



# RF TEST REPORT

**Applicant**      Quectel Wireless Solutions Co., Ltd  
**FCC ID**            XMR202008EG95NAXD  
**Product**          LTE Module  
**Brand**             Quectel  
**Model**             EG95-NAXD  
**Report No.**        R2006A0378-R4  
**Issue Date**        July 8, 2020

TA Technology (Shanghai) Co., Ltd. tested the above equipment in accordance with the requirements in **FCC CFR47 Part 2 (2019)/ FCC CFR 47 Part 22H (2019)**. The test results show that the equipment tested is capable of demonstrating compliance with the requirements as documented in this report.

*Performed by: Peng Tao*

*Approved by: Kai Xu*

---

## TA Technology (Shanghai) Co., Ltd.

*No.145, Jintang Rd, Tangzhen Industry Park, Pudong Shanghai, China*

*TEL: +86-021-50791141/2/3*

*FAX: +86-021-50791141/2/3-8000*



# TABLE OF CONTENT

- 1. Test Laboratory .....4
  - 1.1. Notes of the Test Report ..... 4
  - 1.2. Testing Location ..... 4
- 2. General Description of Equipment under Test.....5
- 3. Applied Standards .....6
- 4. Test Configuration.....7
- 5. Test Case Results .....9
  - 5.1. RF Power Output.....9
  - 5.2. Effective Radiated Power ..... 13
  - 5.3. Occupied Bandwidth ..... 16
  - 5.4. Band Edge Compliance..... 23
  - 5.5. Peak-to-Average Power Ratio (PAPR) ..... 30
  - 5.6. Frequency Stability ..... 32
  - 5.7. Spurious Emissions at Antenna Terminals ..... 37
  - 5.8. Radiates Spurious Emission ..... 43
- 6. Main Test Instruments .....51

### Summary of measurement results

No.	Test Type	Clause in FCC rules	Verdict
1	RF power output	2.1046	Refer to the original
2	Effective Radiated Power	22.913(a)(5)	Refer to the original
3	Occupied Bandwidth	2.1049	Refer to the original
4	Band Edge Compliance	2.1051 / 22.917(a)	Refer to the original
5	Peak-to-Average Power Ratio	22.913(d)/ KDB 971168 D01(5.7)	Refer to the original
6	Frequency Stability	2.1055 / 22.355	PASS
7	Spurious Emissions at Antenna Terminals	2.1051 / 22.917(a)	Refer to the original
8	Radiates Spurious Emission	2.1053 / 22.917 (a)	Only tested the worst case of WCDMA Band V

Date of Testing: May 25, 2018 ~ June 27, 2018 and June 29, 2020

Note: All indications of Pass/Fail in this report are opinions expressed by TA Technology (Shanghai) Co., Ltd. based on interpretations and/or observations of test results. Measurement Uncertainties were not taken into account and are published for informational purposes only.

**EG95-NAXD (Report No.: R2006A0378-R4) is a variant of the EG95-NAX (Report No.: R1907A0407-R4). Test values partial duplicated from Original for variant. There is only tested Radiates Spurious Emission of WCDMA Band V middle channel and Frequency Stability for variant in this report. The detailed product change description please refers to the Statement letter\_EG95-NAX & EG95-NAXD.**

**EG95-NAX (Report No.: R1907A0407-R4) is a variant of the EG95-NA (Report No.: R1805A0249-R1). Test values duplicated from Original for variant. There is no test for variant in this report.**



## 1. Test Laboratory

### 1.1. Notes of the Test Report

This report shall not be reproduced in full or partial, without the written approval of **TA technology (shanghai) co., Ltd.** The results documented in this report apply only to the tested sample, under the conditions and modes of operation as described herein .Measurement Uncertainties were not taken into account and are published for informational purposes only. This report is written to support regulatory compliance of the applicable standards stated above.

### 1.2. Testing Location

Company: TA Technology (Shanghai) Co., Ltd.  
Address: No.145, Jintang Rd, Tangzhen Industry Park, Pudong  
City: Shanghai  
Post code: 201201  
Country: P. R. China  
Contact: Xu Kai  
Telephone: +86-021-50791141/2/3  
Fax: +86-021-50791141/2/3-8000  
Website: <http://www.ta-shanghai.com>  
E-mail: [xukai@ta-shanghai.com](mailto:xukai@ta-shanghai.com)

## 2. General Description of Equipment under Test

### Client Information

Applicant	Quectel Wireless Solutions Co., Ltd
Applicant address	Building 5, Shanghai Business Park Phase III (Area B), No.1016 Tianlin Road, Minhang District, Shanghai, China 200233
Manufacturer	Quectel Wireless Solutions Co., Ltd
Manufacturer address	Building 5, Shanghai Business Park Phase III (Area B), No.1016 Tianlin Road, Minhang District, Shanghai, China 200233

### General Information

EUT Description			
Model	EG95-NAXD		
IMEI	863071010199125		
Hardware Version	R1.0		
Software Version	EG95NAXDGAR07A01M1G		
Power Supply	External Power Supply		
Antenna Type	The EUT don't have standard Antenna, The Antenna used for testing in this report is the after-market accessory (Dipole Antenna)		
Antenna Gain	Frequency(MHz)	Gain(dBi)	
	820	2.53	
	840	1.89	
	850	2.29	
Test Mode(s)	WCDMA Band V;LTE Band 5;		
Test Modulation	(WCDMA) BPSK, QPSK, 16QAM; (LTE)QPSK 16QAM;		
HSDPA UE Category	24		
HSUPA UE Category	6		
DC-HSDPA UE Category	24		
LTE Category	4		
Maximum E.R.P.	WCDMA Band V:	23.11dBm	
	LTE Band 5:	22.25dBm	
Rated Power Supply Voltage	3.8V		
Extreme Voltage	Minimum: 3.3V Maximum: 4.3V		
Extreme Temperature	Lowest: -40°C Highest: +85°C		
Operating Frequency Range(s)	Band	Tx (MHz)	Rx (MHz)
	WCDMA Band V	824 ~ 849	869 ~ 894
	LTE Band 5	824 ~ 849	869 ~ 894
Note: The information of the EUT is declared by the manufacturer.			



### **3. Applied Standards**

According to the specifications of the manufacturer, it must comply with the requirements of the following standards:

**Test standards:**

**FCC CFR 47 Part 22H (2019)**

**ANSI C63.26 (2015)**

**Reference standard:**

**FCC CFR47 Part 2 (2019)**

**KDB 971168 D01 Power Meas License Digital Systems v03r01**

## 4. Test Configuration

Radiated measurements are performed by rotating the EUT in three different orthogonal test planes. EUT stand-up position (Z axis), lie-down position (X, Y axis). Receiver antenna polarization (horizontal and vertical), the worst emission was found in position (X axis, horizontal polarization) and the worst case was recorded.

All mode and data rates and positions were investigated. Subsequently, only the worst case emissions are reported.

The following testing in WCDMA/LTE is set based on the maximum RF Output Power.

Test modes are chosen to be reported as the worst case configuration below:

	Test items	Modes/Modulation
		WCDMA Band V
Conducted Test cases	RF power output	RMC HSDPA/HSUPA DC-HSDPA
	Occupied Bandwidth	RMC
	Band Edge Compliance	RMC
	Peak-to-Average Power Ratio	RMC
	Frequency Stability	RMC
	Spurious Emissions at Antenna Terminals	RMC
Radiated Test cases	Effective Radiated Power	RMC
	Radiates Spurious Emission	RMC



Test modes are chosen as the worst case configuration below for LTE Band 5.

Test items	Bandwidth (MHz)				Modulation		RB			Test Channel		
	1.4	3	5	10	QPSK	16QAM	1	50%	100%	L	M	H
RF power output	○	○	○	○	○	○	○	○	○	○	○	○
Effective Isotropic Radiated power	○	○	○	○	○	○	-	-	○	○	○	○
Occupied Bandwidth	○	○	○	○	○	○	-	-	○	○	○	○
Band Edge Compliance	○	○	○	○	○	○	○	-	○	○	-	○
Peak-to-Average Power Ratio	○	○	○	○	○	○	-	-	○	○	○	○
Frequency Stability	○	○	○	○	○	○	○	○	○	○	○	○
Spurious Emissions at Antenna Terminals	○	○	○	○	○	-	○	-	-	○	○	○
Radiates Spurious Emission	○	-	○	○	○	-	○	-	-	○	○	○
Note	1. The mark "○" means that this configuration is chosen for testing. 2. The mark "-" means that this configuration is not testing.											



## 5. Test Case Results

### 5.1. RF Power Output

#### Ambient condition

Temperature	Relative humidity	Pressure
23°C ~25°C	45%~50%	101.5kPa

#### Methods of Measurement

During the process of the testing, The EUT is controlled by the Base Station Simulator to ensure max power transmission and proper modulation.

#### Test Setup

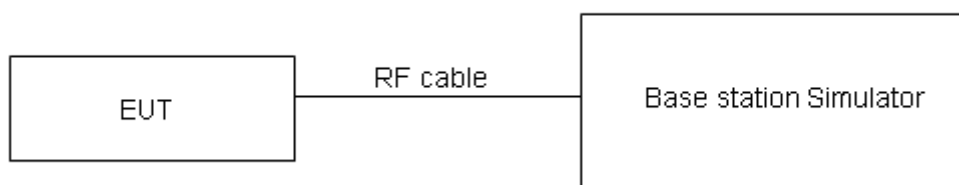

The loss between RF output port of the EUT and the input port of the tester has been taken into consideration.

#### Limits

No specific RF power output requirements in part 2.1046.

#### Measurement Uncertainty

The assessed measurement uncertainty to ensure 95% confidence level for the normal distribution is with the coverage factor  $k = 2$ ,  $U = 0.4$  dB.

**Test Results**

WCDMA Band V		Conducted Power(dBm)		
		Channel 4132	Channel 4183	Channel 4233
		826.4(MHz)	836.6(MHz)	846.6(MHz)
<b>RMC</b>	12.2k	23.20	23.09	23.17
	64k	23.13	22.95	23.11
	144k	23.12	22.94	23.01
	384k	23.11	22.93	23.00
<b>HSDPA</b>	Sub - Test 1	22.29	22.25	22.27
	Sub - Test 2	22.27	22.31	22.28
	Sub - Test 3	22.23	22.17	22.24
	Sub - Test 4	22.33	22.23	22.32
<b>HSUPA</b>	Sub - Test 1	22.72	22.57	22.72
	Sub - Test 2	22.72	22.69	22.64
	Sub - Test 3	22.80	22.67	22.64
	Sub - Test 4	22.22	22.15	22.21
	Sub - Test 5	22.21	22.18	22.23
<b>DC-HSDPA</b>	Sub - Test 1	23.07	22.96	23.04
	Sub - Test 2	23.16	22.94	23.03
	Sub - Test 3	22.65	22.43	22.52
	Sub - Test 4	22.64	22.42	22.51

LTE Band 5				Conducted Power(dBm)		
BW	Modulation	RB size	RB offset	Channel/Frequency(MHz)		
				20407/824.7	20525/836.5	20643/848.3
1.4MHz	QPSK	1	0	23.79	23.61	23.75
		1	2	23.71	23.78	23.92
		1	5	23.82	23.45	23.65
		3	0	23.60	23.78	23.63
		3	2	23.54	23.77	23.72
		3	3	23.69	23.79	23.72
		6	0	22.76	22.80	22.75
	16QAM	1	0	23.31	22.94	22.40
		1	2	23.59	23.04	23.00
		1	5	23.33	22.99	22.87
		3	0	22.70	22.79	22.79
		3	2	22.50	22.71	22.71
		3	3	22.76	22.77	22.75
		6	0	21.78	21.83	21.79
BW	Modulation	RB size	RB offset	Channel/Frequency(MHz)		
				20415/825.5	20525/836.5	20635/847.5
3MHz	QPSK	1	0	23.80	23.64	23.77
		1	7	23.75	23.84	23.97
		1	14	23.84	23.49	23.68
		8	0	22.70	22.90	22.76
		8	4	22.67	22.88	22.83
		8	7	22.79	22.92	22.83
		15	0	22.85	22.85	22.80
	16QAM	1	0	23.33	22.95	22.42
		1	7	23.62	23.11	23.04
		1	14	23.35	23.03	22.89
		8	0	21.82	21.93	21.92
		8	4	21.60	21.83	21.82
		8	7	21.86	21.89	21.88
		15	0	21.82	21.88	21.81
BW	Modulation	RB size	RB offset	Channel/Frequency(MHz)		
				20425/826.5	20525/836.5	20625/846.5
5MHz	QPSK	1	0	23.79	23.60	23.75



		1	13	23.73	23.83	23.94
		1	24	23.81	23.44	23.64
		12	0	22.68	22.86	22.73
		12	6	22.64	22.83	22.79
		12	13	22.76	22.89	22.79
		25	0	22.83	22.81	22.75
	16QAM	1	0	23.28	22.93	22.40
		1	13	23.60	23.08	23.02
		1	24	23.32	22.99	22.86
		12	0	21.79	21.91	21.89
		12	6	21.57	21.78	21.78
		12	13	21.84	21.85	21.85
		25	0	21.79	21.83	21.77
BW	Modulation	RB size	RB offset	Channel/Frequency(MHz)		
				20450/829	20525/836.5	20600/844
10MHz	QPSK	1	0	23.76	23.56	23.72
		1	25	23.72	23.79	23.92
		1	49	23.79	23.43	23.61
		25	0	22.65	22.81	22.69
		25	13	22.62	22.79	22.76
		25	25	22.73	22.84	22.75
		50	0	22.80	22.76	22.71
	16QAM	1	0	23.26	22.89	22.35
		1	25	23.56	23.06	22.98
		1	49	23.30	22.96	22.84
		25	0	21.76	21.87	21.86
		25	13	21.54	21.76	21.75
		25	25	21.81	21.80	21.81
		50	0	21.77	21.79	21.74

## 5.2. Effective Radiated Power

### Ambient condition

Temperature	Relative humidity	Pressure
23°C ~25°C	45%~50%	101.5kPa

### Methods of Measurement

The testing follows FCC KDB 971168 v03r01 Section 5.8 and ANSI/TIA-603-E (2016).

- a) Connect the equipment as illustrated. Mount the equipment with the manufacturer specified antenna in a vertical orientation on a manufacturer specified mounting surface located on a non-conducting rotating platform of a RF anechoic chamber (preferred) or a standard radiation site.
- b) Key the transmitter, then rotate the EUT 360° azimuthally and record spectrum analyzer power level (LVL) measurements at angular increments that are sufficiently small to permit resolution of all peaks. If a standard radiation test site is used, raise and lower the test antenna to obtain a maximum reading at each angular increment. (Note: several batteries may be needed to offset the effect of battery voltage droop, which should not exceed 5% of the manufactured specified battery voltage during transmission).
- c) Replace the transmitter under test with a vertically polarized half-wave dipole (or an antenna whose gain is known relative to an ideal half-wave dipole). The center of the antenna should be at the same location as the center of the antenna under test.
- d) Connect the antenna to a signal generator with a known output power and record the path loss (in dB) as LOSS. If a standard radiation test site is used, raise and lower the test antenna to obtain a maximum reading.  $LOSS = \text{Generator Output Power (dBm)} - \text{Analyzer reading (dBm)}$
- e) Determine the effective radiated output power at each angular position from the readings in steps b) and d) using the following equation:  $ERP \text{ (dBm)} = \text{LVL (dBm)} + \text{LOSS (dB)}$
- f) The maximum ERP is the maximum value determined in the preceding step.
- g) When calculating ERP, in addition to knowing the antenna radiation and matching characteristics, it is necessary to know the loss values of all elements (e.g. transmission line attenuation, mismatches, filters, combiners) interposed between the point where transmitter output power is measured, and the point where power is applied to the antenna. ERP can then be calculated as follows:  
 $ERP \text{ (dBm)} = \text{Output Power (dBm)} - \text{Losses (dB)} + \text{Antenna Gain (dBd)}$   
where: dBd refers to gain relative to an ideal dipole.  
 $EIRP \text{ (dBm)} = ERP \text{ (dBm)} + 2.15 \text{ (dB.)}$

The RB allocation refers to section 5.1, using the maximum output power configuration.

**Test setup**

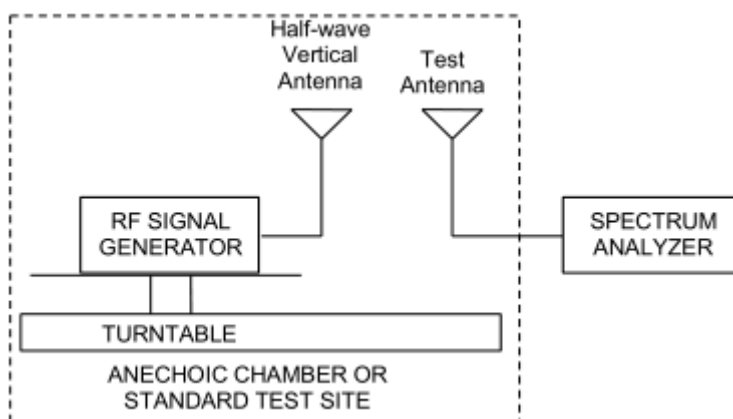
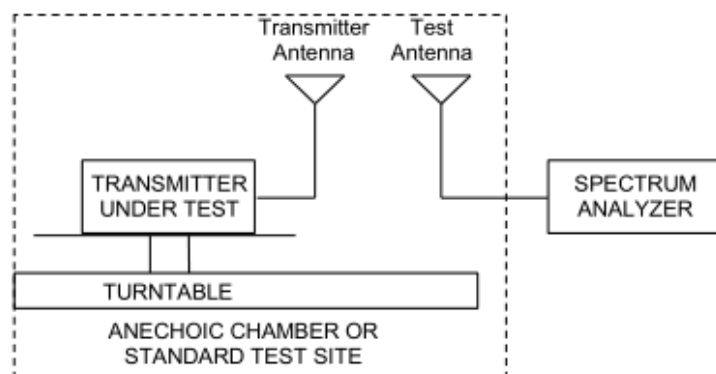

**Limits**

Rule Part 22.913(a)(5) specifies that "Mobile/portable stations are limited to 7 watts ERP".

Limit	$\leq 7 \text{ W}$ (38.45 dBm)
-------	--------------------------------

**Measurement Uncertainty**

The assessed measurement uncertainty to ensure 95% confidence level for the normal distribution is with the coverage factor  $k = 2$ ,  $U = 1.19 \text{ dB}$

**Test Results:**

The measurement is performed for both of horizontal and vertical antenna Polarization, and only the data of worst mode is recorded in this report.

Mode	Channel	Frequency (MHz)	Polarization	ERP (dBm)	Limit (dBm)	Conclusion
WCDMA Band V	Low	826.4	Horizontal	23.11	38.45	Pass
	Mid	836.6	Horizontal	23.08	38.45	Pass
	High	846.6	Horizontal	22.73	38.45	Pass

LTE Band 5						
bandwidth	Channel	Frequency (MHz)	Polarization	ERP (dBm)	Limit (dBm)	Conclusion
1.4 MHz (QPSK)	Low	824.7	Horizontal	21.73	38.45	Pass
	Mid	836.5	Horizontal	21.85	38.45	Pass
	High	848.3	Horizontal	21.92	38.45	Pass
3 MHz (QPSK)	Low	825.5	Horizontal	22.09	38.45	Pass
	Mid	836.5	Horizontal	22.00	38.45	Pass
	High	847.5	Horizontal	21.67	38.45	Pass
5 MHz (QPSK)	Low	826.5	Horizontal	21.75	38.45	Pass
	Mid	836.5	Horizontal	21.93	38.45	Pass
	High	846.5	Horizontal	21.23	38.45	Pass
10 MHz (QPSK)	Low	829	Horizontal	21.95	38.45	Pass
	Mid	836.5	Horizontal	21.54	38.45	Pass
	High	844	Horizontal	21.34	38.45	Pass
1.4 MHz (16QAM)	Low	824.7	Horizontal	21.26	38.45	Pass
	Mid	836.5	Horizontal	21.36	38.45	Pass
	High	848.3	Horizontal	21.49	38.45	Pass
3 MHz (16QAM)	Low	825.5	Horizontal	21.60	38.45	Pass
	Mid	836.5	Horizontal	21.56	38.45	Pass
	High	847.5	Horizontal	21.16	38.45	Pass
5 MHz (16QAM)	Low	826.5	Horizontal	22.25	38.45	Pass
	Mid	836.5	Horizontal	21.48	38.45	Pass
	High	846.5	Horizontal	20.82	38.45	Pass
10 MHz (16QAM)	Low	829	Horizontal	21.71	38.45	Pass
	Mid	836.5	Horizontal	21.10	38.45	Pass
	High	844	Horizontal	20.90	38.45	Pass

### 5.3. Occupied Bandwidth

#### Ambient condition

Temperature	Relative humidity	Pressure
23°C ~25°C	45%~50%	101.5kPa

#### Method of Measurement

The EUT was connected to Spectrum Analyzer and Base Station Simulator via power Splitter. The occupied bandwidth is measured using spectrum analyzer.

RBW is set to 51kHz, VBW is set to 160kHz for WCDMA Band V,

RBW is set to 51 kHz, VBW is set to 160 kHz for LTE Band 5(1.4MHz),

RBW is set to 100 kHz, VBW is set to 300 kHz for LTE Band 5 (3MHz/5MHz),

RBW is set to 300 kHz, VBW is set to 1 MHz for LTE Band 5 (10MHz),

99% power and -26dBc occupied bandwidths are recorded. Spectrum analyzer plots are included on the following pages.

#### Test Setup

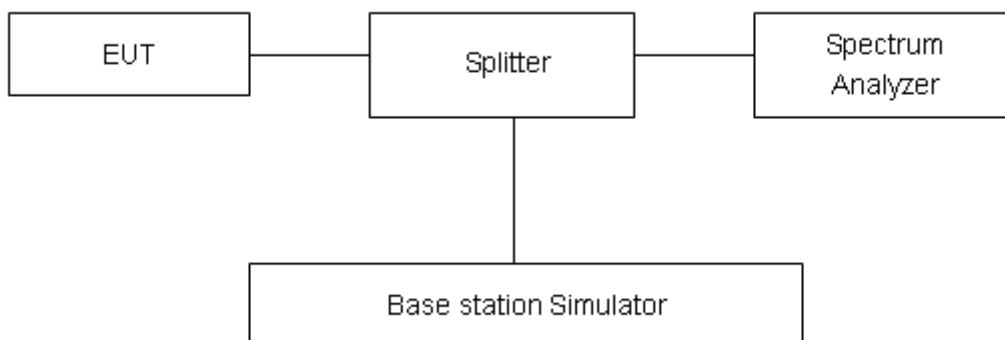

#### Limits

No specific occupied bandwidth requirements in part 2.1049.

#### Measurement Uncertainty

The assessed measurement uncertainty to ensure 95% confidence level for the normal distribution is with the coverage factor  $k = 2$ ,  $U = 624\text{Hz}$ .





## Test Result

Mode	Channel	Frequency (MHz)	99% Power Bandwidth (MHz)	-26dBc Bandwidth(MHz)
WCDMA Band V (RMC)	4132	826.4	4.1273	4.690
	4183	836.6	4.1381	4.693
	4233	846.6	4.1266	4.680

LTE Band 5						
RB	Modulation	Bandwidth (MHz)	Channel	Frequency (MHz)	99% Power Bandwidth(MHz)	-26dBc Bandwidth(MHz)
100%	QPSK	1.4	20407	824.7	1.1153	1.335
			20525	836.5	1.1105	1.318
			20643	848.3	1.1131	1.333
		3	20415	825.5	2.7631	3.027
			20525	836.5	2.7477	3.062
			20635	847.5	2.7387	3.030
		5	20425	826.5	4.5394	4.990
			20525	836.5	4.506	4.983
			20625	846.5	4.5035	4.990
		10	20450	829	9.0220	10.00
			20525	836.5	9.0084	10.02
			20600	844	9.0109	10.08
	16QAM	1.4	20407	824.7	1.1167	1.343
			20525	836.5	1.1112	1.326
			20643	848.3	1.1175	1.327
		3	20415	825.5	2.7428	3.054
			20525	836.5	2.7473	3.040
			20635	847.5	2.7409	3.036
		5	20425	826.5	4.5359	4.982
			20525	836.5	4.5185	5.002
			20625	846.5	4.5052	4.999
		10	20450	829	9.0079	10.09
			20525	836.5	8.9988	9.988
			20600	844	9.022	9.997

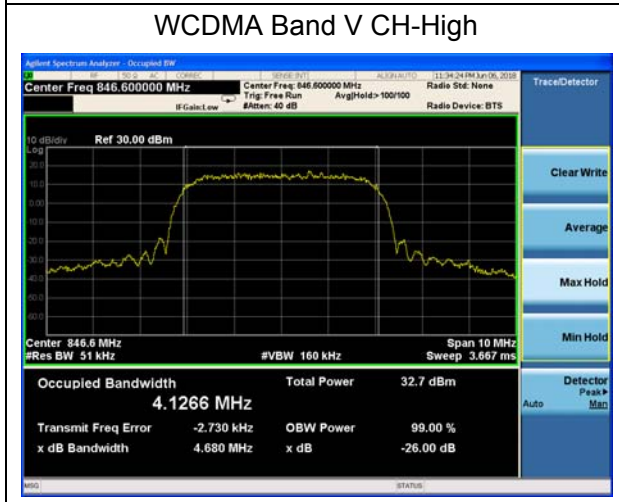
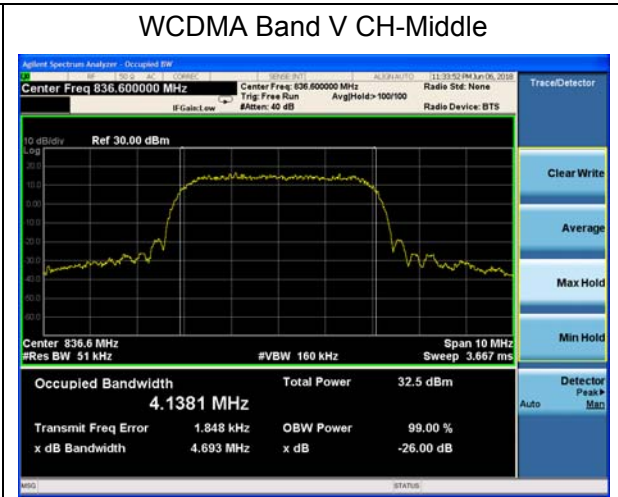
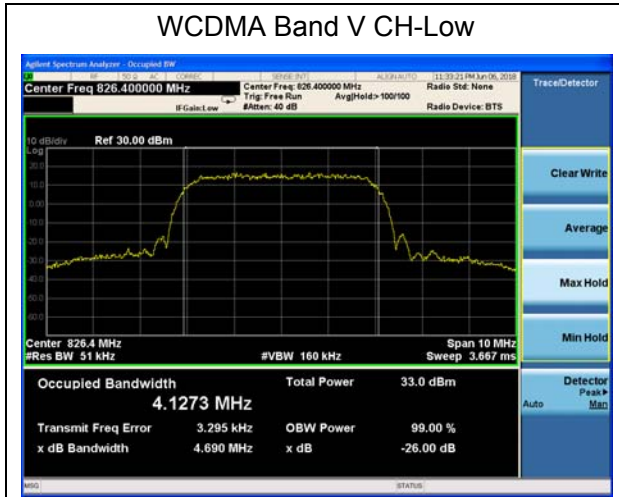

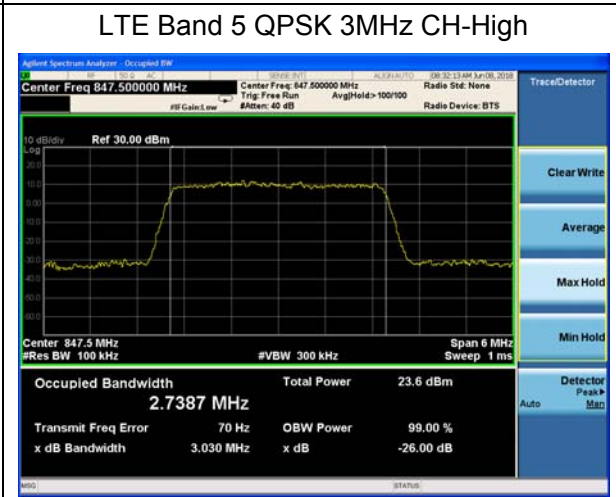
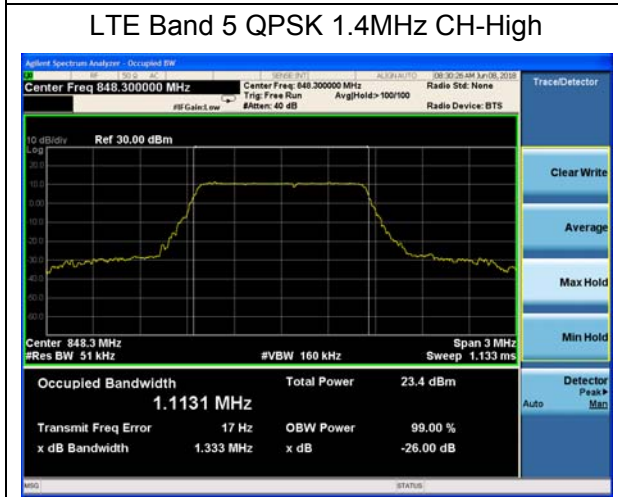
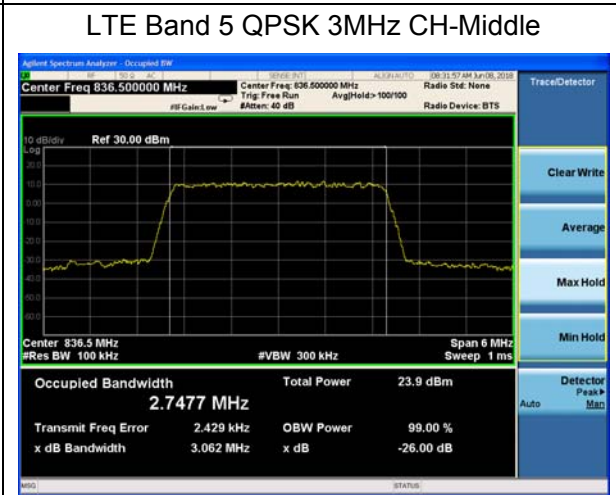
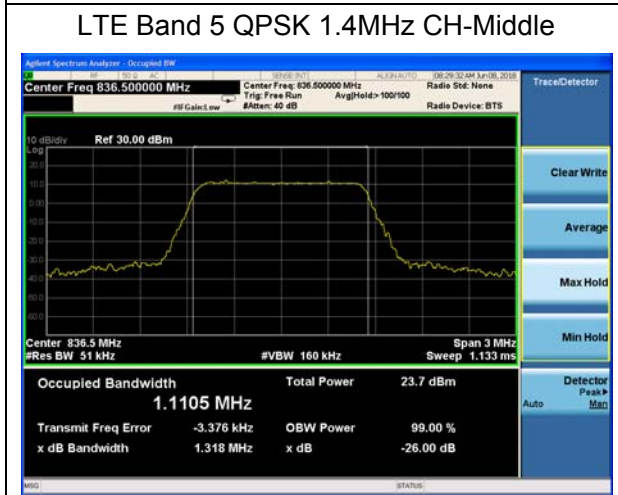
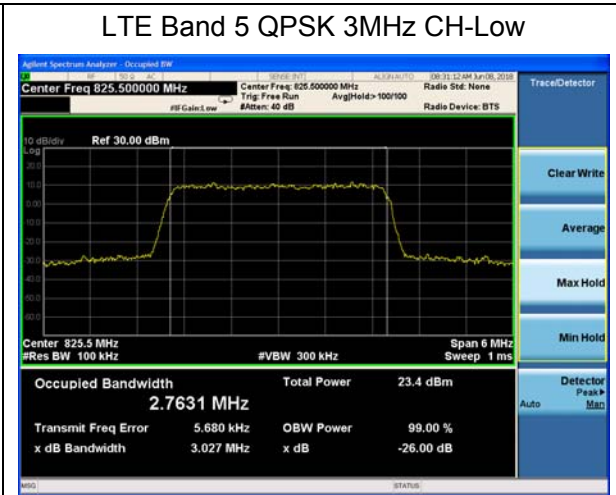
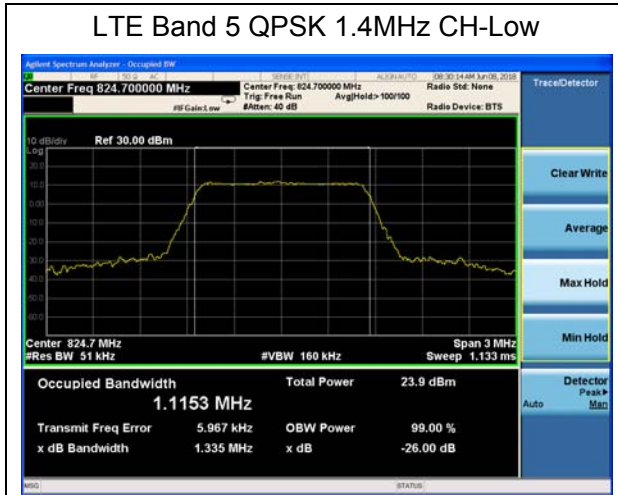

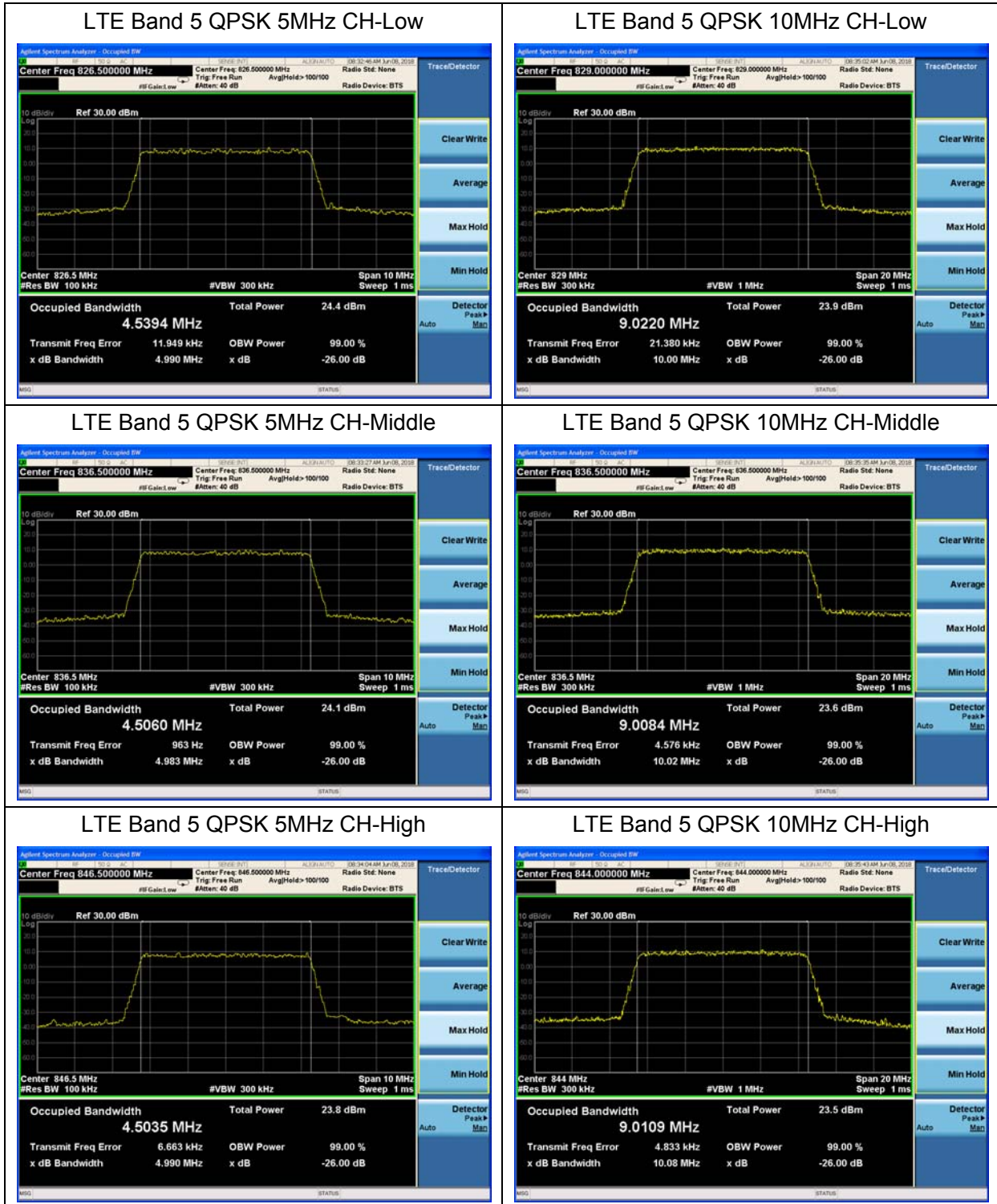

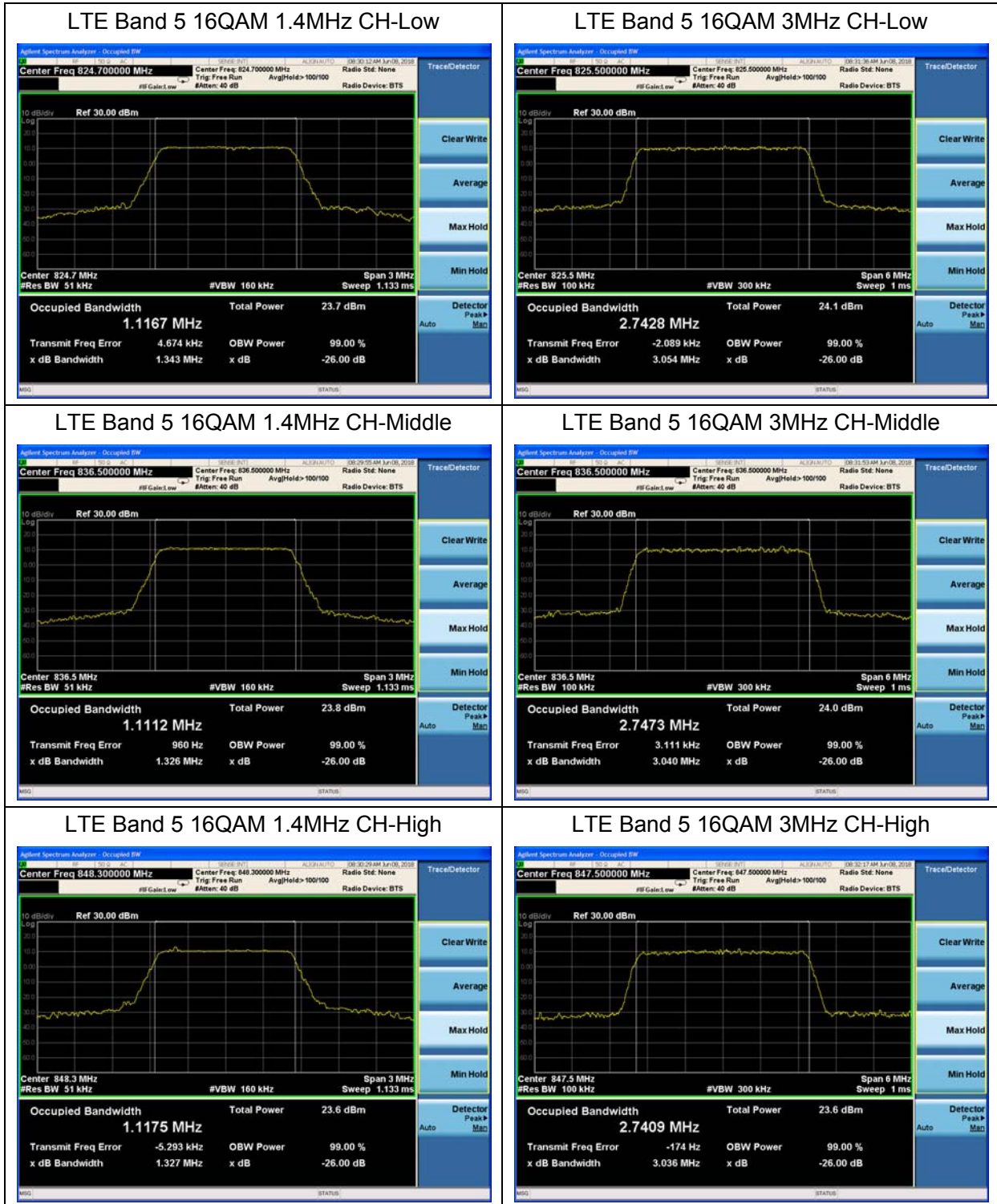



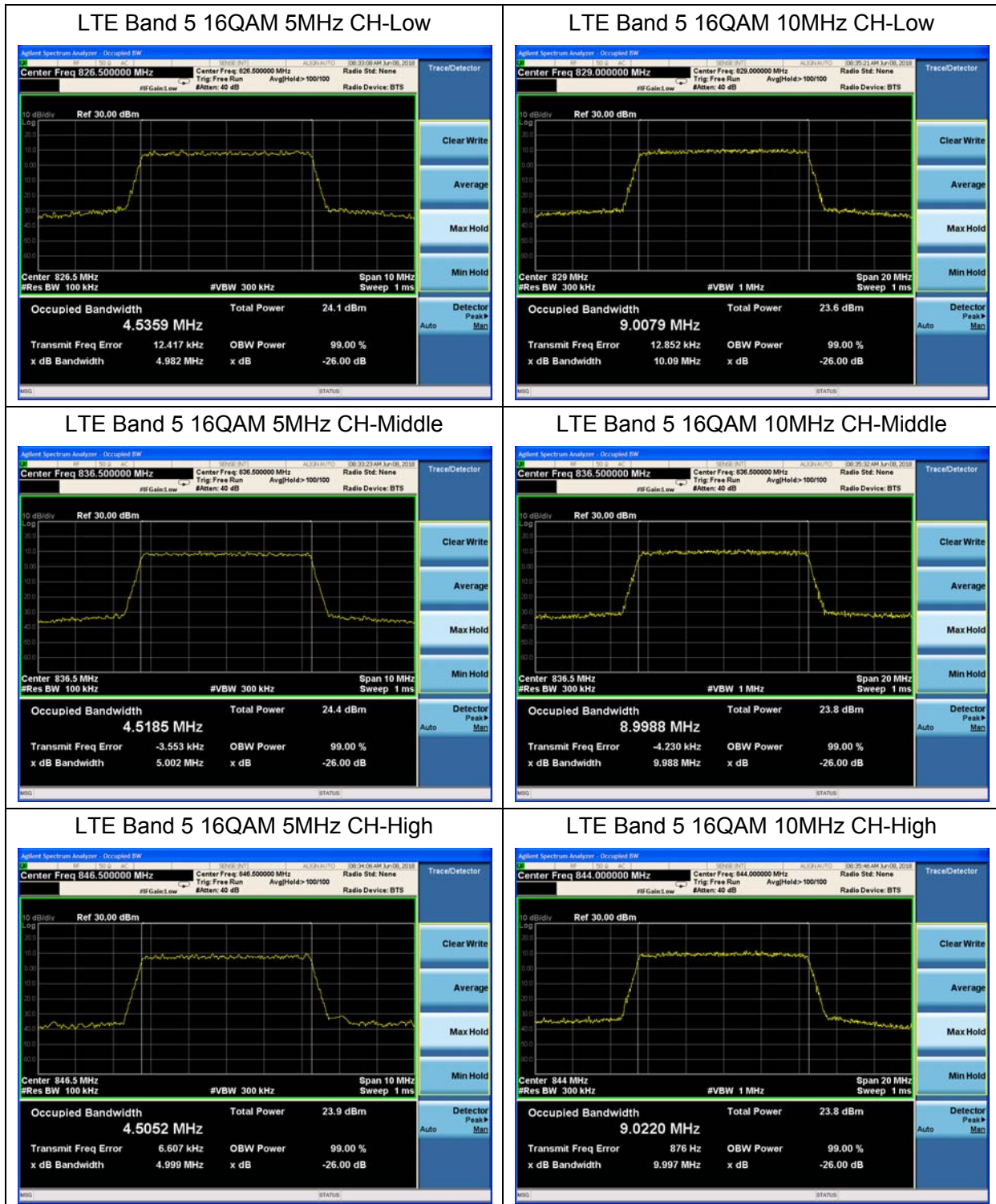

### 5.4. Band Edge Compliance

#### Ambient condition

Temperature	Relative humidity	Pressure
23°C ~25°C	45%~50%	101.5kPa

#### Method of Measurement

The EUT was connected to Spectrum Analyzer and Base Station Simulator via power Splitter. The band edge of the lowest and highest channels were measured. The average detector is used. RBW is set to 51kHz,VBW is set to 160kHz for WCDMA Band V, RBW is set to 15 kHz, VBW is set to 51 kHz for LTE Band 5(1.4MHz), RBW is set to 30 kHz, VBW is set to 100 kHz for LTE Band 5(3MHz), RBW is set to 51 kHz, VBW is set to 160 kHz for LTE Band 5(5MHz), RBW is set to 100 kHz, VBW is set to 300 kHz for LTE Band 5(10MHz),

Spectrum analyzer plots are included on the following pages.

#### Test Setup

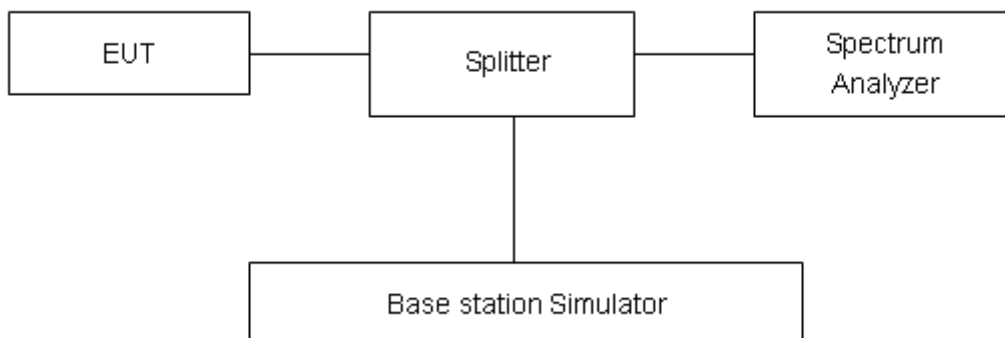

#### Limits

Rule Part 22.917(a) specifies that “The power of any emission outside of the authorized operating frequency ranges must be attenuated below the transmitting power (P) by a factor of at least 43 + 10 log(P) dB.”

Limit	-13 dBm
-------	---------

#### Measurement Uncertainty

The assessed measurement uncertainty to ensure 95% confidence level for the normal distribution is with the coverage factor  $k = 1.96$ ,  $U=0.684$ dB.



Test Result:

WCDMA Band V CH-Low



WCDMA Band V CH-High



LTE Band 5 QPSK 1.4MHz CH-Low 1RB

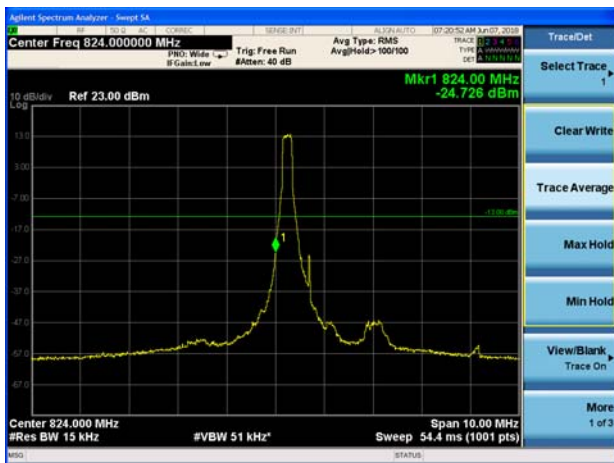

LTE Band 5 QPSK 1.4MHz CH-High 1RB

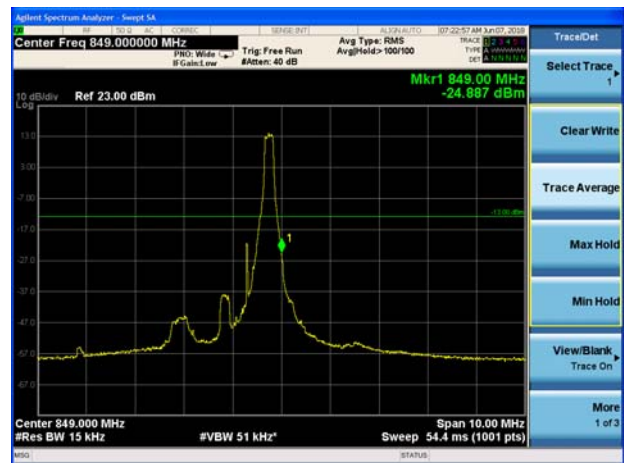

LTE Band 5 QPSK 1.4MHz CH-Low 100%RB

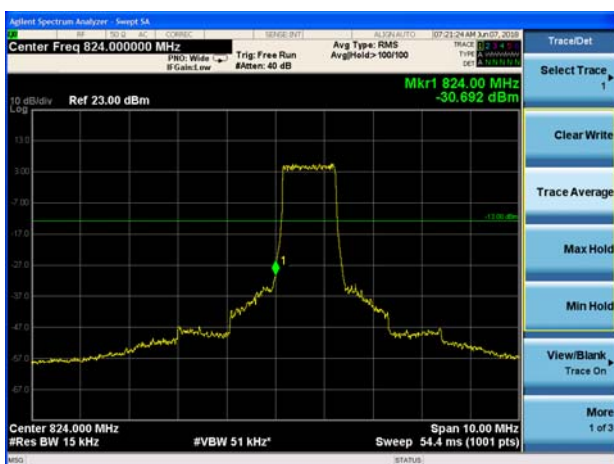

LTE Band 5 QPSK 1.4MHz CH-High 100%RB

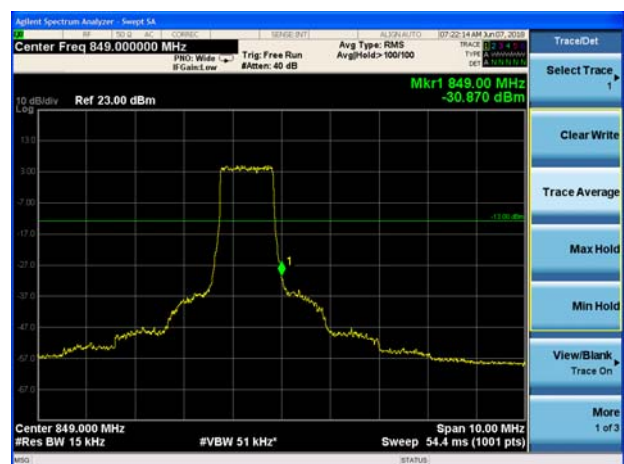



LTE Band 5 QPSK 3MHz CH-Low 1RB

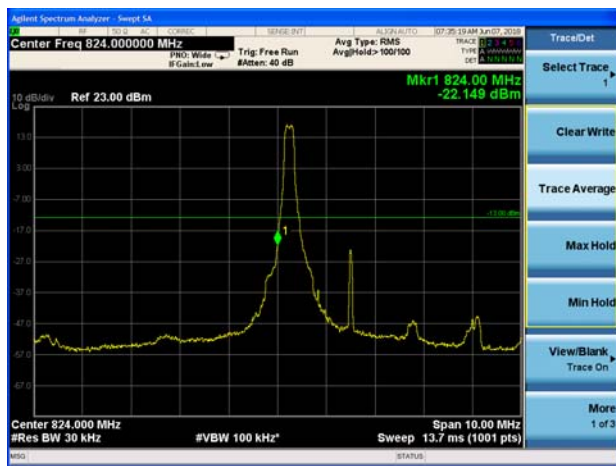

LTE Band 5 QPSK 3MHz CH-High 1RB

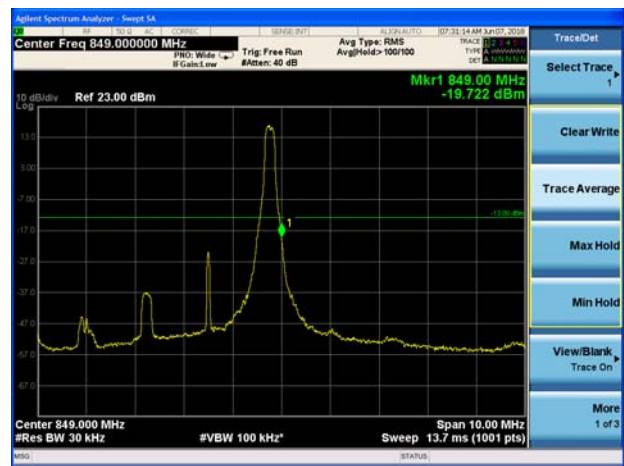

LTE Band 5 QPSK 3MHz CH-Low 100%RB

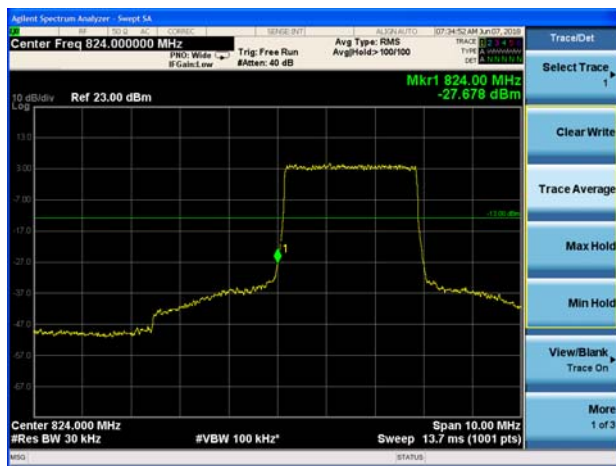

LTE Band 5 QPSK 3MHz CH-High 100%RB

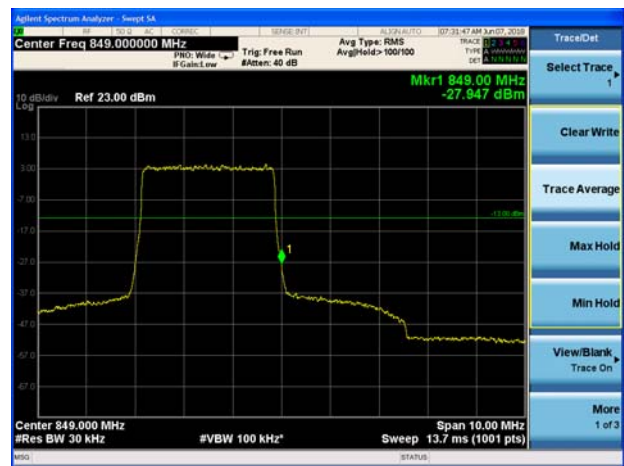

LTE Band 5 QPSK 5MHz CH-Low 1RB

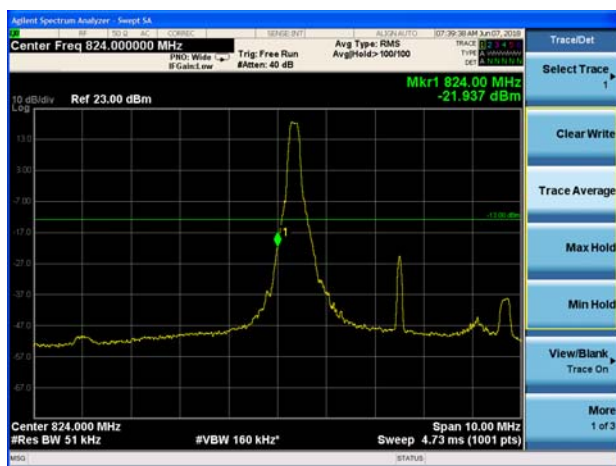

LTE Band 5 QPSK 5MHz CH-High 1RB

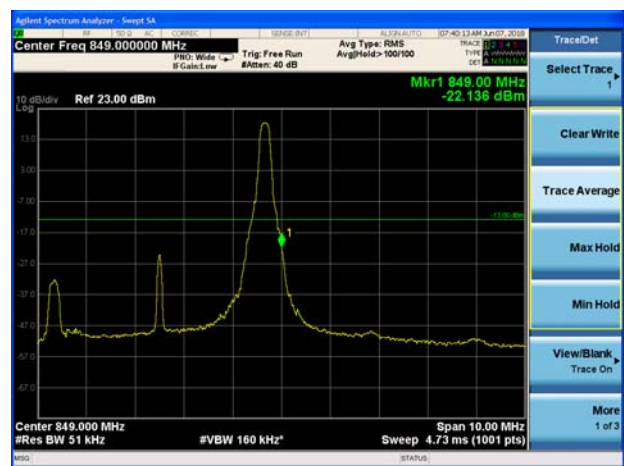



LTE Band 5 QPSK 5MHz CH-Low 100%RB



LTE Band 5 QPSK 5MHz CH-High 100%RB



LTE Band 5 QPSK 10MHz CH-Low 1RB

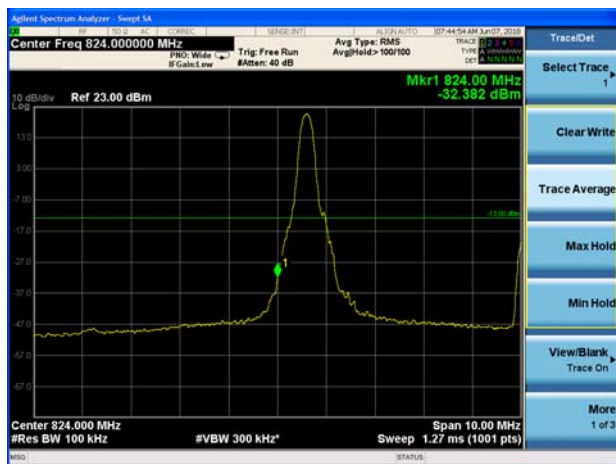

LTE Band 5 QPSK 10MHz CH-High 1RB

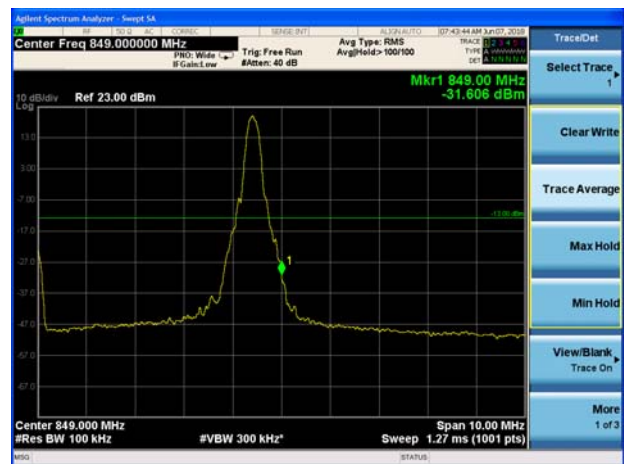

LTE Band 5 QPSK 10MHz CH-Low 100%RB

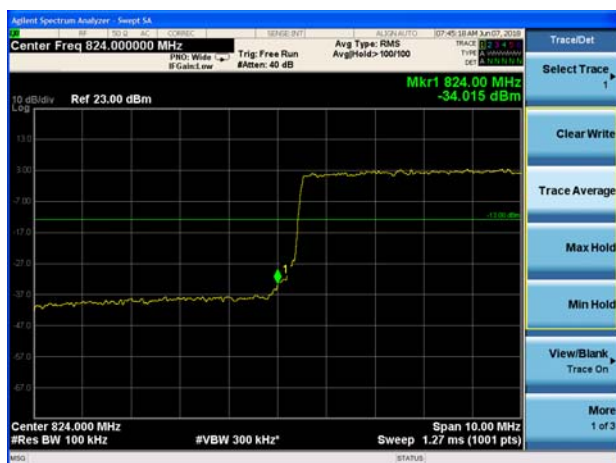

LTE Band 5 QPSK 10MHz CH-High 100%RB





LTE Band 5 16QAM 1.4MHz CH-Low 1RB

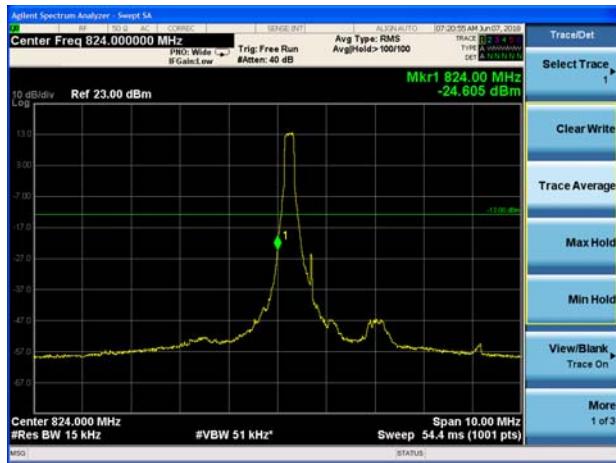

LTE Band 5 16QAM 1.4MHz CH-High 1RB

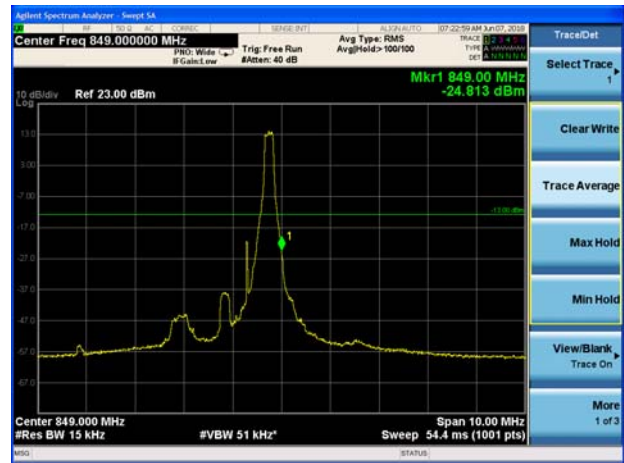

LTE Band 5 16QAM 1.4MHz CH-Low 100%RB

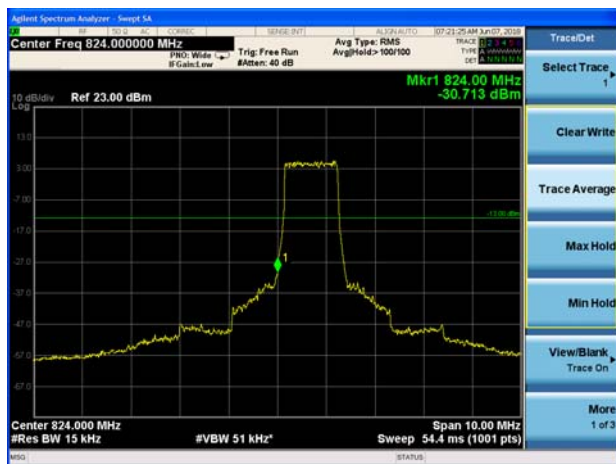

LTE Band 5 16QAM 1.4MHz CH-High 100%RB

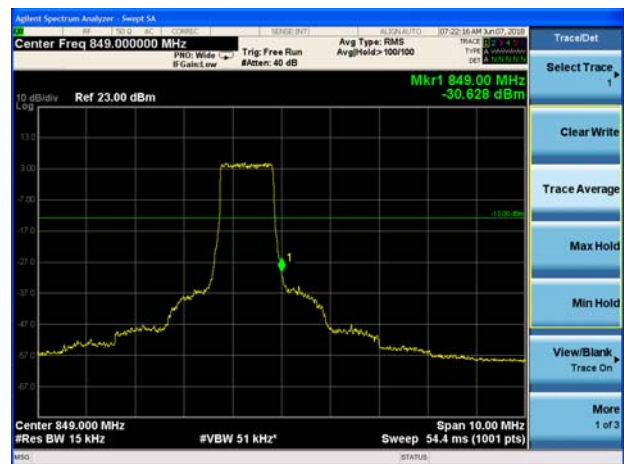

LTE Band 5 16QAM 3MHz CH-Low 1RB

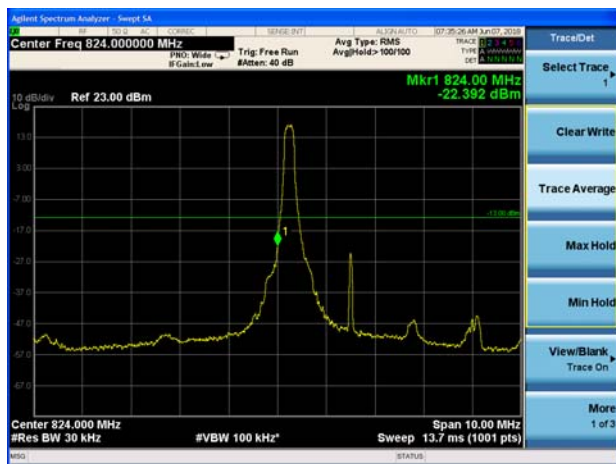

LTE Band 5 16QAM 3MHz CH-High 1RB

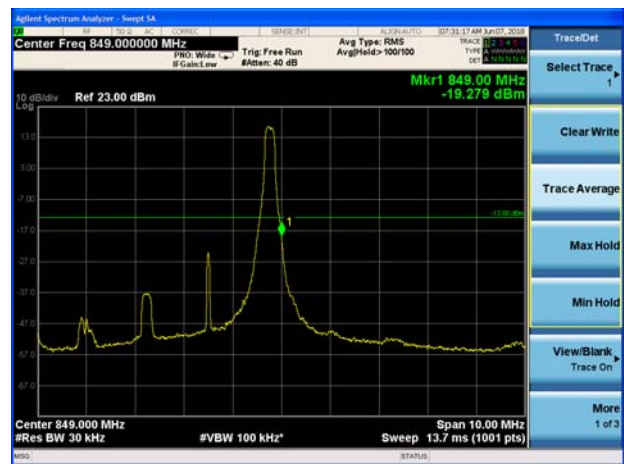



LTE Band 5 16QAM 3MHz CH-Low 100%RB



LTE Band 5 16QAM 3MHz CH-High 100%RB



LTE Band 5 16QAM 5MHz CH-Low 1RB

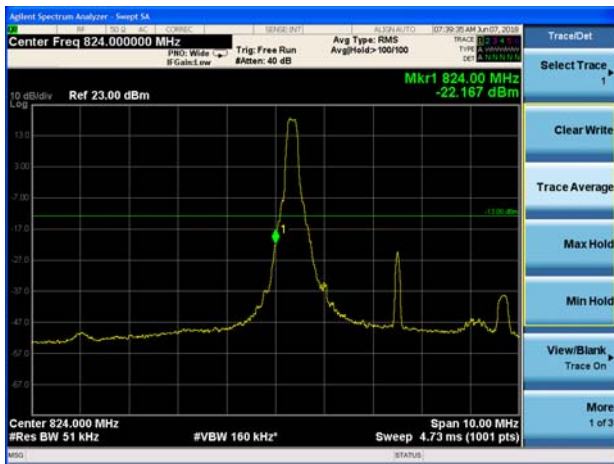

LTE Band 5 16QAM 5MHz CH-High 1RB

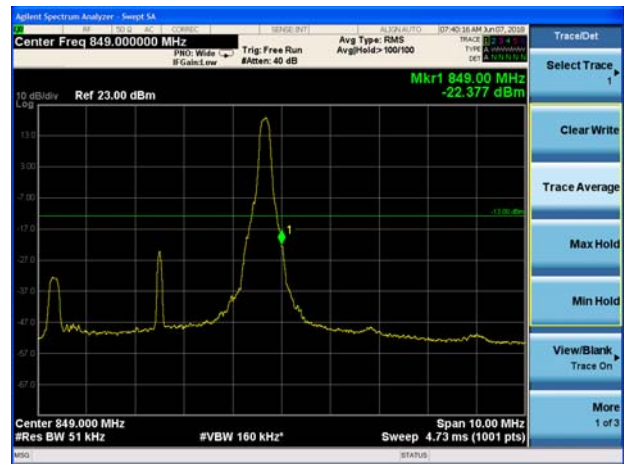

LTE Band 5 16QAM 5MHz CH-Low 100%RB

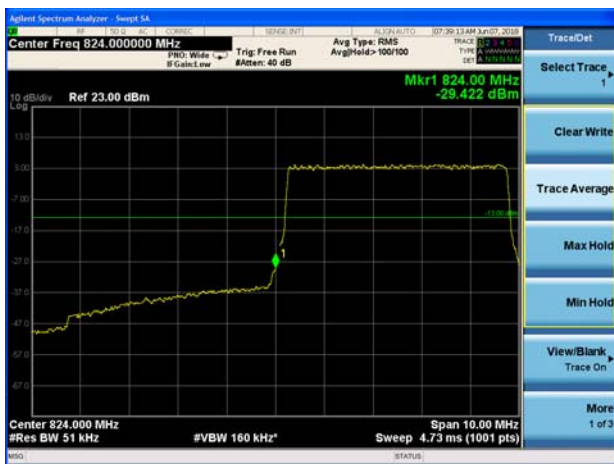

LTE Band 5 16QAM 5MHz CH-High 100%RB





### LTE Band 5 16QAM 10MHz CH-Low 1RB

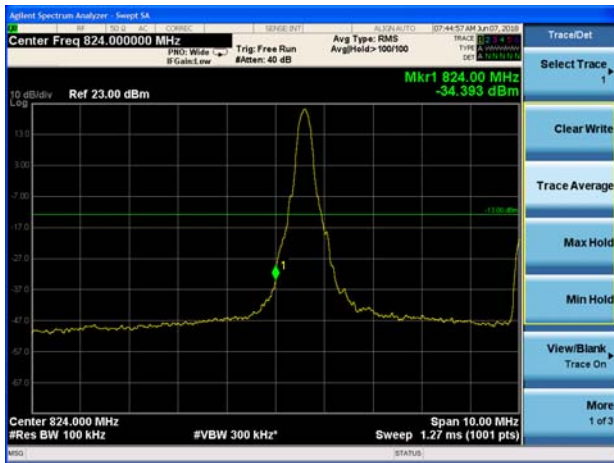

### LTE Band 5 16QAM 10MHz CH-High 1RB

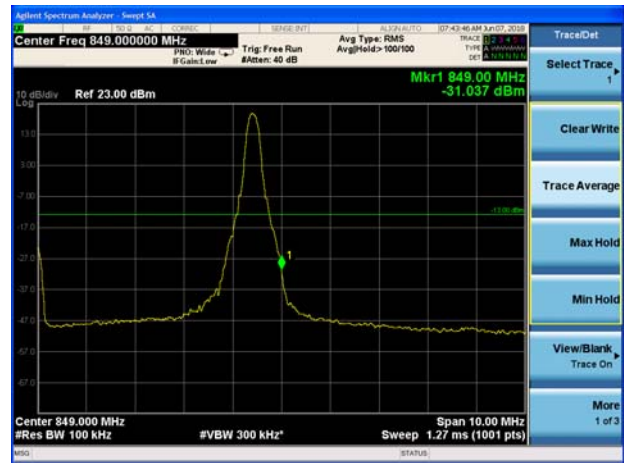

### LTE Band 5 16QAM 10MHz CH-Low 100%RB

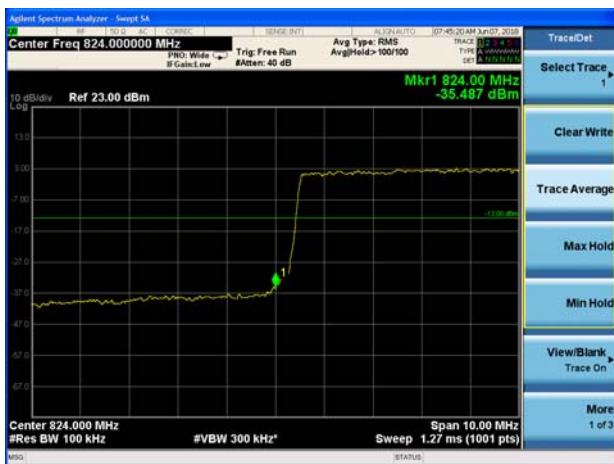

### LTE Band 5 16QAM 10MHz CH-High 100%RB

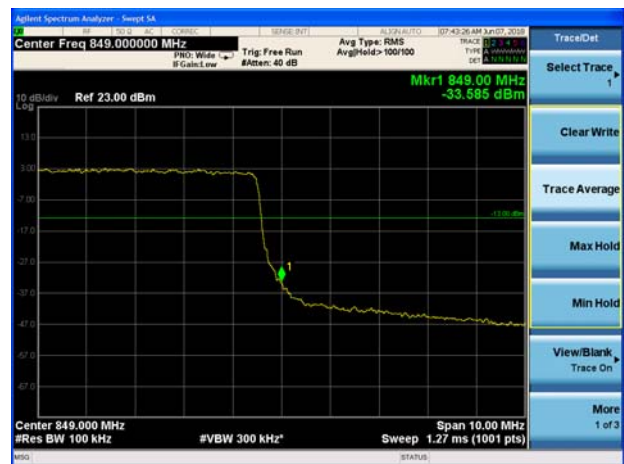

### 5.5. Peak-to-Average Power Ratio (PAPR)

#### Ambient condition

Temperature	Relative humidity	Pressure
23°C ~25°C	45%~50%	101.5kPa

#### Methods of Measurement

Measure the total peak power and record as  $P_{Pk}$ . And measure the total average power and record as  $P_{Avg}$ . Both the peak and average power levels must be expressed in the same logarithmic units (e.g., dBm). Determine the PAPR from:

$$PAPR (dB) = P_{Pk} (dBm) - P_{Avg} (dBm).$$

#### Test Setup

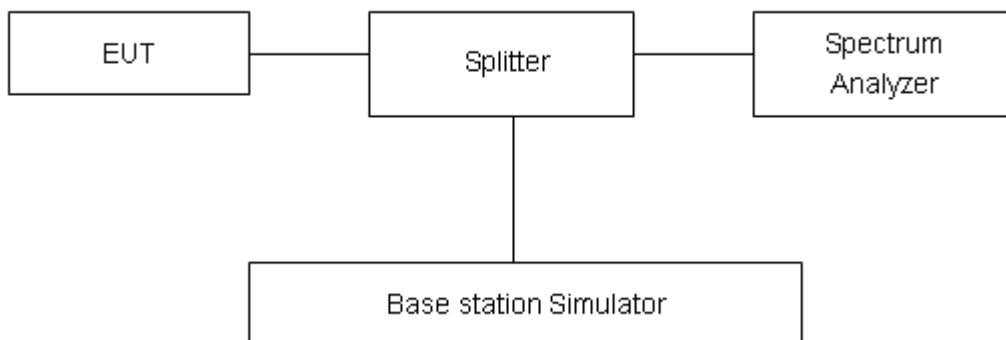

#### Limits

According to the Sec. 22.913(d), The peak-to-average ratio (PAR) of the transmission must not exceed 13 dB.

#### Measurement Uncertainty

The assessed measurement uncertainty to ensure 95% confidence level for the normal distribution is with the coverage factor  $k = 2$ ,  $U = 0.4$  dB.



**Test Results**

Mode	Channel	Frequency (MHz)	Peak (dBm)	Avg (dBm)	PAPR (dB)	Limit (dB)	Conclusion
WCDMA Band V (RMC)	4132	826.4	26.47	23.20	3.27	≤13	PASS
	4183	836.6	26.32	23.09	3.23	≤13	PASS
	4233	846.6	26.25	23.17	3.08	≤13	PASS

LTE Band 5								
Modulation	Bandwidth (MHz)	Channel	Frequency (MHz)	Peak (dBm)	Avg (dBm)	PAPR (dB)	Limit (dB)	Conclusion
QPSK	1.4	20407	824.7	29.39	22.76	6.63	≤13	PASS
		20525	836.5	28.89	22.80	6.09	≤13	PASS
		20643	848.3	28.81	22.75	6.06	≤13	PASS
	3	20415	825.5	28.77	22.85	5.92	≤13	PASS
		20525	836.5	28.92	22.85	6.07	≤13	PASS
		20635	847.5	29.26	22.80	6.46	≤13	PASS
	5	20425	826.5	30.12	22.83	7.29	≤13	PASS
		20525	836.5	29.16	22.81	6.35	≤13	PASS
		20625	846.5	29.56	22.75	6.81	≤13	PASS
	10	20450	829	28.93	22.80	6.13	≤13	PASS
		20525	836.5	28.72	22.76	5.96	≤13	PASS
		20600	844	28.62	22.71	5.91	≤13	PASS
16QAM	1.4	20407	824.7	29.19	21.78	7.41	≤13	PASS
		20525	836.5	29.71	21.83	7.88	≤13	PASS
		20643	848.3	28.99	21.79	7.20	≤13	PASS
	3	20415	825.5	28.61	21.82	6.79	≤13	PASS
		20525	836.5	28.55	21.88	6.67	≤13	PASS
		20635	847.5	28.57	21.81	6.76	≤13	PASS
	5	20425	826.5	29.36	21.79	7.57	≤13	PASS
		20525	836.5	29.40	21.83	7.57	≤13	PASS
		20625	846.5	29.31	21.77	7.54	≤13	PASS
	10	20450	829	28.87	21.77	7.10	≤13	PASS
		20525	836.5	28.61	21.79	6.82	≤13	PASS
		20600	844	28.51	21.74	6.77	≤13	PASS

## 5.6. Frequency Stability

### Ambient condition

Temperature	Relative humidity	Pressure
23°C ~25°C	45%~50%	101.5kPa

### Method of Measurement

#### Frequency Stability (Temperature Variation)

The temperature inside the climate chamber is varied from -40°C to +85°C in 10°C step size,

(1) With all power removed, the temperature was decreased to 0°C and permitted to stabilize for three hours.

(2) Measure the carrier frequency with the test equipment in a “call mode”. These measurements should be made within 1 minute of powering up the mobile station, to prevent significant self warming.

(3) Repeat the above measurements at 10°C increments from -40°C to +85°. Allow at least 1.5 hours at each temperature, un-powered, before making measurements.

#### Frequency Stability (Voltage Variation)

The frequency stability shall be measured with variation of primary supply voltage as follows:

(1) Vary primary supply voltage from 85 to 115 percent of the nominal value for other than hand carried battery equipment.

(2) For hand carried, battery powered equipment, reduce primary supply voltage to the battery-operating end point which shall be specified by the manufacturer.

This transceiver is specified to operate with an input voltage of between 3.3 V and 4.3 V, with a nominal voltage of 3.8V.

### Test setup

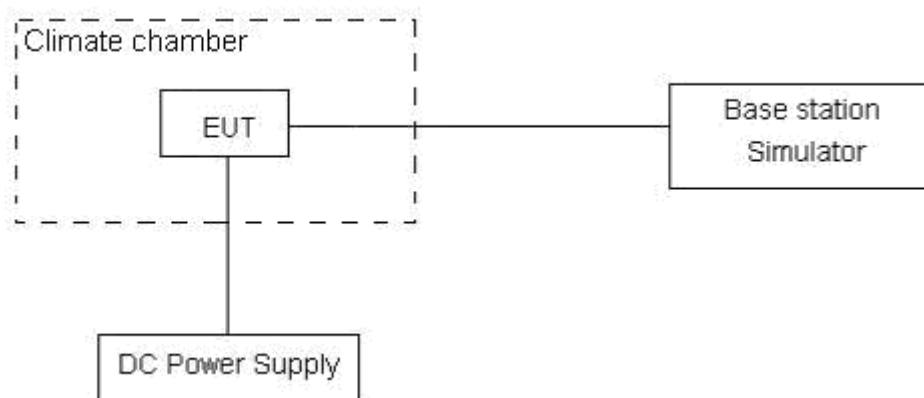





## Limits

According to the Sec. 22.355, the frequency stability of the carrier shall be accurate to within 2.5 ppm of the received frequency for mobile stations.

Limits	$\leq 2.5$ ppm
--------	----------------

## Measurement Uncertainty

The assessed measurement uncertainty to ensure 99.75% confidence level for the normal distribution is with the coverage factor  $k = 3$ ,  $U = 0.01$  ppm.

**Test Result**

WCDMA Band 5						
Condition		Freq.Error (Hz)	Freq.Error (Hz)	Frequency Stability (ppm)	Frequency Stability (ppm)	Verdict
Temperature	Voltage	BPSK	QPSK	BPSK	QPSK	
Normal (25°C)	Normal	13.48	5.84	0.00717	0.00311	PASS
Extreme (85°C)		12.55	3.93	0.00667	0.00209	PASS
Extreme (80°C)		15.35	3.71	0.00817	0.00197	PASS
Extreme (70°C)		10.82	14.68	0.00576	0.00781	PASS
Extreme (60°C)		1.85	16.10	0.00099	0.00856	PASS
Extreme (50°C)		5.17	12.47	0.00275	0.00663	PASS
Extreme (40°C)		8.22	3.73	0.00437	0.00198	PASS
Extreme (30°C)		17.72	4.85	0.00943	0.00258	PASS
Extreme (20°C)		9.04	9.13	0.00481	0.00486	PASS
Extreme (10°C)		4.19	6.25	0.00223	0.00332	PASS
Extreme (0°C)		17.17	11.58	0.00913	0.00616	PASS
Extreme (-10°C)		5.07	7.84	0.00269	0.00417	PASS
Extreme (-20°C)		6.11	12.62	0.00325	0.00671	PASS
Extreme (-30°C)		9.21	15.18	0.00490	0.00807	PASS
Extreme (-40°C)		9.68	16.75	0.00515	0.00891	PASS
25°C	LV	2.92	8.90	0.00155	0.00474	PASS
	HV	10.58	7.50	0.00563	0.00399	PASS

LTE Band 5						
Condition		Freq.Error (Hz)	Freq.Error (Hz)	Frequency Stability (ppm)	Frequency Stability (ppm)	Verdict
BANDWIDTH	1.4MHz					
Temperature	Voltage	16QAM	QPSK	16QAM	QPSK	
Normal (25°C)	Normal	2.69	8.09	0.00143	0.00430	PASS
Extreme (85°C)		17.97	8.39	0.00956	0.00446	PASS
Extreme (80°C)		2.59	17.96	0.00138	0.00956	PASS
Extreme (70°C)		7.78	11.16	0.00414	0.00593	PASS
Extreme (60°C)		6.26	12.90	0.00333	0.00686	PASS
Extreme (50°C)		10.34	14.26	0.00550	0.00758	PASS
Extreme (40°C)		7.50	6.34	0.00399	0.00337	PASS
Extreme (30°C)		17.76	8.50	0.00945	0.00452	PASS
Extreme (20°C)		12.36	15.34	0.00657	0.00816	PASS
Extreme (10°C)		8.94	2.07	0.00476	0.00110	PASS
Extreme (0°C)		13.90	14.41	0.00739	0.00766	PASS



Extreme (-10°C)		6.69	12.17	0.00356	0.00647	PASS
Extreme (-20°C)		15.09	18.00	0.00803	0.00957	PASS
Extreme (-30°C)		5.65	7.89	0.00300	0.00420	PASS
Extreme (-40°C)		1.54	13.71	0.00082	0.00729	PASS
25°C	LV	11.26	8.79	0.00599	0.00467	PASS
	HV	4.13	10.03	0.00220	0.00534	PASS
Condition		Freq.Error (Hz)	Freq.Error (Hz)	Frequency Stability (ppm)	Frequency Stability (ppm)	Verdict
BANDWIDTH	3MHz					
Temperature	Voltage	16QAM	QPSK	16QAM	QPSK	
Normal (25°C)	Normal	8.49	2.04	0.00451	0.00109	PASS
Extreme (85°C)		10.24	17.68	0.00545	0.00940	PASS
Extreme (80°C)		6.87	12.68	0.00365	0.00674	PASS
Extreme (70°C)		14.46	12.25	0.00769	0.00651	PASS
Extreme (60°C)		13.20	8.15	0.00702	0.00434	PASS
Extreme (50°C)		10.51	4.47	0.00559	0.00238	PASS
Extreme (40°C)		3.33	8.83	0.00177	0.00469	PASS
Extreme (30°C)		5.59	2.78	0.00298	0.00148	PASS
Extreme (20°C)		11.65	7.59	0.00620	0.00404	PASS
Extreme (10°C)		13.57	5.30	0.00722	0.00282	PASS
Extreme (0°C)		1.15	11.64	0.00061	0.00619	PASS
Extreme (-10°C)		9.25	13.25	0.00492	0.00705	PASS
Extreme (-20°C)		5.55	13.32	0.00295	0.00708	PASS
Extreme (-30°C)		1.60	16.87	0.00085	0.00898	PASS
Extreme (-40°C)		13.72	1.40	0.00730	0.00075	PASS
25°C		LV	5.61	16.15	0.00298	0.00859
	HV	16.94	17.50	0.00901	0.00931	PASS
Condition		Freq.Error (Hz)	Freq.Error (Hz)	Frequency Stability (ppm)	Frequency Stability (ppm)	Verdict
BANDWIDTH	5MHz					
Temperature	Voltage	16QAM	QPSK	16QAM	QPSK	
Normal (25°C)	Normal	2.98	3.60	0.00158	0.00191	PASS
Extreme (85°C)		10.58	14.24	0.00563	0.00758	PASS
Extreme (80°C)		8.75	8.75	0.00465	0.00465	PASS
Extreme (70°C)		6.29	7.15	0.00335	0.00380	PASS
Extreme (60°C)		1.64	16.97	0.00087	0.00903	PASS
Extreme (50°C)		8.34	17.12	0.00444	0.00910	PASS
Extreme (40°C)		3.14	8.84	0.00167	0.00470	PASS
Extreme (30°C)		13.77	4.41	0.00732	0.00234	PASS
Extreme (20°C)		3.09	1.18	0.00165	0.00063	PASS
Extreme (10°C)		15.75	3.68	0.00838	0.00196	PASS



Extreme (0°C)		5.77	8.69	0.00307	0.00462	PASS
Extreme (-10°C)		2.12	5.21	0.00113	0.00277	PASS
Extreme (-20°C)		2.77	13.23	0.00147	0.00704	PASS
Extreme (-30°C)		16.72	11.09	0.00890	0.00590	PASS
Extreme (-40°C)		11.40	13.31	0.00606	0.00708	PASS
25°C	LV	6.26	8.98	0.00333	0.00478	PASS
	HV	17.88	1.20	0.00951	0.00064	PASS
Condition		Freq.Error (Hz)	Freq.Error (Hz)	Frequency Stability (ppm)	Frequency Stability (ppm)	Verdict
BANDWIDTH	10MHz					
Temperature	Voltage	16QAM	QPSK	16QAM	QPSK	
Normal (25°C)	Normal	2.62	11.11	0.00139	0.00591	PASS
Extreme (85°C)		11.39	1.46	0.00606	0.00078	PASS
Extreme (80°C)		8.64	6.71	0.00460	0.00357	PASS
Extreme (70°C)		16.32	1.82	0.00868	0.00097	PASS
Extreme (60°C)		2.42	17.00	0.00129	0.00904	PASS
Extreme (50°C)		17.49	14.96	0.00930	0.00796	PASS
Extreme (40°C)		13.18	14.08	0.00701	0.00749	PASS
Extreme (30°C)		4.90	4.75	0.00260	0.00253	PASS
Extreme (20°C)		6.00	9.80	0.00319	0.00521	PASS
Extreme (10°C)		12.43	17.77	0.00661	0.00945	PASS
Extreme (0°C)		1.41	11.65	0.00075	0.00620	PASS
Extreme (-10°C)		11.27	10.15	0.00599	0.00540	PASS
Extreme (-20°C)		5.26	11.92	0.00280	0.00634	PASS
Extreme (-30°C)		13.57	17.27	0.00722	0.00918	PASS
Extreme (-40°C)		1.01	5.79	0.00054	0.00308	PASS
25°C	LV	12.23	5.26	0.00651	0.00280	PASS
	HV	14.02	12.82	0.00746	0.00682	PASS

### 5.7. Spurious Emissions at Antenna Terminals

#### Ambient condition

Temperature	Relative humidity	Pressure
23°C ~25°C	45%~50%	101.5kPa

#### Method of Measurement

The EUT was connected to Spectrum Analyzer and Base Station Simulator via power Splitter. The measurement is carried out using a spectrum analyzer. The spectrum analyzer scans from 9kHz to the 10th harmonic of the carrier.

The peak detector is used. RBW are set to 100 kHz and VBW are set to 300 kHz for below 1G, RBW are set to 1MHz and VBW are set to 3MHz for above 1G, Sweep is set to ATUO.

The modulation mode and RB allocation refer to section 5.1, using the maximum output power configuration.

#### Test setup

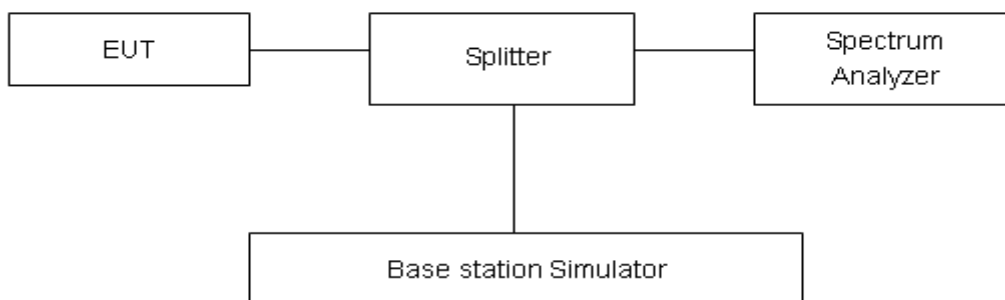

#### Limits

Rule Part 22.917(a) specifies that “The power of any emission outside of the authorized operating frequency ranges must be attenuated below the transmitting power (P) by a factor of at least 43 + 10 log (P) dB.”

Limit	-13 dBm
-------	---------

#### Measurement Uncertainty

The assessed measurement uncertainty to ensure 99.75% confidence level for the normal distribution is with the coverage factor  $k = 1.96$ .

Frequency	Uncertainty
9kHz-1GHz	0.684 dB
1GHz-18GHz	1.407 dB

## Test Result

Sweep the whole frequency band through the range from 9kHz to the 10th harmonic of the carrier, the emissions more than 20 dB below the limit are not reported.

The signal beyond the limit is carrier.

### WCDMA Band V CH-Low 30MHz ~ 1GHz

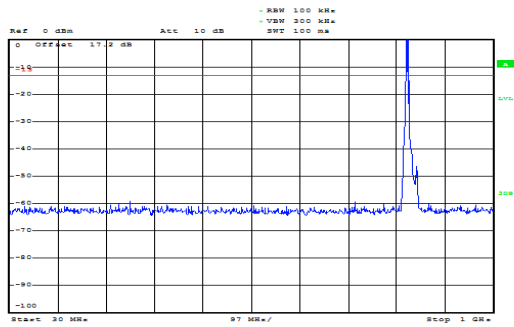

### WCDMA Band V CH-Low 1GHz ~ 9GHz

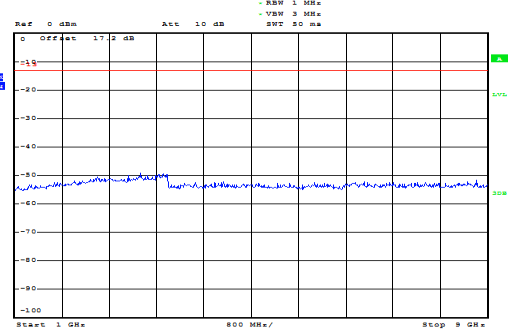

### WCDMA Band V CH-Middle 30MHz ~ 1GHz

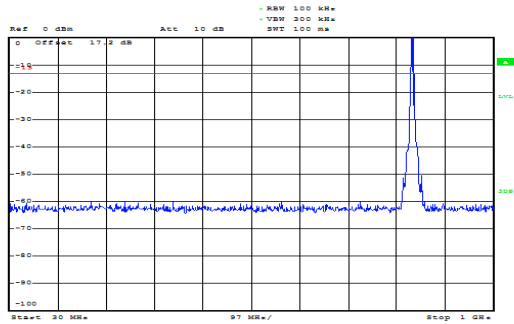

### WCDMA Band V CH-Middle 1GHz ~ 9GHz

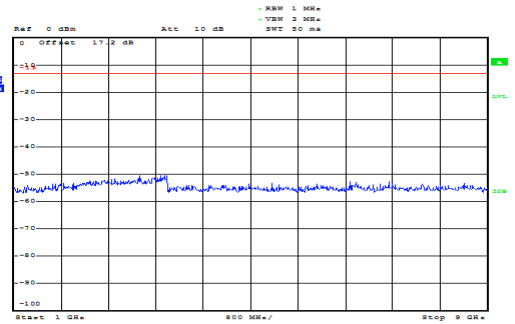

### WCDMA Band V CH-High 30MHz ~ 1GHz

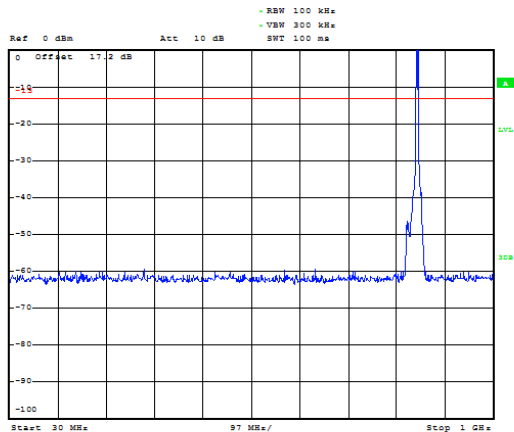

### WCDMA Band V CH-High 1GHz ~ 9GHz

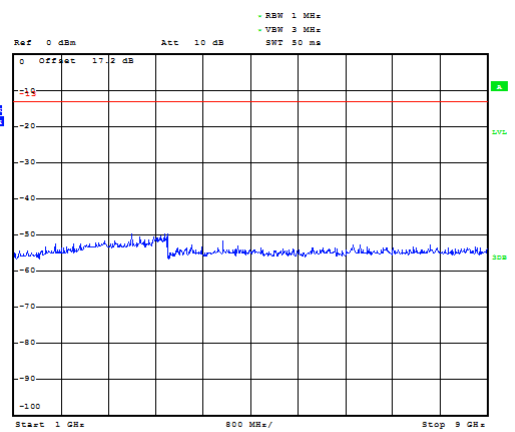



### LTE Band 5 1.4MHz CH-Low 30MHz~1GHz

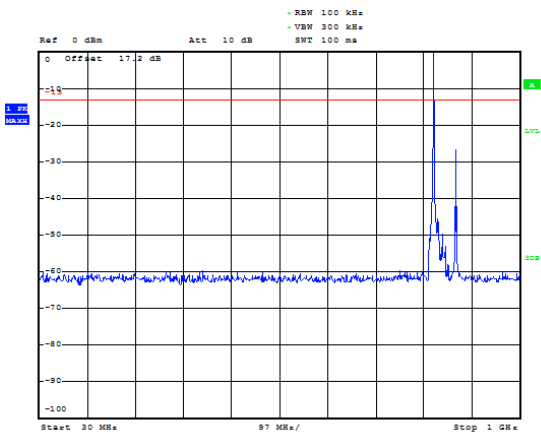

### LTE Band 5 1.4MHz CH-Low 1GHz~9GHz

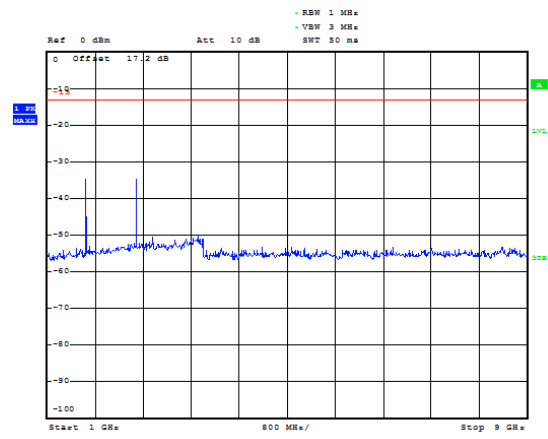

### LTE Band 5 1.4MHz CH-Middle 30MHz~1GHz

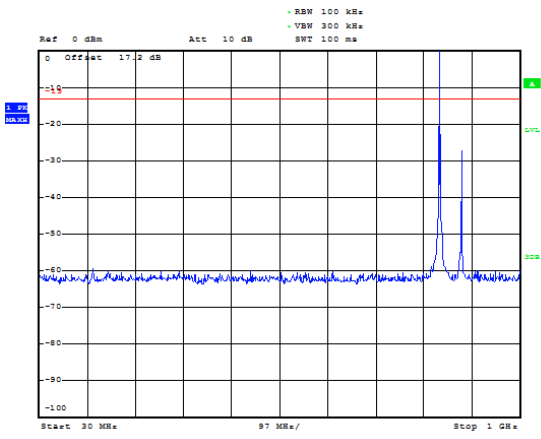

### LTE Band 5 1.4MHz CH-Middle 1GHz~9GHz

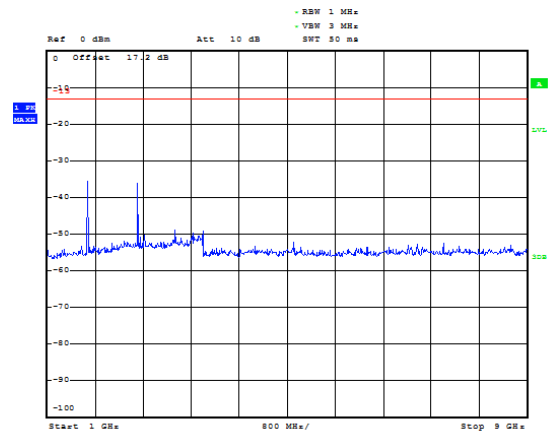

### LTE Band 5 1.4MHz CH-High 30MHz~1GHz

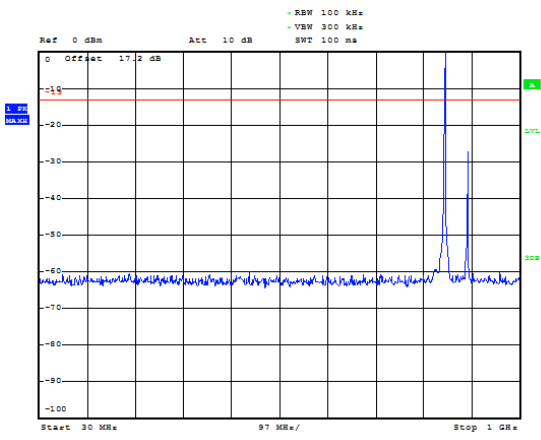

### LTE Band 5 1.4MHz CH-High 1GHz~9GHz

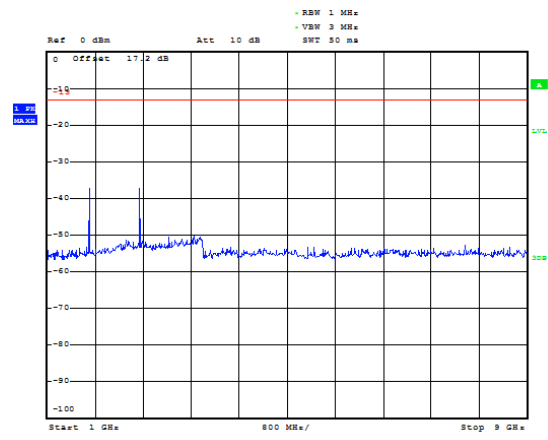



### LTE Band 5 3MHz CH-Low 30MHz~1GHz

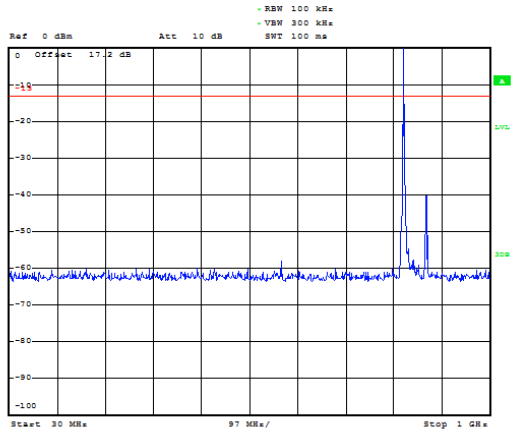

### LTE Band 5 3MHz CH-Low 1GHz~9GHz

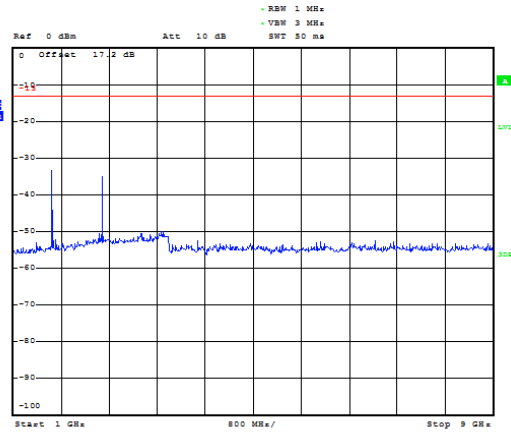

### LTE Band 5 3MHz CH-Middle 30MHz~1GHz

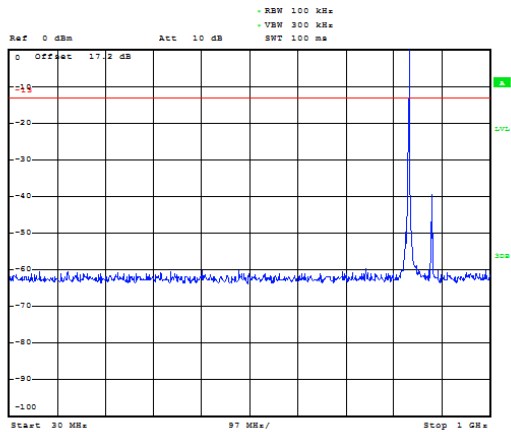

### LTE Band 5 3MHz CH-Middle 1GHz~9GHz

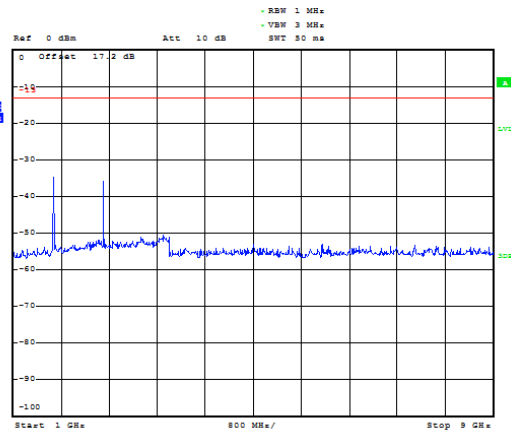

### LTE Band 5 3MHz CH-High 30MHz~1GHz

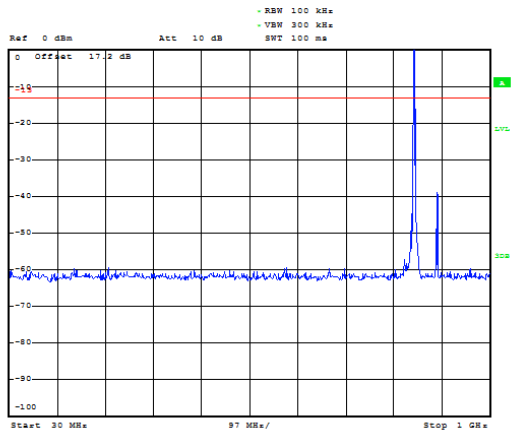

### LTE Band 5 3MHz CH-High 1GHz~9GHz

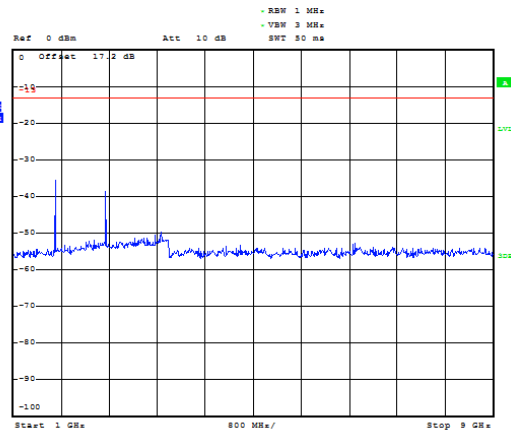





### LTE Band 5 5MHz CH-Low 30MHz~1GHz

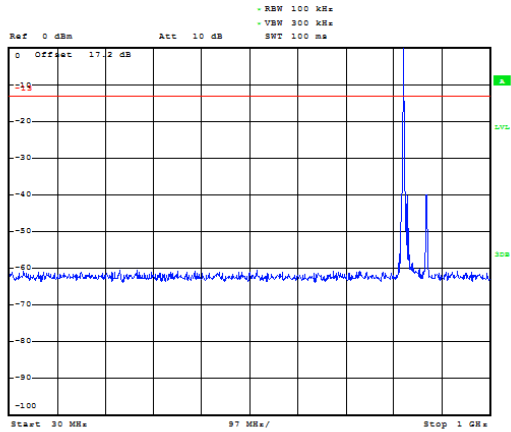

### LTE Band 5 5MHz CH-Low 1GHz~9GHz

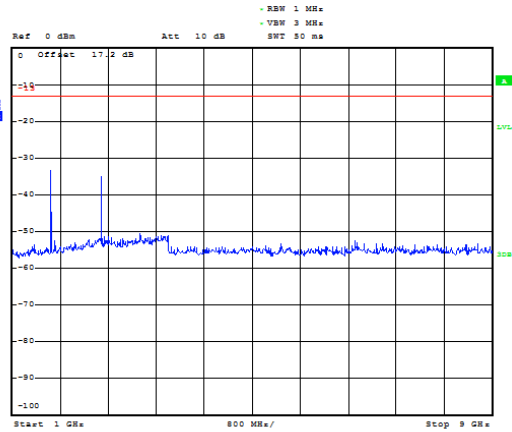

### LTE Band 5 5MHz CH-Middle 30MHz~1GHz

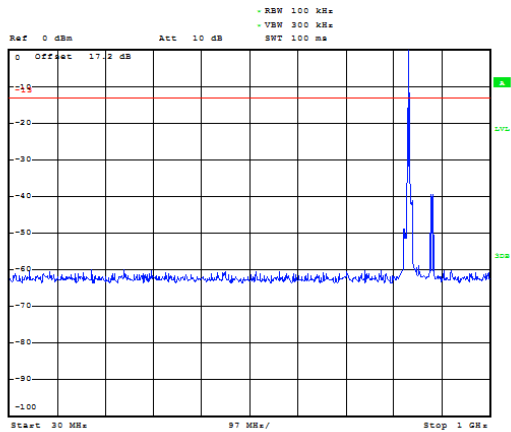

### LTE Band 5 5MHz CH-Middle 1GHz~9GHz

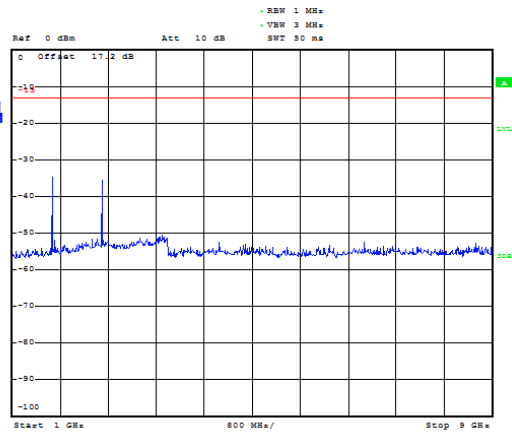

### LTE Band 5 5MHz CH-High 30MHz~1GHz

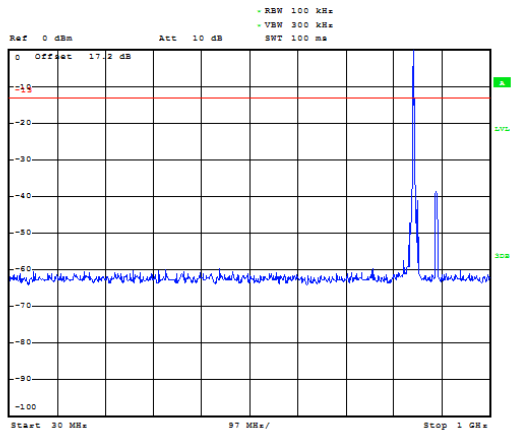

### LTE Band 5 5MHz CH-High 1GHz~9GHz

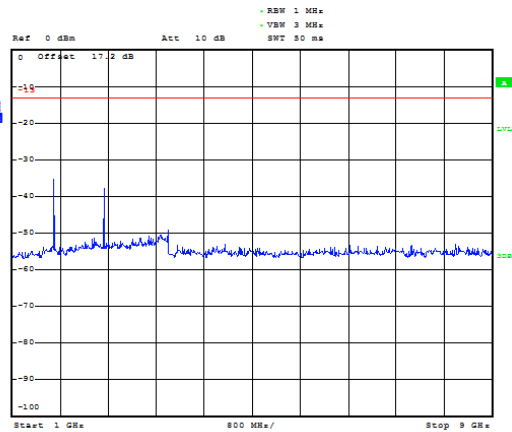



### LTE Band 5 10MHz CH-Low 30MHz~1GHz

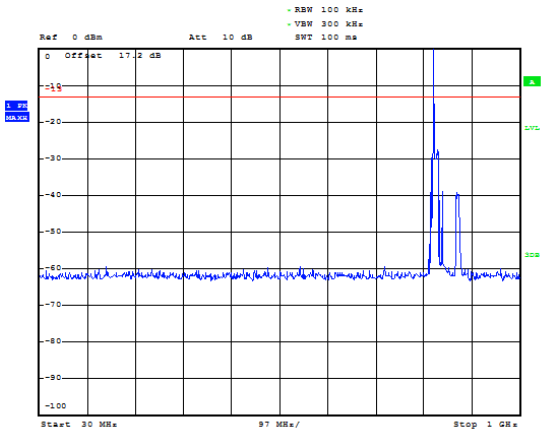

### LTE Band 5 10MHz CH-Low 1GHz~9GHz

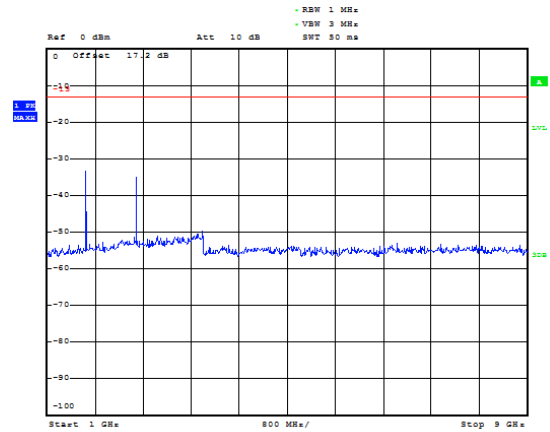

### LTE Band 5 10MHz CH-Middle 30MHz~1GHz

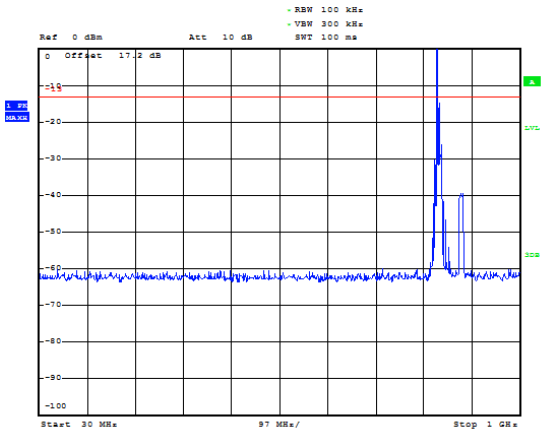

### LTE Band 5 10MHz CH-Middle 1GHz~9GHz

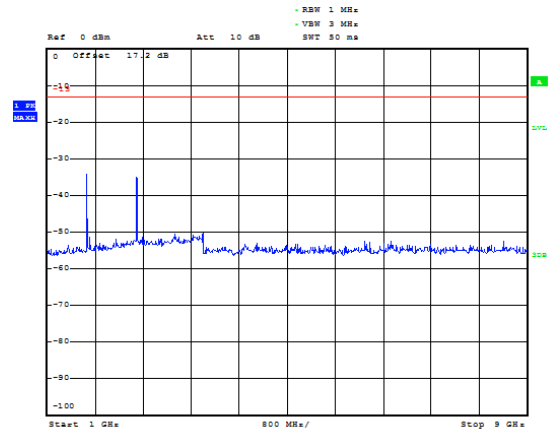

### LTE Band 5 10MHz CH-High 30MHz~1GHz

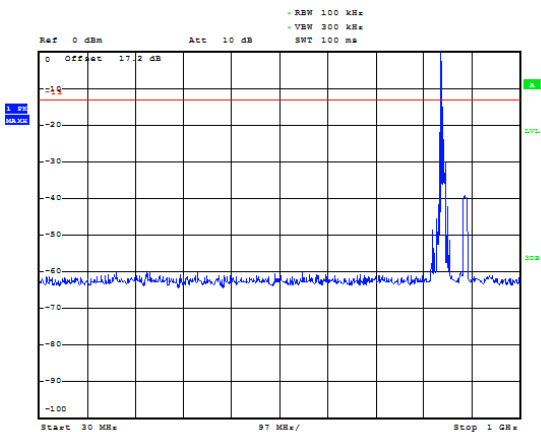

### LTE Band 5 10MHz CH-High 1GHz~9GHz

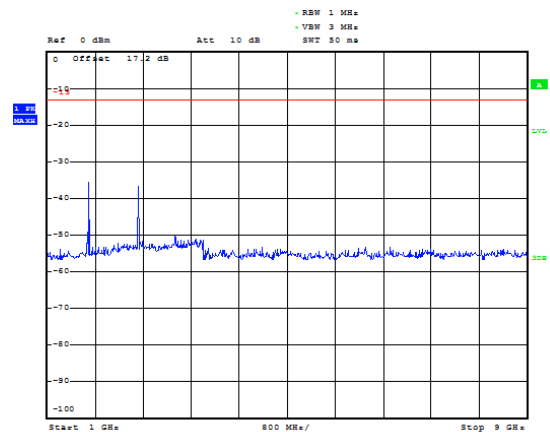

## 5.8. Radiates Spurious Emission

### Ambient condition

Temperature	Relative humidity	Pressure
23°C ~25°C	45%~50%	101.5kPa

### Method of Measurement

1. The testing follows FCC KDB 971168 v03r01 Section 5.8 and ANSI/TIA-603-E (2016).
2. The EUT is placed on a turntable 0.8 meters above the ground in the chamber, 3 meter away from the antenna. The maximal emission value is acquired by adjusting the antenna height, polarisation and turntable azimuth. Normally, the height range of antenna is 1 m to 4 m, the azimuth range of turntable is 0° to 360°, and the receive antenna has two polarizations Vertical (V) and Horizontal (H).
3. A log-periodic antenna or double-ridged waveguide horn antenna shall be substituted in place of the EUT. The log-periodic antenna will be driven by a signal generator and the level will be adjusted till the same power value on the spectrum analyzer or receiver. The level of the spurious emissions can be calculated through the level of the signal generator, cable loss, the gain of the substitution antenna and the reading of the spectrum analyzer or receiver.
4. The EUT is then put into continuously transmitting mode at its maximum power level during the test. Set Test Receiver or Spectrum RBW=1MHz, VBW=3MHz for above 1GHz and RBW=100kHz, VBW=300kHz for 30MHz to 1GHz, And the maximum value of the receiver should be recorded as (Pr).
5. The EUT shall be replaced by a substitution antenna. In the chamber, an substitution antenna for the frequency band of interest is placed at the reference point of the chamber. An RF Signal source for the frequency band of interest is connected to the substitution antenna with a cable that has been constructed to not interfere with the radiation pattern of the antenna. A power (PMea) is applied to the input of the substitution antenna, and adjust the level of the signal generator output until the value of the receiver reach the previously recorded (Pr). The power of signal source (PMea) is recorded. The test should be performed by rotating the test item and adjusting the receiving antenna polarization.
6. A amplifier should be connected to the Signal Source output port. And the cable should be connect between the Amplifier and the Substitution Antenna. The cable loss (Pcl), the Substitution Antenna Gain (Ga) and the Amplifier Gain (PAg) should be recorded after test.
7. The measurement results are obtained as described below:  
Power(EIRP)=PMea- PAg - Pcl + Ga  
The measurement results are amend as described below:  
Power(EIRP)=PMea- Pcl + Ga
8. This value is EIRP since the measurement is calibrated using an antenna of known gain (2.15 dBi) and known input power. ERP can be calculated from EIRP by subtracting the gain of the dipole, ERP = EIRP-2.15dBi.  
The modulation mode and RB allocation refer to section 5.1, using the maximum output power configuration.

**Test setup**

**30MHz~~~ 1GHz**

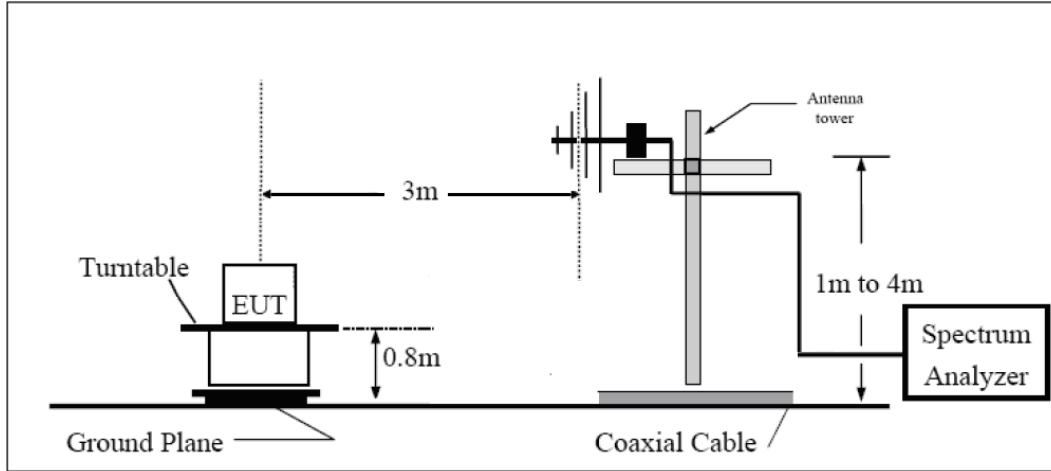

**Above 1GHz**

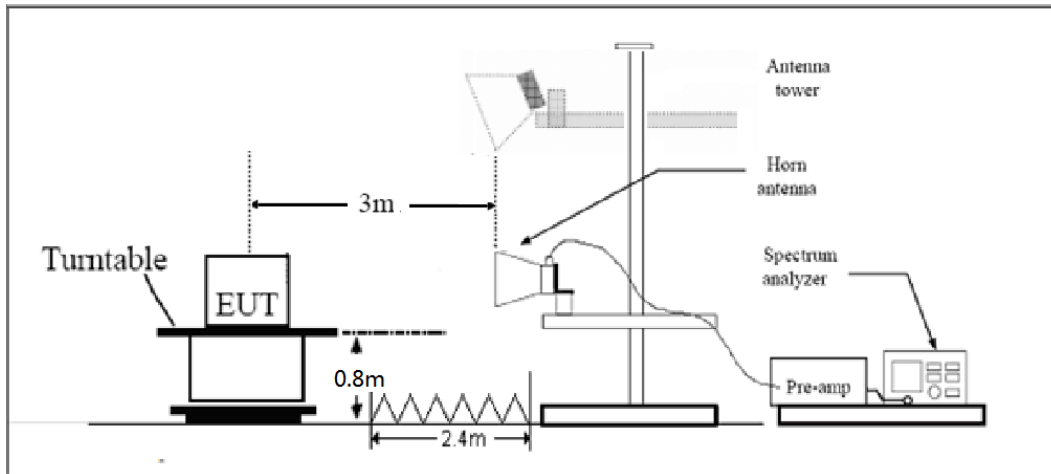

Note: Area side:2.4mX3.6m

**Limits**

Rule Part 22.917(a) specifies that “The power of any emission outside of the authorized operating frequency ranges must be attenuated below the transmitting power (P) by a factor of at least  $43 + 10 \log (P)$  dB.”

Limit	-13 dBm
-------	---------

**Measurement Uncertainty**

The assessed measurement uncertainty to ensure 95% confidence level for the normal distribution is with the coverage factor  $k = 1.96$ ,  $U = 3.55$  dB.

**Test Result**

Sweep the whole frequency band through the range from 30MHz to the 10th harmonic of the carrier, the emissions below the noise floor will not be recorded in the report.

## WCDMA Band V CH-Low

Harmonic	Frequency (MHz)	SG (dBm)	Cable Loss (dB)	Gain (dBi)	Antenna Polarization	ERP Level (dBm)	Limit (dBm)	Margin (dB)	Azimuth (deg)
2	1653	-61.20	2	10.15	Horizontal	-55.2	-13.0	42.2	45
3	2479	-42.89	2.51	11.35	Horizontal	-36.2	-13.0	23.2	135
4	3306	-62.00	4.2	10.85	Horizontal	-57.5	-13.0	44.5	90
5	4132	-58.70	5.2	11.35	Horizontal	-54.7	-13.0	41.7	135
6	4958	-57.50	5.5	11.95	Horizontal	-53.2	-13.0	40.2	370
7	5785	-58.20	5.7	13.55	Horizontal	-52.5	-13.0	39.5	45
8	6611	-55.80	6.3	13.75	Horizontal	-50.5	-13.0	37.5	0
9	7438	-52.60	6.8	13.85	Horizontal	-47.7	-13.0	34.7	90
10	8264	-52.40	6.9	14.25	Horizontal	-47.2	-13.0	34.2	180

Note: 1.The other Spurious RF Radiated emissions level is no more than noise floor.  
2.The worst emission was found in the antenna is Horizontal position.

## WCDMA Band V CH-Middle

Harmonic	Frequency (MHz)	SG (dBm)	Cable Loss (dB)	Gain (dBi)	Antenna Polarization	ERP Level (dBm)	Limit (dBm)	Margin (dB)	Azimuth (deg)
2	1673.2	-62.71	2	10.75	Horizontal	-56.11	-13.00	43.11	45
3	2509.8	-61.27	2.51	11.05	Horizontal	-54.88	-13.00	41.88	315
4	3346.4	-56.93	4.2	11.15	Horizontal	-52.13	-13.00	39.13	225
5	4183.0	-54.67	5.2	11.15	Horizontal	-50.87	-13.00	37.87	45
6	5019.6	-54.27	5.5	11.95	Horizontal	-49.97	-13.00	36.97	180
7	5856.2	-56.38	5.7	13.55	Horizontal	-50.68	-13.00	37.68	0
8	6692.8	-56.45	6.3	13.75	Horizontal	-51.15	-13.00	38.15	90
9	7529.4	-54.94	6.8	13.85	Horizontal	-50.04	-13.00	37.04	90
10	8366.0	-53.27	6.9	14.25	Horizontal	-48.07	-13.00	35.07	315

Note: 1.The other Spurious RF Radiated emissions level is no more than noise floor.  
2.The worst emission was found in the antenna is Horizontal position.

WCDMA Band V CH-High

Harmonic	Frequency (MHz)	SG (dBm)	Cable Loss (dB)	Gain (dBi)	Antenna Polarization	ERP Level (dBm)	Limit (dBm)	Margin (dB)	Azimuth (deg)
2	1693	-58.20	2	10.15	Horizontal	-52.2	-13.0	39.2	315
3	2540	-61.19	2.51	11.05	Horizontal	-54.8	-13.0	41.8	225
4	3386	-61.70	4.2	11.15	Horizontal	-56.9	-13.0	43.9	45
5	4233	-57.90	5.2	11.15	Horizontal	-54.1	-13.0	41.1	180
6	5080	-55.40	5.5	11.95	Horizontal	-51.1	-13.0	38.1	270
7	5926	-56.40	5.7	13.55	Horizontal	-50.7	-13.0	37.7	45
8	6773	-55.20	6.3	13.75	Horizontal	-49.9	-13.0	36.9	135
9	7619	-52.40	6.8	13.85	Horizontal	-47.5	-13.0	34.5	315
10	8466	-53.30	6.9	14.25	Horizontal	-48.1	-13.0	35.1	0

Note: 1.The other Spurious RF Radiated emissions level is no more than noise floor.  
 2.The worst emission was found in the antenna is Horizontal position.

LTE Band 5 1.4MHz CH-Low

Harmonic	Frequency (MHz)	SG (dBm)	Cable Loss (dB)	Gain (dBi)	Antenna Polarization	ERP Level (dBm)	Limit (dBm)	Margin (dB)	Azimuth (deg)
2	1649.4	-57.70	2.00	10.75	Horizontal	-51.1	-13.0	38.1	135
3	2474.1	-59.39	2.51	11.05	Horizontal	-53.0	-13.0	40.0	370
4	3298.8	-61.60	4.20	11.15	Horizontal	-56.8	-13.0	43.8	315
5	4123.5	-59.50	5.20	11.15	Horizontal	-55.7	-13.0	42.7	45
6	4948.2	-56.80	5.50	11.95	Horizontal	-52.5	-13.0	39.5	90
7	5772.9	-57.80	5.70	13.55	Horizontal	-52.1	-13.0	39.1	135
8	6597.6	-55.80	6.30	13.75	Horizontal	-50.5	-13.0	37.5	370
9	7422.3	-53.10	6.80	13.85	Horizontal	-48.2	-13.0	35.2	0
10	8247.0	-53.80	6.90	14.25	Horizontal	-48.6	-13.0	35.6	45

Note: 1.The other Spurious RF Radiated emissions level is no more than noise floor.  
 2.The worst emission was found in the antenna is Horizontal position.



## LTE Band 5 1.4MHz CH-Middle

Harmonic	Frequency (MHz)	SG (dBm)	Cable Loss (dB)	Gain (dBi)	Antenna Polarization	ERP Level (dBm)	Limit (dBm)	Margin (dB)	Azimuth (deg)
2	1673.0	-55.70	2.00	10.75	Horizontal	-49.1	-13.0	36.1	0
3	2509.5	-59.79	2.51	11.05	Horizontal	-53.4	-13.0	40.4	45
4	3346.0	-61.90	4.20	11.15	Horizontal	-57.1	-13.0	44.1	90
5	4182.5	-59.40	5.20	11.15	Horizontal	-55.6	-13.0	42.6	135
6	5019.0	-56.60	5.50	11.95	Horizontal	-52.3	-13.0	39.3	45
7	5855.5	-57.60	5.70	13.55	Horizontal	-51.9	-13.0	38.9	90
8	6692.0	-56.00	6.30	13.75	Horizontal	-50.7	-13.0	37.7	135
9	7528.5	-53.20	6.80	13.85	Horizontal	-48.3	-13.0	35.3	315
10	8365.0	-53.40	6.90	14.25	Horizontal	-48.2	-13.0	35.2	45

Note: 1.The other Spurious RF Radiated emissions level is no more than noise floor.  
2.The worst emission was found in the antenna is Horizontal position.

## LTE Band 5 1.4MHz CH-High

Harmonic	Frequency (MHz)	SG (dBm)	Cable Loss (dB)	Gain (dBi)	Antenna Polarization	ERP Level (dBm)	Limit (dBm)	Margin (dB)	Azimuth (deg)
2	1696.6	-56.30	2.00	10.75	Horizontal	-49.7	-13.0	36.7	90
3	2544.9	-61.79	2.51	11.05	Horizontal	-55.4	-13.0	42.4	135
4	3393.2	-61.30	4.20	11.15	Horizontal	-56.5	-13.0	43.5	0
5	4241.5	-58.10	5.20	11.15	Horizontal	-54.3	-13.0	41.3	45
6	5089.8	-58.00	5.50	11.95	Horizontal	-53.7	-13.0	40.7	90
7	5938.1	-58.10	5.70	13.55	Horizontal	-52.4	-13.0	39.4	135
8	6786.4	-56.60	6.30	13.75	Horizontal	-51.3	-13.0	38.3	370
9	7634.7	-53.40	6.80	13.85	Horizontal	-48.5	-13.0	35.5	90
10	8483.0	-53.10	6.90	14.25	Horizontal	-47.9	-13.0	34.9	315

Note: 1.The other Spurious RF Radiated emissions level is no more than noise floor.  
2.The worst emission was found in the antenna is Horizontal position.

LTE Band 5 5MHz CH-Low

Harmonic	Frequency (MHz)	SG (dBm)	Cable Loss (dB)	Gain (dBi)	Antenna Polarization	ERP Level (dBm)	Limit (dBm)	Margin (dB)	Azimuth (deg)
2	1649.6	-58.30	2.00	10.75	Horizontal	-51.7	-13.0	38.7	45
3	2479.5	-62.19	2.51	11.05	Horizontal	-55.8	-13.0	42.8	90
4	3306.0	-61.60	4.20	11.15	Horizontal	-56.8	-13.0	43.8	45
5	4132.5	-58.40	5.20	11.15	Horizontal	-54.6	-13.0	41.6	90
6	4959.0	-59.10	5.50	11.95	Horizontal	-54.8	-13.0	41.8	135
7	5785.5	-57.80	5.70	13.55	Horizontal	-52.1	-13.0	39.1	315
8	6612.0	-57.70	6.30	13.75	Horizontal	-52.4	-13.0	39.4	45
9	7438.5	-52.40	6.80	13.85	Horizontal	-47.5	-13.0	34.5	90
10	8265.0	-52.10	6.90	14.25	Horizontal	-46.9	-13.0	33.9	135

Note: 1.The other Spurious RF Radiated emissions level is no more than noise floor.  
 2.The worst emission was found in the antenna is Horizontal position.

LTE Band 5 5MHz CH-Middle

Harmonic	Frequency (MHz)	SG (dBm)	Cable Loss (dB)	Gain (dBi)	Antenna Polarization	ERP Level (dBm)	Limit (dBm)	Margin (dB)	Azimuth (deg)
2	1673.0	-55.50	2.00	10.75	Horizontal	-48.9	-13.0	35.9	135
3	2509.5	-61.89	2.51	11.05	Horizontal	-55.5	-13.0	42.5	0
4	3346.0	-59.20	4.20	11.15	Horizontal	-54.4	-13.0	41.4	315
5	4182.5	-58.50	5.20	11.15	Horizontal	-54.7	-13.0	41.7	45
6	5019.0	-57.50	5.50	11.95	Horizontal	-53.2	-13.0	40.2	0
7	5855.5	-58.40	5.70	13.55	Horizontal	-52.7	-13.0	39.7	45
8	6692.0	-56.40	6.30	13.75	Horizontal	-51.1	-13.0	38.1	90
9	7528.5	-52.70	6.80	13.85	Horizontal	-47.8	-13.0	34.8	135
10	8365.0	-53.10	6.90	14.25	Horizontal	-47.9	-13.0	34.9	370

Note: 1.The other Spurious RF Radiated emissions level is no more than noise floor.  
 2.The worst emission was found in the antenna is Horizontal position.





## LTE Band 5 5MHz CH-High

Harmonic	Frequency (MHz)	SG (dBm)	Cable Loss (dB)	Gain (dBi)	Antenna Polarization	ERP Level (dBm)	Limit (dBm)	Margin (dB)	Azimuth (deg)
2	1693.0	-58.90	2.00	10.75	Horizontal	-52.3	-13.0	39.3	45
3	2539.5	-60.29	2.51	11.05	Horizontal	-53.9	-13.0	40.9	90
4	3386.0	-58.60	4.20	11.15	Horizontal	-53.8	-13.0	40.8	90
5	4232.5	-57.20	5.20	11.15	Horizontal	-53.4	-13.0	40.4	315
6	5079.0	-57.20	5.50	11.95	Horizontal	-52.9	-13.0	39.9	45
7	5925.5	-58.00	5.70	13.55	Horizontal	-52.3	-13.0	39.3	90
8	6772.0	-56.00	6.30	13.75	Horizontal	-50.7	-13.0	37.7	135
9	7618.5	-52.20	6.80	13.85	Horizontal	-47.3	-13.0	34.3	315
10	8465.0	-52.00	6.90	14.25	Horizontal	-46.8	-13.0	33.8	45

Note: 1.The other Spurious RF Radiated emissions level is no more than noise floor.

2.The worst emission was found in the antenna is Horizontal position.

## LTE Band 5 10MHz CH-Low

Harmonic	Frequency (MHz)	SG (dBm)	Cable Loss (dB)	Gain (dBi)	Antenna Polarization	ERP Level (dBm)	Limit (dBm)	Margin (dB)	Azimuth (deg)
2	1658.0	-58.40	2.00	10.75	Horizontal	-51.8	-13.0	38.8	135
3	2487.0	-62.09	2.51	11.05	Horizontal	-55.7	-13.0	42.7	370
4	3316.0	-58.20	4.20	11.15	Horizontal	-53.4	-13.0	40.4	90
5	4145.0	-56.60	5.20	11.15	Horizontal	-52.8	-13.0	39.8	135
6	4974.0	-56.80	5.50	11.95	Horizontal	-52.5	-13.0	39.5	315
7	5803.0	-57.80	5.70	13.55	Horizontal	-52.1	-13.0	39.1	45
8	6632.0	-56.00	6.30	13.75	Horizontal	-50.7	-13.0	37.7	0
9	7461.0	-52.90	6.80	13.85	Horizontal	-48.0	-13.0	35.0	45
10	8290.0	-52.70	6.90	14.25	Horizontal	-47.5	-13.0	34.5	90

Note: 1.The other Spurious RF Radiated emissions level is no more than noise floor.

2.The worst emission was found in the antenna is Horizontal position.



## LTE Band 5 10MHz CH-Middle

Harmonic	Frequency (MHz)	SG (dBm)	Cable Loss (dB)	Gain (dBi)	Antenna Polarization	ERP Level (dBm)	Limit (dBm)	Margin (dB)	Azimuth (deg)
2	1673.0	-57.30	2.00	10.75	Horizontal	-50.7	-13.0	37.7	90
3	2509.5	-61.89	2.51	11.05	Horizontal	-55.5	-13.0	42.5	315
4	3346.0	-58.50	4.20	11.15	Horizontal	-53.7	-13.0	40.7	135
5	4182.5	-57.20	5.20	11.15	Horizontal	-53.4	-13.0	40.4	135
6	5019.0	-56.90	5.50	11.95	Horizontal	-52.6	-13.0	39.6	370
7	5855.5	-58.20	5.70	13.55	Horizontal	-52.5	-13.0	39.5	90
8	6692.0	-55.70	6.30	13.75	Horizontal	-50.4	-13.0	37.4	315
9	7528.5	-52.40	6.80	13.85	Horizontal	-47.5	-13.0	34.5	45
10	8365.0	-52.50	6.90	14.25	Horizontal	-47.3	-13.0	34.3	90

Note: 1.The other Spurious RF Radiated emissions level is no more than noise floor.

2.The worst emission was found in the antenna is Horizontal position.

## LTE Band 5 10MHz CH-High

Harmonic	Frequency (MHz)	SG (dBm)	Cable Loss (dB)	Gain (dBi)	Antenna Polarization	ERP Level (dBm)	Limit (dBm)	Margin (dB)	Azimuth (deg)
2	1688.0	-59.60	2.00	10.75	Horizontal	-53.0	-13.0	40.0	45
3	2532.0	-62.39	2.51	11.05	Horizontal	-56.0	-13.0	43.0	0
4	3376.0	-58.20	4.20	11.15	Horizontal	-53.4	-13.0	40.4	135
5	4220.0	-56.60	5.20	11.15	Horizontal	-52.8	-13.0	39.8	315
6	5064.0	-56.90	5.50	11.95	Horizontal	-52.6	-13.0	39.6	90
7	5908.0	-57.80	5.70	13.55	Horizontal	-52.1	-13.0	39.1	135
8	6752.0	-55.50	6.30	13.75	Horizontal	-50.2	-13.0	37.2	315
9	7596.0	-52.20	6.80	13.85	Horizontal	-47.3	-13.0	34.3	45
10	8440.0	-52.10	6.90	14.25	Horizontal	-46.9	-13.0	33.9	0

Note: 1.The other Spurious RF Radiated emissions level is no more than noise floor.

2.The worst emission was found in the antenna is Horizontal position.

## 6. Main Test Instruments

Date of Testing: May 25, 2018 ~ June 27, 2018

Name	Manufacturer	Type	Serial Number	Calibration Date	Expiration Date
Base Station Simulator	R&S	CMW500	113824	2018-05-20	2019-05-19
Power Splitter	Hua Xiang	SHX-GF2-2-13	10120101	NA	NA
Spectrum Analyzer	Agilent	N9010A	MY47191109	2018-05-20	2019-05-19
Universal Radio Communication Tester	Agilent	E5515C	MY48367192	2018-05-20	2019-05-19
Signal Analyzer	R&S	FSV30	100815	2017-12-17	2018-12-16
EMI Test Receiver	R&S	ESCI	100948	2018-05-20	2019-05-19
Signal generator	R&S	SMB 100A	102594	2018-05-13	2019-05-12
Signal generator	R&S	SMR27	100365	2018-05-14	2019-05-13
Loop Antenna	SCHWARZBECK	FMZB1519	1519-047	2014-12-06	2019-12-05
Trilog Antenna	SCHWARZBECK	VUBL 9163	9163-201	2017-11-18	2020-11-17
Horn Antenna	R&S	HF907	100126	2014-12-06	2019-12-05
Horn Antenna	ETS-Lindgren	3160-09	00102644	2015-01-30	2020-01-29
Climatic Chamber	Re Ce	PT-30B	20101891	2015-07-18	2018-07-17
RF Cable	Agilent	SMA 15cm	0001	2018-02-03	2018-08-02
Preamplifier	R&S	SCU18	102327	2018-05-20	2019-05-19
Software	R&S	EMC32	V 8.52.0	NA	NA
MOB COMMS DC SUPPLY	Keysight	66319D	MY43004105	2018-05-07	2019-05-06



Date of Testing: June 29, 2020

Name	Manufacturer	Type	Serial Number	Calibration Date	Expiration Date
Base Station Simulator	R&S	CMW500	113824	2020-05-18	2021-05-17
Power Splitter	Hua Xiang	SHX-GF2-2-13	10120101	/	/
Spectrum Analyzer	Key sight	N9010A	MY50210259	2020-05-18	2021-05-17
Universal Radio Communication Tester	Key sight	E5515C	MY48367192	2020-05-27	2021-05-26
Signal Analyzer	R&S	FSV30	100815	2019-12-15	2020-12-14
Loop Antenna	SCHWARZBECK	FMZB1519	1519-047	2017-09-26	2020-09-25
Trilog Antenna	SCHWARZBECK	VUBL 9163	9163-201	2017-11-18	2020-11-17
Horn Antenna	R&S	HF907	102723	2018-08-11	2021-08-10
Horn Antenna	ETS-Lindgren	3160-09	00102643	2018-06-20	2021-06-19
Signal generator	R&S	SMB 100A	102594	2020-05-18	2021-05-17
Climatic Chamber	ESPEC	SU-242	93000506	2017-12-17	2020-12-16
Preamplifier	R&S	SCU18	102327	2020-05-18	2021-05-17
MOB COMMS DC SUPPLY	Keysight	66319D	MY43004105	2020-05-18	2021-05-17
RF Cable	Agilent	SMA 15cm	0001	2020-06-12	2020-12-11
Software	R&S	EMC32	9.26.0	/	/

\*\*\*\*\*END OF REPORT \*\*\*\*\*