



# RF TEST REPORT

**Applicant**      Quectel Wireless Solutions Co., Ltd  
**FCC ID**            XMR202008EG91NAXD  
**Product**          LTE Module  
**Brand**             Quectel  
**Model**             EG91-NAXD  
**Report No.**        R2006A0379-R6  
**Issue Date**        July 29, 2020

TA Technology (Shanghai) Co., Ltd. tested the above equipment in accordance with the requirements in **FCC CFR47 Part 2 (2019)/ FCC CFR 47 Part 24E (2019)**. The test results show that the equipment tested is capable of demonstrating compliance with the requirements as documented in this report.

*Performed by: Peng Tao*

*Approved by: Kai Xu*

---

**TA Technology (Shanghai) Co., Ltd.**

*No.145, Jintang Rd, Tangzhen Industry Park, Pudong Shanghai, China*

*TEL: +86-021-50791141/2/3*

*FAX: +86-021-50791141/2/3-8000*



## TABLE OF CONTENT

1. Test Laboratory .....	4
1.1. Notes of the test report.....	4
1.2. Test facility.....	4
1.3. Testing Location .....	4
2. General Description of Equipment under Test.....	5
2.1. Applicant and Manufacturer Information .....	5
2.2. General information .....	5
3. Applied Standards.....	7
4. Test Configuration.....	8
5. Test Case Results.....	10
5.3. RF Power Output.....	10
5.4. Effective Isotropic Radiated Power .....	14
5.5. Occupied Bandwidth .....	18
5.6. Band Edge Compliance.....	27
5.7. Peak-to-Average Power Ratio (PAPR) .....	35
5.8. Frequency Stability .....	38
5.9. Spurious Emissions at Antenna Terminals .....	42
5.10. Radiates Spurious Emission.....	55
6. Main Test Instruments .....	63

### Summary of measurement results

No.	Test Case	Clause in FCC rules	Verdict
1	RF power output	2.1046	PASS
2	Effective Isotropic Radiated power	24.232(c)	PASS
3	Occupied Bandwidth	2.1049	PASS
4	Band Edge Compliance	2.1051 /24.238(a)	PASS
5	Peak-to-Average Power Ratio	24.232/KDB 971168 D01(5.7)	PASS
6	Frequency Stability	2.1055 / 24.235	PASS
7	Spurious Emissions at Antenna Terminals	2.1051 / 24.238(a)	PASS
8	Radiates Spurious Emission	2.1053 / 24.238(a)	PASS
Date of Testing: May 25, 2018 ~ June 27, 2018 and July 7, 2020			
Note: PASS: The EUT complies with the essential requirements in the standard. FAIL: The EUT does not comply with the essential requirements in the standard.			

**EG91-NAXD (Report No.: R2006A0379-R6) is a variant model of EG91-NAX (Report No.: R1907A0406-R6). Test values partial duplicated from Original for variant. There is only tested Frequency Stability for variant in this report. The detailed product change description please refers to the *Statement letter\_EG91-NAX&EG91-NAXD*.**

**EG91-NAX (Report No.: R1907A0406-R6) is a variant of the EG91-NA (Report No.: R1805A0250-R2). Test values duplicated from Original for variant. There is no test for variant in this report.**



## 1. Test Laboratory

### 1.1. Notes of the test report

This report shall not be reproduced in full or partial, without the written approval of **TA technology (shanghai) co., Ltd.** The results documented in this report apply only to the tested sample, under the conditions and modes of operation as described herein. Measurement Uncertainties were not taken into account and are published for informational purposes only. This report is written to support regulatory compliance of the applicable standards stated above.

### 1.2. Test facility

#### **FCC (Designation number: CN1179, Test Firm Registration Number: 446626)**

TA Technology (Shanghai) Co., Ltd. has been listed on the US Federal Communications Commission list of test facilities recognized to perform electromagnetic emissions measurements.

#### **A2LA (Certificate Number: 3857.01)**

TA Technology (Shanghai) Co., Ltd. has been listed by American Association for Laboratory Accreditation to perform electromagnetic emission measurement.

### 1.3. Testing Location

Company: TA Technology (Shanghai) Co., Ltd.  
Address: No.145, Jintang Rd, Tangzhen Industry Park, Pudong  
City: Shanghai  
Post code: 201201  
Country: P. R. China  
Contact: Xu Kai  
Telephone: +86-021-50791141/2/3  
Fax: +86-021-50791141/2/3-8000  
Website: <http://www.ta-shanghai.com>  
E-mail: [xukai@ta-shanghai.com](mailto:xukai@ta-shanghai.com)

## 2. General Description of Equipment under Test

### 2.1. Applicant and Manufacturer Information

Applicant	Quectel Wireless Solutions Co., Ltd
Applicant address	Building 5, Shanghai Business Park Phase III (Area B), No.1016 Tianlin Road, Minhang District, Shanghai, China 200233
Manufacturer	Quectel Wireless Solutions Co., Ltd
Manufacturer address	Building 5, Shanghai Business Park Phase III (Area B), No.1016 Tianlin Road, Minhang District, Shanghai, China 200233

### 2.2. General information

EUT Description			
Model	EG91-NAXD		
IMEI	863071010199125		
Hardware Version	R1.0		
Software Version	EG91NAXDGAR07A01M1G		
Power Supply	External Power Supply		
Antenna Type	The EUT don't have standard Antenna, The Antenna used for testing in this report is the after-market accessory (Dipole Antenna)		
Antenna Gain	Frequency(MHz)	Gain(dBi)	
	1860	1.25	
	1880	1.38	
	1900	1.59	
Test Mode(s)	WCDMA Band II; LTE Band 2;		
Test Modulation	(WCDMA) BPSK, QPSK; (LTE)QPSK,16QAM		
HSDPA UE Category	24		
HSUPA UE Category	6		
DC-HSDPA UE Category	24		
LTE Category	1		
Maximum E.I.R.P	WCDMA Band II:	25.56dBm	
	LTE Band 2:	26.29dBm	
Rated Power Supply Voltage	3.8V		
Extreme Voltage	Minimum: 3.3V Maximum: 4.3V		
Extreme Temperature	Lowest: -40°C Highest: +85°C		
Operating Frequency Range(s)	Band	Tx (MHz)	Rx (MHz)
	WCDMA Band II	1850 ~ 1910	1930 ~ 1990
	LTE Band 2	1850 ~ 1910	1930 ~ 1990



Note: 1. The EUT is sent from the applicant to TA and the information of the EUT is declared by the applicant.  
2. For LTE, 16QAM only supports 25%RB.

### 3. Applied Standards

According to the specifications of the manufacturer, it must comply with the requirements of the following standards:

**Test standards:**

**FCC CFR 47 Part 24E (2019)**

**ANSI C63.26 (2015)**

**Reference standard:**

**FCC CFR47 Part 2 (2019)**

**KDB 971168 D01 Power Meas License Digital Systems v03r01**

## 4. Test Configuration

Radiated measurements are performed by rotating the EUT in three different orthogonal test planes. EUT stand-up position (Z axis), lie-down position (X, Y axis). Receiver antenna polarization (horizontal and vertical), the worst emission was found in position (Z axis, horizontal polarization) and the worst case was recorded.

All mode and data rates and positions and RB size and modulations were investigated. Subsequently, only the worst case emissions are reported.

The following testing in WCDMA/LTE is set based on the maximum RF Output Power.

Test modes are chosen to be reported as the worst case configuration below:

	Test items	Modes/Modulation
		WCDMA Band II
Conducted Test cases	RF power output	RMC HSDPA/HSUPA DC-HSDPA
	Occupied Bandwidth	RMC
	Band Edge Compliance	RMC
	Peak-to-Average Power Ratio	RMC
	Frequency Stability	RMC
	Spurious Emissions at Antenna Terminals	RMC
Radiated Test cases	Effective Isotropic Radiated power	RMC
	Radiates Spurious Emission	RMC



Test modes are chosen to be reported as the worst case configuration below for LTE Band 2:

Test items	Bandwidth (MHz)						Modulation		RB			Test Channel		
	1.4	3	5	10	15	20	QPSK	16QAM	1	50%	100%	L	M	H
RF power output	O	O	O	O	O	O	O	O	O	O	O	O	O	O
Effective Isotropic Radiated power	O	O	O	O	O	O	O	O	O	O	O	O	O	O
Occupied Bandwidth	O	O	O	O	O	O	O	O	O	-	O	O	O	O
Band Edge Compliance	O	O	O	O	O	O	O	O	O	-	O	O	-	O
Peak-to-Average Power Ratio	O	O	O	O	O	O	O	O	O	-	O	O	O	O
Frequency Stability	-	-	-	-	-	O	O	O	-	-	O	O	O	O
Conducted Spurious Emissions	O	O	O	O	O	O	O	-	O	-	-	O	O	O
Radiates Spurious Emission	O	-	O	-	-	O	O	-	O	-	-	O	O	O
Note	1. The mark "O" means that this configuration is chosen for testing. 2. The mark "-" means that this configuration is not testing. 3. For LTE, 16QAM only supports 25%RB.													

## 5. Test Case Results

### 5.3.RF Power Output

#### Ambient condition

Temperature	Relative humidity	Pressure
23°C ~25°C	45%~50%	101.5kPa

#### Methods of Measurement

During the process of the testing, The EUT is controlled by the Base Station Simulator to ensure max power transmission and proper modulation.

#### Test Setup

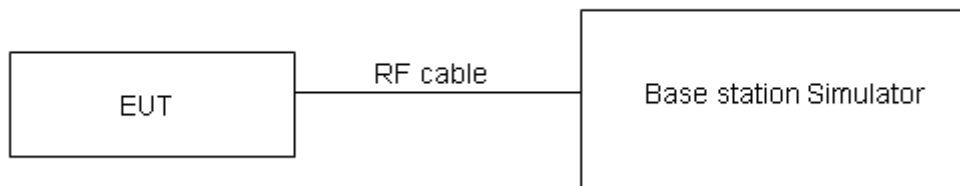

The loss between RF output port of the EUT and the input port of the tester has been taken into consideration.

#### Limits

No specific RF power output requirements in part 2.1046.

#### Measurement Uncertainty

The assessed measurement uncertainty to ensure 95% confidence level for the normal distribution is with the coverage factor  $k = 2$ ,  $U = 0.4$  dB.



## Test Results

WCDMA Band II		Conducted Power(dBm)		
		Channel 9262	Channel 9400	Channel 9538
		1852.4(MHz)	1880(MHz)	1907.6(MHz)
RMC	12.2k	23.38	23.33	23.18
	64k	23.32	23.21	23.02
	144k	23.23	23.16	23.01
	384k	23.22	23.17	23.02
HSDPA	Sub - Test 1	22.36	22.37	22.35
	Sub - Test 2	22.39	22.37	22.30
	Sub - Test 3	21.86	21.87	21.80
	Sub - Test 4	21.90	21.81	21.80
HSUPA	Sub - Test 1	22.40	22.39	22.30
	Sub - Test 2	21.90	21.88	21.82
	Sub - Test 3	22.43	22.38	22.34
	Sub - Test 4	22.48	22.34	22.32
	Sub - Test 5	22.32	22.21	22.18
DC-HSDPA	Sub - Test 1	23.31	23.22	23.07
	Sub - Test 2	23.30	23.21	23.06
	Sub - Test 3	22.79	22.70	22.55
	Sub - Test 4	22.78	22.79	22.53



LTE Band 2				Conducted Power(dBm)		
Bandwidth	Modulation	RB size	RB offset	Channel/Frequency (MHz)		
				18607/1850.7	18900/1880	19193/1909.3
1.4MHz	QPSK	1	0	23.90	23.76	23.58
		1	2	24.19	23.97	23.68
		1	5	24.22	23.89	23.78
		3	0	23.86	23.87	23.81
		3	2	23.96	23.65	23.86
		3	3	24.12	23.89	23.67
	16QAM	1	0	22.98	22.88	22.84
		1	0	22.89	22.67	23.09
		1	2	23.05	22.96	23.17
		1	5	22.95	22.85	22.95
Bandwidth	Modulation	RB size	RB offset	Channel/Frequency (MHz)		
				18615/1851.5	18900/1880	19185/1908.5
3MHz	QPSK	1	0	23.98	23.77	23.64
		1	7	24.13	23.84	24.43
		1	14	23.82	23.58	23.52
		8	0	22.96	22.95	22.74
		8	4	22.90	22.82	22.94
		8	7	22.87	22.88	22.89
	16QAM	15	0	22.82	22.89	22.98
		1	0	23.17	22.99	23.43
		1	7	23.76	22.88	24.14
		1	14	23.09	22.90	23.32
Bandwidth	Modulation	RB size	RB offset	Channel/Frequency (MHz)		
				18625/1852.5	18900/1880	19175/1907.5
5MHz	QPSK	1	0	23.95	23.75	23.60
		1	13	24.11	23.80	24.40
		1	24	23.79	23.53	23.48
		12	0	22.93	22.90	22.70
		12	6	22.88	22.78	22.89
		12	13	22.85	22.86	22.85
	16QAM	25	0	22.80	22.88	22.96
		1	0	23.14	22.95	23.40
		1	13	23.73	22.86	24.11
		1	24	23.06	22.88	23.28
Bandwidth	Modulation	RB size	RB offset	Channel/Frequency (MHz)		
				18650/1855	18900/1880	19150/1905



10MHz	QPSK	1	0	23.97	23.76	23.63
		1	25	24.14	23.85	24.44
		1	49	23.81	23.57	23.51
		25	0	22.96	22.95	22.74
		25	13	22.91	22.83	22.93
		25	25	22.87	22.90	22.90
		50	0	22.88	22.90	23.00
	16QAM	1	0	23.16	22.98	23.42
		1	25	23.76	22.90	24.14
1		49	23.09	22.90	23.31	
Bandwidth	Modulation	RB size	RB offset	Channel/Frequency (MHz)		
				18675/1857.5	18900/1880	19125/1902.5
15MHz	QPSK	1	0	23.96	23.72	23.61
		1	38	24.12	23.84	24.41
		1	74	23.78	23.52	23.47
		36	0	22.94	22.91	22.71
		36	18	22.88	22.78	22.89
		36	39	22.84	22.87	22.86
		75	0	22.86	22.86	22.95
	16QAM	1	0	23.11	22.96	23.40
		1	38	23.74	22.87	24.12
1		74	23.06	22.86	23.28	
Bandwidth	Modulation	RB size	RB offset	Channel/Frequency (MHz)		
				18700/1860	18900/1880	19100/1900
20MHz	QPSK	1	0	23.93	23.68	23.58
		1	50	24.11	23.80	24.39
		1	99	23.76	23.51	23.44
		50	0	22.91	22.86	22.67
		50	25	22.86	22.74	22.86
		50	50	22.81	22.82	22.82
		100	0	22.83	22.81	22.91
	16QAM	1	0	23.09	22.92	23.35
		1	50	23.70	22.85	24.08
1		99	23.04	22.83	23.26	

## 5.4. Effective Isotropic Radiated Power

### Ambient condition

Temperature	Relative humidity	Pressure
23°C ~25°C	45%~50%	101.5kPa

### Methods of Measurement

The testing follows FCC KDB 971168 v03r01 Section 5.8 and ANSI/TIA-603-E (2016).

- Connect the equipment as illustrated. Mount the equipment with the manufacturer specified antenna in a vertical orientation on a manufacturer specified mounting surface located on a non-conducting rotating platform of a RF anechoic chamber (preferred) or a standard radiation site.
- Key the transmitter, then rotate the EUT 360° azimuthally and record spectrum analyzer power level (LVL) measurements at angular increments that are sufficiently small to permit resolution of all peaks. If a standard radiation test site is used, raise and lower the test antenna to obtain a maximum reading at each angular increment. (Note: several batteries may be needed to offset the effect of battery voltage droop, which should not exceed 5% of the manufactured specified battery voltage during transmission).
- Replace the transmitter under test with a vertically polarized half-wave dipole (or an antenna whose gain is known relative to an ideal half-wave dipole). The center of the antenna should be at the same location as the center of the antenna under test.
- Connect the antenna to a signal generator with a known output power and record the path loss (in dB) as LOSS. If a standard radiation test site is used, raise and lower the test antenna to obtain a maximum reading.  $LOSS = \text{Generator Output Power (dBm)} - \text{Analyzer reading (dBm)}$
- Determine the effective radiated output power at each angular position from the readings in steps b) and d) using the following equation:  $ERP \text{ (dBm)} = \text{LVL (dBm)} + \text{LOSS (dB)}$
- The maximum ERP is the maximum value determined in the preceding step.
- When calculating ERP, in addition to knowing the antenna radiation and matching characteristics, it is necessary to know the loss values of all elements (e.g. transmission line attenuation, mismatches, filters, combiners) interposed between the point where transmitter output power is measured, and the point where power is applied to the antenna. ERP can then be calculated as follows:  
 $ERP \text{ (dBm)} = \text{Output Power (dBm)} - \text{Losses (dB)} + \text{Antenna Gain (dBd)}$   
where: dBd refers to gain relative to an ideal dipole.  
 $EIRP \text{ (dBm)} = ERP \text{ (dBm)} + 2.15 \text{ (dB.)}$

The RB allocation refers to section 5.1, using the maximum output power configuration.

**Test setup**

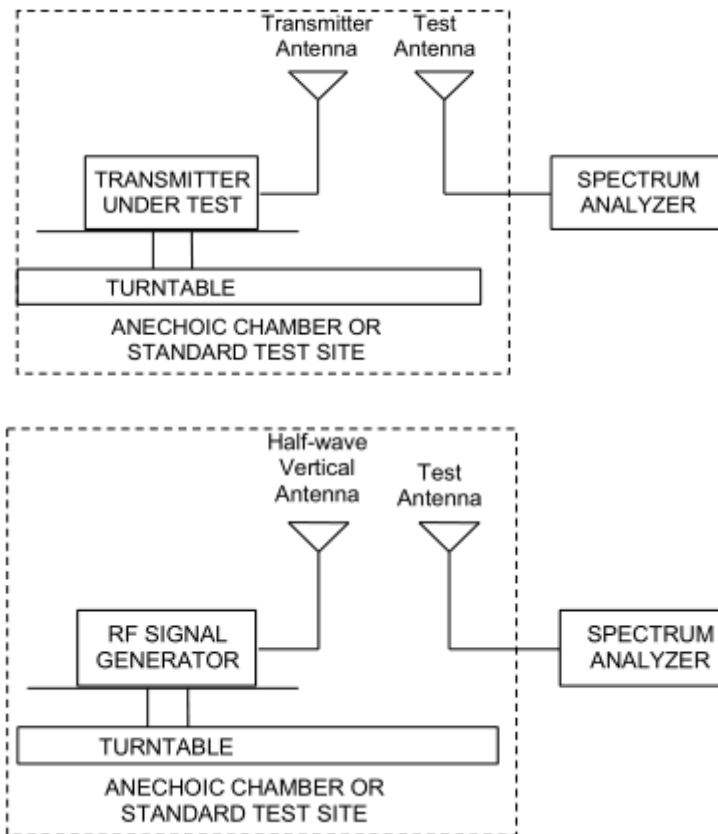

**Limits**

Rule Part 24.232(c) Mobile and portable stations are limited to 2 watts EIRP.

Rule Part 24.232(e) Peak transmit power must be measured over any interval of continuous transmission using instrumentation calibrated in terms of an rms-equivalent voltage.

Limit	$\leq 2 \text{ W}$ (33 dBm)
-------	-----------------------------

**Measurement Uncertainty**

The assessed measurement uncertainty to ensure 95% confidence level for the normal distribution is with the coverage factor  $k = 2$ ,  $U = 1.19 \text{ dB}$

**Test Results:**

The measurement is performed for both of horizontal and vertical antenna Polarization, and only the data of worst mode is recorded in this report.

Mode	Channel	Frequency (MHz)	Polarization	EIRP (dBm)	Limit (dBm)	Conclusion
WCDMA Band II	Low	1852.4	Horizontal	24.95	33	Pass
	Middle	1880	Horizontal	25.56	33	Pass
	High	1907.6	Horizontal	25.48	33	Pass

LTE Band 2						
bandwidth	Channel	Frequency (MHz)	Polarization	EIRP (dBm)	Limit (dBm)	Conclusion
1.4 MHz (QPSK)	Low	1850.7	Horizontal	25.62	33	Pass
	Middle	1880	Horizontal	25.87	33	Pass
	High	1909.3	Horizontal	25.89	33	Pass
3 MHz (QPSK)	Low	1851.5	Horizontal	25.95	33	Pass
	Middle	1880	Horizontal	26.14	33	Pass
	High	1908.5	Horizontal	26.29	33	Pass
5 MHz (QPSK)	Low	1852.5	Horizontal	25.68	33	Pass
	Middle	1880	Horizontal	26.22	33	Pass
	High	1907.5	Horizontal	26.23	33	Pass
10 MHz (QPSK)	Low	1855	Horizontal	25.54	33	Pass
	Middle	1880	Horizontal	25.60	33	Pass
	High	1905	Horizontal	25.50	33	Pass
15 MHz (QPSK)	Low	1857.5	Horizontal	25.34	33	Pass
	Middle	1880	Horizontal	25.59	33	Pass
	High	1902.5	Horizontal	25.79	33	Pass
20 MHz (QPSK)	Low	1860	Horizontal	25.78	33	Pass
	Middle	1880	Horizontal	25.89	33	Pass
	High	1900	Horizontal	26.03	33	Pass
1.4 MHz (16QAM)	Low	1850.7	Horizontal	25.31	33	Pass
	Middle	1880	Horizontal	25.47	33	Pass
	High	1909.3	Horizontal	25.51	33	Pass
3 MHz (16QAM)	Low	1851.5	Horizontal	25.56	33	Pass
	Middle	1880	Horizontal	25.79	33	Pass
	High	1908.5	Horizontal	25.92	33	Pass
5 MHz (16QAM)	Low	1852.5	Horizontal	25.34	33	Pass
	Middle	1880	Horizontal	25.89	33	Pass
	High	1907.5	Horizontal	25.69	33	Pass
10 MHz (16QAM)	Low	1855	Horizontal	25.32	33	Pass
	Middle	1880	Horizontal	25.29	33	Pass





LTE Band 2						
bandwidth	Channel	Frequency (MHz)	Polarization	EIRP (dBm)	Limit (dBm)	Conclusion
15 MHz (16QAM)	High	1905	Horizontal	25.19	33	Pass
	Low	1857.5	Horizontal	25.05	33	Pass
	Middle	1880	Horizontal	25.12	33	Pass
	High	1902.5	Horizontal	25.19	33	Pass
20 MHz (16QAM)	Low	1860	Horizontal	25.47	33	Pass
	Middle	1880	Horizontal	25.88	33	Pass
	High	1900	Horizontal	25.87	33	Pass

## 5.5.Occupied Bandwidth

### Ambient condition

Temperature	Relative humidity	Pressure
23°C ~25°C	45%~50%	101.5kPa

### Method of Measurement

The EUT was connected to Spectrum Analyzer and Base Station Simulator via power Splitter. The occupied bandwidth is measured using spectrum analyzer.

RBW is set to 51kHz, VBW is set to 160kHz for WCDMA Band II,

RBW is set to 51kHz, VBW is set to 160kHz for LTE Band 2(1.4MHz),

RBW is set to 100kHz,VBW is set to 300kHz for LTE Band 2(3MHz/5MHz),

RBW is set to 300kHz,VBW is set to 1MHz for LTE Band 2(10MHz/15MHz/20MHz).

99% power and -26dBc occupied bandwidths are recorded. Spectrum analyzer plots are included on the following pages.

### Test Setup

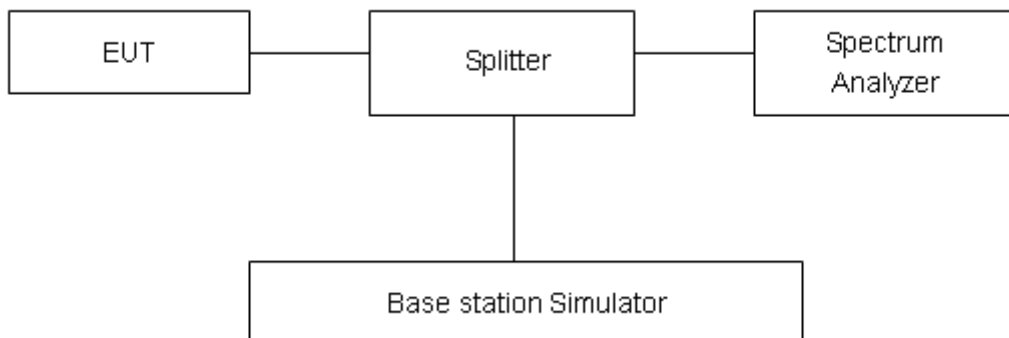

### Limits

No specific occupied bandwidth requirements in part 2.1049.

### Measurement Uncertainty

The assessed measurement uncertainty to ensure 95% confidence level for the normal distribution is with the coverage factor  $k = 2$ ,  $U = 624\text{Hz}$ .



## Test Result

Mode	Channel	Frequency (MHz)	99% Power Bandwidth (MHz)	-26dBc Bandwidth(MHz)
WCDMA Band II (RMC)	9262	1852.4	4.1242	4.675
	9400	1880	4.1211	4.676
	9538	1907.6	4.1201	4.673

LTE Band 2						
Modulation	Bandwidth (MHz)	Channel	Frequency (MHz)	99% Power Bandwidth(MHz)	-26dBc Bandwidth(MHz)	
QPSK	1.4	18607	1850.7	1.1257	1.3450	
		18900	1880.0	1.1328	1.3440	
		19193	1909.3	1.1144	1.3380	
	3	18615	1851.5	2.7424	3.0600	
		18900	1880	2.7347	3.0530	
		19185	1908.5	2.7321	3.0530	
	5	18625	1852.5	4.5299	5.0310	
		18900	1880	4.5307	5.0310	
		19175	1907.5	4.5335	5.0630	
	10	18650	1855	9.0476	10.0100	
		18900	1880	9.0180	9.9160	
		19150	1905	9.0078	9.9850	
	15	18675	1857.5	13.4420	14.7200	
		18900	1880	13.4500	14.6800	
		19125	1902.5	13.4090	14.5700	
	20	18700	1860	17.8420	19.1800	
		18900	1880	17.8690	19.1400	
		19100	1900	17.8360	19.1900	
	16QAM	1.4	18607	1850.7	0.3327	0.4677
			18900	1880.0	0.3270	0.4657
			19193	1909.3	0.3159	0.4742
3		18615	1851.5	0.4106	0.5634	
		18900	1880	0.4071	0.5594	



		19185	1908.5	0.4095	0.5682
5		18625	1852.5	0.4905	0.6986
		18900	1880	0.4973	0.7215
		19175	1907.5	0.4732	0.6778
10		18650	1855	0.9149	1.2710
		18900	1880	0.8973	1.2150
		19150	1905	0.8933	1.1940
15		18675	1857.5	1.1602	1.6300
		18900	1880	1.1659	1.6020
		19125	1902.5	1.1132	1.5630
20		18700	1860	1.2621	1.7960
		18900	1880	1.2355	1.7650
		19100	1900	1.2209	1.7690

WCDMA Band II RMC CH-LOW

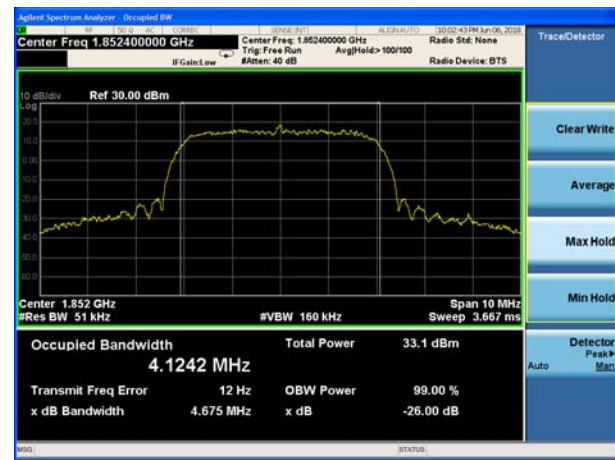

WCDMA Band II RMC CH-Middle



WCDMA Band II RMC CH-High

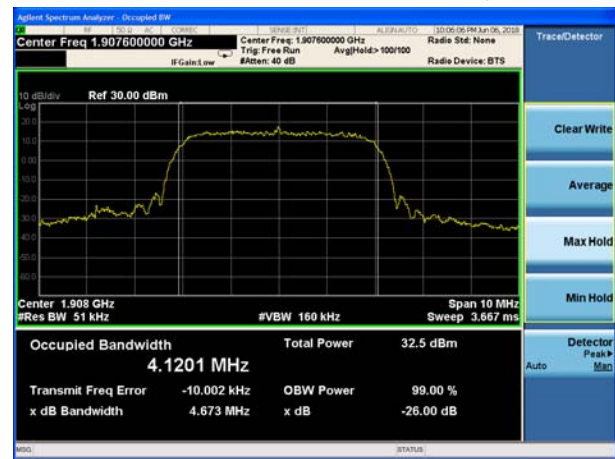



LTE Band 2 1.4MHz QPSK CH-Low

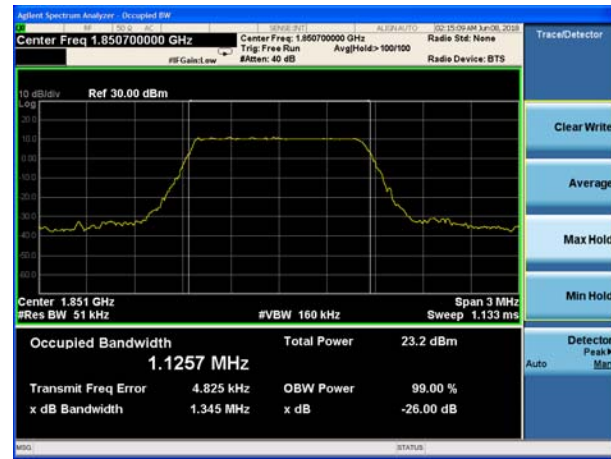

LTE Band 2 3MHz QPSK CH-Low

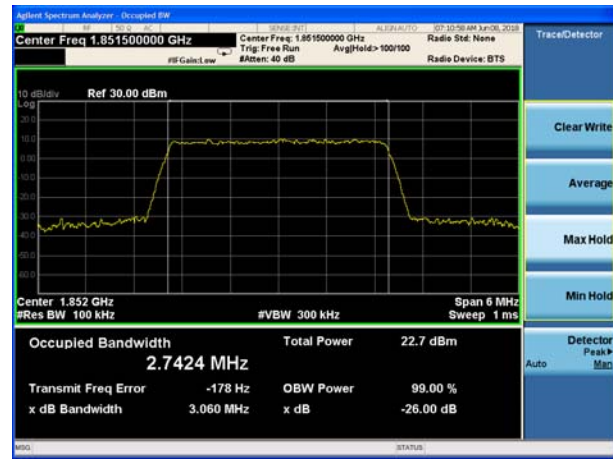

LTE Band 2 1.4MHz QPSK CH-Middle

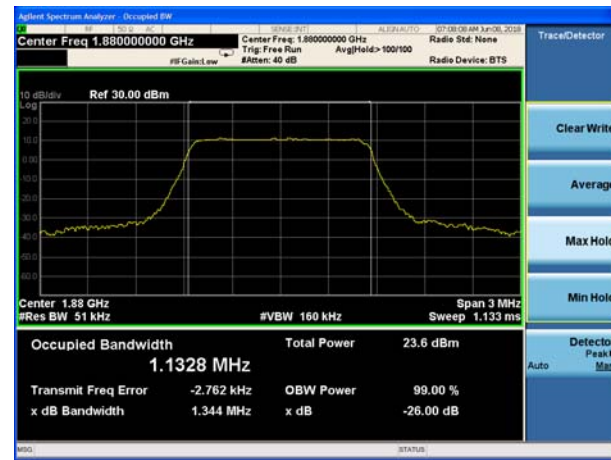

LTE Band 2 3MHz QPSK CH-Middle

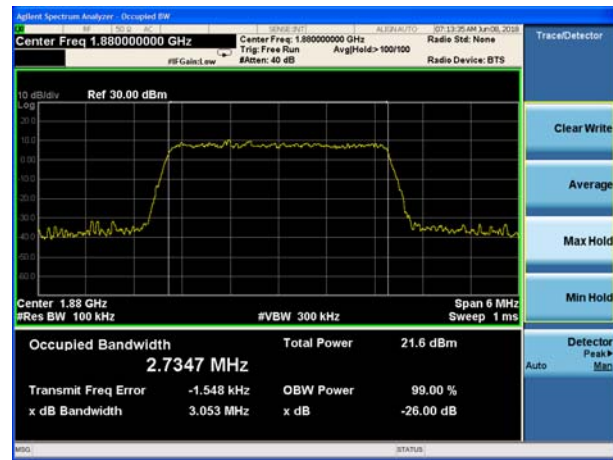

LTE Band 2 1.4MHz QPSK CH-High

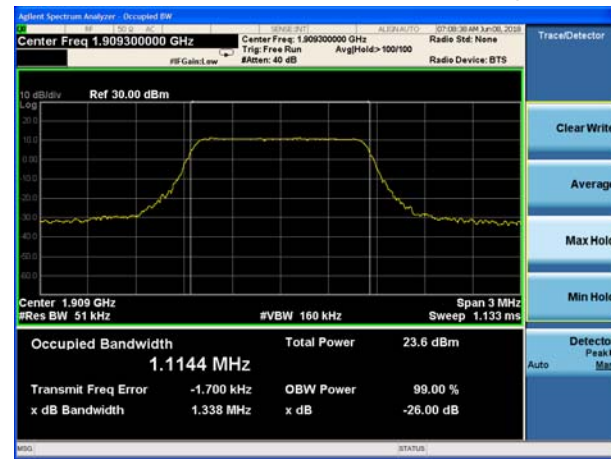

LTE Band 2 3MHz QPSK CH-High



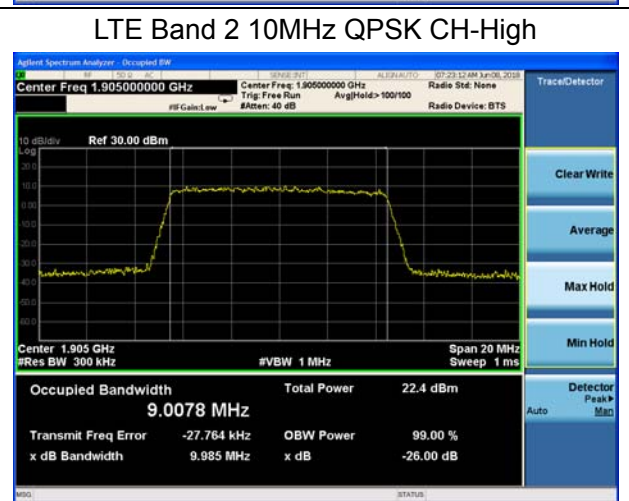
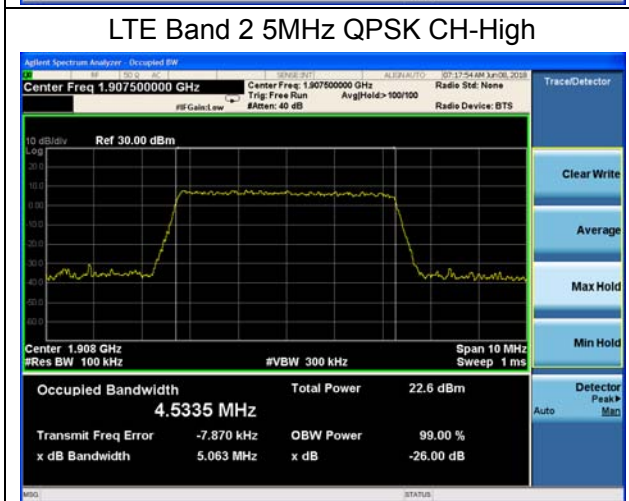
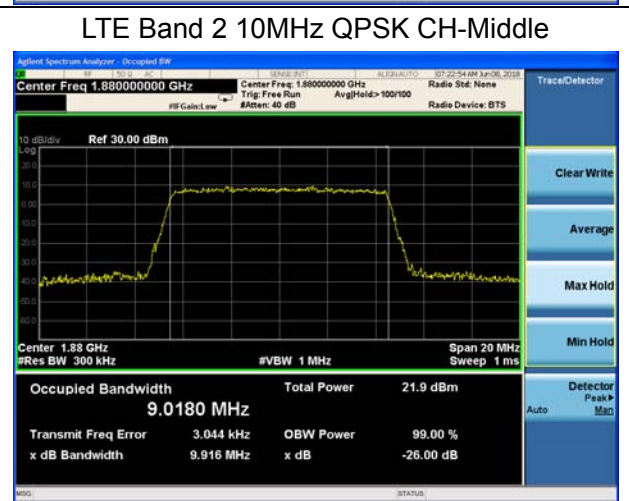
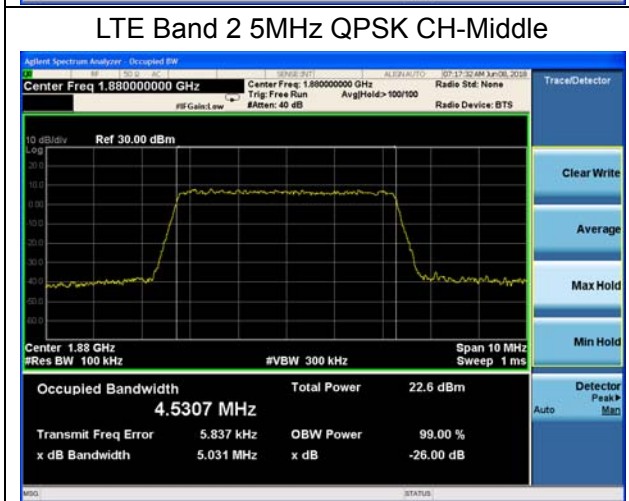
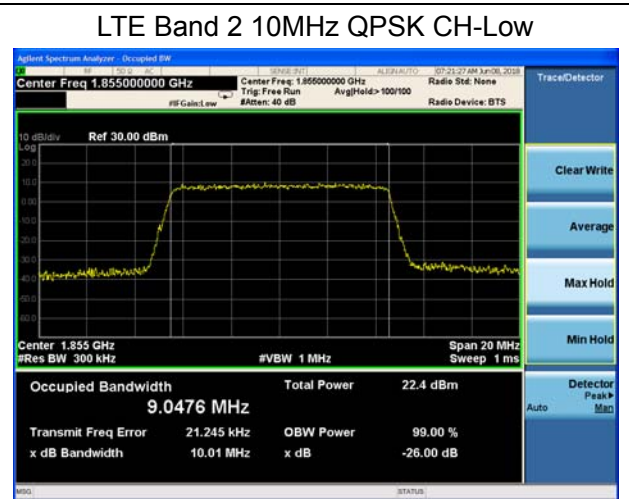
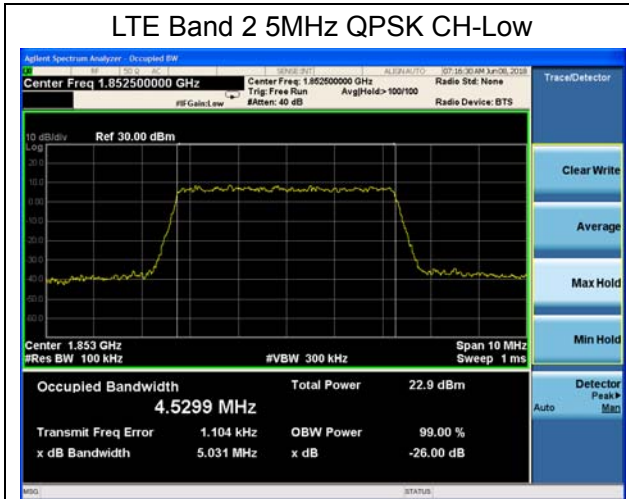

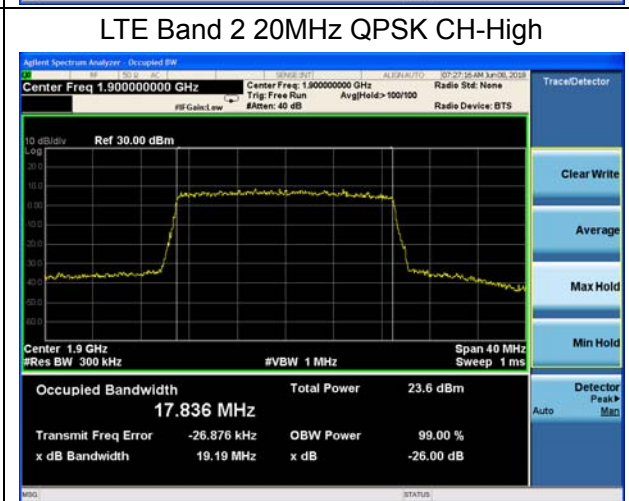
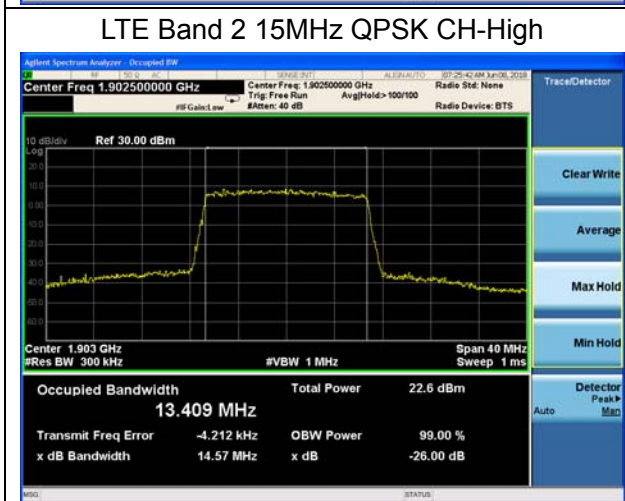
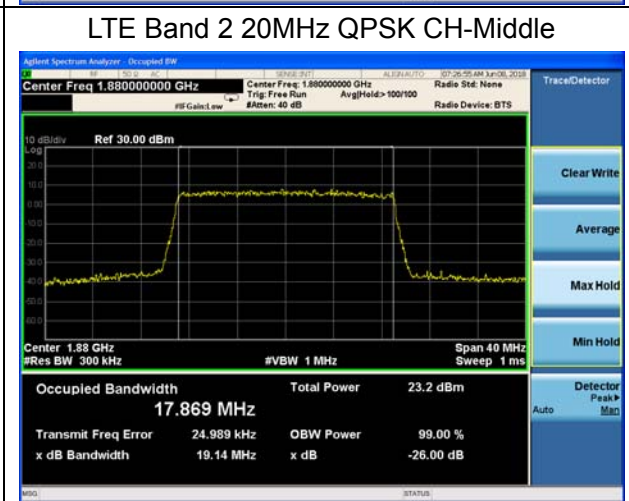
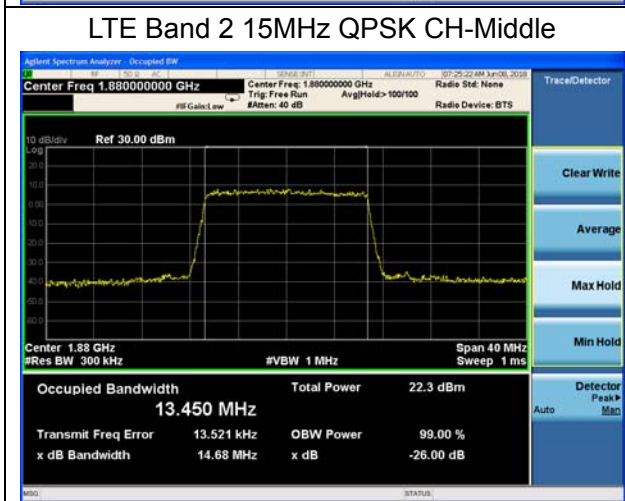
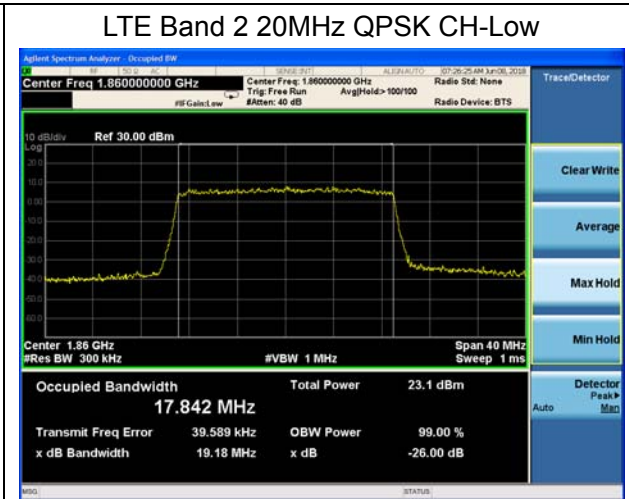
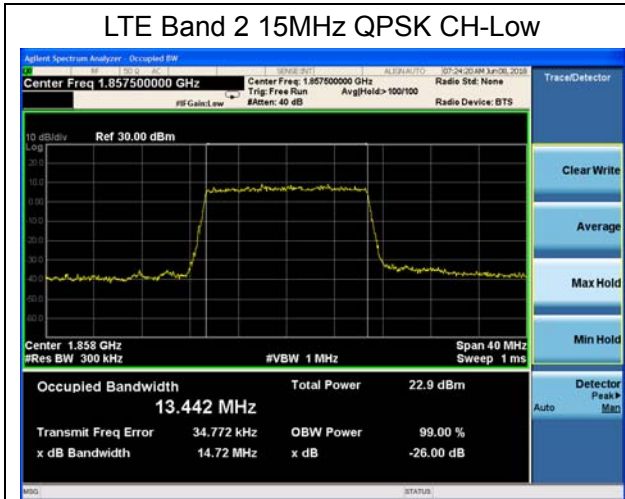

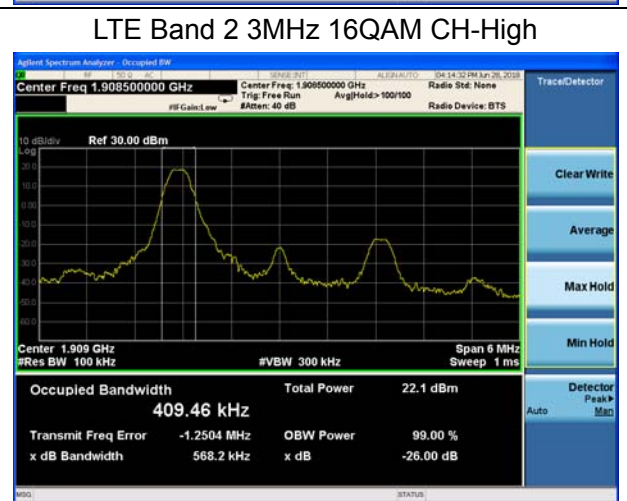
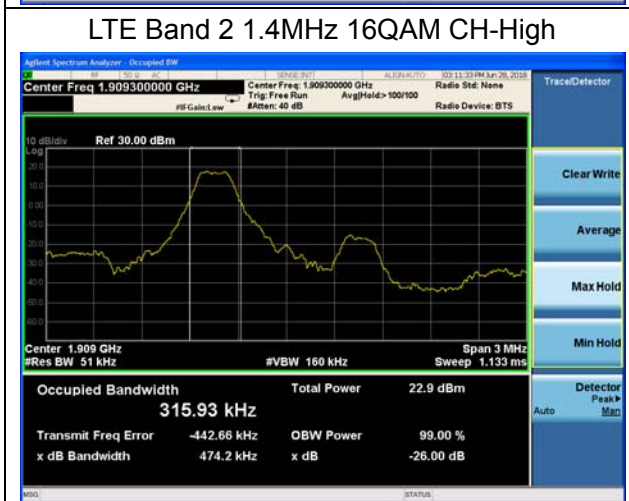
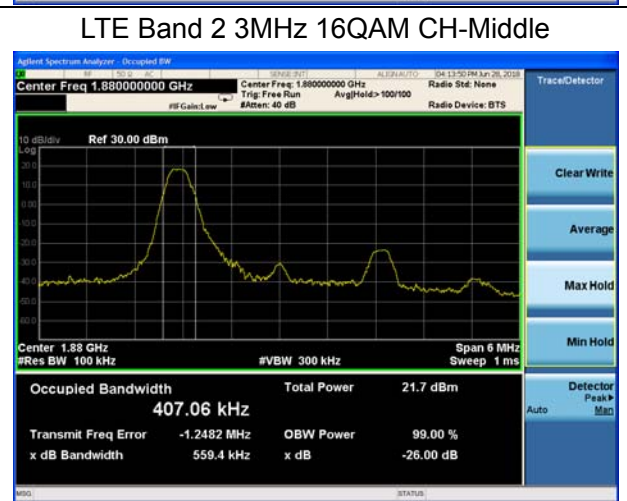
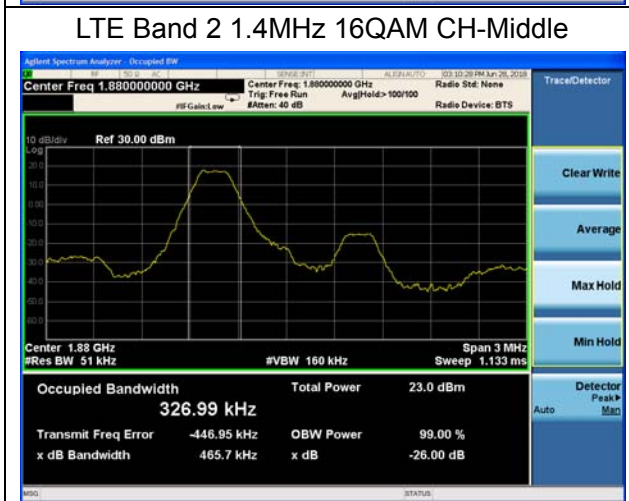
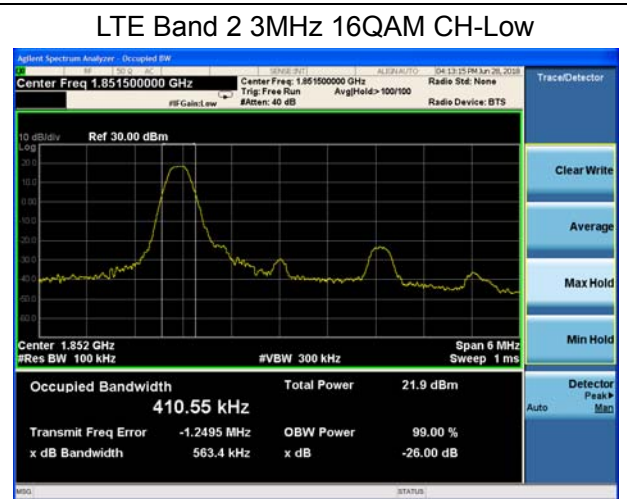
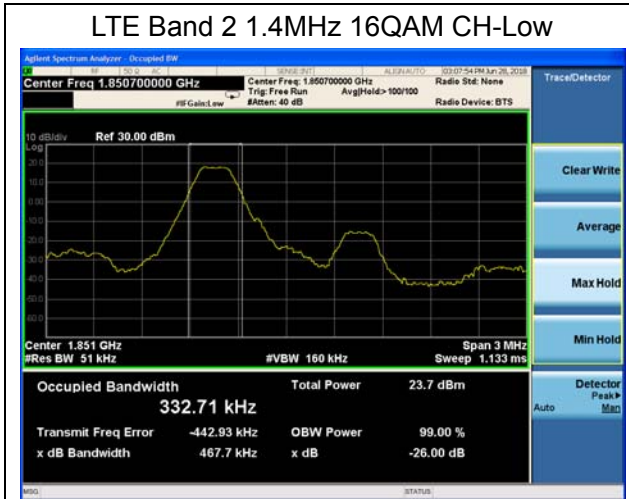



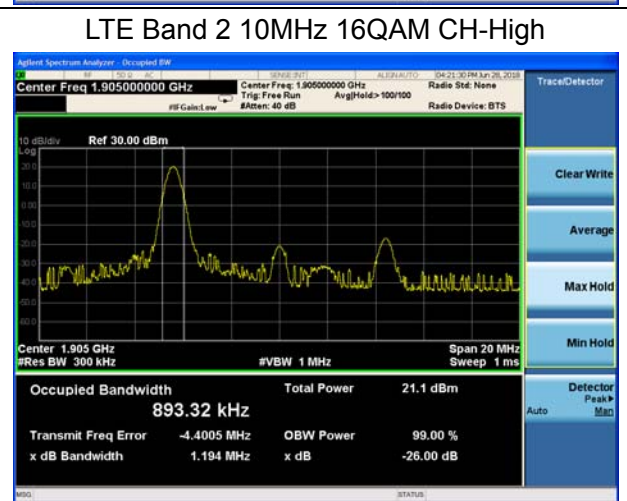
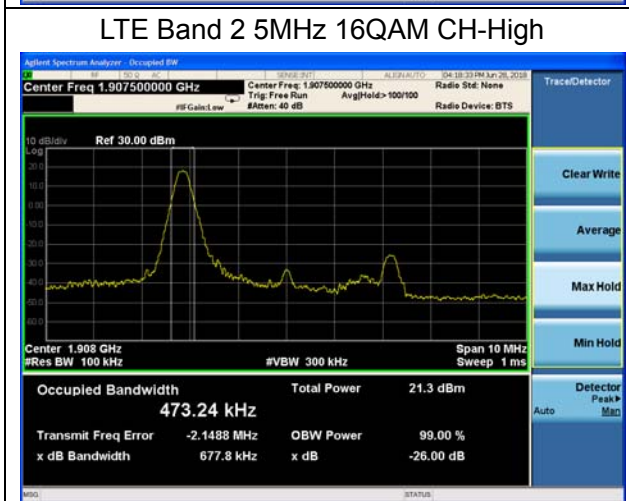
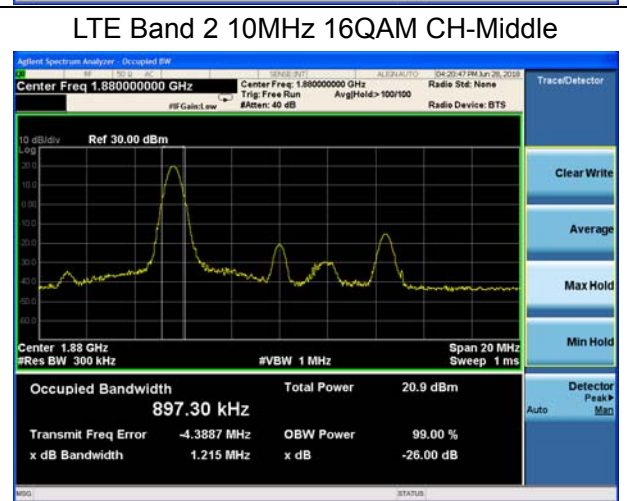
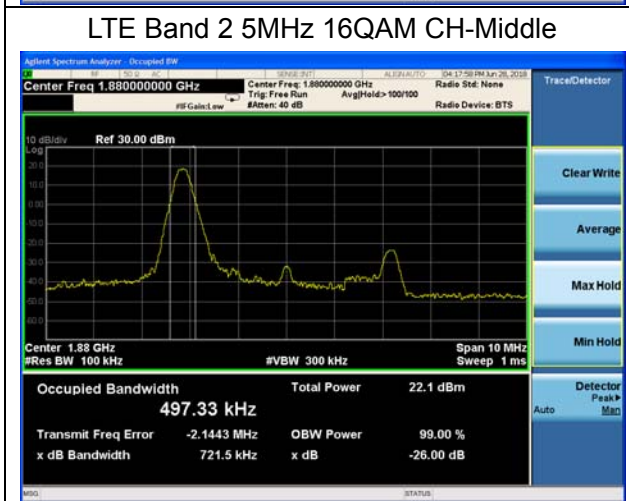
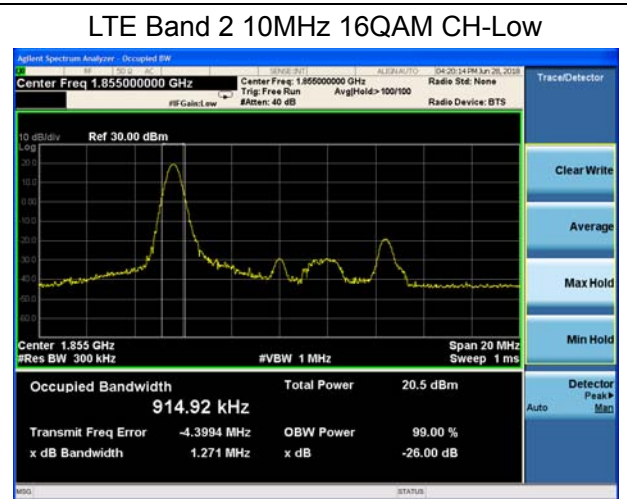
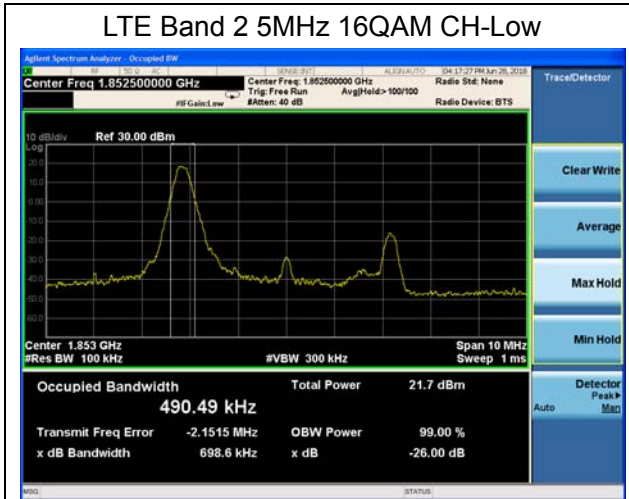

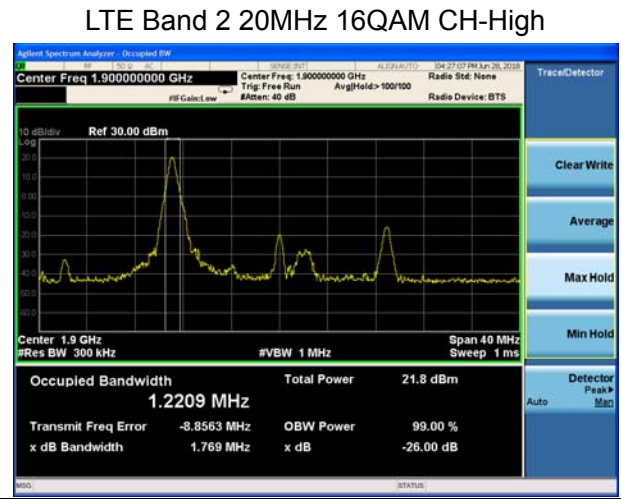
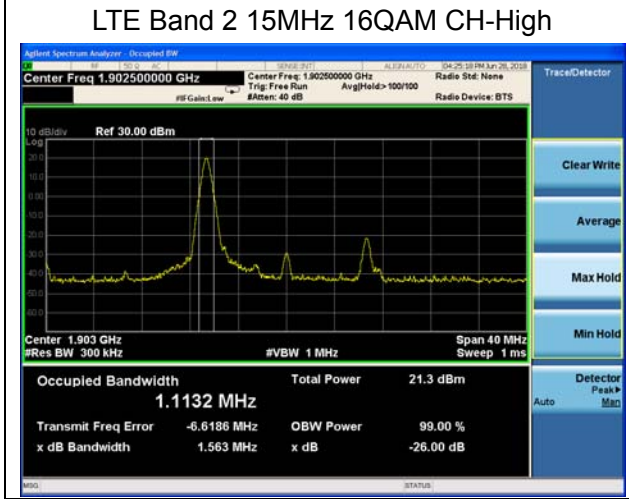
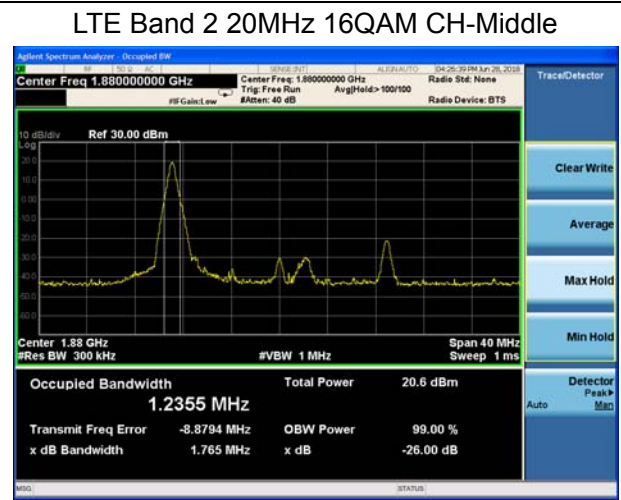
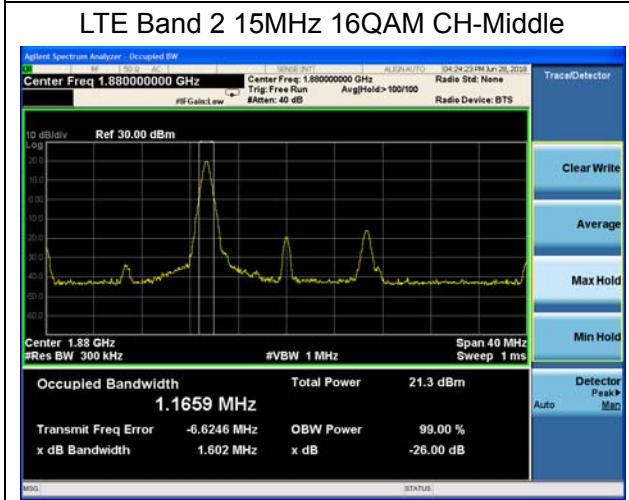
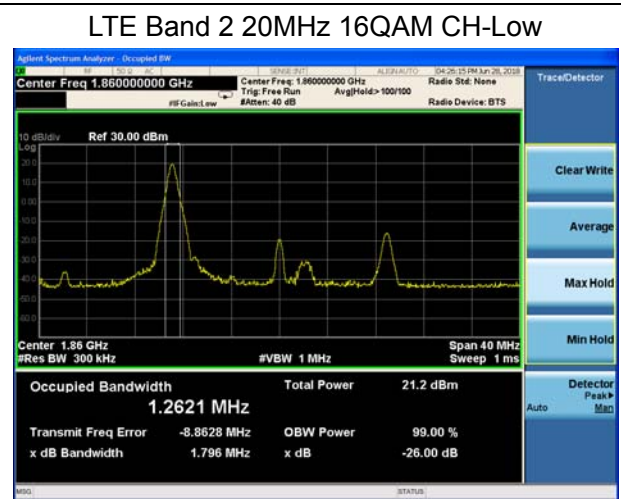
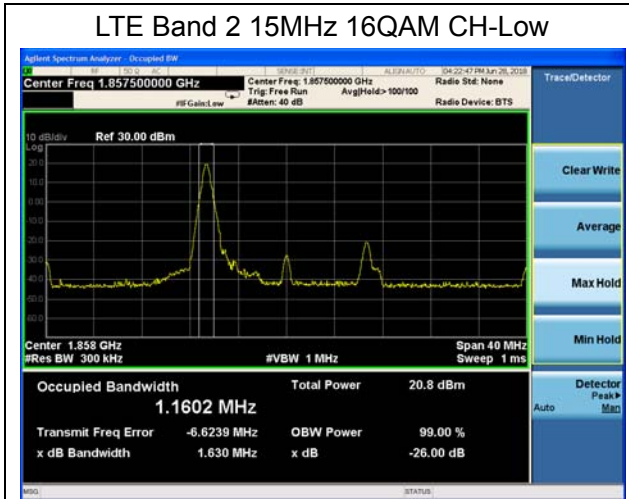

### 5.6. Band Edge Compliance

**Ambient condition**

Temperature	Relative humidity	Pressure
23°C ~25°C	45%~50%	101.5kPa

**Method of Measurement**

The EUT was connected to Spectrum Analyzer and Base Station Simulator via power Splitter. The band edge of the lowest and highest channels were measured. The Average detector is used and RBW is set to 51kHz, VBW is set to 160kHz for WCDMA Band II, RBW is set to 15kHz, VBW is set to 51kHz for LTE Band 2(1.4MHz), RBW is set to 30kHz,VBW is set to 100kHz for LTE Band 2(3MHz), RBW is set to 51kHz,VBW is set to 160kHz for LTE Band 2(5MHz), RBW is set to 100kHz,VBW is set to 300kHz for LTE Band 2(10MHz), RBW is set to 150kHz,VBW is set to 510kHz for LTE Band 2(15MHz), RBW is set to 200kHz,VBW is set to 620kHz for LTE Band 2(20MHz). Spectrum analyzer plots are included on the following pages.

**Test Setup**

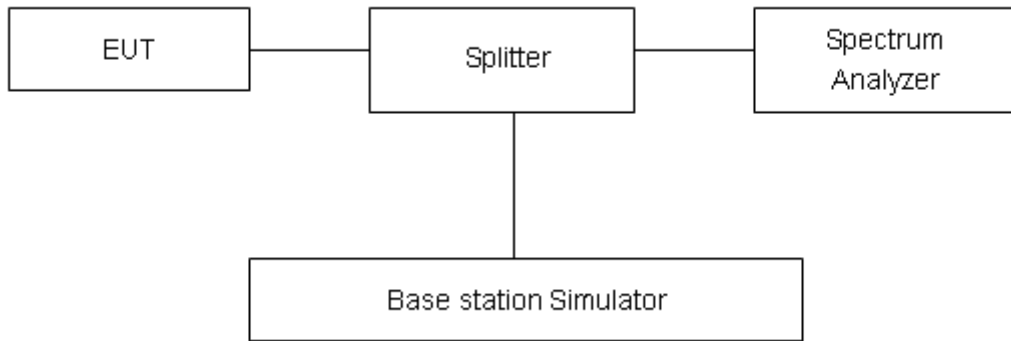

**Limits**

Rule Part 24.238(a) specifies that “on any frequency outside a licensee’s frequency block, the power of any emission shall be attenuated below the transmitter power (P) by at least 43 + 10 log<sub>10</sub> (P) dB.”

Limit	-13 dBm
-------	---------

**Measurement Uncertainty**

The assessed measurement uncertainty to ensure 95% confidence level for the normal distribution is with the coverage factor  $k = 1.96$ ,  $U=0.684$ dB.



Test Result:

WCDMA Band II RMC CH-Low



WCDMA Band II RMC CH-High



LTE Band 2 1.4MHz QPSK 1RB CH-Low

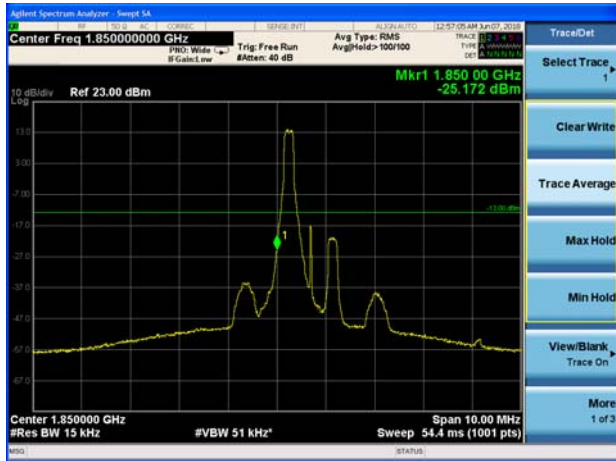

LTE Band 2 1.4MHz QPSK 1RB CH-High



LTE Band 2 1.4MHz QPSK 100%RB CH-Low

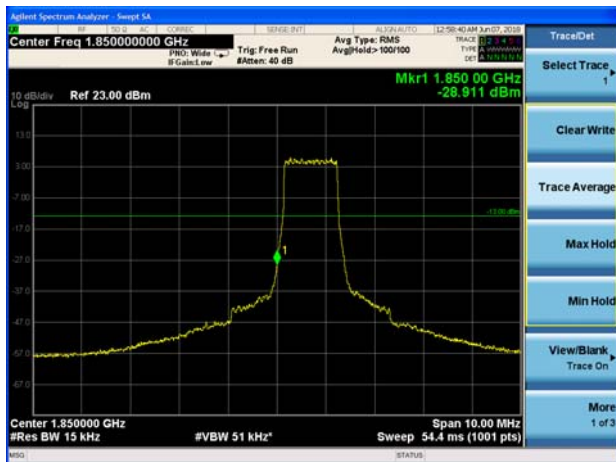

LTE Band 2 1.4MHz QPSK 100%RB CH-High

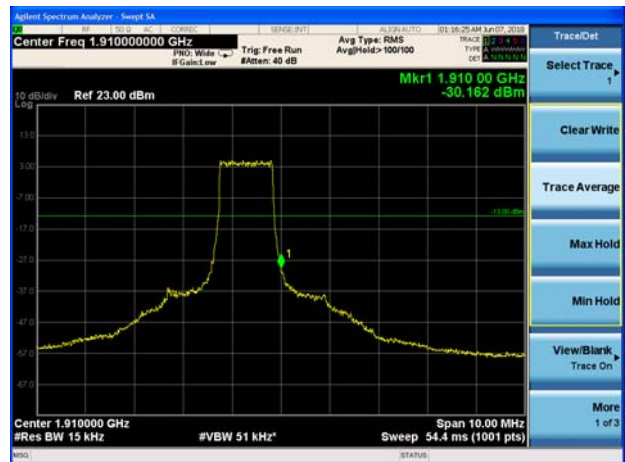

LTE Band 2 3MHz QPSK 1RB CH-Low

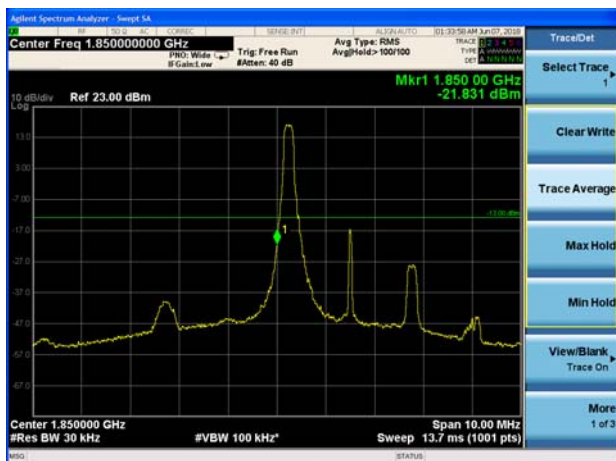

LTE Band 2 3MHz QPSK 1RB CH-High

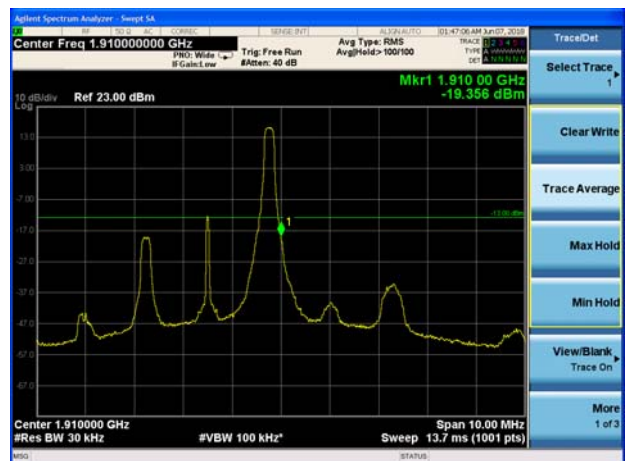



LTE Band 2 3MHz QPSK 100%RB CH-Low

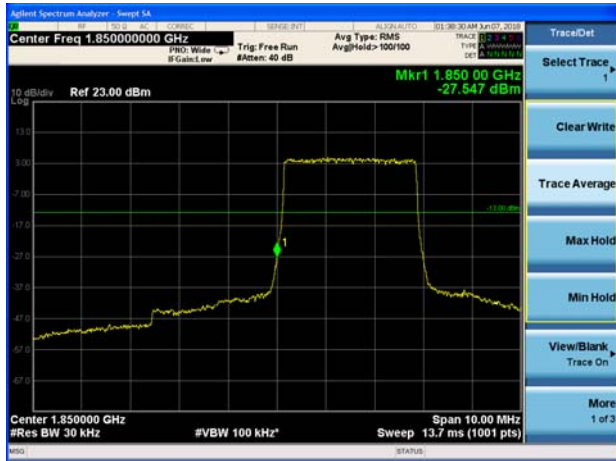

LTE Band 2 3MHz QPSK 100%RB CH-High



LTE Band 2 5MHz QPSK 1RB CH-Low

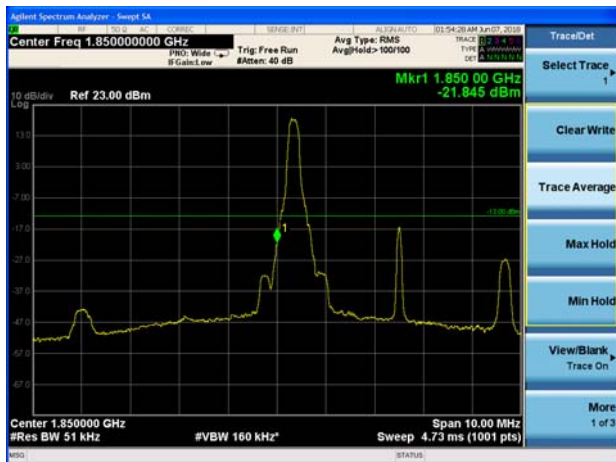

LTE Band 2 5MHz QPSK 1RB CH-High

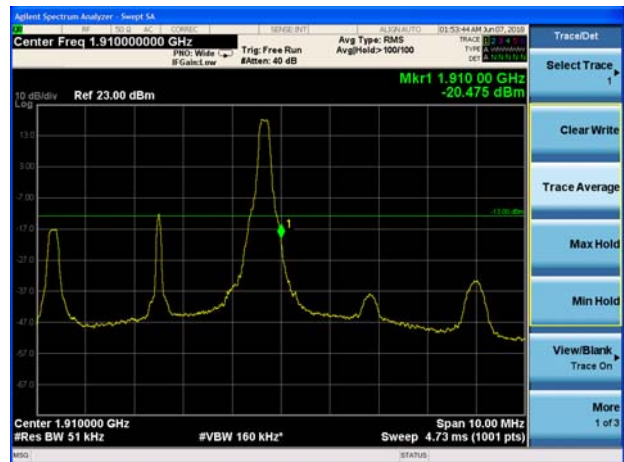

LTE Band 2 5MHz QPSK 100%RB CH-Low

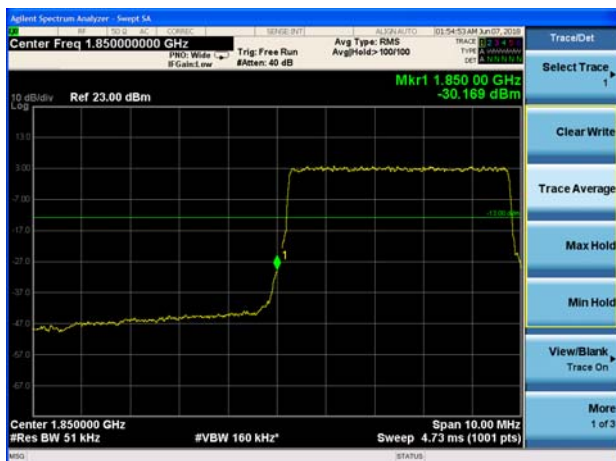

LTE Band 2 5MHz QPSK 100%RB CH-High



LTE Band 2 10MHz QPSK 1RB CH-Low

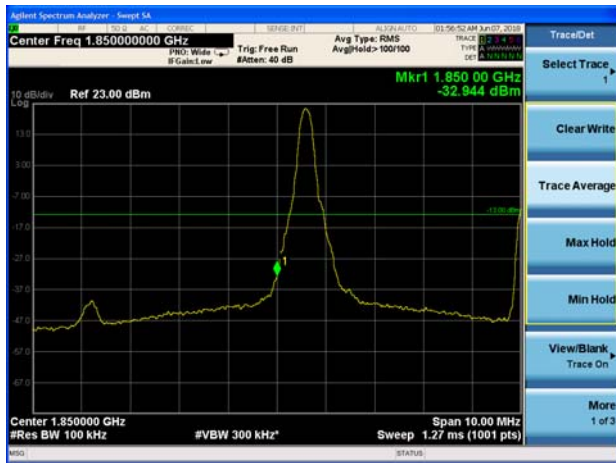

LTE Band 2 10MHz QPSK 1RB CH-High

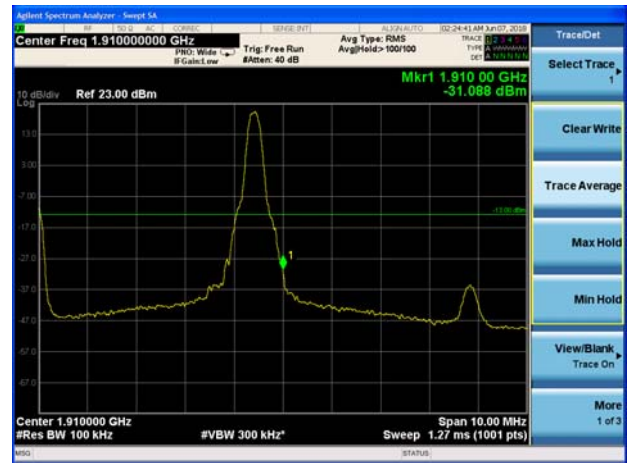

LTE Band 2 10MHz QPSK 100%RB CH-Low

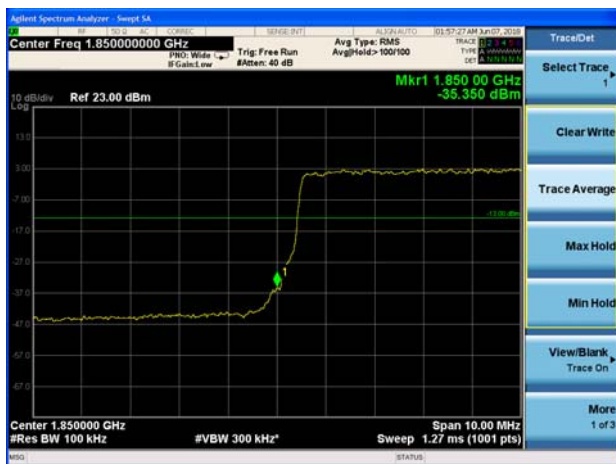

LTE Band 2 10MHz QPSK 100%RB CH-High

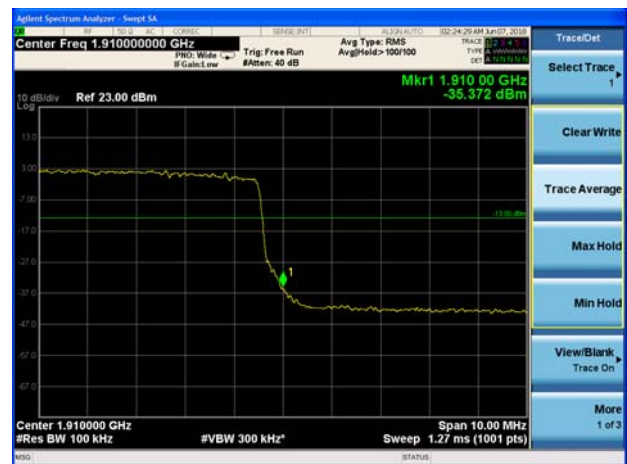

LTE Band 2 15MHz QPSK 1RB CH-Low

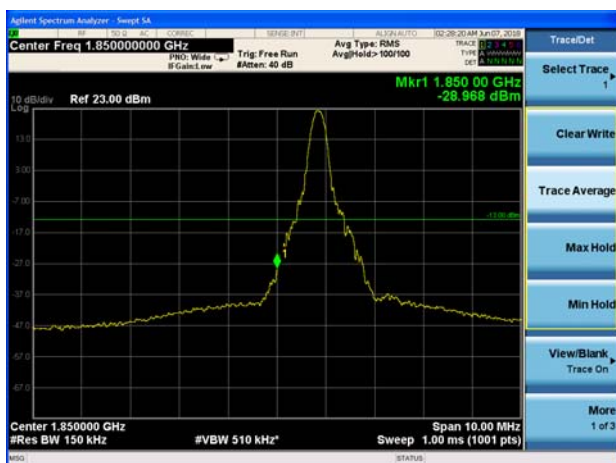

LTE Band 2 15MHz QPSK 1RB CH-High

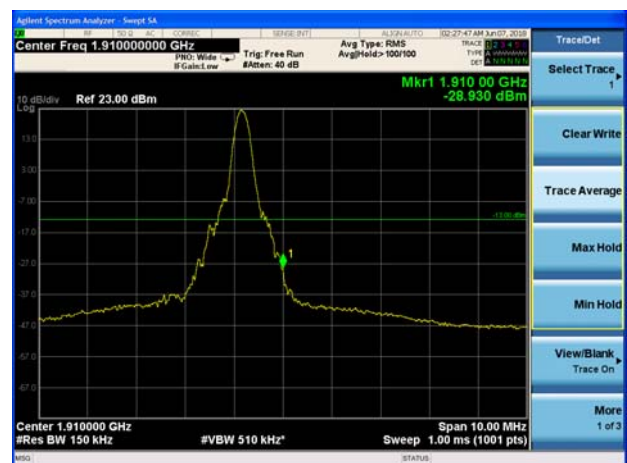



LTE Band 2 15MHz QPSK 100%RB CH-Low



LTE Band 2 15MHz QPSK 100%RB CH-High



LTE Band 2 20MHz QPSK 1RB CH-Low

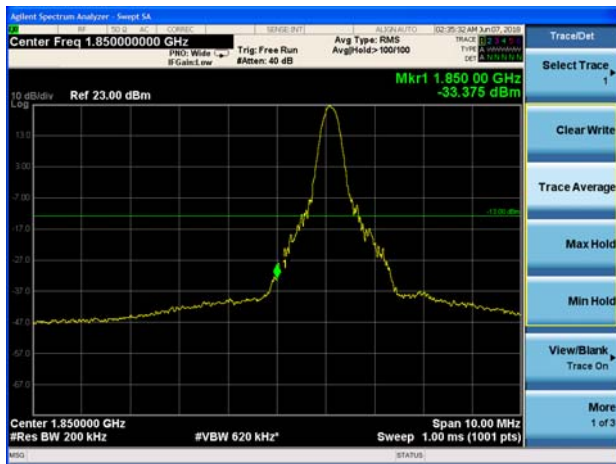

LTE Band 2 20MHz QPSK 1RB CH-High

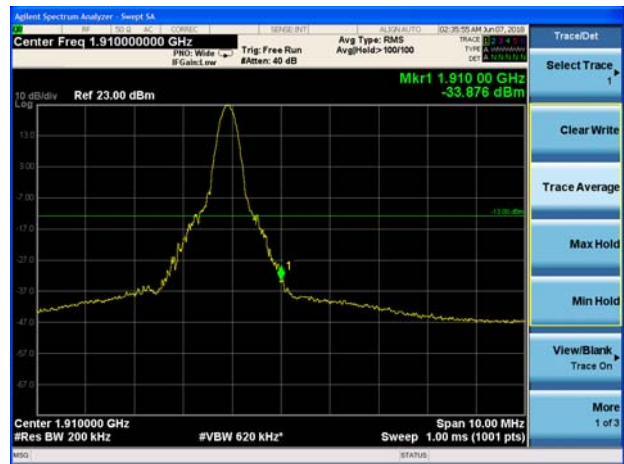

LTE Band 2 20MHz QPSK 100%RB CH-Low

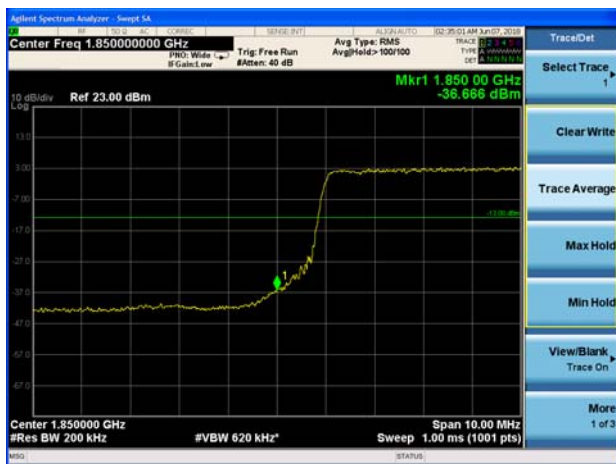

LTE Band 2 20MHz QPSK 100%RB CH-High







LTE Band 2 1.4MHz 16QAM 1RB CH-Low

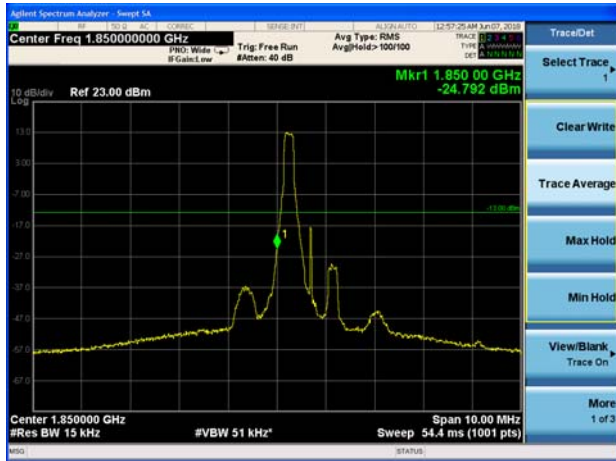

LTE Band 2 1.4MHz 16QAM 1RB CH-High



LTE Band 2 3MHz 16QAM 1RB CH-Low

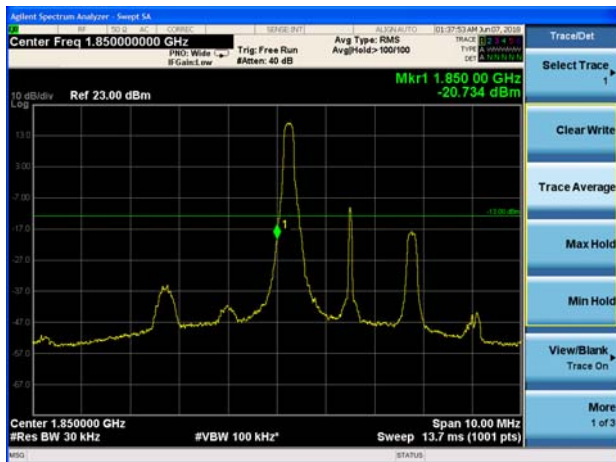

LTE Band 2 3MHz 16QAM 1RB CH-High

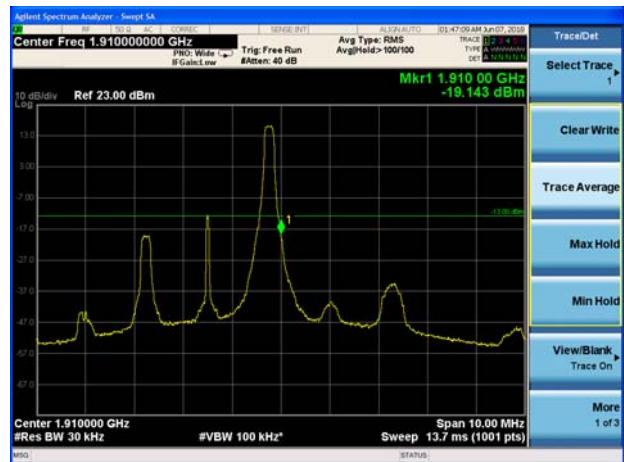

LTE Band 2 5MHz 16QAM 1RB CH-Low

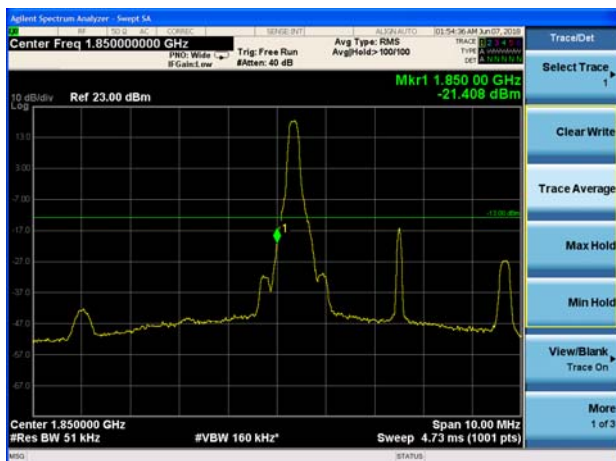

LTE Band 2 5MHz 16QAM 1RB CH-High

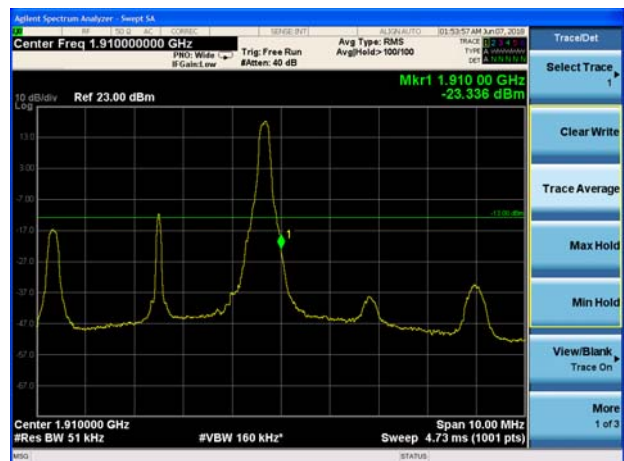

LTE Band 2 10MHz 16QAM 1RB CH-Low

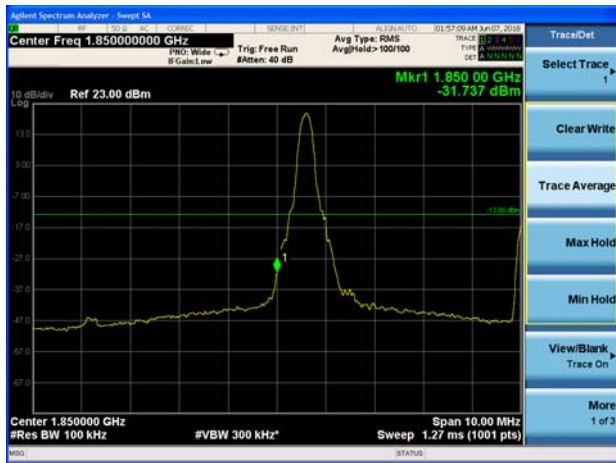

LTE Band 2 10MHz 16QAM 1RB CH-High

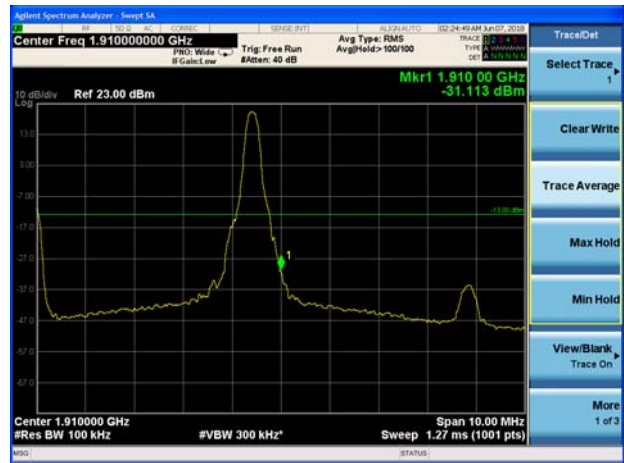

LTE Band 2 15MHz 16QAM 1RB CH-Low

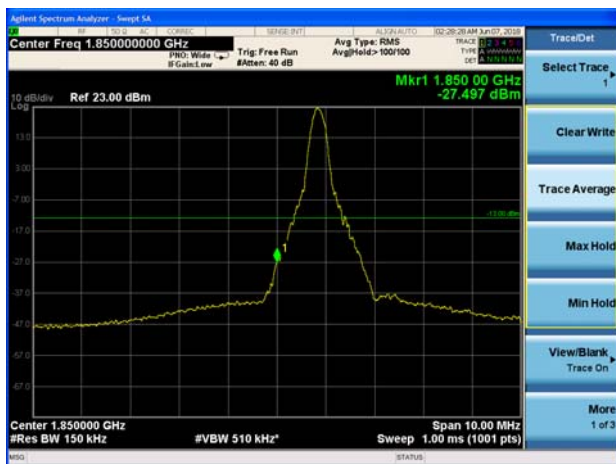

LTE Band 2 15MHz 16QAM 1RB CH-High

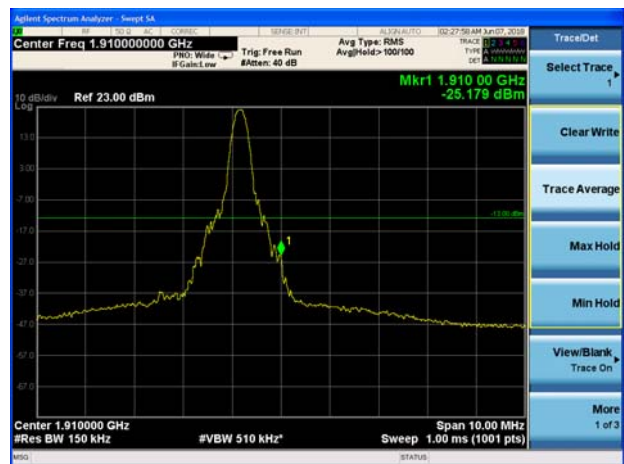

LTE Band 2 20MHz 16QAM 1RB CH-Low

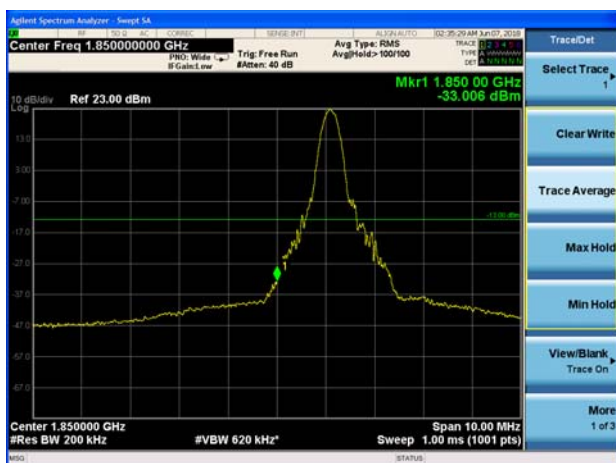

LTE Band 2 20MHz 16QAM 1RB CH-High

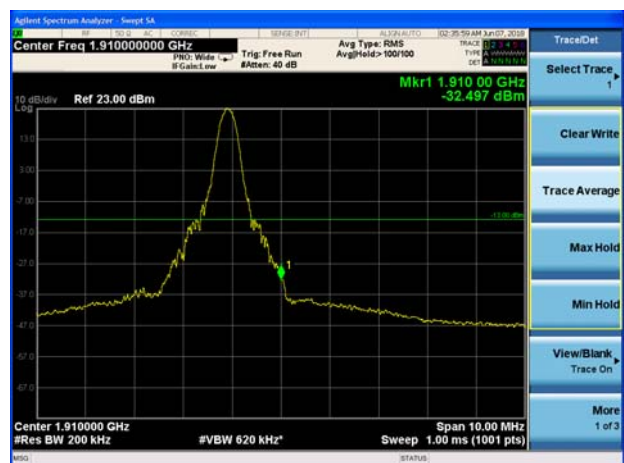

### 5.7. Peak-to-Average Power Ratio (PAPR)

**Ambient condition**

Temperature	Relative humidity	Pressure
23°C ~25°C	45%~50%	101.5kPa

**Methods of Measurement**

Measure the total peak power and record as PPk. And measure the total average power and record as PAvg. Both the peak and average power levels must be expressed in the same logarithmic units (e.g., dBm). Determine the PAPR from:

$$PAPR (dB) = PPk (dBm) - PAvg (dBm).$$

**Test Setup**

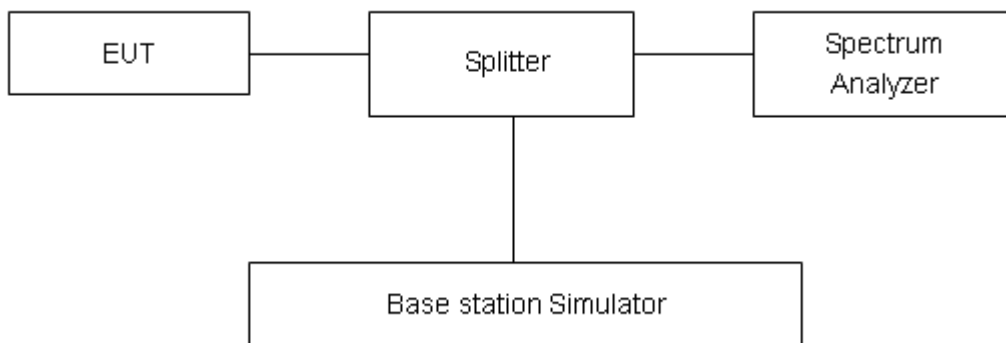

**Limits**

In measuring transmissions in this band using an average power technique, the peak-to-average ratio (PAR) of the transmission may not exceed 13 dB in 24.232(d).

**Measurement Uncertainty**

The assessed measurement uncertainty to ensure 95% confidence level for the normal distribution is with the coverage factor  $k = 2$ ,  $U = 0.4$  dB.



## Test Results

Mode	Channel	Frequency (MHz)	Peak(dBm)	Avg(dBm)	PAPR(dB)	Limit(dB)	Conclusion
WCDMA Band II (RMC)	9262	1852.4	26.27	23.38	2.89	≤13	PASS
	9400	1880	26.22	23.33	2.89	≤13	PASS
	9538	1907.6	26.04	23.18	2.86	≤13	PASS

LTE Band 2									
Modulation	Bandwidth (MHz)	Channel	Frequency (MHz)	Peak (dBm)	Avg (dBm)	PAPR (dB)	Limit (dB)	Conclusion	
QPSK	1.4	18607	1850.7	28.27	22.98	5.29	≤13	PASS	
		18900	1880.0	28.26	22.88	5.38	≤13	PASS	
		19193	1909.3	28.83	22.84	5.99	≤13	PASS	
	3	18615	1851.5	27.82	22.82	5.00	≤13	PASS	
		18900	1880	29.32	22.89	6.43	≤13	PASS	
		19185	1908.5	28.12	22.98	5.14	≤13	PASS	
	5	18625	1852.5	27.57	22.80	4.77	≤13	PASS	
		18900	1880	28.43	22.88	5.55	≤13	PASS	
		19175	1907.5	28.15	22.96	5.19	≤13	PASS	
	10	18650	1855	28.60	22.88	5.72	≤13	PASS	
		18900	1880	29.23	22.90	6.33	≤13	PASS	
		19150	1905	29.05	23.00	6.05	≤13	PASS	
	15	18675	1857.5	27.96	22.86	5.10	≤13	PASS	
		18900	1880	29.03	22.86	6.17	≤13	PASS	
		19125	1902.5	29.05	22.95	6.10	≤13	PASS	
	20	18700	1860	28.30	22.83	5.47	≤13	PASS	
		18900	1880	27.74	22.81	4.93	≤13	PASS	
		19100	1900	28.85	22.91	5.94	≤13	PASS	
	16QAM	1.4	18607	1850.7	29.27	22.89	6.38	≤13	PASS
			18900	1880.0	27.53	22.67	4.86	≤13	PASS
			19193	1909.3	29.13	23.09	6.04	≤13	PASS
		3	18615	1851.5	28.43	23.17	5.26	≤13	PASS
			18900	1880	28.97	22.99	5.98	≤13	PASS
			19185	1908.5	28.72	23.43	5.29	≤13	PASS
5		18625	1852.5	29.01	23.14	5.87	≤13	PASS	
		18900	1880	28.61	22.95	5.66	≤13	PASS	
		19175	1907.5	28.30	23.40	4.90	≤13	PASS	
10		18650	1855	29.39	23.16	6.23	≤13	PASS	
		18900	1880	29.54	22.98	6.56	≤13	PASS	
		19150	1905	28.37	23.42	4.95	≤13	PASS	
15		18675	1857.5	29.81	23.11	6.70	≤13	PASS	



		18900	1880	28.76	22.96	5.80	≤13	PASS
		19125	1902.5	29.69	23.40	6.29	≤13	PASS
	20	18700	1860	28.02	23.09	4.93	≤13	PASS
		18900	1880	28.87	22.92	5.95	≤13	PASS
		19100	1900	28.61	23.35	5.26	≤13	PASS

## 5.8. Frequency Stability

### Ambient condition

Temperature	Relative humidity	Pressure
23°C ~25°C	45%~50%	101.5kPa

### Method of Measurement

#### Frequency Stability (Temperature Variation)

The temperature inside the climate chamber is varied from -40°C to +85°C in 10°C step size,

(1) With all power removed, the temperature was decreased to 0°C and permitted to stabilize for three hours.

(2) Measure the carrier frequency with the test equipment in a “call mode”. These measurements should be made within 1 minute of powering up the mobile station, to prevent significant self warming.

(3) Repeat the above measurements at 10°C increments from -40°C to +85°C. Allow at least 1.5 hours at each temperature, un-powered, before making measurements.

#### Frequency Stability (Voltage Variation)

The frequency stability shall be measured with variation of primary supply voltage as follows:

(1) Vary primary supply voltage from 85 to 115 percent of the nominal value for other than hand carried battery equipment.

(2) For hand carried, battery powered equipment, reduce primary supply voltage to the battery-operating end point which shall be specified by the manufacturer.

This transceiver is specified to operate with an input voltage of between 3.3 V and 4.3 V, with a nominal voltage of 3.8V.

### Test setup

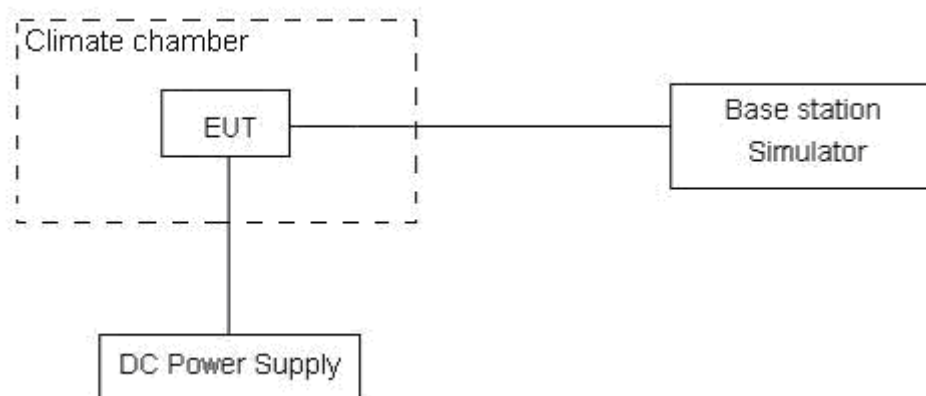



### **Limits**

No specific frequency stability requirements in part 24.235

### **Measurement Uncertainty**

The assessed measurement uncertainty to ensure 99.75% confidence level for the normal distribution is with the coverage factor  $k = 3$ ,  $U = 0.01\text{ppm}$ .

**Test Result**

WCDMA Band II						
Condition		Freq.Error (Hz)	Freq.Error (Hz)	Frequency Stability (ppm)	Frequency Stability (ppm)	Verdict
Temperature	Voltage	BPSK	QPSK	BPSK	QPSK	
Normal (25°C)	Normal	1.02	16.98	0.00054	0.00903	PASS
Extreme (85°C)		9.78	5.93	0.00520	0.00316	PASS
Extreme (80°C)		6.49	2.11	0.00345	0.00112	PASS
Extreme (70°C)		4.18	8.27	0.00223	0.00440	PASS
Extreme (60°C)		17.65	1.03	0.00939	0.00055	PASS
Extreme (50°C)		15.63	12.10	0.00831	0.00644	PASS
Extreme (40°C)		3.48	12.24	0.00185	0.00651	PASS
Extreme (30°C)		7.15	16.90	0.00381	0.00899	PASS
Extreme (20°C)		14.88	10.81	0.00791	0.00575	PASS
Extreme (10°C)		4.50	1.68	0.00239	0.00089	PASS
Extreme (0°C)		6.49	14.96	0.00345	0.00796	PASS
Extreme (-10°C)		3.13	9.59	0.00167	0.00510	PASS
Extreme (-20°C)		8.09	16.48	0.00430	0.00877	PASS
Extreme (-30°C)		14.09	12.69	0.00750	0.00675	PASS
Extreme (-40°C)		8.71	10.12	0.00463	0.00538	PASS
25°C		LV	12.51	16.90	0.00665	0.00899
	HV	9.51	17.97	0.00506	0.00956	PASS



LTE Band 2						
Condition		Freq.Error (Hz)	Freq.Error (Hz)	Frequency Stability (ppm)	Frequency Stability (ppm)	Verdict
BANDWIDTH	20MHz	16QAM	QPSK	16QAM	QPSK	
Temperature	Voltage	16QAM	QPSK	16QAM	QPSK	
Normal (25°C)	Normal	17.21	14.59	0.00915	0.00776	PASS
Extreme (85°C)		12.37	10.03	0.00658	0.00533	PASS
Extreme (80°C)		3.61	5.52	0.00192	0.00293	PASS
Extreme (70°C)		3.48	10.37	0.00185	0.00551	PASS
Extreme (60°C)		10.61	7.36	0.00565	0.00391	PASS
Extreme (50°C)		8.83	2.05	0.00469	0.00109	PASS
Extreme (40°C)		12.73	16.10	0.00677	0.00856	PASS
Extreme (30°C)		13.47	3.15	0.00717	0.00167	PASS
Extreme (20°C)		7.77	11.79	0.00414	0.00627	PASS
Extreme (10°C)		16.92	16.74	0.00900	0.00890	PASS
Extreme (0°C)		9.78	4.61	0.00520	0.00245	PASS
Extreme (-10°C)		14.97	2.85	0.00796	0.00151	PASS
Extreme (-20°C)		3.03	2.48	0.00161	0.00132	PASS
Extreme (-30°C)		7.79	1.61	0.00414	0.00086	PASS
Extreme (-40°C)		17.87	15.64	0.00951	0.00832	PASS
25°C		LV	8.14	7.24	0.00433	0.00385
	HV	6.03	11.05	0.00321	0.00588	PASS

### 5.9. Spurious Emissions at Antenna Terminals

#### Ambient condition

Temperature	Relative humidity	Pressure
23°C ~25°C	45%~50%	101.5kPa

#### Method of Measurement

The EUT was connected to Spectrum Analyzer and Base Station Simulator via power Splitter. The measurement is carried out using a spectrum analyzer. The spectrum analyzer scans from 9kHz to the 10th harmonic of the carrier. The peak detector is used.

RBW is set to 100kHz, VBW is set to 300kHz for 30MHz~1GHz

RBW is set to 1MHz, VBW is set to 3MHz for above 1GHz, Sweep is set to ATUO.

The modulation mode and RB allocation refer to section 5.1, using the maximum output power configuration.

#### Test setup

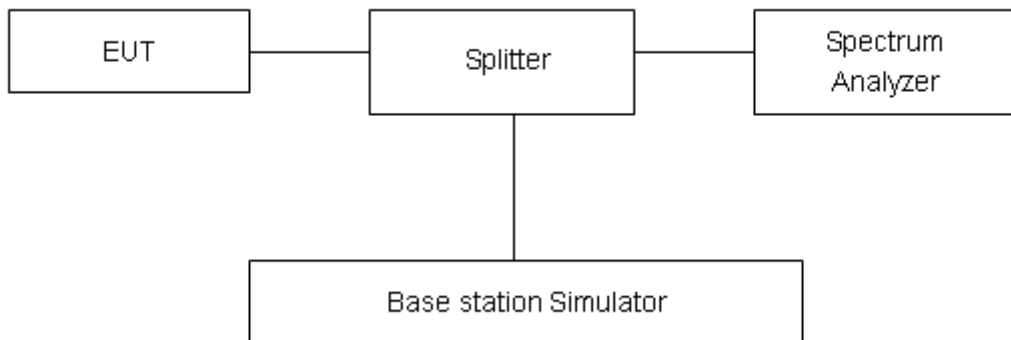

#### Limits

Rule Part 24.238(a) specifies that “on any frequency outside a licensee's frequency block, the power of any emission shall be attenuated below the transmitter power (P) by at least 43 + 10 log<sub>10</sub> (P) dB.”

Limit	-13 dBm
-------	---------

#### Measurement Uncertainty

The assessed measurement uncertainty to ensure 99.75% confidence level for the normal distribution is with the coverage factor  $k = 1.96$ .

Frequency	Uncertainty
9kHz-1GHz	0.684 dB
1GHz-20GHz	1.407 dB

### Test Result

Sweep the whole frequency band through the range from 9kHz to the 10th harmonic of the carrier, the emissions more than 20 dB below the limit are not reported.

The signal beyond the limit is carrier.

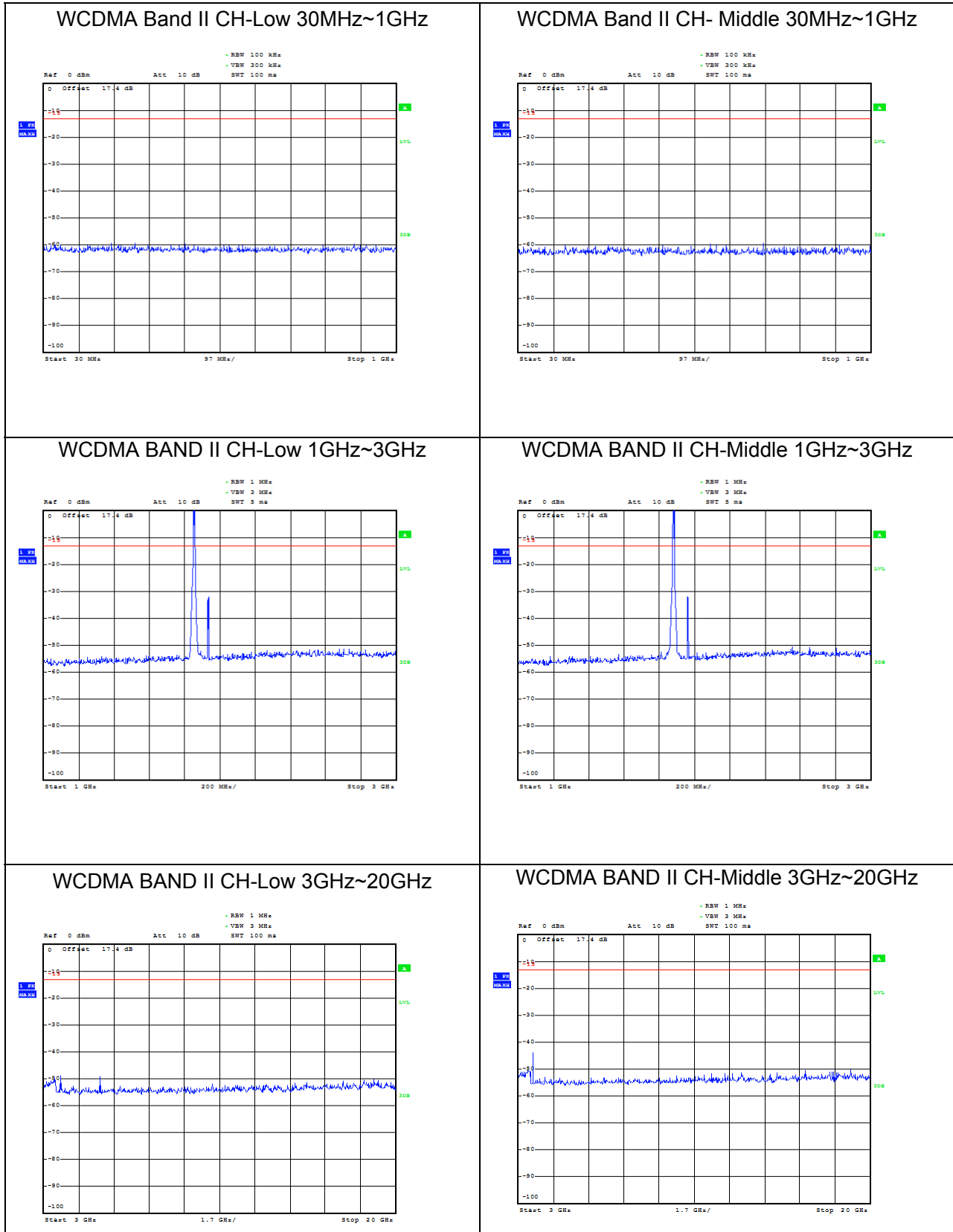





### WCDMA Band II CH- High 30MHz~1GHz

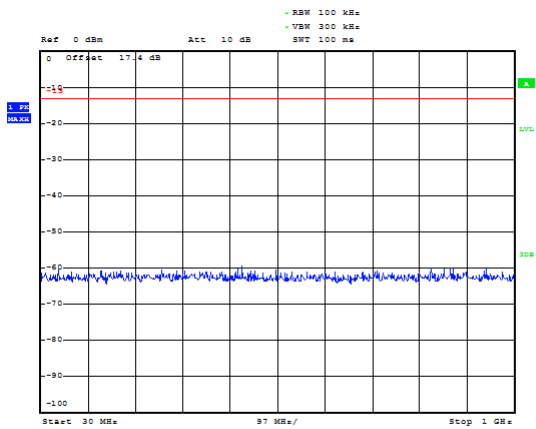

### WCDMA BAND II CH-High 1GHz~3GHz

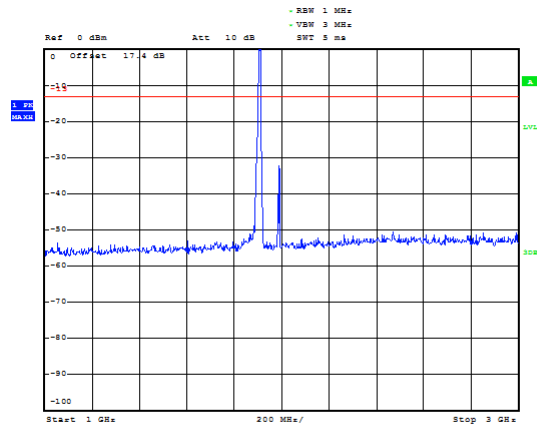

### WCDMA BAND II CH-High 3GHz~20GHz

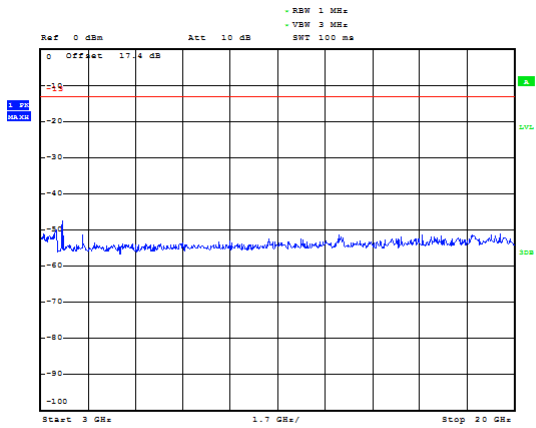



LTE Band 2 1.4MHz CH-Low 30MHz~1GHz

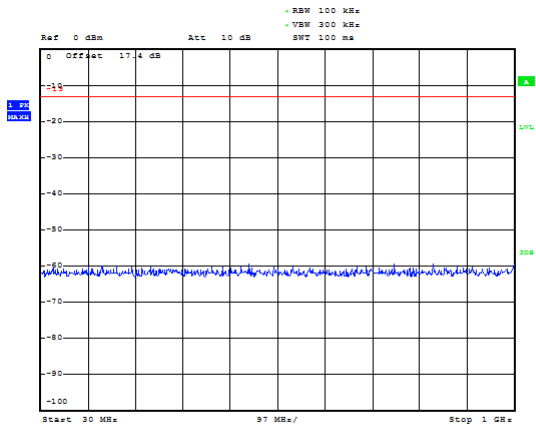

LTE Band 2 1.4MHz CH-Middle 30MHz~1GHz

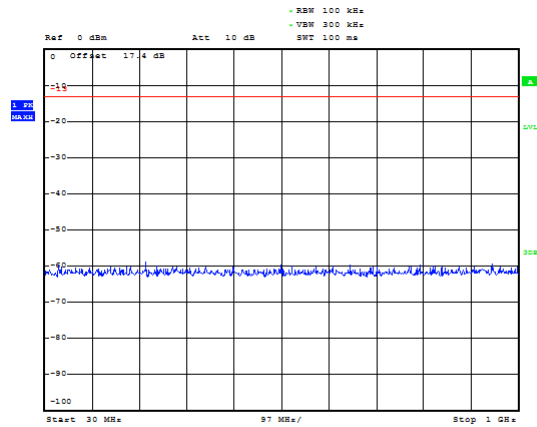

LTE Band 2 1.4MHz CH-Low 1GHz~3GHz

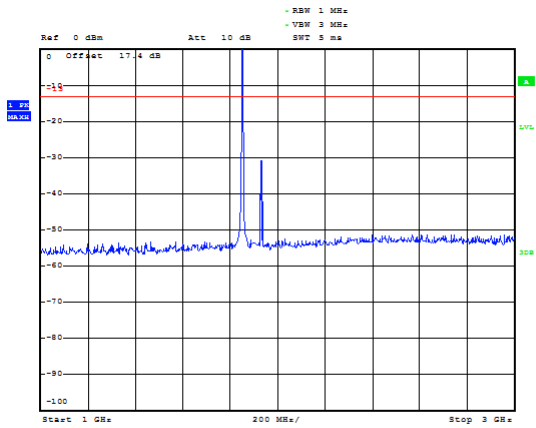

LTE Band 2 1.4MHz CH-Middle 1GHz~3GHz

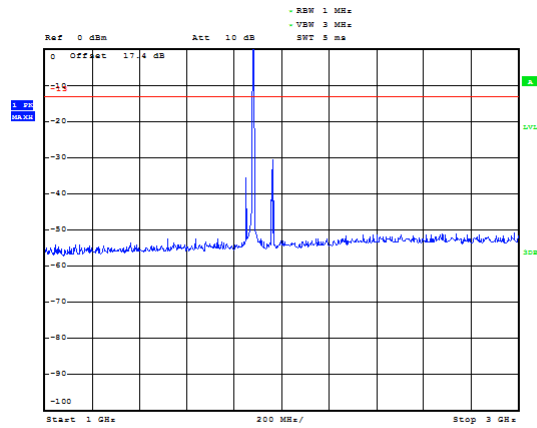

LTE Band 2 1.4MHz CH-Low 3GHz~20GHz

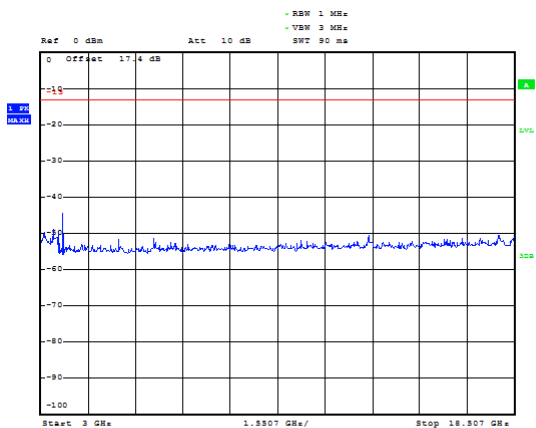

LTE Band 2 1.4MHz CH-Middle 3GHz~20GHz

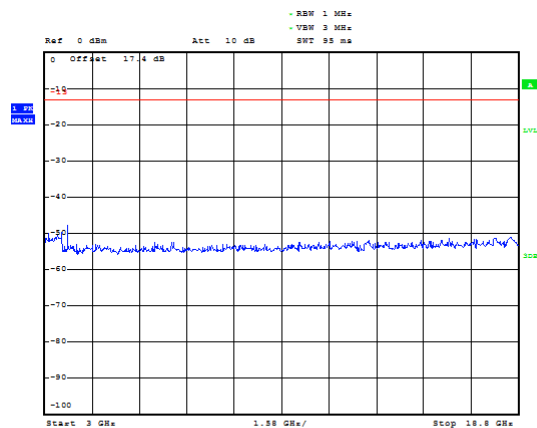



### LTE Band 2 1.4MHz CH-High 30MHz~1GHz

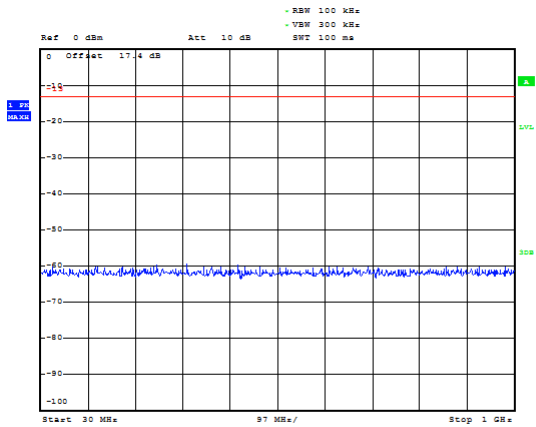

### LTE Band 2 3MHz CH-Low 30MHz~1GHz

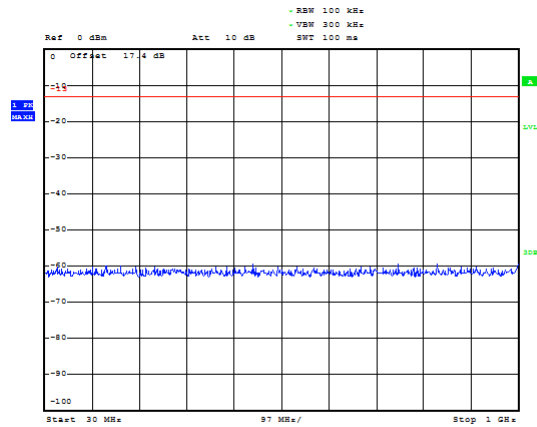

### LTE Band 2 1.4MHz CH-High 1GHz~3GHz

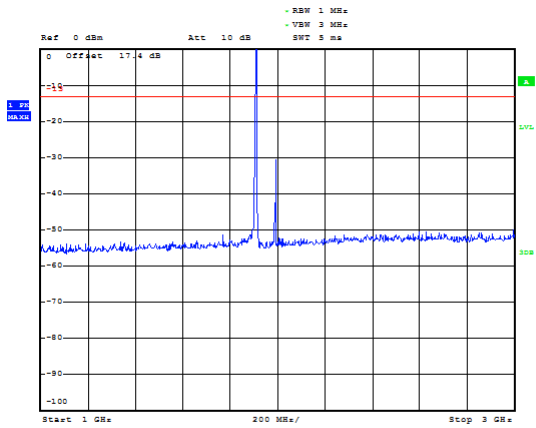

### LTE Band 2 3MHz CH-Low 1GHz~3GHz

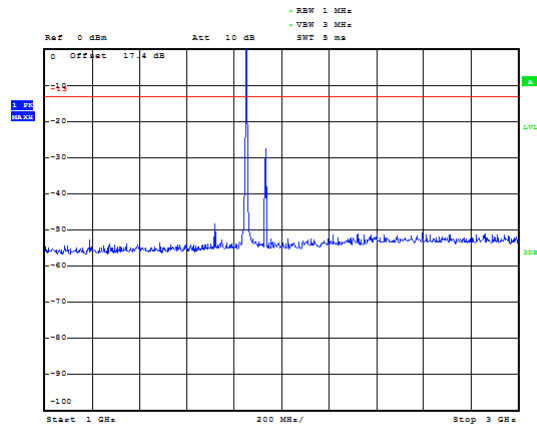

### LTE Band 2 1.4MHz CH-High 3GHz~20GHz

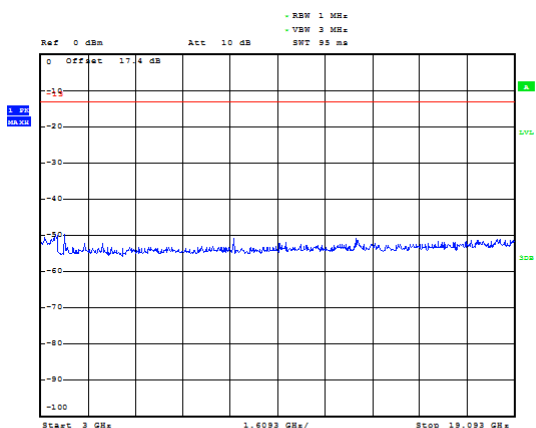

### LTE Band 2 3MHz CH-Low 3GHz~20GHz

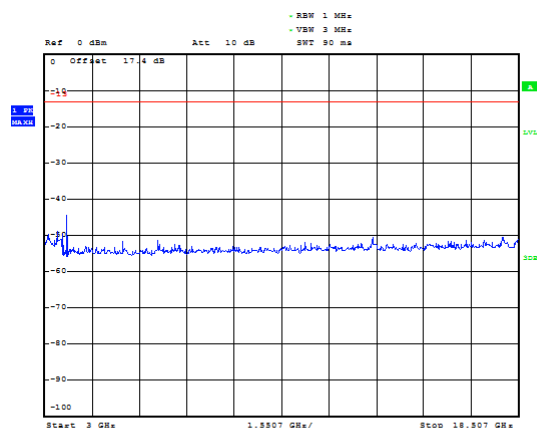



LTE Band 2 3MHz CH-Middle 30MHz~1GHz

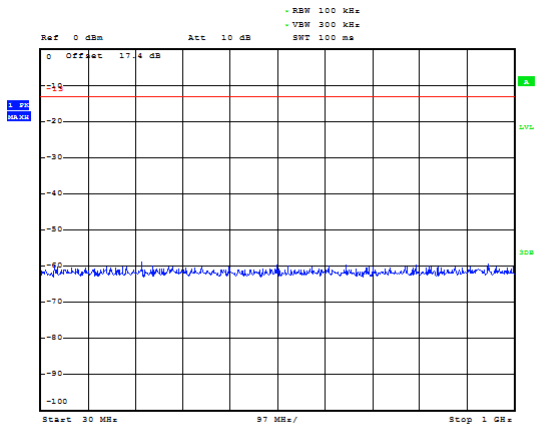

LTE Band 2 3MHz CH-High 30MHz~1GHz

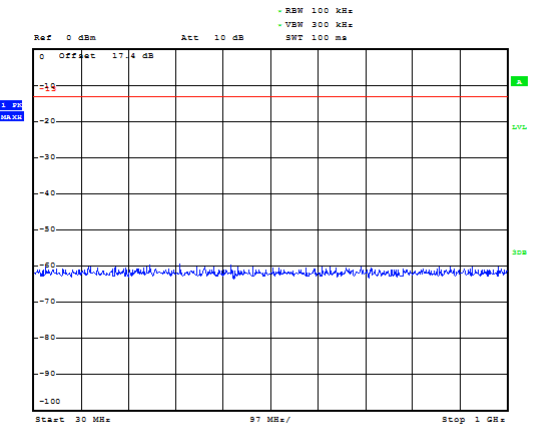

LTE Band 2 3MHz CH-Middle 1GHz~3GHz

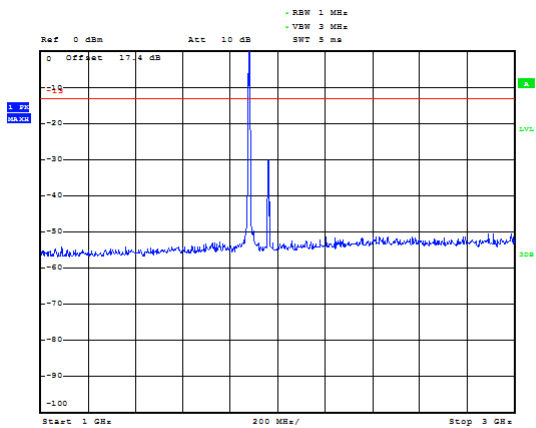

LTE Band 2 3MHz CH-High 1GHz~3GHz

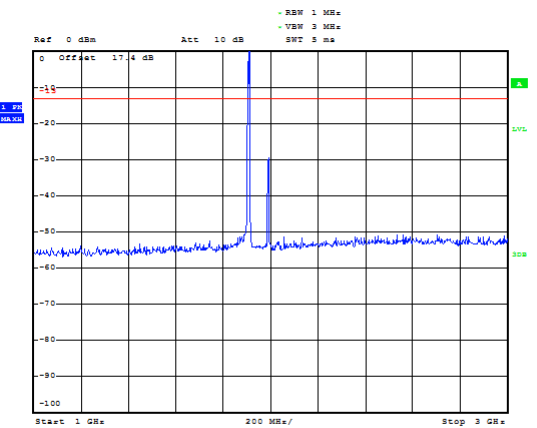

LTE Band 2 3MHz CH-Middle 3GHz~20GHz

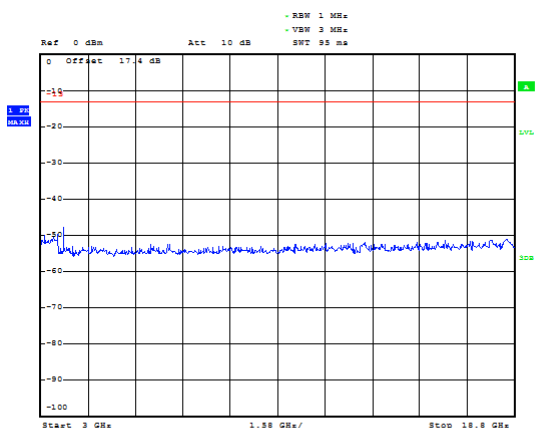

LTE Band 2 3MHz CH-High 3GHz~20GHz

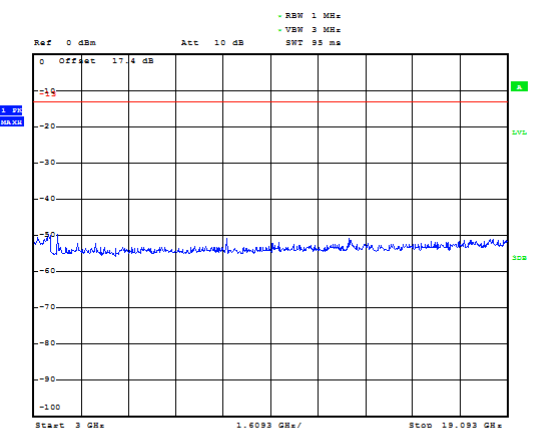





### LTE Band 2 5MHz CH-Low 30MHz~1GHz

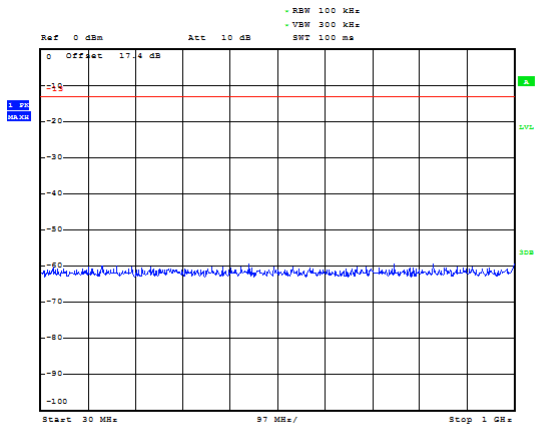

### LTE Band 2 5MHz CH-Middle 30MHz~1GHz

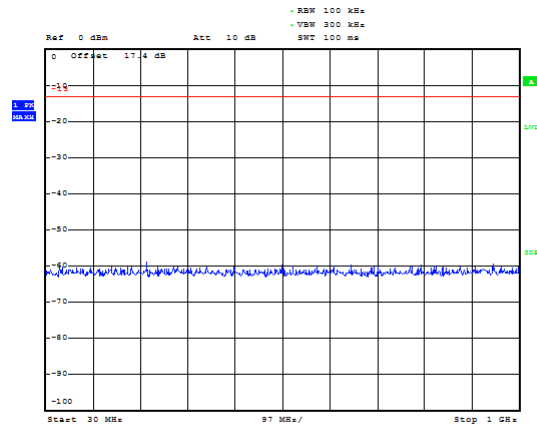

### LTE Band 2 5MHz CH-Low 1GHz~3GHz

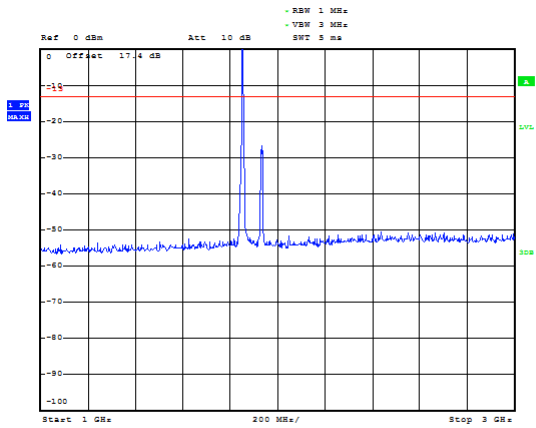

### LTE Band 2 5MHz CH-Middle 1GHz~3GHz

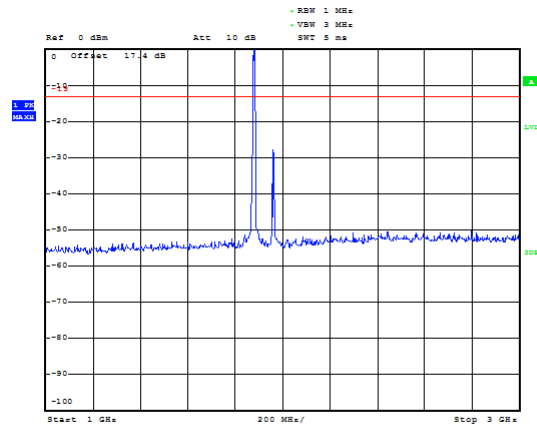

### LTE Band 2 5MHz CH-Low 3GHz~20GHz

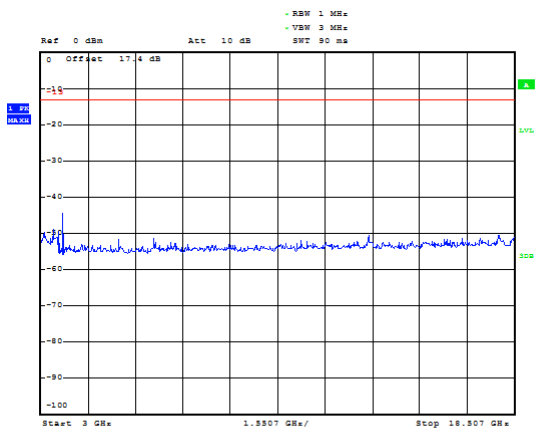

### LTE Band 2 5MHz CH-Middle 3GHz~20GHz

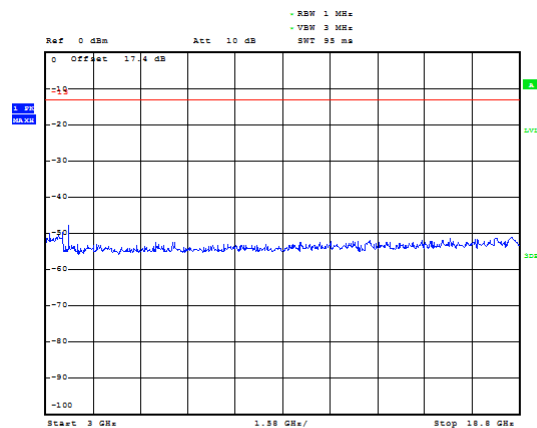



### LTE Band 2 5MHz CH-High 30MHz~1GHz

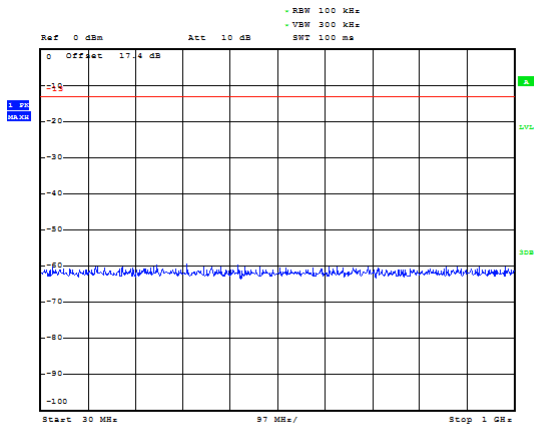

### LTE Band 2 10MHz CH-Low 30MHz~1GHz

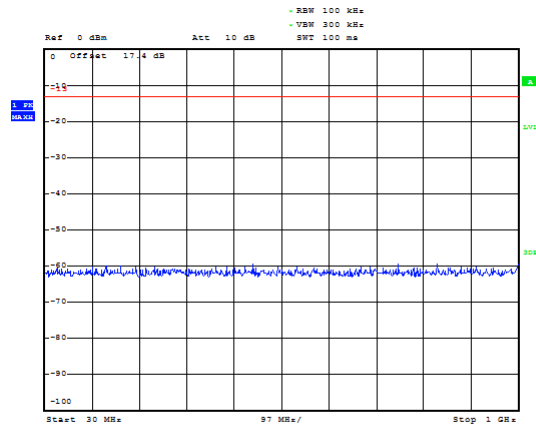

### LTE Band 2 5MHz CH-High 1GHz~3GHz

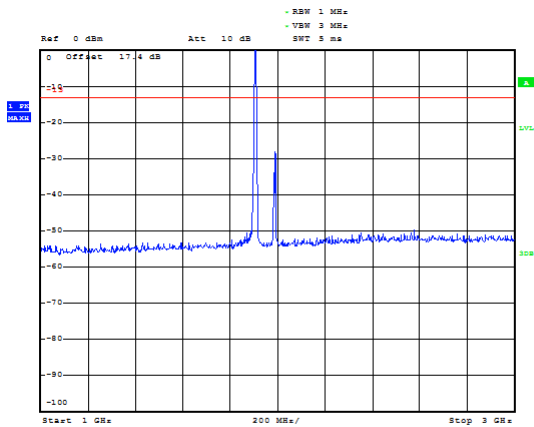

### LTE Band 2 10MHz CH-Low 1GHz~3GHz

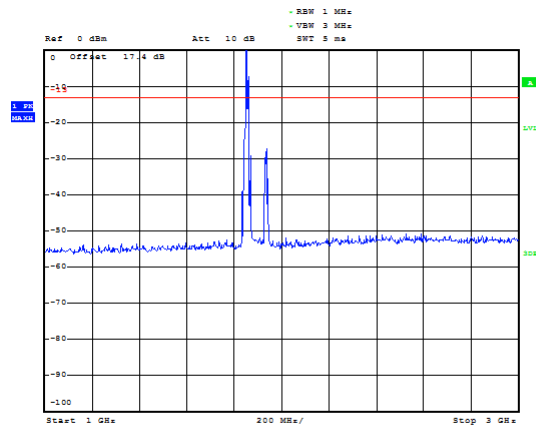

### LTE Band 2 5MHz CH-High 3GHz~20GHz

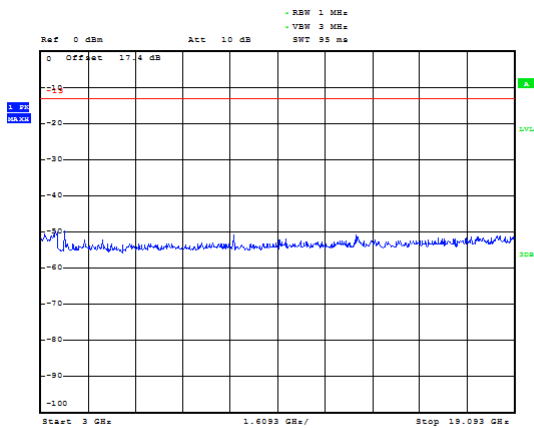

### LTE Band 2 10MHz CH-Low 3GHz~20GHz

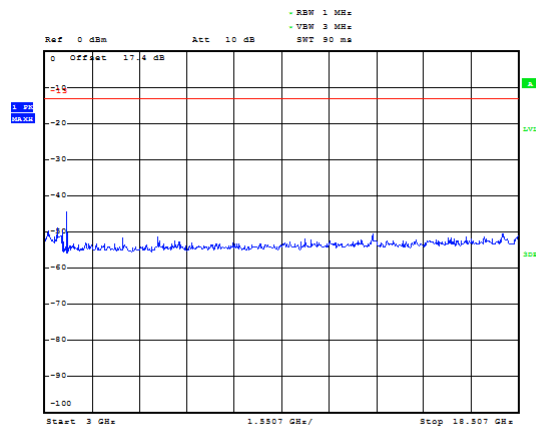



LTE Band 2 10MHz CH-Middle 30MHz~1GHz

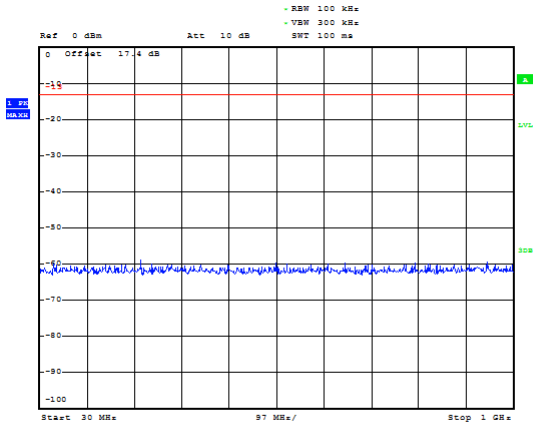

LTE Band 2 10MHz CH-High 30MHz~1GHz

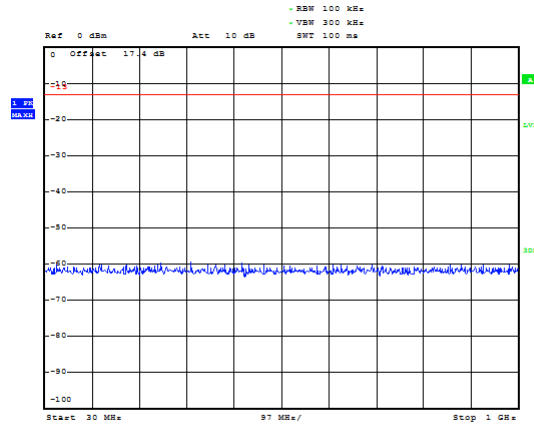

LTE Band 2 10MHz CH-Middle 1GHz~3GHz

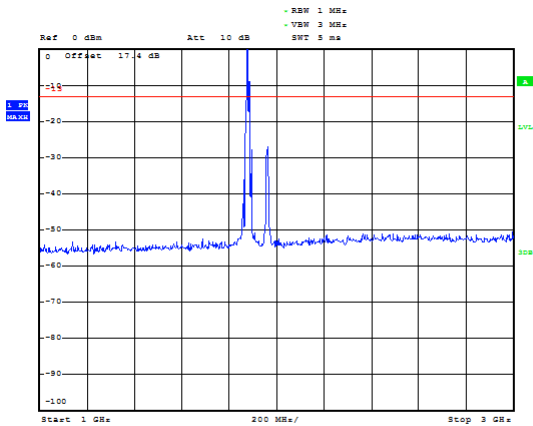

LTE Band 2 10MHz CH-High 1GHz~3GHz

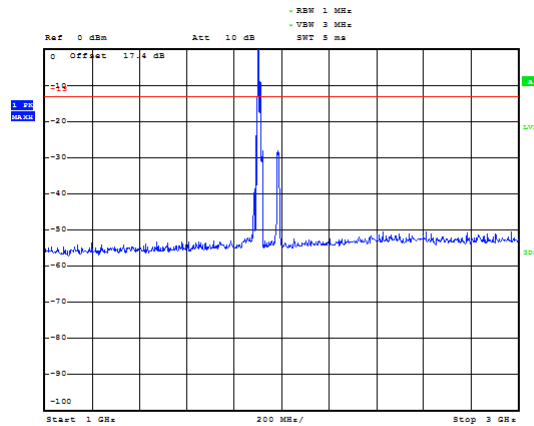

LTE Band 2 10MHz CH-Middle 3GHz~20GHz

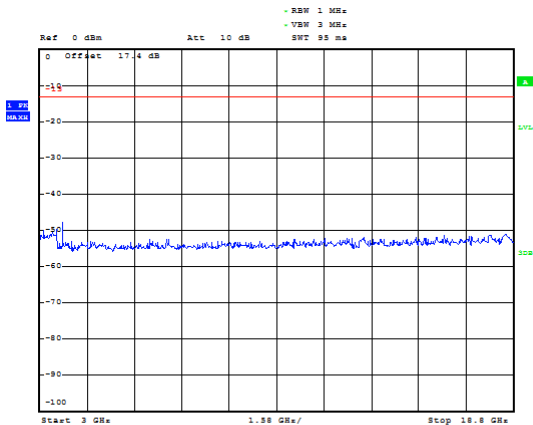

LTE Band 2 10MHz CH-High 3GHz~20GHz

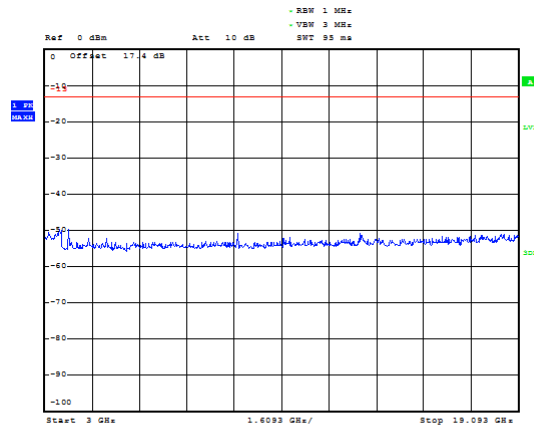



LTE Band 2 15MHz CH-Low 30MHz~1GHz

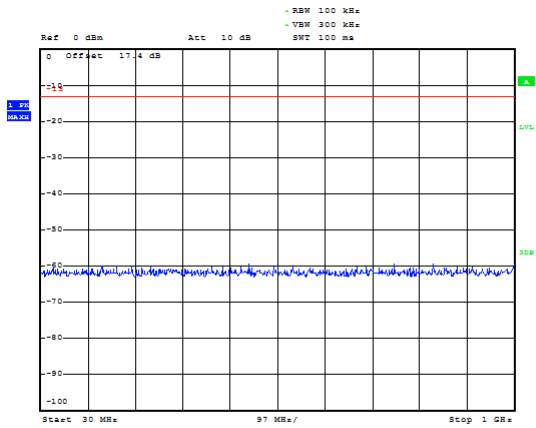

LTE Band 2 15MHz CH-Middle 30MHz~1GHz

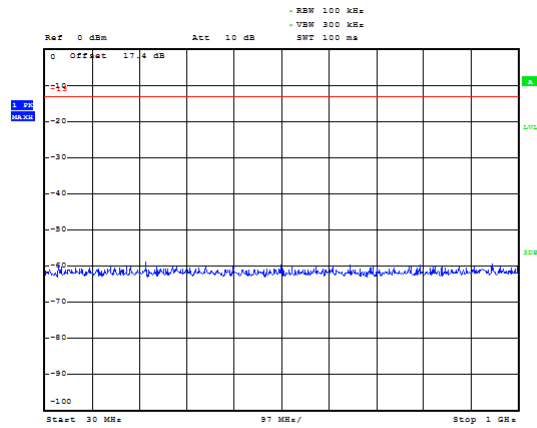

LTE Band 2 15MHz CH-Low 1GHz~3GHz

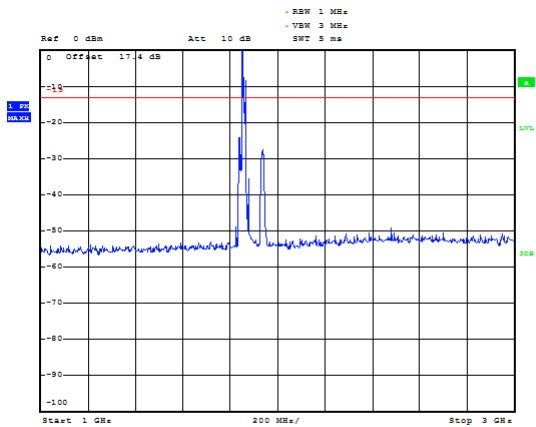

LTE Band 2 15MHz CH-Middle 1GHz~3GHz

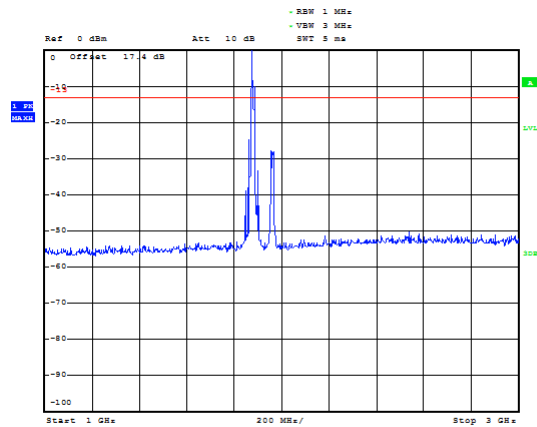

LTE Band 2 15MHz CH-Low 3GHz~20GHz

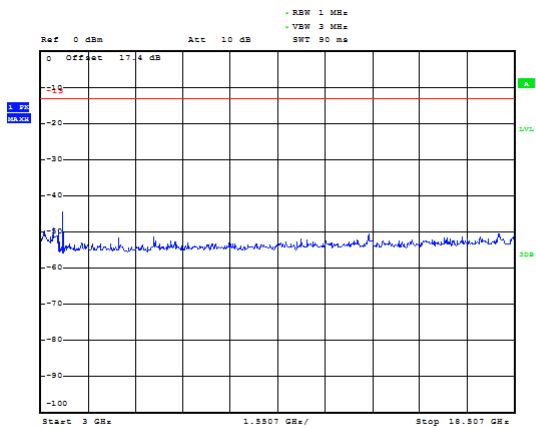

LTE Band 2 15MHz CH-Middle 3GHz~20GHz

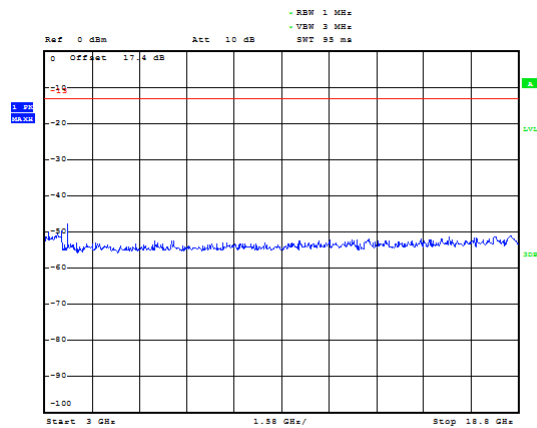



LTE Band 2 15MHz CH-High 30MHz~1GHz

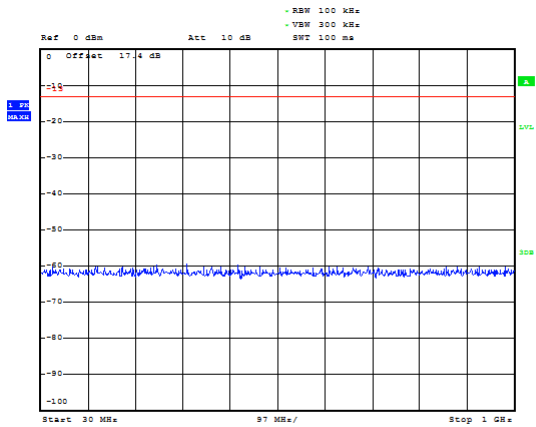

LTE Band 2 20MHz CH-Low 30MHz~1GHz

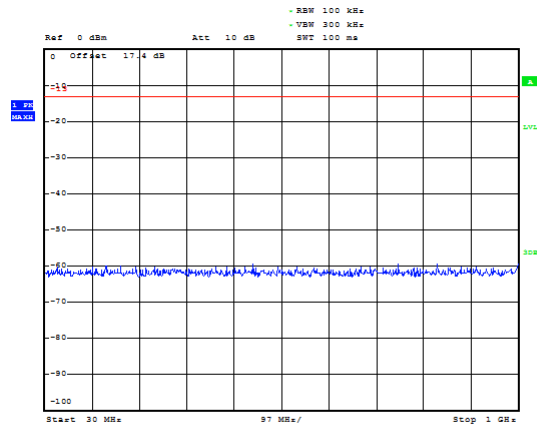

LTE Band 2 15MHz CH-High 1GHz~3GHz

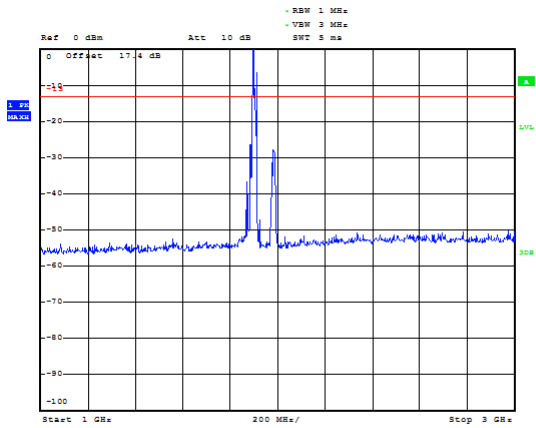

LTE Band 2 20MHz CH-Low 1GHz~3GHz

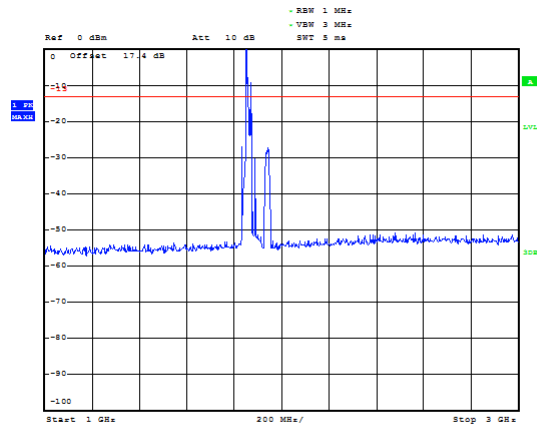

LTE Band 2 15MHz CH-High 3GHz~20GHz

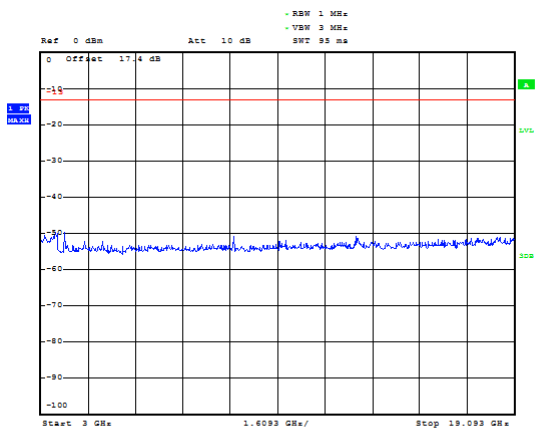

LTE Band 2 20MHz CH-Low 3GHz~20GHz

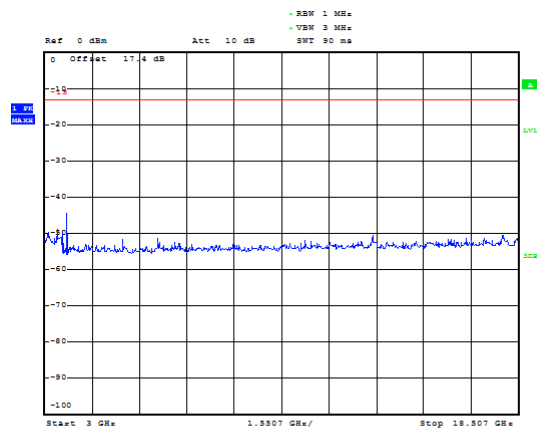



LTE Band 2 20MHz CH-Middle 30MHz~1GHz

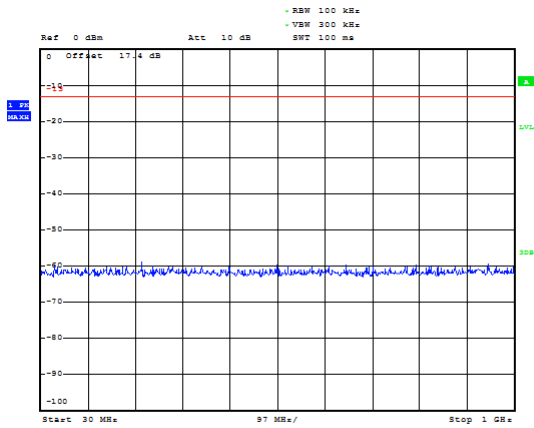

LTE Band 2 20MHz CH-High 30MHz~1GHz

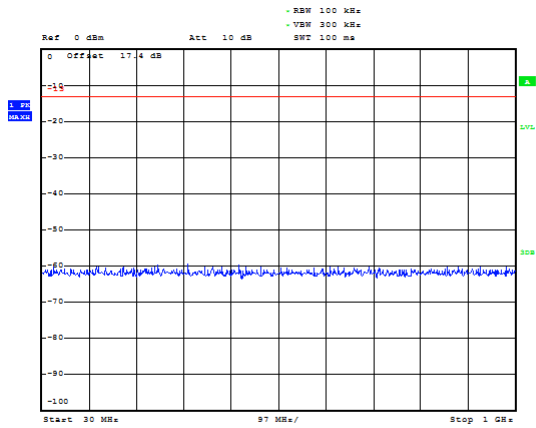

LTE Band 2 20MHz CH-Middle 1GHz~3GHz

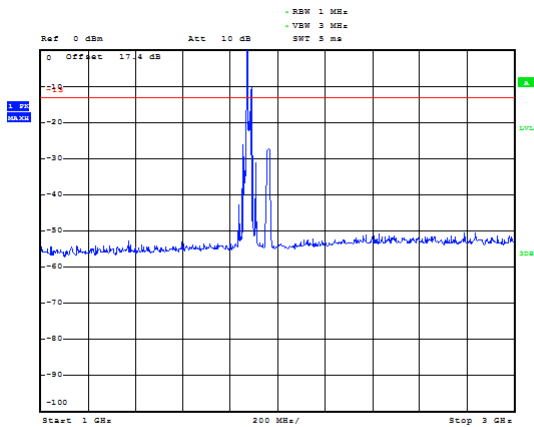

LTE Band 2 20MHz CH-High 1GHz~3GHz

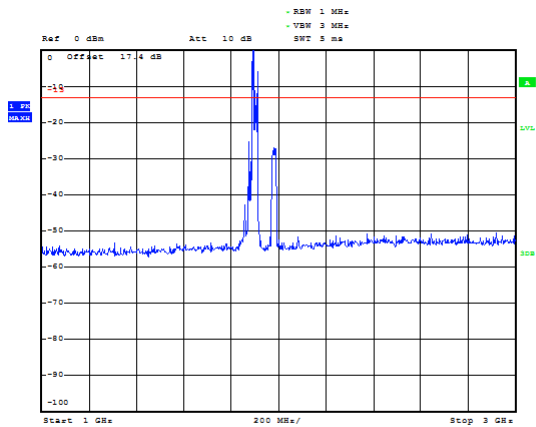

LTE Band 2 20MHz CH-Middle 3GHz~20GHz

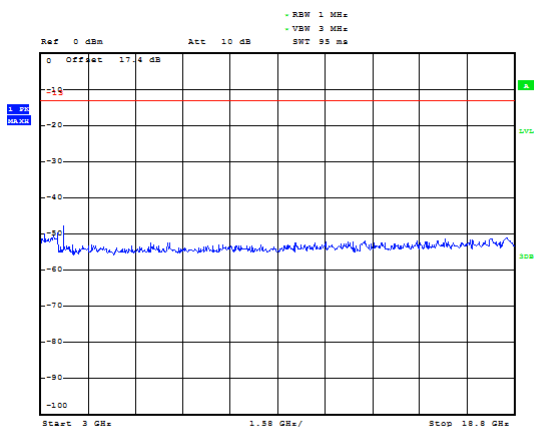

LTE Band 2 20MHz CH-High 3GHz~20GHz

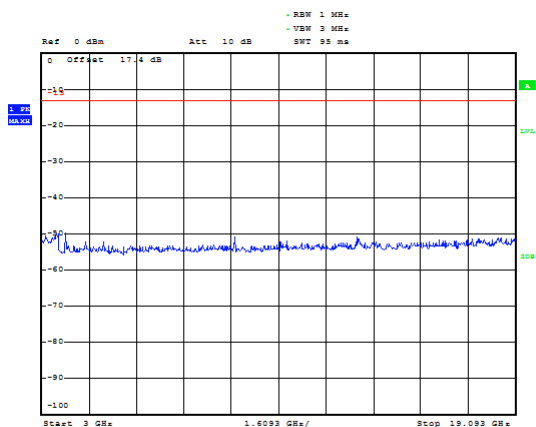

## 5.10. Radiates Spurious Emission

### Ambient condition

Temperature	Relative humidity	Pressure
23°C ~25°C	45%~50%	101.5kPa

### Method of Measurement

1. The testing follows FCC KDB 971168 v03r01 Section 5.8 and ANSI/TIA-603-E (2016).
2. The EUT is placed on a turntable 0.8 meters above the ground in the chamber, 3 meter away from the antenna. The maximal emission value is acquired by adjusting the antenna height, polarisation and turntable azimuth. Normally, the height range of antenna is 1 m to 4 m, the azimuth range of turntable is 0° to 360°, and the receive antenna has two polarizations Vertical (V) and Horizontal (H).
3. A log-periodic antenna or double-ridged waveguide horn antenna shall be substituted in place of the EUT. The log-periodic antenna will be driven by a signal generator and the level will be adjusted till the same power value on the spectrum analyzer or receiver. The level of the spurious emissions can be calculated through the level of the signal generator, cable loss, the gain of the substitution antenna and the reading of the spectrum analyzer or receiver.
4. The EUT is then put into continuously transmitting mode at its maximum power level during the test. Set Test Receiver or Spectrum RBW=1MHz, VBW=3MHz, And the maximum value of the receiver should be recorded as (Pr).
5. The EUT shall be replaced by a substitution antenna. In the chamber, an substitution antenna for the frequency band of interest is placed at the reference point of the chamber. An RF Signal source for the frequency band of interest is connected to the substitution antenna with a cable that has been constructed to not interfere with the radiation pattern of the antenna. A power (PMea) is applied to the input of the substitution antenna, and adjust the level of the signal generator output until the value of the receiver reach the previously recorded (Pr). The power of signal source (PMea) is recorded. The test should be performed by rotating the test item and adjusting the receiving antenna polarization.
6. A amplifier should be connected to the Signal Source output port. And the cable should be connect between the Amplifier and the Substitution Antenna. The cable loss (Pcl), the Substitution Antenna Gain (Ga) and the Amplifier Gain (PAg) should be recorded after test.
7. The measurement results are obtained as described below:  
$$\text{Power(EIRP)} = \text{PMea} - \text{PAg} - \text{Pcl} + \text{Ga}$$
  
The measurement results are amend as described below:  
$$\text{Power(EIRP)} = \text{PMea} - \text{Pcl} + \text{Ga}$$
8. This value is EIRP since the measurement is calibrated using an antenna of known gain (2.15 dBi) and known input power. ERP can be calculated from EIRP by subtracting the gain of the dipole,  $\text{ERP} = \text{EIRP} - 2.15\text{dBi}$ .

The modulation mode and RB allocation refer to section 5.1, using the maximum output power configuration.

**Test setup**

**30MHz~~~ 1GHz**

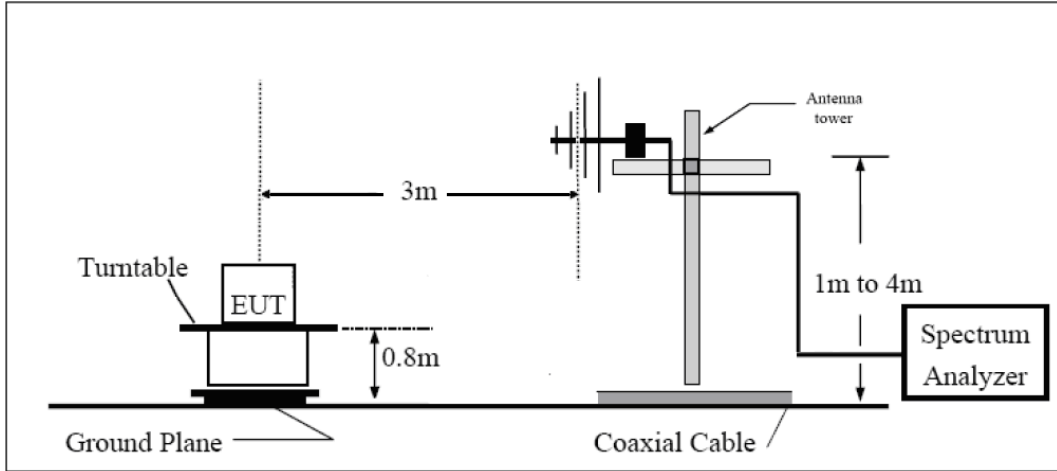

**Above 1GHz**

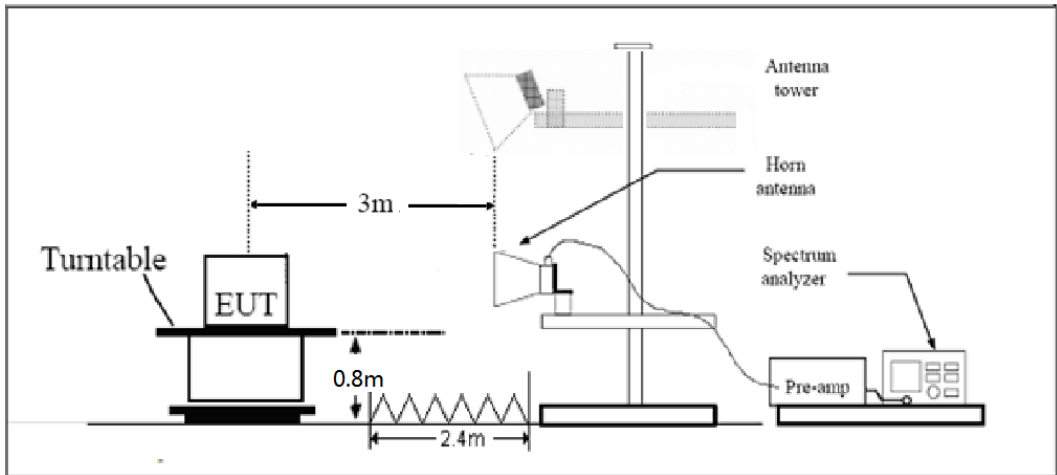

Note: Area side: 2.4mX3.6m

The radiated emission was measured in the following position: EUT stand-up position (Z axis), lie-down position (X, Y axis). The worst emission was found in lie-down position (X axis) and the worst case was recorded.

**Limits**

Rule Part 24.238(a) specifies that “on any frequency outside a licensee's frequency block, the power of any emission shall be attenuated below the transmitter power (P) by at least 43 + 10 log10 (P) dB.”

Limit	-13 dBm
-------	---------

**Measurement Uncertainty**

The assessed measurement uncertainty to ensure 95% confidence level for the normal distribution is with the coverage factor  $k = 1.96$ ,  $U = 3.55$  dB.



**Test Result**

Sweep the whole frequency band through the range from 30MHz to the 10th harmonic of the carrier, the emissions below the noise floor will not be recorded in the report.

## WCDMA Band II CH-Low

Harmonic	Frequency (MHz)	SG (dBm)	Cable Loss (dB)	Gain (dBi)	Antenna Polarization	EIRP Level (dBm)	Limit (dBm)	Margin (dB)	Azimuth (deg)
2	3702.7	-52.75	5.1	11.05	Horizontal	-46.80	-13.00	33.80	0
3	5554.5	-54.53	5.42	12.65	Horizontal	-47.30	-13.00	34.30	45
4	7409.6	-52.95	6.7	13.85	Horizontal	-45.80	-13.00	32.80	180
5	9262.0	-50.84	7.01	14.75	Horizontal	-43.10	-13.00	30.10	225
6	11114.4	-51.97	7.48	15.95	Horizontal	-43.50	-13.00	30.50	315
7	12966.8	-52.94	7.51	16.55	Horizontal	-43.90	-13.00	30.90	135
8	14819.2	-45.61	8.24	15.35	Horizontal	-38.50	-13.00	25.50	0
9	16671.6	-46.94	8.41	14.95	Horizontal	-40.40	-13.00	27.40	90
10	18524.0	-	-	-	-	-	-	-	-

Note: 1.The other Spurious RF Radiated emissions level is no more than noise floor.

2. The worst emission was found in the antenna is Horizontal position.

## WCDMA Band II CH-Middle

Harmonic	Frequency (MHz)	SG (dBm)	Cable Loss (dB)	Gain (dBi)	Antenna Polarization	EIRP Level (dBm)	Limit (dBm)	Margin (dB)	Azimuth (deg)
2	3758.3	-52.75	5.1	11.05	Horizontal	-46.80	-13.00	33.80	45
3	5643.4	-54.53	5.42	12.65	Horizontal	-47.30	-13.00	34.30	90
4	7520.0	-54.05	6.7	13.85	Horizontal	-46.90	-13.00	33.90	225
5	9400.0	-53.74	7.01	14.75	Horizontal	-46.00	-13.00	33.00	135
6	11280.0	-51.37	7.48	15.95	Horizontal	-42.90	-13.00	29.90	180
7	13160.0	-51.64	7.51	16.55	Horizontal	-42.60	-13.00	29.60	270
8	15040.0	-47.91	8.24	15.35	Horizontal	-40.80	-13.00	27.80	315
9	16920.0	-46.54	8.41	14.95	Horizontal	-40.00	-13.00	27.00	135
10	18800.0	-	-	-	-	-	-	-	-

Note: 1.The other Spurious RF Radiated emissions level is no more than noise floor.

2. The worst emission was found in the antenna is Horizontal position.

WCDMA Band II CH-High

Harmonic	Frequency (MHz)	SG (dBm)	Cable Loss (dB)	Gain (dBi)	Antenna Polarization	EIRP Level (dBm)	Limit (dBm)	Margin (dB)	Azimuth (deg)
2	3813.8	-52.25	5.1	11.05	Horizontal	-46.30	-13.00	33.30	135
3	5722.8	-49.13	5.42	12.65	Horizontal	-41.90	-13.00	28.90	90
4	7630.4	-54.55	6.7	13.85	Horizontal	-47.40	-13.00	34.40	45
5	9538.0	-54.54	7.01	14.75	Horizontal	-46.80	-13.00	33.80	225
6	11445.6	-52.07	7.48	15.95	Horizontal	-43.60	-13.00	30.60	270
7	13353.2	-50.14	7.51	16.55	Horizontal	-41.10	-13.00	28.10	315
8	15260.8	-47.91	8.24	15.35	Horizontal	-40.80	-13.00	27.80	0
9	17168.4	-47.54	8.41	14.95	Horizontal	-41.00	-13.00	28.00	0
10	19076.0	-	-	-	-	-	-	-	-

Note: 1.The other Spurious RF Radiated emissions level is no more than noise floor.  
2. The worst emission was found in the antenna is Horizontal position.

LTE Band 2 1.4MHz CH-Low

Harmonic	Frequency (MHz)	SG (dBm)	Cable Loss (dB)	Gain (dBi)	Antenna Polarization	EIRP Level (dBm)	Limit (dBm)	Margin (dB)	Azimuth (deg)
2	3700.5	-48.15	5.1	11.05	Horizontal	-42.20	-13.00	29.20	0
3	5550.8	-49.13	5.42	12.65	Horizontal	-41.90	-13.00	28.90	0
4	7402.8	-51.35	6.7	13.85	Horizontal	-44.20	-13.00	31.20	90
5	9253.5	-51.24	7.01	14.75	Horizontal	-43.50	-13.00	30.50	225
6	11104.2	-51.67	7.48	15.95	Horizontal	-43.20	-13.00	30.20	135
7	12954.9	-50.34	7.51	16.55	Horizontal	-41.30	-13.00	28.30	135
8	14805.6	-45.71	8.24	15.35	Horizontal	-38.60	-13.00	25.60	315
9	16656.3	-46.34	8.41	14.95	Horizontal	-39.80	-13.00	26.80	270
10	18507.0	-	-	-	-	-	-	-	-

Note: 1.The other Spurious RF Radiated emissions level is no more than noise floor.  
2. The worst emission was found in the antenna is Horizontal position.



## LTE Band 2 1.4MHz CH-Middle

Harmonic	Frequency (MHz)	SG (dBm)	Cable Loss (dB)	Gain (dBi)	Antenna Polarization	EIRP Level (dBm)	Limit (dBm)	Margin (dB)	Azimuth (deg)
2	3759.0	-45.85	5.10	11.05	Horizontal	-39.90	-13.00	26.90	45
3	5638.9	-47.43	5.42	12.65	Horizontal	-40.20	-13.00	27.20	45
4	7520.0	-52.85	6.70	13.85	Horizontal	-45.70	-13.00	32.70	135
5	9400.0	-52.34	7.01	14.75	Horizontal	-44.60	-13.00	31.60	0
6	11280.0	-51.87	7.48	15.95	Horizontal	-43.40	-13.00	30.40	0
7	13160.0	-51.54	7.51	16.55	Horizontal	-42.50	-13.00	29.50	225
8	15040.0	-48.11	8.24	15.35	Horizontal	-41.00	-13.00	28.00	315
9	16920.0	-46.44	8.41	14.95	Horizontal	-39.90	-13.00	26.90	90
10	18800.0	-	-	-	-	-	-	-	-

Note: 1. The other Spurious RF Radiated emissions level is no more than noise floor.

2. The worst emission was found in the antenna is Horizontal position.

## LTE Band 2 1.4MHz CH-High

Harmonic	Frequency (MHz)	SG (dBm)	Cable Loss (dB)	Gain (dBi)	Antenna Polarization	EIRP Level (dBm)	Limit (dBm)	Margin (dB)	Azimuth (deg)
2	3817.5	-45.35	5.10	11.05	Horizontal	-39.40	-13.00	26.40	180
3	5726.6	-43.43	5.42	12.65	Horizontal	-36.20	-13.00	23.20	180
4	7637.2	-52.85	6.70	13.85	Horizontal	-45.70	-13.00	32.70	45
5	9546.5	-52.24	7.01	14.75	Horizontal	-44.50	-13.00	31.50	0
6	11455.8	-52.17	7.48	15.95	Horizontal	-43.70	-13.00	30.70	0
7	13365.1	-51.34	7.51	16.55	Horizontal	-42.30	-13.00	29.30	135
8	15274.4	-47.61	8.24	15.35	Horizontal	-40.50	-13.00	27.50	90
9	17183.7	-45.64	8.41	14.95	Horizontal	-39.10	-13.00	26.10	270
10	19093.0	-	-	-	-	-	-	-	-

Note: 1. The other Spurious RF Radiated emissions level is no more than noise floor.

2. The worst emission was found in the antenna is Horizontal position.



## LTE Band 2 5MHz CH-Low

Harmonic	Frequency (MHz)	SG (dBm)	Cable Loss (dB)	Gain (dBi)	Antenna Polarization	EIRP Level (dBm)	Limit (dBm)	Margin (dB)	Azimuth (deg)
2	3700.5	-47.25	5.10	11.05	Horizontal	-41.30	-13.00	28.30	45
3	5551.5	-49.13	5.42	12.65	Horizontal	-41.90	-13.00	28.90	315
4	7410.0	-54.25	6.70	13.85	Horizontal	-47.10	-13.00	34.10	45
5	9262.5	-51.44	7.01	14.75	Horizontal	-43.70	-13.00	30.70	135
6	11115.0	-52.17	7.48	15.95	Horizontal	-43.70	-13.00	30.70	45
7	12967.5	-52.14	7.51	16.55	Horizontal	-43.10	-13.00	30.10	135
8	14820.0	-45.61	8.24	15.35	Horizontal	-38.50	-13.00	25.50	180
9	16672.5	-46.24	8.41	14.95	Horizontal	-39.70	-13.00	26.70	180
10	18525.0	-	-	-	-	-	-	-	-

Note: 1. The other Spurious RF Radiated emissions level is no more than noise floor.

2. The worst emission was found in the antenna is Horizontal position.

## LTE Band 2 5MHz CH-Middle

Harmonic	Frequency (MHz)	SG (dBm)	Cable Loss (dB)	Gain (dBi)	Antenna Polarization	EIRP Level (dBm)	Limit (dBm)	Margin (dB)	Azimuth (deg)
2	3755.6	-47.45	5.10	11.05	Horizontal	-41.50	-13.00	28.50	90
3	5633.6	-47.93	5.42	12.65	Horizontal	-40.70	-13.00	27.70	45
4	7520.0	-54.25	6.70	13.85	Horizontal	-47.10	-13.00	34.10	135
5	9400.0	-52.14	7.01	14.75	Horizontal	-44.40	-13.00	31.40	180
6	11280.0	-52.17	7.48	15.95	Horizontal	-43.70	-13.00	30.70	180
7	13160.0	-51.64	7.51	16.55	Horizontal	-42.60	-13.00	29.60	180
8	15040.0	-48.31	8.24	15.35	Horizontal	-41.20	-13.00	28.20	45
9	16920.0	-47.64	8.41	14.95	Horizontal	-41.10	-13.00	28.10	0
10	18800.0	-	-	-	-	-	-	-	-

Note: 1. The other Spurious RF Radiated emissions level is no more than noise floor.

2. The worst emission was found in the antenna is Horizontal position.



## LTE Band 2 5MHz CH-High

Harmonic	Frequency (MHz)	SG (dBm)	Cable Loss (dB)	Gain (dBi)	Antenna Polarization	EIRP Level (dBm)	Limit (dBm)	Margin (dB)	Azimuth (deg)
2	3810.8	-45.55	5.10	11.05	Horizontal	-39.60	-13.00	26.60	270
3	5716.1	-43.93	5.42	12.65	Horizontal	-36.70	-13.00	23.70	90
4	7621.5	-53.35	6.70	13.85	Horizontal	-46.20	-13.00	33.20	45
5	9537.5	-53.14	7.01	14.75	Horizontal	-45.40	-13.00	32.40	135
6	11445.0	-49.97	7.48	15.95	Horizontal	-41.50	-13.00	28.50	180
7	13352.5	-50.34	7.51	16.55	Horizontal	-41.30	-13.00	28.30	180
8	15260.0	-47.61	8.24	15.35	Horizontal	-40.50	-13.00	27.50	180
9	17167.5	-45.94	8.41	14.95	Horizontal	-39.40	-13.00	26.40	45
10	19075.0	-	-	-	-	-	-	-	-

Note: 1.The other Spurious RF Radiated emissions level is no more than noise floor.

2. The worst emission was found in the antenna is Horizontal position.

## LTE Band 2 20MHz CH-Low

Harmonic	Frequency (MHz)	SG (dBm)	Cable Loss (dB)	Gain (dBi)	Antenna Polarization	EIRP Level (dBm)	Limit (dBm)	Margin (dB)	Azimuth (deg)
2	3702.0	-46.35	5.10	11.05	Horizontal	-40.40	-13.00	27.40	45
3	5553.4	-49.63	5.42	12.65	Horizontal	-42.40	-13.00	29.40	180
4	7440.0	-53.25	6.70	13.85	Horizontal	-46.10	-13.00	33.10	315
5	9300.0	-52.14	7.01	14.75	Horizontal	-44.40	-13.00	31.40	45
6	11160.0	-52.37	7.48	15.95	Horizontal	-43.90	-13.00	30.90	0
7	13020.0	-51.34	7.51	16.55	Horizontal	-42.30	-13.00	29.30	45
8	14880.0	-48.21	8.24	15.35	Horizontal	-41.10	-13.00	28.10	90
9	16740.0	-46.74	8.41	14.95	Horizontal	-40.20	-13.00	27.20	315
10	18600.0	-	-	-	-	-	-	-	-

Note: 1.The other Spurious RF Radiated emissions level is no more than noise floor.

2. The worst emission was found in the antenna is Horizontal position.



## LTE Band 2 20MHz CH-Middle

Harmonic	Frequency (MHz)	SG (dBm)	Cable Loss (dB)	Gain (dBi)	Antenna Polarization	EIRP Level (dBm)	Limit (dBm)	Margin (dB)	Azimuth (deg)
2	3742.1	-48.15	5.10	11.05	Horizontal	-42.20	-13.00	29.20	180
3	5613.4	-47.83	5.42	12.65	Horizontal	-40.60	-13.00	27.60	45
4	7484.6	-53.45	6.70	13.85	Horizontal	-46.30	-13.00	33.30	0
5	9400.0	-53.54	7.01	14.75	Horizontal	-45.80	-13.00	32.80	0
6	11280.0	-52.67	7.48	15.95	Horizontal	-44.20	-13.00	31.20	135
7	13160.0	-52.64	7.51	16.55	Horizontal	-43.60	-13.00	30.60	90
8	15040.0	-48.41	8.24	15.35	Horizontal	-41.30	-13.00	28.30	270
9	16920.0	-45.34	8.41	14.95	Horizontal	-38.80	-13.00	25.80	270
10	18800.0	-	-	-	-	-	-	-	-

Note: 1. The other Spurious RF Radiated emissions level is no more than noise floor.

2. The worst emission was found in the antenna is Horizontal position.

## LTE Band 2 20MHz CH-High

Harmonic	Frequency (MHz)	SG (dBm)	Cable Loss (dB)	Gain (dBi)	Antenna Polarization	EIRP Level (dBm)	Limit (dBm)	Margin (dB)	Azimuth (deg)
2	3781.9	-49.15	5.10	11.05	Horizontal	-43.20	-13.00	30.20	135
3	5673.8	-45.73	5.42	12.65	Horizontal	-38.50	-13.00	25.50	180
4	7564.1	-54.25	6.70	13.85	Horizontal	-47.10	-13.00	34.10	45
5	9500.0	-54.74	7.01	14.75	Horizontal	-47.00	-13.00	34.00	90
6	11400.0	-49.37	7.48	15.95	Horizontal	-40.90	-13.00	27.90	0
7	13300.0	-50.44	7.51	16.55	Horizontal	-41.40	-13.00	28.40	90
8	15200.0	-46.91	8.24	15.35	Horizontal	-39.80	-13.00	26.80	45
9	17100.0	-45.94	8.41	14.95	Horizontal	-39.40	-13.00	26.40	180
10	19000.0	-	-	-	-	-	-	-	-

Note: 1. The other Spurious RF Radiated emissions level is no more than noise floor.

2. The worst emission was found in the antenna is Horizontal position.

## 6. Main Test Instruments

Name	Manufacturer	Type	Serial Number	Calibration Date	Expiration Date
Base Station Simulator	R&S	CMU200	118133	2019-05-19	2020-05-18
Base Station Simulator	R&S	CMU200	118133	2020-05-17	2021-05-16
Base Station Simulator	R&S	CMW500	113824	2019-05-19	2020-05-18
Base Station Simulator	R&S	CMW500	113824	2020-05-18	2021-05-17
Power Splitter	Hua Xiang	SHX-GF2-2-13	10120101	/	/
Spectrum Analyzer	Key sight	N9010A	MY50210259	2019-05-19	2020-05-18
Spectrum Analyzer	Key sight	N9010A	MY50210259	2020-05-18	2021-05-17
Universal Radio Communication Tester	Key sight	E5515C	MY48367192	2019-05-19	2020-05-27
Universal Radio Communication Tester	Key sight	E5515C	MY48367192	2020-05-27	2021-05-26
Signal Analyzer	R&S	FSV30	100815	2018-12-16	2019-12-15
Signal Analyzer	R&S	FSV30	100815	2019-12-15	2020-12-14
Loop Antenna	SCHWARZBECK	FMZB1519	1519-047	2017-09-26	2020-09-25
Trilog Antenna	SCHWARZBECK	VUBL 9163	9163-201	2017-11-18	2020-11-17
Horn Antenna	R&S	HF907	102723	2018-08-11	2021-08-10
Horn Antenna	ETS-Lindgren	3160-09	00102643	2018-06-20	2021-06-19
Signal generator	R&S	SMB 100A	102594	2019-05-19	2020-05-18
Signal generator	R&S	SMB 100A	102594	2020-05-18	2021-05-17
Climatic Chamber	ESPEC	SU-242	93000506	2017-12-17	2020-12-16
Preampfier	R&S	SCU18	102327	2019-05-19	2020-05-18
Preampfier	R&S	SCU18	102327	2020-05-18	2021-05-17



MOB COMMS DC SUPPLY	Keysight	66319D	MY43004105	2019-05-19	2020-05-18
MOB COMMS DC SUPPLY	Keysight	66319D	MY43004105	2020-05-18	2021-05-17
RF Cable	Agilent	SMA 15cm	0001	2019-06-14	2019-12-13
RF Cable	Agilent	SMA 15cm	0001	2020-06-12	2020-12-11
Software	R&S	EMC32	9.26.0	/	/

\*\*\*\*\*END OF REPORT \*\*\*\*\*