

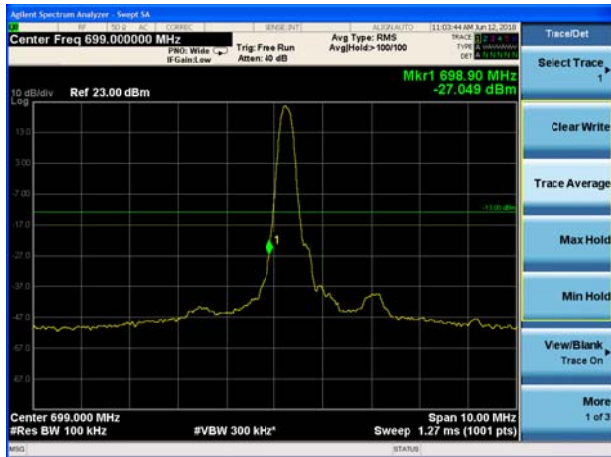

LTE Band 12 QPSK 1.4MHz CH-Low, 1 RB

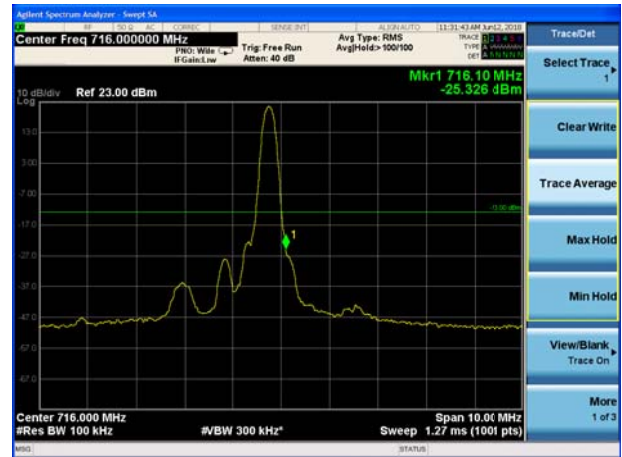

LTE Band 12 QPSK 1.4MHz CH-High, 1 RB



LTE Band 12 QPSK 1.4MHz CH-Low, 1 RB
698MHz~699MHz

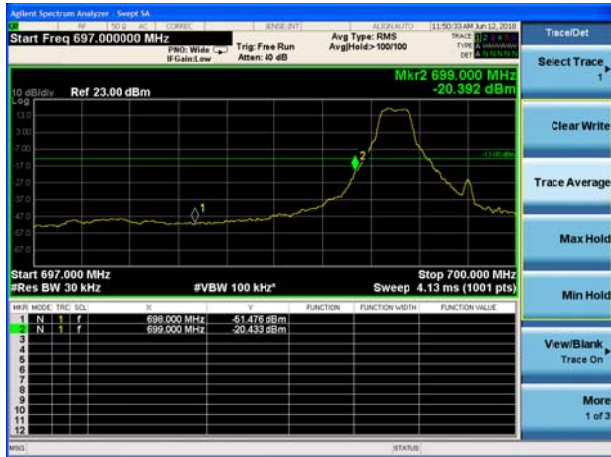

LTE Band 12 QPSK 1.4MHz CH-High, 1 RB
716MHz~717MHz

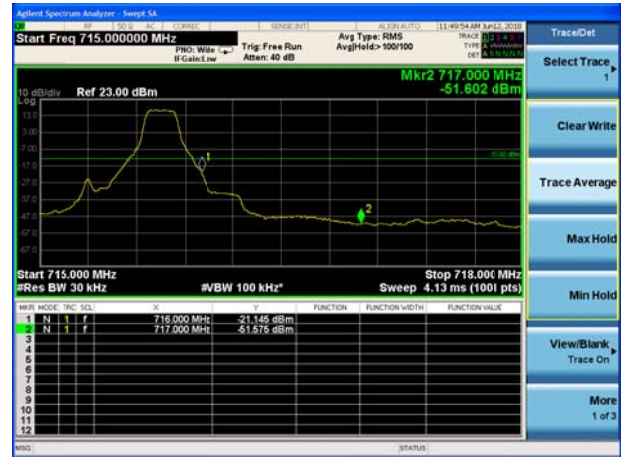

LTE Band 12 QPSK 1.4MHz CH-Low, 100%RB

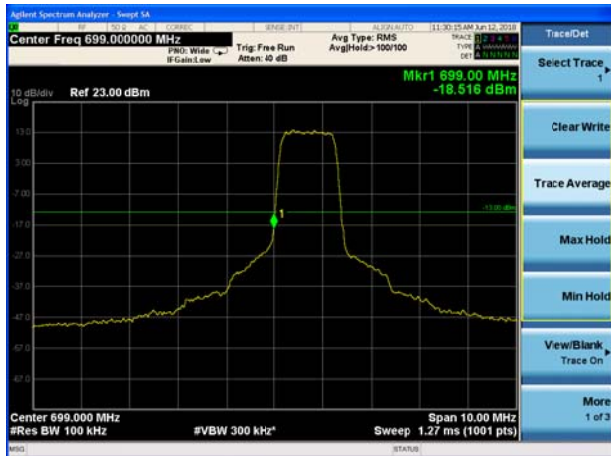

LTE Band 12 QPSK 1.4MHz CH-High, 100%RB





LTE Band 12 QPSK 3MHz CH-Low, 1 RB

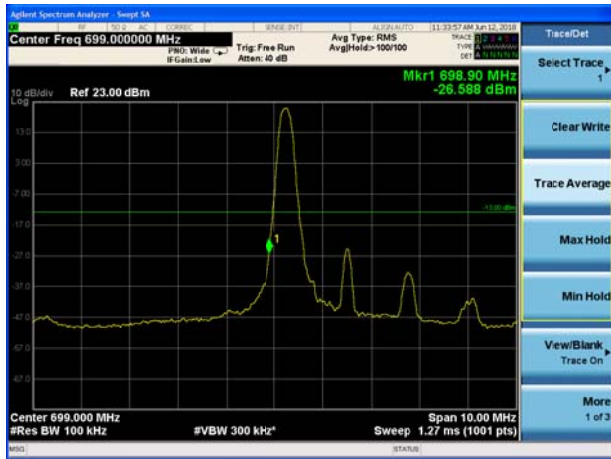

LTE Band 12 QPSK 3MHz CH-High, 1 RB

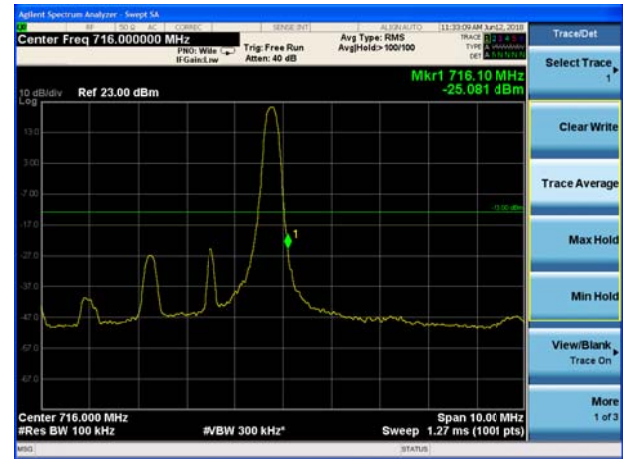

LTE Band 12 QPSK 3MHz CH-Low, 1RB
698MHz~699MHz



LTE Band 12 QPSK 3MHz CH-High, 1RB
698MHz~699MHz

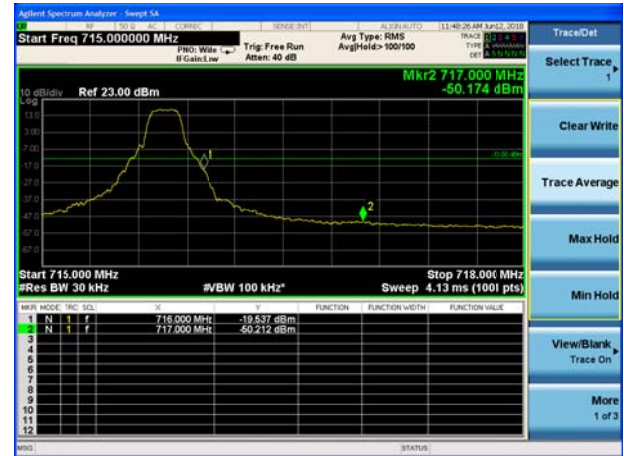

LTE Band 12 QPSK 3MHz CH-Low, 100%RB



LTE Band 12 QPSK 3MHz CH-High, 100%RB

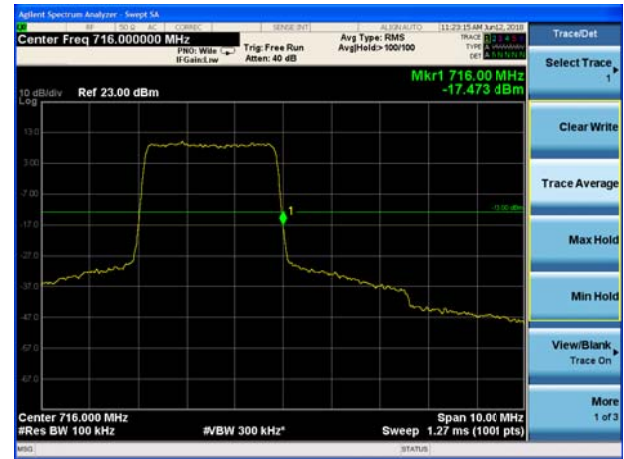

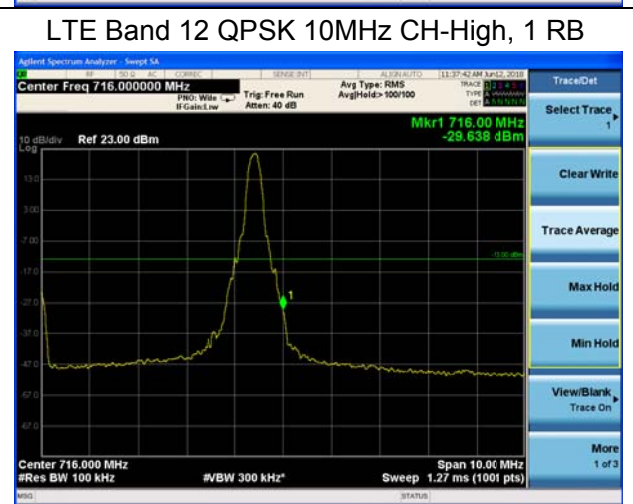
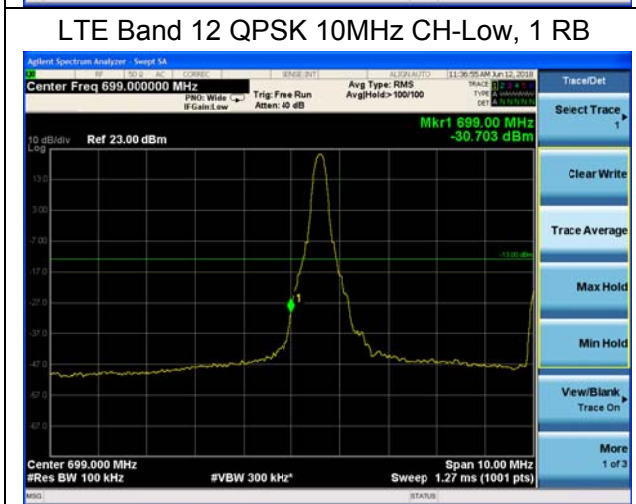
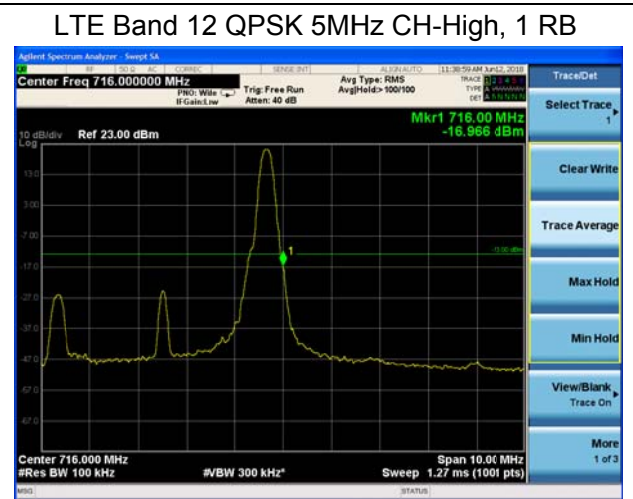
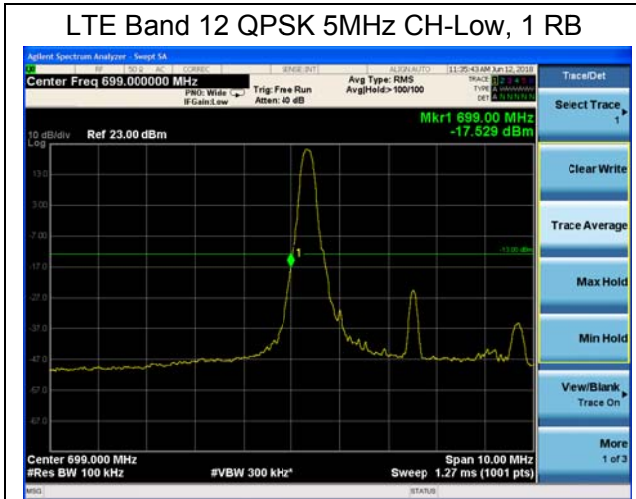



LTE Band 12 QPSK 10MHz CH-Low, 100%RB



LTE Band 12 QPSK 10MHz CH-High, 100%RB



LTE Band 12 16QAM 1.4MHz CH-Low, 1 RB

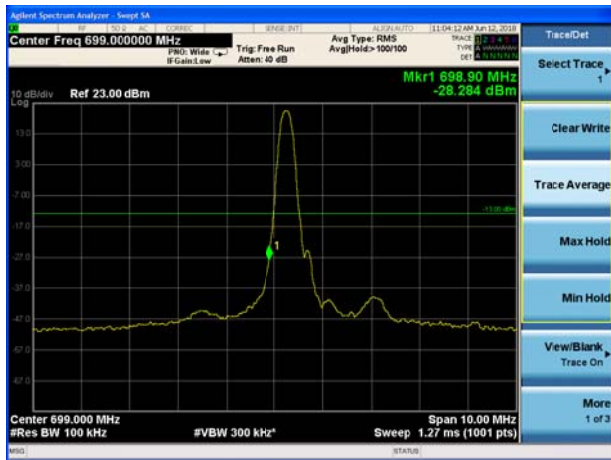

LTE Band 12 16QAM 1.4MHz CH-High, 1 RB



LTE Band 12 16QAM 1.4MHz CH-Low, 1 RB
698MHz~699MHz

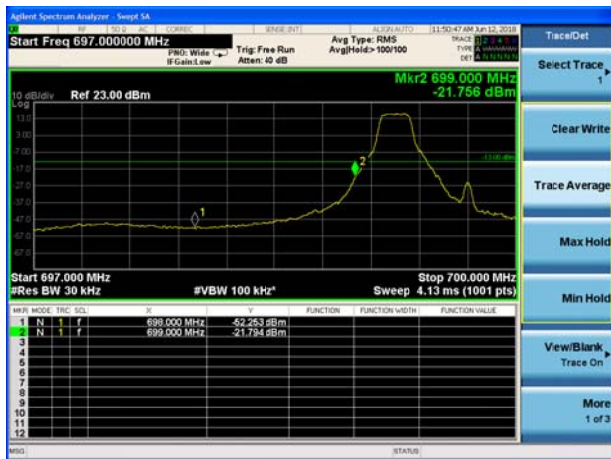

LTE Band 12 16QAM 1.4MHz CH-High, 1 RB
716MHz~717MHz

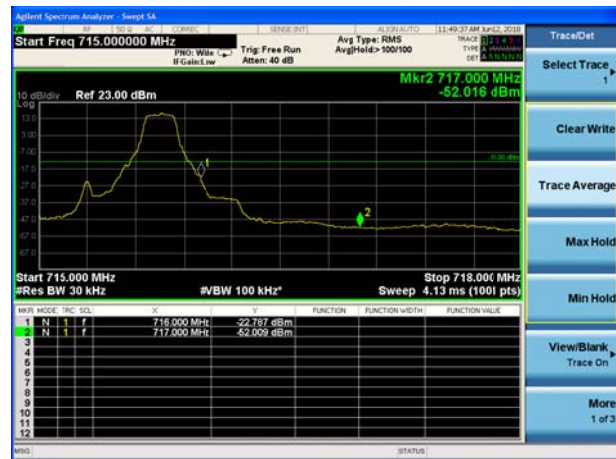



LTE Band 12 16QAM 3MHz CH-Low, 1 RB

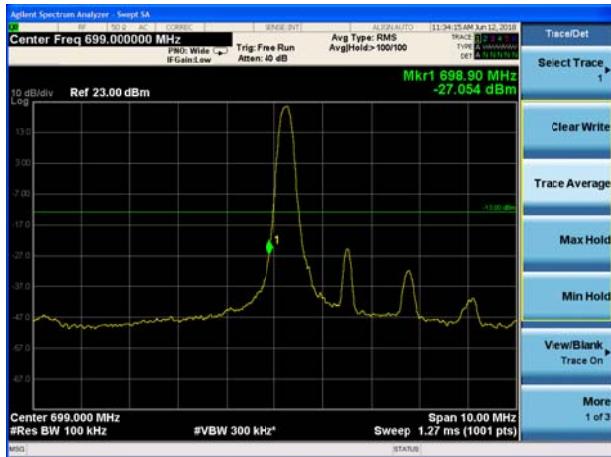

LTE Band 12 16QAM 3MHz CH-High, 1 RB

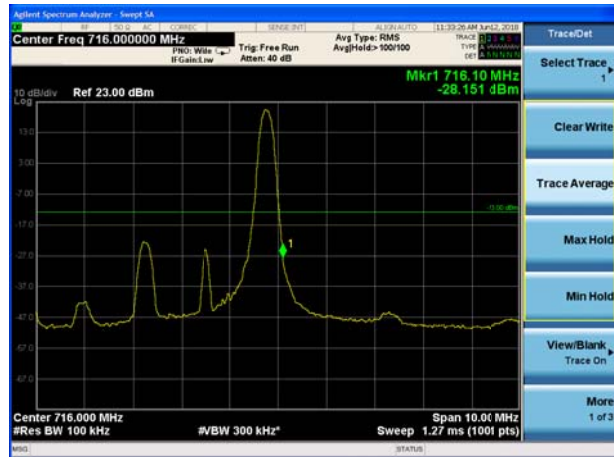

LTE Band 12 16QAM 3MHz CH-Low, 1 RB 698MHz~699MHz

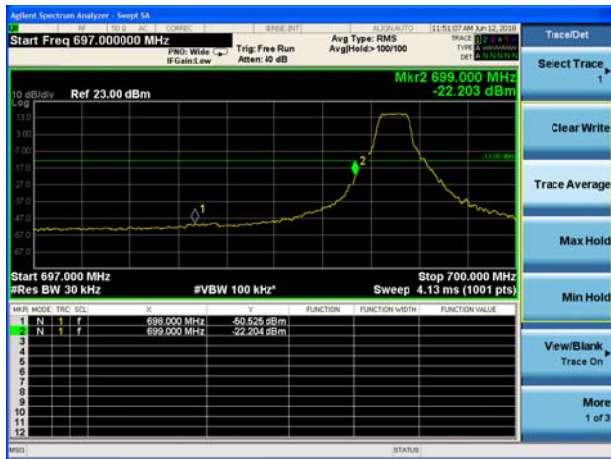

LTE Band 12 16QAM 3MHz CH-High, 1 RB 716MHz~717MHz

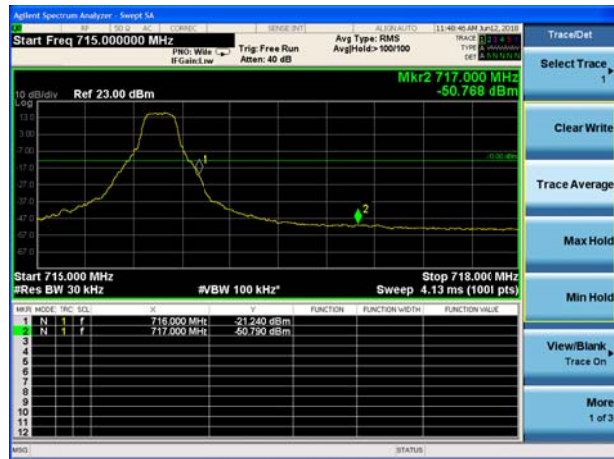

LTE Band 12 16QAM 5MHz CH-Low, 1 RB

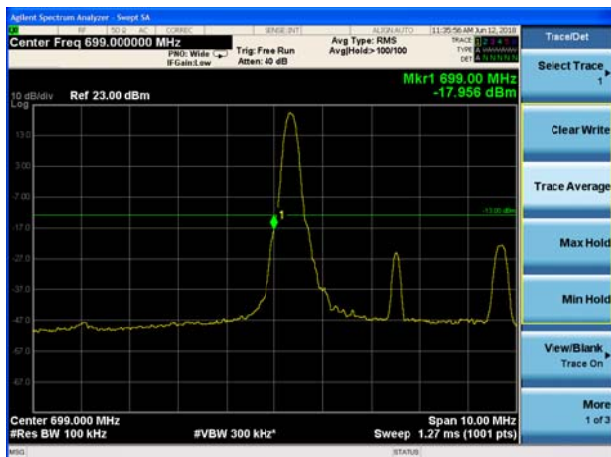

LTE Band 12 16QAM 5MHz CH-High, 1 RB

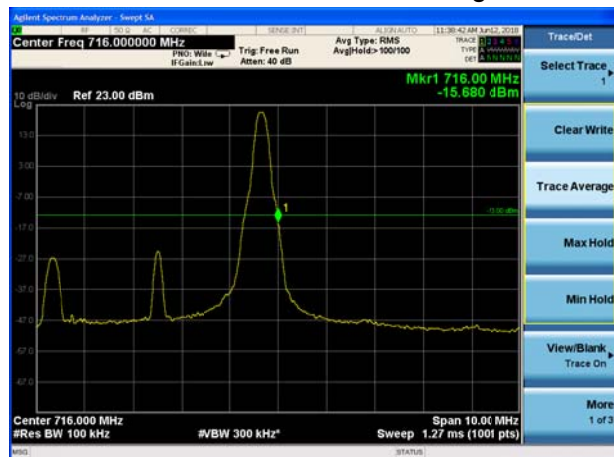

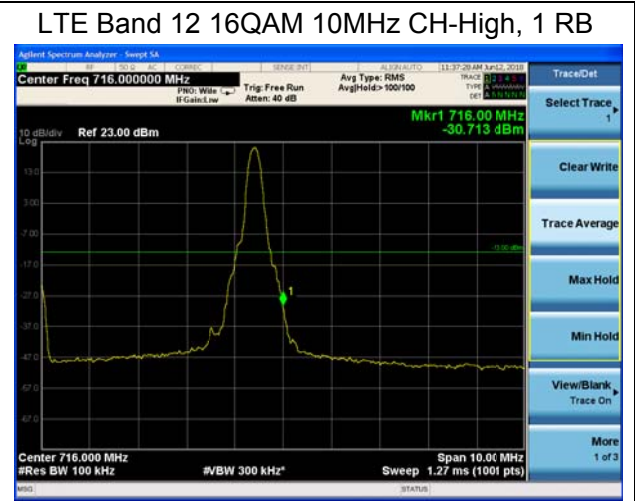
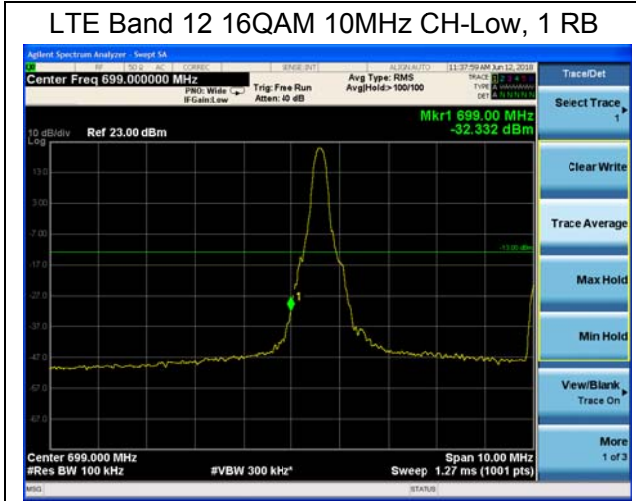

Variant:

LTE Band 13 QPSK 5MHz CH-Low, 1 RB

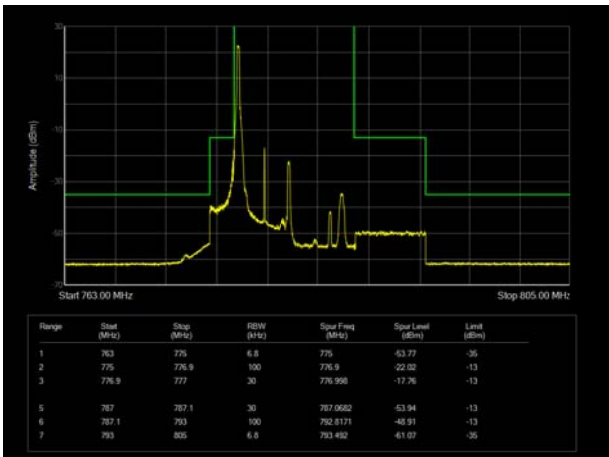

LTE Band 13 QPSK 5MHz CH-High, 1 RB

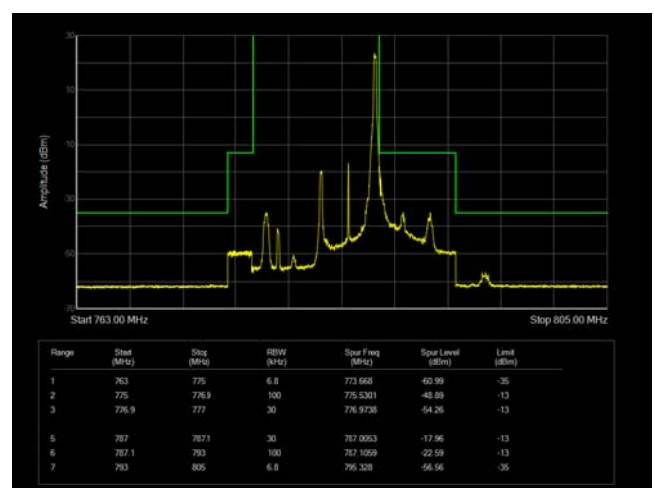

LTE Band 13 QPSK 5MHz CH-Low, 100%RB

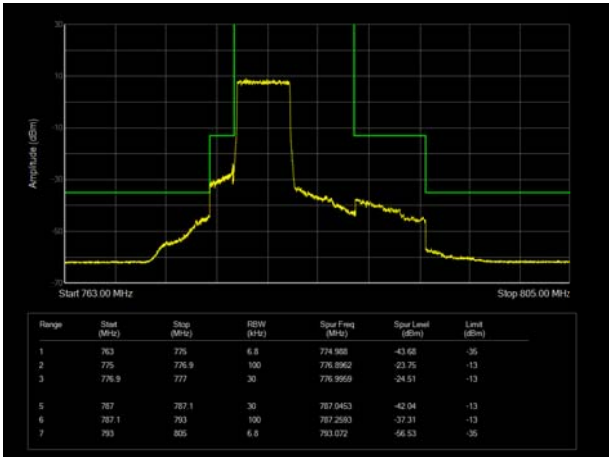

LTE Band 13 QPSK 5MHz CH-High, 100%RB

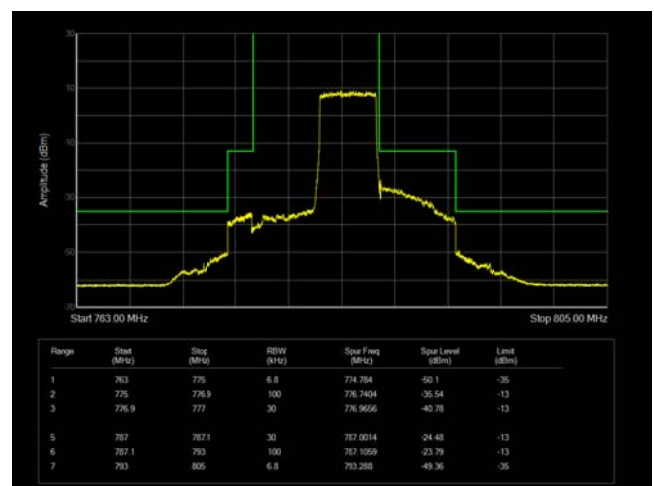

LTE Band 13 QPSK 10MHz CH-Low, 1 RB

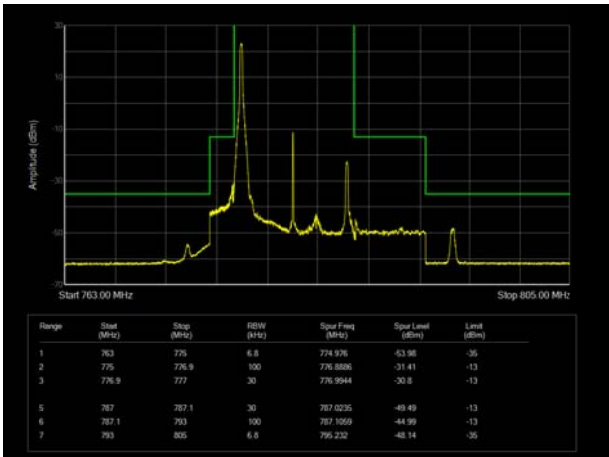

LTE Band 13 QPSK 10MHz CH-High, 1 RB

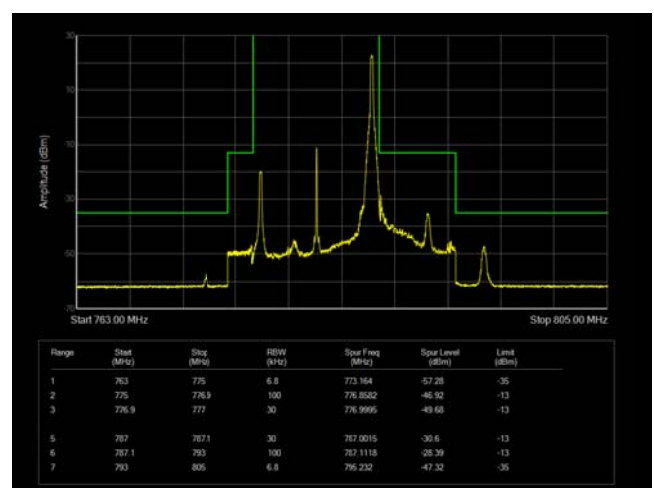



LTE Band 13 QPSK 10MHz CH-Middle, 100% RB

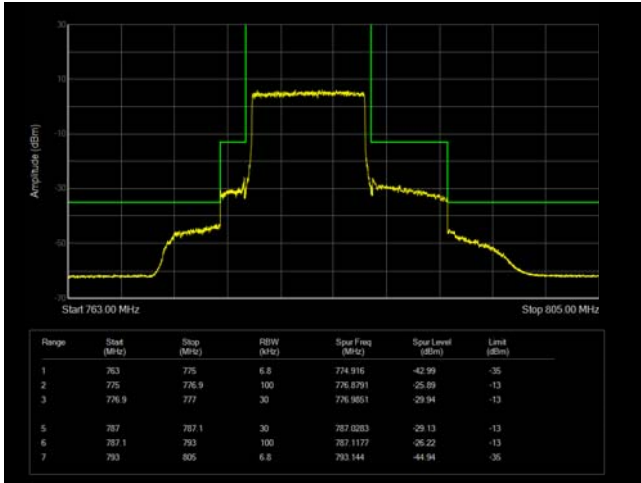

LTE Band 13 16QAM 5MHz CH-Low, 1 RB

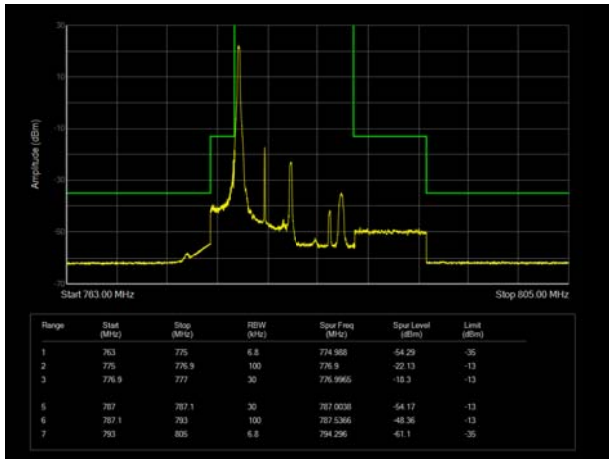

LTE Band 13 16QAM 5MHz CH-High, 1 RB

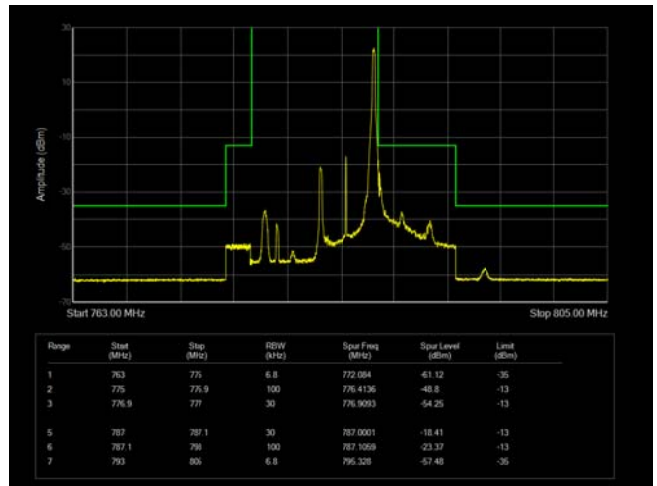

LTE Band 13 16QAM 5MHz CH-Low, 100% RB

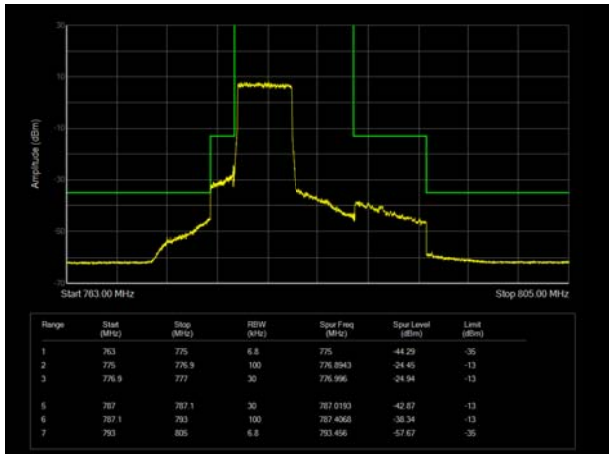

LTE Band 13 16QAM 5MHz CH-High, 100% RB

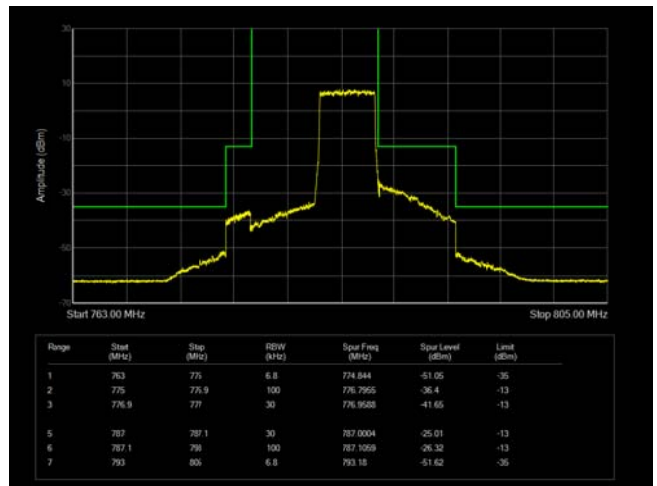



LTE Band 13 16QAM 10MHz CH-Low, 1 RB

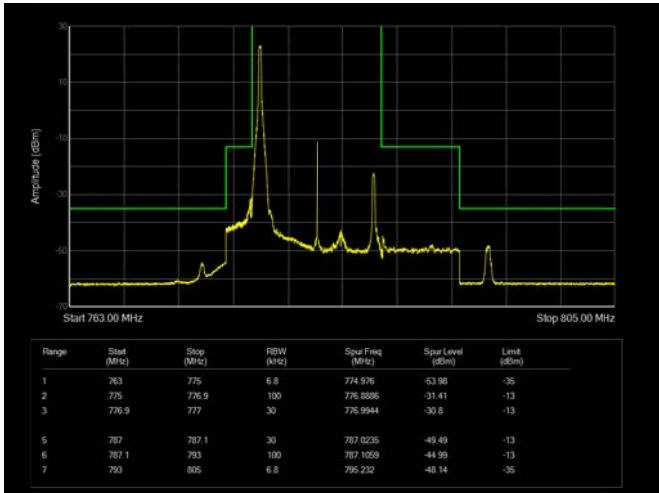

LTE Band 13 16QAM 10MHz CH-High, 1 RB

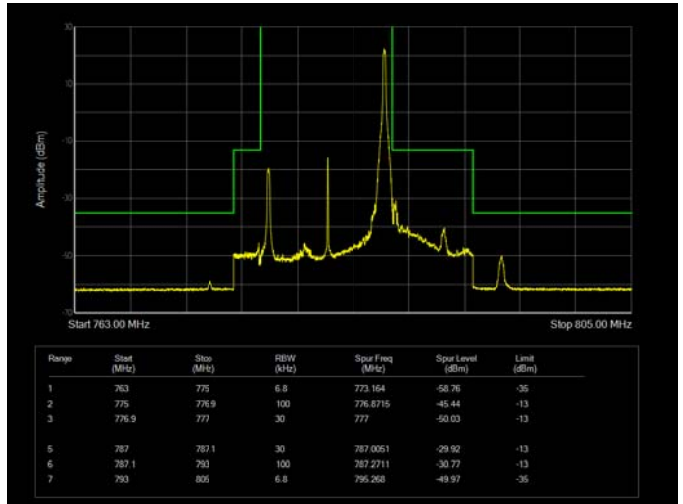

LTE Band 13 16QAM 10MHz CH-Middle, 100% RB

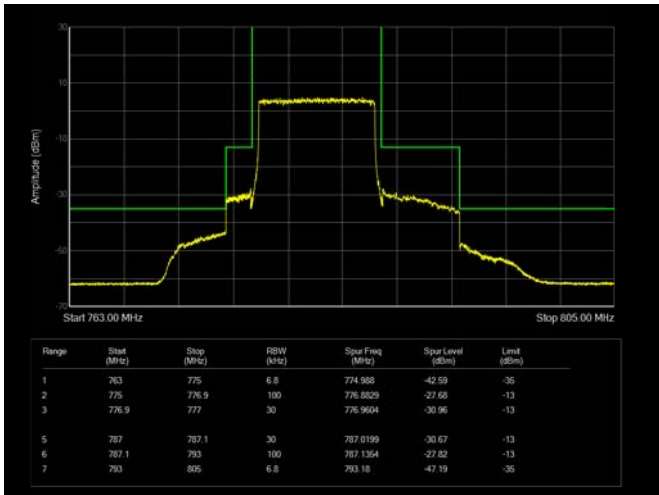

5.5 Peak-to-Average Power Ratio (PAPR)

Ambient condition

Temperature	Relative humidity	Pressure
23°C ~25°C	45%~50%	101.5kPa

Methods of Measurement

Measure the total peak power and record as Ppk. And measure the total average power and record as PAvg. Both the peak and average power levels must be expressed in the same logarithmic units (e.g., dBm). Determine the PAPR from:

$$PAPR (dB) = Ppk (dBm) - PAvg (dBm).$$

Test Setup

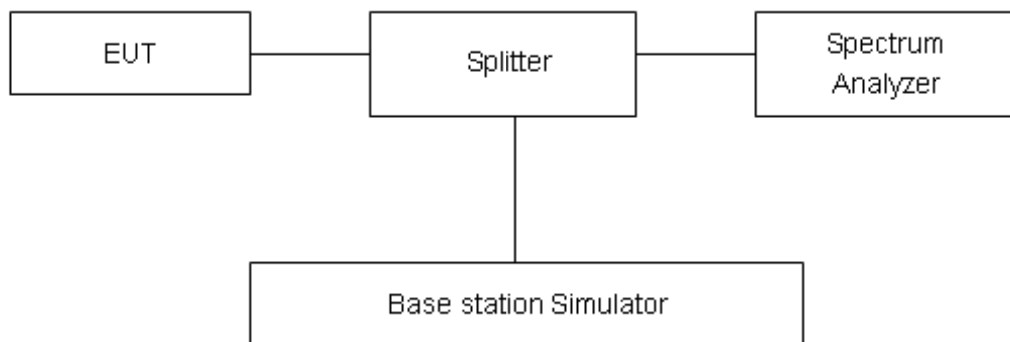

Limits

Rule Part 27.50(d)(5) Equipment employed must be authorized in accordance with the provisions of 24.51. Power measurements for transmissions by stations authorized under this section may be made either in accordance with a Commission-approved average power technique or in compliance with paragraph (d)(6) of this section. In measuring transmissions in this band using an average power technique, the peak-to-average ratio (PAR) of the transmission may not exceed 13 dB.

Measurement Uncertainty

The assessed measurement uncertainty to ensure 95% confidence level for the normal distribution is with the coverage factor k = 2, U= 0.4 dB.

Test Results

WCDMA Band IV	Channel	Frequency (MHz)	Peak (dBm)	Avg (dBm)	PAPR (dB)	Limit (dB)	Conclusion
RMC	1312	1712.4	26.69	23.57	3.12	≤13	PASS
	1413	1732.6	26.78	23.56	3.22	≤13	PASS
	1513	1752.6	26.33	23.51	2.82	≤13	PASS

LTE Band 4								
Modulation	Bandwidth (MHz)	Channel	Frequency (MHz)	Peak (dBm)	Avg (dBm)	PAPR (dB)	Limit (dB)	Conclusion
QPSK	1.4	19957	1710.7	28.43	23.06	5.37	≤13	PASS
		20175	1732.5	28.31	22.95	5.36	≤13	PASS
		20393	1754.3	28.39	22.98	5.41	≤13	PASS
	3	19965	1711.5	27.92	22.79	5.13	≤13	PASS
		20175	1732.5	28.21	23.06	5.15	≤13	PASS
		20385	1753.5	28.13	22.93	5.20	≤13	PASS
	5	19975	1712.5	28.31	22.77	5.54	≤13	PASS
		20175	1732.5	28.54	23.05	5.49	≤13	PASS
		20375	1752.5	28.51	22.91	5.60	≤13	PASS
	10	20000	1715	28.02	22.85	5.17	≤13	PASS
		20175	1732.5	28.18	23.07	5.11	≤13	PASS
		20350	1750	28.17	22.95	5.22	≤13	PASS
	15	20025	1717.5	29.16	22.83	6.33	≤13	PASS
		20175	1732.5	29.36	23.03	6.33	≤13	PASS
		20325	1747.5	29.30	22.90	6.40	≤13	PASS
20	20050	1720	28.99	22.80	6.19	≤13	PASS	
	20175	1732.5	29.18	22.98	6.20	≤13	PASS	
	20300	1745	29.17	22.86	6.31	≤13	PASS	
16QAM	1.4	19957	1710.7	29.81	23.39	6.42	≤13	PASS
		20175	1732.5	29.39	23.01	6.38	≤13	PASS
		20393	1754.3	29.41	22.93	6.48	≤13	PASS
	3	19965	1711.5	29.11	22.89	6.22	≤13	PASS
		20175	1732.5	28.83	22.67	6.16	≤13	PASS
		20385	1753.5	29.90	23.60	6.30	≤13	PASS
	5	19975	1712.5	28.13	22.66	5.47	≤13	PASS
		20175	1732.5	28.84	22.92	5.92	≤13	PASS
		20375	1752.5	28.50	23.45	5.05	≤13	PASS
	10	20000	1715	29.16	22.88	6.28	≤13	PASS
		20175	1732.5	28.06	22.66	5.40	≤13	PASS
		20350	1750	28.68	23.59	5.09	≤13	PASS



	15	20025	1717.5	28.11	22.83	5.28	≤13	PASS
		20175	1732.5	28.46	22.64	5.82	≤13	PASS
		20325	1747.5	29.47	23.57	5.90	≤13	PASS
	20	20050	1720	29.53	22.81	6.72	≤13	PASS
		20175	1732.5	29.58	22.60	6.98	≤13	PASS
		20300	1745	29.42	23.52	5.90	≤13	PASS

LTE Band 12								
Modulation	Bandwidth (MHz)	Channel	Frequency (MHz)	Peak (dBm)	Avg (dBm)	PAPR (dB)	Limit (dB)	Conclusion
QPSK	1.4	23017	699.7	28.93	22.70	6.23	≤13	PASS
		23095	707.5	29.11	22.78	6.33	≤13	PASS
		23173	715.3	29.61	22.83	6.78	≤13	PASS
	3	23025	700.5	29.81	22.85	6.96	≤13	PASS
		23095	707.5	29.14	22.93	6.21	≤13	PASS
		23165	714.5	29.37	22.99	6.38	≤13	PASS
	5	23035	701.5	29.98	22.83	7.15	≤13	PASS
		23095	707.5	29.62	22.89	6.73	≤13	PASS
		23155	713.5	29.69	22.94	6.75	≤13	PASS
	10	23060	704	30.81	22.80	8.01	≤13	PASS
		23095	707.5	29.19	22.84	6.35	≤13	PASS
		23130	711	29.24	22.90	6.34	≤13	PASS
16QAM	1.4	23017	699.7	30.96	23.53	7.43	≤13	PASS
		23095	707.5	30.33	23.16	7.17	≤13	PASS
		23173	715.3	30.29	22.71	7.58	≤13	PASS
	3	23025	700.5	30.01	22.59	7.42	≤13	PASS
		23095	707.5	30.71	23.27	7.44	≤13	PASS
		23165	714.5	29.94	22.84	7.10	≤13	PASS
	5	23035	701.5	29.53	22.54	6.99	≤13	PASS
		23095	707.5	30.74	23.25	7.49	≤13	PASS
		23155	713.5	30.27	22.82	7.45	≤13	PASS
	10	23060	704	30.27	22.52	7.75	≤13	PASS
		23095	707.5	30.30	23.21	7.09	≤13	PASS
		23130	711	30.28	22.77	7.51	≤13	PASS



LTE Band 13								
Modulation	Bandwidth (MHz)	Channel	Frequency (MHz)	Peak (dBm)	Avg (dBm)	PAPR (dB)	Limit (dB)	Conclusion
QPSK	5	23205	779.5	29.31	22.76	6.55	≤13	PASS
		23230	782	30.14	22.78	7.36	≤13	PASS
		23255	784.5	29.72	22.89	6.83	≤13	PASS
	10	23230	782	28.43	22.74	5.69	≤13	PASS
16QAM	5	23205	779.5	29.04	22.88	6.16	≤13	PASS
		23230	782	28.95	22.86	6.09	≤13	PASS
		23255	784.5	29.33	22.46	6.87	≤13	PASS
	10	23230	782	29.64	22.98	6.66	≤13	PASS

5.6 Frequency Stability

Ambient condition

Temperature	Relative humidity	Pressure
23°C ~25°C	45%~50%	101.5kPa

Method of Measurement

Frequency Stability (Temperature Variation)

The temperature inside the climate chamber is varied from -40°C to +85°C in 10°C step size.

(1) With all power removed, the temperature was decreased to -10°C and permitted to stabilize for three hours.

(2) Measure the carrier frequency with the test equipment in a “call mode”. These measurements should be made within 1 minute of powering up the mobile station, to prevent significant self warming.

(3) Repeat the above measurements at 10°C increments from -40°C to +85°C. Allow at least 1.5 hours at each temperature, un-powered, before making measurements.

Frequency Stability (Voltage Variation)

The frequency stability shall be measured with variation of primary supply voltage as follows:

(1) Vary primary supply voltage from 85 to 115 percent of the nominal value for other than hand carried battery equipment.

(2) For hand carried, battery powered equipment, reduce primary supply voltage to the battery-operating end point which shall be specified by the manufacturer.

This transceiver is specified to operate with an input voltage of between 3.3 V and 4.3 V, with a nominal voltage of 3.8V.

Test setup

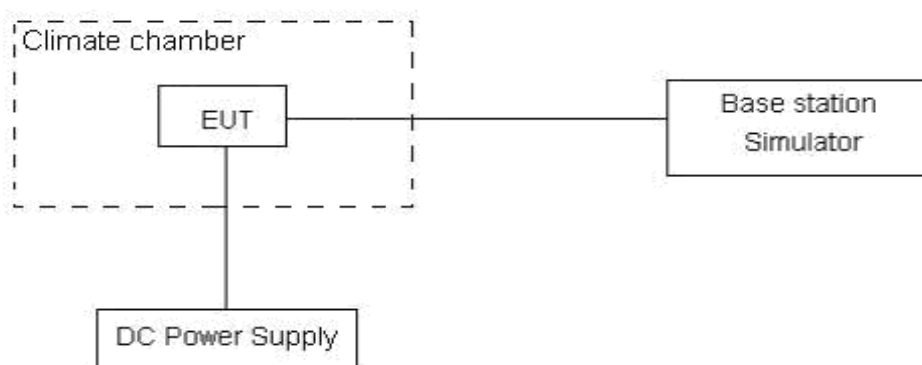

Limits

No specific frequency stability requirements in part 27.54

Measurement Uncertainty

The assessed measurement uncertainty to ensure 99.75% confidence level for the normal distribution is with the coverage factor $k = 3, U=0.01\text{ppm}$.

Test Result
Variants:

WCDMA Band IV						
Condition		Freq.Error (Hz)	Freq.Error (Hz)	Frequency Stability (ppm)	Frequency Stability (ppm)	Verdict
Temperature	Voltage	BPSK	QPSK	BPSK	QPSK	
Normal (25°C)	Normal	2.34	17.28	0.00125	0.00919	PASS
Extreme (85°C)		11.32	13.47	0.00602	0.00716	PASS
Extreme (80°C)		2.64	8.81	0.00140	0.00469	PASS
Extreme (70°C)		9.21	11.84	0.00490	0.00630	PASS
Extreme (60°C)		5.36	14.51	0.00285	0.00772	PASS
Extreme (50°C)		8.53	14.14	0.00454	0.00752	PASS
Extreme (40°C)		5.57	5.94	0.00296	0.00316	PASS
Extreme (30°C)		5.22	5.28	0.00278	0.00281	PASS
Extreme (20°C)		9.99	7.61	0.00532	0.00405	PASS
Extreme (10°C)		12.36	4.43	0.00657	0.00235	PASS
Extreme (0°C)		16.44	1.30	0.00874	0.00069	PASS
Extreme (-10°C)		8.07	2.65	0.00429	0.00141	PASS
Extreme (-20°C)		14.80	17.46	0.00787	0.00929	PASS
Extreme (-30°C)		10.73	5.87	0.00571	0.00312	PASS
Extreme (-40°C)		5.92	16.46	0.00315	0.00875	PASS
25°C	LV	17.89	14.17	0.00951	0.00754	PASS
	HV	14.63	9.22	0.00778	0.00490	PASS

LTE Band 4						
Condition		Freq.Error (Hz)	Freq.Error (Hz)	Frequency Stability (ppm)	Frequency Stability (ppm)	Verdict
BANDWIDTH	20MHz					
Temperature	Voltage	16QAM	QPSK	16QAM	QPSK	
Normal (25°C)	Normal	13.43	16.39	0.00714	0.00872	PASS
Extreme (85°C)		5.60	8.06	0.00298	0.00429	PASS
Extreme (80°C)		8.51	15.57	0.00452	0.00828	PASS
Extreme (70°C)		3.74	6.56	0.00199	0.00349	PASS
Extreme (60°C)		8.24	11.66	0.00438	0.00620	PASS
Extreme (50°C)		9.25	10.47	0.00492	0.00557	PASS
Extreme (40°C)		12.56	6.58	0.00668	0.00350	PASS
Extreme (30°C)		9.33	12.85	0.00496	0.00684	PASS
Extreme (20°C)		8.68	8.98	0.00462	0.00478	PASS
Extreme (10°C)		2.10	17.01	0.00112	0.00905	PASS
Extreme (0°C)		8.28	12.41	0.00441	0.00660	PASS
Extreme (-10°C)		1.04	7.76	0.00055	0.00413	PASS
Extreme (-20°C)		12.95	16.06	0.00689	0.00854	PASS
Extreme (-30°C)		1.99	10.63	0.00106	0.00565	PASS
Extreme (-40°C)		16.96	17.20	0.00902	0.00915	PASS
25°C		LV	3.67	14.67	0.00195	0.00780
	HV	3.52	4.05	0.00187	0.00215	PASS

LTE Band 12						
Condition		Freq.Error (Hz)	Freq.Error (Hz)	Frequency Stability (ppm)	Frequency Stability (ppm)	Verdict
BANDWIDTH	10MHz					
Temperature	Voltage	16QAM	QPSK	16QAM	QPSK	
Normal (25°C)	Normal	12.72	2.90	0.00677	0.00154	PASS
Extreme (85°C)		14.95	14.24	0.00795	0.00758	PASS
Extreme (80°C)		7.58	14.46	0.00403	0.00769	PASS
Extreme (70°C)		17.11	17.99	0.00910	0.00957	PASS
Extreme (60°C)		2.13	16.08	0.00113	0.00856	PASS
Extreme (50°C)		1.79	3.07	0.00095	0.00164	PASS
Extreme (40°C)		12.92	9.15	0.00687	0.00487	PASS
Extreme (30°C)		8.81	17.54	0.00468	0.00933	PASS
Extreme (20°C)		13.16	13.03	0.00700	0.00693	PASS
Extreme (10°C)		16.41	17.85	0.00873	0.00949	PASS
Extreme (0°C)		7.87	10.82	0.00418	0.00576	PASS
Extreme (-10°C)		6.43	8.63	0.00342	0.00459	PASS
Extreme (-20°C)		11.04	16.42	0.00587	0.00874	PASS
Extreme (-30°C)		15.48	7.57	0.00823	0.00403	PASS
Extreme (-40°C)		1.32	16.64	0.00070	0.00885	PASS
25°C	LV	13.69	15.07	0.00728	0.00801	PASS
	HV	11.41	2.85	0.00607	0.00152	PASS

LTE Band 13						
Condition		Freq.Error (Hz)	Freq.Error (Hz)	Frequency Stability (ppm)	Frequency Stability (ppm)	Verdict
BANDWIDTH	10MHz					
Temperature	Voltage	16QAM	QPSK	16QAM	QPSK	
Normal (25°C)	Normal	3.92	3.64	0.00208	0.00194	PASS
Extreme (85°C)		11.63	15.32	0.00619	0.00815	PASS
Extreme (80°C)		8.76	3.77	0.00466	0.00201	PASS
Extreme (70°C)		10.92	5.88	0.00581	0.00313	PASS
Extreme (60°C)		11.74	6.84	0.00624	0.00364	PASS
Extreme (50°C)		14.70	5.96	0.00782	0.00317	PASS
Extreme (40°C)		11.46	4.30	0.00610	0.00229	PASS
Extreme (30°C)		8.30	16.60	0.00441	0.00883	PASS
Extreme (20°C)		4.26	6.56	0.00227	0.00349	PASS
Extreme (10°C)		8.66	1.25	0.00461	0.00067	PASS
Extreme (0°C)		15.77	13.01	0.00839	0.00692	PASS
Extreme (-10°C)		3.34	5.57	0.00178	0.00296	PASS
Extreme (-20°C)		1.77	13.30	0.00094	0.00708	PASS
Extreme (-30°C)		2.48	14.15	0.00132	0.00753	PASS
Extreme (-40°C)		12.89	15.73	0.00686	0.00837	PASS
25°C		LV	17.54	1.28	0.00933	0.00068
	HV	10.13	12.64	0.00539	0.00672	PASS

5.7 Spurious Emissions at Antenna Terminals

Ambient condition

Temperature	Relative humidity	Pressure
23°C ~25°C	45%~50%	101.5kPa

Method of Measurement

The EUT was connected to Spectrum Analyzer and Base Station Simulator via power Splitter. The measurement is carried out using a spectrum analyzer. The spectrum analyzer scans from 9kHz to the 10th harmonic of the carrier. The peak detector is used.

RBW is set to 100kHz, VBW is set to 300kHz for 30MHz~1GHz

RBW is set to 1MHz, VBW is set to 3MHz for above 1GHz,

RBW is set to 1 kHz (0.009MHz~ 0.15 MHz) for LTE Band 4/12/13,

RBW is set to 10 kHz (0.15 MHz~ 30 MHz) for LTE Band 4/12/13,

RBW is set to 100 kHz (30MHz~1000 MHz) for LTE Band 4/12/13,

RBW is set to 1000 kHz (above 1000MHz) for LTE Band 4/12/13,

Sweep is set to ATUO.

Of those disturbances below (limit – 20 dB), the mark is not required for the EUT.

The modulation mode and RB allocation refer to section 5.1, using the maximum output power configuration.

Test setup

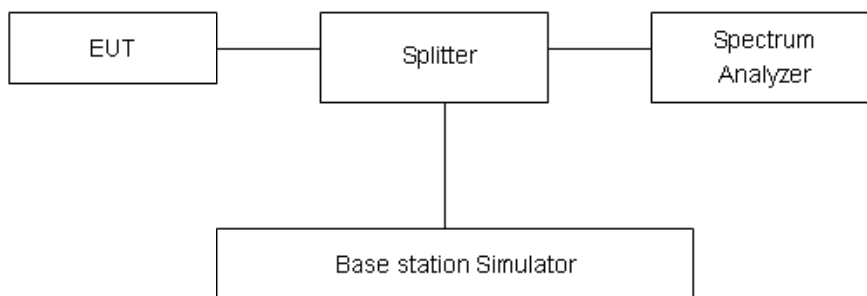

Limits

Rule Part 27.53(h) specifies that “for operations in the 1695-1710 MHz, 1710-1755 MHz, 1755-1780 MHz, 1915-1920 MHz, 1995-2000 MHz, 2000-2020 MHz, 2110-2155 MHz, 2155-2180 MHz, and 2180-2200 bands, the power of any emission outside a licensee's frequency block shall be attenuated below the transmitter power (P) in watts by at least $43 + 10 \log_{10} (P)$ dB..”

Rule Part 27.53 (g) For operations in the 600 MHz band and the 698-746 MHz band, the power of any emission outside a licensee's frequency band(s) of operation shall be attenuated below the transmitter power (P) within the licensed band(s) of operation, measured in watts, by at least $43 + 10 \log (P)$ dB. Compliance with this provision is based on the use of measurement instrumentation employing a resolution bandwidth of 100 kilohertz or greater. However, in the 100 kilohertz bands



immediately outside and adjacent to a licensee's frequency block, a resolution bandwidth of at least 30 kHz may be employed.

Rule Part 27.53(f) For operations in the 746-758 MHz, 775-788 MHz, and 805-806 MHz bands, emissions in the band 1559-1610 MHz shall be limited to -70 dBW/MHz equivalent isotropically radiated power (EIRP) for wideband signals, and -80 dBW EIRP for discrete emissions of less than 700 Hz bandwidth. For the purpose of equipment authorization, a transmitter shall be tested with an antenna that is representative of the type that will be used with the equipment in normal operation.

Part 27.53(h)/(g) Limit		-13 dBm
Part 27.53(f) Limit	Limit out of the band 1559-1610 MHz	-13 dBm
	Limit in the band 1559-1610 MHz	-40 dBm

Measurement Uncertainty

The assessed measurement uncertainty to ensure 99.75% confidence level for the normal distribution is with the coverage factor $k = 1.96$.

Frequency	Uncertainty
9kHz-1GHz	0.684 dB
1GHz-20GHz	1.407 dB

Test Result

Sweep the whole frequency band through the range from 9kHz to the 10th harmonic of the carrier, the emissions more than 20 dB below the limit are not reported.

The signal beyond the limit is carrier.

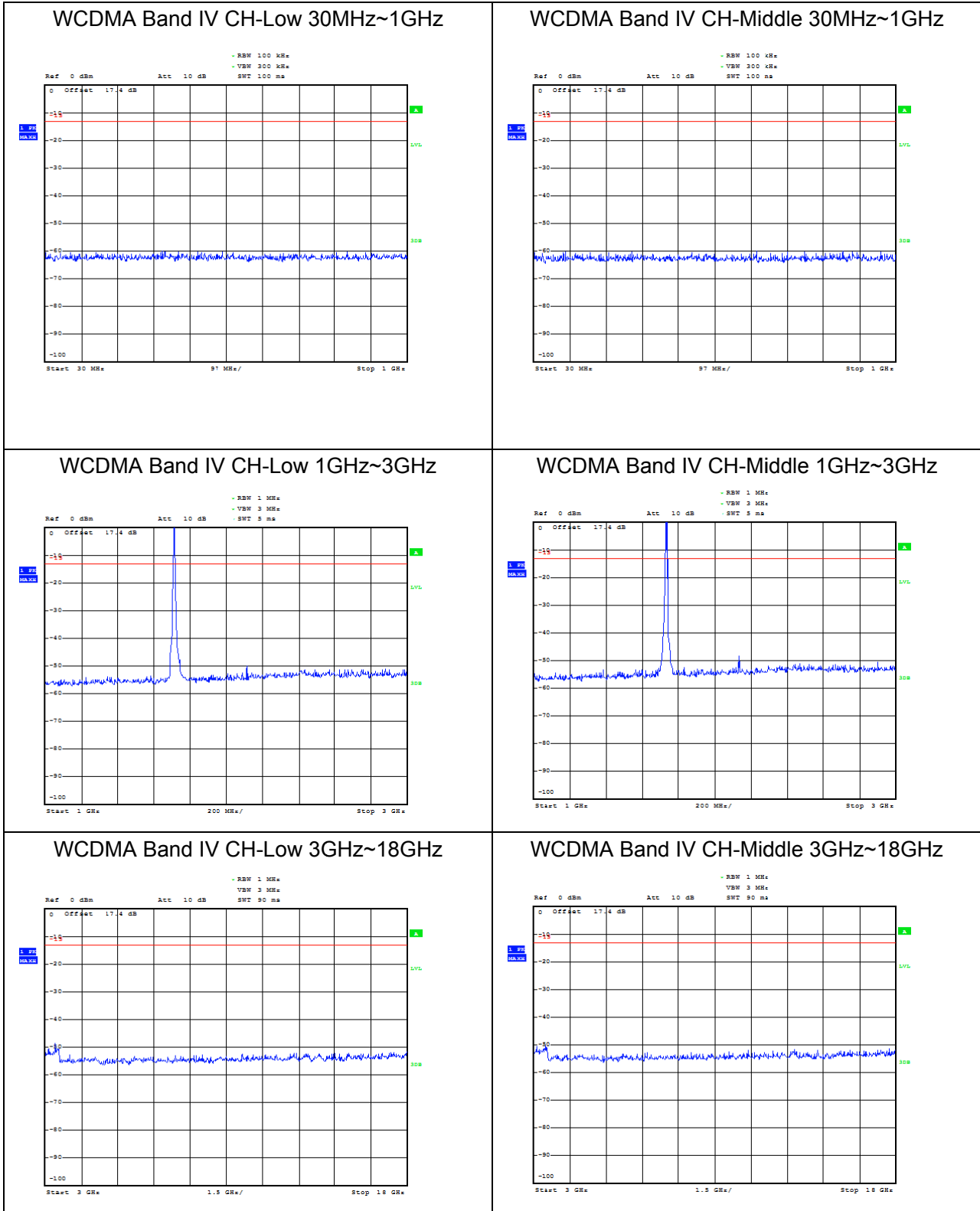



WCDMA Band IV CH-High 30MHz~1GHz

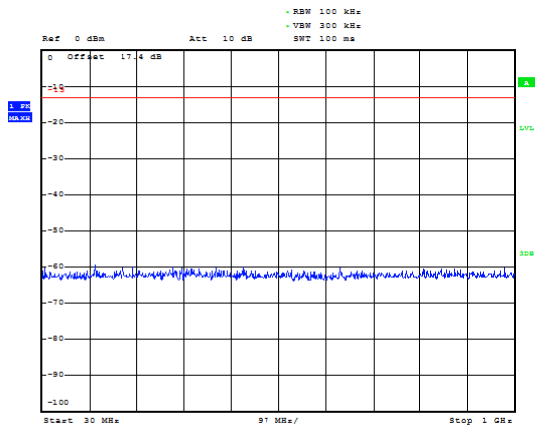

WCDMA Band IV CH-High 1GHz~3GHz

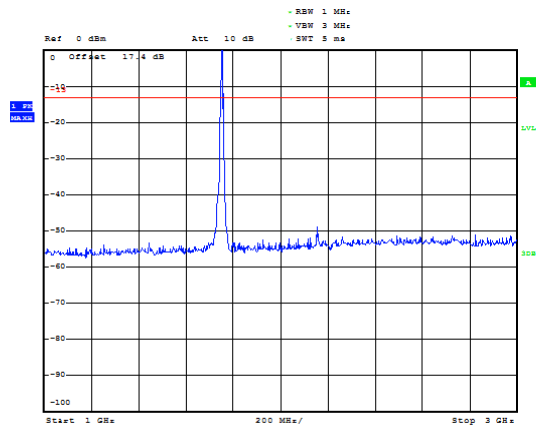

WCDMA Band IV CH-High 3GHz~18GHz

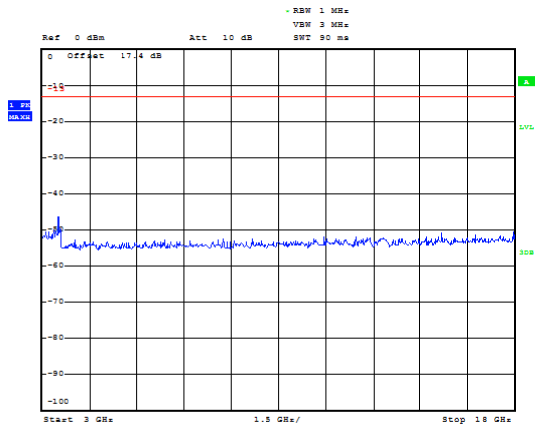

LTE Band 4 1.4MHz CH-Low 9kHz~20GHz

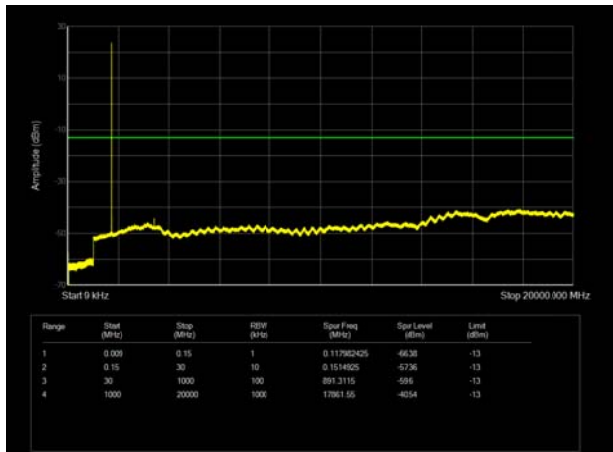

LTE Band 4 3MHz CH-Low 9kHz~20GHz

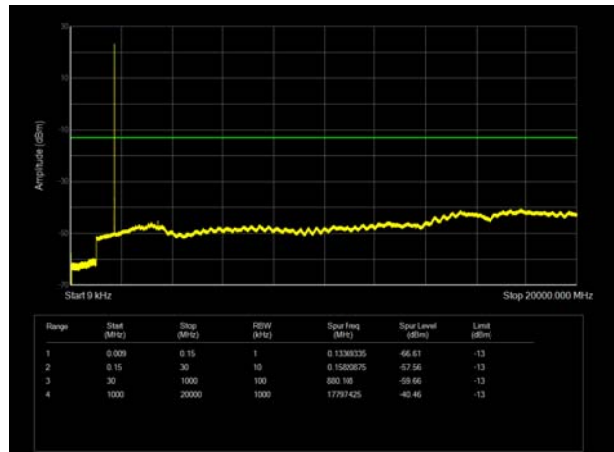

LTE Band 4 1.4MHz CH-Middle 9kHz~20GHz

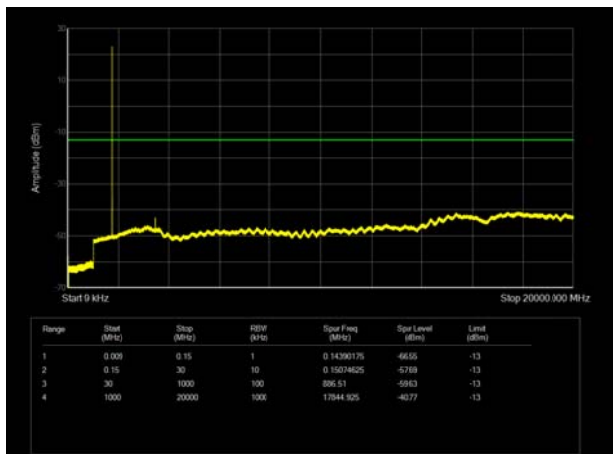

LTE Band 4 3MHz CH-Middle 9kHz~20GHz

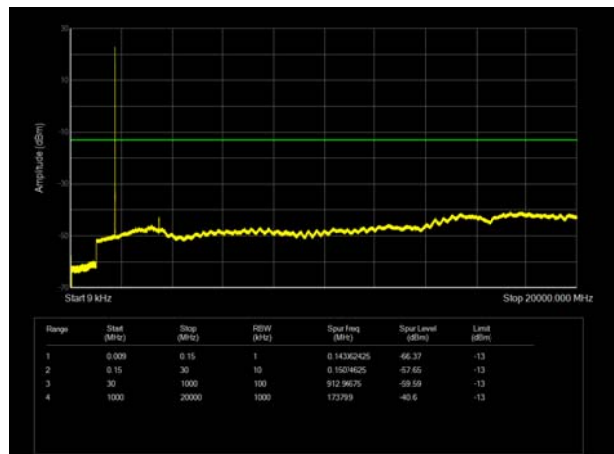

LTE Band 4 1.4MHz CH-High 9kHz~20GHz

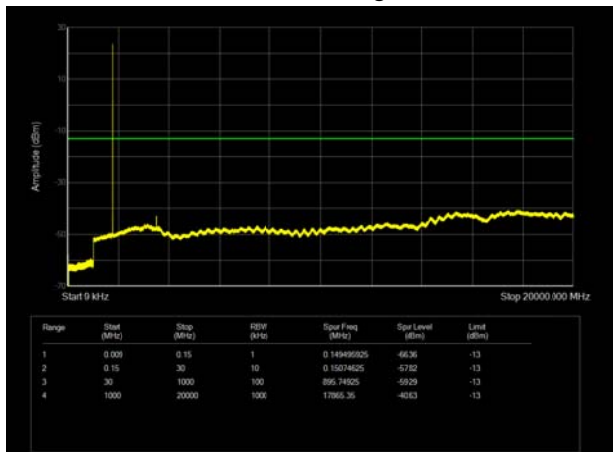

LTE Band 4 3MHz CH-High 9kHz~20GHz

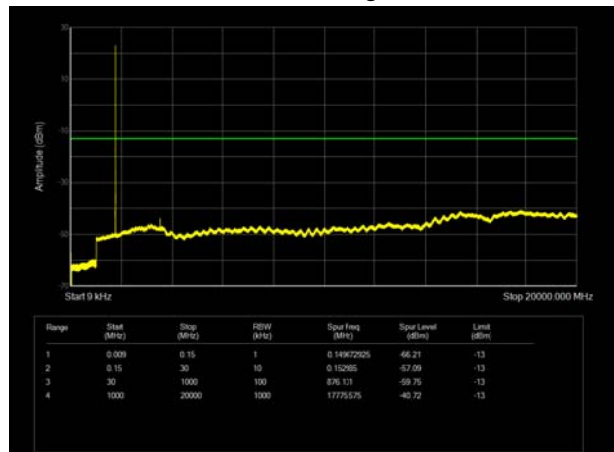

LTE Band 4 5MHz CH-Low 9kHz~20GHz

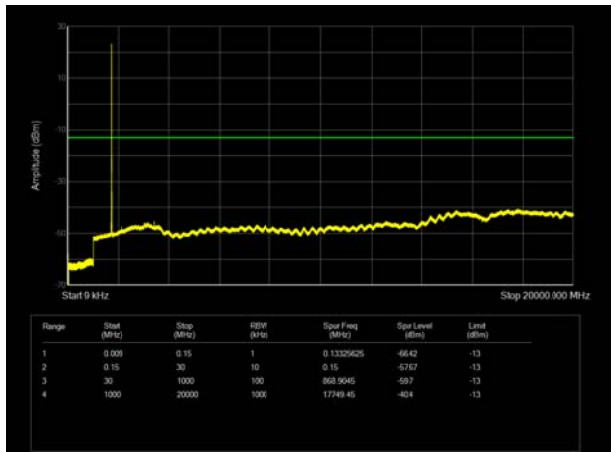

LTE Band 4 10MHz CH-Low 9kHz~20GHz

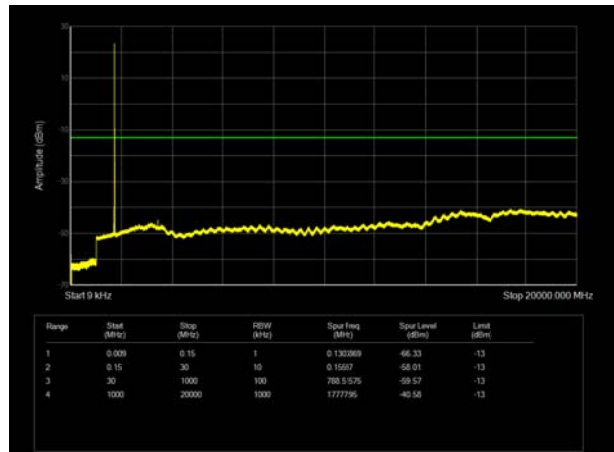

LTE Band 4 5MHz CH-Middle 9kHz~20GHz

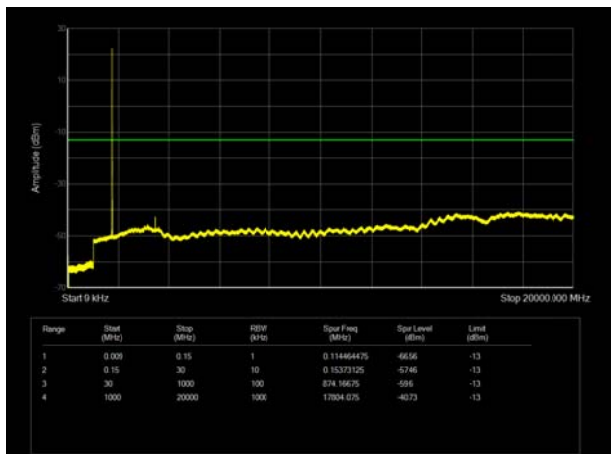

LTE Band 4 10MHz CH-Middle 9kHz~20GHz

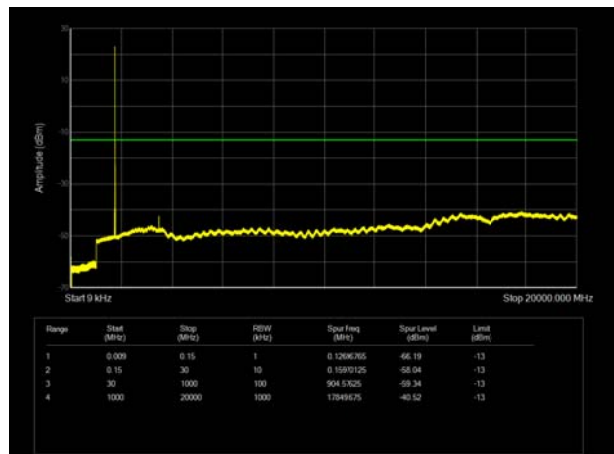

LTE Band 4 5MHz CH-High 9kHz~20GHz

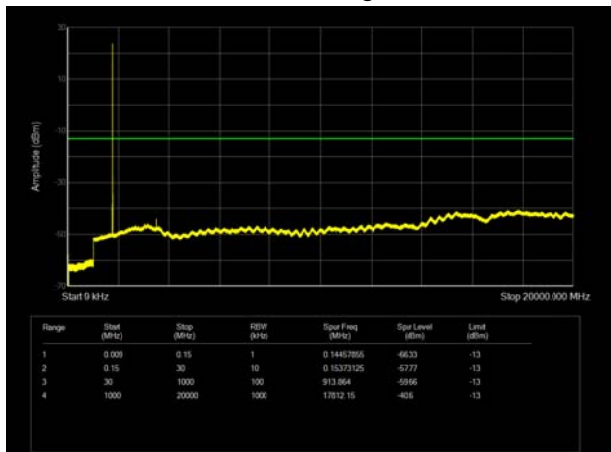

LTE Band 4 10MHz CH-High 9kHz~20GHz

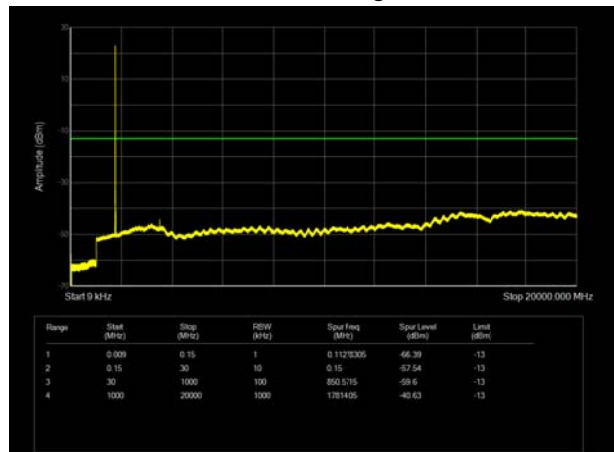

LTE Band 4 15MHz CH-Low 9kHz~20GHz

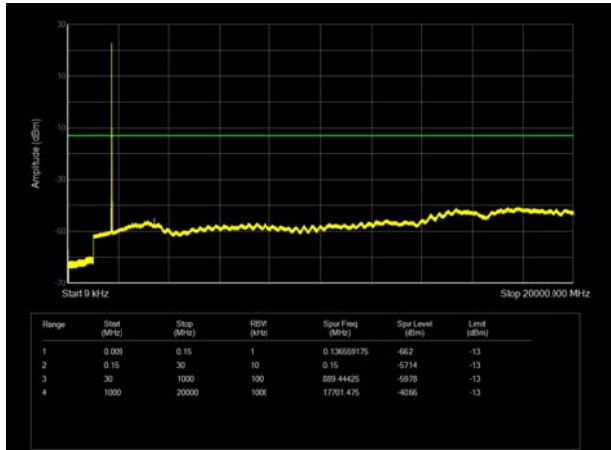

LTE Band 4 20MHz CH-Low 9kHz~20GHz

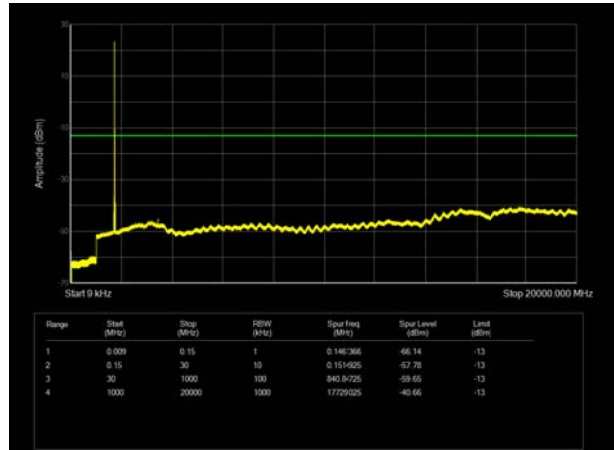

LTE Band 4 15MHz CH-Middle 9kHz~20GHz

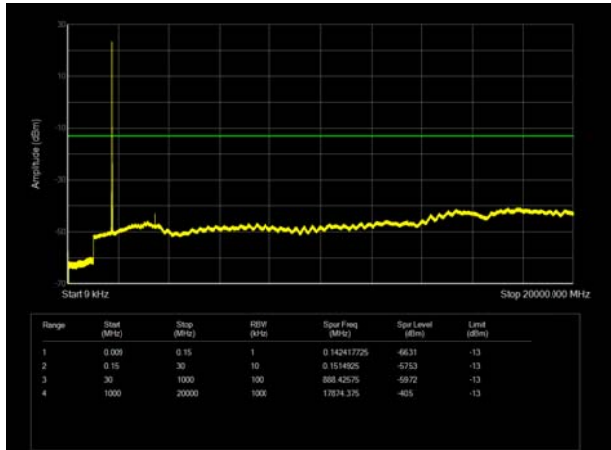

LTE Band 4 20MHz CH-Middle 9kHz~20GHz

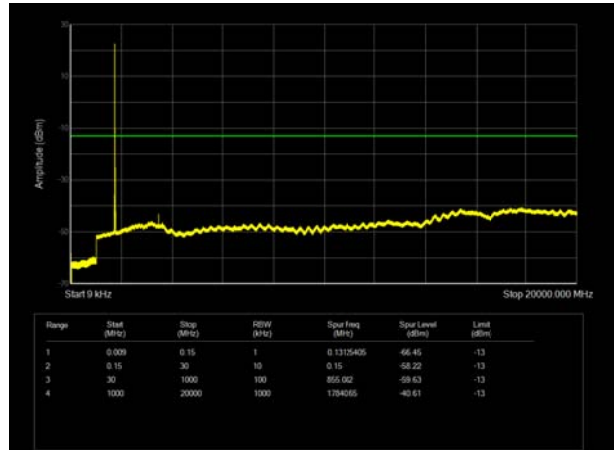

LTE Band 4 15MHz CH-High 9kHz~20GHz

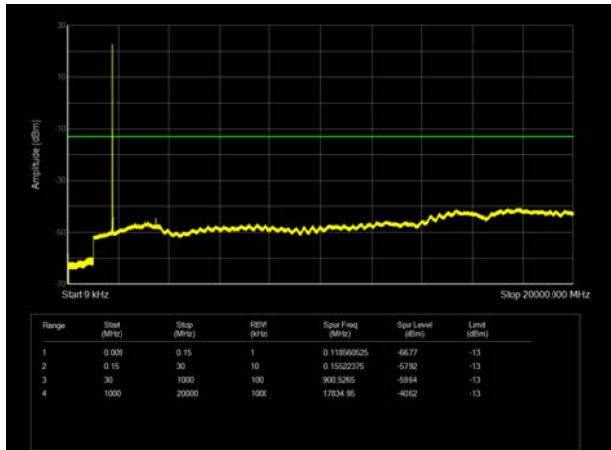

LTE Band 4 20MHz CH-High 9kHz~20GHz

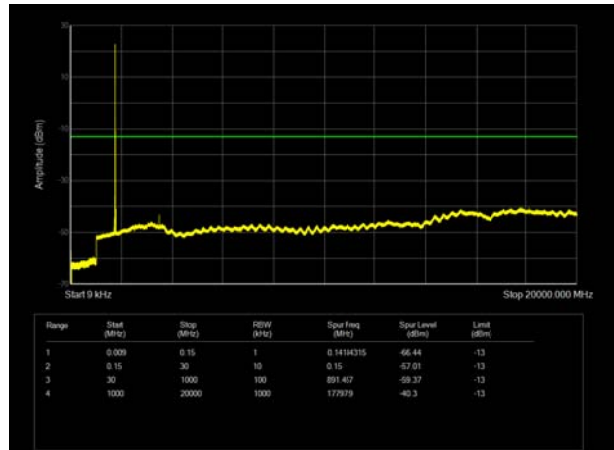

LTE Band 12 1.4MHz CH-Low 9kHz~10GHz

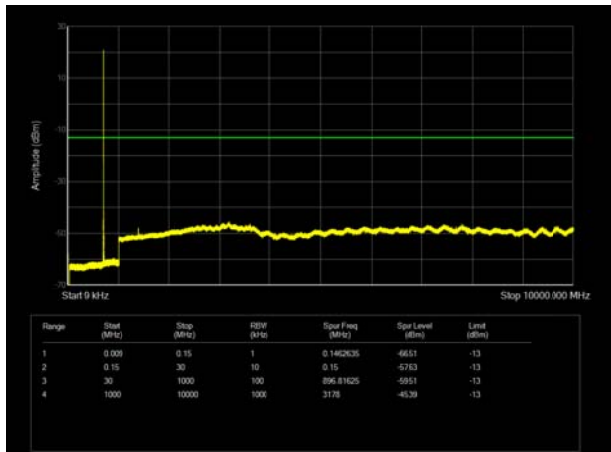

LTE Band 12 3MHz CH-Low 9kHz~10GHz

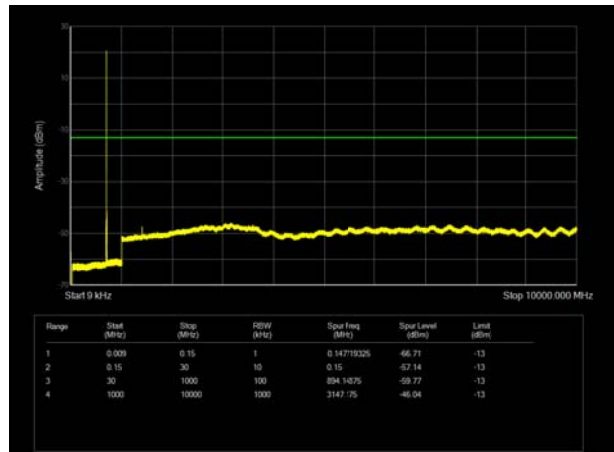

LTE Band 12 1.4MHz CH-Middle 9kHz~10GHz

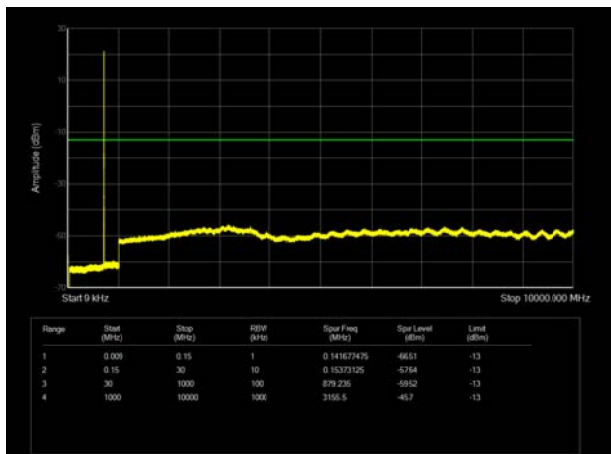

LTE Band 12 3MHz CH-Middle 9kHz~10GHz

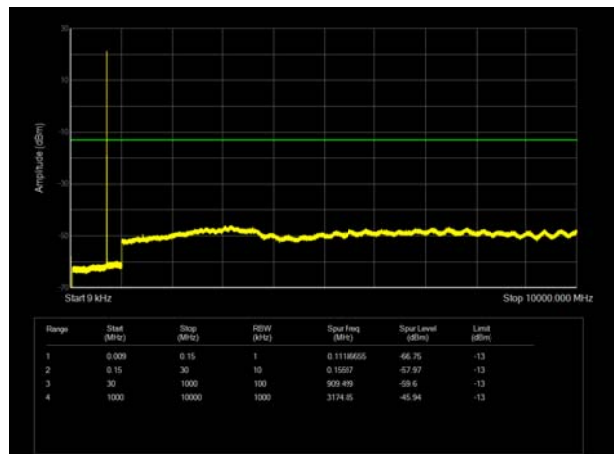

LTE Band 12 1.4MHz CH-High 9kHz~10GHz

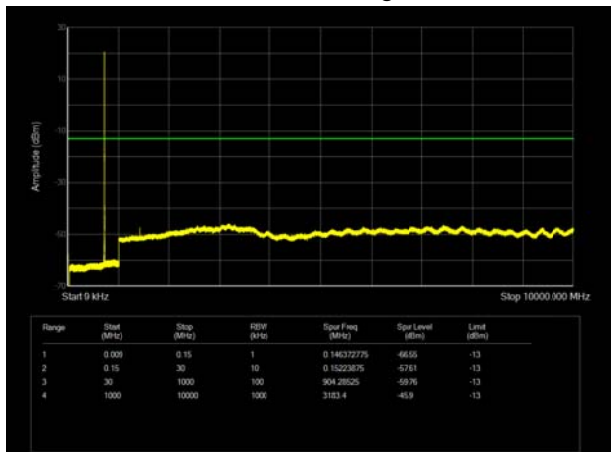

LTE Band 12 3MHz CH-High 9kHz~10GHz

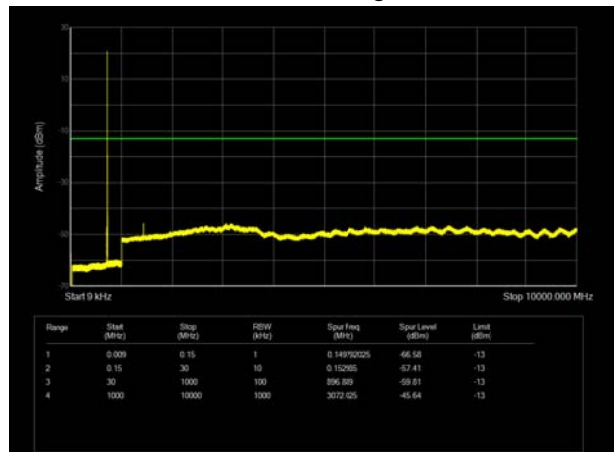



LTE Band 12 5MHz CH-Low 9kHz~10GHz

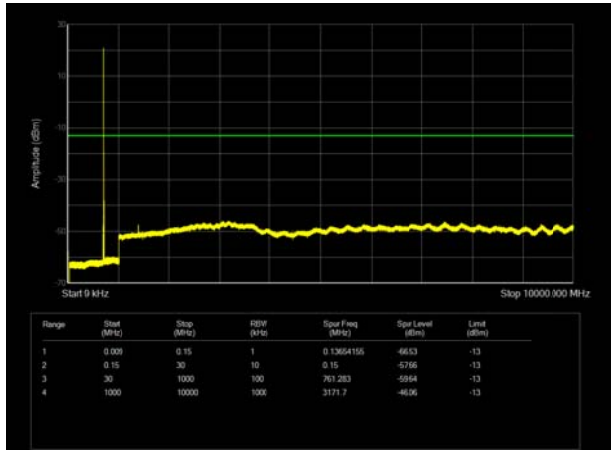

LTE Band 12 10MHz CH-Low 9kHz~10GHz

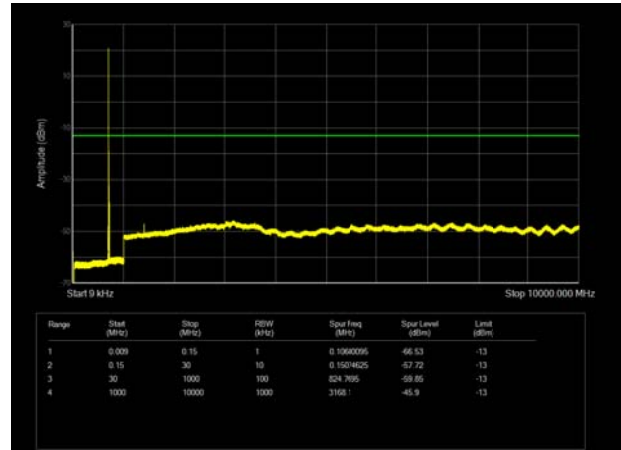

LTE Band 12 5MHz CH-Middle 9kHz~10GHz

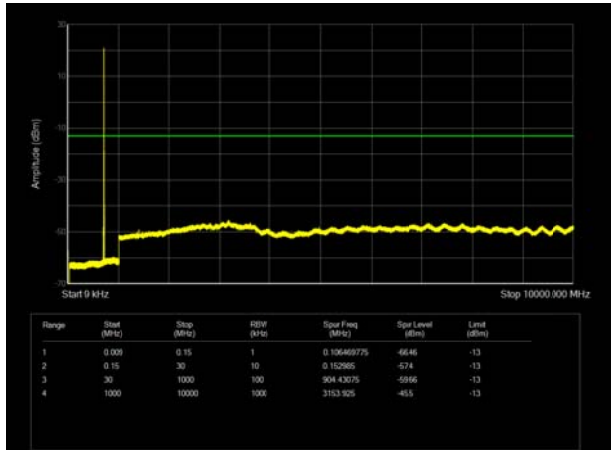

LTE Band 12 10MHz CH-Middle 9kHz~10GHz

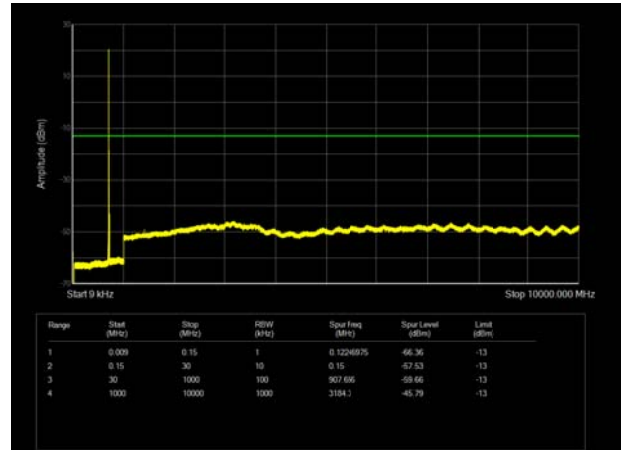

LTE Band 12 5MHz CH-High 9kHz~10GHz

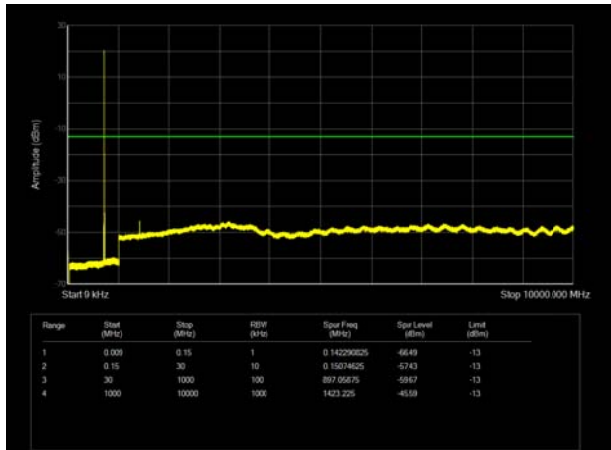

LTE Band 12 10MHz CH-High 9kHz~10GHz

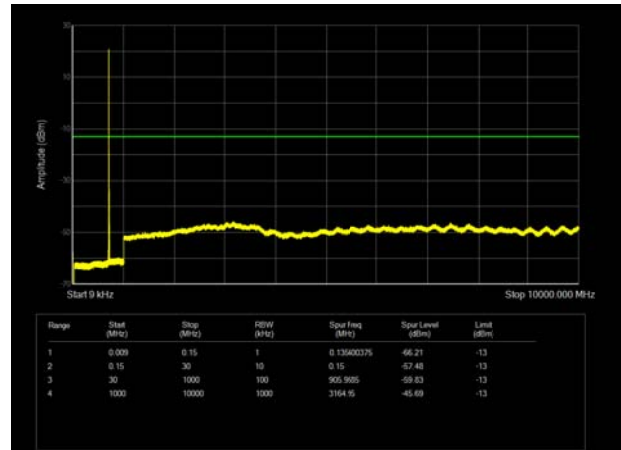

LTE Band 13 5MHz CH-Low 9kHz~10GHz

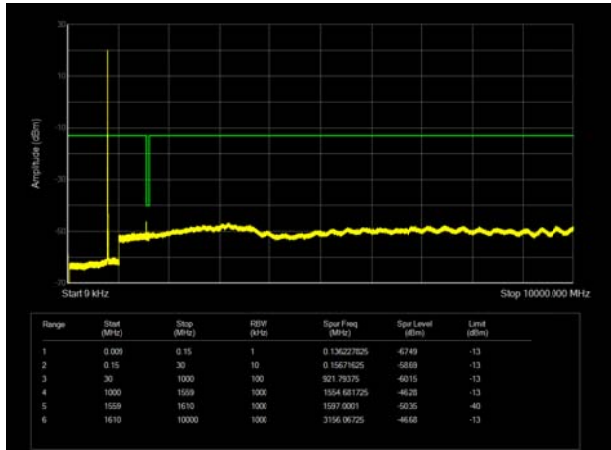

LTE Band 13 10MHz CH-Middle 9kHz~10GHz

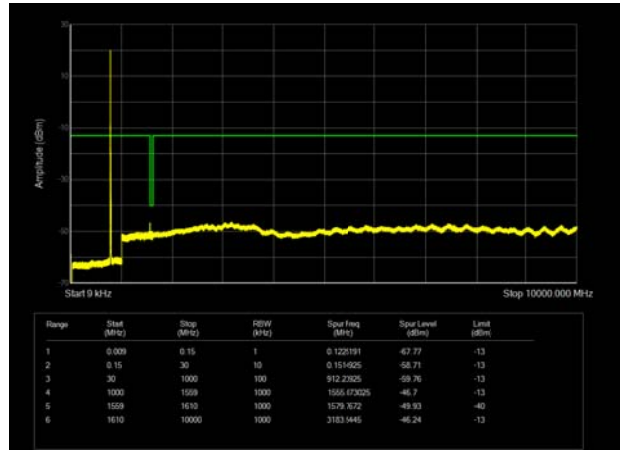

LTE Band 13 5MHz CH-Middle 9kHz~10GHz

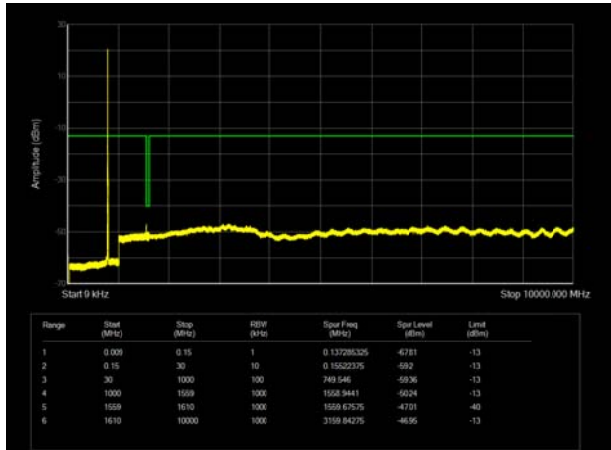

LTE Band 13 5MHz CH-High 9kHz~10GHz

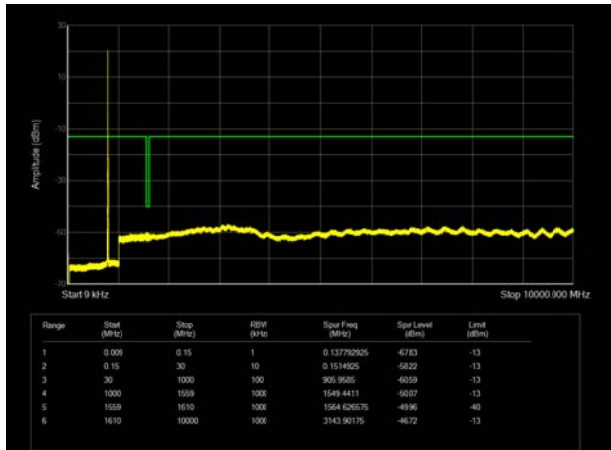

5.8 Radiates Spurious Emission

Ambient condition

Temperature	Relative humidity	Pressure
23°C ~25°C	45%~50%	101.5kPa

Method of Measurement

1. The testing follows FCC KDB 971168 D01 v03r01 Section 5.8 and ANSI/TIA-603-E (2016).
 2. The EUT is placed on a turntable 0.8 meters above the ground in the chamber, 3 meter away from the antenna. The maximal emission value is acquired by adjusting the antenna height, polarisation and turntable azimuth. Normally, the height range of antenna is 1 m to 4 m, the azimuth range of turntable is 0° to 360°, and the receive antenna has two polarizations Vertical (V) and Horizontal (H).
 3. A log-periodic antenna or double-ridged waveguide horn antenna shall be substituted in place of the EUT. The log-periodic antenna will be driven by a signal generator and the level will be adjusted till the same power value on the spectrum analyzer or receiver. The level of the spurious emissions can be calculated through the level of the signal generator, cable loss, the gain of the substitution antenna and the reading of the spectrum analyzer or receiver.
 4. The EUT is then put into continuously transmitting mode at its maximum power level during the test. Set Test Receiver or Spectrum RBW=1MHz, VBW=3MHz, And the maximum value of the receiver should be recorded as (Pr).
 5. The EUT shall be replaced by a substitution antenna. In the chamber, an substitution antenna for the frequency band of interest is placed at the reference point of the chamber. An RF Signal source for the frequency band of interest is connected to the substitution antenna with a cable that has been constructed to not interfere with the radiation pattern of the antenna. A power (PMea) is applied to the input of the substitution antenna, and adjust the level of the signal generator output until the value of the receiver reach the previously recorded (Pr). The power of signal source (PMea) is recorded. The test should be performed by rotating the test item and adjusting the receiving antenna polarization.
 6. A amplifier should be connected to the Signal Source output port. And the cable should be connect between the Amplifier and the Substitution Antenna. The cable loss (Pcl) ,the Substitution Antenna Gain (Ga) and the Amplifier Gain (PAg) should be recorded after test.
 7. The measurement results are obtained as described below:
 $Power(EIRP) = PMea - PAg - Pcl + Ga$
 The measurement results are amend as described below:
 $Power(EIRP) = PMea - Pcl + Ga$
 8. This value is EIRP since the measurement is calibrated using an antenna of known gain (2.15 dBi) and known input power. ERP can be calculated from EIRP by subtracting the gain of the dipole, $ERP = EIRP - 2.15dBi$.
- The modulation mode and RB allocation refer to section 5.1, using the maximum output power configuration.

Test setup

30MHz~~~ 1GHz

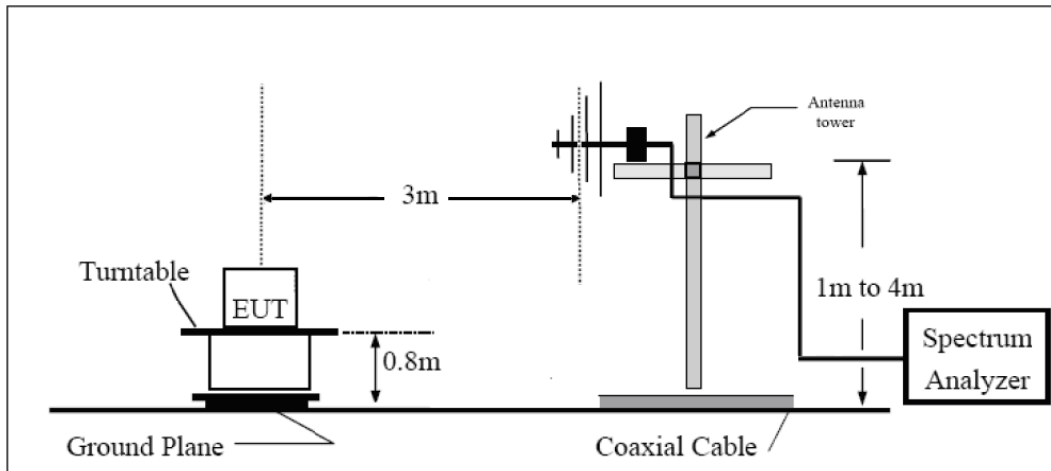

Above 1GHz

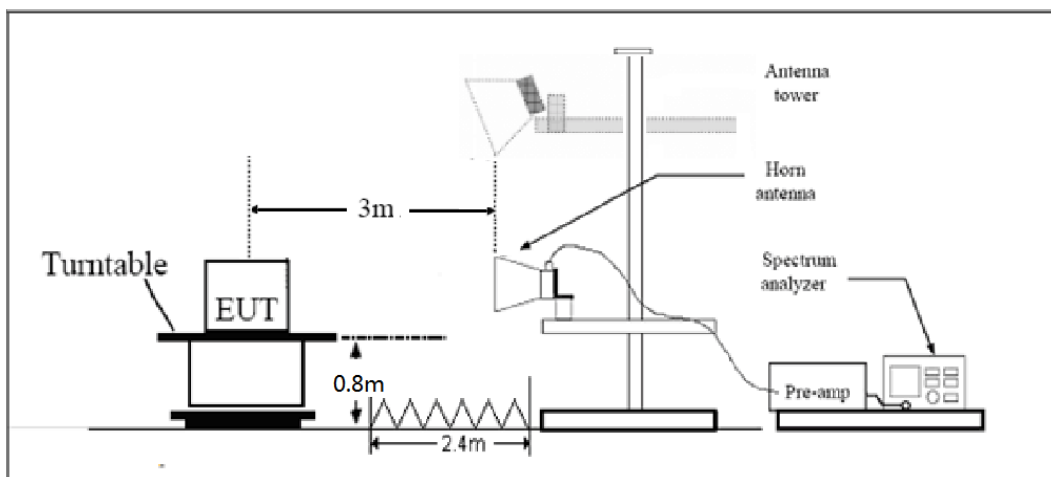

Note: Area side:2.4mX3.6m

The radiated emission was measured in the following position: EUT stand-up position (Z axis), lie-down position (X, Y axis). The worst emission was found in lie-down position (X axis) and the worst case was recorded.

Limits

Rule Part 27.53(h) specifies that “for operations in the 1695-1710 MHz, 1710-1755 MHz, 1755-1780 MHz, 1915-1920 MHz, 1995-2000 MHz, 2000-2020 MHz, 2110-2155 MHz, 2155-2180 MHz, and 2180-2200 bands, the power of any emission outside a licensee's frequency block shall be attenuated below the transmitter power (P) in watts by at least $43 + 10 \log_{10} (P)$ dB..”

Rule Part 27.53 (g) For operations in the 600 MHz band and the 698-746 MHz band, the power of any emission outside a licensee's frequency band(s) of operation shall be attenuated below the transmitter power (P) within the licensed band(s) of operation, measured in watts, by at least $43 + 10 \log (P)$ dB. Compliance with this provision is based on the use of measurement instrumentation employing a resolution bandwidth of 100 kilohertz or greater. However, in the 100 kilohertz bands



immediately outside and adjacent to a licensee's frequency block, a resolution bandwidth of at least 30 kHz may be employed.

Rule Part 27.53(f) For operations in the 746-758 MHz, 775-788 MHz, and 805-806 MHz bands, emissions in the band 1559-1610 MHz shall be limited to -70 dBW/MHz equivalent isotropically radiated power (EIRP) for wideband signals, and -80 dBW EIRP for discrete emissions of less than 700 Hz bandwidth. For the purpose of equipment authorization, a transmitter shall be tested with an antenna that is representative of the type that will be used with the equipment in normal operation.

Part 27.53(h)(g) Limit		-13 dBm
Part 27.53(f) Limit	Limit out of the band 1559-1610 MHz	-13 dBm
	Limit in the band 1559-1610 MHz	-40 dBm

Measurement Uncertainty

The assessed measurement uncertainty to ensure 95% confidence level for the normal distribution is with the coverage factor $k = \pm 1.96$, $U = \pm 3.55$ dB.

Test Result

Sweep the whole frequency band through the range from 30MHz to the 10th harmonic of the carrier, the emissions below the noise floor will not be recorded in the report.

WCDMA Band IV CH-Low

Harmonic	Frequency (MHz)	SG (dBm)	Cable Loss (dB)	Gain (dBi)	Antenna Polarization	EIRP Level (dBm)	Limit (dBm)	Margin (dB)	Azimuth (deg)
2	3424.8	-52.55	2.6	10.15	Horizontal	-45.00	-13.00	32.00	0
3	5137.2	-50.15	2.4	11.35	Horizontal	-41.20	-13.00	28.20	45
4	6849.6	-54.35	4.5	10.85	Horizontal	-48.00	-13.00	35.00	90
5	8562.0	-54.05	5.1	11.35	Horizontal	-47.80	-13.00	34.80	0
6	10274.4	-48.95	5.3	11.95	Horizontal	-42.30	-13.00	29.30	225
7	11986.8	-51.95	5.5	13.55	Horizontal	-43.90	-13.00	30.90	135
8	13699.2	-47.95	6.3	13.75	Horizontal	-40.50	-13.00	27.50	90
9	15411.6	-49.95	6.7	13.85	Horizontal	-42.80	-13.00	29.80	0
10	17124.0	-48.05	6.8	14.25	Horizontal	-40.60	-13.00	27.60	45

Note: 1. The other Spurious RF Radiated emissions level is no more than noise floor.

2. The worst emission was found in the antenna is Horizontal position.

WCDMA Band IV CH-High

Harmonic	Frequency (MHz)	SG (dBm)	Cable Loss (dB)	Gain (dBi)	Antenna Polarization	EIRP Level (dBm)	Limit (dBm)	Margin (dB)	Azimuth (deg)
2	3505.2	-56.25	2.6	10.15	Horizontal	-48.70	-13.00	35.70	135
3	5254.1	-55.85	2.4	11.05	Horizontal	-47.20	-13.00	34.20	225
4	7010.4	-53.65	4.5	11.15	Horizontal	-47.00	-13.00	34.00	270
5	8763.0	-53.05	5.1	11.35	Horizontal	-46.80	-13.00	33.80	135
6	10515.6	-48.95	5.3	11.95	Horizontal	-42.30	-13.00	29.30	45
7	12268.2	-51.55	5.5	13.55	Horizontal	-43.50	-13.00	30.50	315
8	14020.8	-47.25	6.3	13.75	Horizontal	-39.80	-13.00	26.80	90
9	15773.4	-49.25	6.7	13.85	Horizontal	-42.10	-13.00	29.10	0
10	17526.0	-48.05	6.8	14.25	Horizontal	-40.60	-13.00	27.60	45

Note: 1. The other Spurious RF Radiated emissions level is no more than noise floor.

2. The worst emission was found in the antenna is Horizontal position.

LTE Band 4 QPSK 1.4MHz CH-Low, RB 1

Harmonic	Frequency (MHz)	SG (dBm)	Cable Loss (dB)	Gain (dBi)	Antenna Polarization	EIRP Level (dBm)	Limit (dBm)	Margin (dB)	Azimuth (deg)
2	3421.4	-49.15	2.6	10.15	Horizontal	-41.60	-13.00	28.60	0
3	5131.1	-44.85	2.4	11.35	Horizontal	-35.90	-13.00	22.90	0
4	6842.8	-52.95	4.5	10.85	Horizontal	-46.60	-13.00	33.60	45
5	8553.5	-53.05	5.1	11.35	Horizontal	-46.80	-13.00	33.80	315
6	10264.2	-51.15	5.3	11.95	Horizontal	-44.50	-13.00	31.50	315
7	11974.9	-51.15	5.5	13.55	Horizontal	-43.10	-13.00	30.10	315
8	13685.6	-48.95	6.3	13.75	Horizontal	-41.50	-13.00	28.50	270
9	15396.3	-47.65	6.7	13.85	Horizontal	-40.50	-13.00	27.50	90
10	17107.0	-47.25	6.8	14.25	Horizontal	-39.80	-13.00	26.80	45

Note: 1.The other Spurious RF Radiated emissions level is no more than noise floor.
2. The worst emission was found in the antenna is Horizontal position.

LTE Band 4 QPSK 1.4MHz CH-Middle, RB 1

Harmonic	Frequency (MHz)	SG (dBm)	Cable Loss (dB)	Gain (dBi)	Antenna Polarization	EIRP Level (dBm)	Limit (dBm)	Margin (dB)	Azimuth (deg)
2	3464.3	-51.85	2.6	10.75	Horizontal	-43.70	-13.00	30.70	135
3	5197.5	-44.75	2.4	11.05	Horizontal	-36.10	-13.00	23.10	180
4	6930.0	-53.95	4.5	11.15	Horizontal	-47.30	-13.00	34.30	180
5	8662.5	-52.75	5.1	11.35	Horizontal	-46.50	-13.00	33.50	180
6	10395.0	-50.85	5.3	11.95	Horizontal	-44.20	-13.00	31.20	45
7	12127.5	-51.65	5.5	13.55	Horizontal	-43.60	-13.00	30.60	315
8	13860.0	-49.15	6.3	13.75	Horizontal	-41.70	-13.00	28.70	45
9	15592.5	-47.65	6.7	13.85	Horizontal	-40.50	-13.00	27.50	135
10	17325.0	-46.05	6.8	14.25	Horizontal	-38.60	-13.00	25.60	45

Note: 1.The other Spurious RF Radiated emissions level is no more than noise floor.
2. The worst emission was found in the antenna is Horizontal position.



LTE Band 4 QPSK 1.4MHz CH-High, RB 1

Harmonic	Frequency (MHz)	SG (dBm)	Cable Loss (dB)	Gain (dBi)	Antenna Polarization	EIRP Level (dBm)	Limit (dBm)	Margin (dB)	Azimuth (deg)
2	3507.8	-44.65	2.6	10.15	Horizontal	-37.10	-13.00	24.10	135
3	5261.6	-46.75	2.4	11.05	Horizontal	-38.10	-13.00	25.10	180
4	7017.2	-50.65	4.5	11.15	Horizontal	-44.00	-13.00	31.00	180
5	8771.5	-50.05	5.1	11.35	Horizontal	-43.80	-13.00	30.80	45
6	10525.8	-50.45	5.3	11.95	Horizontal	-43.80	-13.00	30.80	0
7	12280.1	-50.55	5.5	13.55	Horizontal	-42.50	-13.00	29.50	0
8	14034.4	-48.65	6.3	13.75	Horizontal	-41.20	-13.00	28.20	135
9	15788.7	-46.85	6.7	13.85	Horizontal	-39.70	-13.00	26.70	90
10	17543.0	-45.65	6.8	14.25	Horizontal	-38.20	-13.00	25.20	270

Note: 1.The other Spurious RF Radiated emissions level is no more than noise floor.

2. The worst emission was found in the antenna is Horizontal position.

LTE Band 4 QPSK 5MHz CH-Low, RB 1

Harmonic	Frequency (MHz)	SG (dBm)	Cable Loss (dB)	Gain (dBi)	Antenna Polarization	EIRP Level (dBm)	Limit (dBm)	Margin (dB)	Azimuth (deg)
2	3425.0	-49.45	2.6	10.15	Horizontal	-41.90	-13.00	28.90	0
3	5131.1	-45.05	2.4	11.35	Horizontal	-36.10	-13.00	23.10	90
4	6850.0	-53.35	4.5	10.85	Horizontal	-47.00	-13.00	34.00	180
5	8562.5	-53.45	5.1	11.35	Horizontal	-47.20	-13.00	34.20	270
6	10275.0	-50.15	5.3	11.95	Horizontal	-43.50	-13.00	30.50	315
7	11987.5	-50.75	5.5	13.55	Horizontal	-42.70	-13.00	29.70	135
8	13700.0	-47.15	6.3	13.75	Horizontal	-39.70	-13.00	26.70	180
9	15412.5	-49.15	6.7	13.85	Horizontal	-42.00	-13.00	29.00	45
10	17125.0	-46.65	6.8	14.25	Horizontal	-39.20	-13.00	26.20	90

Note: 1.The other Spurious RF Radiated emissions level is no more than noise floor.

2. The worst emission was found in the antenna is Horizontal position.

LTE Band 4 QPSK 5MHz CH-Middle, RB 1

Harmonic	Frequency (MHz)	SG (dBm)	Cable Loss (dB)	Gain (dBi)	Antenna Polarization	EIRP Level (dBm)	Limit (dBm)	Margin (dB)	Azimuth (deg)
2	3460.5	-53.25	2.6	10.75	Horizontal	-45.10	-13.00	32.10	0
3	5191.5	-44.85	2.4	11.05	Horizontal	-36.20	-13.00	23.20	0
4	6930.0	-53.85	4.5	11.15	Horizontal	-47.20	-13.00	34.20	0
5	8662.5	-52.65	5.1	11.35	Horizontal	-46.40	-13.00	33.40	90
6	10395.0	-50.45	5.3	11.95	Horizontal	-43.80	-13.00	30.80	315
7	12127.5	-50.55	5.5	13.55	Horizontal	-42.50	-13.00	29.50	45
8	13860.0	-46.85	6.3	13.75	Horizontal	-39.40	-13.00	26.40	45
9	15592.5	-49.05	6.7	13.85	Horizontal	-41.90	-13.00	28.90	90
10	17325.0	-46.25	6.8	14.25	Horizontal	-38.80	-13.00	25.80	135

Note: 1.The other Spurious RF Radiated emissions level is no more than noise floor.
2. The worst emission was found in the antenna is Horizontal position.

LTE Band 4 QPSK 5MHz CH-High, RB 1

Harmonic	Frequency (MHz)	SG (dBm)	Cable Loss (dB)	Gain (dBi)	Antenna Polarization	EIRP Level (dBm)	Limit (dBm)	Margin (dB)	Azimuth (deg)
2	3500.6	-44.75	2.6	10.15	Horizontal	-37.20	-13.00	24.20	0
3	5251.1	-47.95	2.4	11.05	Horizontal	-39.30	-13.00	26.30	90
4	7010.0	-52.75	4.5	11.15	Horizontal	-46.10	-13.00	33.10	180
5	8762.5	-52.05	5.1	11.35	Horizontal	-45.80	-13.00	32.80	315
6	10515.0	-50.15	5.3	11.95	Horizontal	-43.50	-13.00	30.50	135
7	12267.5	-50.15	5.5	13.55	Horizontal	-42.10	-13.00	29.10	180
8	14020.0	-46.35	6.3	13.75	Horizontal	-38.90	-13.00	25.90	45
9	15772.5	-46.65	6.7	13.85	Horizontal	-39.50	-13.00	26.50	90
10	17525.0	-45.05	6.8	14.25	Horizontal	-37.60	-13.00	24.60	0

Note: 1.The other Spurious RF Radiated emissions level is no more than noise floor.
2. The worst emission was found in the antenna is Horizontal position.

LTE Band 4 QPSK 20MHz CH-Low, RB 1

Harmonic	Frequency (MHz)	SG (dBm)	Cable Loss (dB)	Gain (dBi)	Antenna Polarization	EIRP Level (dBm)	Limit (dBm)	Margin (dB)	Azimuth (deg)
2	3440.0	-49.75	2.6	10.15	Horizontal	-42.20	-13.00	29.20	90
3	5133.4	-44.55	2.4	11.35	Horizontal	-35.60	-13.00	22.60	45
4	6880.0	-53.25	4.5	10.85	Horizontal	-46.90	-13.00	33.90	180
5	8600.0	-51.95	5.1	11.35	Horizontal	-45.70	-13.00	32.70	315
6	10320.0	-49.15	5.3	11.95	Horizontal	-42.50	-13.00	29.50	45
7	12040.0	-51.75	5.5	13.55	Horizontal	-43.70	-13.00	30.70	0
8	13760.0	-49.55	6.3	13.75	Horizontal	-42.10	-13.00	29.10	45
9	15480.0	-48.35	6.7	13.85	Horizontal	-41.20	-13.00	28.20	90
10	17200.0	-46.15	6.8	14.25	Horizontal	-38.70	-13.00	25.70	315

Note: 1.The other Spurious RF Radiated emissions level is no more than noise floor.
2. The worst emission was found in the antenna is Horizontal position.

LTE Band 4 QPSK 20MHz CH-Middle, RB 1

Harmonic	Frequency (MHz)	SG (dBm)	Cable Loss (dB)	Gain (dBi)	Antenna Polarization	EIRP Level (dBm)	Limit (dBm)	Margin (dB)	Azimuth (deg)
2	3465.0	-56.25	2.6	10.75	Horizontal	-48.10	-13.00	35.10	135
3	5170.9	-47.65	2.4	11.05	Horizontal	-39.00	-13.00	26.00	180
4	6930.0	-54.05	4.5	11.15	Horizontal	-47.40	-13.00	34.40	45
5	8662.5	-51.75	5.1	11.35	Horizontal	-45.50	-13.00	32.50	90
6	10395.0	-49.45	5.3	11.95	Horizontal	-42.80	-13.00	29.80	0
7	12127.5	-50.15	5.5	13.55	Horizontal	-42.10	-13.00	29.10	90
8	13860.0	-48.65	6.3	13.75	Horizontal	-41.20	-13.00	28.20	45
9	15592.5	-48.55	6.7	13.85	Horizontal	-41.40	-13.00	28.40	180
10	17325.0	-45.65	6.8	14.25	Horizontal	-38.20	-13.00	25.20	315

Note: 1.The other Spurious RF Radiated emissions level is no more than noise floor.
2. The worst emission was found in the antenna is Horizontal position.

LTE Band 4 QPSK 20MHz CH-High, RB 1

Harmonic	Frequency (MHz)	SG (dBm)	Cable Loss (dB)	Gain (dBi)	Antenna Polarization	EIRP Level (dBm)	Limit (dBm)	Margin (dB)	Azimuth (deg)
2	3490.0	-48.45	2.6	10.15	Horizontal	-40.90	-13.00	27.9	45
3	5208.4	-45.45	2.4	11.05	Horizontal	-36.80	-13.00	23.8	180
4	6980.0	-53.45	4.5	11.15	Horizontal	-46.80	-13.00	33.8	315
5	8725.0	-50.85	5.1	11.35	Horizontal	-44.60	-13.00	31.6	45
6	10470.0	-48.75	5.3	11.95	Horizontal	-42.10	-13.00	29.1	0
7	12215.0	-49.85	5.5	13.55	Horizontal	-41.80	-13.00	28.8	45
8	13960.0	-48.95	6.3	13.75	Horizontal	-41.50	-13.00	28.5	90
9	15705.0	-46.65	6.7	13.85	Horizontal	-39.50	-13.00	26.5	315
10	17450.0	-45.55	6.8	14.25	Horizontal	-38.10	-13.00	25.1	135

Note: 1.The other Spurious RF Radiated emissions level is no more than noise floor.
2. The worst emission was found in the antenna is Horizontal position.

LTE Band 12 QPSK 1.4MHz CH-Low, RB 1

Harmonic	Frequency (MHz)	SG (dBm)	Cable Loss (dB)	Gain (dBi)	Antenna Polarization	ERP Level (dBm)	Limit (dBm)	Margin (dB)	Azimuth (deg)
2	1399.4	-55.90	2.00	10.15	Horizontal	-49.90	-13.00	36.90	180
3	2099.1	-58.90	2.50	11.35	Horizontal	-52.20	-13.00	39.20	315
4	2798.8	-59.40	4.20	10.85	Horizontal	-54.90	-13.00	36.90	45
5	3498.5	-58.60	5.20	11.35	Horizontal	-54.60	-13.00	41.60	180
6	4198.2	-58.50	5.50	11.95	Horizontal	-54.20	-13.00	41.20	315
7	4897.9	-59.10	5.70	13.55	Horizontal	-53.40	-13.00	40.40	45
8	5597.6	-56.50	6.30	13.75	Horizontal	-51.20	-13.00	38.20	0
9	6297.3	-55.50	6.80	13.85	Horizontal	-50.60	-13.00	37.60	45
10	6997.0	-53.00	6.90	14.25	Horizontal	-47.80	-13.00	34.80	90

Note: 1.The other Spurious RF Radiated emissions level is no more than noise floor.
2. The worst emission was found in the antenna is Horizontal position.

LTE Band 12 QPSK 1.4MHz CH-Middle, RB 1

Harmonic	Frequency (MHz)	SG (dBm)	Cable Loss (dB)	Gain (dBi)	Antenna Polarization	ERP Level (dBm)	Limit (dBm)	Margin (dB)	Azimuth (deg)
2	1415.0	-58.50	2.00	10.75	Horizontal	-51.90	-13.00	38.90	45
3	2122.5	-58.09	2.51	11.05	Horizontal	-51.70	-13.00	38.70	0
4	2830.0	-58.60	4.20	11.15	Horizontal	-53.80	-13.00	40.80	315
5	3537.5	-58.60	5.20	11.15	Horizontal	-54.80	-13.00	41.80	315
6	4245.0	-58.90	5.50	11.95	Horizontal	-54.60	-13.00	41.60	135
7	4952.5	-59.10	5.70	13.55	Horizontal	-53.40	-13.00	40.40	45
8	5660.0	-56.70	6.30	13.75	Horizontal	-51.40	-13.00	38.40	0
9	6367.5	-55.10	6.80	13.85	Horizontal	-50.20	-13.00	37.20	315
10	7075.0	-52.70	6.90	14.25	Horizontal	-47.50	-13.00	34.50	135

Note: 1.The other Spurious RF Radiated emissions level is no more than noise floor.
2. The worst emission was found in the antenna is Horizontal position.

LTE Band 12 QPSK 1.4MHz CH-High, RB 1

Harmonic	Frequency (MHz)	SG (dBm)	Cable Loss (dB)	Gain (dBi)	Antenna Polarization	ERP Level (dBm)	Limit (dBm)	Margin (dB)	Azimuth (deg)
2	1430.6	-60.50	2.00	10.15	Horizontal	-54.50	-13.00	41.50	0
3	2145.9	-58.19	2.51	11.05	Horizontal	-51.80	-13.00	38.80	135
4	2861.2	-59.50	4.20	11.15	Horizontal	-54.70	-13.00	41.70	45
5	3576.5	-58.10	5.20	11.15	Horizontal	-54.30	-13.00	41.30	180
6	4291.8	-58.00	5.50	11.95	Horizontal	-53.70	-13.00	40.70	45
7	5007.1	-59.10	5.70	13.55	Horizontal	-53.40	-13.00	40.40	90
8	5722.4	-56.30	6.30	13.75	Horizontal	-51.00	-13.00	38.00	45
9	6437.7	-54.10	6.80	13.85	Horizontal	-49.20	-13.00	36.20	90
10	7153.0	-52.10	6.90	14.25	Horizontal	-46.90	-13.00	33.90	315

Note: 1.The other Spurious RF Radiated emissions level is no more than noise floor.
2. The worst emission was found in the antenna is Horizontal position.

LTE Band 12 QPSK 5MHz CH-Low, RB 1

Harmonic	Frequency (MHz)	SG (dBm)	Cable Loss (dB)	Gain (dBi)	Antenna Polarization	ERP Level (dBm)	Limit (dBm)	Margin (dB)	Azimuth (deg)
2	1403.0	-54.10	2.00	10.15	Horizontal	-48.10	-13.00	35.10	180
3	2104.5	-59.70	2.50	11.35	Horizontal	-53.00	-13.00	40.00	45
4	2806.0	-59.10	4.20	10.85	Horizontal	-54.60	-13.00	41.60	90
5	3507.5	-58.70	5.20	11.35	Horizontal	-54.70	-13.00	41.70	90
6	4209.0	-58.90	5.50	11.95	Horizontal	-54.60	-13.00	41.60	315
7	4910.5	-59.90	5.70	13.55	Horizontal	-54.20	-13.00	41.20	135
8	5612.0	-57.60	6.30	13.75	Horizontal	-52.30	-13.00	39.30	45
9	6313.5	-55.70	6.80	13.85	Horizontal	-50.80	-13.00	37.80	0
10	7015.0	-53.20	6.90	14.25	Horizontal	-48.00	-13.00	35.00	315

Note: 1.The other Spurious RF Radiated emissions level is no more than noise floor.
 2. The worst emission was found in the antenna is Horizontal position.

LTE Band 12 QPSK 5MHz CH-Middle, RB 1

Harmonic	Frequency (MHz)	SG (dBm)	Cable Loss (dB)	Gain (dBi)	Antenna Polarization	ERP Level (dBm)	Limit (dBm)	Margin (dB)	Azimuth (deg)
2	1415.0	-59.60	2.00	10.75	Horizontal	-53.00	-13.00	40.00	45
3	2122.5	-59.99	2.51	11.05	Horizontal	-53.60	-13.00	40.60	90
4	2830.0	-59.00	4.20	11.15	Horizontal	-54.20	-13.00	41.20	315
5	3537.5	-58.70	5.20	11.15	Horizontal	-54.90	-13.00	41.90	45
6	4245.0	-58.90	5.50	11.95	Horizontal	-54.60	-13.00	41.60	0
7	4952.5	-59.10	5.70	13.55	Horizontal	-53.40	-13.00	40.40	315
8	5660.0	-57.40	6.30	13.75	Horizontal	-52.10	-13.00	39.10	135
9	6367.5	-55.40	6.80	13.85	Horizontal	-50.50	-13.00	37.50	180
10	7075.0	-52.80	6.90	14.25	Horizontal	-47.60	-13.00	34.60	45

Note: 1.The other Spurious RF Radiated emissions level is no more than noise floor.
 2. The worst emission was found in the antenna is Horizontal position.

LTE Band 12 QPSK 5MHz CH-High, RB 1

Harmonic	Frequency (MHz)	SG (dBm)	Cable Loss (dB)	Gain (dBi)	Antenna Polarization	ERP Level (dBm)	Limit (dBm)	Margin (dB)	Azimuth (deg)
2	1427.0	-56.60	2.00	10.15	Horizontal	-50.60	-13.00	37.60	135
3	2140.5	-59.09	2.51	11.05	Horizontal	-52.70	-13.00	39.70	45
4	2854.0	-59.10	4.20	11.15	Horizontal	-54.30	-13.00	41.30	0
5	3567.5	-58.40	5.20	11.15	Horizontal	-54.60	-13.00	41.60	90
6	4281.0	-57.80	5.50	11.95	Horizontal	-53.50	-13.00	40.50	45
7	4994.5	-58.30	5.70	13.55	Horizontal	-52.60	-13.00	39.60	90
8	5708.0	-57.30	6.30	13.75	Horizontal	-52.00	-13.00	39.00	315
9	6421.5	-55.10	6.80	13.85	Horizontal	-50.20	-13.00	37.20	135
10	7135.0	-52.60	6.90	14.25	Horizontal	-47.40	-13.00	34.40	45

Note: 1.The other Spurious RF Radiated emissions level is no more than noise floor.
2. The worst emission was found in the antenna is Horizontal position.

LTE Band 12 QPSK 10MHz CH-Low, RB 1

Harmonic	Frequency (MHz)	SG (dBm)	Cable Loss (dB)	Gain (dBi)	Antenna Polarization	ERP Level (dBm)	Limit (dBm)	Margin (dB)	Azimuth (deg)
2	1408.0	-56.40	2.00	10.15	Horizontal	-50.40	-13.00	37.40	90
3	2112.0	-59.89	2.51	11.35	Horizontal	-53.20	-13.00	40.20	315
4	2816.0	-59.60	4.20	10.85	Horizontal	-55.10	-13.00	42.10	180
5	3520.0	-60.40	5.20	11.35	Horizontal	-56.40	-13.00	43.40	135
6	4224.0	-60.20	5.50	11.95	Horizontal	-55.90	-13.00	42.90	180
7	4928.0	-60.10	5.70	13.55	Horizontal	-54.40	-13.00	41.40	45
8	5632.0	-57.10	6.30	13.75	Horizontal	-51.80	-13.00	38.80	90
9	6336.0	-55.40	6.80	13.85	Horizontal	-50.50	-13.00	37.50	45
10	7040.0	-53.50	6.90	14.25	Horizontal	-48.30	-13.00	35.30	225

Note: 1.The other Spurious RF Radiated emissions level is no more than noise floor.
2. The worst emission was found in the antenna is Horizontal position.

LTE Band 12 QPSK 10MHz CH-Middle, RB 1

Harmonic	Frequency (MHz)	SG (dBm)	Cable Loss (dB)	Gain (dBi)	Antenna Polarization	ERP Level (dBm)	Limit (dBm)	Margin (dB)	Azimuth (deg)
2	1415.0	-61.40	2.00	10.75	Horizontal	-54.80	-13.00	41.80	135
3	2122.5	-59.49	2.51	11.05	Horizontal	-53.10	-13.00	40.10	225
4	2830.0	-60.40	4.20	11.15	Horizontal	-55.60	-13.00	42.60	45
5	3537.5	-60.00	5.20	11.15	Horizontal	-56.20	-13.00	43.20	45
6	4245.0	-59.50	5.50	11.95	Horizontal	-55.20	-13.00	42.20	90
7	4952.5	-59.60	5.70	13.55	Horizontal	-53.90	-13.00	40.90	315
8	5660.0	-58.80	6.30	13.75	Horizontal	-53.50	-13.00	40.50	90
9	6367.5	-55.50	6.80	13.85	Horizontal	-50.60	-13.00	37.60	315
10	7075.0	-52.20	6.90	14.25	Horizontal	-47.00	-13.00	34.00	135

Note: 1.The other Spurious RF Radiated emissions level is no more than noise floor.
2. The worst emission was found in the antenna is Horizontal position.

LTE Band 12 QPSK 10MHz CH-High, RB 1

Harmonic	Frequency (MHz)	SG (dBm)	Cable Loss (dB)	Gain (dBi)	Antenna Polarization	ERP Level (dBm)	Limit (dBm)	Margin (dB)	Azimuth (deg)
2	1422.0	-58.1	2.00	10.15	Horizontal	-52.10	-13.00	39.10	0
3	2133.0	-58.59	2.51	11.05	Horizontal	-52.20	-13.00	39.20	315
4	2844.0	-60.1	4.20	11.15	Horizontal	-55.30	-13.00	42.30	225
5	3555.0	-59.7	5.20	11.15	Horizontal	-55.90	-13.00	42.90	45
6	4266.0	-59.3	5.50	11.95	Horizontal	-55.00	-13.00	42.00	45
7	4977.0	-59.9	5.70	13.55	Horizontal	-54.20	-13.00	41.20	135
8	5688.0	-57.3	6.30	13.75	Horizontal	-52.00	-13.00	39.00	180
9	6399.0	-55.7	6.80	13.85	Horizontal	-50.80	-13.00	37.80	45
10	7110.0	-51.6	6.90	14.25	Horizontal	-46.40	-13.00	33.40	90

Note: 1.The other Spurious RF Radiated emissions level is no more than noise floor.
2. The worst emission was found in the antenna is Horizontal position.



LTE Band 13 QPSK 5MHz CH-Low, RB 1

Harmonic	Frequency (MHz)	SG (dBm)	Cable Loss (dB)	Gain (dBi)	Antenna Polarization	ERP Level (dBm)	Limit (dBm)	Margin (dB)	Azimuth (deg)
2	1555.8	-56.40	2.00	10.15	Horizontal	-50.40	-13.00	37.40	45
3	2338.5	-54.50	2.50	11.35	Horizontal	-47.80	-13.00	34.80	90
4	3118.0	-61.40	4.20	10.85	Horizontal	-56.90	-13.00	43.90	45
5	3897.5	-58.50	5.20	11.35	Horizontal	-54.50	-13.00	41.50	135
6	4677.0	-58.00	5.50	11.95	Horizontal	-53.70	-13.00	40.70	180
7	5456.5	-56.60	5.70	13.55	Horizontal	-50.90	-13.00	37.90	45
8	6236.0	-56.10	6.30	13.75	Horizontal	-50.80	-13.00	37.80	90
9	7015.5	-52.90	6.80	13.85	Horizontal	-48.00	-13.00	35.00	45
10	7795.0	-53.70	6.90	14.25	Horizontal	-48.50	-13.00	35.50	0

Note: 1. The other Spurious RF Radiated emissions level is no more than noise floor.
2. The worst emission was found in the antenna is Horizontal position.

LTE Band 13 QPSK 5MHz CH-High, RB 1

Harmonic	Frequency (MHz)	SG (dBm)	Cable Loss (dB)	Gain (dBi)	Antenna Polarization	EIRP Level (dBm)	Limit (dBm)	Margin (dB)	Azimuth (deg)
2	1569.0	-56.80	2.00	10.15	Horizontal	-50.80	-40.00	10.80	45
Harmonic	Frequency (MHz)	SG (dBm)	Cable Loss (dB)	Gain (dBi)	Antenna Polarization	ERP Level (dBm)	Limit (dBm)	Margin (dB)	Azimuth (deg)
3	2353.5	-54.89	2.51	11.05	Horizontal	-48.50	-13.00	35.50	135
4	3138.0	-61.80	4.20	11.15	Horizontal	-57.00	-13.00	44.00	45
5	3922.5	-58.60	5.20	11.15	Horizontal	-54.80	-13.00	41.80	90
6	4707.0	-58.20	5.50	11.95	Horizontal	-53.90	-13.00	40.90	45
7	5491.5	-58.10	5.70	13.55	Horizontal	-52.40	-13.00	39.40	225
8	6276.0	-56.00	6.30	13.75	Horizontal	-50.70	-13.00	37.70	45
9	7060.5	-53.10	6.80	13.85	Horizontal	-48.20	-13.00	35.20	90
10	7845.0	-52.80	6.90	14.25	Horizontal	-47.60	-13.00	34.60	315

Note: 1. The other Spurious RF Radiated emissions level is no more than noise floor.
2. The worst emission was found in the antenna is Horizontal position.



LTE Band 13 QPSK 10MHz CH-Low, RB 1

Harmonic	Frequency (MHz)	SG (dBm)	Cable Loss (dB)	Gain (dBi)	Antenna Polarization	ERP Level (dBm)	Limit (dBm)	Margin (dB)	Azimuth (deg)
2	1556.5	-56.20	2.00	10.15	Horizontal	-50.20	-13.00	37.20	180
3	2346.0	-55.99	2.51	11.35	Horizontal	-49.30	-13.00	36.30	45
4	3128.0	-61.30	4.20	10.85	Horizontal	-56.80	-13.00	43.80	135
5	3910.0	-59.40	5.20	11.35	Horizontal	-55.40	-13.00	42.40	45
6	4692.0	-57.20	5.50	11.95	Horizontal	-52.90	-13.00	39.90	135
7	5474.0	-58.80	5.70	13.55	Horizontal	-53.10	-13.00	40.10	180
8	6256.0	-56.20	6.30	13.75	Horizontal	-50.90	-13.00	37.90	45
9	7038.0	-52.60	6.80	13.85	Horizontal	-47.70	-13.00	34.70	90
10	7820.0	-53.10	6.90	14.25	Horizontal	-47.90	-13.00	34.90	45

Note: 1.The other Spurious RF Radiated emissions level is no more than noise floor.
2. The worst emission was found in the antenna is Horizontal position.

LTE Band 13 QPSK 10MHz CH-High, RB 1

Harmonic	Frequency (MHz)	SG (dBm)	Cable Loss (dB)	Gain (dBi)	Antenna Polarization	EIRP Level (dBm)	Limit (dBm)	Margin (dB)	Azimuth (deg)
2	1564.0	-56.70	2.00	10.15	Horizontal	-50.70	-40.00	10.70	225
Harmonic	Frequency (MHz)	SG (dBm)	Cable Loss (dB)	Gain (dBi)	Antenna Polarization	ERP Level (dBm)	Limit (dBm)	Margin (dB)	Azimuth (deg)
3	2346.0	-55.49	2.51	11.05	Horizontal	-49.10	-13.00	36.10	0
4	3128.0	-62.00	4.20	11.15	Horizontal	-57.20	-13.00	44.20	90
5	3910.0	-58.80	5.20	11.15	Horizontal	-55.00	-13.00	42.00	315
6	4692.0	-57.70	5.50	11.95	Horizontal	-53.40	-13.00	40.40	135
7	5474.0	-58.80	5.70	13.55	Horizontal	-53.10	-13.00	40.10	45
8	6256.0	-56.50	6.30	13.75	Horizontal	-51.20	-13.00	38.20	0
9	7038.0	-52.70	6.80	13.85	Horizontal	-47.80	-13.00	34.80	315
10	7820.0	-53.20	6.90	14.25	Horizontal	-48.00	-13.00	35.00	45

Note: 1.The other Spurious RF Radiated emissions level is no more than noise floor.
2. The worst emission was found in the antenna is Horizontal position.

Variant:
WCDMA Band IV CH-Middle

Harmonic	Frequency (MHz)	SG (dBm)	Cable Loss (dB)	Gain (dBi)	Antenna Polarization	EIRP Level (dBm)	Limit (dBm)	Margin (dB)	Azimuth (deg)
2	3466.88	-51.06	2.6	10.75	Horizontal	-42.91	-13.00	29.91	90
3	5197.80	-59.74	2.4	11.05	Horizontal	-51.09	-13.00	38.09	0
4	6930.40	-60.28	4.5	11.15	Horizontal	-53.63	-13.00	40.63	225
5	8663.00	-54.50	5.1	11.35	Horizontal	-48.25	-13.00	35.25	135
6	10395.60	-50.82	5.3	11.95	Horizontal	-44.17	-13.00	31.17	180
7	12128.20	-51.19	5.5	13.55	Horizontal	-43.14	-13.00	30.14	315
8	13860.80	-49.35	6.3	13.75	Horizontal	-41.90	-13.00	28.90	0
9	15593.40	-48.13	6.7	13.85	Horizontal	-40.98	-13.00	27.98	0
10	17326.00	-45.63	6.8	14.25	Horizontal	-38.18	-13.00	25.18	90

Note: 1.The other Spurious RF Radiated emissions level is no more than noise floor.
2. The worst emission was found in the antenna is Horizontal position.

LTE Band 13 QPSK 5MHz CH-Middle, RB 1

Harmonic	Frequency (MHz)	SG (dBm)	Cable Loss (dB)	Gain (dBi)	Antenna Polarization	EIRP Level (dBm)	Limit (dBm)	Margin (dB)	Azimuth (deg)
2	1559.8	-65.87	2.00	10.75	Horizontal	-57.12	-40.00	17.12	315
Harmonic	Frequency (MHz)	SG (dBm)	Cable Loss (dB)	Gain (dBi)	Antenna Polarization	ERP Level (dBm)	Limit (dBm)	Margin (dB)	Azimuth (deg)
3	2346.0	-63.65	2.51	11.05	Horizontal	-57.26	-13.00	44.26	135
4	3128.0	-58.34	4.20	11.15	Horizontal	-53.54	-13.00	40.54	90
5	3910.0	-55.86	5.20	11.15	Horizontal	-52.06	-13.00	39.06	45
6	4692.0	-55.57	5.50	11.95	Horizontal	-51.27	-13.00	38.27	225
7	5474.0	-55.67	5.70	13.55	Horizontal	-49.97	-13.00	36.97	45
8	6256.0	-58.50	6.30	13.75	Horizontal	-53.20	-13.00	40.20	90
9	7038.0	-56.54	6.80	13.85	Horizontal	-51.64	-13.00	38.64	315
10	7820.0	-54.58	6.90	14.25	Horizontal	-49.38	-13.00	36.38	90

Note: 1.The other Spurious RF Radiated emissions level is no more than noise floor.
2. The worst emission was found in the antenna is Horizontal position.

LTE Band 13 QPSK 10MHz CH-Middle, RB 1



Harmonic	Frequency (MHz)	SG (dBm)	Cable Loss (dB)	Gain (dBi)	Antenna Polarization	ERP Level (dBm)	Limit (dBm)	Margin (dB)	Azimuth (deg)
2	1554.6	-64.92	2.00	10.75	Horizontal	-58.32	-13.00	45.32	90
3	2346.0	-64.53	2.51	11.05	Horizontal	-58.14	-13.00	45.14	45
4	3128.0	-58.65	4.20	11.15	Horizontal	-53.85	-13.00	40.85	90
5	3910.0	-54.35	5.20	11.15	Horizontal	-50.55	-13.00	37.55	45
6	4692.0	-54.92	5.50	11.95	Horizontal	-50.62	-13.00	37.62	225
7	5474.0	-55.39	5.70	13.55	Horizontal	-49.69	-13.00	36.69	45
8	6256.0	-56.19	6.30	13.75	Horizontal	-50.89	-13.00	37.89	90
9	7038.0	-54.55	6.80	13.85	Horizontal	-49.65	-13.00	36.65	315
10	7820.0	-54.17	6.90	14.25	Horizontal	-48.97	-13.00	35.97	90

Note: 1.The other Spurious RF Radiated emissions level is no more than noise floor.

2. The worst emission was found in the antenna is Horizontal position.

6 Main Test Instruments

Name	Manufacturer	Type	Serial Number	Calibration Date	Expiration Date
Base Station Simulator	R&S	CMW500	113645	2018-05-20	2019-05-19
Base Station Simulator	R&S	CMW500	113824	2020-05-18	2021-05-17
Power Splitter	Hua Xiang	SHX-GF2-2-13	10120101	/	/
Spectrum Analyzer	Key sight	N9010A	MY50210259	2018-05-20	2019-05-19
Spectrum Analyzer	Key sight	N9010A	MY50210259	2020-05-18	2021-05-17
Signal Analyzer	R&S	FSV30	100815	2017-12-17	2018-12-16
Signal Analyzer	R&S	FSV30	100815	2019-12-15	2020-12-14
Signal generator	R&S	SMB 100A	102594	2018-05-20	2019-05-19
Signal generator	R&S	SMB 100A	102594	2020-05-18	2021-05-17
Loop Antenna	SCHWARZBECK	FMZB1519	1519-047	2017-09-26	2020-09-25
Trilog Antenna	SCHWARZBECK	VUBL 9163	9163-201	2017-11-18	2020-11-17
Horn Antenna	R&S	HF907	100126	2014-12-06	2019-12-05
Horn Antenna	R&S	HF907	102723	2018-08-11	2021-08-10
Horn Antenna	ETS-Lindgren	3160-09	00102643	2015-01-30	2020-01-29
Horn Antenna	ETS-Lindgren	3160-09	00102643	2018-06-20	2021-06-19
Climatic Chamber	ESPEC	SU-242	93000506	2017-12-17	2020-12-16
RF Cable	Agilent	SMA 15cm	0001	2019-06-14	2019-12-13
RF Cable	Agilent	SMA 15cm	0001	2020-06-12	2020-12-11
Preamplifier	R&S	SCU18	102327	2018-05-20	2019-05-19
Preamplifier	R&S	SCU18	102327	2020-05-18	2021-05-17
MOB COMMS DC SUPPLY	Keysight	66319D	MY43004105	2018-05-20	2019-05-19
MOB COMMS DC SUPPLY	Keysight	66319D	MY43004105	2020-05-18	2021-05-17



Software	R&S	EMC32	V 8.52.0	NA	NA
----------	-----	-------	----------	----	----

*****END OF REPORT *****