



RF TEST REPORT

Applicant Quectel Wireless Solutions Co., Ltd
FCC ID XMR202007BG95M6
Product LTE Cat M1 & Cat NB2 Module
Brand Quectel
Marketing Quectel BG95-M6
Model BG95-M6
Report No. R2108A0769-R2V1
Issue Date November 25, 2021

TA Technology (Shanghai) Co., Ltd. tested the above equipment in accordance with the requirements in **FCC CFR47 Part 2 (2020)/ FCC CFR 47 Part 24E (2020)**. The test results show that the equipment tested is capable of demonstrating compliance with the requirements as documented in this report.

Performed by: Peng Tao

Approved by: Kai Xu

TA Technology (Shanghai) Co., Ltd.

No.145, Jintang Rd, Tangzhen Industry Park, Pudong Shanghai, China

TEL: +86-021-50791141/2/3

FAX: +86-021-50791141/2/3-8000



TABLE OF CONTENT

1. Test Laboratory	5
1.1. Notes of the test report	5
1.2. Test facility	5
1.3. Testing Location	5
2. General Description of Equipment under Test	6
2.1. Applicant and Manufacturer Information	6
2.2. General information	6
3. Applied Standards	7
4. Test Configuration	8
5. Test Case Results	9
5.1. RF Power Output and Effective Isotropic Radiated Power	9
5.2. Occupied Bandwidth	14
5.3. Band Edge Compliance	20
5.4. Peak-to-Average Power Ratio (PAPR)	37
5.5. Frequency Stability	39
5.6. Spurious Emissions at Antenna Terminals	48
5.7. Radiates Spurious Emission	62
6. Main Test Instruments	68
ANNEX A: The EUT Appearance	69
ANNEX B: Test Setup Photos	70
ANNEX C: Verify data	71
ANNEX D: Product Change Description	72



Version	Revision description	Issue Date
Rev.0	Initial issue of report.	September 26, 2021
Rev.1	Update data. Update description	November 25, 2021

Note: This revised report (Report No. R2108A0769-R2V1) supersedes and replaces the previously issued report (Report No. R2108A0769-R2). Please discard or destroy the previously issued report and dispose of it accordingly.



Summary of measurement results

No.	Test Case	Clause in FCC rules	Verdict
1	RF Power Output and Effective Isotropic Radiated Power	2.1046 24.232(c)	PASS
2	Occupied Bandwidth	2.1049	PASS
3	Band Edge Compliance	2.1051 /24.238(a)	PASS
4	Peak-to-Average Power Ratio	24.232/KDB 971168 D01(5.7)	PASS
5	Frequency Stability	2.1055 / 24.235	PASS
6	Spurious Emissions at Antenna Terminals	2.1051 / 24.238(a)	PASS
7	Radiates Spurious Emission	2.1053 / 24.238(a)	PASS
Date of Testing: (Original) May 23, 2020 ~ June 16, 2020 (Variant) August 24, 2021~ November 25, 2021			
Note: PASS: The EUT complies with the essential requirements in the standard. FAIL: The EUT does not comply with the essential requirements in the standard. All indications of Pass/Fail in this report are opinions expressed by TA Technology (Shanghai) Co., Ltd. based on interpretations and/or observations of test results. Measurement Uncertainties were not taken into account and are published for informational purposes only.			

BG95-M6 (Report No.: R2108A0769-R2V1) is a variant model of BG95-M6 (Report No.: R2006A0413-R2). There is only changed the Power Amplifier and Software Version of product. Tested cases refer to the following table. Please refer to Appendix C for Verify data

Test Case	Original	Variant
RF Power Output and Effective Radiated Power	PASS	Retest(LTE band2 / LTE band 25)
Occupied Bandwidth	PASS	Verify the worst combination of each frequency band(LTE band2 / LTE band 25)
Band Edge Compliance	PASS	Verify the worst combination of each frequency band(LTE band2/ LTE band 25)
Peak-to-Average Power Ratio	PASS	Retest(LTE band2 / LTE band 25)
Frequency Stability	PASS	Verify the worst combination of each frequency band(LTE band2 / LTE band 22)
Spurious Emissions at Antenna Terminals	PASS	Verify the worst combination of each frequency band(LTE band2 / LTE band 25)
Radiates Spurious Emission	PASS	Verify the worst combination of each frequency band(LTE band5 / LTE band 25)

The detailed product change description please refers to the Difference Declaration Letter.



1. Test Laboratory

1.1. Notes of the test report

This report shall not be reproduced in full or partial, without the written approval of **TA technology (shanghai) co., Ltd.** The results documented in this report apply only to the tested sample, under the conditions and modes of operation as described herein. Measurement Uncertainties were not taken into account and are published for informational purposes only. This report is written to support regulatory compliance of the applicable standards stated above.

1.2. Test facility

FCC (Designation number: CN1179, Test Firm Registration Number: 446626)

TA Technology (Shanghai) Co., Ltd. has been listed on the US Federal Communications Commission list of test facilities recognized to perform electromagnetic emissions measurements.

A2LA (Certificate Number: 3857.01)

TA Technology (Shanghai) Co., Ltd. has been listed by American Association for Laboratory Accreditation to perform electromagnetic emission measurement.

1.3. Testing Location

Company: TA Technology (Shanghai) Co., Ltd.
Address: No.145, Jintang Rd, Tangzhen Industry Park, Pudong
City: Shanghai
Post code: 201201
Country: P. R. China
Contact: Xu Kai
Telephone: +86-021-50791141/2/3
Fax: +86-021-50791141/2/3-8000
Website: <http://www.ta-shanghai.com>
E-mail: xukai@ta-shanghai.com

2. General Description of Equipment under Test

2.1. Applicant and Manufacturer Information

Applicant	Quectel Wireless Solutions Co., Ltd
Applicant address	Building 5, Shanghai Business Park Phase III (Area B), No.1016 Tianlin Road, Minhang District, Shanghai, China 200233
Manufacturer	Quectel Wireless Solutions Co., Ltd
Manufacturer address	Building 5, Shanghai Business Park Phase III (Area B), No.1016 Tianlin Road, Minhang District, Shanghai, China 200233

2.2. General information

EUT Description			
Model	BG95-M6		
SN	Original	866642050000803	
	Variant	866642053044873	
Hardware Version	R1.1		
Software Version	BG95M6LAR02A02		
Power Supply	External power supply		
Antenna Type	The EUT don't have standard Antenna, The Antenna used for testing in this report is the after-market accessory (Dipole Antenna)		
Antenna Gain	Frequency(MHz)	Gain (dBi)	
	1860	1.25	
	1880	1.38	
	1900	1.59	
Test Mode(s)	LTE Band 2/25;		
Test Modulation	(LTE)QPSK,16QAM		
LTE Category	M1		
Maximum E.I.R.P	LTE Band 2:	25.23dBm	
	LTE Band 25:	25.03dBm	
Rated Power Supply Voltage	3.8V		
Extreme Voltage	Minimum: 3.3V Maximum: 4.3V		
Extreme Temperature	Lowest: -40°C Highest: +85°C		
Frequency Range(s)	Band	Tx (MHz)	Rx (MHz)
	LTE Band 2	1850 ~ 1910	1930 ~ 1990
	LTE Band 25	1850 ~ 1915	1930 ~ 1995
Note: 1. The EUT is sent from the applicant to TA and the information of the EUT is declared by the applicant.			



3. Applied Standards

According to the specifications of the manufacturer, it must comply with the requirements of the following standards:

Test standards:

FCC CFR 47 Part 24E (2020)

ANSI C63.26 (2015)

Reference standard:

FCC CFR47 Part 2 (2020)

KDB 971168 D01 Power Meas License Digital Systems v03r01

4. Test Configuration

Radiated measurements are performed by rotating the EUT in three different orthogonal test planes. EUT stand-up position (Z axis), lie-down position (X, Y axis). Receiver antenna polarization (horizontal and vertical), the worst emission was found in position (Z axis, horizontal polarization) and the worst case was recorded.

All mode and data rates and positions and RB size and modulations were investigated.

Subsequently, only the worst case emissions are reported.

The following testing in LTE is set based on the maximum RF Output Power.

Test modes are chosen to be reported as the worst case configuration below for LTE Band 2/25:

Test items	Bandwidth (MHz)						Modulation		RB			Test Channel		
	1.4	3	5	10	15	20	QPSK	16QAM	1	50%	100%	L	M	H
RF Power Output and Effective Isotropic Radiated Power	O	O	O	O	O	O	O	O	O	O	O	O	O	O
Occupied Bandwidth	O	O	O	O	O	O	O	O	-	-	O	O	O	O
Band Edge Compliance	O	O	O	O	O	O	O	O	O	-	O	O	-	O
Peak-to-Average Power Ratio	O	O	O	O	O	O	O	O	-	-	O	O	O	O
Frequency Stability	O	O	O	O	O	O	O	O	O	O	O	O	O	O
Conducted Spurious Emissions	O	O	O	O	O	O	O	-	O	-	-	O	O	O
Radiates Spurious Emission	O	-	O	-	-	O	O	-	O	-	-	-	O	-
Note	1. The mark "O" means that this configuration is chosen for testing. 2. The mark "-" means that this configuration is not testing.													

5. Test Case Results

5.1.RF Power Output and Effective Isotropic Radiated Power

Ambient condition

Temperature	Relative humidity	Pressure
23°C ~25°C	45%~50%	101.5kPa

Methods of Measurement

During the process of the testing, The EUT is controlled by the Base Station Simulator to ensure max power transmission and proper modulation.

The testing follows FCC KDB 971168 v03r01 Section 5.8 and ANSI C63.26 (2015).

- a) Connect the equipment as illustrated. Mount the equipment with the manufacturer specified antenna in a vertical orientation on a manufacturer specified mounting surface located on a non-conducting rotating platform of a RF anechoic chamber (preferred) or a standard radiation site.
- b) Key the transmitter, then rotate the EUT 360° azimuthally and record spectrum analyzer power level (LVL) measurements at angular increments that are sufficiently small to permit resolution of all peaks. If a standard radiation test site is used, raise and lower the test antenna to obtain a maximum reading at each angular increment. (Note: several batteries may be needed to offset the effect of battery voltage droop, which should not exceed 5% of the manufactured specified battery voltage during transmission).
- c) Replace the transmitter under test with a vertically polarized half-wave dipole (or an antenna whose gain is known relative to an ideal half-wave dipole). The center of the antenna should be at the same location as the center of the antenna under test.
- d) Connect the antenna to a signal generator with a known output power and record the path loss (in dB) as LOSS. If a standard radiation test site is used, raise and lower the test antenna to obtain a maximum reading. $LOSS = \text{Generator Output Power (dBm)} - \text{Analyzer reading (dBm)}$
- e) Determine the effective radiated output power at each angular position from the readings in steps b) and d) using the following equation: $ERP \text{ (dBm)} = \text{LVL (dBm)} + \text{LOSS (dB)}$
- f) The maximum ERP is the maximum value determined in the preceding step.
- g) When calculating ERP, in addition to knowing the antenna radiation and matching characteristics, it is necessary to know the loss values of all elements (e.g.transmission line attenuation, mismatches, filters, combiners) interposed between the point where transmitter output power is measured, and the point where power is applied to the antenna. ERP can then be calculated as follows:
 $EIRP \text{ (dBm)} = \text{Output Power (dBm)} - \text{Losses (dB)} + \text{Antenna Gain (dBi)}$
where:dBd refers to gain relative to an ideal dipole.
 $EIRP \text{ (dBm)} = \text{ERP (dBm)} + 2.15 \text{ (dB.)}$

The RB allocation refers to section 5.1, using the maximum output power configuration.

Test Setup

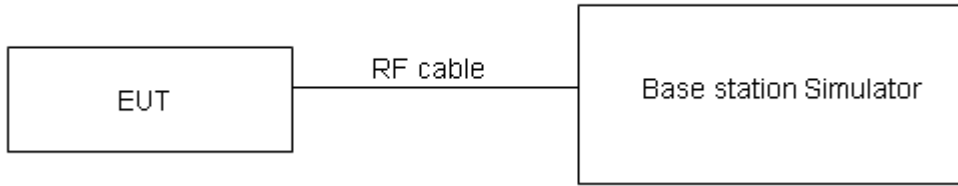

The loss between RF output port of the EUT and the input port of the tester has been taken into consideration.

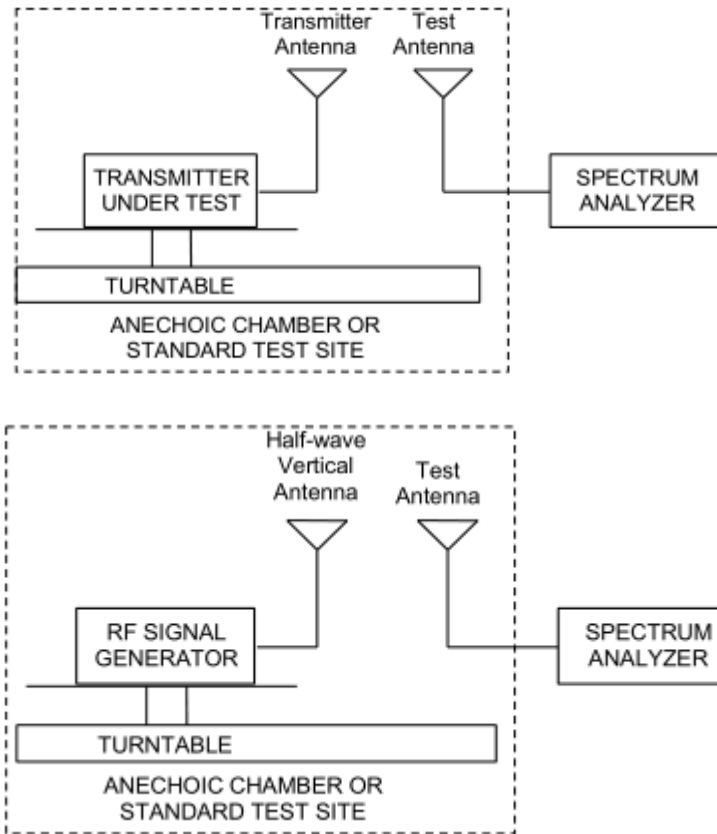

Limits

No specific RF power output requirements in part 2.1046.

Rule Part 24.232(c) Mobile and portable stations are limited to 2 watts EIRP.

Rule Part 24.232(e) Peak transmit power must be measured over any interval of continuous transmission using instrumentation calibrated in terms of an rms-equivalent voltage.

Limit	$\leq 2\text{ W}$ (33 dBm)
-------	----------------------------



Measurement Uncertainty

The assessed measurement uncertainty to ensure 95% confidence level for the normal distribution is with the coverage factor $k = 2$, $U = 0.4$ dB for RF power output, $k = 2$, $U = 1.19$ dB for EIRP.

**Test Results**

LTE Band 2	Channel/ Frequency(MHz)	Index	RB# RBstart	Conducted Power (dBm)		EIRP (dBm)	
				QPSK	16QAM	QPSK	16QAM
1.4MHz	18607/1850.7	0	1#0	23.05	22.25	24.30	23.50
		0	6#0	21.13	21.11	22.38	22.36
	18900/1880	0	1#0	23.09	22.00	24.47	23.38
		0	6#0	20.96	21.02	22.34	22.40
	19193/1909.3	0	1#5	23.50	23.58	25.09	25.17
		0	6#0	21.57	21.72	23.16	23.31
3MHz	18615/1851.5	0	1#0	23.44	22.05	24.69	23.30
		0	6#0	21.12	21.33	22.37	22.58
	18900/1880	0	1#0	23.32	22.01	24.70	23.39
		0	6#0	20.96	21.26	22.34	22.64
	19185/1908.5	1	1#5	23.01	21.99	24.60	23.58
		1	6#0	20.91	20.88	22.50	22.47
5MHz	18625/1852.5	3	1#0	23.14	23.31	24.39	24.56
		0	6#0	22.07	21.11	23.32	22.36
	18900/1880	0	1#0	23.00	23.14	24.38	24.52
		0	6#0	21.93	21.03	23.31	22.41
	19175/1907.5	0	1#5	23.37	23.35	24.96	24.94
		3	6#0	22.54	21.55	24.13	23.14
10MHz	18650/1855	3	1#0	23.03	23.24	24.28	24.49
		0	4#0	23.08	21.81	24.33	23.06
	18900/1880	0	1#0	23.07	23.23	24.45	24.61
		0	4#0	23.05	21.89	24.43	23.27
	19150/1905	4	1#5	23.30	23.64	24.89	25.23
		7	4#2	23.45	22.51	25.04	24.10
15MHz	18675/1857.5	3	1#0	23.08	23.22	24.33	24.47
		0	6#0	23.14	23.24	24.39	24.49
	18900/1880	0	1#0	23.09	23.17	24.47	24.55
		0	6#0	23.03	23.06	24.41	24.44
	19125/1902.5	8	1#5	23.01	22.96	24.60	24.55
		11	6#0	23.01	23.15	24.60	24.74
20MHz	18700/1860	3	1#0	23.11	23.25	24.36	24.50
		0	6#0	23.11	23.17	24.36	24.42
	18900/1880	0	1#0	23.10	23.24	24.48	24.62
		0	6#0	23.00	23.08	24.38	24.46
	19100/1900	12	1#5	23.01	22.61	24.60	24.20
		15	6#0	22.96	23.07	24.55	24.66



LTE Band 25	Channel/ Frequency(MHz)	Index	RB# RBstart	Conducted Power (dBm)		EIRP (dBm)	
				QPSK	16QAM	QPSK	16QAM
1.4MHz	26047/1850.7	0	1#0	23.23	22.67	24.61	24.05
		0	6#0	21.44	21.34	22.82	22.72
	26365/1882.5	0	1#0	23.08	22.45	24.46	23.83
		0	6#0	21.22	21.14	22.60	22.52
	26683/1914.3	0	1#5	23.00	22.10	24.36	23.46
		0	6#0	21.04	20.81	22.40	22.17
3MHz	26055/1851.5	0	1#0	23.50	22.67	24.88	24.05
		0	6#0	21.33	21.34	22.71	22.72
	26365/1882.5	0	1#0	23.23	22.34	24.61	23.72
		0	6#0	21.23	21.12	22.61	22.50
	26675/1913.5	1	1#5	23.25	21.84	24.61	23.20
		1	6#0	21.02	21.33	22.38	22.69
5MHz	26065/1852.5	3	1#0	23.44	23.63	24.82	25.01
		0	6#0	22.46	21.35	23.84	22.73
	26365/1882.5	0	1#0	23.39	23.06	24.77	24.44
		0	6#0	22.28	21.53	23.66	22.91
	26665/1912.5	0	1#5	23.03	22.71	24.39	24.07
		3	6#0	22.07	21.20	23.43	22.56
10MHz	26090/1855	3	1#0	23.59	23.19	24.97	24.57
		0	4#0	23.60	22.68	24.98	24.06
	26365/1882.5	0	1#0	23.48	23.04	24.86	24.42
		0	4#0	23.44	22.78	24.82	24.16
	26640/1910	4	1#5	23.02	23.13	24.38	24.49
		7	4#2	22.94	21.83	24.30	23.19
15MHz	26115/1857.5	3	1#0	23.52	23.21	24.90	24.59
		0	6#0	22.48	22.59	23.86	23.97
	26365/1882.5	0	1#0	23.38	23.06	24.76	24.44
		0	6#0	22.27	22.47	23.65	23.85
	26615/1907.5	8	1#5	23.01	23.22	24.37	24.58
		11	6#0	22.94	23.16	24.30	24.52
20MHz	26140/1860	3	1#0	23.36	23.65	24.74	25.03
		0	6#0	23.42	23.55	24.80	24.93
	26365/1882.5	0	1#0	23.34	23.41	24.72	24.79
		0	6#0	23.27	23.39	24.65	24.77
	26590/1905	12	1#5	23.03	22.71	24.39	24.07
		15	6#0	22.94	23.18	24.30	24.54

5.2.Occupied Bandwidth

Ambient condition

Temperature	Relative humidity	Pressure
23°C ~25°C	45%~50%	101.5kPa

Method of Measurement

The EUT was connected to Spectrum Analyzer and Base Station Simulator via power Splitter. The occupied bandwidth is measured using spectrum analyzer.

RBW is set to 51kHz, VBW is set to 160kHz for LTE Band 2/25

99% power and -26dBc occupied bandwidths are recorded. Spectrum analyzer plots are included on the following pages.

Test Setup

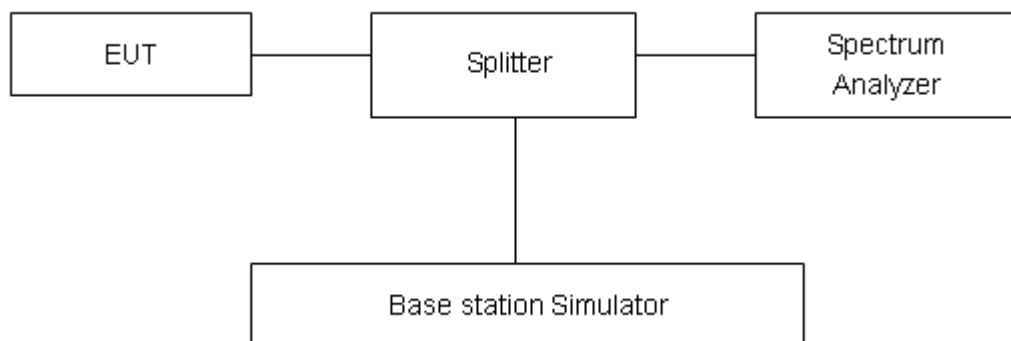

Limits

No specific occupied bandwidth requirements in part 2.1049.

Measurement Uncertainty

The assessed measurement uncertainty to ensure 95% confidence level for the normal distribution is with the coverage factor $k = 2$, $U = 624\text{Hz}$.

Test Result

Mode	Bandwidth	Modulation	Channel/ Frequency(MHz)	RB	Bandwidth(MHz)	
					99% Power	-26dBc
LTE Band 2	1.4MHz	QPSK	18900/1880	6#0	1.1081	1.388
		16QAM	18900/1880	6#0	0.9459	1.186
	3MHz	QPSK	18900/1880	6#0	1.1169	1.375
		16QAM	18900/1880	6#0	0.9525	1.187
	5MHz	QPSK	18900/1880	6#0	1.1134	1.319
		16QAM	18900/1880	6#0	0.9582	1.228
	10MHz	QPSK	18900/1880	6#0	1.1148	1.332
		16QAM	18900/1880	6#0	0.9608	1.251
	15MHz	QPSK	18900/1880	6#0	1.1384	1.443
		16QAM	18900/1880	6#0	0.9818	1.707
	20MHz	QPSK	18900/1880	6#0	1.1341	1.702
		16QAM	18900/1880	6#0	0.9710	1.554

Mode	Bandwidth	Modulation	Channel/ Frequency(MHz)	RB	Bandwidth(MHz)	
					99% Power	-26dBc
LTE Band 25	1.4MHz	QPSK	26365/1882.5	6#0	1.1015	1.331
		16QAM	26365/1882.5	6#0	0.9414	1.377
	3MHz	QPSK	26365/1882.5	6#0	1.1099	1.378
		16QAM	26365/1882.5	6#0	0.9537	1.187
	5MHz	QPSK	26365/1882.5	6#0	1.1106	1.352
		16QAM	26365/1882.5	6#0	0.9580	1.223
	10MHz	QPSK	26365/1882.5	6#0	1.1186	1.332
		16QAM	26365/1882.5	6#0	0.9750	1.299
	15MHz	QPSK	26365/1882.5	6#0	1.1330	1.634
		16QAM	26365/1882.5	6#0	0.9914	1.689
	20MHz	QPSK	26365/1882.5	6#0	1.1362	1.730
		16QAM	26365/1882.5	6#0	0.9688	1.694



LTE Band 2 1.4MHz QPSK CH-Middle

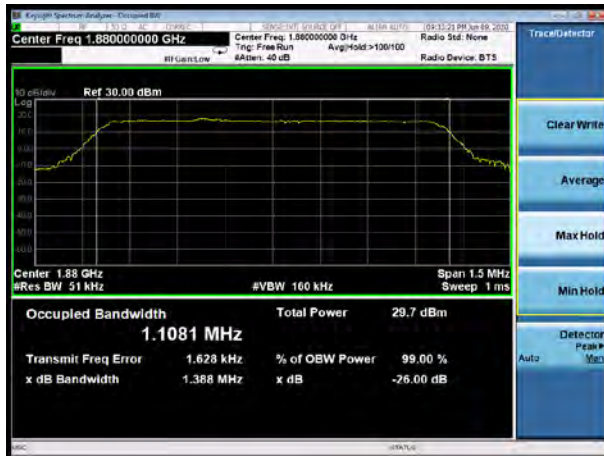

LTE Band 2 3MHz QPSK CH-Middle

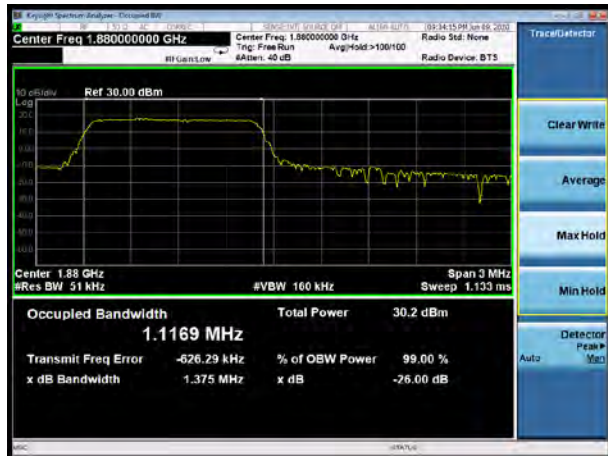

LTE Band 2 5MHz QPSK CH-Middle



LTE Band 2 10MHz QPSK CH-Middle



LTE Band 2 15MHz QPSK CH-Middle



LTE Band 2 20MHz QPSK CH-Middle



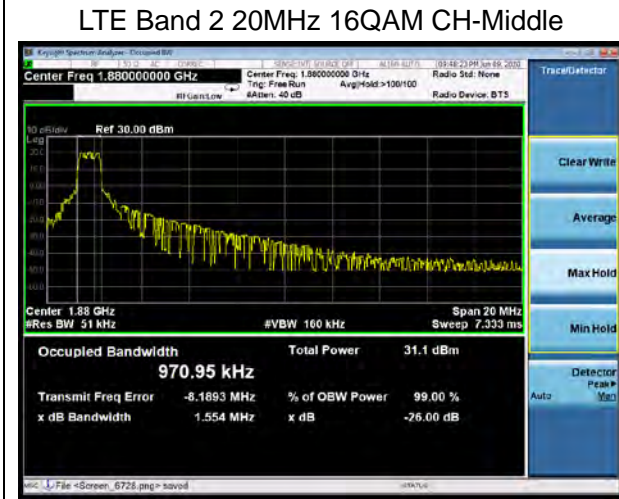
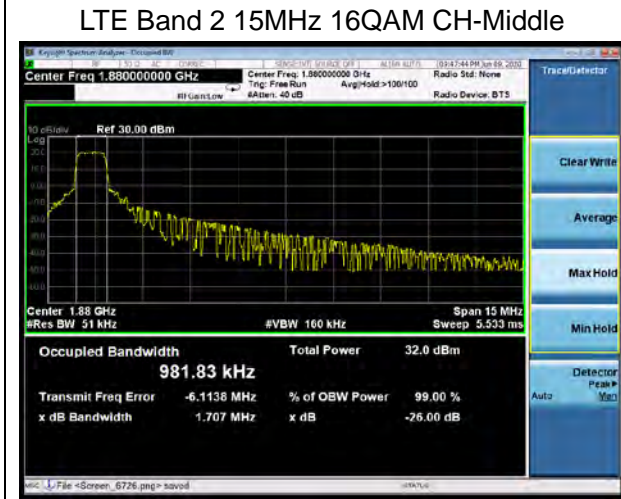
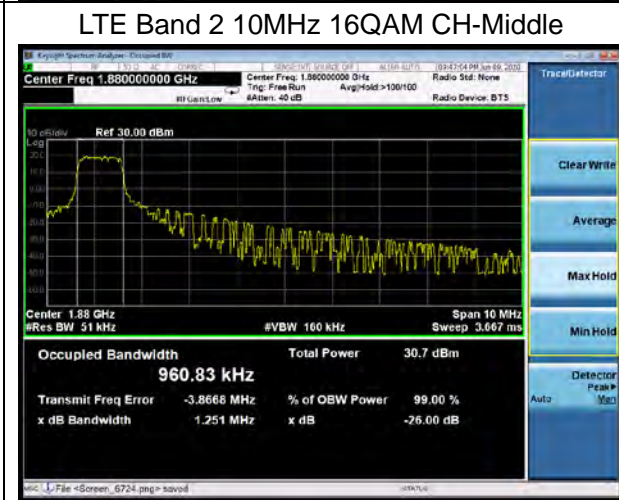
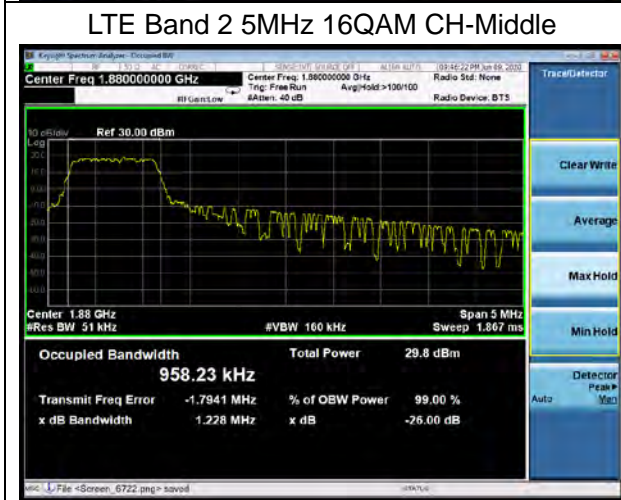
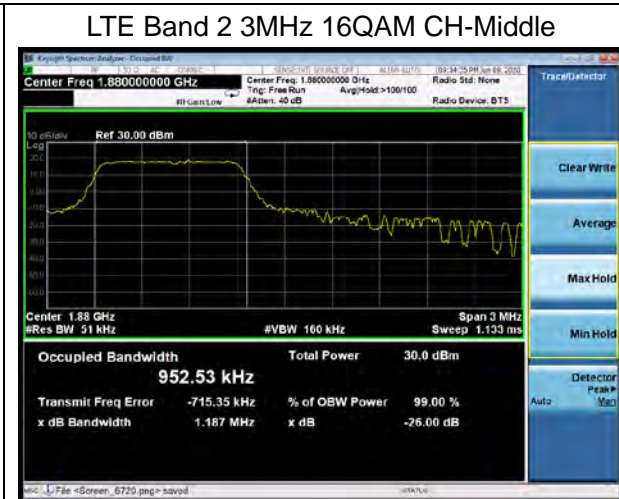
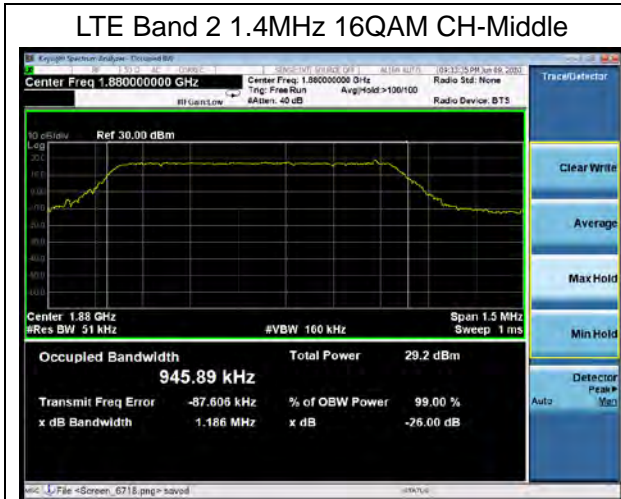



LTE Band 25 1.4MHz QPSK CH-Middle

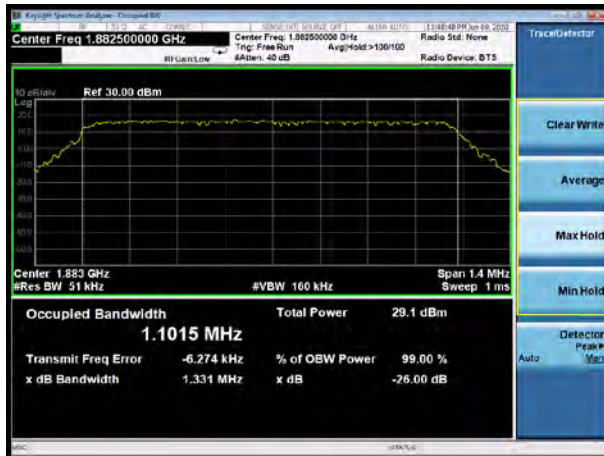

LTE Band 25 3MHz QPSK CH-Middle

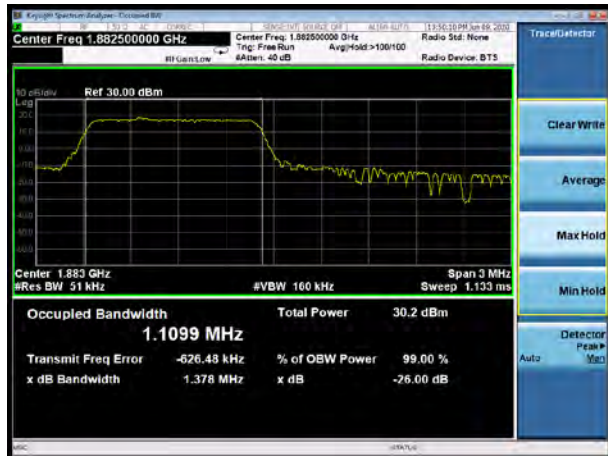

LTE Band 25 5MHz QPSK CH-Middle

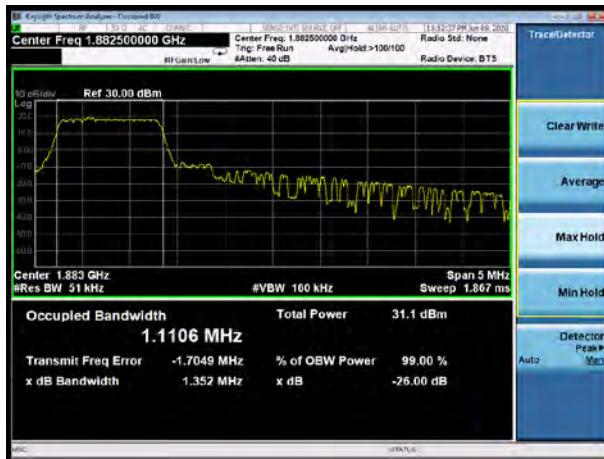

LTE Band 25 10MHz QPSK CH-Middle



LTE Band 25 15MHz QPSK CH-Middle

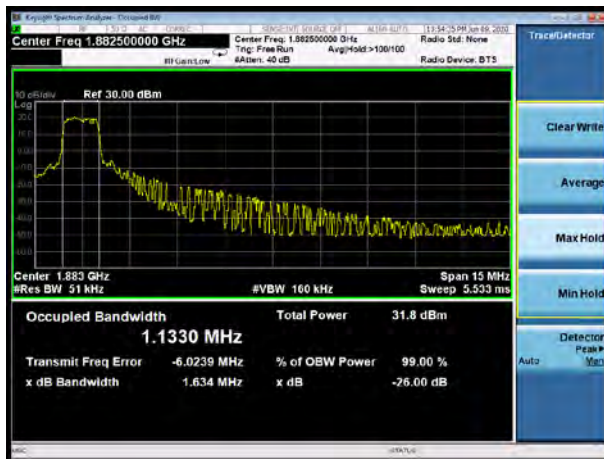

LTE Band 25 20MHz QPSK CH-Middle





LTE Band 25 1.4MHz 16QAM CH-Middle

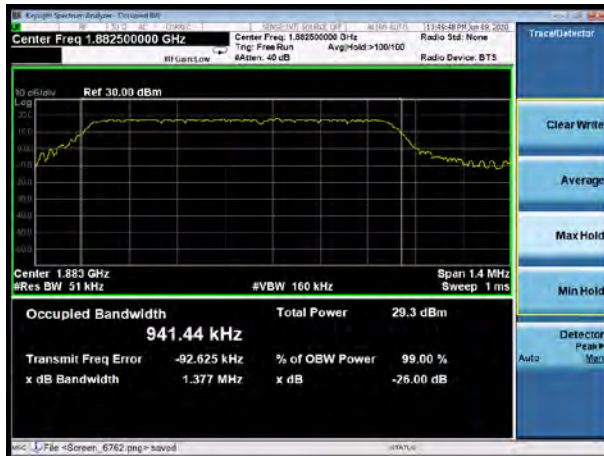

LTE Band 25 3MHz 16QAM CH-Middle



LTE Band 25 5MHz 16QAM CH-Middle



LTE Band 25 10MHz 16QAM CH-Middle



LTE Band 25 15MHz 16QAM CH-Middle

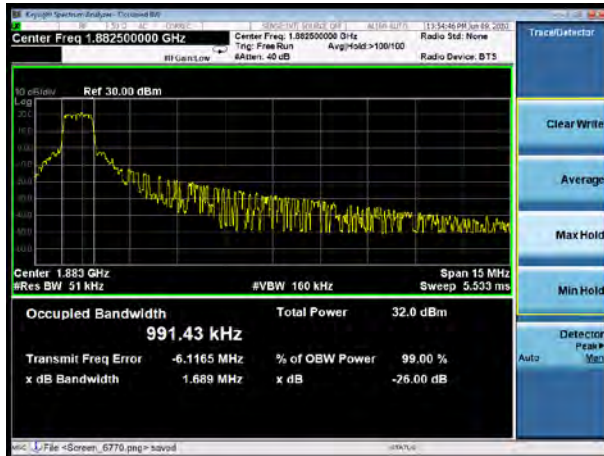

LTE Band 25 20MHz 16QAM CH-Middle

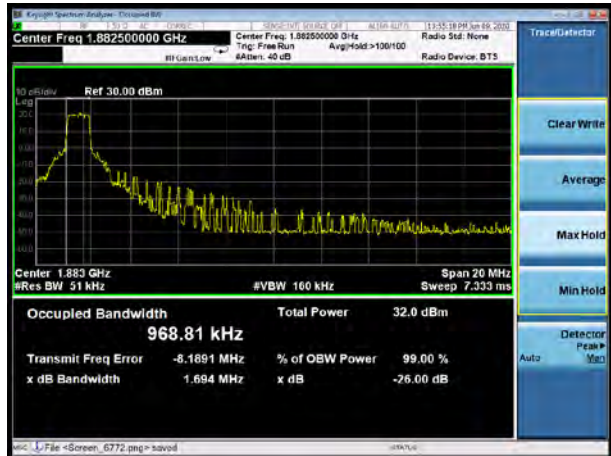

5.3. Band Edge Compliance

Ambient condition

Temperature	Relative humidity	Pressure
23°C ~25°C	45%~50%	101.5kPa

Method of Measurement

The EUT was connected to Spectrum Analyzer and Base Station Simulator via power Splitter. The band edge of the lowest and highest channels were measured. The Average detector is used and RBW is set to 51kHz, VBW is set to 160kHz for LTE Band 2/25,

Spectrum analyzer plots are included on the following pages.

Test Setup

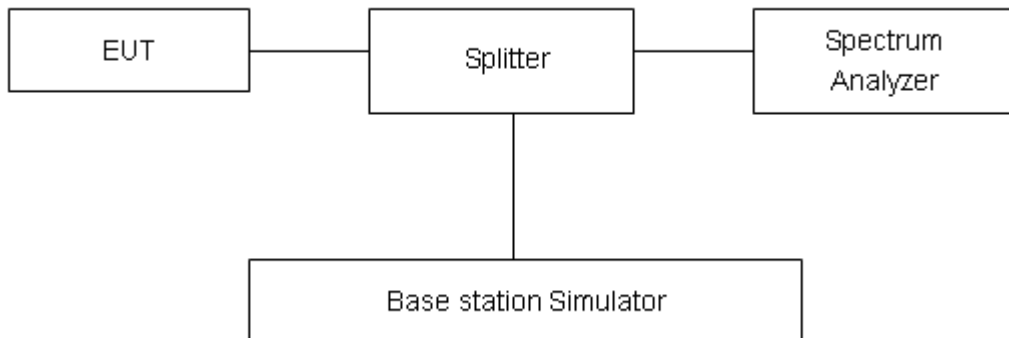

Limits

Rule Part 24.238(a) specifies that “on any frequency outside a licensee's frequency block, the power of any emission shall be attenuated below the transmitter power (P) by at least $43 + 10 \log_{10} (P)$ dB.”

Limit	-13 dBm
-------	---------

Measurement Uncertainty

The assessed measurement uncertainty to ensure 95% confidence level for the normal distribution is with the coverage factor $k = 1.96$, $U=0.684$ dB.

Test Result:

LTE Band 2 1.4MHz QPSK 1RB CH-Low

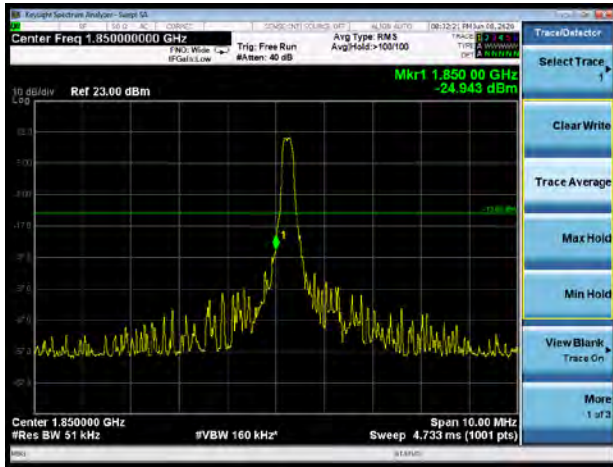

LTE Band 2 1.4MHz QPSK 1RB CH-High

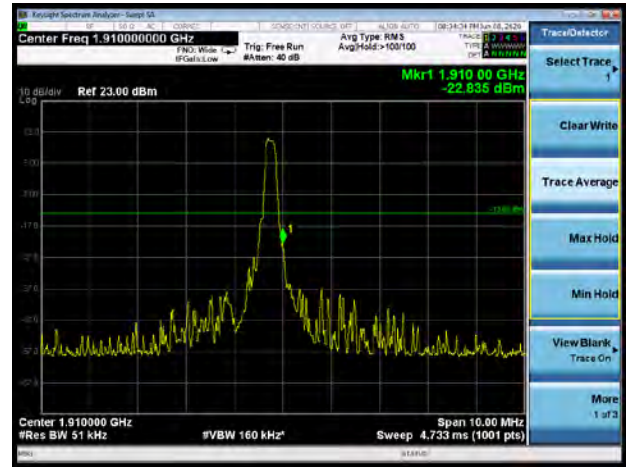

LTE Band 2 1.4MHz QPSK 100%RB CH-Low

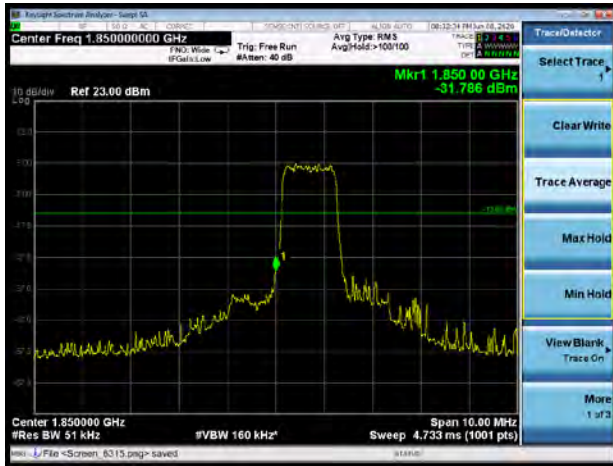

LTE Band 2 1.4MHz QPSK 100%RB CH-High

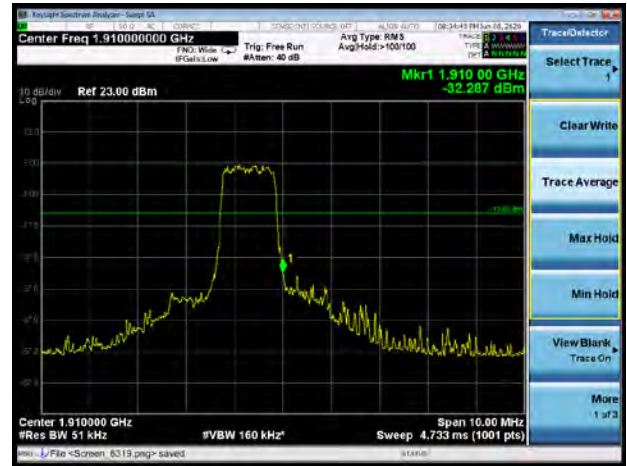

LTE Band 2 3MHz QPSK 1RB CH-Low

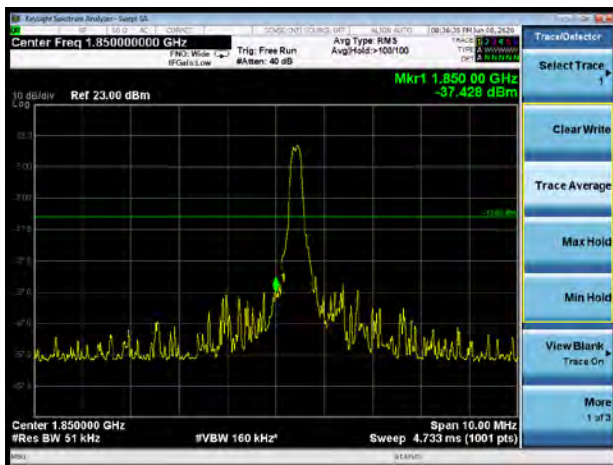

LTE Band 2 3MHz QPSK 1RB CH-High

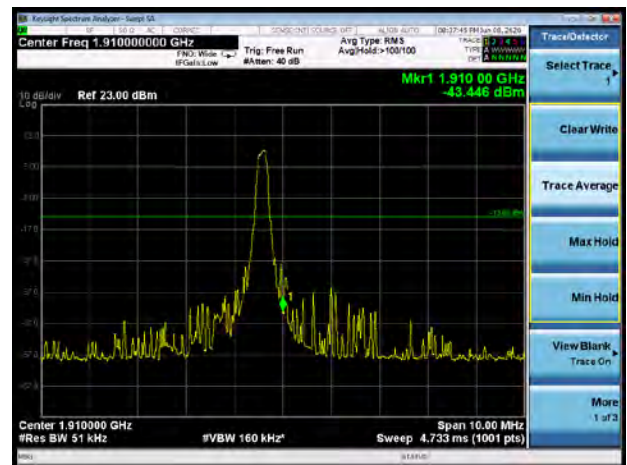



LTE Band 2 3MHz QPSK 100%RB CH-Low

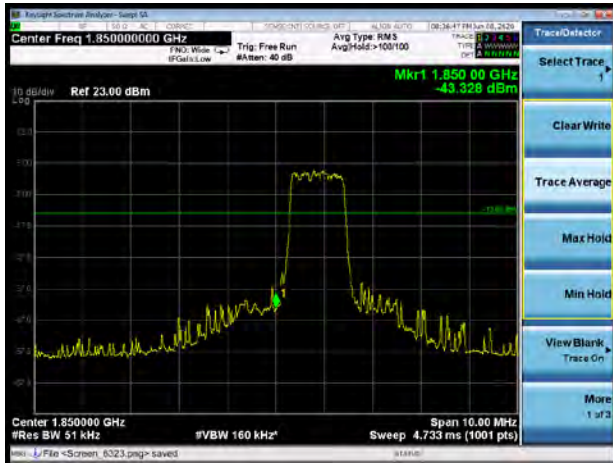

LTE Band 2 3MHz QPSK 100%RB CH-High

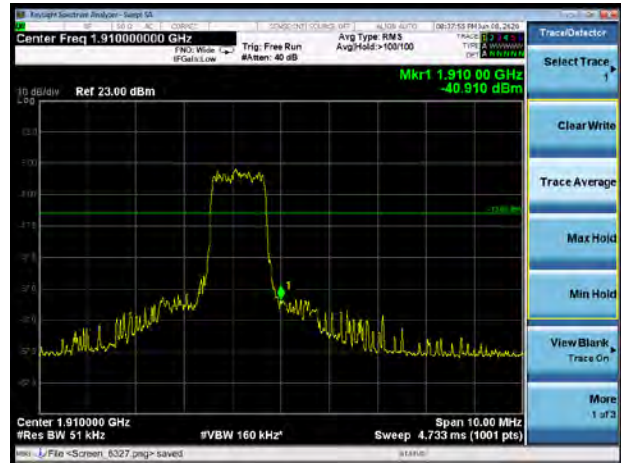

LTE Band 2 5MHz QPSK 1RB CH-Low

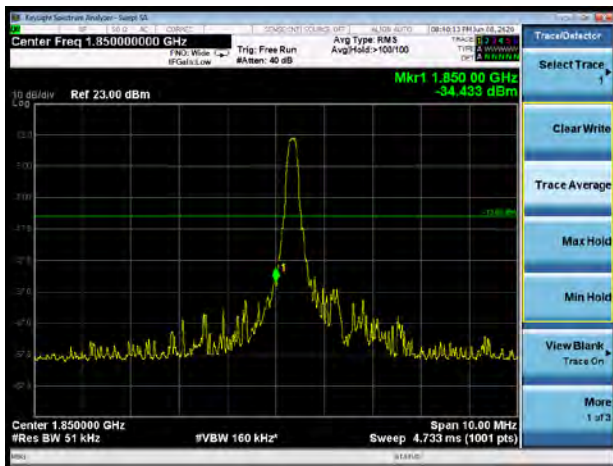

LTE Band 2 5MHz QPSK 1RB CH-High

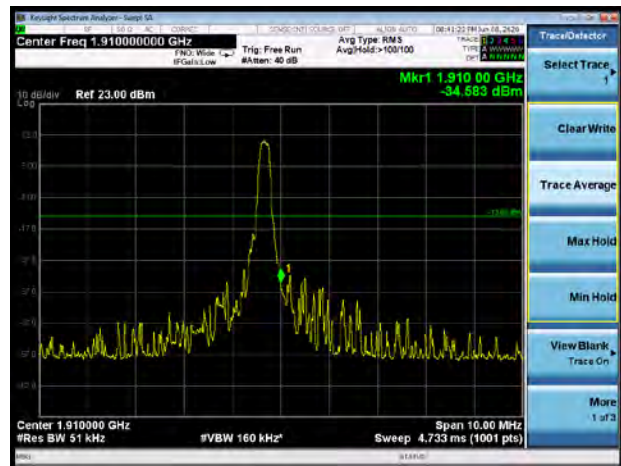

LTE Band 2 5MHz QPSK 100%RB CH-Low

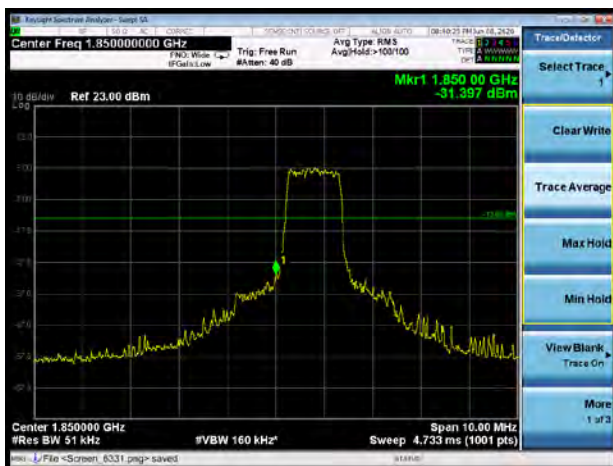

LTE Band 2 5MHz QPSK 100%RB CH-High

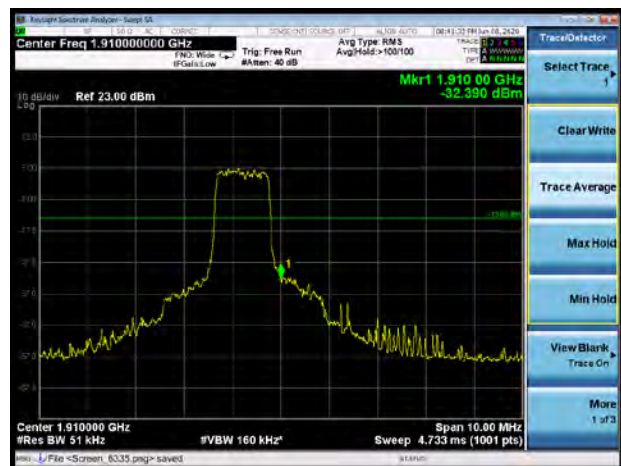



LTE Band 2 10MHz QPSK 1RB CH-Low

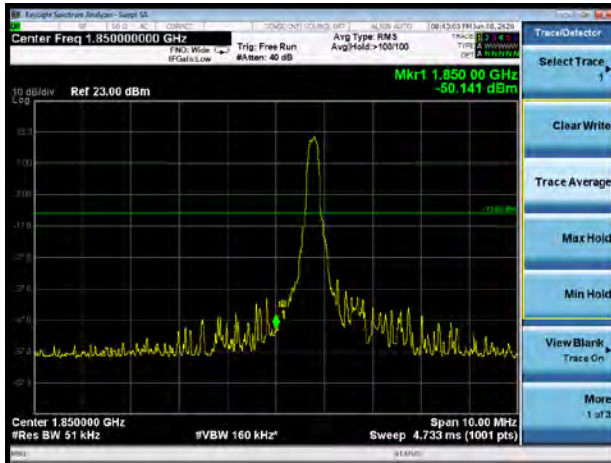

LTE Band 2 10MHz QPSK 1RB CH-High

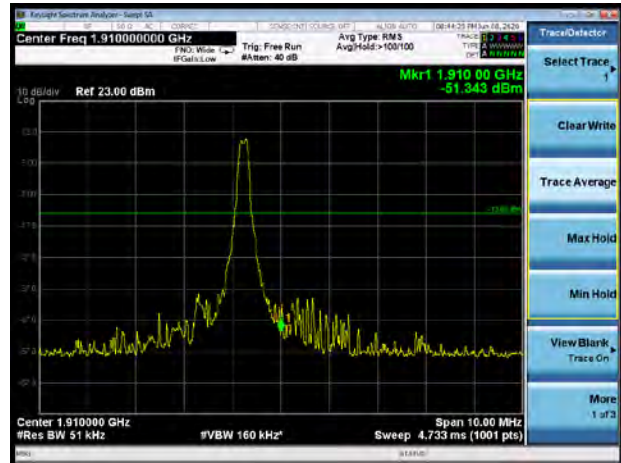

LTE Band 2 10MHz QPSK 100%RB CH-Low

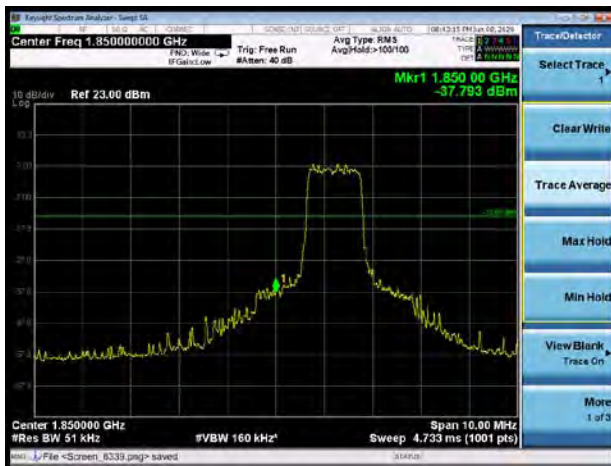

LTE Band 2 10MHz QPSK 100%RB CH-High

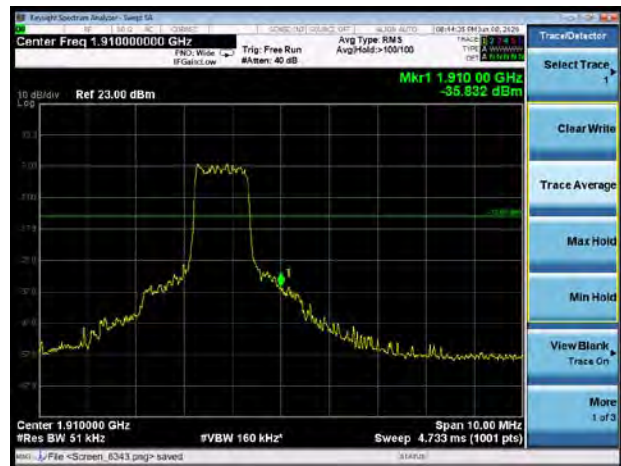

LTE Band 2 15MHz QPSK 1RB CH-Low

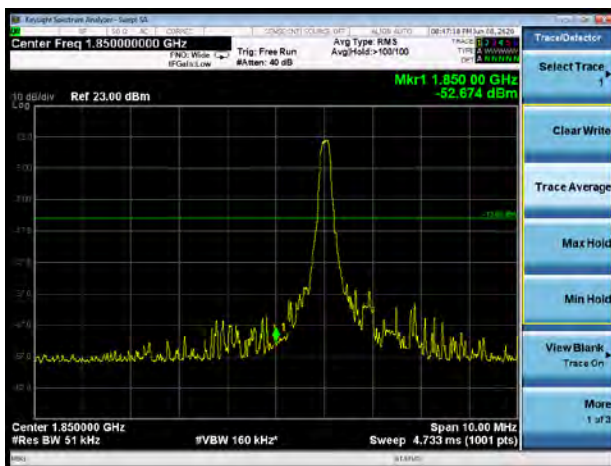

LTE Band 2 15MHz QPSK 1RB CH-High

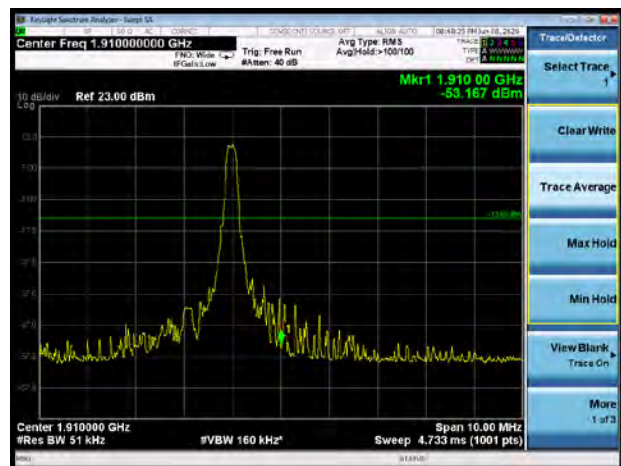



LTE Band 2 15MHz QPSK 100%RB CH-Low

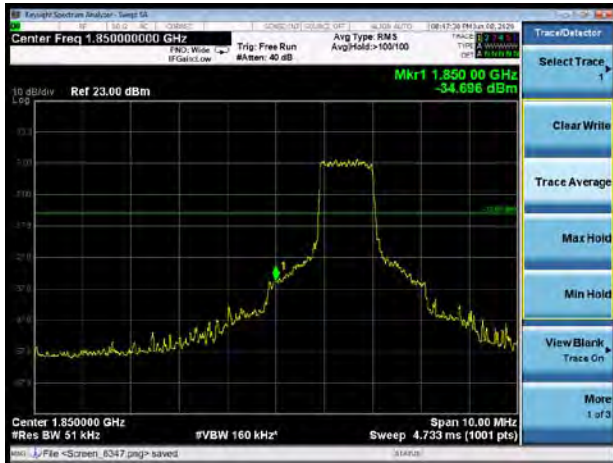

LTE Band 2 15MHz QPSK 100%RB CH-High

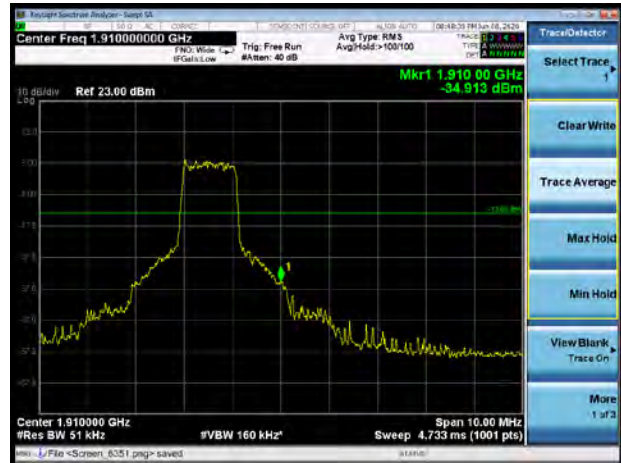

LTE Band 2 20MHz QPSK 1RB CH-Low

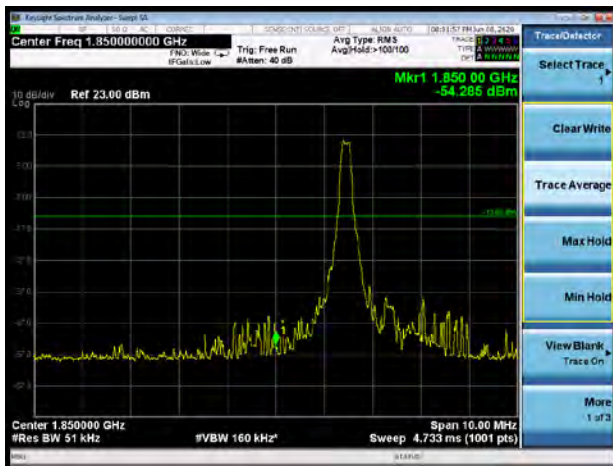

LTE Band 2 20MHz QPSK 1RB CH-High

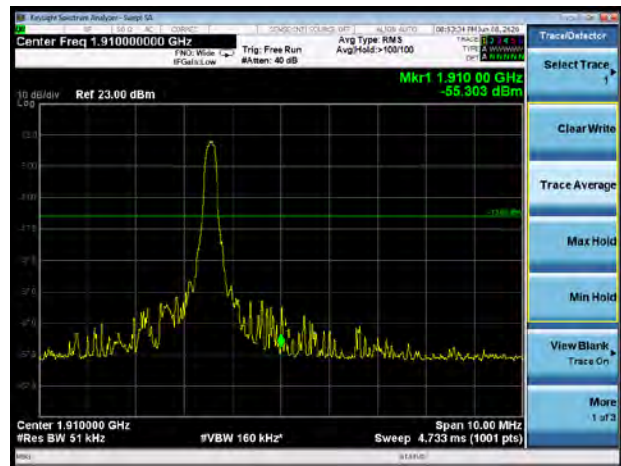

LTE Band 2 20MHz QPSK 100%RB CH-Low



LTE Band 2 20MHz QPSK 100%RB CH-High

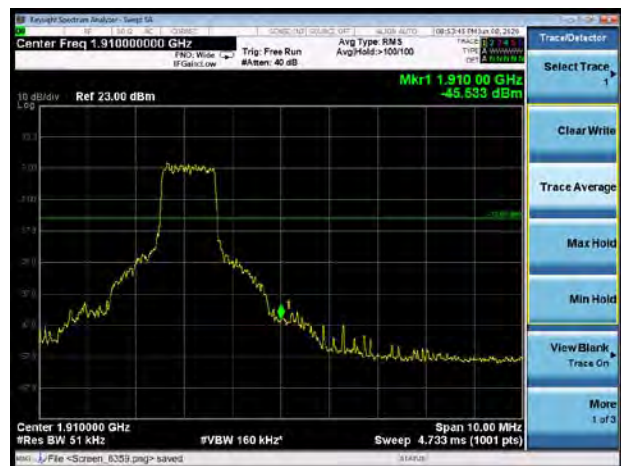



LTE Band 2 1.4MHz 16QAM 1RB CH-Low

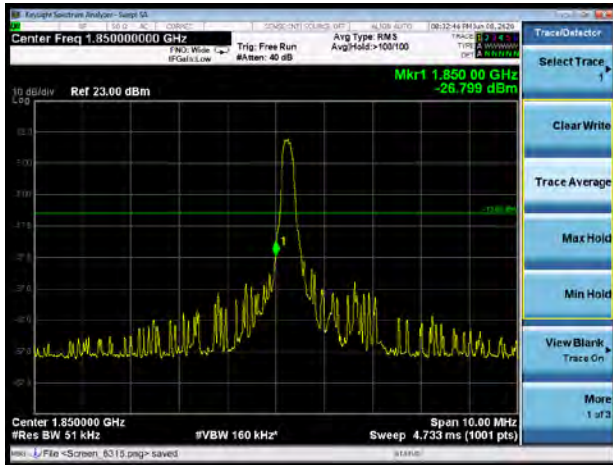

LTE Band 2 1.4MHz 16QAM 1RB CH-High

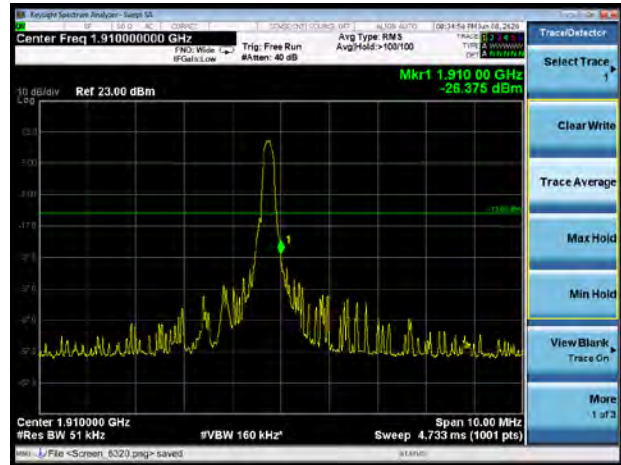

LTE Band 2 1.4MHz 16QAM 100%RB CH-Low

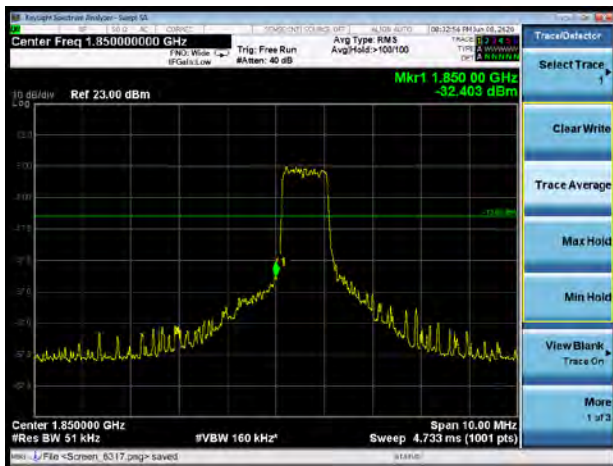

LTE Band 2 1.4MHz 16QAM 100%RB CH-High

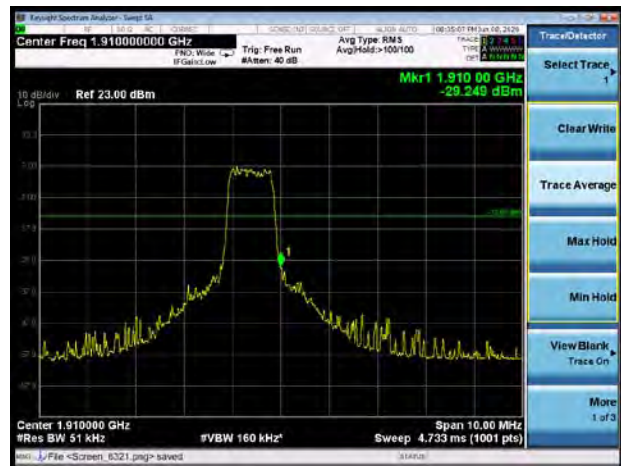

LTE Band 2 3MHz 16QAM 1RB CH-Low

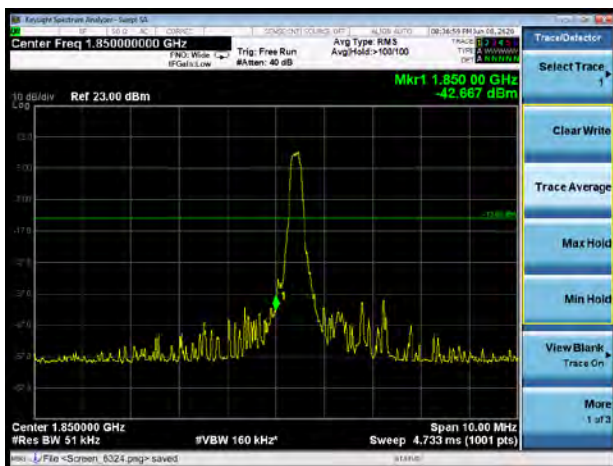

LTE Band 2 3MHz 16QAM 1RB CH-High

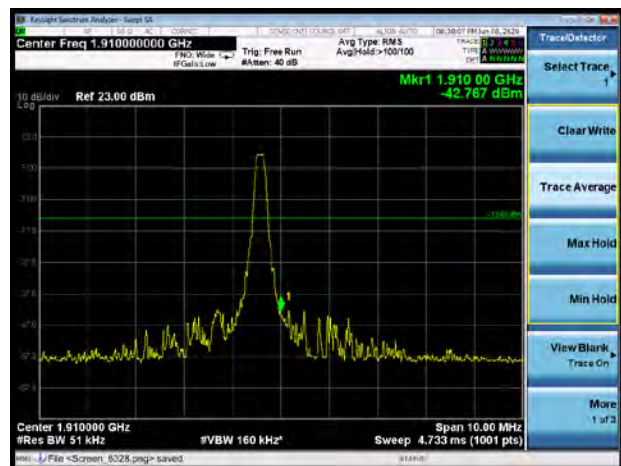



LTE Band 2 3MHz 16QAM 100%RB CH-Low

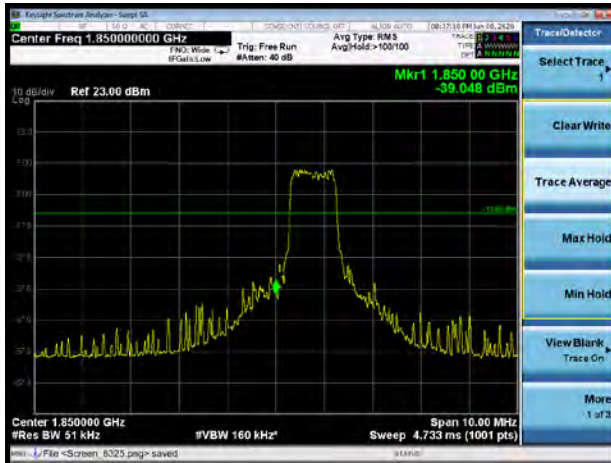

LTE Band 2 3MHz 16QAM 100%RB CH-High

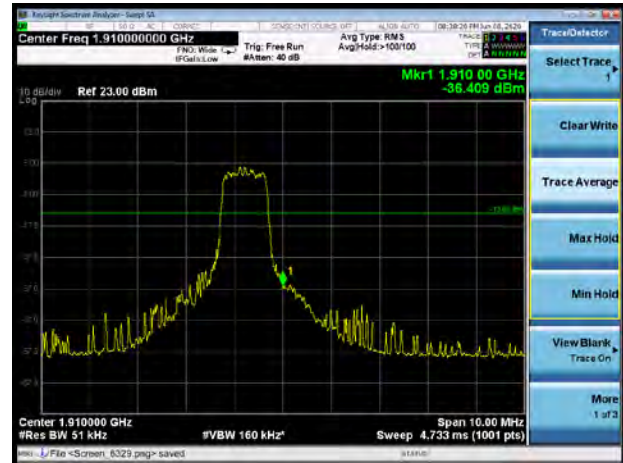

LTE Band 2 5MHz 16QAM 1RB CH-Low

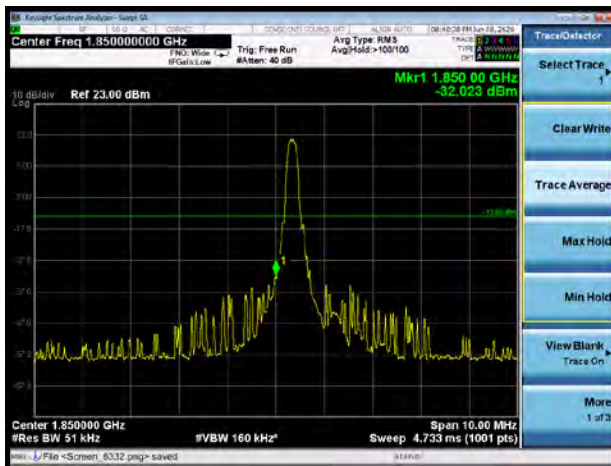

LTE Band 2 5MHz 16QAM 1RB CH-High

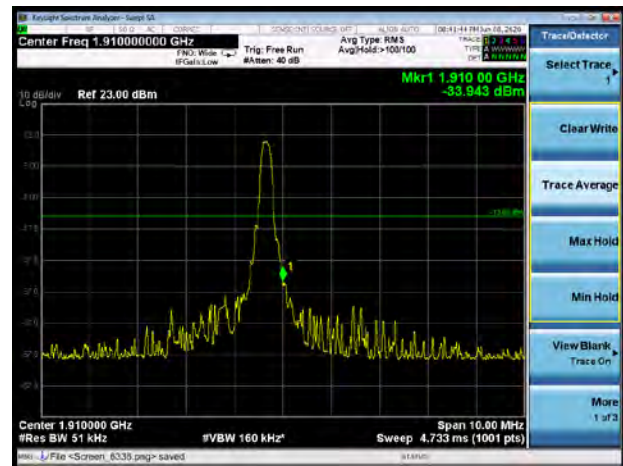

LTE Band 2 5MHz 16QAM 100%RB CH-Low

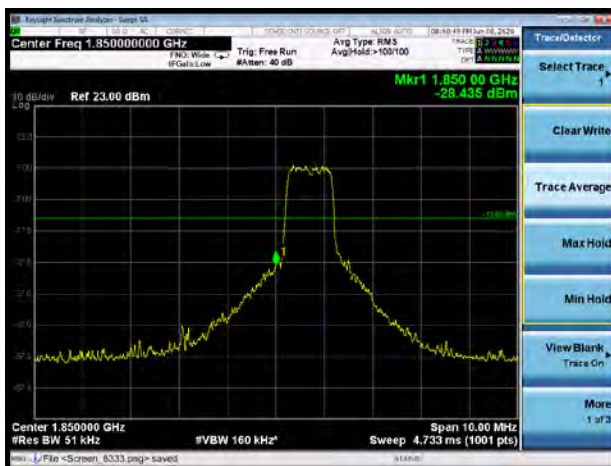

LTE Band 2 5MHz 16QAM 100%RB CH-High

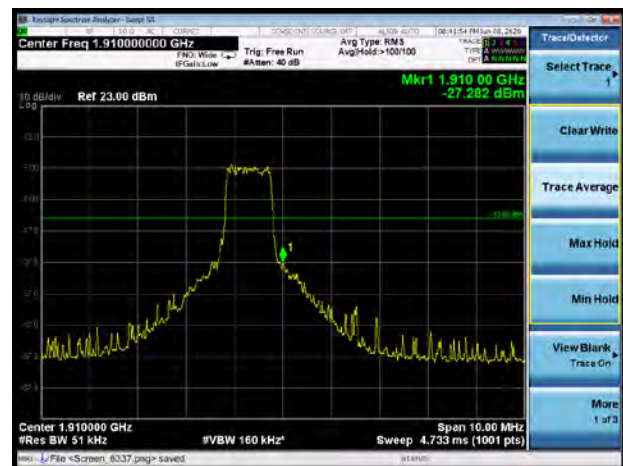

LTE Band 2 10MHz 16QAM 1RB CH-Low

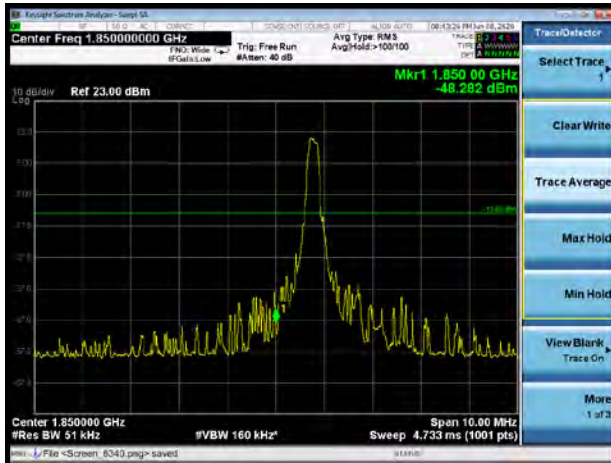

LTE Band 2 10MHz 16QAM 1RB CH-High

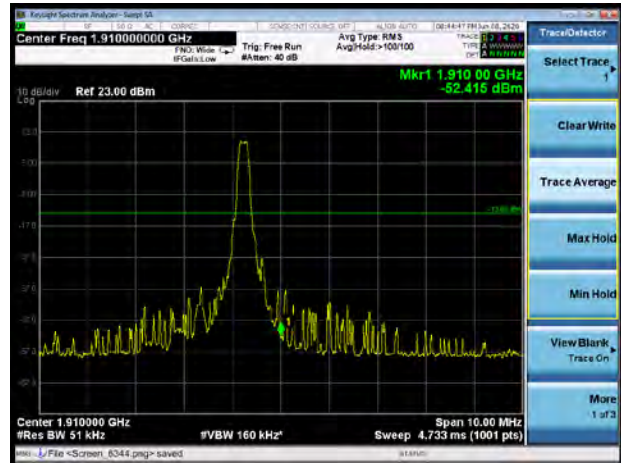

LTE Band 2 10MHz 16QAM 100%RB CH-Low

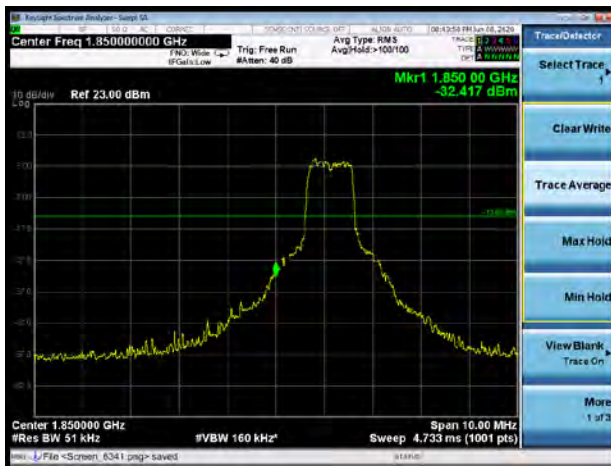

LTE Band 2 10MHz 16QAM 100%RB CH-High



LTE Band 2 15MHz 16QAM 1RB CH-Low

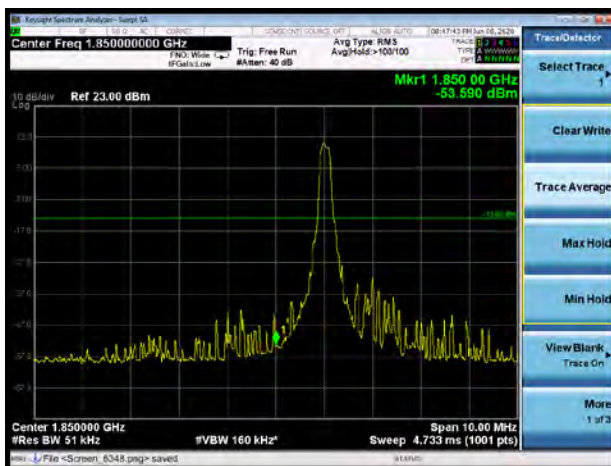

LTE Band 2 15MHz 16QAM 1RB CH-High

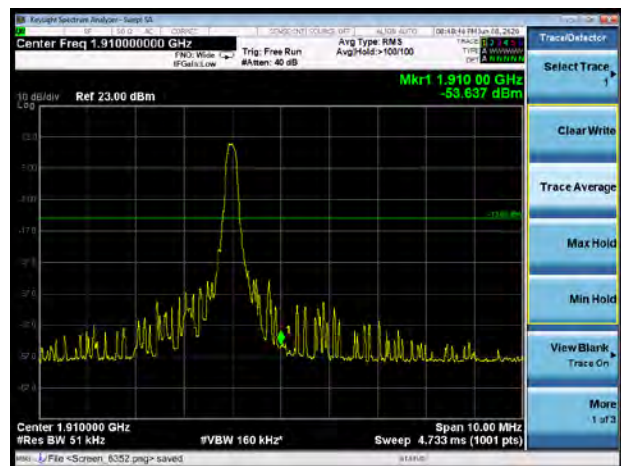

LTE Band 2 15MHz 16QAM 100%RB CH-Low

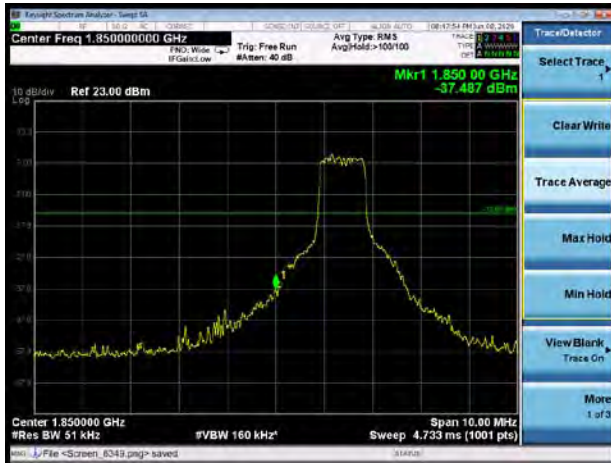

LTE Band 2 15MHz 16QAM 100%RB CH-High

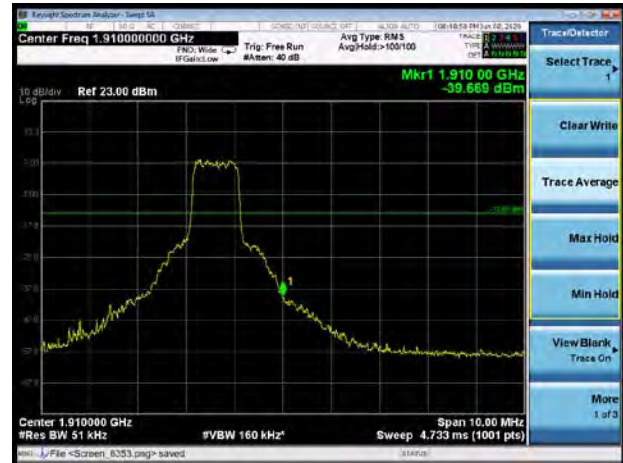

LTE Band 2 20MHz 16QAM 1RB CH-Low

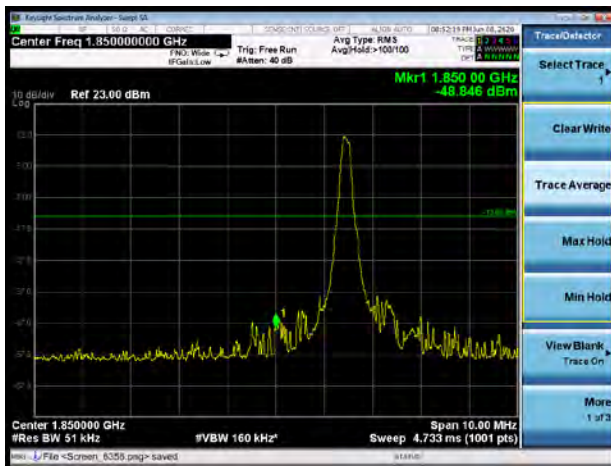

LTE Band 2 20MHz 16QAM 1RB CH-High

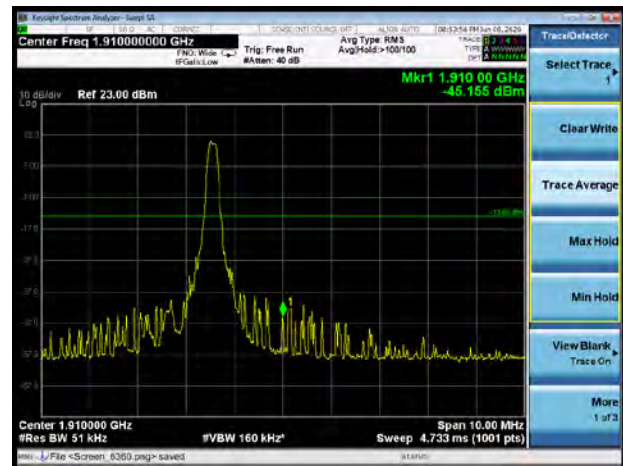

LTE Band 2 20MHz 16QAM 100%RB CH-Low

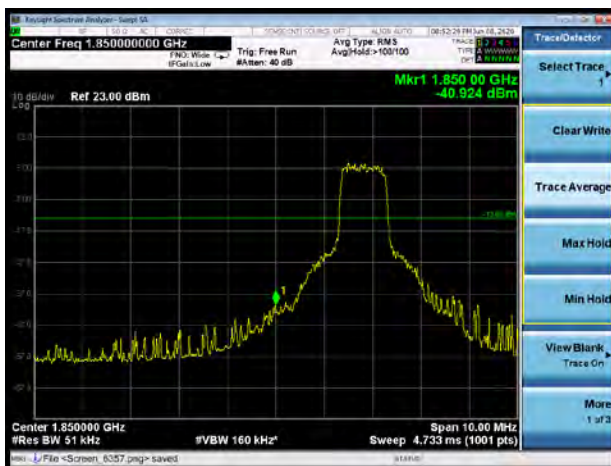

LTE Band 2 20MHz 16QAM 100%RB CH-High





LTE Band 25 1.4MHz QPSK 1RB CH-Low

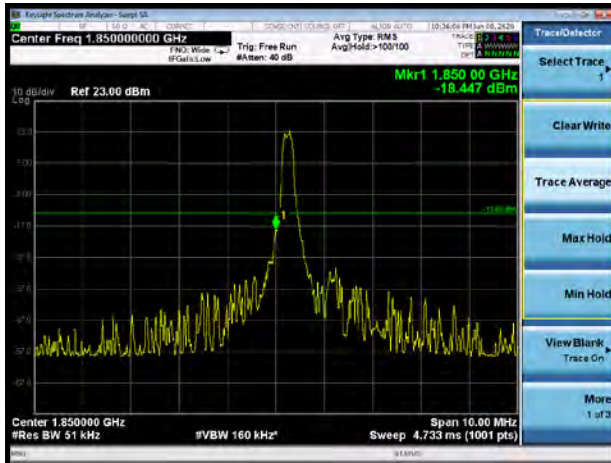

LTE Band 25 1.4MHz QPSK 1RB CH-High

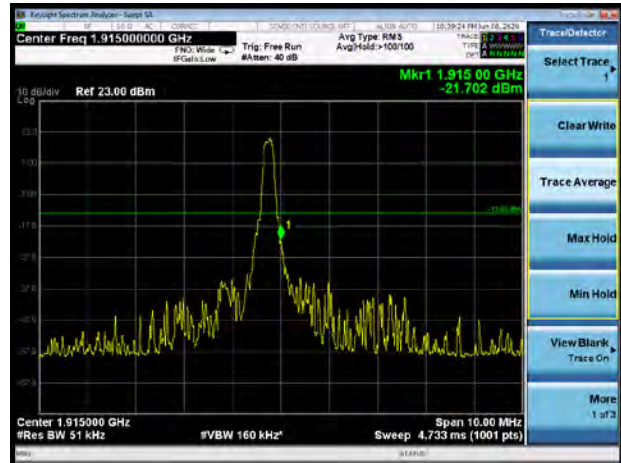

LTE Band 25 1.4MHz QPSK 100%RB CH-Low

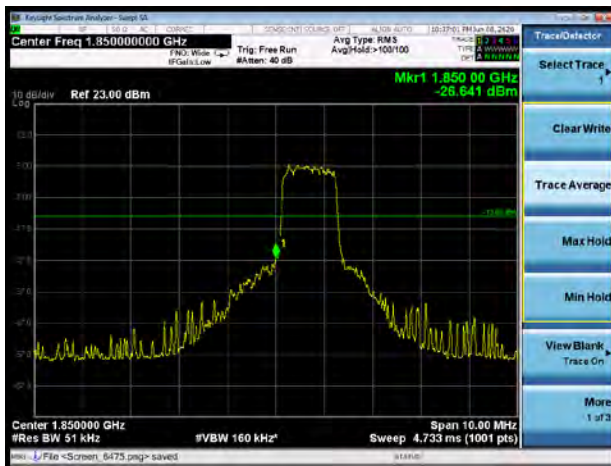

LTE Band 25 1.4MHz QPSK 100%RB CH-High

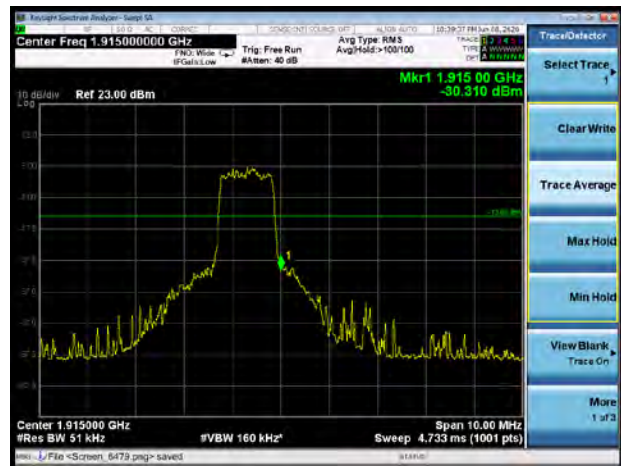

LTE Band 25 3MHz QPSK 1RB CH-Low

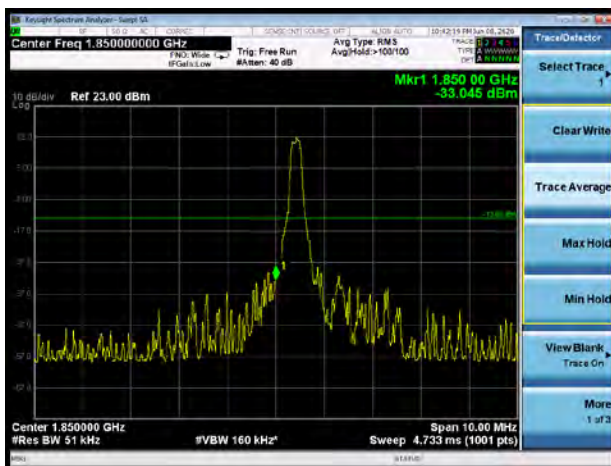

LTE Band 25 3MHz QPSK 1RB CH-High

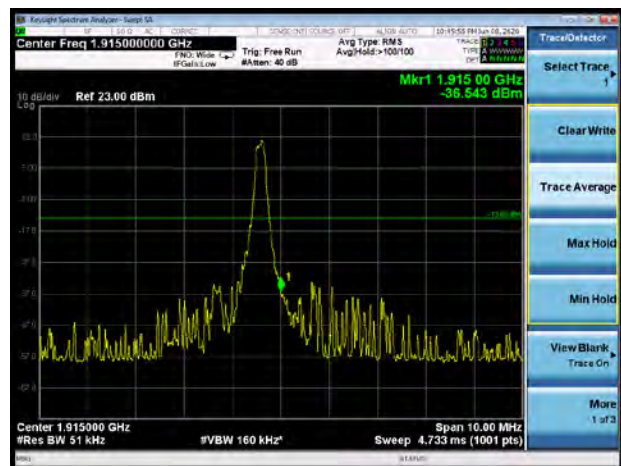



LTE Band 25 3MHz QPSK 100%RB CH-Low

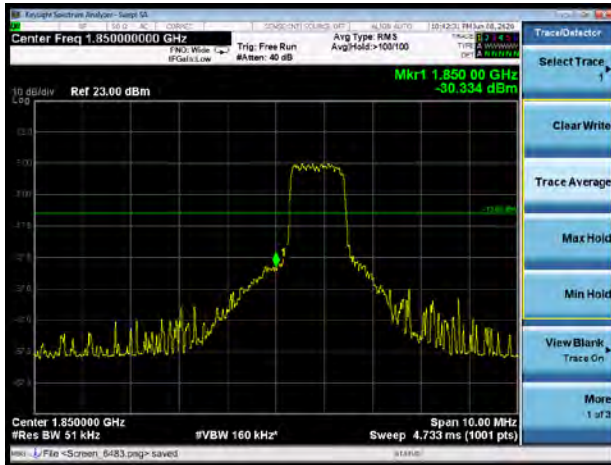

LTE Band 25 3MHz QPSK 100%RB CH-High

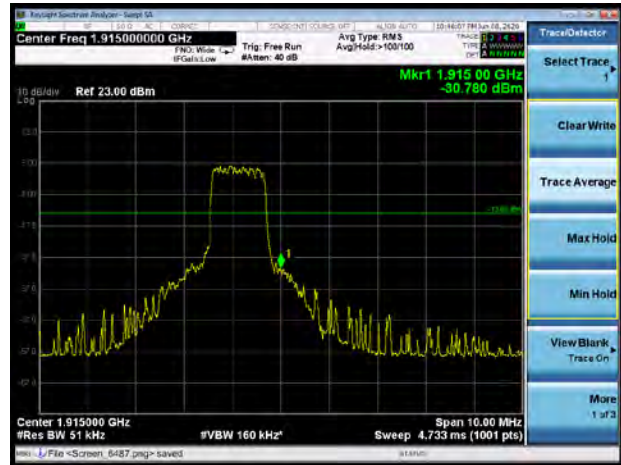

LTE Band 25 5MHz QPSK 1RB CH-Low

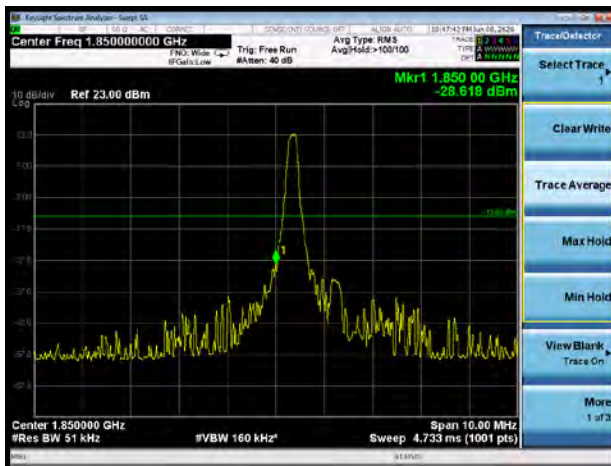

LTE Band 25 5MHz QPSK 1RB CH-High

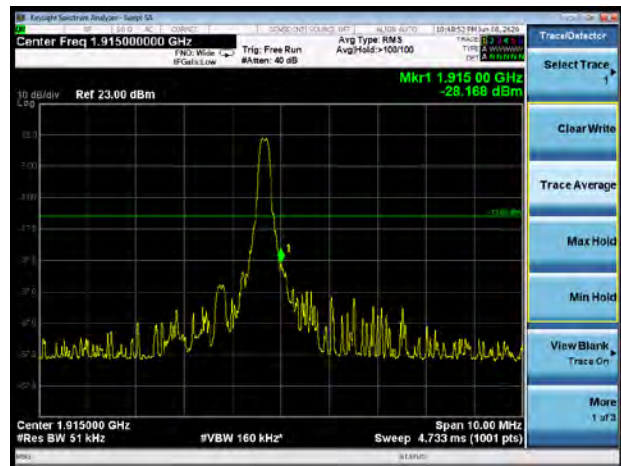

LTE Band 25 5MHz QPSK 100%RB CH-Low

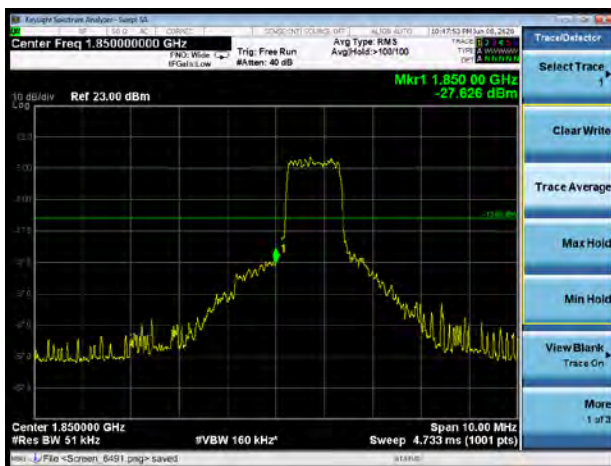

LTE Band 25 5MHz QPSK 100%RB CH-High

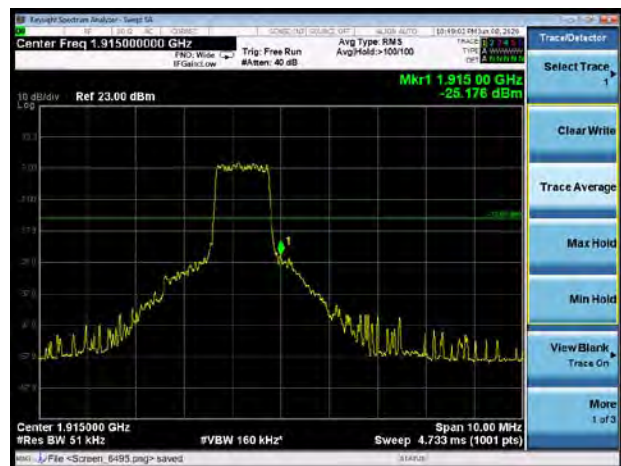



LTE Band 25 10MHz QPSK 1RB CH-Low

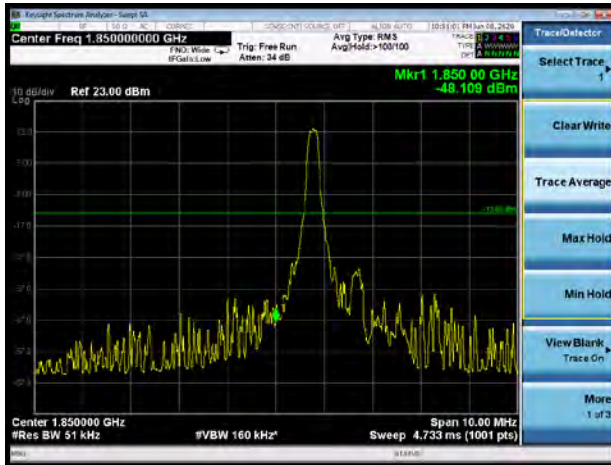

LTE Band 25 10MHz QPSK 1RB CH-High

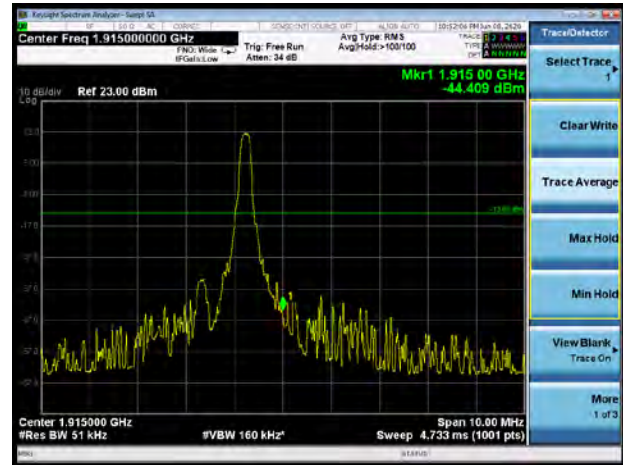

LTE Band 25 10MHz QPSK 100%RB CH-Low

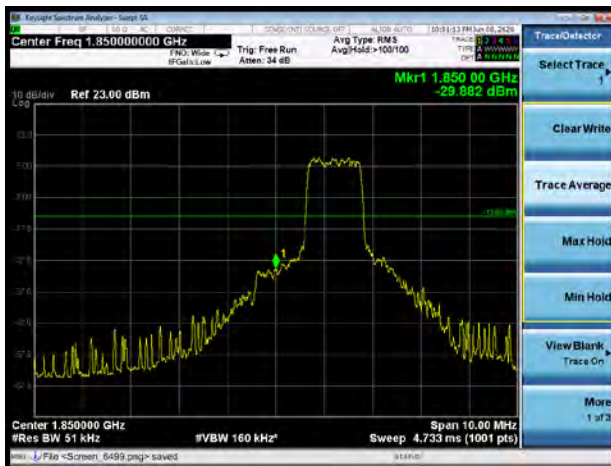

LTE Band 25 10MHz QPSK 100%RB CH-High

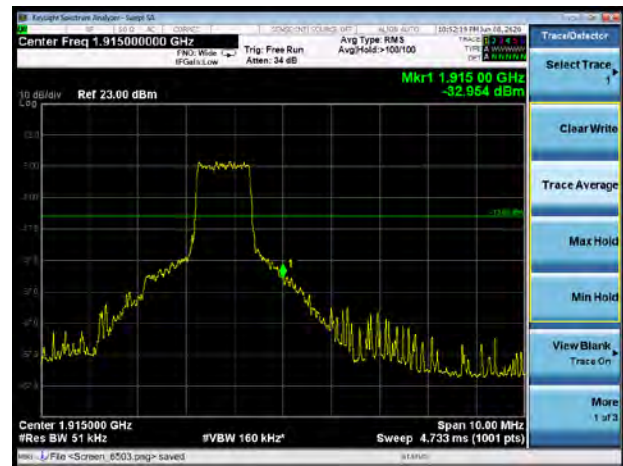

LTE Band 25 15MHz QPSK 1RB CH-Low

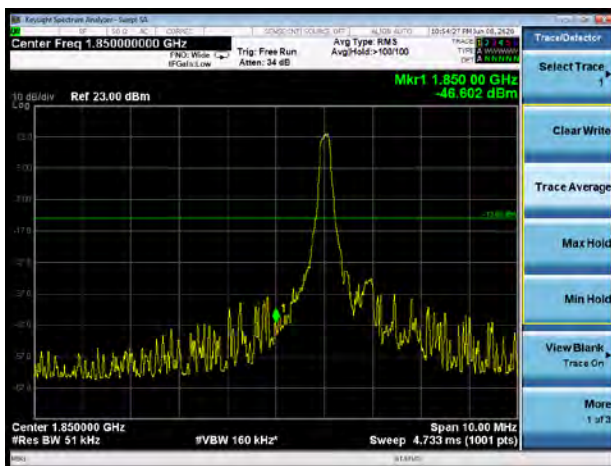

LTE Band 25 15MHz QPSK 1RB CH-High

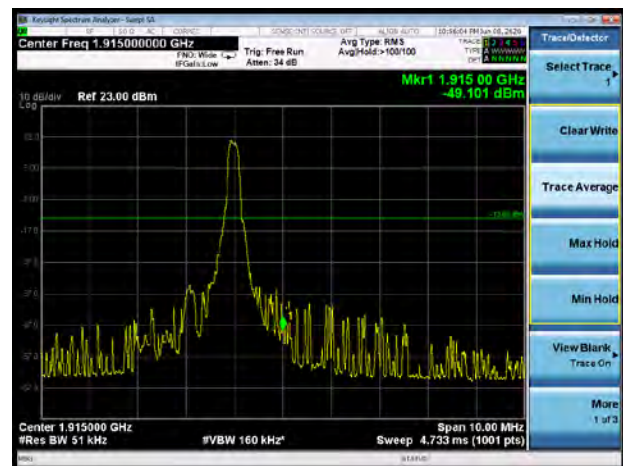



LTE Band 25 15MHz QPSK 100%RB CH-Low

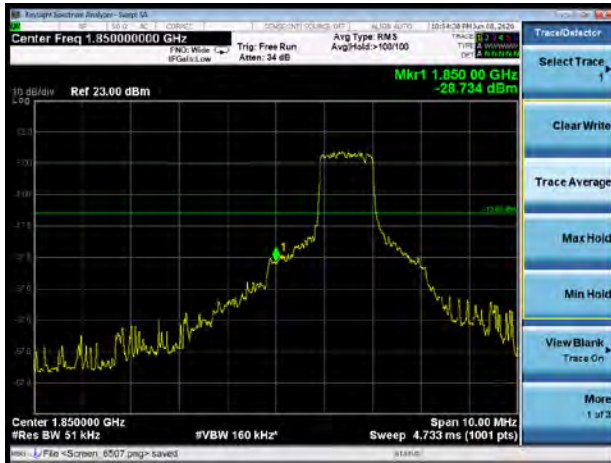

LTE Band 25 15MHz QPSK 100%RB CH-High

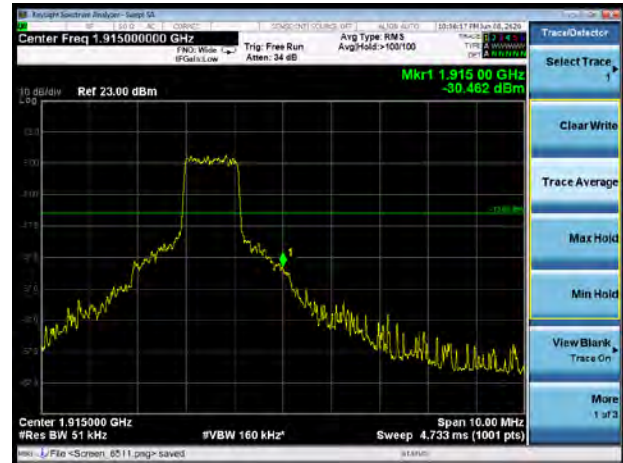

LTE Band 25 20MHz QPSK 1RB CH-Low

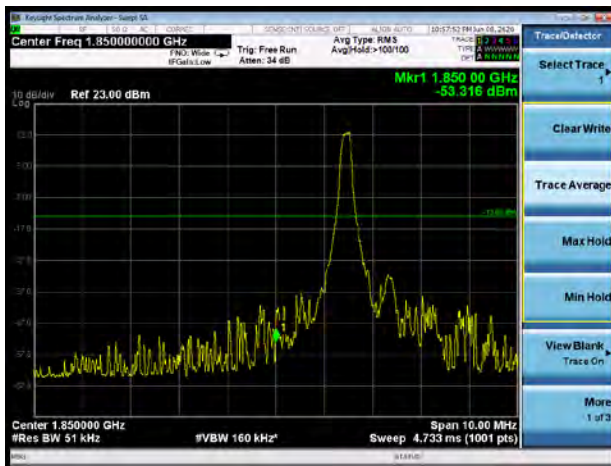

LTE Band 25 20MHz QPSK 1RB CH-High

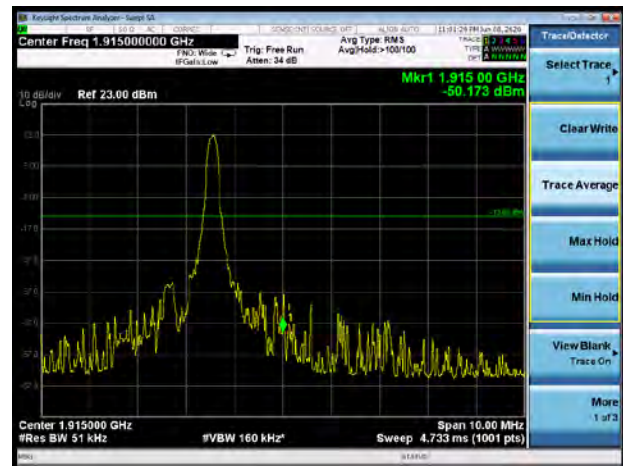

LTE Band 25 20MHz QPSK 100%RB CH-Low

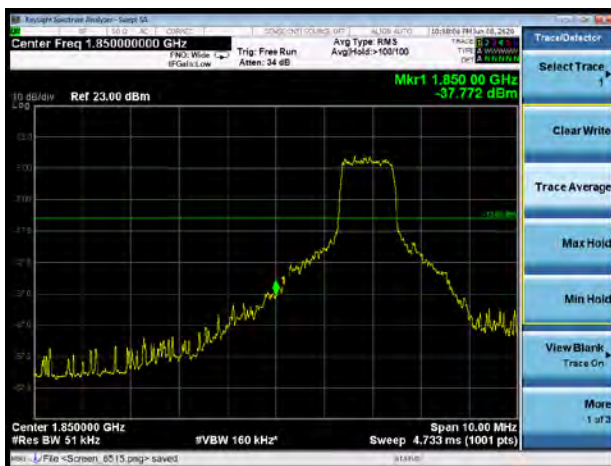

LTE Band 25 20MHz QPSK 100%RB CH-High

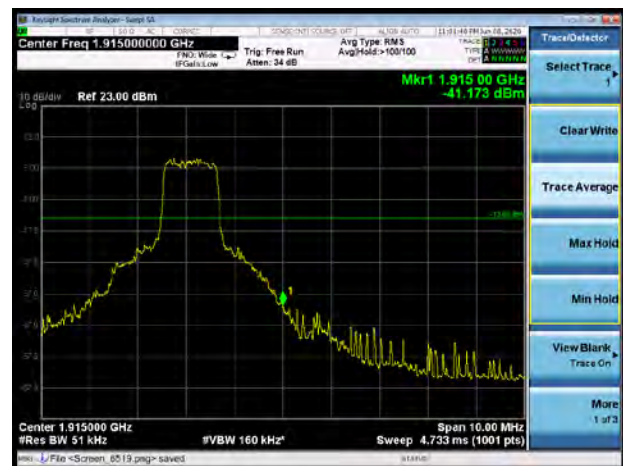



LTE Band 25 1.4MHz 16QAM 1RB CH-Low

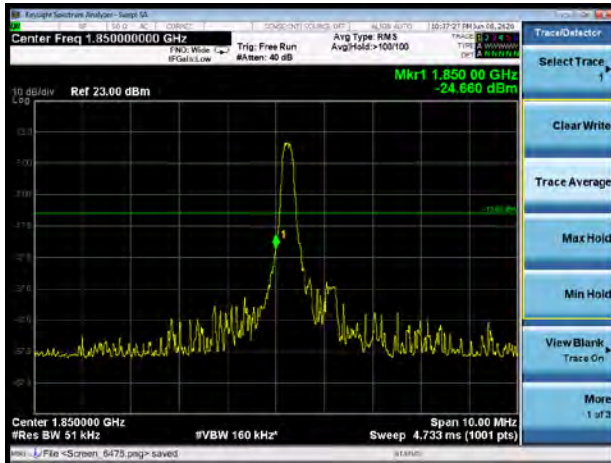

LTE Band 25 1.4MHz 16QAM 1RB CH-High

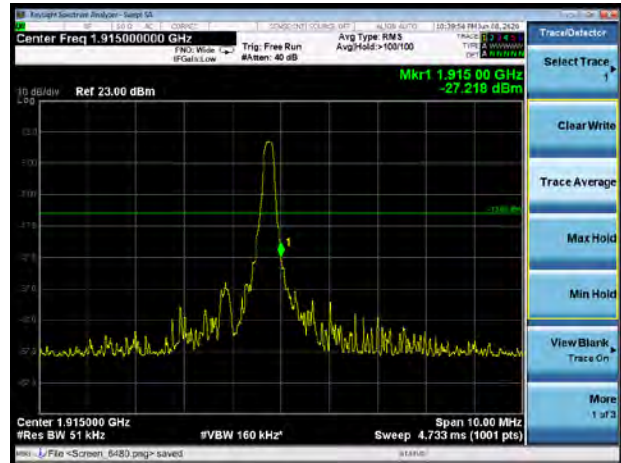

LTE Band 25 1.4MHz 16QAM 100%RB CH-Low

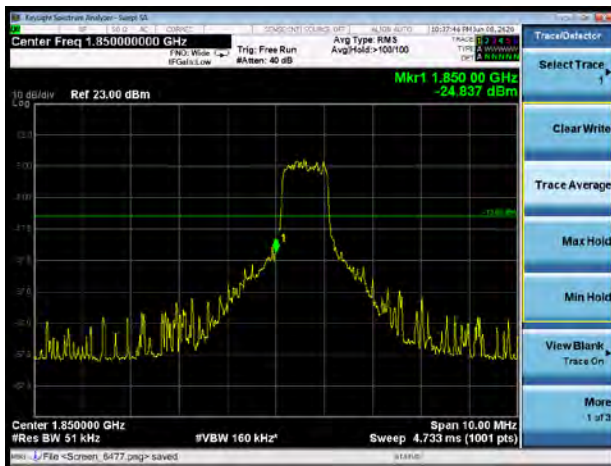

LTE Band 25 1.4MHz 16QAM 100%RB CH-High

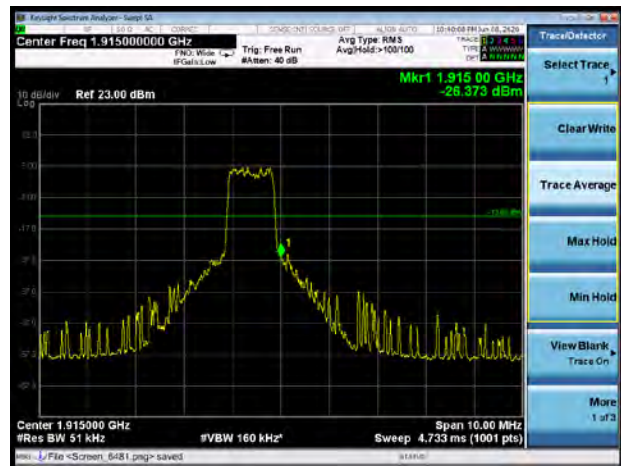

LTE Band 25 3MHz 16QAM 1RB CH-Low

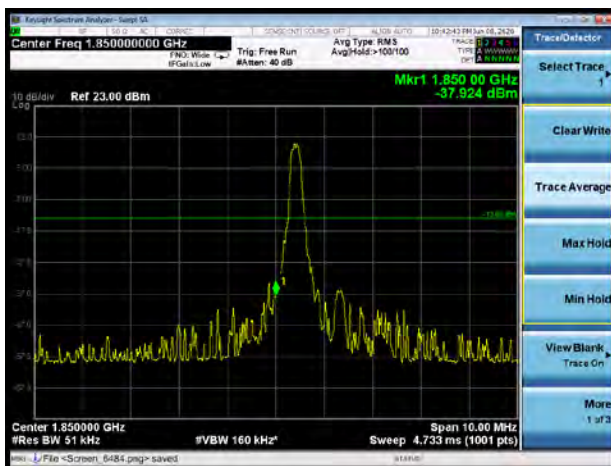

LTE Band 25 3MHz 16QAM 1RB CH-High

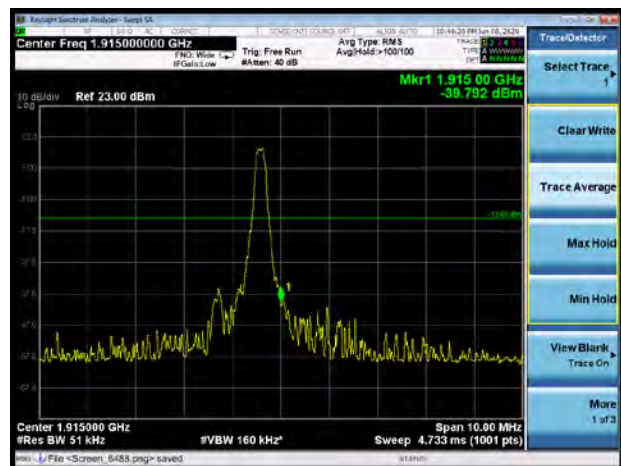



LTE Band 25 3MHz 16QAM 100%RB CH-Low

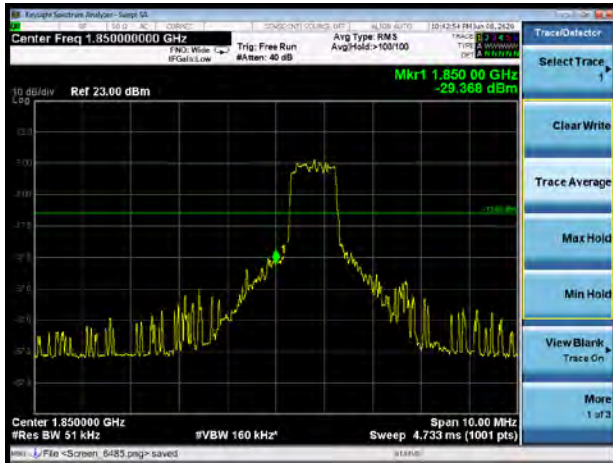

LTE Band 25 3MHz 16QAM 100%RB CH-High

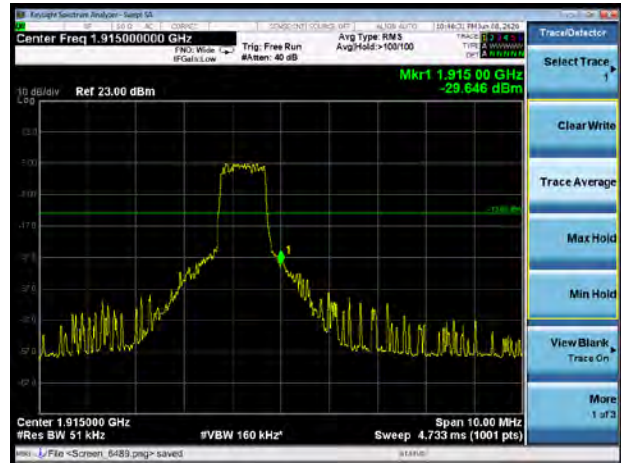

LTE Band 25 5MHz 16QAM 1RB CH-Low



LTE Band 25 5MHz 16QAM 1RB CH-High

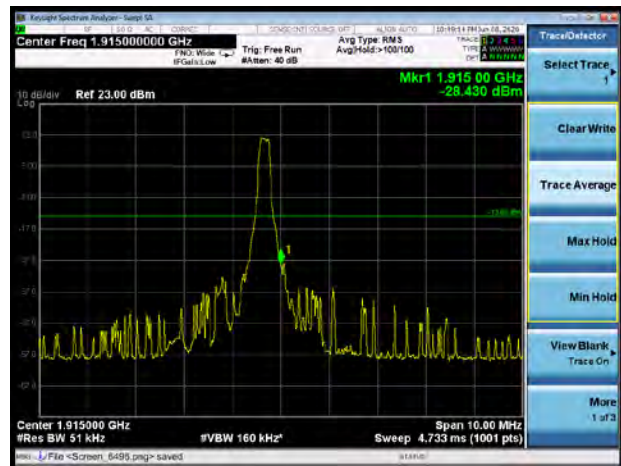

LTE Band 25 5MHz 16QAM 100%RB CH-Low

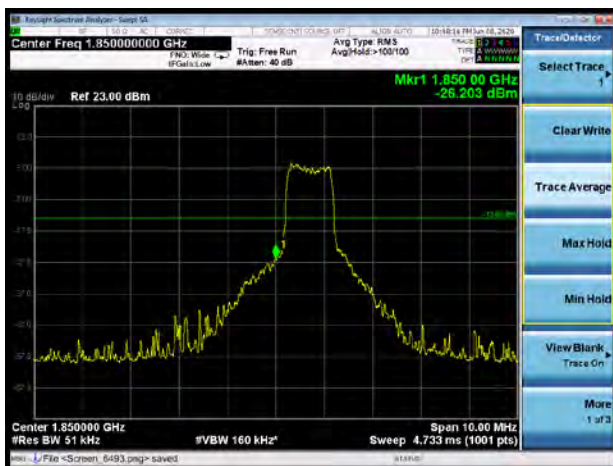

LTE Band 25 5MHz 16QAM 100%RB CH-High

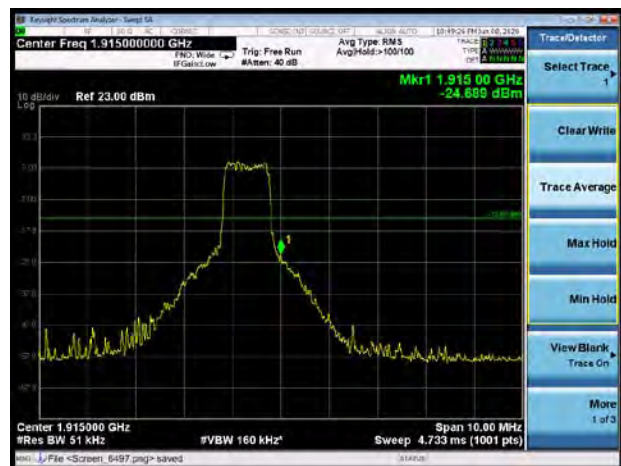

LTE Band 25 10MHz 16QAM 1RB CH-Low

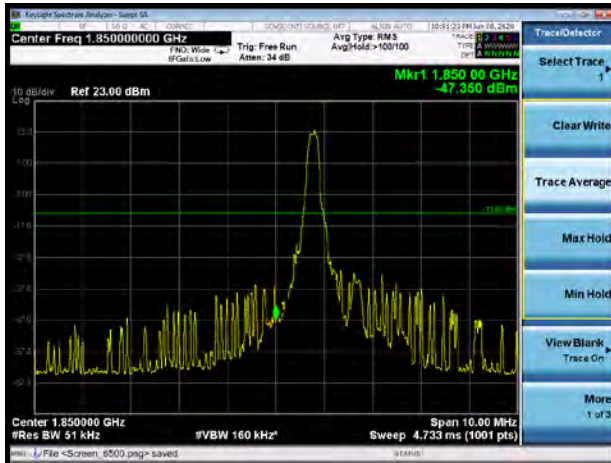

LTE Band 25 10MHz 16QAM 1RB CH-High

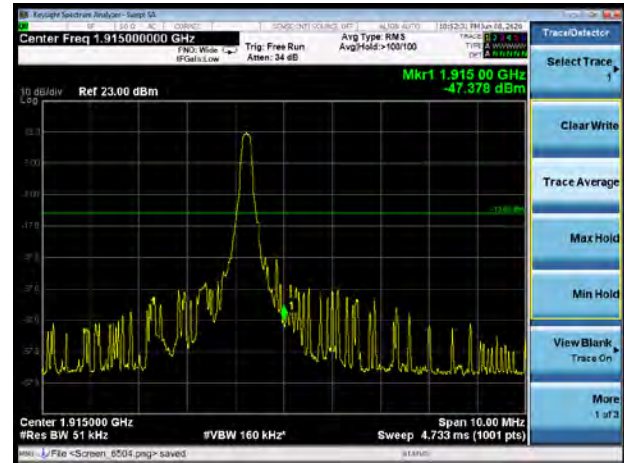

LTE Band 25 10MHz 16QAM 100%RB CH-Low

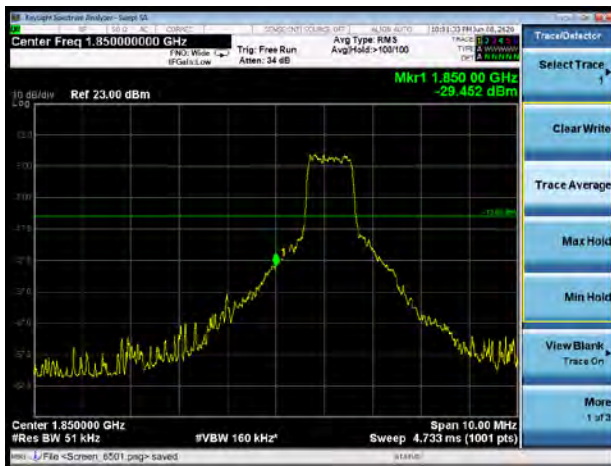

LTE Band 25 10MHz 16QAM 100%RB CH-High

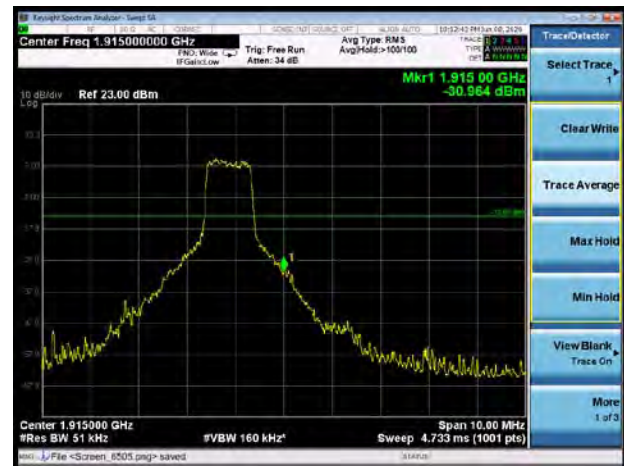

LTE Band 25 15MHz 16QAM 1RB CH-Low

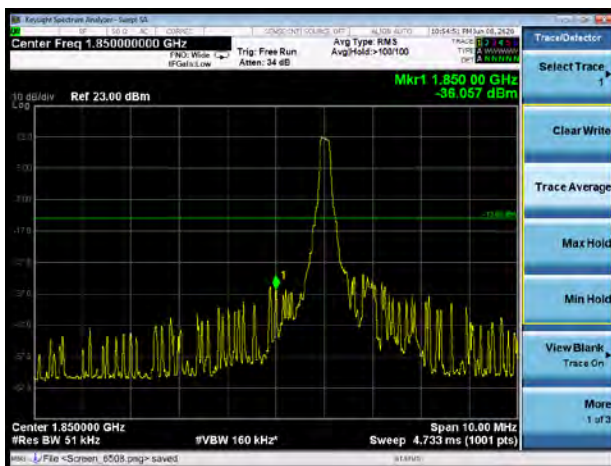

LTE Band 25 15MHz 16QAM 1RB CH-High

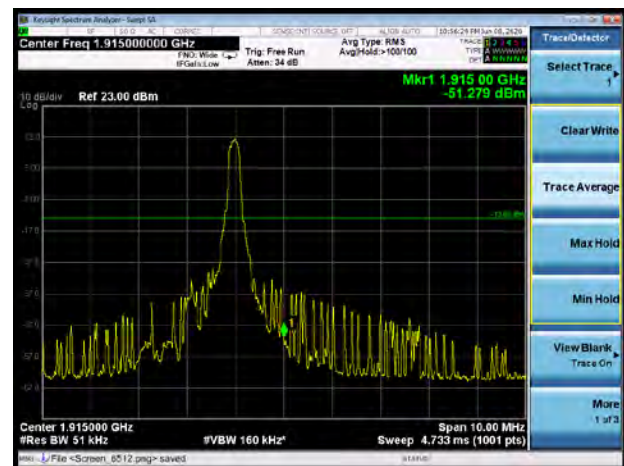



LTE Band 25 15MHz 16QAM 100%RB CH-Low

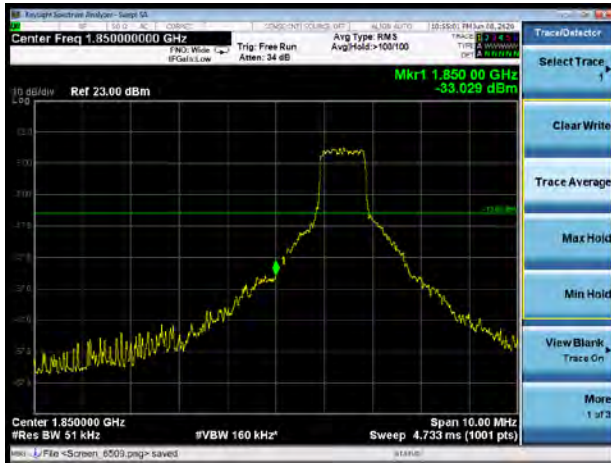

LTE Band 25 15MHz 16QAM 100%RB CH-High

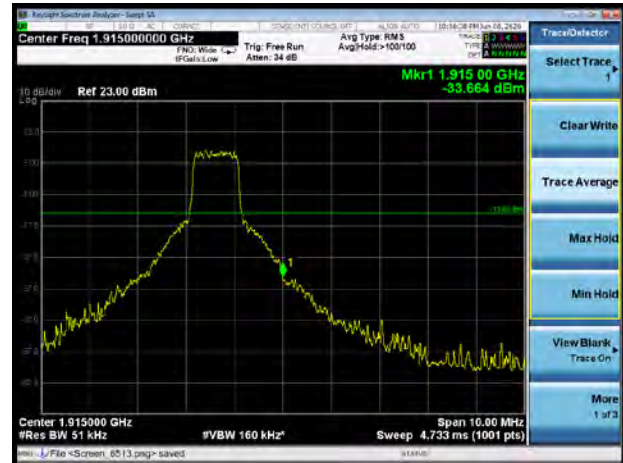

LTE Band 25 20MHz 16QAM 1RB CH-Low

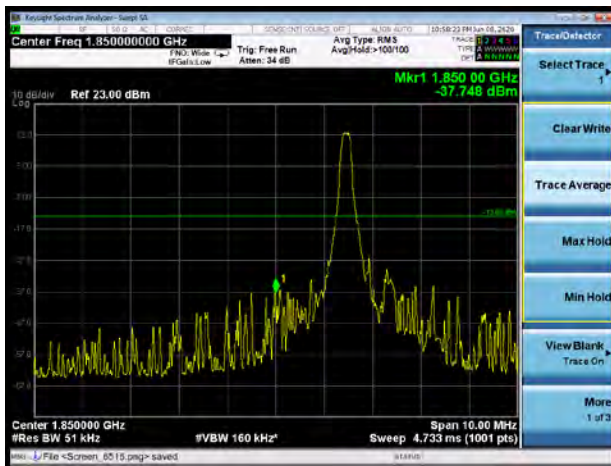

LTE Band 25 20MHz 16QAM 1RB CH-High

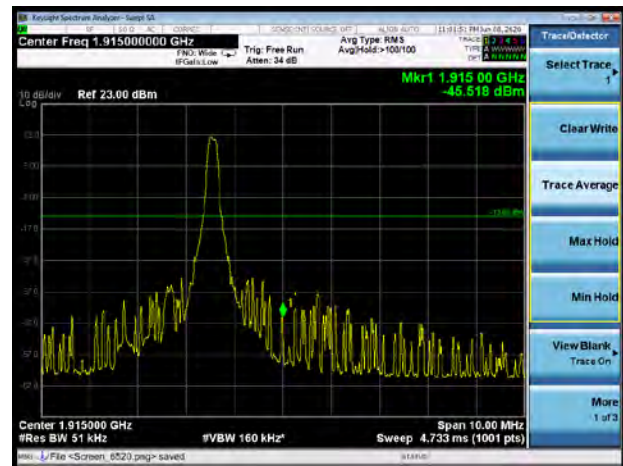

LTE Band 25 20MHz 16QAM 100%RB CH-Low

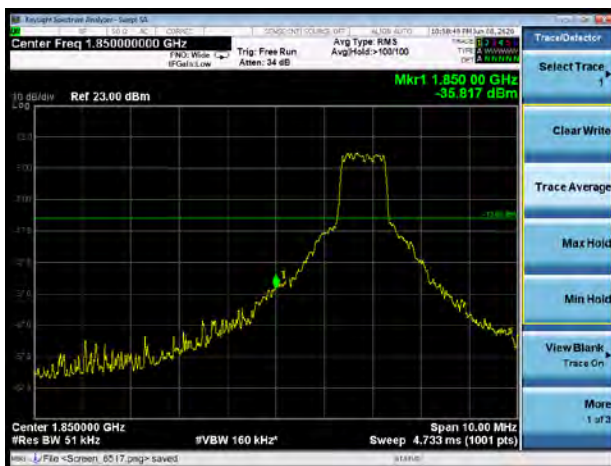

LTE Band 25 20MHz 16QAM 100%RB CH-High

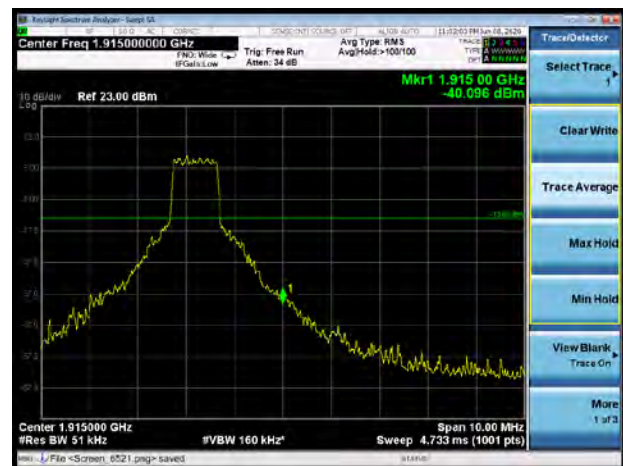

5.4. Peak-to-Average Power Ratio (PAPR)

Ambient condition

Temperature	Relative humidity	Pressure
23°C ~25°C	45%~50%	101.5kPa

Methods of Measurement

Measure the total peak power and record as PPk. And measure the total average power and record as PAvg. Both the peak and average power levels must be expressed in the same logarithmic units (e.g., dBm). Determine the PAPR from:

$$PAPR (dB) = PPk (dBm) - PAvg (dBm).$$

Test Setup

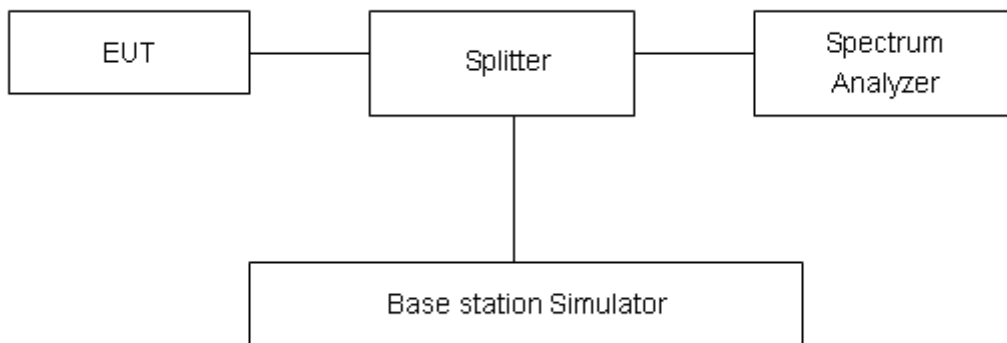

Limits

In measuring transmissions in this band using an average power technique, the peak-to-average ratio (PAR) of the transmission may not exceed 13 dB in 24.232(d).

Measurement Uncertainty

The assessed measurement uncertainty to ensure 95% confidence level for the normal distribution is with the coverage factor $k = 2$, $U = 0.4$ dB.

**Test Results**

Mode	Bandwidth	Modulation	Channel/ Frequency(MHz)	Peak-to-Average Power Ratio (PAPR)			Limit(dB)	Conclusion
				Peak(dBm)	Avg(dBm)	PAPR(dB)		
LTE Band 2	1.4MHz	QPSK	18900/1880	26.12	16.27	9.85	≤13	PASS
		16QAM	18900/1880	26.48	16.28	10.20	≤13	PASS
	3MHz	QPSK	18900/1880	26.04	16.18	9.86	≤13	PASS
		16QAM	18900/1880	26.35	16.31	10.04	≤13	PASS
	5MHz	QPSK	18900/1880	26.50	17.01	9.49	≤13	PASS
		16QAM	18900/1880	26.35	16.11	10.24	≤13	PASS
	10MHz	QPSK	18900/1880	26.36	17.02	9.34	≤13	PASS
		16QAM	18900/1880	26.37	17.22	9.15	≤13	PASS
	15MHz	QPSK	18900/1880	26.41	18.28	8.13	≤13	PASS
		16QAM	18900/1880	26.43	18.44	7.99	≤13	PASS
	20MHz	QPSK	18900/1880	26.47	17.98	8.49	≤13	PASS
		16QAM	18900/1880	26.50	18.50	8.00	≤13	PASS

Mode	Bandwidth	Modulation	Channel/ Frequency(MHz)	Peak-to-Average Power Ratio (PAPR)			Limit(dB)	Conclusion
				Peak(dBm)	Avg(dBm)	PAPR(dB)		
LTE Band 25	1.4MHz	QPSK	26365/1882.5	25.80	14.44	11.36	≤13	PASS
		16QAM	26365/1882.5	26.42	15.11	11.31	≤13	PASS
	3MHz	QPSK	26365/1882.5	25.92	15.97	9.95	≤13	PASS
		16QAM	26365/1882.5	26.23	16.06	10.17	≤13	PASS
	5MHz	QPSK	26365/1882.5	26.42	17.55	8.87	≤13	PASS
		16QAM	26365/1882.5	26.23	16.02	10.21	≤13	PASS
	10MHz	QPSK	26365/1882.5	26.30	16.98	9.32	≤13	PASS
		16QAM	26365/1882.5	26.29	17.16	9.13	≤13	PASS
	15MHz	QPSK	26365/1882.5	26.34	18.02	8.32	≤13	PASS
		16QAM	26365/1882.5	26.35	18.01	8.34	≤13	PASS
	20MHz	QPSK	26365/1882.5	26.40	18.24	8.16	≤13	PASS
		16QAM	26365/1882.5	26.41	18.20	8.21	≤13	PASS

5.5.Frequency Stability

Ambient condition

Temperature	Relative humidity	Pressure
23°C ~25°C	45%~50%	101.5kPa

Method of Measurement

Frequency Stability (Temperature Variation)

The temperature inside the climate chamber is varied from -40°C to +85°C in 10°C step size,

- (1) With all power removed, the temperature was decreased to 0°C and permitted to stabilize for three hours.
- (2) Measure the carrier frequency with the test equipment in a “call mode”. These measurements should be made within 1 minute of powering up the mobile station, to prevent significant self warming.
- (3) Repeat the above measurements at 10°C increments from -40°C to +85°C. Allow at least 1.5 hours at each temperature, un-powered, before making measurements.

Frequency Stability (Voltage Variation)

The frequency stability shall be measured with variation of primary supply voltage as follows:

- (1) Vary primary supply voltage from 85 to 115 percent of the nominal value for other than hand carried battery equipment.
- (2) For hand carried, battery powered equipment, reduce primary supply voltage to the battery-operating end point which shall be specified by the manufacturer.

This transceiver is specified to operate with an input voltage of between 3.3 V and 4.3 V, with a nominal voltage of 3.8V.

Test setup

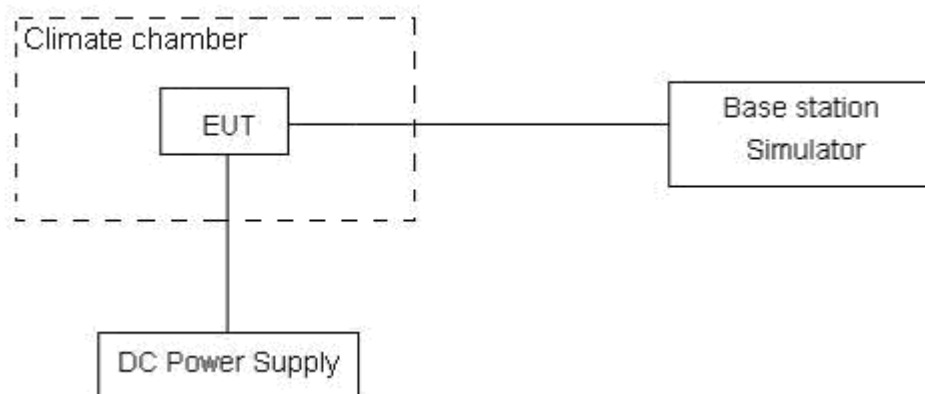

**Limits**

The frequency stability shall be sufficient to ensure that the fundamental emission stays within the authorized frequency block

Measurement Uncertainty

The assessed measurement uncertainty to ensure 99.75% confidence level for the normal distribution is with the coverage factor $k = 3$, $U = 0.01\text{ppm}$.



Test Result

LTE Band 2						
Condition		Freq.Error (Hz)	Freq.Error (Hz)	Frequency Stability (ppm)	Frequency Stability (ppm)	Verdict
BANDWIDTH	1.4MHz					
Temperature	Voltage	16QAM	QPSK	16QAM	QPSK	
Normal (25°C)	Normal	13.98	17.37	0.00743	0.00924	PASS
Extreme (85°C)		11.92	14.01	0.00634	0.00745	PASS
Extreme (80°C)		1.06	7.11	0.00056	0.00378	PASS
Extreme (70°C)		9.65	4.34	0.00513	0.00231	PASS
Extreme (60°C)		1.32	7.51	0.00070	0.00400	PASS
Extreme (50°C)		8.60	3.95	0.00458	0.00210	PASS
Extreme (40°C)		15.28	10.95	0.00813	0.00583	PASS
Extreme (30°C)		4.73	11.07	0.00252	0.00589	PASS
Extreme (20°C)		12.21	6.86	0.00649	0.00365	PASS
Extreme (10°C)		17.50	9.30	0.00931	0.00495	PASS
Extreme (0°C)		17.74	12.80	0.00943	0.00681	PASS
Extreme (-10°C)		11.75	13.77	0.00625	0.00732	PASS
Extreme (-20°C)		16.26	1.41	0.00865	0.00075	PASS
Extreme (-30°C)		8.77	9.95	0.00466	0.00529	PASS
Extreme (-40°C)		17.53	10.61	0.00932	0.00565	PASS
25°C		LV	8.58	15.04	0.00456	0.00800
	HV	6.07	13.62	0.00323	0.00725	PASS
Condition		Freq.Error (Hz)	Freq.Error (Hz)	Frequency Stability (ppm)	Frequency Stability (ppm)	Verdict
BANDWIDTH	3MHz					
Temperature	Voltage	16QAM	QPSK	16QAM	QPSK	
Normal (25°C)	Normal	10.51	10.21	0.00559	0.00543	PASS
Extreme (85°C)		14.58	10.19	0.00776	0.00542	PASS
Extreme (80°C)		1.72	15.01	0.00092	0.00798	PASS
Extreme (70°C)		8.49	16.74	0.00452	0.00891	PASS
Extreme (60°C)		3.04	6.15	0.00162	0.00327	PASS
Extreme (50°C)		2.59	8.75	0.00138	0.00465	PASS
Extreme (40°C)		14.04	4.28	0.00747	0.00228	PASS
Extreme (30°C)		16.50	4.02	0.00878	0.00214	PASS
Extreme (20°C)		11.01	9.62	0.00585	0.00512	PASS
Extreme (10°C)		14.32	2.40	0.00762	0.00127	PASS
Extreme (0°C)		12.17	11.57	0.00647	0.00616	PASS
Extreme (-10°C)		4.27	4.26	0.00227	0.00226	PASS
Extreme (-20°C)		15.44	3.44	0.00821	0.00183	PASS
Extreme (-30°C)		14.77	13.04	0.00786	0.00694	PASS



Extreme (-40°C)		2.98	6.62	0.00158	0.00352	PASS
25°C	LV	10.14	10.09	0.00540	0.00537	PASS
	HV	13.50	8.61	0.00718	0.00458	PASS
Condition		Freq.Error (Hz)	Freq.Error (Hz)	Frequency Stability (ppm)	Frequency Stability (ppm)	Verdict
BANDWIDTH	5MHz					
Temperature	Voltage	16QAM	QPSK	16QAM	QPSK	
Normal (25°C)	Normal	16.91	13.94	0.00899	0.00741	PASS
Extreme (85°C)		14.80	6.83	0.00787	0.00363	PASS
Extreme (80°C)		8.63	3.67	0.00459	0.00195	PASS
Extreme (70°C)		7.80	3.07	0.00415	0.00163	PASS
Extreme (60°C)		17.49	13.59	0.00930	0.00723	PASS
Extreme (50°C)		12.99	10.27	0.00691	0.00546	PASS
Extreme (40°C)		16.61	11.13	0.00884	0.00592	PASS
Extreme (30°C)		10.73	13.45	0.00571	0.00716	PASS
Extreme (20°C)		3.79	2.59	0.00202	0.00138	PASS
Extreme (10°C)		13.86	9.58	0.00737	0.00509	PASS
Extreme (0°C)		7.88	2.10	0.00419	0.00112	PASS
Extreme (-10°C)		1.94	17.99	0.00103	0.00957	PASS
Extreme (-20°C)		16.85	9.89	0.00896	0.00526	PASS
Extreme (-30°C)		13.72	4.97	0.00730	0.00264	PASS
Extreme (-40°C)		17.60	15.94	0.00936	0.00848	PASS
25°C	LV	11.16	16.83	0.00594	0.00895	PASS
	HV	15.93	12.18	0.00847	0.00648	PASS
Condition		Freq.Error (Hz)	Freq.Error (Hz)	Frequency Stability (ppm)	Frequency Stability (ppm)	Verdict
BANDWIDTH	10MHz					
Temperature	Voltage	16QAM	QPSK	16QAM	QPSK	
Normal (25°C)	Normal	9.90	4.14	0.00526	0.00220	PASS
Extreme (85°C)		9.80	16.11	0.00521	0.00857	PASS
Extreme (80°C)		16.71	14.18	0.00889	0.00754	PASS
Extreme (70°C)		7.15	14.28	0.00380	0.00760	PASS
Extreme (60°C)		9.09	7.16	0.00484	0.00381	PASS
Extreme (50°C)		9.29	3.53	0.00494	0.00188	PASS
Extreme (40°C)		17.43	6.92	0.00927	0.00368	PASS
Extreme (30°C)		5.78	12.54	0.00307	0.00667	PASS
Extreme (20°C)		16.18	8.67	0.00861	0.00461	PASS
Extreme (10°C)		10.32	16.79	0.00549	0.00893	PASS
Extreme (0°C)		7.75	2.83	0.00412	0.00150	PASS
Extreme (-10°C)		7.46	14.85	0.00397	0.00790	PASS
Extreme (-20°C)		10.57	17.84	0.00562	0.00949	PASS
Extreme (-30°C)		3.71	4.39	0.00197	0.00233	PASS



Extreme (-40°C)		7.75	8.30	0.00412	0.00441	PASS
25°C	LV	1.35	8.86	0.00072	0.00471	PASS
	HV	16.89	3.48	0.00898	0.00185	PASS
Condition		Freq.Error (Hz)	Freq.Error (Hz)	Frequency Stability (ppm)	Frequency Stability (ppm)	Verdict
BANDWIDTH	15MHz					
Temperature	Voltage	16QAM	QPSK	16QAM	QPSK	
Normal (25°C)	Normal	3.20	2.66	0.00170	0.00142	PASS
Extreme (85°C)		12.52	15.71	0.00666	0.00836	PASS
Extreme (80°C)		6.16	8.00	0.00327	0.00425	PASS
Extreme (70°C)		11.43	6.77	0.00608	0.00360	PASS
Extreme (60°C)		5.10	7.14	0.00271	0.00380	PASS
Extreme (50°C)		1.62	9.04	0.00086	0.00481	PASS
Extreme (40°C)		8.25	5.55	0.00439	0.00295	PASS
Extreme (30°C)		10.88	2.28	0.00579	0.00121	PASS
Extreme (20°C)		6.18	9.40	0.00328	0.00500	PASS
Extreme (10°C)		13.95	9.56	0.00742	0.00508	PASS
Extreme (0°C)		6.65	3.34	0.00354	0.00178	PASS
Extreme (-10°C)		4.35	10.12	0.00232	0.00538	PASS
Extreme (-20°C)		11.05	8.35	0.00588	0.00444	PASS
Extreme (-30°C)		4.51	13.98	0.00240	0.00743	PASS
Extreme (-40°C)		12.36	12.42	0.00658	0.00661	PASS
25°C	LV	17.94	12.74	0.00954	0.00678	PASS
	HV	16.82	9.51	0.00895	0.00506	PASS
Condition		Freq.Error (Hz)	Freq.Error (Hz)	Frequency Stability (ppm)	Frequency Stability (ppm)	Verdict
BANDWIDTH	20MHz					
Temperature	Voltage	16QAM	QPSK	16QAM	QPSK	
Normal (25°C)	Normal	2.72	9.29	0.00145	0.00494	PASS
Extreme (85°C)		6.45	12.53	0.00343	0.00666	PASS
Extreme (80°C)		4.55	5.86	0.00242	0.00312	PASS
Extreme (70°C)		4.91	12.51	0.00261	0.00665	PASS
Extreme (60°C)		1.92	17.63	0.00102	0.00938	PASS
Extreme (50°C)		2.96	7.30	0.00158	0.00388	PASS
Extreme (40°C)		13.79	5.21	0.00733	0.00277	PASS
Extreme (30°C)		8.72	11.85	0.00464	0.00630	PASS
Extreme (20°C)		11.54	9.32	0.00614	0.00496	PASS
Extreme (10°C)		12.22	5.54	0.00650	0.00295	PASS
Extreme (0°C)		8.13	14.88	0.00432	0.00792	PASS
Extreme (-10°C)		4.79	3.11	0.00255	0.00165	PASS
Extreme (-20°C)		8.53	15.24	0.00454	0.00811	PASS
Extreme (-30°C)		1.22	6.01	0.00065	0.00320	PASS



Extreme (-40°C)		14.06	16.46	0.00748	0.00875	PASS
25°C	LV	16.66	2.04	0.00886	0.00108	PASS
	HV	8.16	16.32	0.00434	0.00868	PASS

LTE Band 25						
Condition		Freq.Error (Hz)	Freq.Error (Hz)	Frequency Stability (ppm)	Frequency Stability (ppm)	Verdict
BANDWIDTH	1.4MHz					
Temperature	Voltage	16QAM	QPSK	16QAM	QPSK	
Normal (25°C)	Normal	3.56	2.34	0.00189	0.00124	PASS
Extreme (85°C)		12.11	7.70	0.00644	0.00410	PASS
Extreme (80°C)		2.42	5.16	0.00129	0.00274	PASS
Extreme (70°C)		17.64	7.88	0.00939	0.00419	PASS
Extreme (60°C)		13.39	15.48	0.00712	0.00823	PASS
Extreme (50°C)		14.55	5.75	0.00774	0.00306	PASS
Extreme (40°C)		3.16	10.35	0.00168	0.00550	PASS
Extreme (30°C)		3.96	12.77	0.00211	0.00679	PASS
Extreme (20°C)		11.83	11.38	0.00629	0.00605	PASS
Extreme (10°C)		1.25	13.94	0.00067	0.00742	PASS
Extreme (0°C)		1.74	1.85	0.00092	0.00098	PASS
Extreme (-10°C)		14.32	14.06	0.00762	0.00748	PASS
Extreme (-20°C)		2.77	11.89	0.00148	0.00632	PASS
Extreme (-30°C)		2.06	2.09	0.00110	0.00111	PASS
Extreme (-40°C)		7.17	1.73	0.00382	0.00092	PASS
25°C	LV	2.20	5.67	0.00117	0.00302	PASS
	HV	10.33	17.32	0.00549	0.00921	PASS

LTE Band 25						
Condition		Freq.Error (Hz)	Freq.Error (Hz)	Frequency Stability (ppm)	Frequency Stability (ppm)	Verdict
BANDWIDTH	3MHz					
Temperature	Voltage	16QAM	QPSK	16QAM	QPSK	
Normal (25°C)	Normal	10.13	8.73	0.00539	0.00464	PASS
Extreme (85°C)		13.98	4.04	0.00744	0.00215	PASS
Extreme (80°C)		15.92	13.78	0.00847	0.00733	PASS
Extreme (70°C)		3.93	11.01	0.00209	0.00586	PASS
Extreme (60°C)		15.26	7.69	0.00812	0.00409	PASS
Extreme (50°C)		5.23	12.78	0.00278	0.00680	PASS
Extreme (40°C)		9.82	6.63	0.00522	0.00353	PASS
Extreme (30°C)		13.89	1.70	0.00739	0.00091	PASS
Extreme (20°C)		5.53	6.95	0.00294	0.00370	PASS
Extreme (10°C)		3.03	7.43	0.00161	0.00395	PASS



Extreme (0°C)		8.99	9.88	0.00478	0.00526	PASS
Extreme (-10°C)		7.38	17.37	0.00392	0.00924	PASS
Extreme (-20°C)		15.27	4.60	0.00812	0.00245	PASS
Extreme (-30°C)		15.04	16.59	0.00800	0.00882	PASS
Extreme (-40°C)		8.70	9.94	0.00463	0.00529	PASS
25°C	LV	8.42	2.95	0.00448	0.00157	PASS
	HV	16.08	15.52	0.00855	0.00826	PASS
Condition		Freq.Error (Hz)	Freq.Error (Hz)	Frequency Stability (ppm)	Frequency Stability (ppm)	Verdict
BANDWIDTH	5MHz					
Temperature	Voltage	16QAM	QPSK	16QAM	QPSK	
Normal (25°C)	Normal	6.09	10.61	0.00324	0.00565	
Extreme (85°C)		11.44	7.30	0.00608	0.00388	PASS
Extreme (80°C)		17.56	12.02	0.00934	0.00640	PASS
Extreme (70°C)		6.89	14.25	0.00366	0.00758	PASS
Extreme (60°C)		12.61	11.74	0.00671	0.00625	PASS
Extreme (50°C)		16.54	4.66	0.00880	0.00248	PASS
Extreme (40°C)		2.73	17.72	0.00145	0.00942	PASS
Extreme (30°C)		16.58	3.71	0.00882	0.00197	PASS
Extreme (20°C)		12.19	12.85	0.00648	0.00684	PASS
Extreme (10°C)		12.89	2.10	0.00685	0.00112	PASS
Extreme (0°C)		14.96	15.09	0.00796	0.00803	PASS
Extreme (-10°C)		5.98	12.49	0.00318	0.00664	PASS
Extreme (-20°C)		9.08	9.98	0.00483	0.00531	PASS
Extreme (-30°C)		7.33	12.78	0.00390	0.00680	PASS
Extreme (-40°C)	2.52	8.43	0.00134	0.00448	PASS	
25°C	LV	13.46	2.61	0.00716	0.00139	PASS
	HV	17.48	9.71	0.00930	0.00517	PASS
Condition		Freq.Error (Hz)	Freq.Error (Hz)	Frequency Stability (ppm)	Frequency Stability (ppm)	Verdict
BANDWIDTH	10MHz					
Temperature	Voltage	16QAM	QPSK	16QAM	QPSK	
Normal (25°C)	Normal	14.36	6.25	0.00764	0.00333	
Extreme (85°C)		12.12	3.46	0.00645	0.00184	PASS
Extreme (80°C)		12.87	3.14	0.00684	0.00167	PASS
Extreme (70°C)		8.12	10.90	0.00432	0.00580	PASS
Extreme (60°C)		16.95	10.06	0.00902	0.00535	PASS
Extreme (50°C)		10.40	4.90	0.00553	0.00261	PASS
Extreme (40°C)		16.98	5.22	0.00903	0.00278	PASS
Extreme (30°C)		12.46	13.61	0.00663	0.00724	PASS
Extreme (20°C)	17.11	10.05	0.00910	0.00535	PASS	



Extreme (10°C)		7.47	3.34	0.00397	0.00178	PASS
Extreme (0°C)		9.59	15.13	0.00510	0.00805	PASS
Extreme (-10°C)		7.94	4.11	0.00422	0.00218	PASS
Extreme (-20°C)		17.11	5.20	0.00910	0.00276	PASS
Extreme (-30°C)		15.83	11.38	0.00842	0.00605	PASS
Extreme (-40°C)		6.22	11.57	0.00331	0.00615	PASS
25°C	LV	1.43	16.91	0.00076	0.00899	PASS
	HV	10.43	12.00	0.00555	0.00638	PASS
Condition		Freq.Error (Hz)	Freq.Error (Hz)	Frequency Stability (ppm)	Frequency Stability (ppm)	Verdict
BANDWIDTH	15MHz					
Temperature	Voltage	16QAM	QPSK	16QAM	QPSK	
Normal (25°C)	Normal	14.08	9.29	0.00749	0.00494	PASS
Extreme (85°C)		17.46	11.77	0.00929	0.00626	PASS
Extreme (80°C)		9.06	2.63	0.00482	0.00140	PASS
Extreme (70°C)		12.09	14.33	0.00643	0.00762	PASS
Extreme (60°C)		17.13	5.39	0.00911	0.00287	PASS
Extreme (50°C)		11.55	10.42	0.00614	0.00554	PASS
Extreme (40°C)		14.60	13.48	0.00776	0.00717	PASS
Extreme (30°C)		15.00	14.62	0.00798	0.00778	PASS
Extreme (20°C)		15.54	16.31	0.00826	0.00867	PASS
Extreme (10°C)		1.42	14.45	0.00075	0.00769	PASS
Extreme (0°C)		11.51	6.81	0.00612	0.00362	PASS
Extreme (-10°C)		7.78	6.67	0.00414	0.00355	PASS
Extreme (-20°C)		7.92	5.77	0.00422	0.00307	PASS
Extreme (-30°C)		9.59	4.45	0.00510	0.00237	PASS
Extreme (-40°C)	12.32	13.18	0.00655	0.00701	PASS	
25°C	LV	16.57	8.03	0.00881	0.00427	PASS
	HV	4.70	12.64	0.00250	0.00672	PASS
Condition		Freq.Error (Hz)	Freq.Error (Hz)	Frequency Stability (ppm)	Frequency Stability (ppm)	Verdict
BANDWIDTH	20MHz					
Temperature	Voltage	16QAM	QPSK	16QAM	QPSK	
Normal (25°C)	Normal	6.16	6.12	0.00327	0.00326	PASS
Extreme (85°C)		13.97	5.95	0.00743	0.00316	PASS
Extreme (80°C)		15.26	14.65	0.00812	0.00779	PASS
Extreme (70°C)		1.01	4.09	0.00053	0.00218	PASS
Extreme (60°C)		12.03	7.68	0.00640	0.00408	PASS
Extreme (50°C)		13.70	4.65	0.00729	0.00248	PASS
Extreme (40°C)		11.81	10.99	0.00628	0.00584	PASS
Extreme (30°C)		14.67	14.69	0.00780	0.00781	PASS



Extreme (20°C)		7.43	9.88	0.00395	0.00526	PASS
Extreme (10°C)		3.91	13.17	0.00208	0.00700	PASS
Extreme (0°C)		12.00	1.94	0.00638	0.00103	PASS
Extreme (-10°C)		6.83	1.41	0.00363	0.00075	PASS
Extreme (-20°C)		12.98	17.05	0.00690	0.00907	PASS
Extreme (-30°C)		17.13	10.42	0.00911	0.00554	PASS
Extreme (-40°C)		14.31	8.97	0.00761	0.00477	PASS
25°C	LV	3.76	1.89	0.00200	0.00101	PASS
	HV	7.96	5.00	0.00423	0.00266	PASS

5.6. Spurious Emissions at Antenna Terminals

Ambient condition

Temperature	Relative humidity	Pressure
23°C ~25°C	45%~50%	101.5kPa

Method of Measurement

The EUT was connected to Spectrum Analyzer and Base Station Simulator via power Splitter. The measurement is carried out using a spectrum analyzer. The spectrum analyzer scans from 9kHz to the 10th harmonic of the carrier. The peak detector is used.

RBW is set to 100kHz, VBW is set to 300kHz for 30MHz~1GHz

RBW is set to 1MHz, VBW is set to 3MHz for above 1GHz, Sweep is set to ATUO.

The modulation mode and RB allocation refer to section 5.1, using the maximum output power configuration.

Test setup

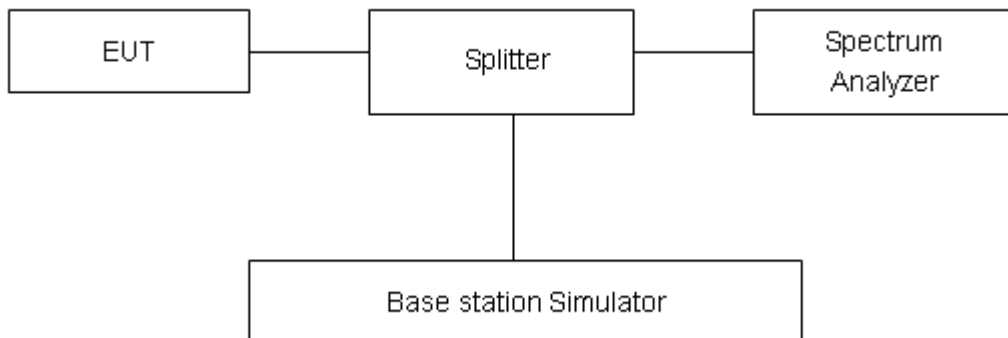

Limits

Rule Part 24.238(a) specifies that “on any frequency outside a licensee's frequency block, the power of any emission shall be attenuated below the transmitter power (P) by at least 43 + 10 log₁₀ (P) dB.”

Limit	-13 dBm
-------	---------

Measurement Uncertainty

The assessed measurement uncertainty to ensure 99.75% confidence level for the normal distribution is with the coverage factor $k = 1.96$.

Frequency	Uncertainty
9kHz-1GHz	0.684 dB
1GHz-20GHz	1.407 dB

Test Result

Sweep the whole frequency band through the range from 9kHz to the 10th harmonic of the carrier, the emissions more than 20 dB below the limit are not reported.

The signal beyond the limit is carrier.

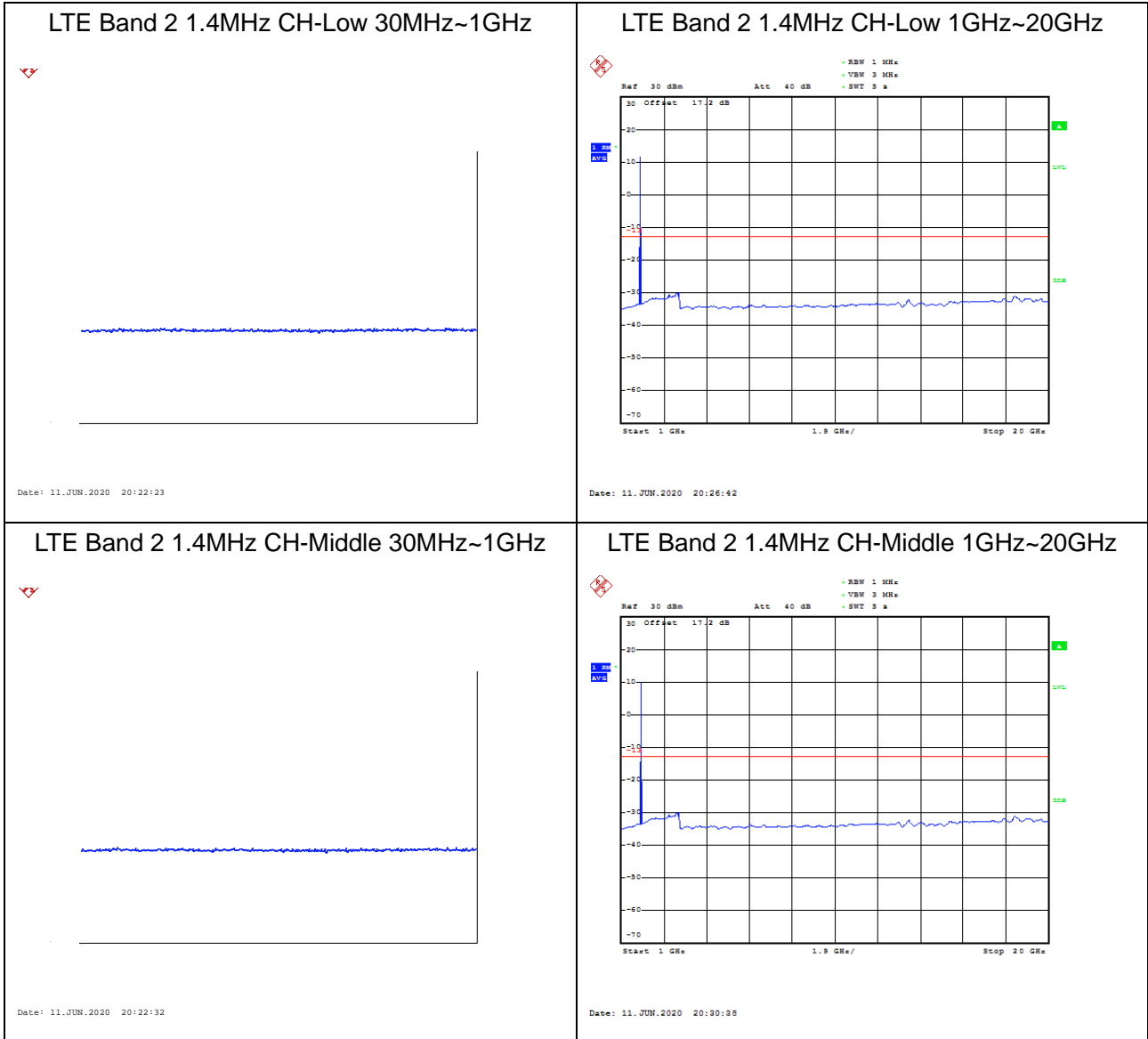

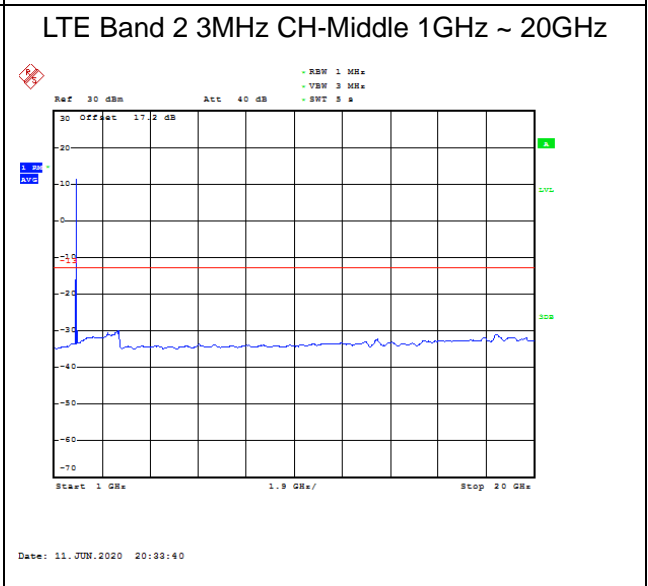
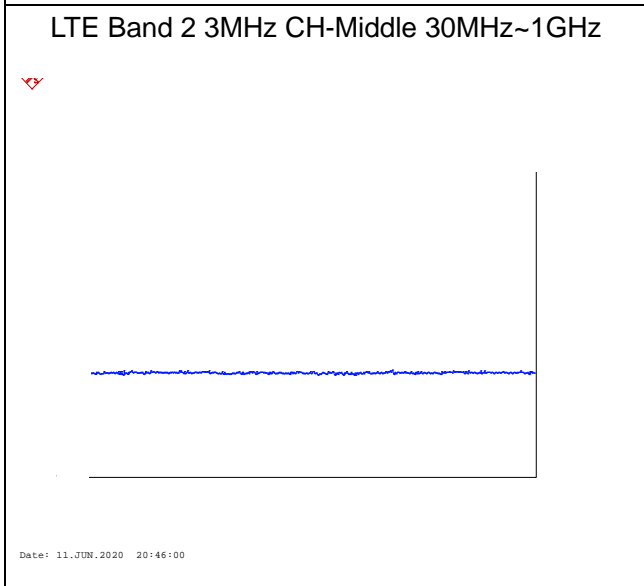
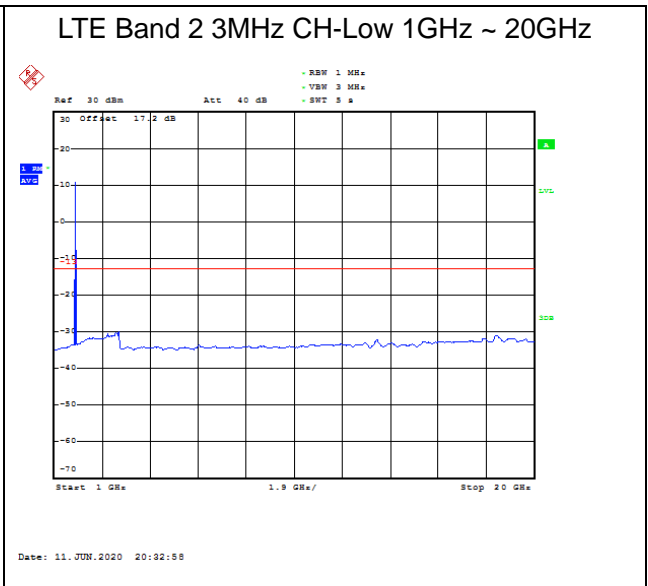
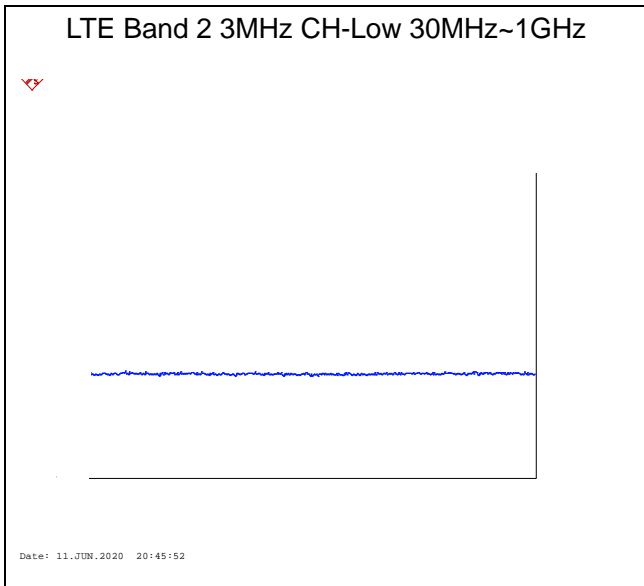
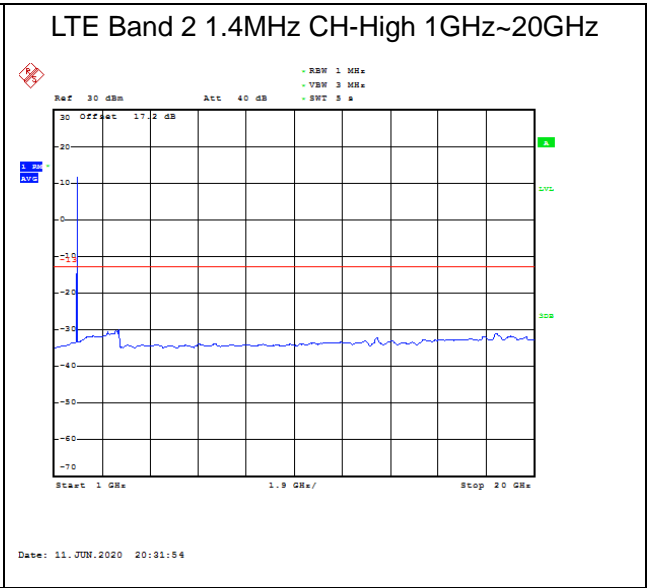
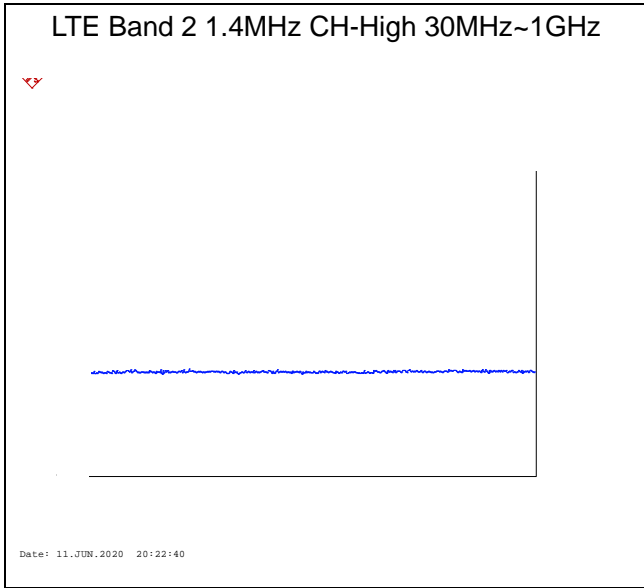

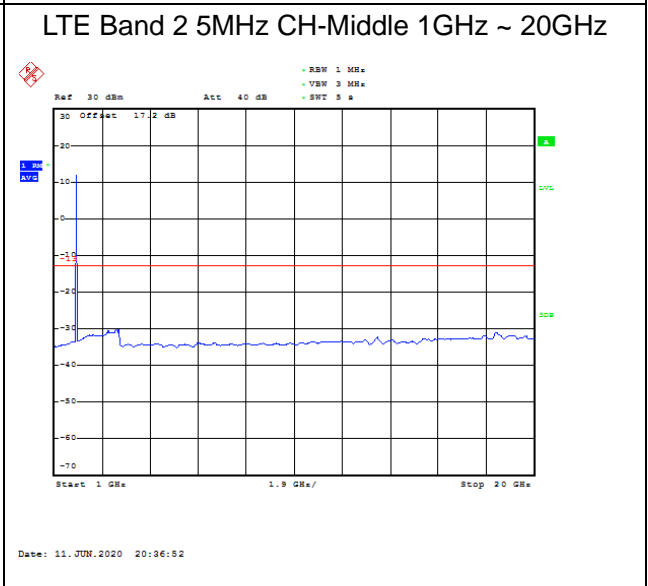
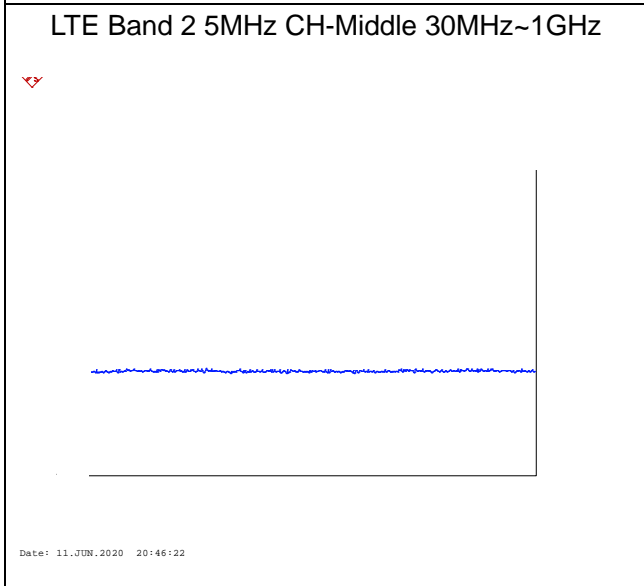
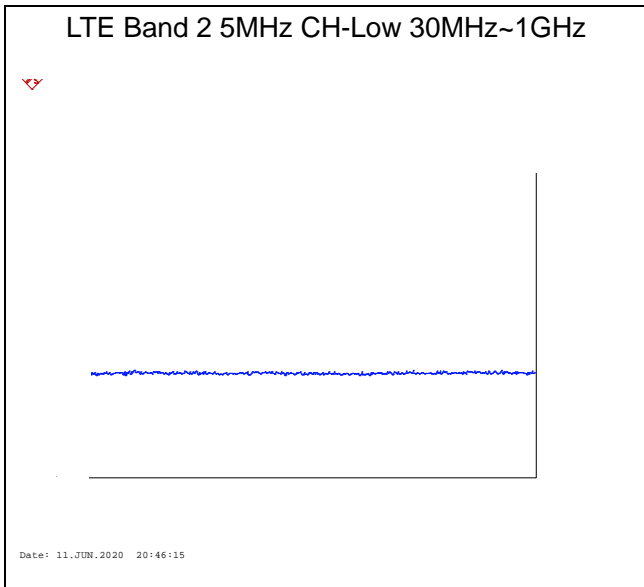
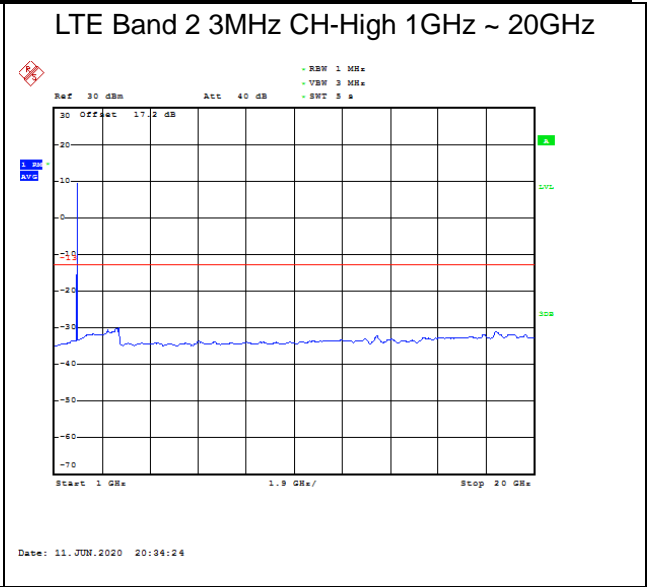
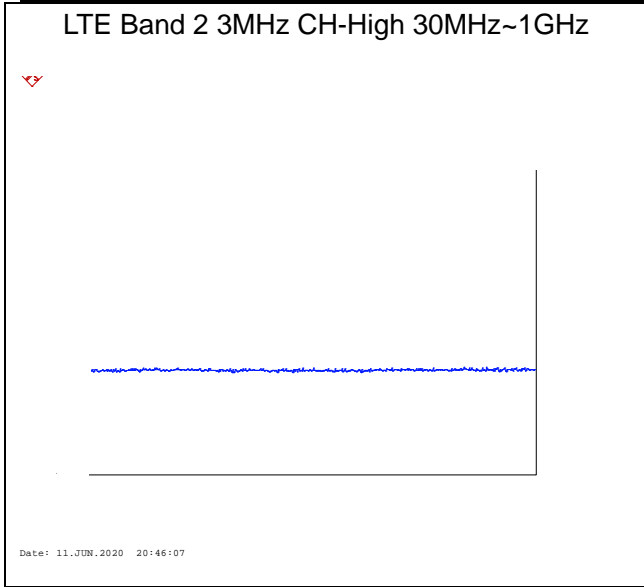

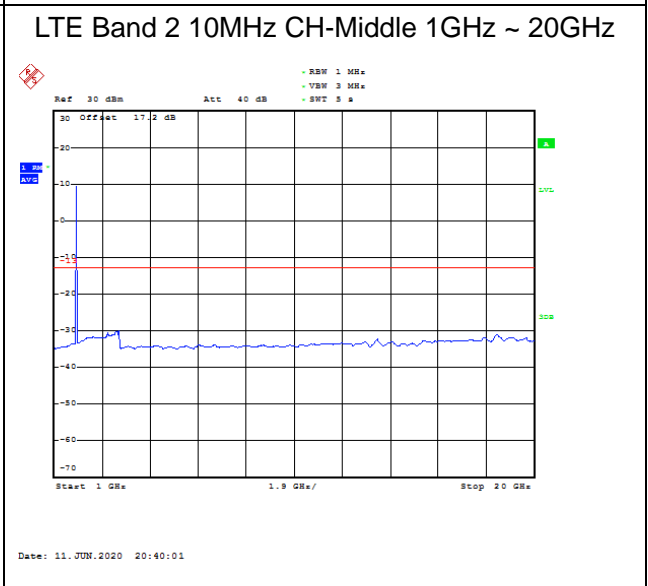
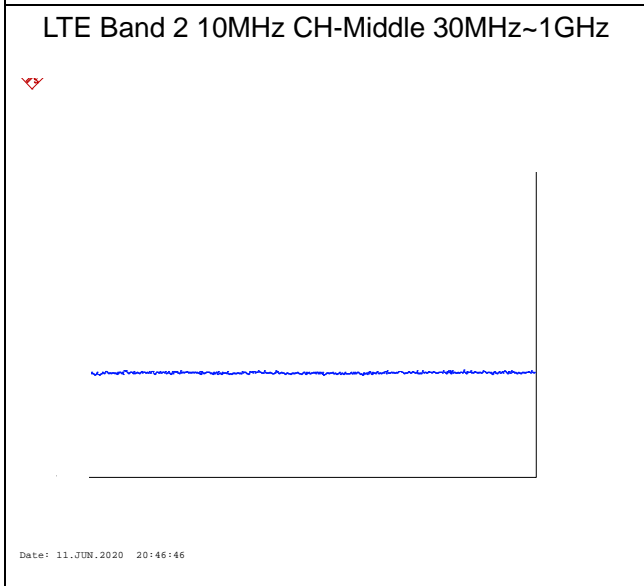
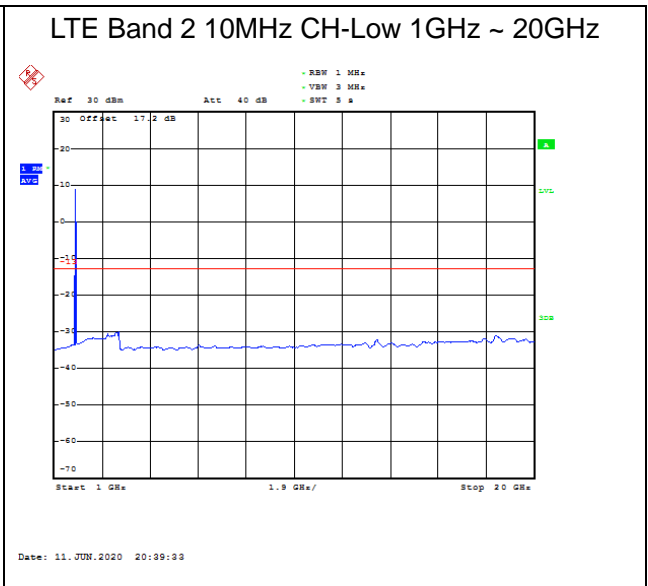
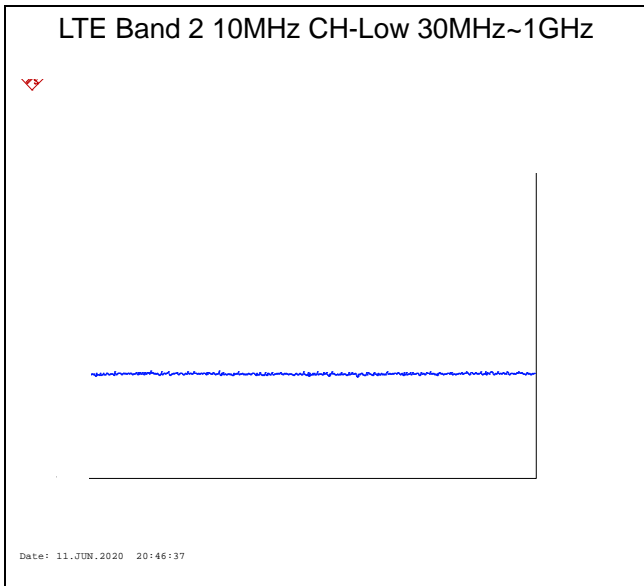
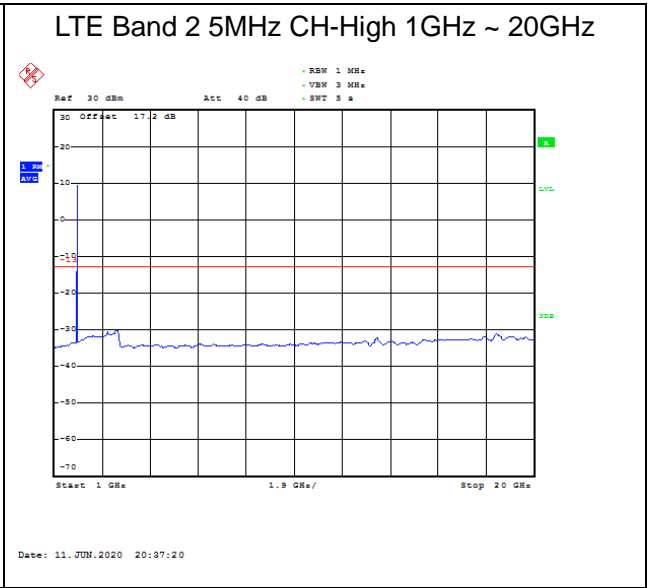
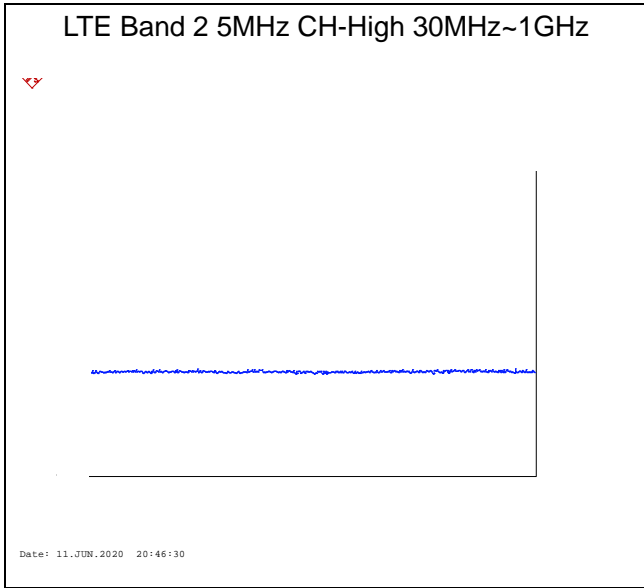



LTE Band 2 10MHz CH-High 30MHz~1GHz

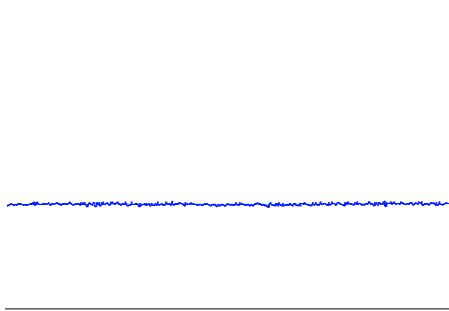

Date: 11.JUN.2020 20:46:53

LTE Band 2 10MHz CH-High 1GHz ~ 20GHz

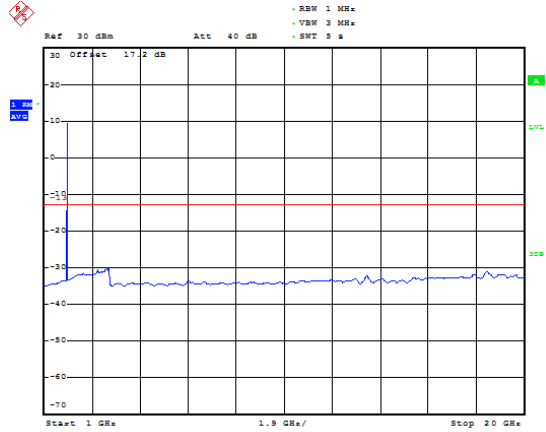

Date: 11.JUN.2020 20:40:38

LTE Band 2 15MHz CH-Low 30MHz~1GHz

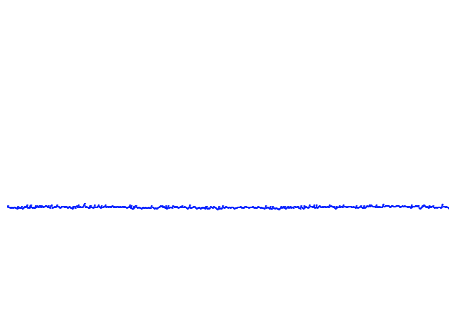

Date: 11.JUN.2020 20:47:00

LTE Band 2 15MHz CH-Low 1GHz ~ 20GHz

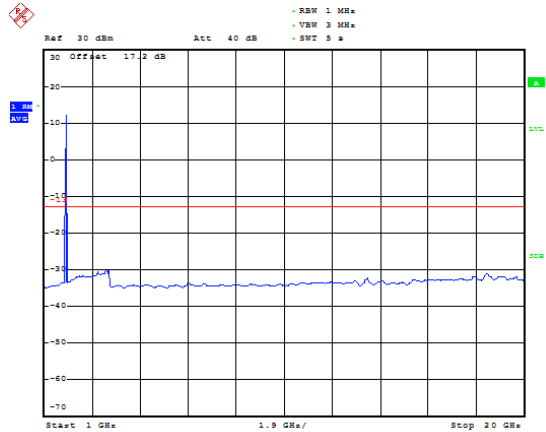

Date: 11.JUN.2020 20:42:26

LTE Band 2 15MHz CH-Middle 30MHz~1GHz

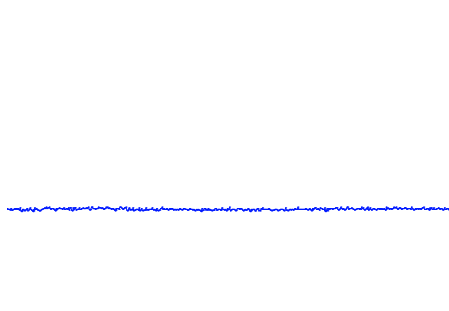

Date: 11.JUN.2020 20:47:07

LTE Band 2 15MHz CH-Middle 1GHz ~ 20GHz

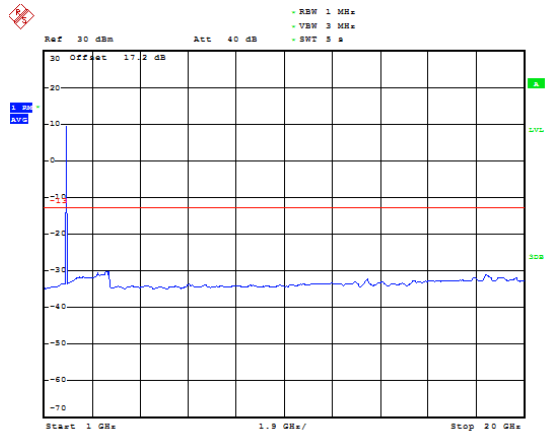

Date: 11.JUN.2020 20:42:59

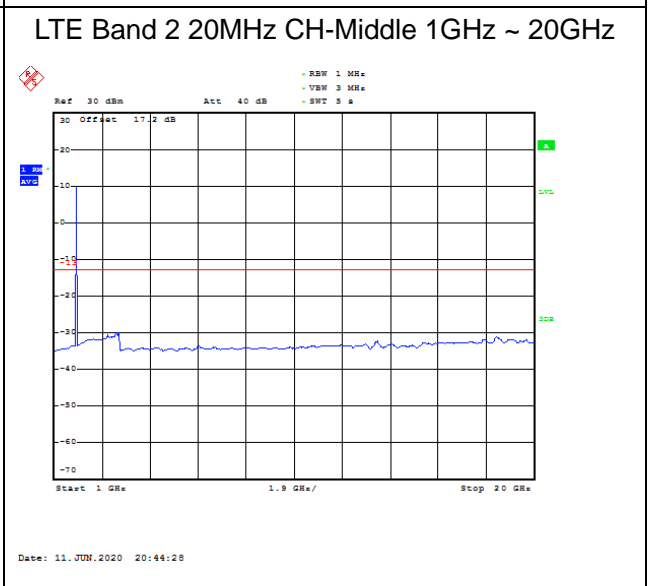
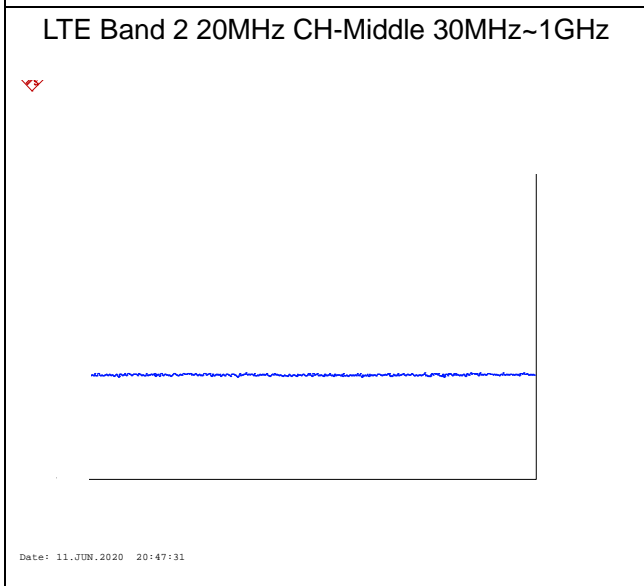
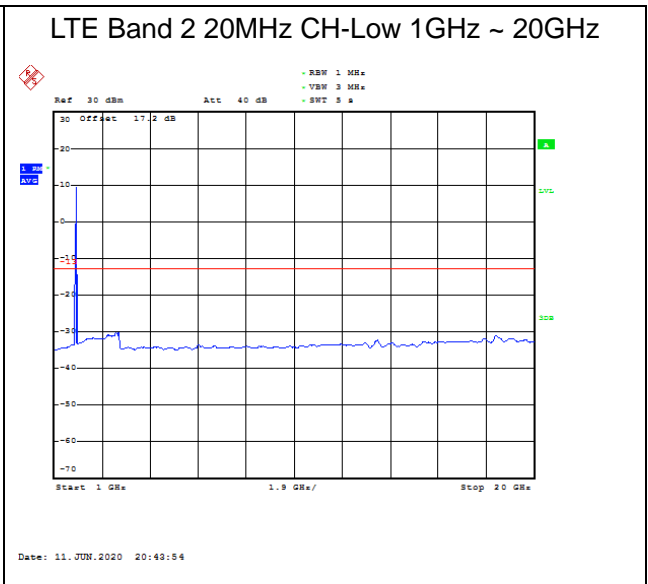
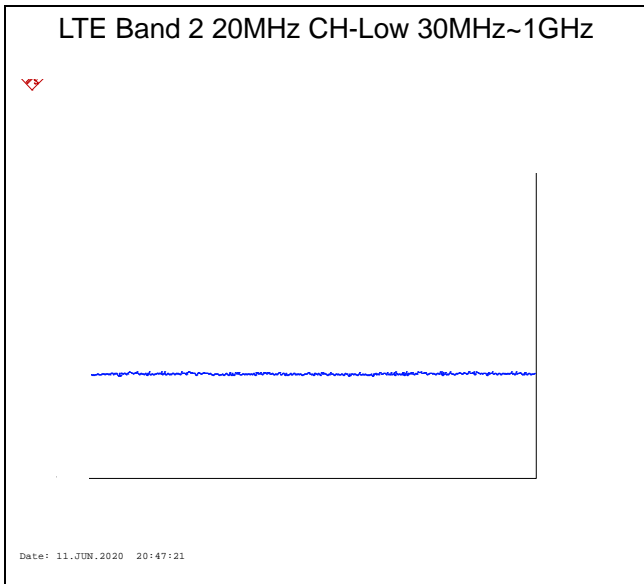
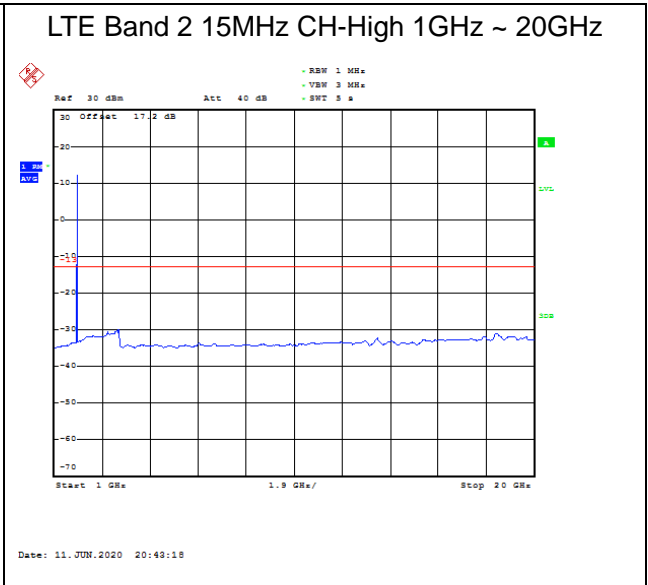
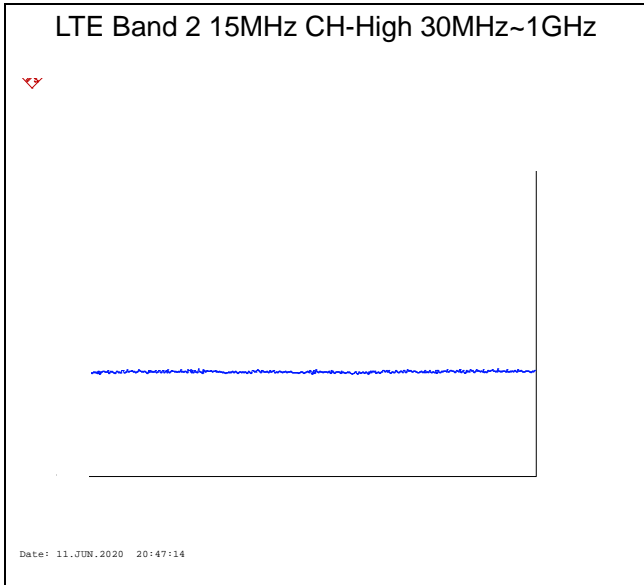



LTE Band 2 20MHz CH-High 30MHz~1GHz

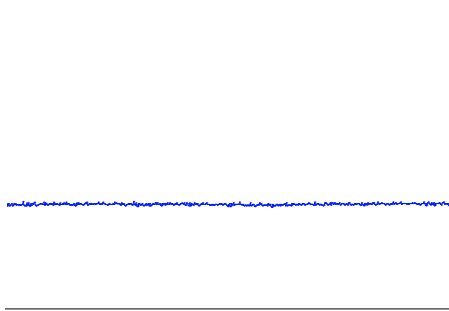

Date: 11.JUN.2020 20:47:39

LTE Band 2 20MHz CH-High 1GHz ~ 20GHz

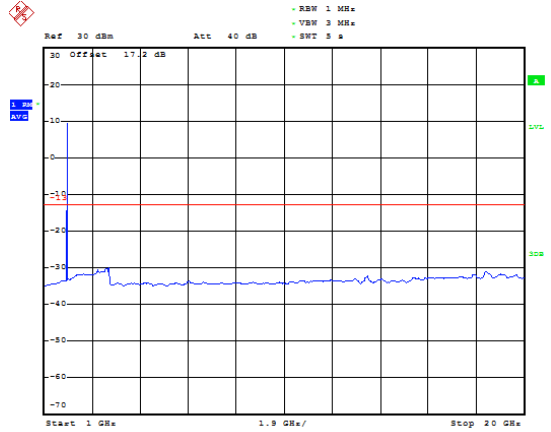

Date: 11.JUN.2020 20:44:59

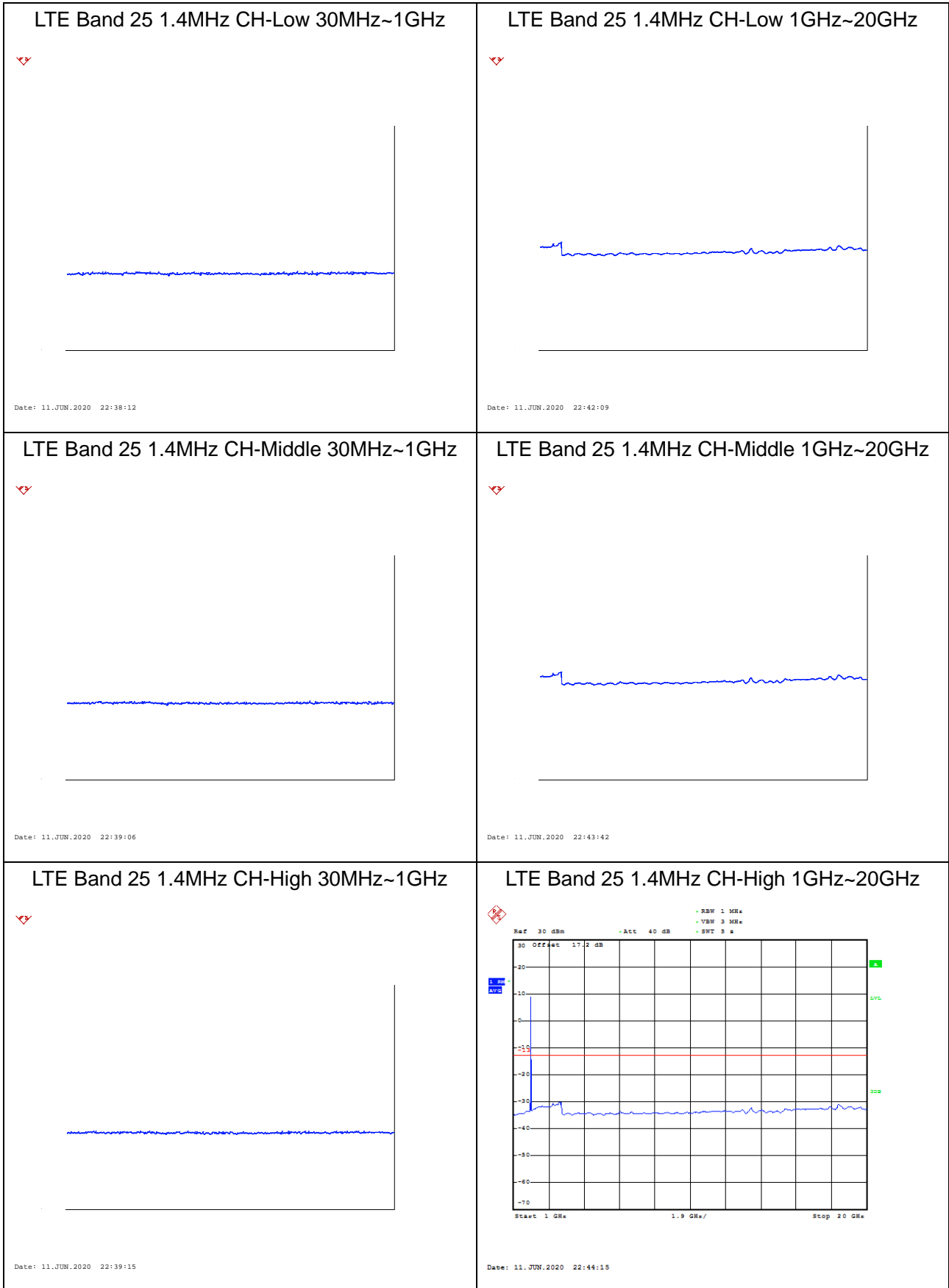



LTE Band 25 3MHz CH-Low 30MHz~1GHz

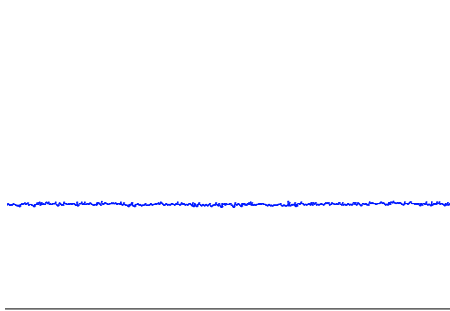

Date: 11.JUN.2020 22:39:25

LTE Band 25 3MHz CH-Low 1GHz ~ 20GHz

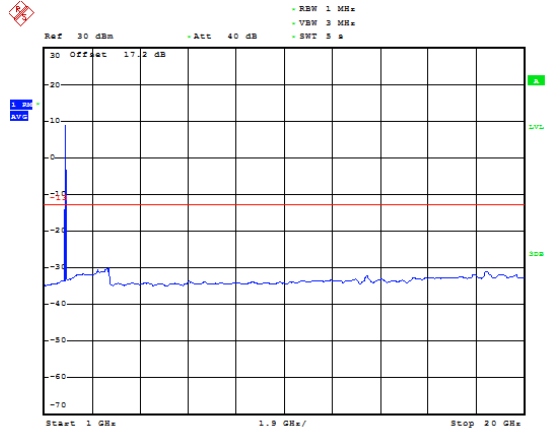

Date: 11.JUN.2020 22:45:22

LTE Band 25 3MHz CH-Middle 30MHz~1GHz

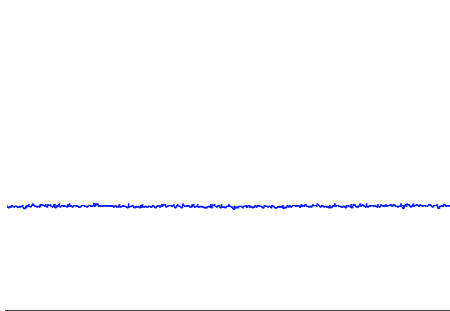

Date: 11.JUN.2020 22:39:33

LTE Band 25 3MHz CH-Middle 1GHz ~ 20GHz

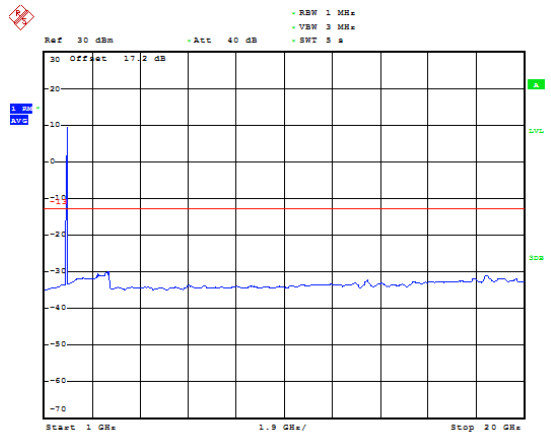

Date: 11.JUN.2020 22:46:49

LTE Band 25 3MHz CH-High 30MHz~1GHz

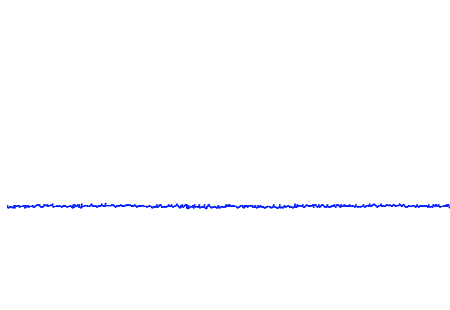

Date: 11.JUN.2020 22:39:41

LTE Band 25 3MHz CH-High 1GHz ~ 20GHz

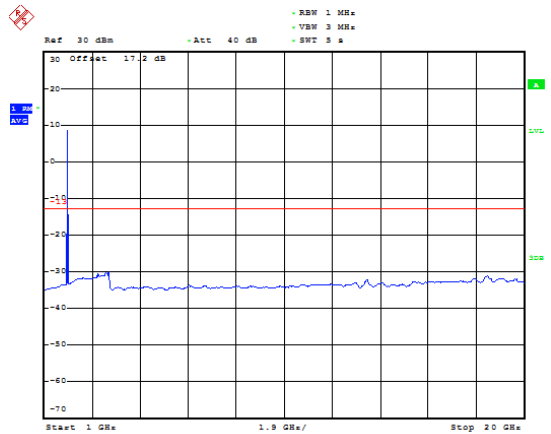

Date: 11.JUN.2020 22:47:58

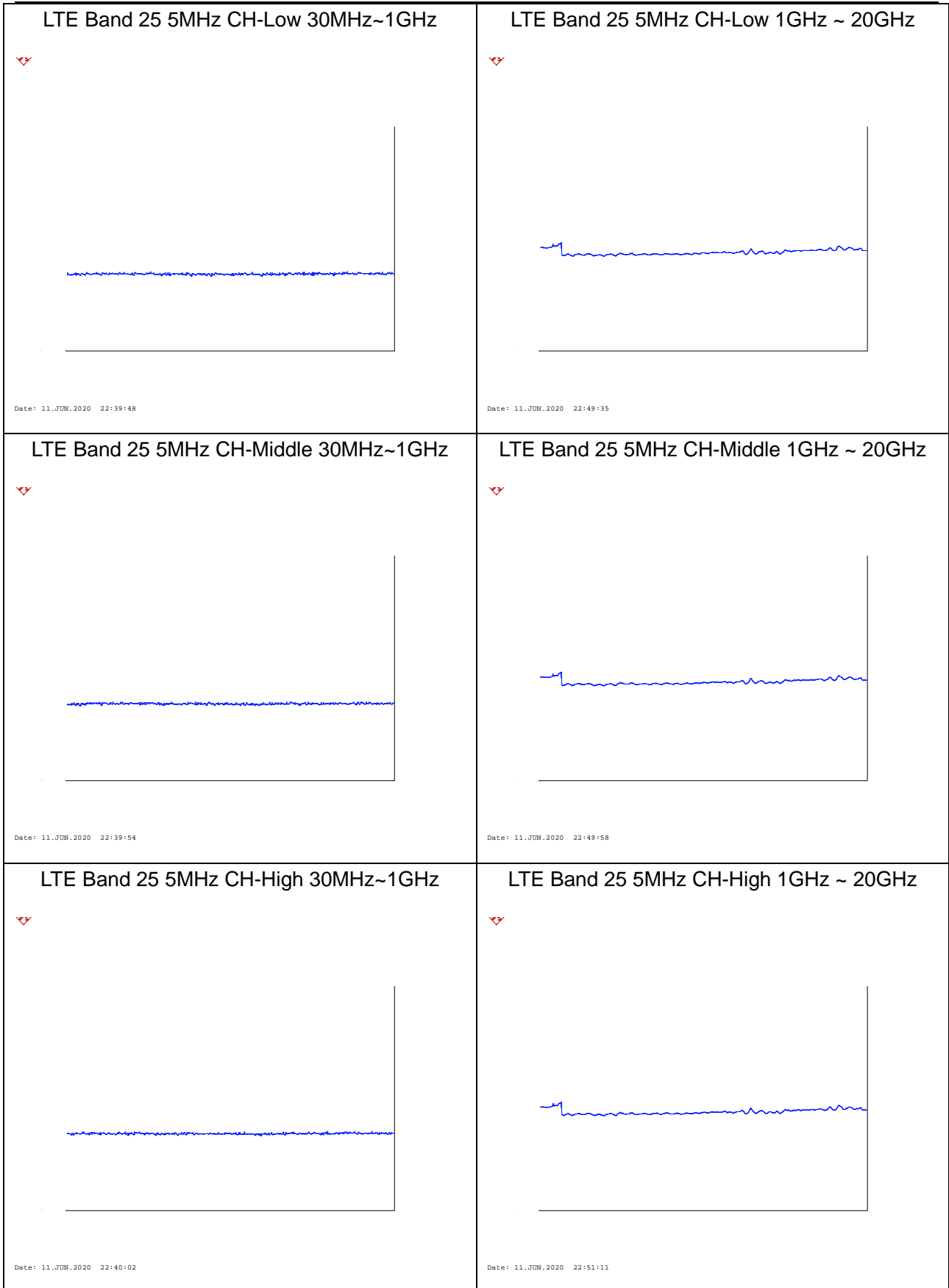



LTE Band 25 10MHz CH-Low 30MHz~1GHz

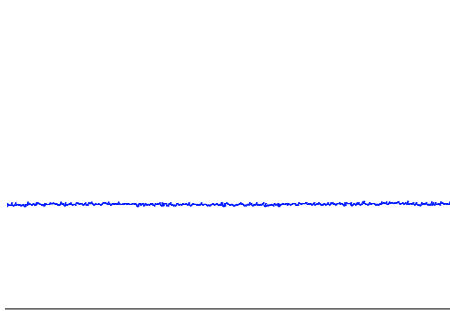

Date: 11.JUN.2020 22:40:09

LTE Band 25 10MHz CH-Low 1GHz ~ 20GHz

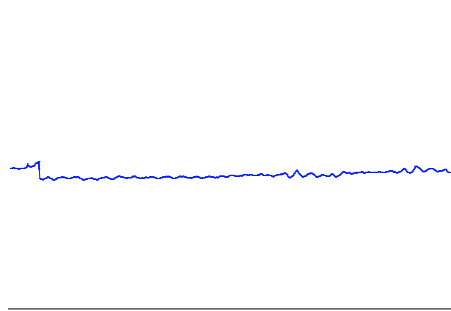

Date: 11.JUN.2020 22:53:10

LTE Band 25 10MHz CH-Middle 30MHz~1GHz

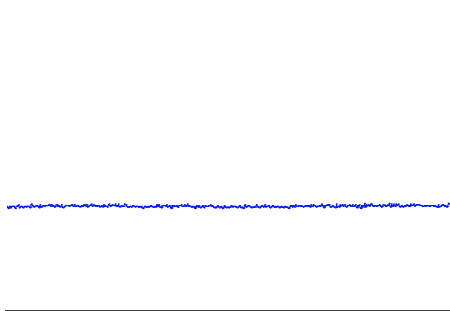

Date: 11.JUN.2020 22:40:19

LTE Band 25 10MHz CH-Middle 1GHz ~ 20GHz

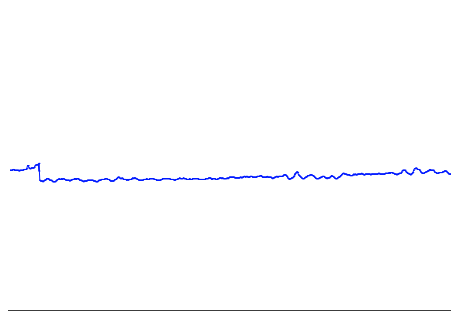

Date: 11.JUN.2020 22:53:41

LTE Band 25 10MHz CH-High 30MHz~1GHz

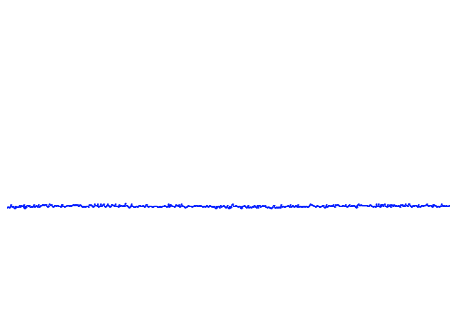

Date: 11.JUN.2020 22:40:26

LTE Band 25 10MHz CH-High 1GHz ~ 20GHz

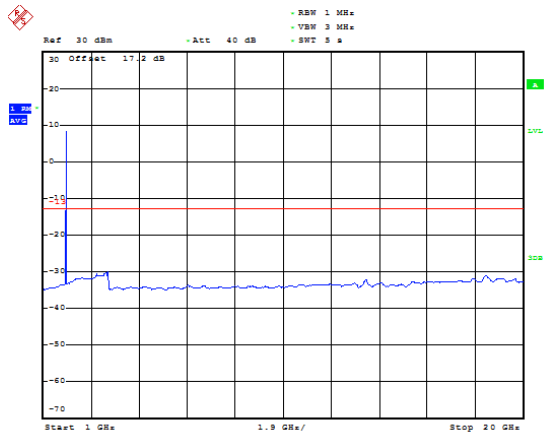

Date: 11.JUN.2020 22:54:07

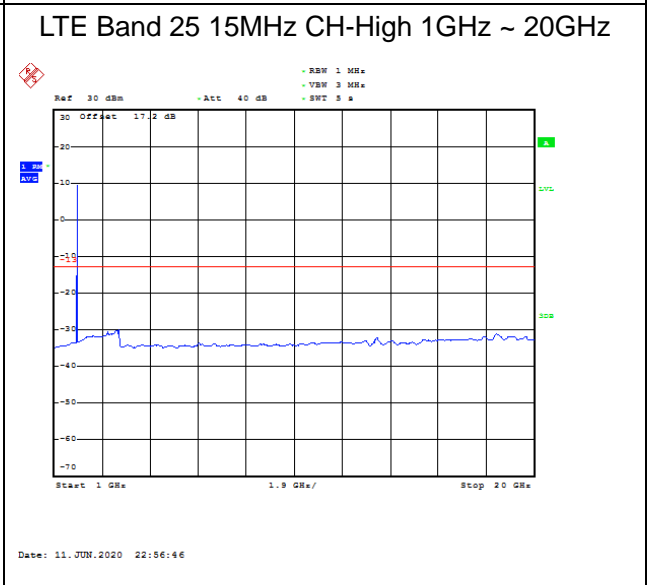
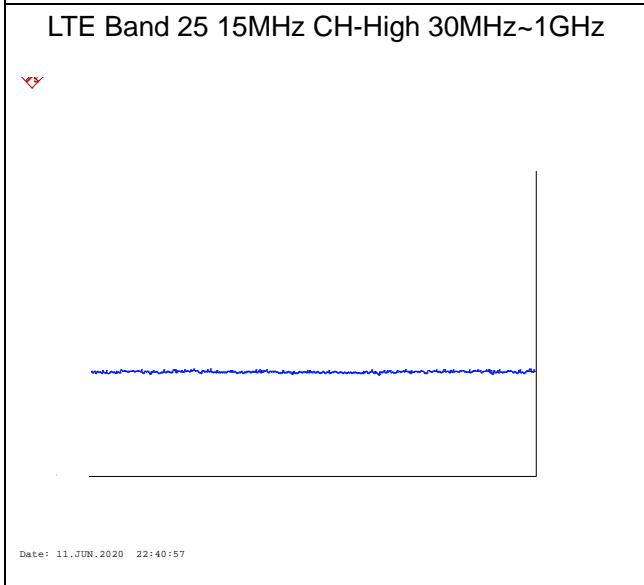
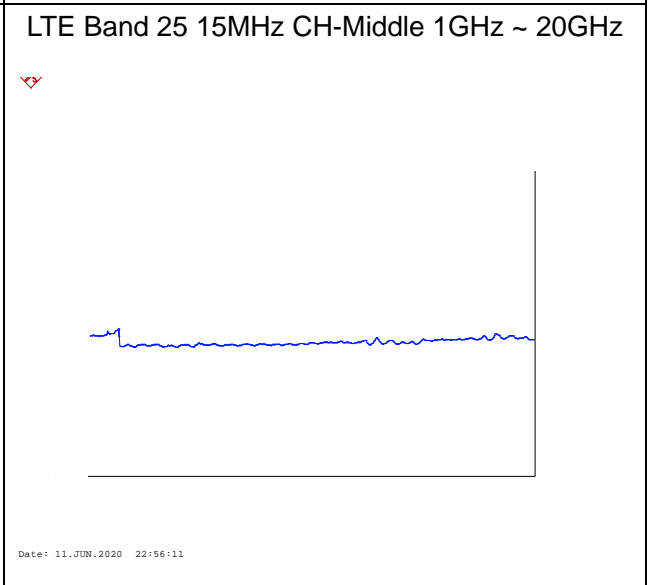
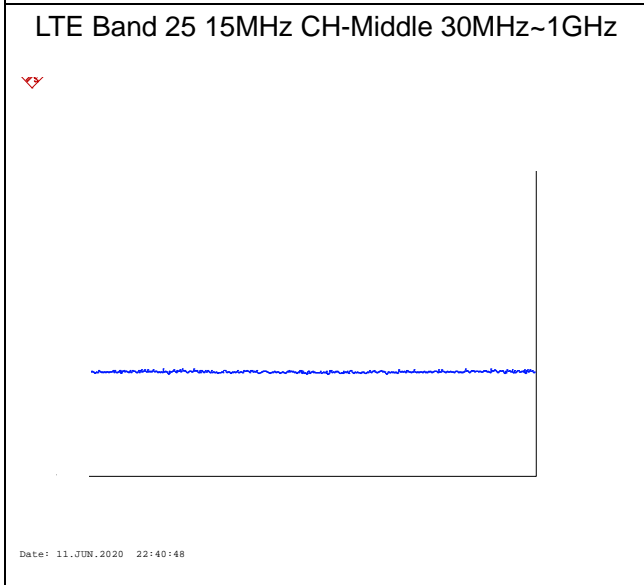
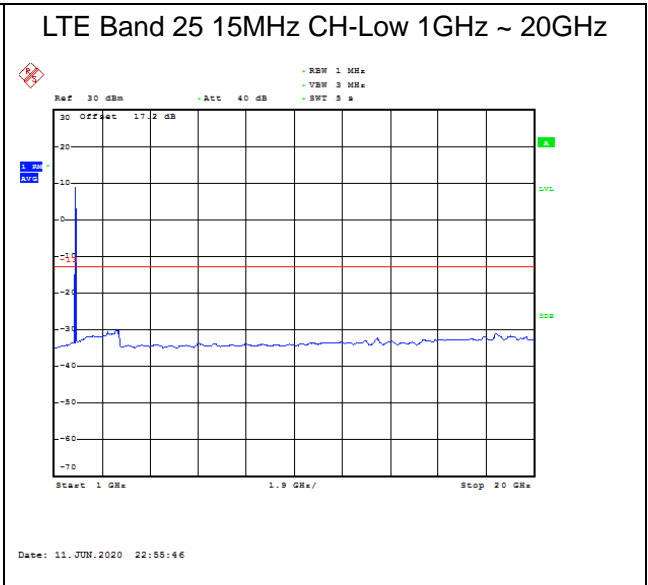
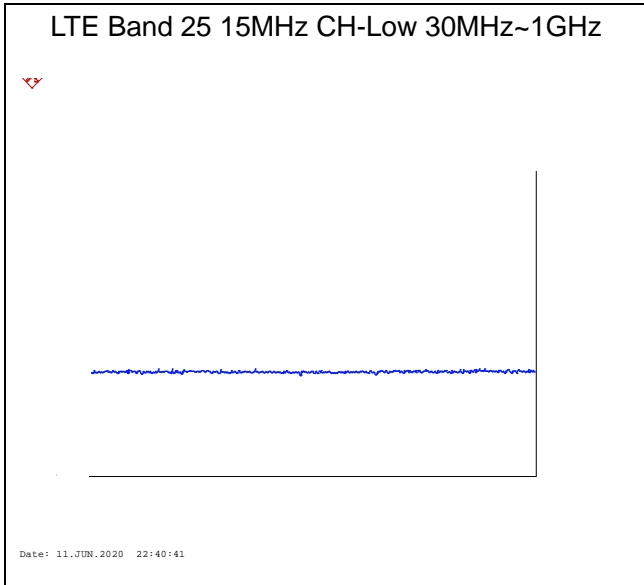

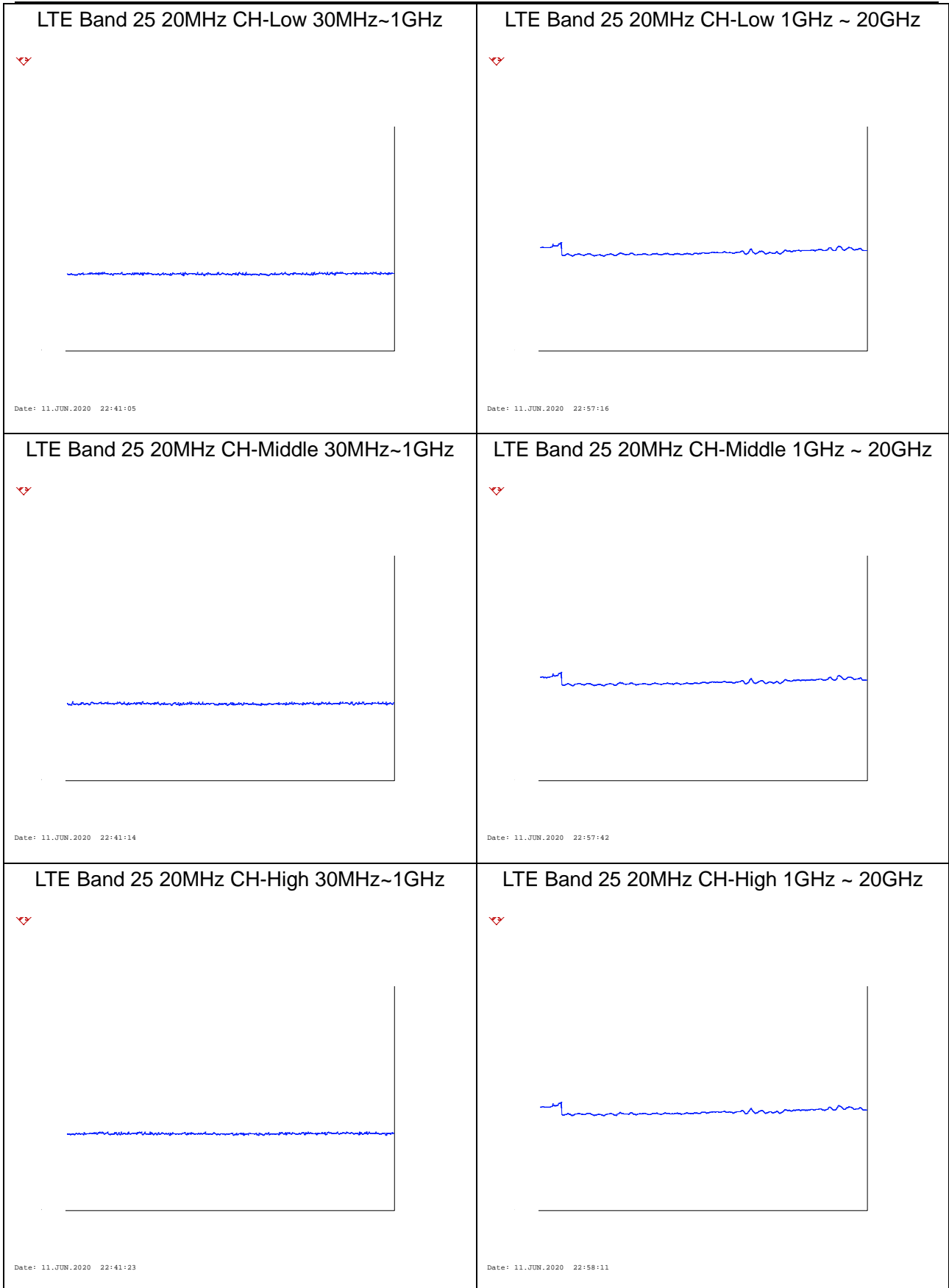

5.7. Radiates Spurious Emission

Ambient condition

Temperature	Relative humidity	Pressure
23°C ~25°C	45%~50%	101.5kPa

Method of Measurement

1. The testing follows FCC KDB 971168 v03r01 Section 5.8 and ANSI C63.26 (2015).
2. Below 1GHz: The EUT is placed on a turntable 0.8 meters above the ground in the chamber, 3 meter away from the antenna. The maximal emission value is acquired by adjusting the antenna height, polarisation and turntable azimuth. Normally, the height range of antenna is 1 m to 4 m, the azimuth range of turntable is 0° to 360°, and the receive antenna has two polarizations Vertical (V) and Horizontal (H). Above 1GHz: (Note: the FCC's permission to use 1.5m as an alternative per TCBC Conf call of Dec. 2, 2014.) The EUT is placed on a turntable 1.5 meters above the ground in the chamber, 3 meter away from the antenna. The maximal emission value is acquired by adjusting the antenna height, polarisation and turntable azimuth. Normally, the height range of antenna is 1 m to 4 m, the azimuth range of turntable is 0° to 360°, and the receive antenna has two polarizations Vertical (V) and Horizontal (H).
3. A loop antenna, A log-periodic antenna or horn antenna shall be substituted in place of the EUT. The log-periodic antenna will be driven by a signal generator and the level will be adjusted till the same power value on the spectrum analyzer or receiver. The level of the spurious emissions can be calculated through the level of the signal generator, cable loss, the gain of the substitution antenna and the reading of the spectrum analyzer or receiver.
4. The EUT is then put into continuously transmitting mode at its maximum power level during the test. Set Test Receiver or Spectrum RBW=200Hz,VBW=600Hz for 9kHz-150kHz , RBW=10kHz, VBW=30kHz 150kHz-30MHz , RBW=100kHz,VBW=300kHz for 30MHz to 1GHz and RBW=1MHz, VBW=3MHz for above 1GHz, And the maximum value of the receiver should be recorded as (Pr).
5. The EUT shall be replaced by a substitution antenna. In the chamber, an substitution antenna for the frequency band of interest is placed at the reference point of the chamber. An RF Signal source for the frequency band of interest is connected to the substitution antenna with a cable that has been constructed to not interfere with the radiation pattern of the antenna. A power (PMea) is applied to the input of the substitution antenna, and adjust the level of the signal generator output until the value of the receiver reach the previously recorded (Pr). The power of signal source (PMea) is recorded. The test should be performed by rotating the test item and adjusting the receiving antenna polarization.
6. A amplifier should be connected to the Signal Source output port. And the cable should be connect between the Amplifier and the Substitution Antenna. The cable loss (Pcl) ,the Substitution Antenna Gain (Ga) and the Amplifier Gain (PAg) should be recorded after test.
7. The measurement results are obtained as described below:
$$\text{Power(EIRP)} = \text{PMea} - \text{PAg} - \text{Pcl} + \text{Ga}$$

The measurement results are amend as described below:
$$\text{Power(EIRP)} = \text{PMea} - \text{Pcl} + \text{Ga}$$
8. This value is EIRP since the measurement is calibrated using an antenna of known gain (2.15 dBi)

and known input power. ERP can be calculated from EIRP by subtracting the gain of the dipole, $ERP = EIRP - 2.15\text{dBi}$.

The modulation mode and RB allocation refer to section 5.1, using the maximum output power configuration.

Test setup

9KHz ~ 30MHz

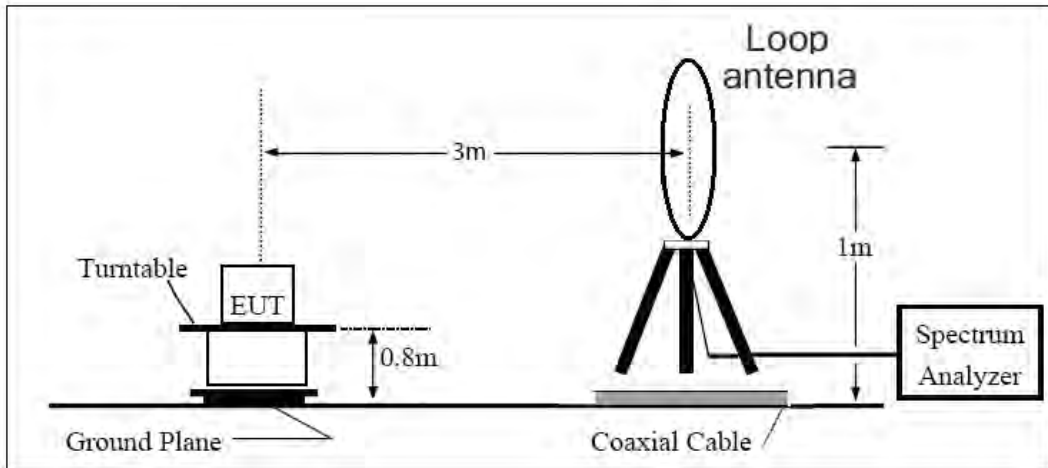

30MHz ~ 1GHz

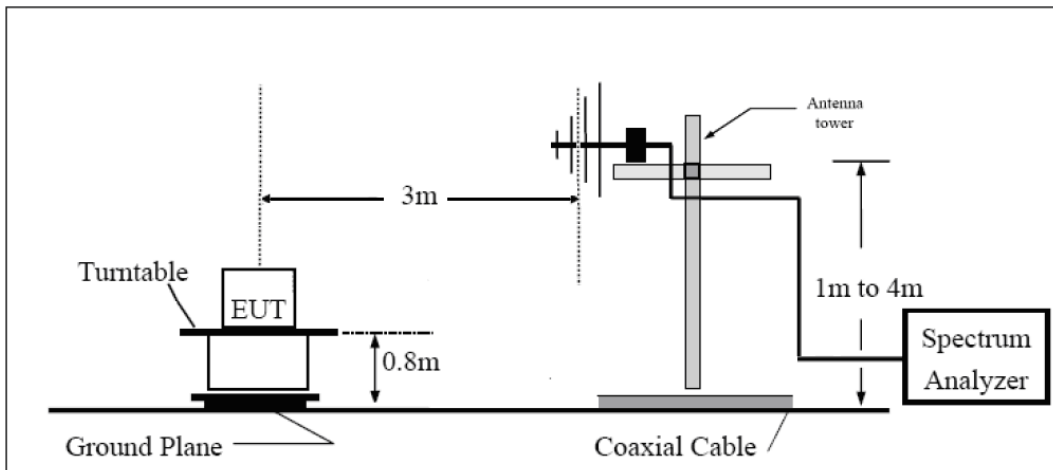

Above 1GHz

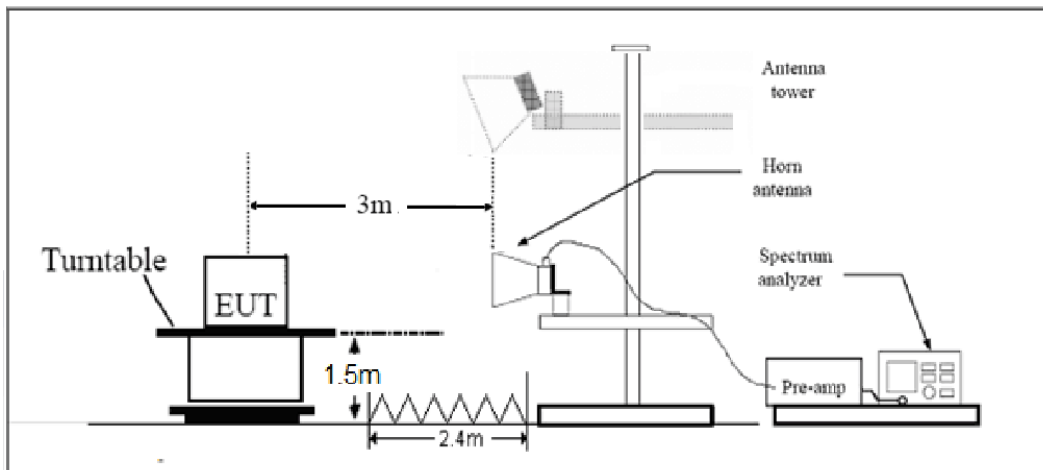



Note: Area side: 2.4mX3.6m

Limits

Rule Part 24.238(a) specifies that “on any frequency outside a licensee's frequency block, the power of any emission shall be attenuated below the transmitter power (P) by at least $43 + 10 \log_{10} (P)$ dB.”

Limit	-13 dBm
-------	---------

Measurement Uncertainty

The assessed measurement uncertainty to ensure 95% confidence level for the normal distribution is with the coverage factor $k = 1.96$, $U = 3.55$ dB.

Test Result

For radiated spurious emissions test, the worst mode (Middle Channel) should be reflected in the report.

Sweep the whole frequency band through the range from 9kHz to the 10th harmonic of the carrier, the emissions below the noise floor will not be recorded in the report.

LTE Band 2 1.4MHz CH-Middle

Harmonic	Frequency (MHz)	SG (dBm)	Cable Loss (dB)	Gain (dBi)	Antenna Polarization	EIRP Level (dBm)	Limit (dBm)	Margin (dB)	Azimuth (deg)
2	3759.0	-53.59	5.10	11.05	Horizontal	-47.64	-13.00	34.64	270
3	5638.9	-56.83	5.42	12.65	Horizontal	-49.60	-13.00	36.60	90
4	7520.0	-48.24	6.70	13.85	Horizontal	-41.09	-13.00	28.09	270
5	9400.0	-54.44	7.01	14.75	Horizontal	-46.70	-13.00	33.70	0
6	11280.0	-51.87	7.48	15.95	Horizontal	-43.40	-13.00	30.40	45
7	13160.0	-50.44	7.51	16.55	Horizontal	-41.40	-13.00	28.40	315
8	15040.0	-48.21	8.24	15.35	Horizontal	-41.10	-13.00	28.10	225
9	16920.0	-46.44	8.41	14.95	Horizontal	-39.90	-13.00	26.90	90
10	18800.0	--	--	--	--	--	--	--	--

Note: 1.The other Spurious RF Radiated emissions level is no more than noise floor.
 2. The worst emission was found in the antenna is Horizontal position.

LTE Band 2 5MHz CH-Middle

Harmonic	Frequency (MHz)	SG (dBm)	Cable Loss (dB)	Gain (dBi)	Antenna Polarization	EIRP Level (dBm)	Limit (dBm)	Margin (dB)	Azimuth (deg)
2	3755.6	-52.75	5.10	11.05	Horizontal	-46.80	-13.00	33.80	45
3	5633.6	-56.33	5.42	12.65	Horizontal	-49.10	-13.00	36.10	315
4	7520.0	-49.85	6.70	13.85	Horizontal	-42.70	-13.00	29.70	90
5	9400.0	-54.94	7.01	14.75	Horizontal	-47.20	-13.00	34.20	0
6	11280.0	-53.27	7.48	15.95	Horizontal	-44.80	-13.00	31.80	0
7	13160.0	-50.84	7.51	16.55	Horizontal	-41.80	-13.00	28.80	45
8	15040.0	-48.51	8.24	15.35	Horizontal	-41.40	-13.00	28.40	135
9	16920.0	-46.34	8.41	14.95	Horizontal	-39.80	-13.00	26.80	225
10	18800.0	--	--	--	--	--	--	--	--

Note: 1.The other Spurious RF Radiated emissions level is no more than noise floor.
 2. The worst emission was found in the antenna is Horizontal position.

LTE Band 2 20MHz CH-Middle

Harmonic	Frequency (MHz)	SG (dBm)	Cable Loss (dB)	Gain (dBi)	Antenna Polarization	EIRP Level (dBm)	Limit (dBm)	Margin (dB)	Azimuth (deg)
2	3742.1	-52.25	5.10	11.05	Horizontal	-46.30	-13.00	33.30	0
3	5613.4	-56.73	5.42	12.65	Horizontal	-49.50	-13.00	36.50	45
4	7484.6	-50.05	6.70	13.85	Horizontal	-42.90	-13.00	29.90	135
5	9400.0	-55.04	7.01	14.75	Horizontal	-47.30	-13.00	34.30	225
6	11280.0	-53.37	7.48	15.95	Horizontal	-44.90	-13.00	31.90	0
7	13160.0	-51.14	7.51	16.55	Horizontal	-42.10	-13.00	29.10	45
8	15040.0	-49.11	8.24	15.35	Horizontal	-42.00	-13.00	29.00	315
9	16920.0	-45.74	8.41	14.95	Horizontal	-39.20	-13.00	26.20	90
10	18800.0	--	--	--	--	--	--	--	--

Note: 1.The other Spurious RF Radiated emissions level is no more than noise floor.
 2. The worst emission was found in the antenna is Horizontal position.

LTE Band 25 1.4MHz CH-Middle

Harmonic	Frequency (MHz)	SG (dBm)	Cable Loss (dB)	Gain (dBi)	Antenna Polarization	EIRP Level (dBm)	Limit (dBm)	Margin (dB)	Azimuth (deg)
2	3765.0	-52.25	5.10	11.05	Horizontal	-46.30	-13.00	33.30	180
3	5647.5	-57.23	5.42	12.65	Horizontal	-50.00	-13.00	37.00	0
4	7530.0	-52.25	6.70	13.85	Horizontal	-45.10	-13.00	32.10	45
5	9412.5	-54.74	7.01	14.75	Horizontal	-47.00	-13.00	34.00	225
6	11295.0	-53.17	7.48	15.95	Horizontal	-44.70	-13.00	31.70	135
7	13177.5	-50.74	7.51	16.55	Horizontal	-41.70	-13.00	28.70	90
8	15060.0	-48.31	8.24	15.35	Horizontal	-41.20	-13.00	28.20	45
9	16942.5	-45.84	8.41	14.95	Horizontal	-39.30	-13.00	26.30	315
10	18825.0	--	--	--	--	--	--	--	--

Note: 1.The other Spurious RF Radiated emissions level is no more than noise floor.
 2. The worst emission was found in the antenna is Horizontal position.

LTE Band 25 5MHz CH-Middle

Harmonic	Frequency (MHz)	SG (dBm)	Cable Loss (dB)	Gain (dBi)	Antenna Polarization	EIRP Level (dBm)	Limit (dBm)	Margin (dB)	Azimuth (deg)
2	3765.0	-51.85	5.10	11.05	Horizontal	-45.90	-13.00	32.90	135
3	5647.5	-57.22	5.42	12.65	Horizontal	-49.99	-13.00	36.99	270
4	7530.0	-51.05	6.70	13.85	Horizontal	-43.90	-13.00	30.90	0
5	9412.5	-54.24	7.01	14.75	Horizontal	-46.50	-13.00	33.50	0
6	11295.0	-53.07	7.48	15.95	Horizontal	-44.60	-13.00	31.60	45
7	13177.5	-50.44	7.51	16.55	Horizontal	-41.40	-13.00	28.40	90
8	15060.0	-49.21	8.24	15.35	Horizontal	-42.10	-13.00	29.10	45
9	16942.5	-46.54	8.41	14.95	Horizontal	-40.00	-13.00	27.00	135
10	18825.0	--	--	--	--	--	--	--	--

Note: 1.The other Spurious RF Radiated emissions level is no more than noise floor.
 2. The worst emission was found in the antenna is Horizontal position.

LTE Band 25 20MHz CH-Middle

Harmonic	Frequency (MHz)	SG (dBm)	Cable Loss (dB)	Gain (dBi)	Antenna Polarization	EIRP Level (dBm)	Limit (dBm)	Margin (dB)	Azimuth (deg)
2	3748.1	-51.45	5.10	11.05	Horizontal	-45.50	-13.00	32.50	90
3	5622.0	-57.22	5.42	12.65	Horizontal	-49.99	-13.00	36.99	180
4	7496.0	-49.95	6.70	13.85	Horizontal	-42.80	-13.00	29.80	135
5	9370.0	-54.24	7.01	14.75	Horizontal	-46.50	-13.00	33.50	45
6	11244.0	-53.47	7.48	15.95	Horizontal	-45.00	-13.00	32.00	315
7	13118.0	-50.14	7.51	16.55	Horizontal	-41.10	-13.00	28.10	270
8	14992.0	-49.61	8.24	15.35	Horizontal	-42.50	-13.00	29.50	45
9	16866.0	-46.44	8.41	14.95	Horizontal	-39.90	-13.00	26.90	315
10	18740.0	--	--	--	--	--	--	--	--

Note: 1.The other Spurious RF Radiated emissions level is no more than noise floor.
 2. The worst emission was found in the antenna is Horizontal position.

6. Main Test Instruments

Name	Manufacturer	Type	Serial Number	Calibration Date	Expiration Date
Base Station Simulator	R&S	CMU200	118133	2020-05-17	2021-05-16
Power Splitter	Hua Xiang	SHX-GF2-2-13	10120101	/	/
Spectrum Analyzer	Key sight	N9010A	MY50210259	2020-05-18	2021-05-17
Universal Radio Communication Tester	Key sight	E5515C	MY48367192	2020-05-27	2021-05-26
Signal Analyzer	R&S	FSV30	100815	2019-12-15	2020-12-14
Loop Antenna	SCHWARZBECK	FMZB1519	1519-047	2017-09-26	2020-09-25
Trilog Antenna	SCHWARZBECK	VUBL 9163	9163-201	2017-11-18	2020-11-17
Horn Antenna	R&S	HF907	102723	2018-08-11	2021-08-10
Horn Antenna	ETS-Lindgren	3160-09	00102643	2018-06-20	2021-06-19
Signal generator	R&S	SMB 100A	102594	2020-05-18	2021-05-17
Climatic Chamber	ESPEC	SU-242	93000506	2017-12-17	2020-12-16
Preampflier	R&S	SCU18	102327	2020-05-18	2021-05-17
MOB COMMS DC SUPPLY	Keysight	66319D	MY43004105	2020-05-18	2021-05-17
RF Cable	Agilent	SMA 15cm	0001	2019-12-13	2020-06-12
RF Cable	Agilent	SMA 15cm	0001	2020-06-12	2020-12-11
Software	R&S	EMC32	9.26.0	/	/

*****END OF REPORT *****



ANNEX A: The EUT Appearance

The EUT Appearance are submitted separately.



ANNEX B: Test Setup Photos

The Test Setup Photos are submitted separately.



ANNEX C: Verify data

The Verify data are submitted separately.



ANNEX D: Product Change Description

The Product Change Description are submitted separately.