



RF TEST REPORT

Applicant Quectel Wireless Solutions Co., Ltd
FCC ID XMR202006EC25AUX
Product LTE Module
Brand Quectel
Model EC25-AUX, EC25-AUX MINIPCIE
Report No. R2108A0762-R2
Issue Date December 1, 2021

TA Technology (Shanghai) Co., Ltd. tested the above equipment in accordance with the requirements in **FCC CFR47 Part 2 (2020)/ FCC CFR 47 Part 24E (2020)**. The test results show that the equipment tested is capable of demonstrating compliance with the requirements as documented in this report.

Performed by: Peng Tao

Approved by: Kai Xu

TA Technology (Shanghai) Co., Ltd.

No.145, Jintang Rd, Tangzhen Industry Park, Pudong Shanghai, China

TEL: +86-021-50791141/2/3

FAX: +86-021-50791141/2/3-8000



TABLE OF CONTENT

1. Test Laboratory	4
1.1. Notes of the test report	4
1.2. Test facility	4
1.3. Testing Location	4
2. General Description of Equipment under Test	5
2.3. Applicant and Manufacturer Information	5
2.4. General information	5
3. Applied Standards	7
4. Test Configuration	8
5. Test Case Results	10
5.1. RF Power Output and Effective Isotropic Radiated Power	10
5.2. Occupied Bandwidth	20
5.3. Band Edge Compliance	31
5.4. Peak-to-Average Power Ratio (PAPR)	42
5.5. Frequency Stability	45
5.6. Spurious Emissions at Antenna Terminals	52
5.7. Radiates Spurious Emission	65
6. Main Test Instruments	71
ANNEX A: The EUT Appearance	73
ANNEX B: Test Setup Photos	74
ANNEX C: Product Change Description	75
ANNEX D: Verify data	76

Summary of measurement results

No.	Test Case	Clause in FCC rules	Verdict
1	RF Power Output and Effective Isotropic Radiated Power	2.1046 24.232(c)	PASS
2	Occupied Bandwidth	2.1049	PASS
3	Band Edge Compliance	2.1051 /24.238(a)	PASS
4	Peak-to-Average Power Ratio	24.232/KDB 971168 D01(5.7)	PASS
5	Frequency Stability	2.1055 / 24.235	PASS
6	Spurious Emissions at Antenna Terminals	2.1051 / 24.238(a)	PASS
7	Radiates Spurious Emission	2.1053 / 24.238(a)	PASS
Date of Testing: (Original) April 12, 2018~ April 18, 2018 and May 12, 2020~ May 13, 2020 (Variant) September 28, 2021~ October 4, 2021			
Note: PASS: The EUT complies with the essential requirements in the standard. FAIL: The EUT does not comply with the essential requirements in the standard. All indications of Pass/Fail in this report are opinions expressed by TA Technology (Shanghai) Co., Ltd. based on interpretations and/or observations of test results. Measurement Uncertainties were not taken into account and are published for informational purposes only.			

EC25-AUX, EC25-AUX MINIPCIE (Report No.: R2108A0762-R2) is a variant model of EC25-AUX, EC25-AUX MINIPCIE (Report No.: R2005A0269-R2). There is only changed the Power Amplifier and Software Version of product.

Tested cases refer to the following table. Please refer to Appendix C for Verify data

Test Case	Original	Variant
RF Power Output and Effective Radiated Power	PASS	Retest(GSM1900/ WCDMA Band II/ LTE Band 2)
Occupied Bandwidth	PASS	Verify the worst combination of each frequency band(GSM1900/ WCDMA Band II/ LTE Band 2)
Band Edge Compliance	PASS	Verify the worst combination of each frequency band(GSM1900/ WCDMA Band II/ LTE Band 2)
Peak-to-Average Power Ratio	PASS	Retest(GSM1900/ WCDMA Band II/ LTE Band 2)
Frequency Stability	PASS	Retest(GSM1900/ WCDMA Band II/ LTE Band 2)
Spurious Emissions at Antenna Terminals	PASS	Verify the worst combination of each frequency band(GSM1900/ WCDMA Band II/ LTE Band 2)
Radiates Spurious Emission	PASS	Retest(GSM1900/ WCDMA Band II/ LTE Band 2)

The detailed product change description please refers to the Difference Declaration Letter.

1. Test Laboratory

1.1. Notes of the test report

This report shall not be reproduced in full or partial, without the written approval of **TA technology (shanghai) co., Ltd.** The results documented in this report apply only to the tested sample, under the conditions and modes of operation as described herein. Measurement Uncertainties were not taken into account and are published for informational purposes only. This report is written to support regulatory compliance of the applicable standards stated above.

1.2. Test facility

FCC (Designation number: CN1179, Test Firm Registration Number: 446626)

TA Technology (Shanghai) Co., Ltd. has been listed on the US Federal Communications Commission list of test facilities recognized to perform electromagnetic emissions measurements.

A2LA (Certificate Number: 3857.01)

TA Technology (Shanghai) Co., Ltd. has been listed by American Association for Laboratory Accreditation to perform electromagnetic emission measurement.

1.3. Testing Location

Company: TA Technology (Shanghai) Co., Ltd.
Address: No.145, Jintang Rd, Tangzhen Industry Park, Pudong
City: Shanghai
Post code: 201201
Country: P. R. China
Contact: Xu Kai
Telephone: +86-021-50791141/2/3
Fax: +86-021-50791141/2/3-8000
Website: <http://www.ta-shanghai.com>
E-mail: xukai@ta-shanghai.com

2. General Description of Equipment under Test

2.3. Applicant and Manufacturer Information

Applicant	Quectel Wireless Solutions Co., Ltd
Applicant address	Building 5, Shanghai Business Park Phase III (Area B), No.1016 Tianlin Road, Minhang District, Shanghai, China 200233
Manufacturer	Quectel Wireless Solutions Co., Ltd
Manufacturer address	Building 5, Shanghai Business Park Phase III (Area B), No.1016 Tianlin Road, Minhang District, Shanghai, China 200233

2.4. General information

EUT Description			
Model	EC25-AUX, EC25-AUX MINIPCIE		
IMEI:	862708040005709		
Hardware Version	R2.0		
Software Version	EC25AUXGAR08A05M1G		
Power Supply	External supply power		
Antenna Type	The EUT don't have standard Antenna, The Antenna used for testing in this report is the after-market accessory (Dipole Antenna)		
Antenna Gain	1.38dBi		
Test Mode(s)	GSM1900; WCDMA Band II; LTE Band 2;		
Test Modulation	(GSM)GMSK,8PSK; (WCDMA) BPSK, QPSK, 16QAM (LTE)QPSK,16QAM		
GPRS Multislot Class	33		
EGPRS Multislot Class	33		
HSDPA UE Category	24		
HSUPA UE Category	6		
DC-HSDPA UE Category	24		
LTE Category	4		
Maximum E.I.R.P	GSM 1900:	31.31dBm	
	WCDMA Band II:	25.05dBm	
	LTE Band 2:	24.96dBm	
Rated Power Supply Voltage	3.8 V		
Extreme Voltage	Minimum: 3.3 V Maximum: 4.3V		
Extreme Temperature	Lowest: -40°C Highest: +85°C		
Operating Frequency Range(s)	Band	Tx (MHz)	Rx (MHz)
	GSM1900	1850 ~ 1910	1930 ~ 1990
	WCDMA Band II	1850 ~ 1910	1930 ~ 1990



	LTE Band 2	1850 ~ 1910	1930 ~ 1990
Note: 1. The EUT is sent from the applicant to TA and the information of the EUT is declared by the applicant.			

The series model number is: EC25-AUX MINIPCIE. The difference of these models are have different marketing requirement.

3. Applied Standards

According to the specifications of the manufacturer, it must comply with the requirements of the following standards:

Test standards:

FCC CFR 47 Part 24E (2020)

FCC CFR47 Part 2 (2020)

Reference standard:

ANSI C63.26 (2015)

KDB 971168 D01 Power Meas License Digital Systems v03r01

4. Test Configuration

Radiated measurements are performed by rotating the EUT in three different orthogonal test planes. EUT stand-up position (Z axis), lie-down position (X, Y axis). Receiver antenna polarization (horizontal and vertical), the worst emission was found in position (Z axis, horizontal polarization) and the worst case was recorded.

All mode and data rates and positions and RB size and modulations were investigated.

Subsequently, only the worst case emissions are reported.

The following testing in GSM/WCDMA/LTE is set based on the maximum RF Output Power.

Test modes are chosen to be reported as the worst case configuration below:

Test items	Modes/Modulation	
	GSM 1900	WCDMA Band II
RF Power Output and Effective Isotropic Radiated Power	GSM GPRS EGPRS	RMC HSDPA/HSUPA DC-HSDPA
Occupied Bandwidth	GSM GPRS(1Tx slot) EGPRS(1Tx slot)	RMC
Band Edge Compliance	GSM GPRS(1Tx slot) EGPRS(1Tx slot)	RMC
Peak-to-Average Power Ratio	GSM GPRS(1Tx slot) EGPRS(1Tx slot)	RMC
Frequency Stability	GSM GPRS(1Tx slot) EGPRS(1Tx slot)	RMC
Spurious Emissions at Antenna Terminals	GSM	RMC
Radiates Spurious Emission	GSM	RMC



Test modes are chosen to be reported as the worst case configuration below for LTE Band 2:

Test items	Bandwidth (MHz)						Modulation		RB			Test Channel		
	1.4	3	5	10	15	20	QPSK	16QAM	1	50%	100%	L	M	H
RF Power Output and Effective Isotropic Radiated Power	○	○	○	○	○	○	○	○	○	○	○	○	○	○
Occupied Bandwidth	○	○	○	○	○	○	○	○	-	-	○	○	○	○
Band Edge Compliance	○	○	○	○	○	○	○	○	○	-	○	○	-	○
Peak-to-Average Power Ratio	○	○	○	○	○	○	○	○	-	-	○	○	○	○
Frequency Stability	○	○	○	○	○	○	○	○	○	○	○	○	○	○
Conducted Spurious Emissions	○	○	○	○	○	○	○	-	○	-	-	○	○	○
Radiates Spurious Emission	○	-	○	-	-	○	○	-	○	-	-	-	○	-
Note	1. The mark "○" means that this configuration is chosen for testing. 2. The mark "-" means that this configuration is not testing.													

5. Test Case Results

5.1. RF Power Output and Effective Isotropic Radiated Power

Ambient condition

Temperature	Relative humidity	Pressure
23°C ~25°C	45%~50%	101.5kPa

Methods of Measurement

During the process of the testing, The EUT is controlled by the Base Station Simulator to ensure max power transmission and proper modulation.

The testing follows FCC KDB 971168 v03r01 Section 5.8 and ANSI C63.26 (2015).

- a) Connect the equipment as illustrated. Mount the equipment with the manufacturer specified antenna in a vertical orientation on a manufacturer specified mounting surface located on a non-conducting rotating platform of a RF anechoic chamber (preferred) or a standard radiation site.
- b) Key the transmitter, then rotate the EUT 360° azimuthally and record spectrum analyzer power level (LVL) measurements at angular increments that are sufficiently small to permit resolution of all peaks. If a standard radiation test site is used, raise and lower the test antenna to obtain a maximum reading at each angular increment. (Note: several batteries may be needed to offset the effect of battery voltage droop, which should not exceed 5% of the manufactured specified battery voltage during transmission).
- c) Replace the transmitter under test with a vertically polarized half-wave dipole (or an antenna whose gain is known relative to an ideal half-wave dipole). The center of the antenna should be at the same location as the center of the antenna under test.
- d) Connect the antenna to a signal generator with a known output power and record the path loss (in dB) as LOSS. If a standard radiation test site is used, raise and lower the test antenna to obtain a maximum reading. $LOSS = \text{Generator Output Power (dBm)} - \text{Analyzer reading (dBm)}$
- e) Determine the effective radiated output power at each angular position from the readings in steps b) and d) using the following equation: $ERP \text{ (dBm)} = \text{LVL (dBm)} + \text{LOSS (dB)}$
- f) The maximum ERP is the maximum value determined in the preceding step.
- g) When calculating ERP, in addition to knowing the antenna radiation and matching characteristics, it is necessary to know the loss values of all elements (e.g. transmission line attenuation, mismatches, filters, combiners) interposed between the point where transmitter output power is measured, and the point where power is applied to the antenna. ERP can then be calculated as follows:
 $EIRP \text{ (dBm)} = \text{Output Power (dBm)} - \text{Losses (dB)} + \text{Antenna Gain (dBi)}$
where: dBd refers to gain relative to an ideal dipole.
 $EIRP \text{ (dBm)} = \text{ERP (dBm)} + 2.15 \text{ (dB.)}$

The RB allocation refers to section 5.1, using the maximum output power configuration.

Test Setup

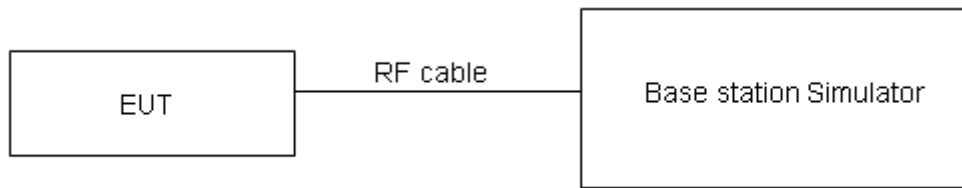

The loss between RF output port of the EUT and the input port of the tester has been taken into consideration.

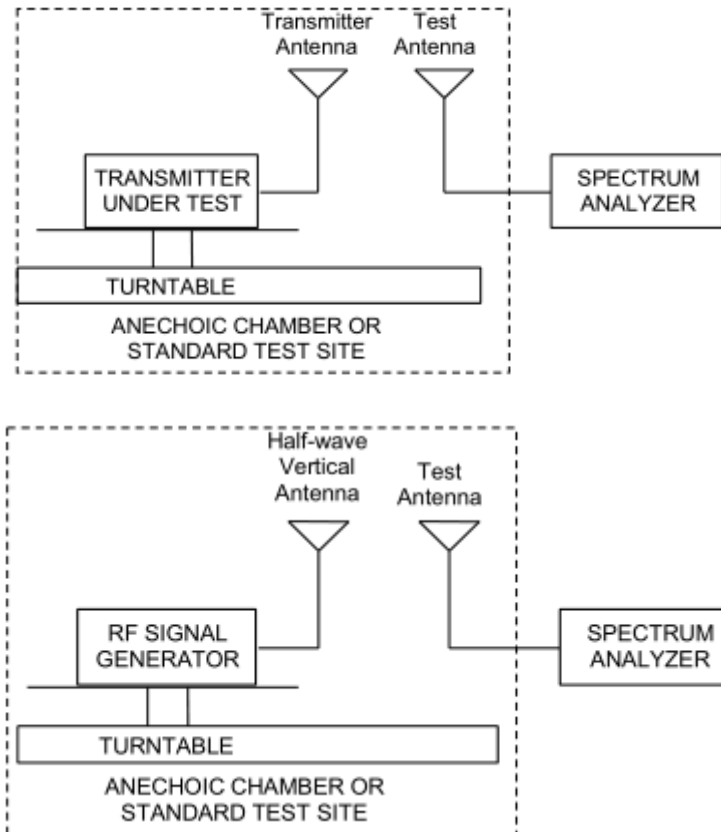

Limits

No specific RF power output requirements in part 2.1046.

Rule Part 24.232(c) Mobile and portable stations are limited to 2 watts EIRP.

Rule Part 24.232(e) Peak transmit power must be measured over any interval of continuous transmission using instrumentation calibrated in terms of an rms-equivalent voltage.

Limit	$\leq 2\text{ W}$ (33 dBm)
-------	----------------------------

Measurement Uncertainty

The assessed measurement uncertainty to ensure 95% confidence level for the normal distribution is with the coverage factor $k = 2$, $U = 0.4$ dB for RF power output, $k = 2$, $U = 1.19$ dB for EIRP.



Test Results

GSM 1900		Conducted Power (dBm)			EIRP (dBm)		
		Channel 512	Channel 661	Channel 810	Channel 512	Channel 661	Channel 810
		1850.2 (MHz)	1880 (MHz)	1909.8 (MHz)	1850.2 (MHz)	1880 (MHz)	1909.8 (MHz)
GSM	Results	29.90	29.93	29.81	31.28	31.31	31.19
GPRS/EGPRS (GMSK)	1TXslot	29.79	29.78	29.64	31.17	31.16	31.02
	2TXslots	28.91	28.72	28.61	30.29	30.10	29.99
	3TXslots	26.75	26.92	26.91	28.13	28.30	28.29
	4TXslots	25.62	25.84	25.83	27.00	27.22	27.21
EGPRS (8PSK)	1TXslot	25.92	26.15	25.76	27.30	27.53	27.14
	2TXslots	25.36	25.78	25.74	26.74	27.16	27.12
	3TXslots	23.73	23.84	23.96	25.11	25.22	25.34
	4TXslots	22.71	22.49	22.52	24.09	23.87	23.90

WCDMA Band II		Conducted Power (dBm)			EIRP (dBm)		
		Channel 9262	Channel 9400	Channel 9538	Channel 9262	Channel 9400	Channel 9538
		1852.4 (MHz)	1880 (MHz)	1907.6 (MHz)	1852.4 (MHz)	1880 (MHz)	1907.6 (MHz)
RMC	12.2k	23.59	23.67	23.66	24.97	25.05	25.04
HSDPA	Sub - Test 1	23.05	23.09	23.10	24.43	24.47	24.48
	Sub - Test 2	23.04	23.11	23.07	24.42	24.49	24.45
	Sub - Test 3	22.51	22.61	22.59	23.89	23.99	23.97
	Sub - Test 4	22.52	22.62	22.57	23.90	24.00	23.95
HSUPA	Sub - Test 1	23.01	23.08	23.05	24.39	24.46	24.43
	Sub - Test 2	22.00	22.06	22.04	23.38	23.44	23.42
	Sub - Test 3	22.47	22.54	22.53	23.85	23.92	23.91
	Sub - Test 4	21.93	22.03	22.01	23.31	23.41	23.39
	Sub - Test 5	22.94	23.01	22.99	24.32	24.39	24.37
DC-HSDPA	Sub - Test 1	22.93	23.03	23.00	24.31	24.41	24.38
	Sub - Test 2	22.92	23.02	22.99	24.30	24.40	24.37
	Sub - Test 3	22.50	22.51	22.50	23.88	23.89	23.88
	Sub - Test 4	22.49	22.50	22.49	23.87	23.88	23.87



Band	Bandwidth (MHz)	UL Channel	RB Size	RB Position	Modulation	Power (dBm)	EIRP (dBm)	Verdict
LTE Band2	1.4	18607	1	#0	QPSK	23.58	24.96	PASS
LTE Band2	1.4	18607	1	#Mid	QPSK	23.56	24.94	PASS
LTE Band2	1.4	18607	1	#Max	QPSK	23.37	24.75	PASS
LTE Band2	1.4	18607	3	#0	QPSK	23.40	24.78	PASS
LTE Band2	1.4	18607	3	#Mid	QPSK	23.39	24.77	PASS
LTE Band2	1.4	18607	3	#Max	QPSK	23.28	24.66	PASS
LTE Band2	1.4	18607	6	#0	QPSK	22.34	23.72	PASS
LTE Band2	1.4	18607	1	#0	QAM16	22.70	24.08	PASS
LTE Band2	1.4	18607	1	#Mid	QAM16	22.63	24.01	PASS
LTE Band2	1.4	18607	1	#Max	QAM16	22.17	23.55	PASS
LTE Band2	1.4	18607	3	#0	QAM16	22.40	23.78	PASS
LTE Band2	1.4	18607	3	#Mid	QAM16	22.40	23.78	PASS
LTE Band2	1.4	18607	3	#Max	QAM16	22.41	23.79	PASS
LTE Band2	1.4	18607	6	#0	QAM16	21.35	22.73	PASS
LTE Band2	1.4	18900	1	#0	QPSK	23.02	24.40	PASS
LTE Band2	1.4	18900	1	#Mid	QPSK	23.17	24.55	PASS
LTE Band2	1.4	18900	1	#Max	QPSK	22.96	24.34	PASS
LTE Band2	1.4	18900	3	#0	QPSK	23.30	24.68	PASS
LTE Band2	1.4	18900	3	#Mid	QPSK	23.31	24.69	PASS
LTE Band2	1.4	18900	3	#Max	QPSK	23.29	24.67	PASS
LTE Band2	1.4	18900	6	#0	QPSK	22.24	23.62	PASS
LTE Band2	1.4	18900	1	#0	QAM16	22.50	23.88	PASS
LTE Band2	1.4	18900	1	#Mid	QAM16	22.84	24.22	PASS
LTE Band2	1.4	18900	1	#Max	QAM16	22.58	23.96	PASS
LTE Band2	1.4	18900	3	#0	QAM16	22.32	23.70	PASS
LTE Band2	1.4	18900	3	#Mid	QAM16	22.31	23.69	PASS
LTE Band2	1.4	18900	3	#Max	QAM16	22.42	23.80	PASS
LTE Band2	1.4	18900	6	#0	QAM16	21.22	22.60	PASS
LTE Band2	1.4	19193	1	#0	QPSK	23.28	24.66	PASS
LTE Band2	1.4	19193	1	#Mid	QPSK	23.56	24.94	PASS
LTE Band2	1.4	19193	1	#Max	QPSK	23.29	24.67	PASS
LTE Band2	1.4	19193	3	#0	QPSK	23.42	24.80	PASS
LTE Band2	1.4	19193	3	#Mid	QPSK	23.50	24.88	PASS
LTE Band2	1.4	19193	3	#Max	QPSK	23.24	24.62	PASS
LTE Band2	1.4	19193	6	#0	QPSK	22.32	23.70	PASS
LTE Band2	1.4	19193	1	#0	QAM16	21.67	23.05	PASS
LTE Band2	1.4	19193	1	#Mid	QAM16	21.79	23.17	PASS
LTE Band2	1.4	19193	1	#Max	QAM16	21.68	23.06	PASS
LTE Band2	1.4	19193	3	#0	QAM16	22.25	23.63	PASS
LTE Band2	1.4	19193	3	#Mid	QAM16	22.20	23.58	PASS



LTE Band2	1.4	19193	3	#Max	QAM16	21.97	23.35	PASS
LTE Band2	1.4	19193	6	#0	QAM16	21.35	22.73	PASS
LTE Band2	3	18615	1	#0	QPSK	23.37	24.75	PASS
LTE Band2	3	18615	1	#Mid	QPSK	23.31	24.69	PASS
LTE Band2	3	18615	1	#Max	QPSK	23.28	24.66	PASS
LTE Band2	3	18615	8	#0	QPSK	22.32	23.70	PASS
LTE Band2	3	18615	8	#Mid	QPSK	22.33	23.71	PASS
LTE Band2	3	18615	8	#Max	QPSK	22.35	23.73	PASS
LTE Band2	3	18615	15	#0	QPSK	22.33	23.71	PASS
LTE Band2	3	18615	1	#0	QAM16	22.92	24.30	PASS
LTE Band2	3	18615	1	#Mid	QAM16	22.87	24.25	PASS
LTE Band2	3	18615	1	#Max	QAM16	22.96	24.34	PASS
LTE Band2	3	18615	8	#0	QAM16	21.45	22.83	PASS
LTE Band2	3	18615	8	#Mid	QAM16	21.45	22.83	PASS
LTE Band2	3	18615	8	#Max	QAM16	21.47	22.85	PASS
LTE Band2	3	18615	15	#0	QAM16	21.20	22.58	PASS
LTE Band2	3	18900	1	#0	QPSK	23.14	24.52	PASS
LTE Band2	3	18900	1	#Mid	QPSK	23.19	24.57	PASS
LTE Band2	3	18900	1	#Max	QPSK	23.14	24.52	PASS
LTE Band2	3	18900	8	#0	QPSK	22.27	23.65	PASS
LTE Band2	3	18900	8	#Mid	QPSK	22.26	23.64	PASS
LTE Band2	3	18900	8	#Max	QPSK	22.22	23.60	PASS
LTE Band2	3	18900	15	#0	QPSK	22.22	23.60	PASS
LTE Band2	3	18900	1	#0	QAM16	22.42	23.80	PASS
LTE Band2	3	18900	1	#Mid	QAM16	22.37	23.75	PASS
LTE Band2	3	18900	1	#Max	QAM16	22.45	23.83	PASS
LTE Band2	3	18900	8	#0	QAM16	21.16	22.54	PASS
LTE Band2	3	18900	8	#Mid	QAM16	21.13	22.51	PASS
LTE Band2	3	18900	8	#Max	QAM16	21.23	22.61	PASS
LTE Band2	3	18900	15	#0	QAM16	21.01	22.39	PASS
LTE Band2	3	19185	1	#0	QPSK	23.33	24.71	PASS
LTE Band2	3	19185	1	#Mid	QPSK	23.11	24.49	PASS
LTE Band2	3	19185	1	#Max	QPSK	23.17	24.55	PASS
LTE Band2	3	19185	8	#0	QPSK	22.09	23.47	PASS
LTE Band2	3	19185	8	#Mid	QPSK	22.10	23.48	PASS
LTE Band2	3	19185	8	#Max	QPSK	22.06	23.44	PASS
LTE Band2	3	19185	15	#0	QPSK	22.04	23.42	PASS
LTE Band2	3	19185	1	#0	QAM16	22.21	23.59	PASS
LTE Band2	3	19185	1	#Mid	QAM16	22.14	23.52	PASS
LTE Band2	3	19185	1	#Max	QAM16	22.08	23.46	PASS
LTE Band2	3	19185	8	#0	QAM16	21.12	22.50	PASS
LTE Band2	3	19185	8	#Mid	QAM16	21.14	22.52	PASS



LTE Band2	3	19185	8	#Max	QAM16	21.01	22.39	PASS
LTE Band2	3	19185	15	#0	QAM16	21.08	22.46	PASS
LTE Band2	5	18625	1	#0	QPSK	23.43	24.81	PASS
LTE Band2	5	18625	1	#Mid	QPSK	23.13	24.51	PASS
LTE Band2	5	18625	1	#Max	QPSK	23.25	24.63	PASS
LTE Band2	5	18625	12	#0	QPSK	22.31	23.69	PASS
LTE Band2	5	18625	12	#Mid	QPSK	22.31	23.69	PASS
LTE Band2	5	18625	12	#Max	QPSK	22.32	23.70	PASS
LTE Band2	5	18625	25	#0	QPSK	22.30	23.68	PASS
LTE Band2	5	18625	1	#0	QAM16	22.75	24.13	PASS
LTE Band2	5	18625	1	#Mid	QAM16	22.78	24.16	PASS
LTE Band2	5	18625	1	#Max	QAM16	22.69	24.07	PASS
LTE Band2	5	18625	12	#0	QAM16	21.08	22.46	PASS
LTE Band2	5	18625	12	#Mid	QAM16	21.10	22.48	PASS
LTE Band2	5	18625	12	#Max	QAM16	21.12	22.50	PASS
LTE Band2	5	18625	25	#0	QAM16	21.12	22.50	PASS
LTE Band2	5	18900	1	#0	QPSK	23.11	24.49	PASS
LTE Band2	5	18900	1	#Mid	QPSK	22.93	24.31	PASS
LTE Band2	5	18900	1	#Max	QPSK	23.00	24.38	PASS
LTE Band2	5	18900	12	#0	QPSK	22.17	23.55	PASS
LTE Band2	5	18900	12	#Mid	QPSK	22.16	23.54	PASS
LTE Band2	5	18900	12	#Max	QPSK	22.10	23.48	PASS
LTE Band2	5	18900	25	#0	QPSK	22.09	23.47	PASS
LTE Band2	5	18900	1	#0	QAM16	22.20	23.58	PASS
LTE Band2	5	18900	1	#Mid	QAM16	22.21	23.59	PASS
LTE Band2	5	18900	1	#Max	QAM16	22.46	23.84	PASS
LTE Band2	5	18900	12	#0	QAM16	20.91	22.29	PASS
LTE Band2	5	18900	12	#Mid	QAM16	20.92	22.30	PASS
LTE Band2	5	18900	12	#Max	QAM16	20.86	22.24	PASS
LTE Band2	5	18900	25	#0	QAM16	21.04	22.42	PASS
LTE Band2	5	19175	1	#0	QPSK	23.10	24.48	PASS
LTE Band2	5	19175	1	#Mid	QPSK	22.95	24.33	PASS
LTE Band2	5	19175	1	#Max	QPSK	22.84	24.22	PASS
LTE Band2	5	19175	12	#0	QPSK	22.10	23.48	PASS
LTE Band2	5	19175	12	#Mid	QPSK	22.11	23.49	PASS
LTE Band2	5	19175	12	#Max	QPSK	22.06	23.44	PASS
LTE Band2	5	19175	25	#0	QPSK	22.14	23.52	PASS
LTE Band2	5	19175	1	#0	QAM16	21.91	23.29	PASS
LTE Band2	5	19175	1	#Mid	QAM16	21.90	23.28	PASS
LTE Band2	5	19175	1	#Max	QAM16	22.19	23.57	PASS
LTE Band2	5	19175	12	#0	QAM16	21.17	22.55	PASS
LTE Band2	5	19175	12	#Mid	QAM16	21.19	22.57	PASS



LTE Band2	5	19175	12	#Max	QAM16	21.15	22.53	PASS
LTE Band2	5	19175	25	#0	QAM16	21.01	22.39	PASS
LTE Band2	10	18650	1	#0	QPSK	23.17	24.55	PASS
LTE Band2	10	18650	1	#Mid	QPSK	23.10	24.48	PASS
LTE Band2	10	18650	1	#Max	QPSK	23.10	24.48	PASS
LTE Band2	10	18650	25	#0	QPSK	22.24	23.62	PASS
LTE Band2	10	18650	25	#Mid	QPSK	22.26	23.64	PASS
LTE Band2	10	18650	25	#Max	QPSK	22.25	23.63	PASS
LTE Band2	10	18650	50	#0	QPSK	22.24	23.62	PASS
LTE Band2	10	18650	1	#0	QAM16	22.33	23.71	PASS
LTE Band2	10	18650	1	#Mid	QAM16	22.49	23.87	PASS
LTE Band2	10	18650	1	#Max	QAM16	22.41	23.79	PASS
LTE Band2	10	18650	25	#0	QAM16	21.22	22.60	PASS
LTE Band2	10	18650	25	#Mid	QAM16	21.29	22.67	PASS
LTE Band2	10	18650	25	#Max	QAM16	21.31	22.69	PASS
LTE Band2	10	18650	50	#0	QAM16	21.21	22.59	PASS
LTE Band2	10	18900	1	#0	QPSK	22.95	24.33	PASS
LTE Band2	10	18900	1	#Mid	QPSK	23.18	24.56	PASS
LTE Band2	10	18900	1	#Max	QPSK	23.03	24.41	PASS
LTE Band2	10	18900	25	#0	QPSK	22.01	23.39	PASS
LTE Band2	10	18900	25	#Mid	QPSK	22.01	23.39	PASS
LTE Band2	10	18900	25	#Max	QPSK	21.98	23.36	PASS
LTE Band2	10	18900	50	#0	QPSK	22.04	23.42	PASS
LTE Band2	10	18900	1	#0	QAM16	22.63	24.01	PASS
LTE Band2	10	18900	1	#Mid	QAM16	22.72	24.10	PASS
LTE Band2	10	18900	1	#Max	QAM16	22.60	23.98	PASS
LTE Band2	10	18900	25	#0	QAM16	21.11	22.49	PASS
LTE Band2	10	18900	25	#Mid	QAM16	21.13	22.51	PASS
LTE Band2	10	18900	25	#Max	QAM16	21.24	22.62	PASS
LTE Band2	10	18900	50	#0	QAM16	21.13	22.51	PASS
LTE Band2	10	19150	1	#0	QPSK	22.94	24.32	PASS
LTE Band2	10	19150	1	#Mid	QPSK	23.28	24.66	PASS
LTE Band2	10	19150	1	#Max	QPSK	22.79	24.17	PASS
LTE Band2	10	19150	25	#0	QPSK	22.12	23.50	PASS
LTE Band2	10	19150	25	#Mid	QPSK	22.14	23.52	PASS
LTE Band2	10	19150	25	#Max	QPSK	22.05	23.43	PASS
LTE Band2	10	19150	50	#0	QPSK	22.09	23.47	PASS
LTE Band2	10	19150	1	#0	QAM16	21.88	23.26	PASS
LTE Band2	10	19150	1	#Mid	QAM16	22.52	23.90	PASS
LTE Band2	10	19150	1	#Max	QAM16	21.86	23.24	PASS
LTE Band2	10	19150	25	#0	QAM16	21.13	22.51	PASS
LTE Band2	10	19150	25	#Mid	QAM16	21.14	22.52	PASS



LTE Band2	10	19150	25	#Max	QAM16	21.13	22.51	PASS
LTE Band2	10	19150	50	#0	QAM16	21.03	22.41	PASS
LTE Band2	15	18675	1	#0	QPSK	23.22	24.60	PASS
LTE Band2	15	18675	1	#Mid	QPSK	23.38	24.76	PASS
LTE Band2	15	18675	1	#Max	QPSK	22.85	24.23	PASS
LTE Band2	15	18675	36	#0	QPSK	22.15	23.53	PASS
LTE Band2	15	18675	36	#Mid	QPSK	22.14	23.52	PASS
LTE Band2	15	18675	36	#Max	QPSK	22.11	23.49	PASS
LTE Band2	15	18675	75	#0	QPSK	22.11	23.49	PASS
LTE Band2	15	18675	1	#0	QAM16	22.18	23.56	PASS
LTE Band2	15	18675	1	#Mid	QAM16	22.28	23.66	PASS
LTE Band2	15	18675	1	#Max	QAM16	22.11	23.49	PASS
LTE Band2	15	18675	36	#0	QAM16	21.07	22.45	PASS
LTE Band2	15	18675	36	#Mid	QAM16	21.04	22.42	PASS
LTE Band2	15	18675	36	#Max	QAM16	21.12	22.50	PASS
LTE Band2	15	18675	75	#0	QAM16	21.12	22.50	PASS
LTE Band2	15	18900	1	#0	QPSK	22.95	24.33	PASS
LTE Band2	15	18900	1	#Mid	QPSK	23.04	24.42	PASS
LTE Band2	15	18900	1	#Max	QPSK	23.04	24.42	PASS
LTE Band2	15	18900	36	#0	QPSK	22.00	23.38	PASS
LTE Band2	15	18900	36	#Mid	QPSK	21.99	23.37	PASS
LTE Band2	15	18900	36	#Max	QPSK	22.04	23.42	PASS
LTE Band2	15	18900	75	#0	QPSK	22.01	23.39	PASS
LTE Band2	15	18900	1	#0	QAM16	22.49	23.87	PASS
LTE Band2	15	18900	1	#Mid	QAM16	22.41	23.79	PASS
LTE Band2	15	18900	1	#Max	QAM16	22.42	23.80	PASS
LTE Band2	15	18900	36	#0	QAM16	21.10	22.48	PASS
LTE Band2	15	18900	36	#Mid	QAM16	21.10	22.48	PASS
LTE Band2	15	18900	36	#Max	QAM16	21.13	22.51	PASS
LTE Band2	15	18900	75	#0	QAM16	20.80	22.18	PASS
LTE Band2	15	19125	1	#0	QPSK	22.93	24.31	PASS
LTE Band2	15	19125	1	#Mid	QPSK	22.78	24.16	PASS
LTE Band2	15	19125	1	#Max	QPSK	22.58	23.96	PASS
LTE Band2	15	19125	36	#0	QPSK	22.03	23.41	PASS
LTE Band2	15	19125	36	#Mid	QPSK	22.07	23.45	PASS
LTE Band2	15	19125	36	#Max	QPSK	21.97	23.35	PASS
LTE Band2	15	19125	75	#0	QPSK	21.93	23.31	PASS
LTE Band2	15	19125	1	#0	QAM16	21.83	23.21	PASS
LTE Band2	15	19125	1	#Mid	QAM16	21.60	22.98	PASS
LTE Band2	15	19125	1	#Max	QAM16	21.01	22.39	PASS
LTE Band2	15	19125	36	#0	QAM16	21.04	22.42	PASS
LTE Band2	15	19125	36	#Mid	QAM16	21.05	22.43	PASS



LTE Band2	15	19125	36	#Max	QAM16	20.87	22.25	PASS
LTE Band2	15	19125	75	#0	QAM16	20.84	22.22	PASS
LTE Band2	20	18700	1	#0	QPSK	23.24	24.62	PASS
LTE Band2	20	18700	1	#Mid	QPSK	23.35	24.73	PASS
LTE Band2	20	18700	1	#Max	QPSK	22.82	24.20	PASS
LTE Band2	20	18700	50	#0	QPSK	22.01	23.39	PASS
LTE Band2	20	18700	50	#Mid	QPSK	21.99	23.37	PASS
LTE Band2	20	18700	50	#Max	QPSK	21.93	23.31	PASS
LTE Band2	20	18700	100	#0	QPSK	21.96	23.34	PASS
LTE Band2	20	18700	1	#0	QAM16	22.19	23.57	PASS
LTE Band2	20	18700	1	#Mid	QAM16	22.46	23.84	PASS
LTE Band2	20	18700	1	#Max	QAM16	22.00	23.38	PASS
LTE Band2	20	18700	50	#0	QAM16	21.12	22.50	PASS
LTE Band2	20	18700	50	#Mid	QAM16	21.09	22.47	PASS
LTE Band2	20	18700	50	#Max	QAM16	20.96	22.34	PASS
LTE Band2	20	18700	100	#0	QAM16	20.94	22.32	PASS
LTE Band2	20	18900	1	#0	QPSK	22.77	24.15	PASS
LTE Band2	20	18900	1	#Mid	QPSK	23.16	24.54	PASS
LTE Band2	20	18900	1	#Max	QPSK	23.00	24.38	PASS
LTE Band2	20	18900	50	#0	QPSK	21.90	23.28	PASS
LTE Band2	20	18900	50	#Mid	QPSK	21.90	23.28	PASS
LTE Band2	20	18900	50	#Max	QPSK	21.93	23.31	PASS
LTE Band2	20	18900	100	#0	QPSK	21.92	23.30	PASS
LTE Band2	20	18900	1	#0	QAM16	21.68	23.06	PASS
LTE Band2	20	18900	1	#Mid	QAM16	21.47	22.85	PASS
LTE Band2	20	18900	1	#Max	QAM16	21.44	22.82	PASS
LTE Band2	20	18900	50	#0	QAM16	20.90	22.28	PASS
LTE Band2	20	18900	50	#Mid	QAM16	20.90	22.28	PASS
LTE Band2	20	18900	50	#Max	QAM16	20.90	22.28	PASS
LTE Band2	20	18900	100	#0	QAM16	20.73	22.11	PASS
LTE Band2	20	19100	1	#0	QPSK	22.89	24.27	PASS
LTE Band2	20	19100	1	#Mid	QPSK	23.00	24.38	PASS
LTE Band2	20	19100	1	#Max	QPSK	22.59	23.97	PASS
LTE Band2	20	19100	50	#0	QPSK	21.92	23.30	PASS
LTE Band2	20	19100	50	#Mid	QPSK	21.93	23.31	PASS
LTE Band2	20	19100	50	#Max	QPSK	21.86	23.24	PASS
LTE Band2	20	19100	100	#0	QPSK	21.84	23.22	PASS
LTE Band2	20	19100	1	#0	QAM16	21.73	23.11	PASS
LTE Band2	20	19100	1	#Mid	QAM16	21.97	23.35	PASS
LTE Band2	20	19100	1	#Max	QAM16	21.62	23.00	PASS
LTE Band2	20	19100	50	#0	QAM16	20.93	22.31	PASS
LTE Band2	20	19100	50	#Mid	QAM16	20.88	22.26	PASS



LTE Band2	20	19100	50	#Max	QAM16	20.91	22.29	PASS
LTE Band2	20	19100	100	#0	QAM16	20.84	22.22	PASS

5.2.Occupied Bandwidth

Ambient condition

Temperature	Relative humidity	Pressure
23°C ~25°C	45%~50%	101.5kPa

Method of Measurement

The EUT was connected to Spectrum Analyzer and Base Station Simulator via power Splitter. The occupied bandwidth is measured using spectrum analyzer.

RBW is set to 3kHz, VBW is set to 10kHz for GSM 1900,
 RBW is set to 51 kHz, VBW is set to 160kHz for WCDMA Band II,
 RBW is set to 30 kHz, VBW is set to 91kHz for LTE Band 2 (1.4MHz),
 RBW is set to 62 kHz, VBW is set to 180 kHz for LTE Band 2 (3MHz),
 RBW is set to 100 kHz, VBW is set to 300 kHz for LTE Band 2 (5MHz),
 RBW is set to 200 kHz, VBW is set to 620kHz for LTE Band 2 (10MHz),
 RBW is set to 300kHz,VBW is set to 910kHz for LTE Band 2 (15MHz).
 RBW is set to 430kHz,VBW is set to 1.2MHz for LTE Band 2 (20MHz).

99% power and -26dBc occupied bandwidths are recorded. Spectrum analyzer plots are included on the following pages.

Test Setup

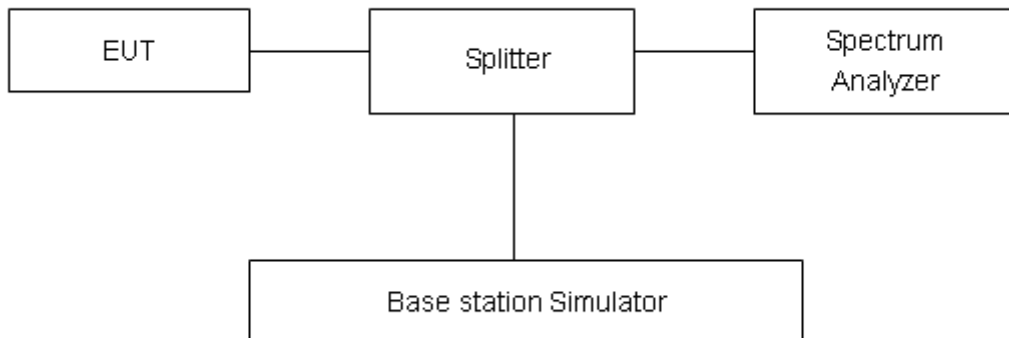

Limits

No specific occupied bandwidth requirements in part 2.1049.

Measurement Uncertainty

The assessed measurement uncertainty to ensure 95% confidence level for the normal distribution is with the coverage factor $k = 2$, $U = 624\text{Hz}$.



Test Result

Mode	Channel	Frequency (MHz)	99% Power Bandwidth (MHz)	-26dBc Bandwidth(MHz)
GSM 1900 (GSM)	512	1850.2	0.2437	0.2997
	661	1880.0	0.2422	0.2994
	810	1909.8	0.2445	0.2993
GPRS 1900 (GMSK)	512	1850.2	0.2442	0.3048
	661	1880.0	0.2453	0.3136
	810	1909.8	0.2455	0.3099
EGPRS 1900 (8-PSK)	512	1850.2	0.2471	0.3132
	661	1880.0	0.2454	0.308
	810	1909.8	0.2452	0.313
WCDMA Band II (RMC)	9262	1852.4	4.1129	4.684
	9400	1880	4.1211	4.665
	9538	1907.6	4.1184	4.696

LTE Band 2					
Modulation	Bandwidth (MHz)	Channel	Frequency (MHz)	99% Power Bandwidth(MHz)	-26dBc Bandwidth(MHz)
QPSK	1.4	18607	1850.7	1.0966	1.28
		18900	1880.0	1.0916	1.29
		19193	1909.3	1.0952	1.269
	3	18615	1851.5	2.7051	2.996
		18900	1880	2.7062	2.974
		19185	1908.5	2.7103	2.99
	5	18625	1852.5	4.5114	4.967
		18900	1880	4.5136	4.96
		19175	1907.5	4.5119	4.946
	10	18650	1855	8.976	9.805
		18900	1880	8.9633	9.733
		19150	1905	8.951	9.743
15	18675	1857.5	13.412	14.59	
	18900	1880	13.41	14.56	



		19125	1902.5	13.388	14.6
	20	18700	1860	17.944	19.35
		18900	1880	17.898	19.19
		19100	1900	17.919	19.33
16QAM	1.4	18607	1850.7	1.1017	1.267
		18900	1880.0	1.0983	1.29
		19193	1909.3	1.0984	1.283
	3	18615	1851.5	2.702	2.96
		18900	1880	2.7048	2.963
		19185	1908.5	2.697	2.988
	5	18625	1852.5	4.5325	4.968
		18900	1880	4.5377	5.031
		19175	1907.5	4.5246	4.999
	10	18650	1855	8.967	9.839
		18900	1880	8.9735	9.802
		19150	1905	8.9495	9.810
	15	18675	1857.5	13.474	14.63
		18900	1880	17.432	14.53
		19125	1902.5	13.398	14.61
	20	18700	1860	17.855	19.3
		18900	1880	17.878	19.36
		19100	1900	17.850	19.32

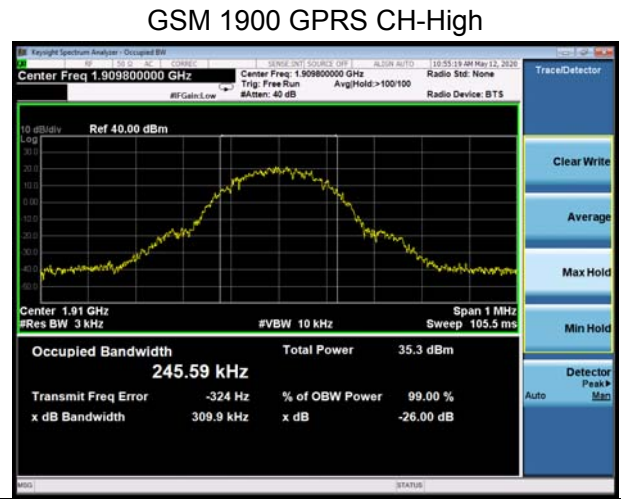
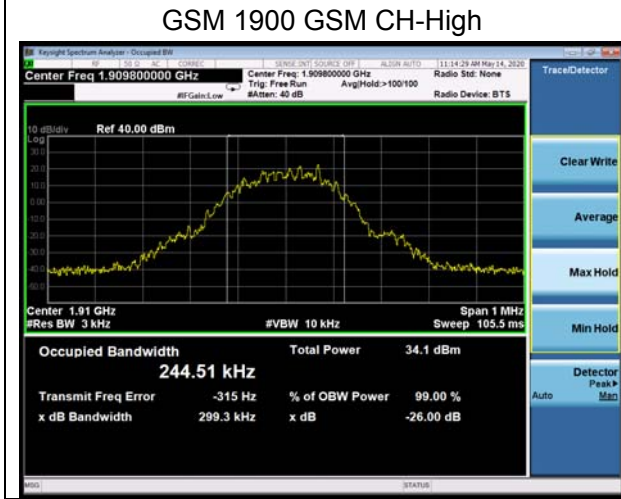
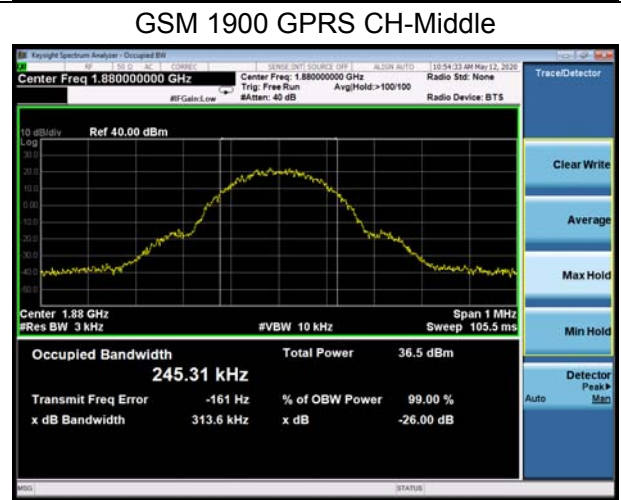
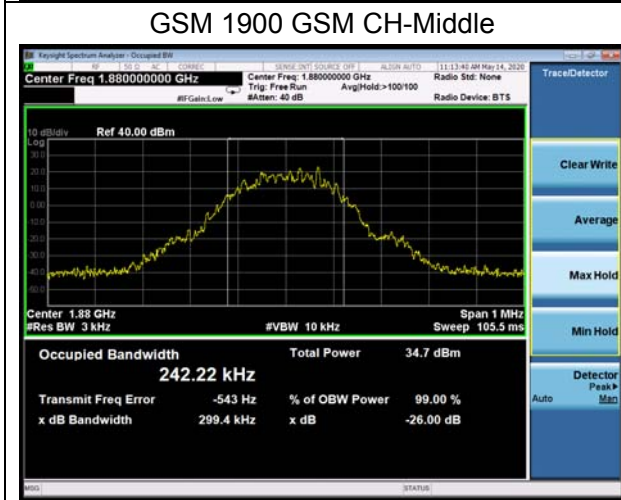
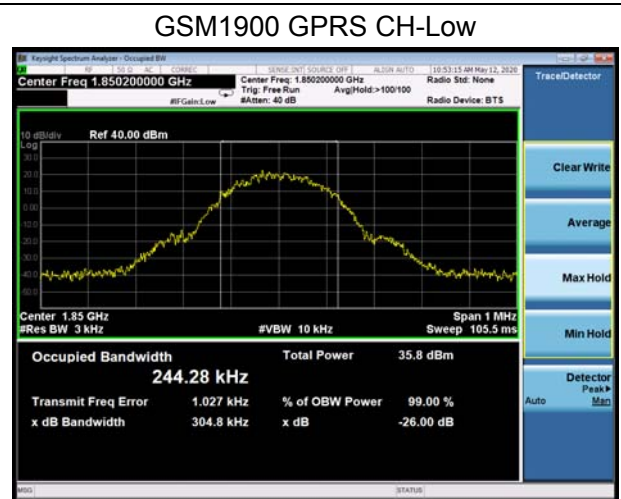
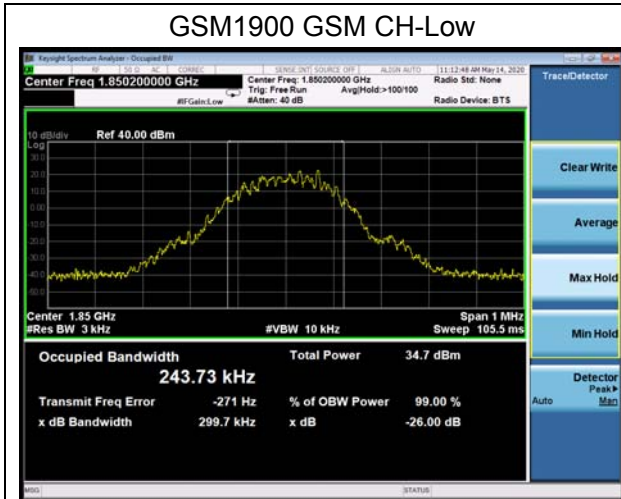

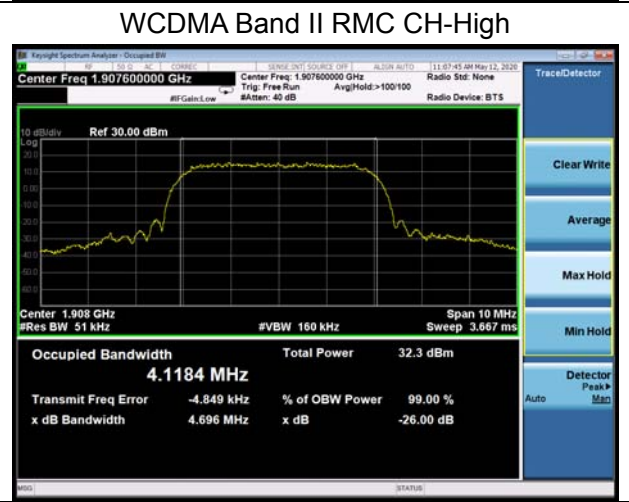
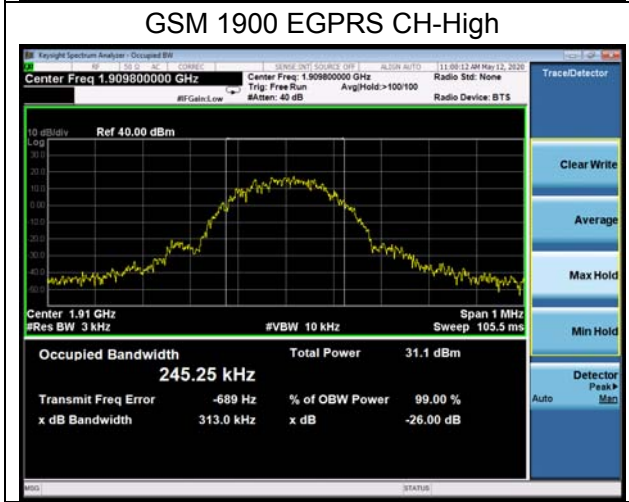
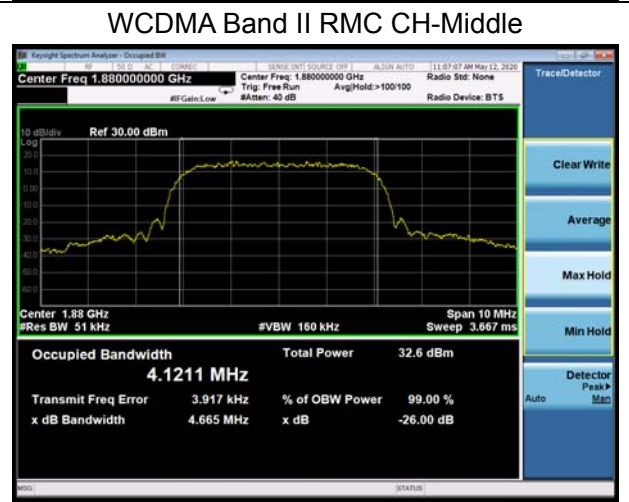
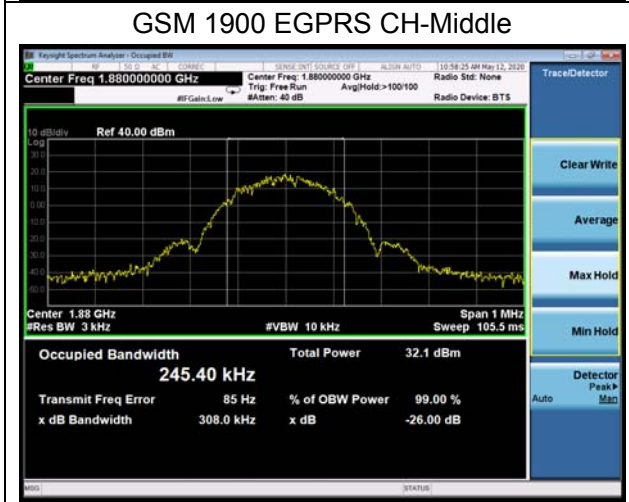
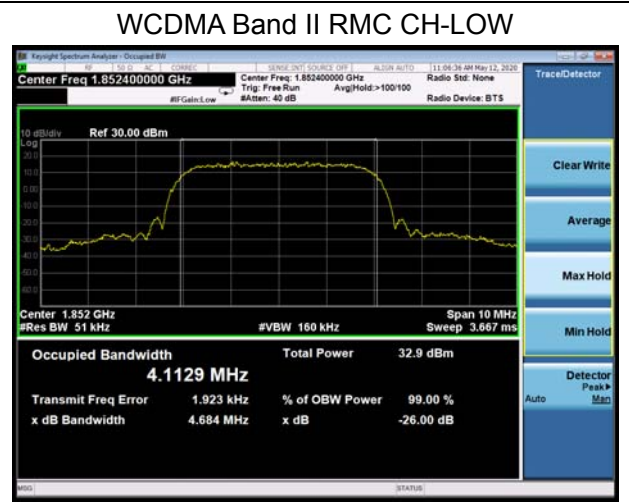
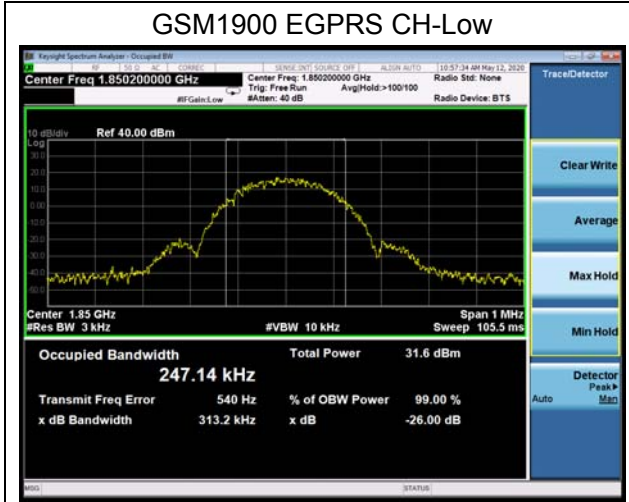



LTE Band 2 1.4MHz QPSK CH-Low



LTE Band 2 3MHz QPSK CH-Low



LTE Band 2 1.4MHz QPSK CH-Middle

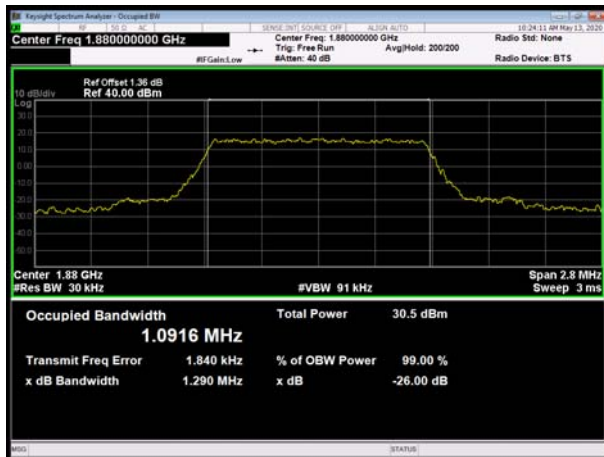

LTE Band 2 3MHz QPSK CH-Middle



LTE Band 2 1.4MHz QPSK CH-High

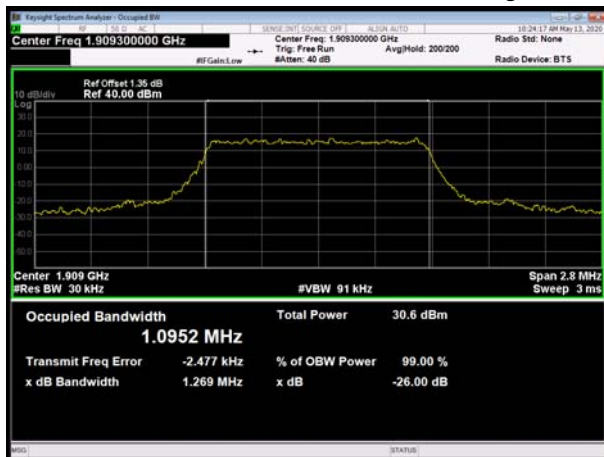

LTE Band 2 3MHz QPSK CH-High

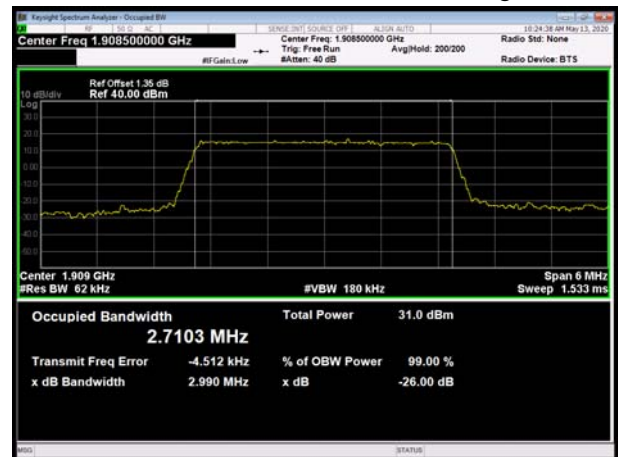



LTE Band 2 5MHz QPSK CH-Low

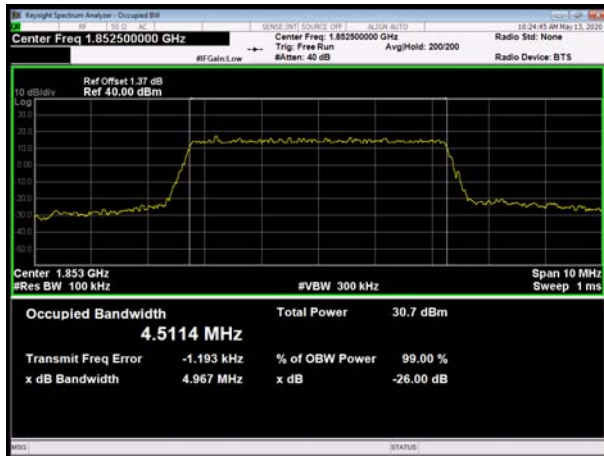

LTE Band 2 10MHz QPSK CH-Low

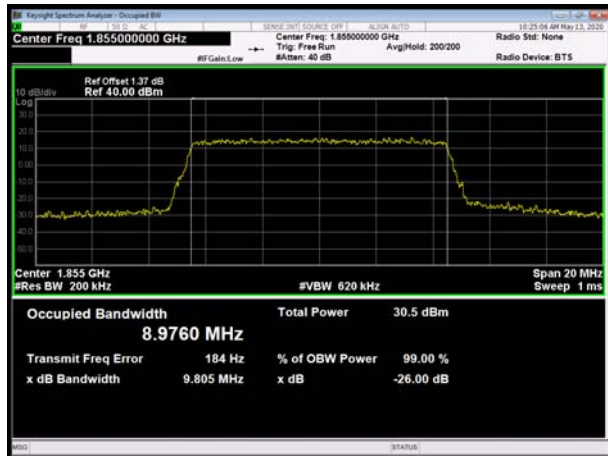

LTE Band 2 5MHz QPSK CH-Middle

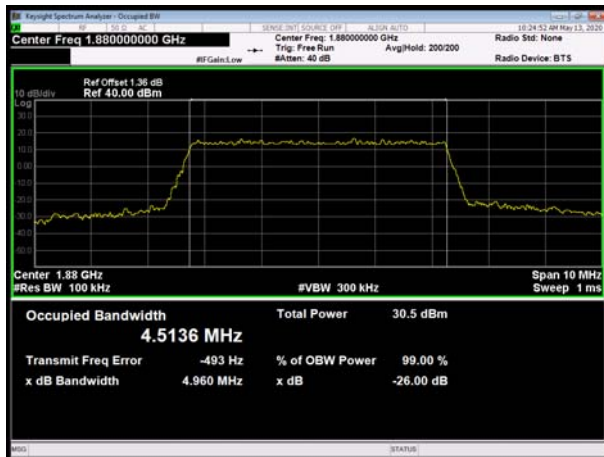

LTE Band 2 10MHz QPSK CH-Middle

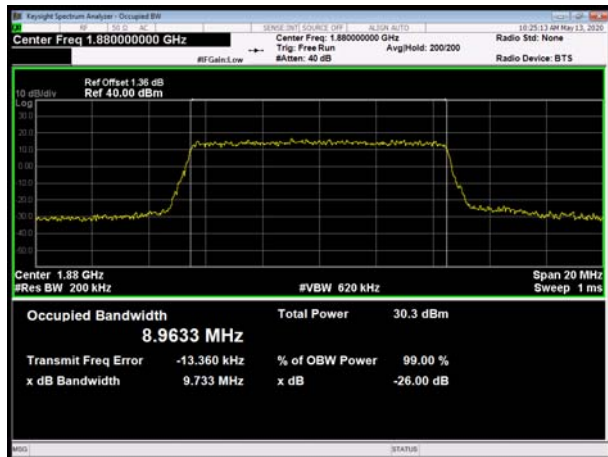

LTE Band 2 5MHz QPSK CH-High



LTE Band 2 10MHz QPSK CH-High



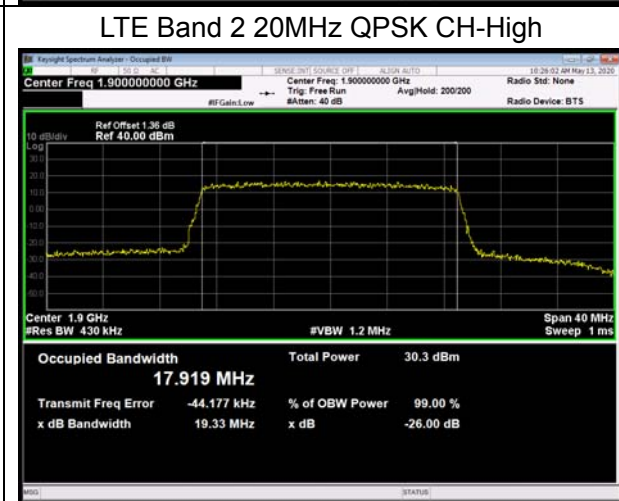
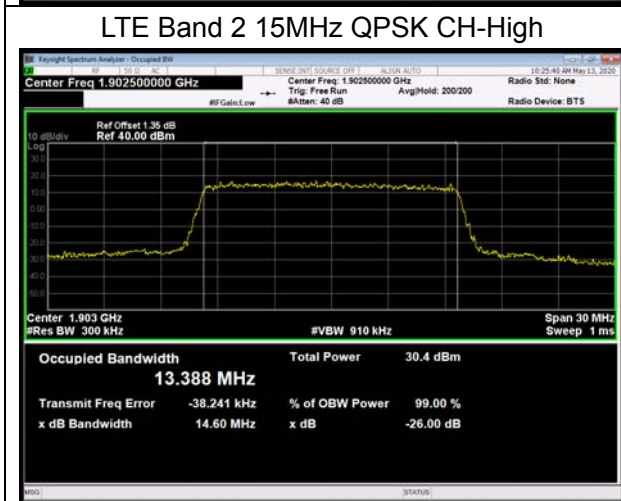
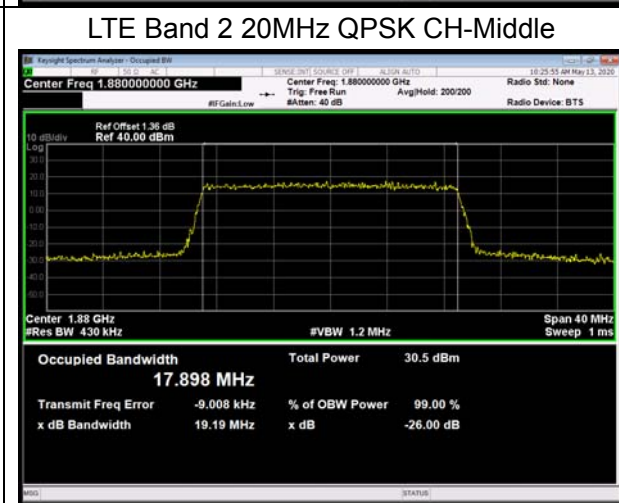
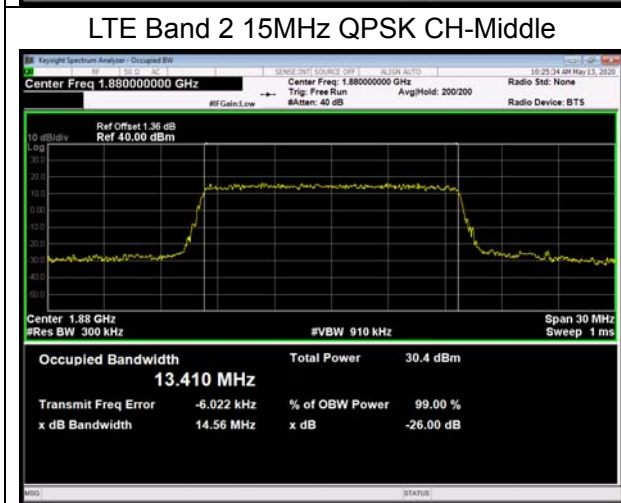
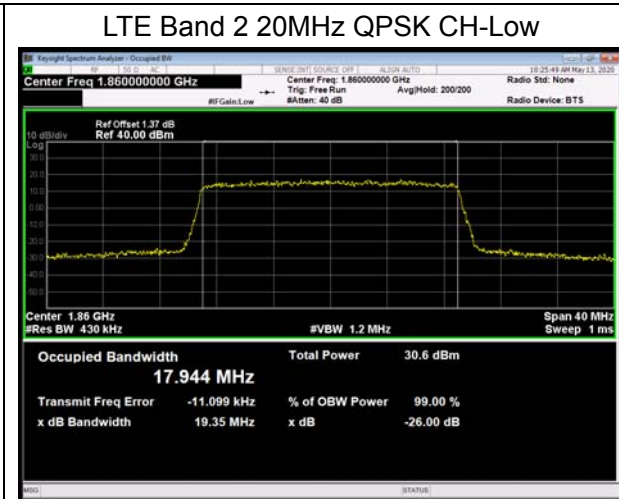
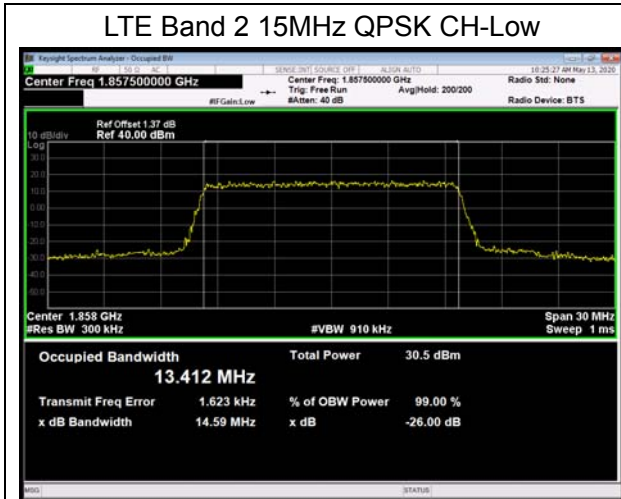



LTE Band 2 1.4MHz 16QAM CH-Low

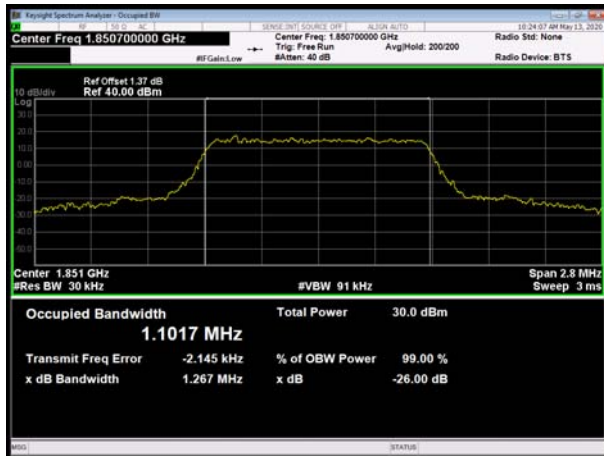

LTE Band 2 3MHz 16QAM CH-Low

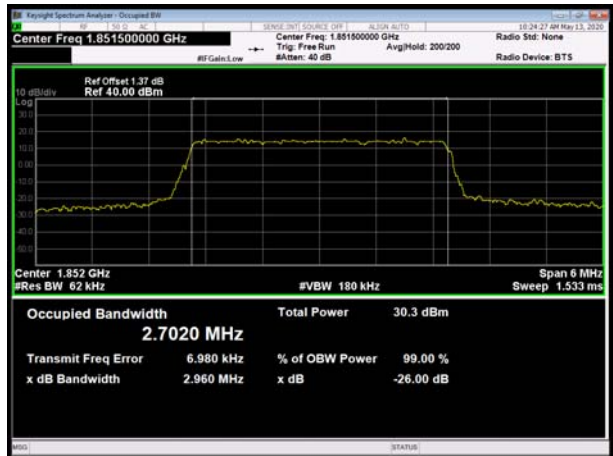

LTE Band 2 1.4MHz 16QAM CH-Middle

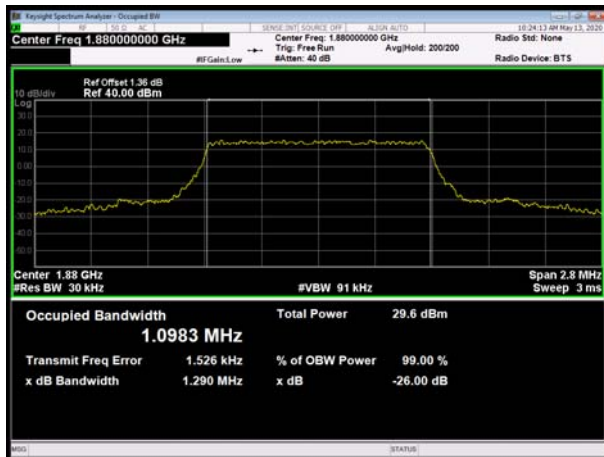

LTE Band 2 3MHz 16QAM CH-Middle

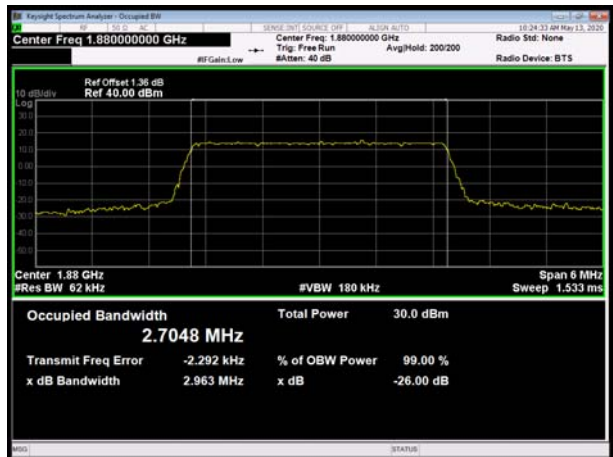

LTE Band 2 1.4MHz 16QAM CH-High

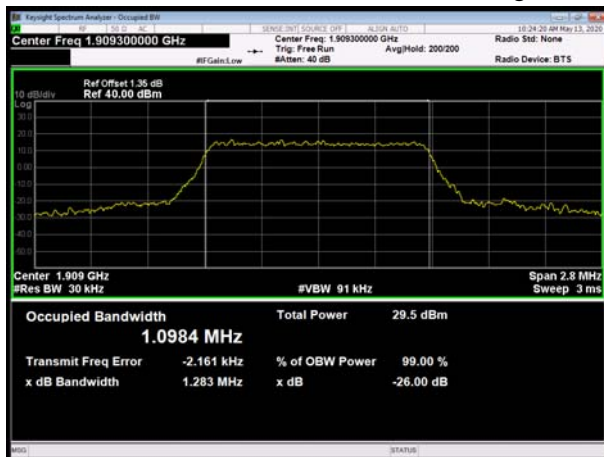

LTE Band 2 3MHz 16QAM CH-High

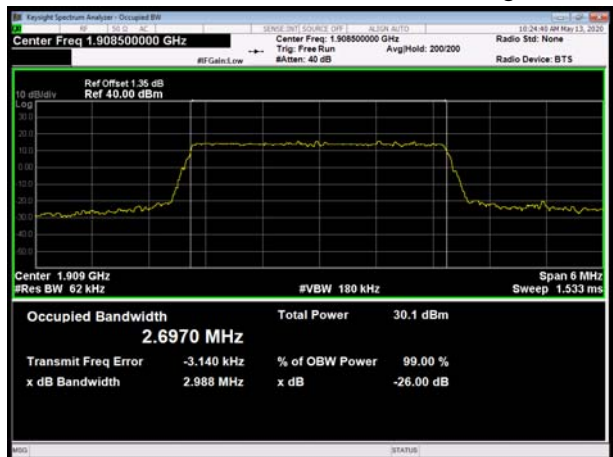

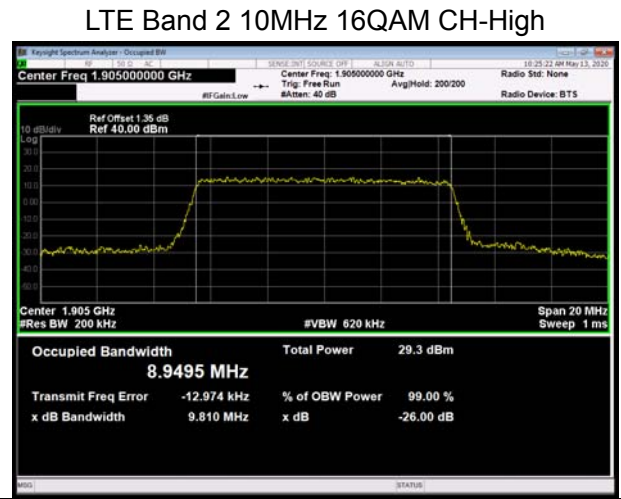
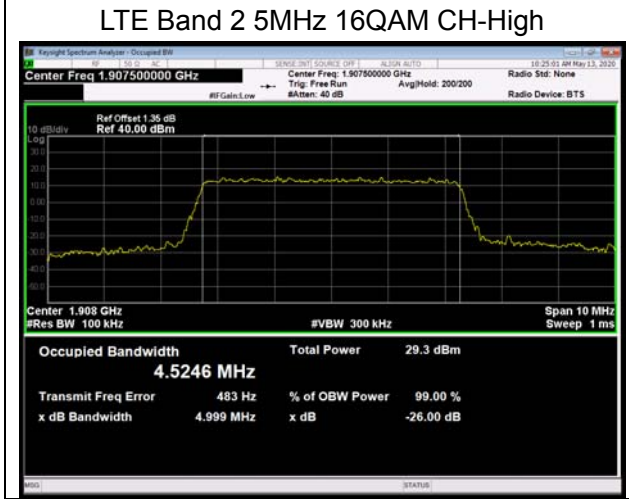
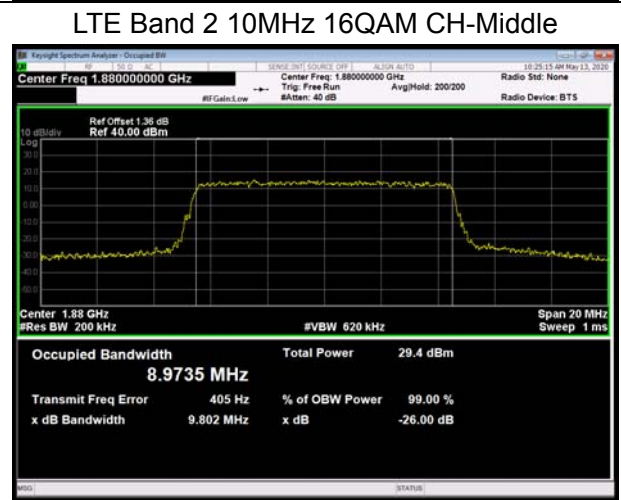
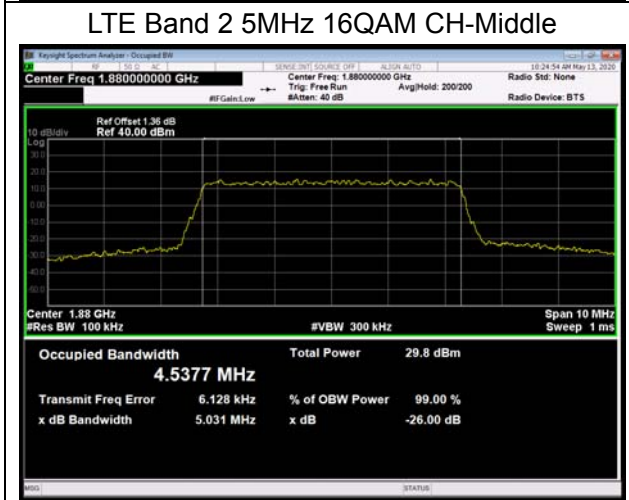
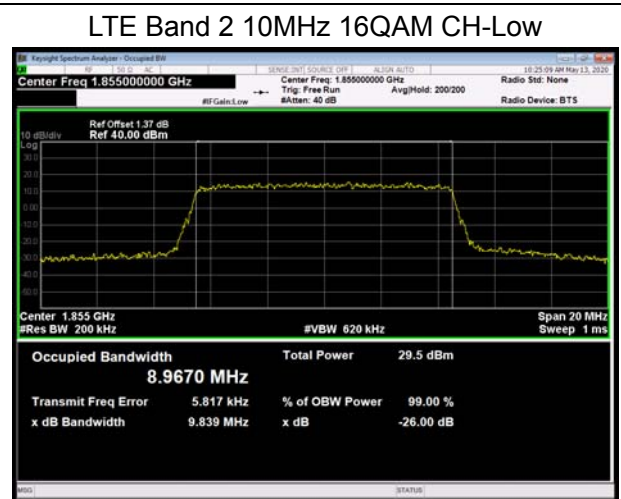
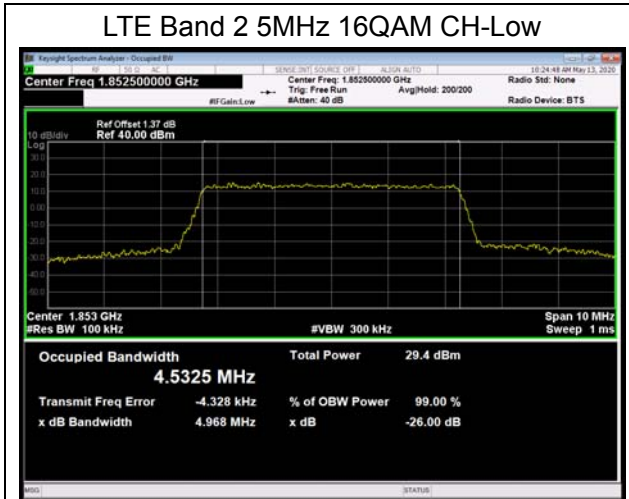



LTE Band 2 15MHz 16QAM CH-Low

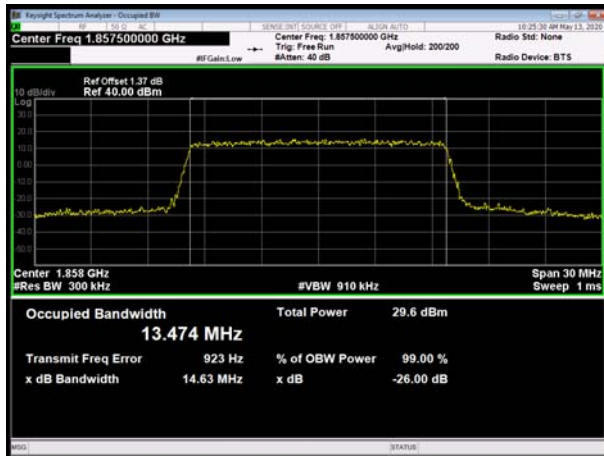

LTE Band 2 20MHz 16QAM CH-Low

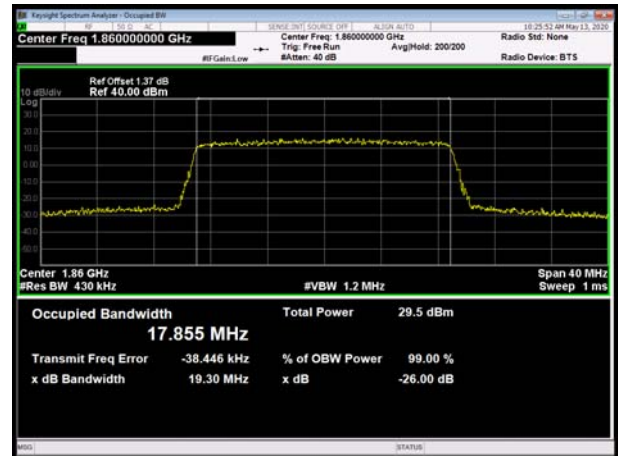

LTE Band 2 15MHz 16QAM CH-Middle

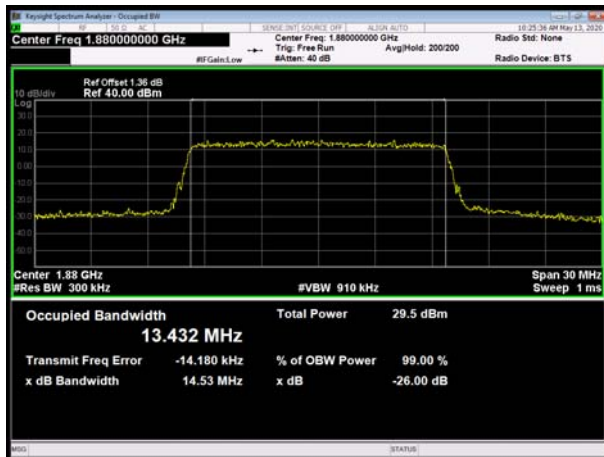

LTE Band 2 20MHz 16QAM CH-Middle

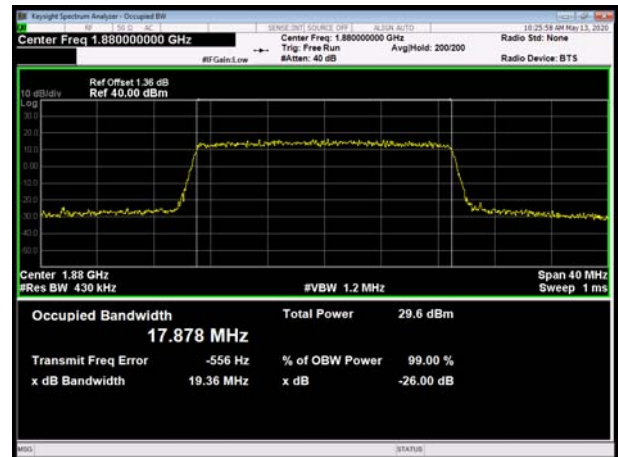

LTE Band 2 15MHz 16QAM CH-High

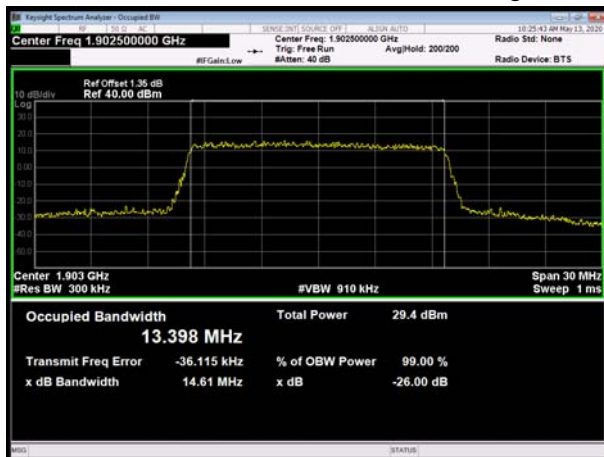

LTE Band 2 20MHz 16QAM CH-High

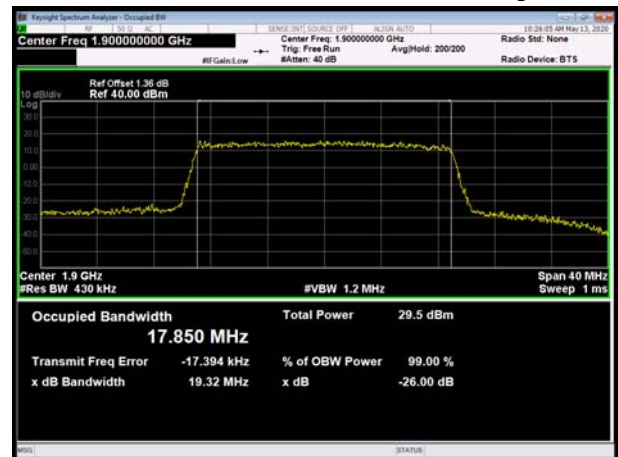

5.3. Band Edge Compliance

Ambient condition

Temperature	Relative humidity	Pressure
23°C ~25°C	45%~50%	101.5kPa

Method of Measurement

The EUT was connected to Spectrum Analyzer and Base Station Simulator via power Splitter. The band edge of the lowest and highest channels were measured. The Average detector is used and RBW is set to 3kHz, VBW is set to 10kHz for GSM 1900, RBW is set to 51kHz, VBW is set to 160kHz for WCDMA Band II, RBW is set to 15kHz, VBW is set to 43kHz for LTE Band 2 (1.4MHz), RBW is set to 30kHz, VBW is set to 91kHz for LTE Band 2 (3MHz), RBW is set to 51kHz, VBW is set to 150kHz for LTE Band 2 (5MHz), RBW is set to 100kHz, VBW is set to 300kHz for LTE Band 2 (10MHz), RBW is set to 150kHz, VBW is set to 470kHz for LTE Band 2 (15MHz), RBW is set to 200kHz, VBW is set to 620kHz for LTE Band 2 (20MHz). Spectrum analyzer plots are included on the following pages.

Test Setup

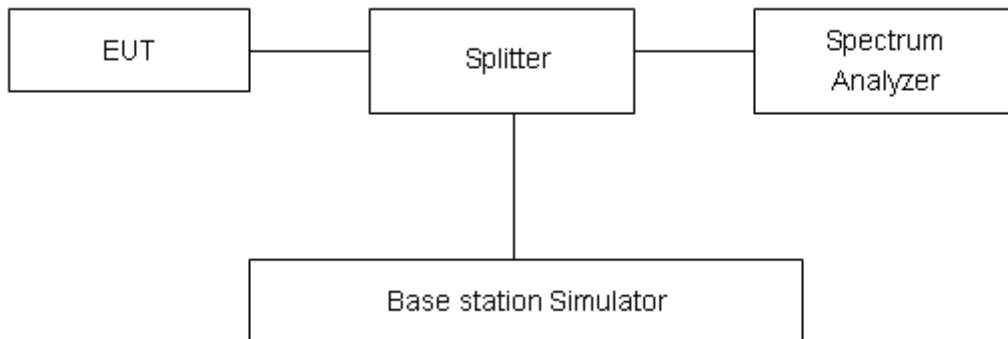

Limits

Rule Part 24.238(a) specifies that “on any frequency outside a licensee's frequency block, the power of any emission shall be attenuated below the transmitter power (P) by at least $43 + 10 \log_{10} (P)$ dB.”

Limit	-13 dBm
-------	---------

Measurement Uncertainty

The assessed measurement uncertainty to ensure 95% confidence level for the normal distribution is with the coverage factor $k = 1.96$, $U=0.684$ dB.



Test Result:

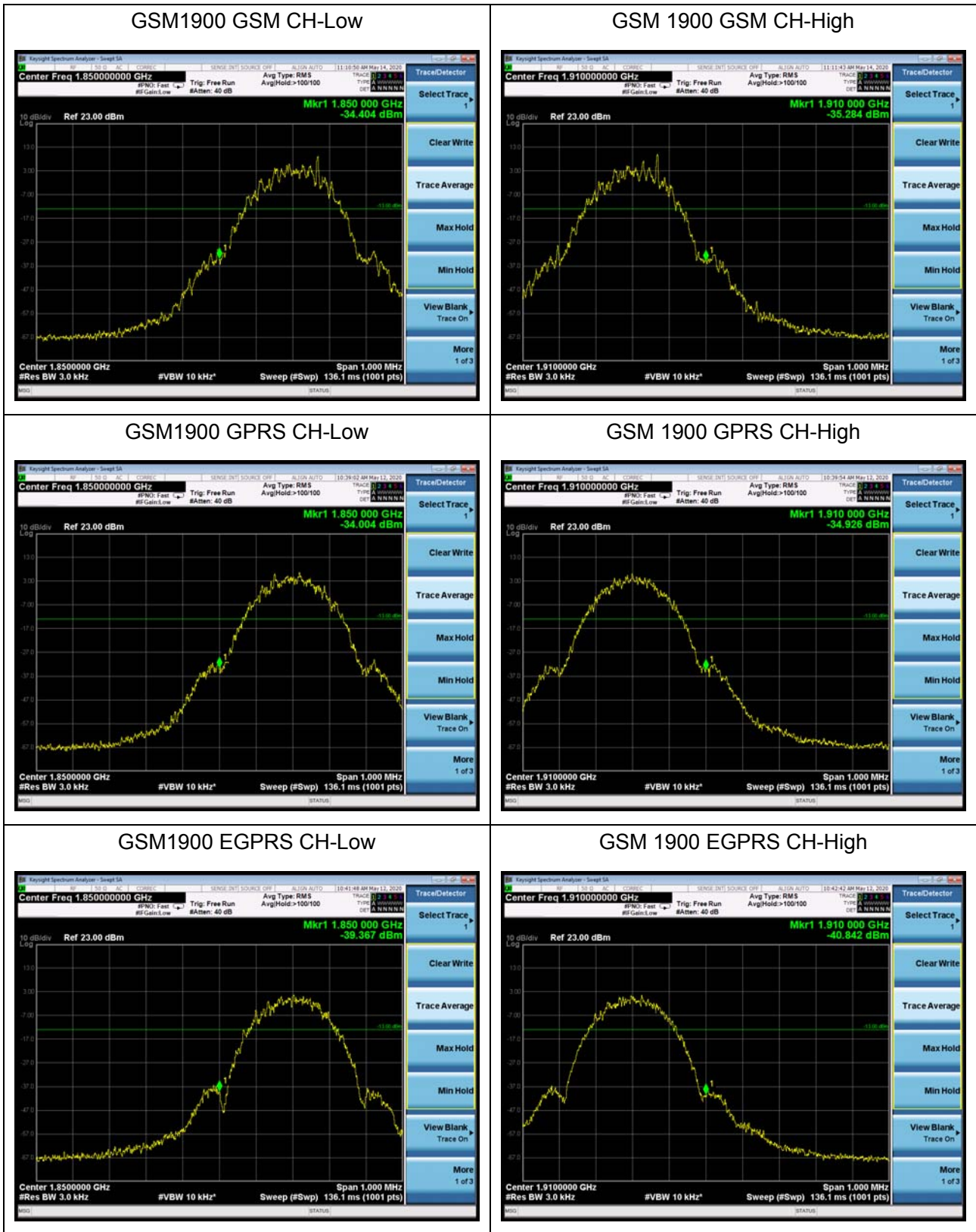



WCDMA Band II RMC CH-Low



WCDMA Band II RMC CH-High



LTE Band 2 1.4MHz QPSK 1RB CH-Low

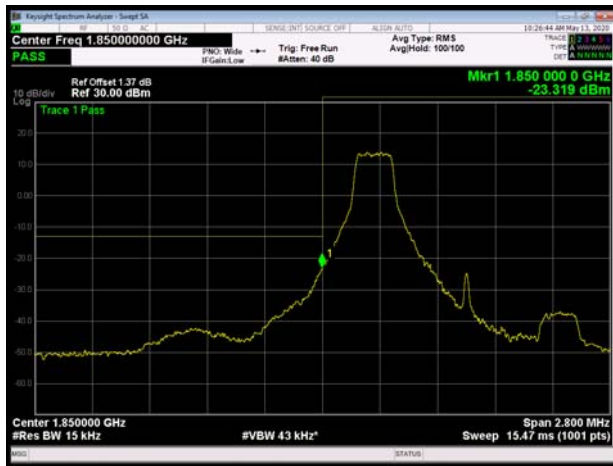

LTE Band 2 1.4MHz QPSK 1RB CH-High

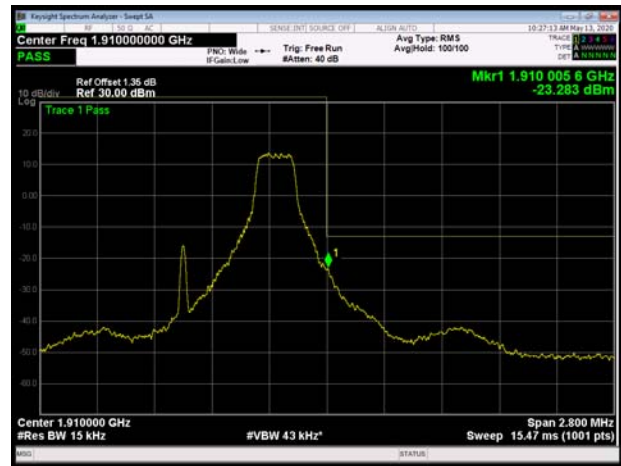

LTE Band 2 1.4MHz QPSK 100%RB CH-Low



LTE Band 2 1.4MHz QPSK 100%RB CH-High





LTE Band 2 3MHz QPSK 1RB CH-Low

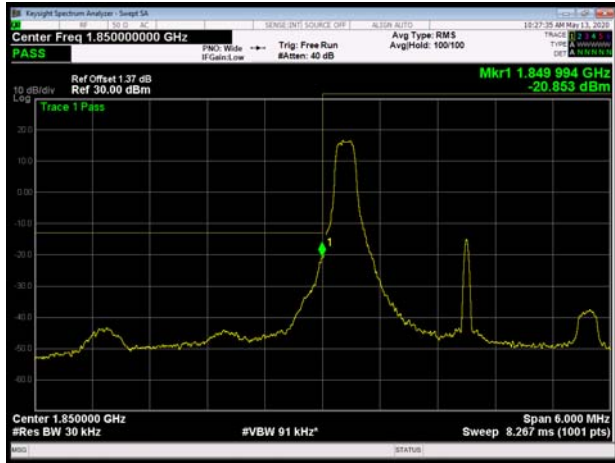

LTE Band 2 3MHz QPSK 1RB CH-High

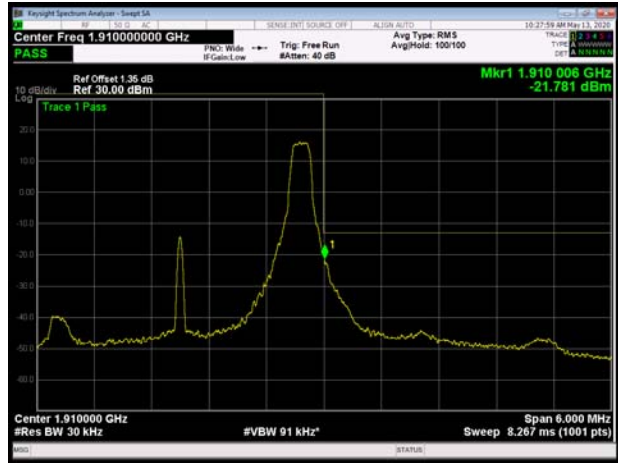

LTE Band 2 3MHz QPSK 100%RB CH-Low

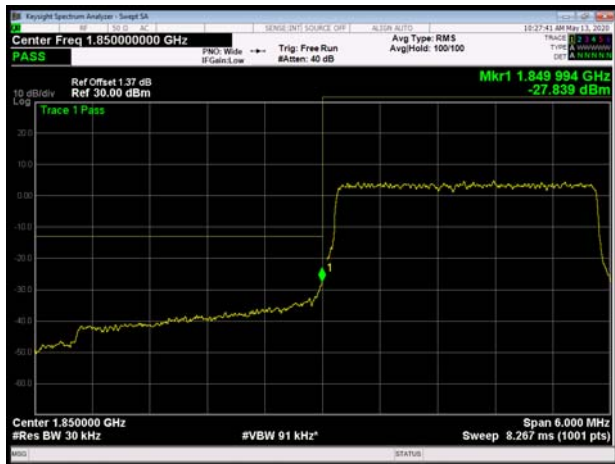

LTE Band 2 3MHz QPSK 100%RB CH-High

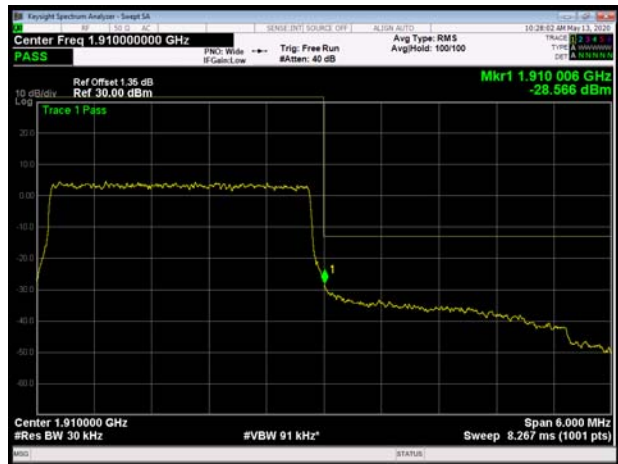

LTE Band 2 5MHz QPSK 1RB CH-Low

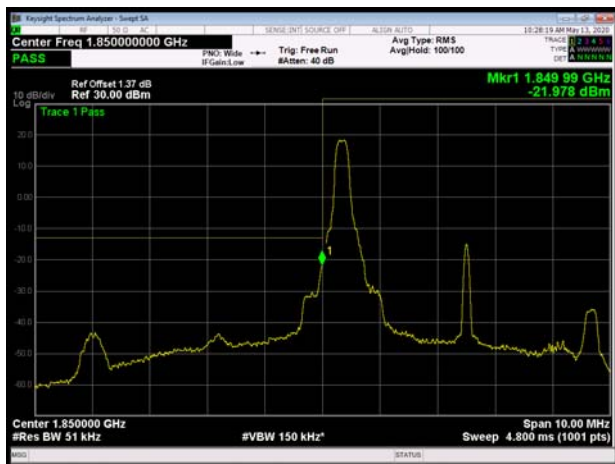

LTE Band 2 5MHz QPSK 1RB CH-High

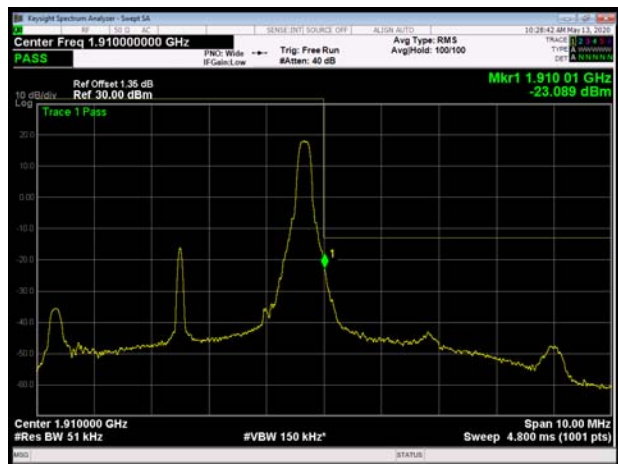



LTE Band 2 5MHz QPSK 100%RB CH-Low

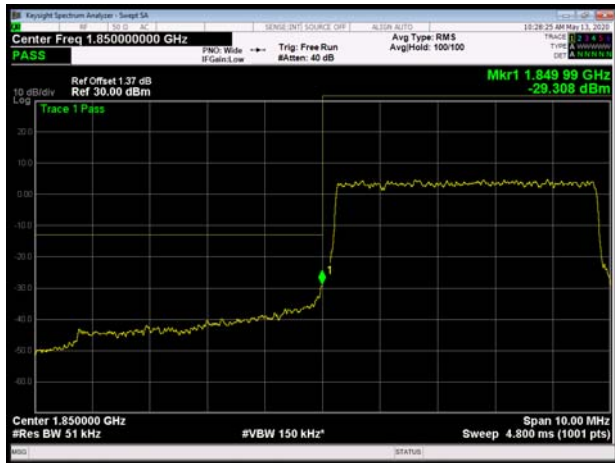

LTE Band 2 5MHz QPSK 100%RB CH-High



LTE Band 2 10MHz QPSK 1RB CH-Low

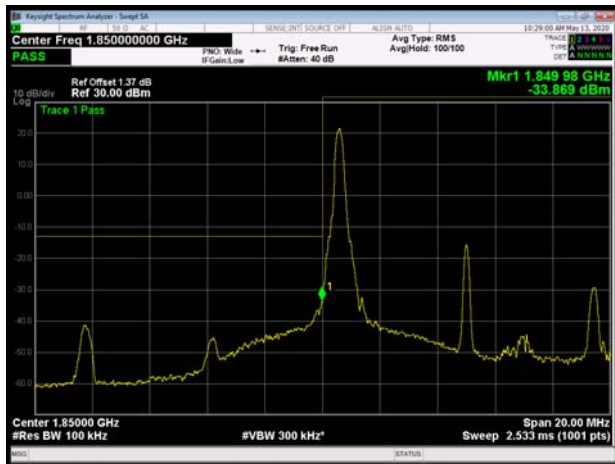

LTE Band 2 10MHz QPSK 1RB CH-High

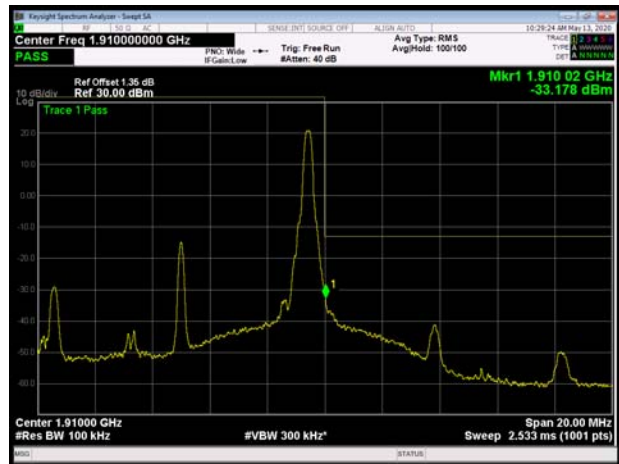

LTE Band 2 10MHz QPSK 100%RB CH-Low

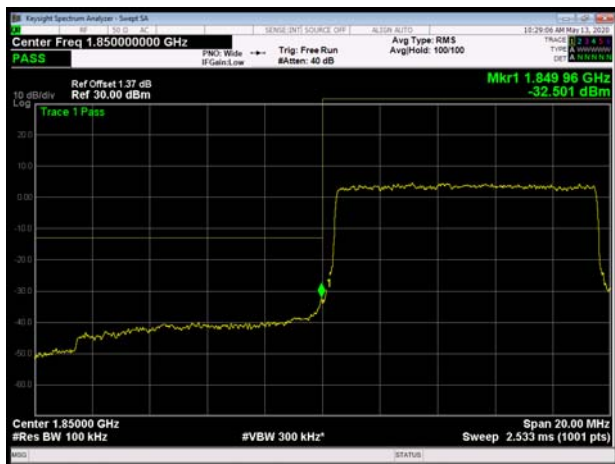

LTE Band 2 10MHz QPSK 100%RB CH-High

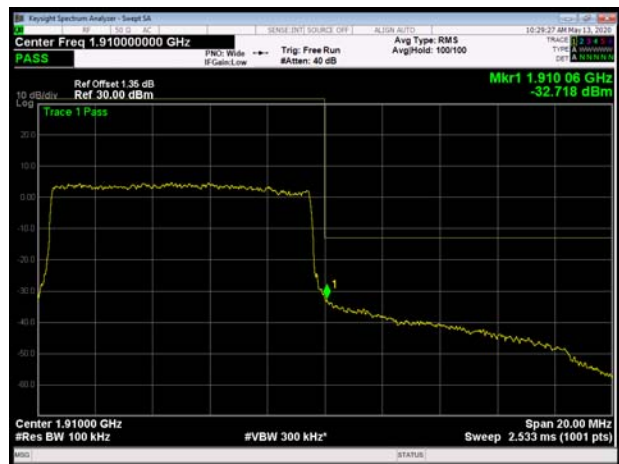



LTE Band 2 15MHz QPSK 1RB CH-Low

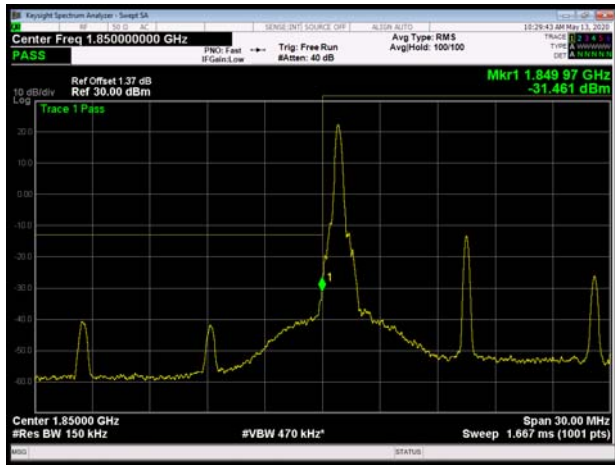

LTE Band 2 15MHz QPSK 1RB CH-High

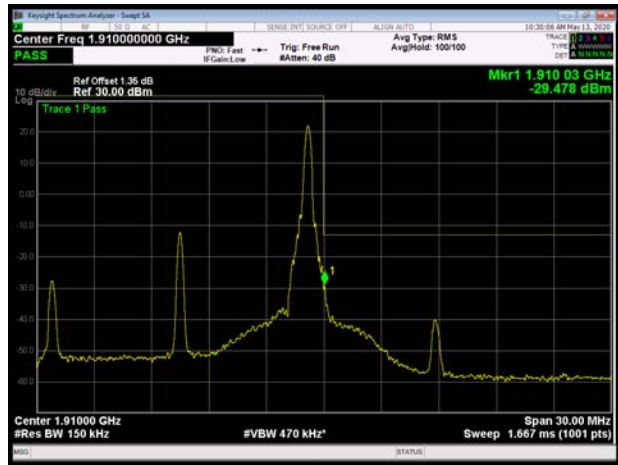

LTE Band 2 15MHz QPSK 100%RB CH-Low



LTE Band 2 15MHz QPSK 100%RB CH-High



LTE Band 2 20MHz QPSK 1RB CH-Low

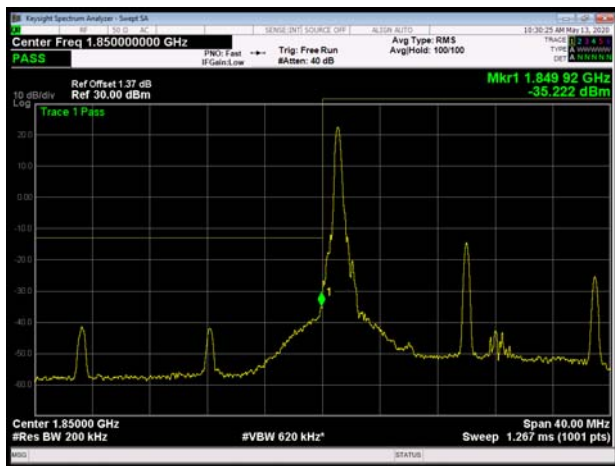

LTE Band 2 20MHz QPSK 1RB CH-High

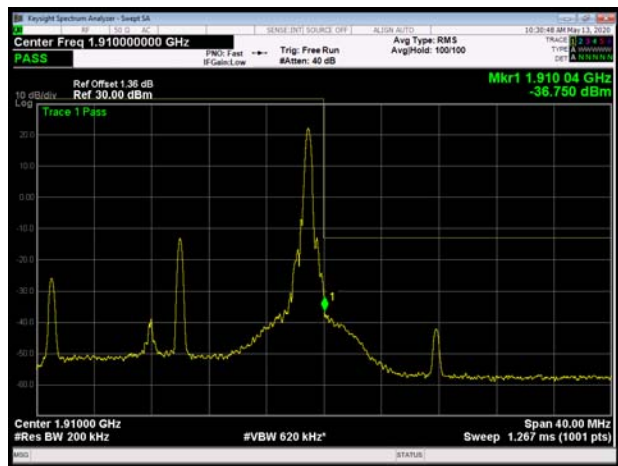



LTE Band 2 20MHz QPSK 100%RB CH-Low

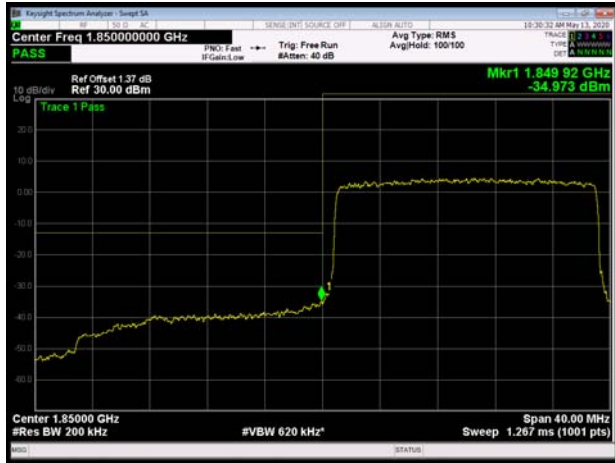

LTE Band 2 20MHz QPSK 100%RB CH-High

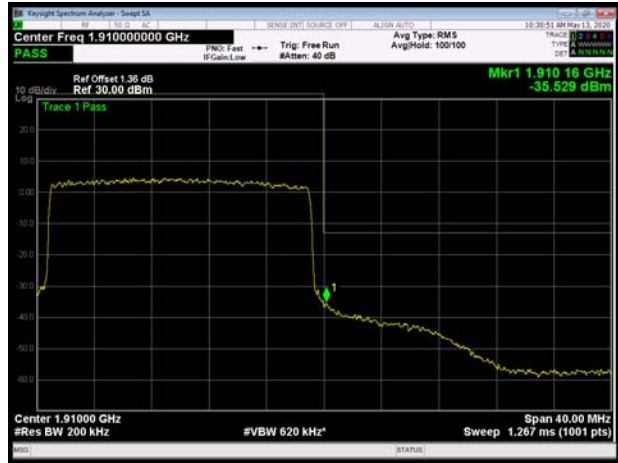

LTE Band 2 1.4MHz 16QAM 1RB CH-Low

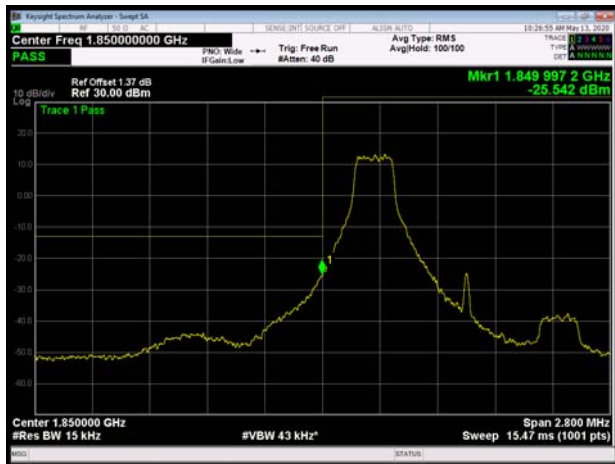

LTE Band 2 1.4MHz 16QAM 1RB CH-High

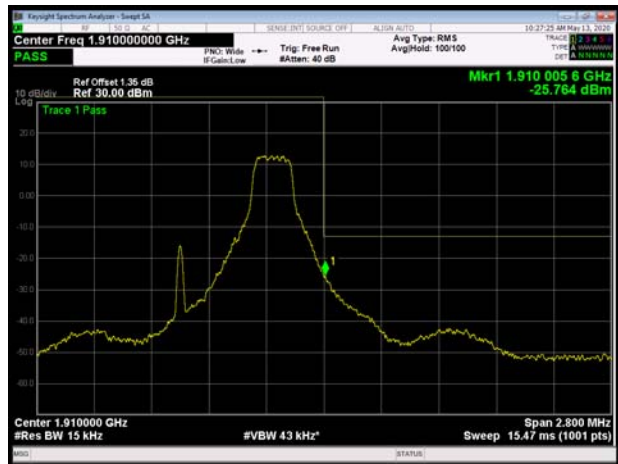

LTE Band 2 1.4MHz 16QAM 100%RB CH-Low



LTE Band 2 1.4MHz 16QAM 100%RB CH-High





LTE Band 2 3MHz 16QAM 1RB CH-Low

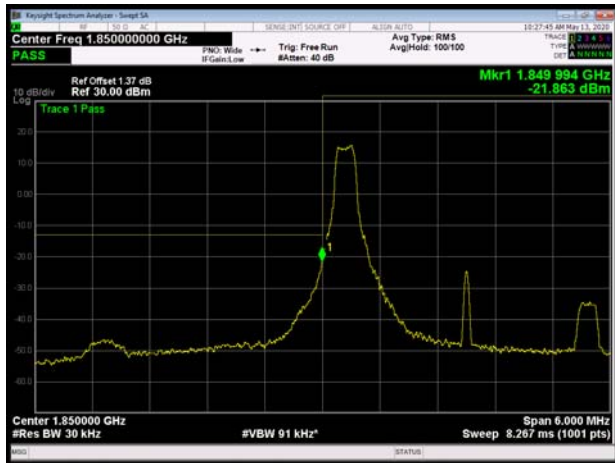

LTE Band 2 3MHz 16QAM 1RB CH-High

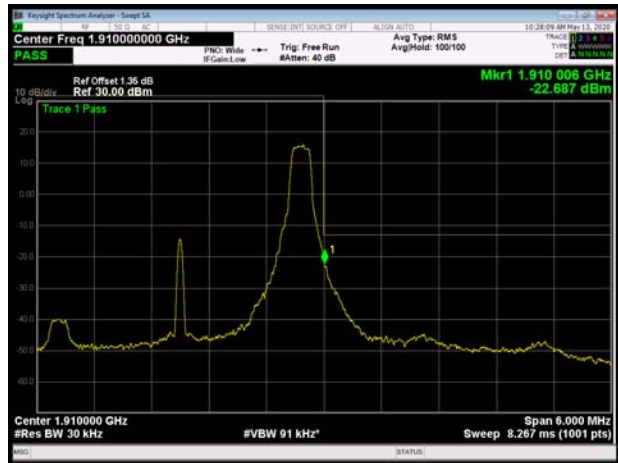

LTE Band 2 3MHz 16QAM 100%RB CH-Low

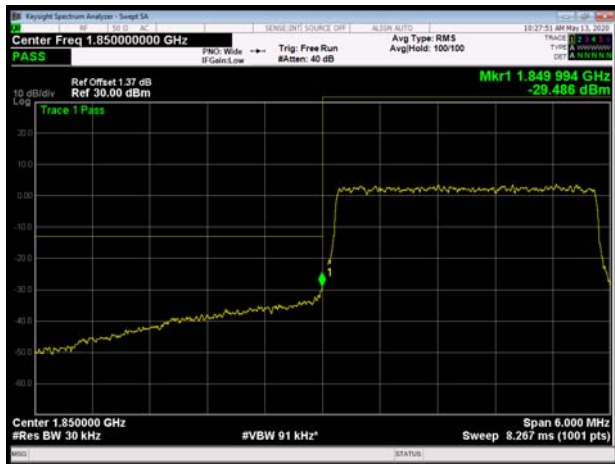

LTE Band 2 3MHz 16QAM 100%RB CH-High



LTE Band 2 5MHz 16QAM 1RB CH-Low

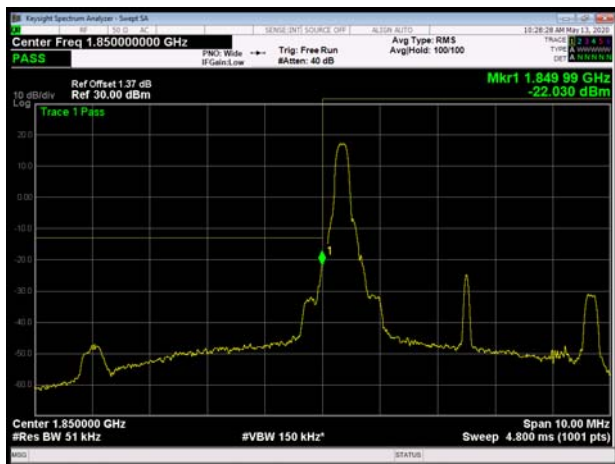

LTE Band 2 5MHz 16QAM 1RB CH-High

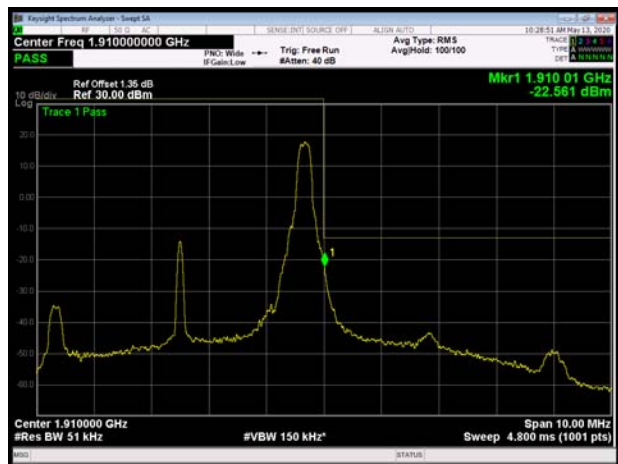



LTE Band 2 5MHz 16QAM 100%RB CH-Low

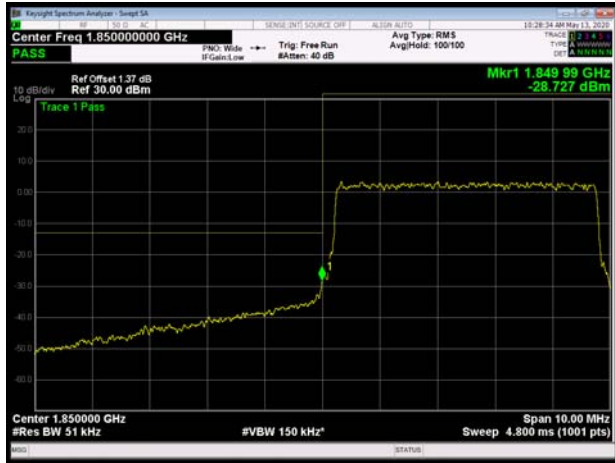

LTE Band 2 5MHz 16QAM 100%RB CH-High

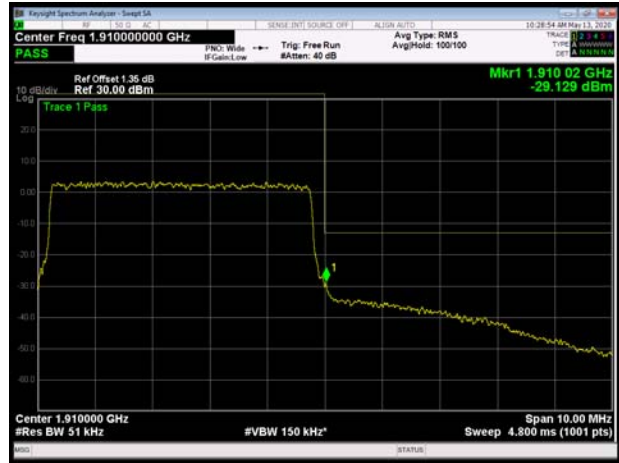

LTE Band 2 10MHz 16QAM 1RB CH-Low

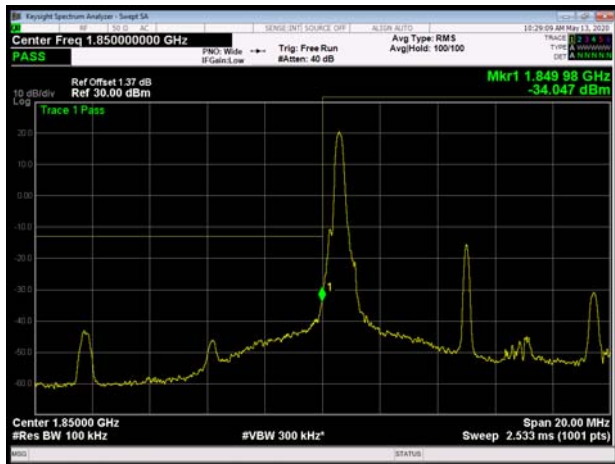

LTE Band 2 10MHz 16QAM 1RB CH-High

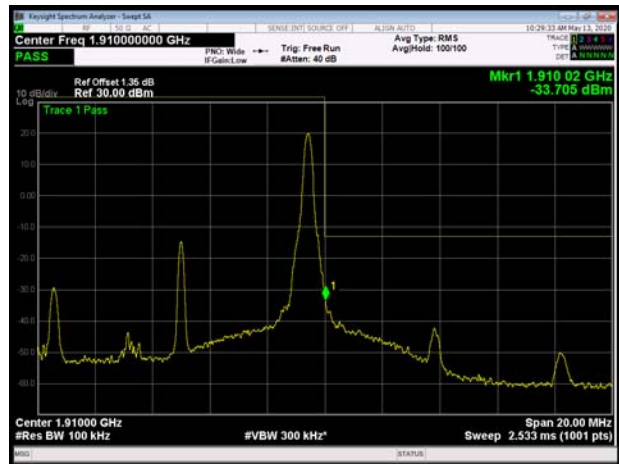

LTE Band 2 10MHz 16QAM 100%RB CH-Low

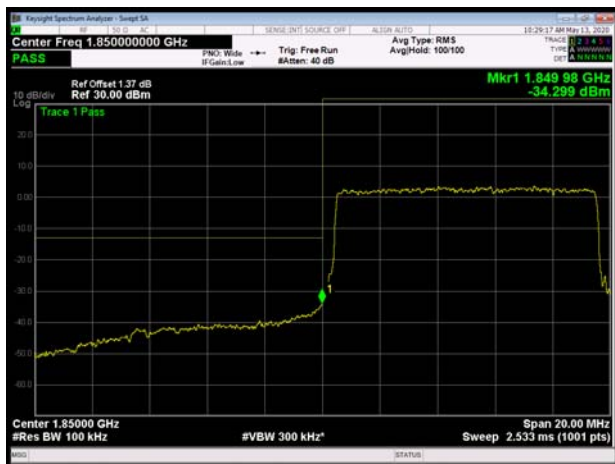

LTE Band 2 10MHz 16QAM 100%RB CH-High



LTE Band 2 15MHz 16QAM 1RB CH-Low

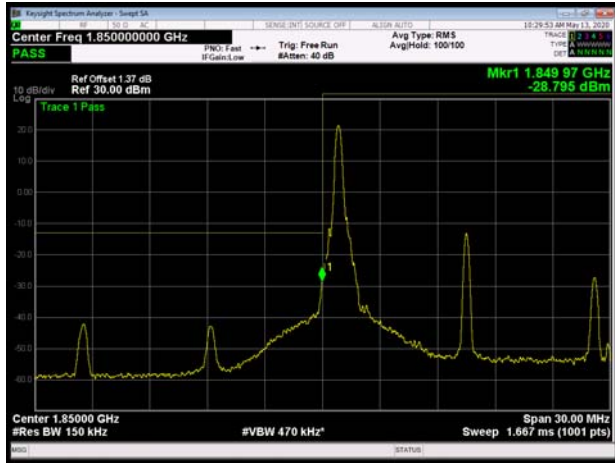

LTE Band 2 15MHz 16QAM 1RB CH-High

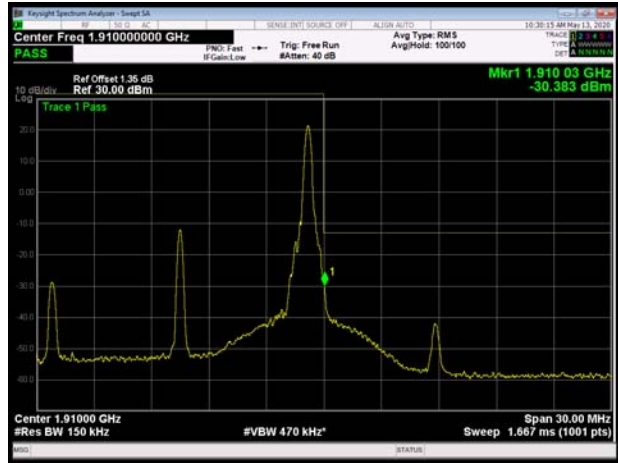

LTE Band 2 15MHz 16QAM 100%RB CH-Low

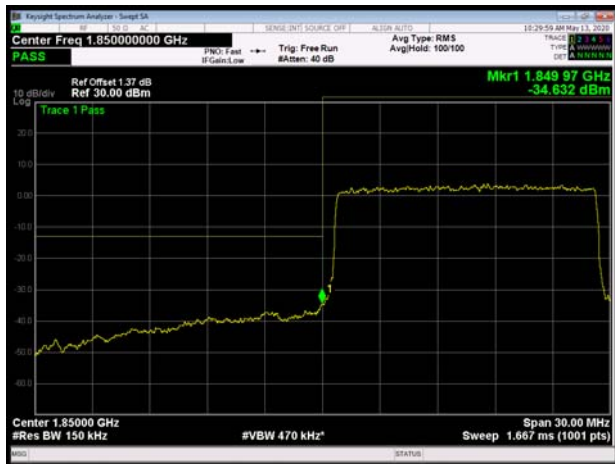

LTE Band 2 15MHz 16QAM 100%RB CH-High

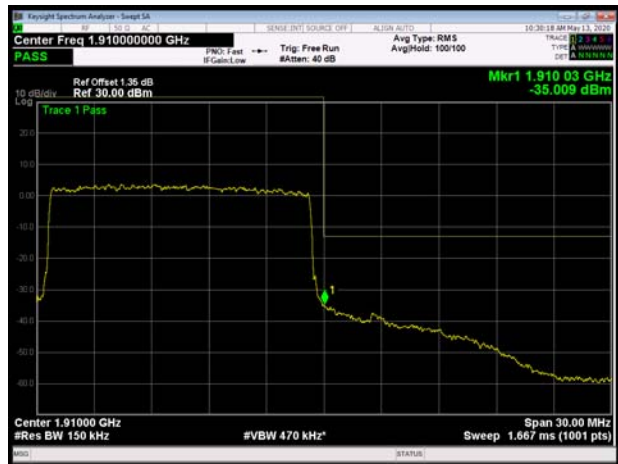

LTE Band 2 20MHz 16QAM 1RB CH-Low

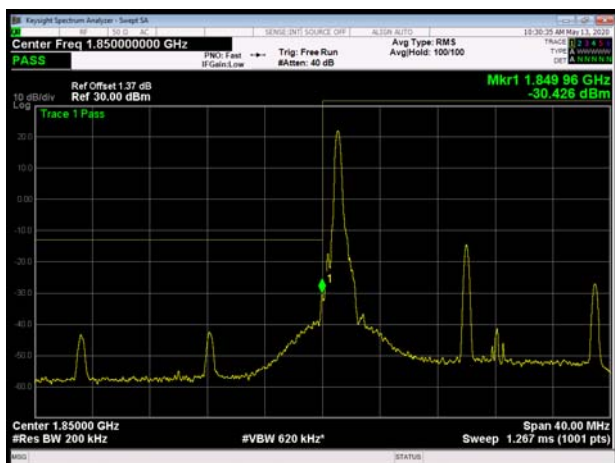

LTE Band 2 20MHz 16QAM 1RB CH-High

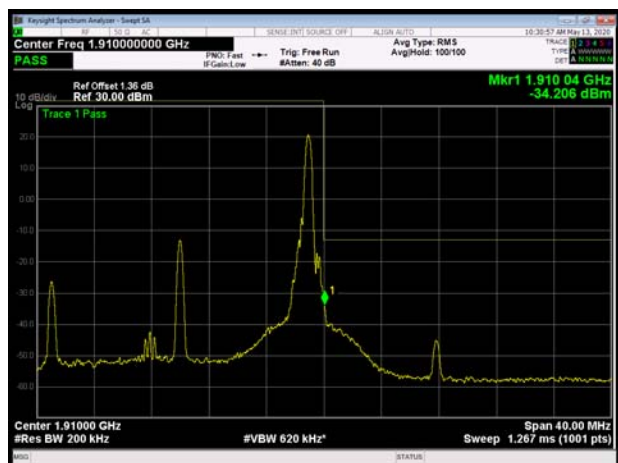



LTE Band 2 20MHz 16QAM 100%RB CH-Low

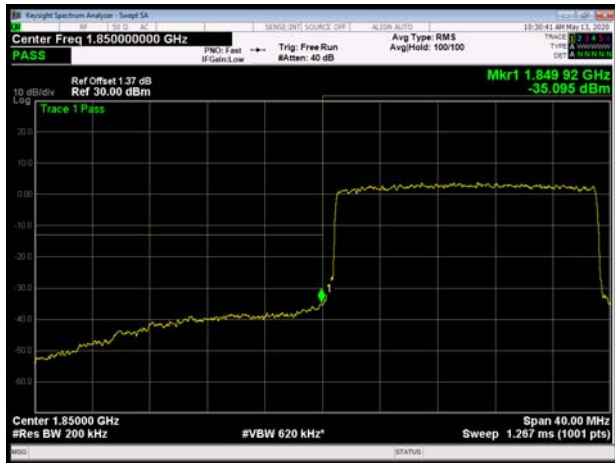

LTE Band 2 20MHz 16QAM 100%RB CH-High

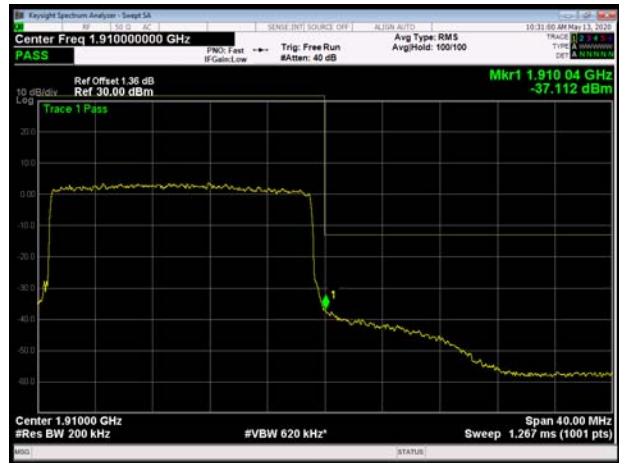

5.4. Peak-to-Average Power Ratio (PAPR)

Ambient condition

Temperature	Relative humidity	Pressure
23°C ~25°C	45%~50%	101.5kPa

Methods of Measurement

Measure the total peak power and record as PPk. And measure the total average power and record as PAvg. Both the peak and average power levels must be expressed in the same logarithmic units (e.g., dBm). Determine the PAPR from:

$$PAPR (dB) = PPk (dBm) - PAvg (dBm).$$

Test Setup

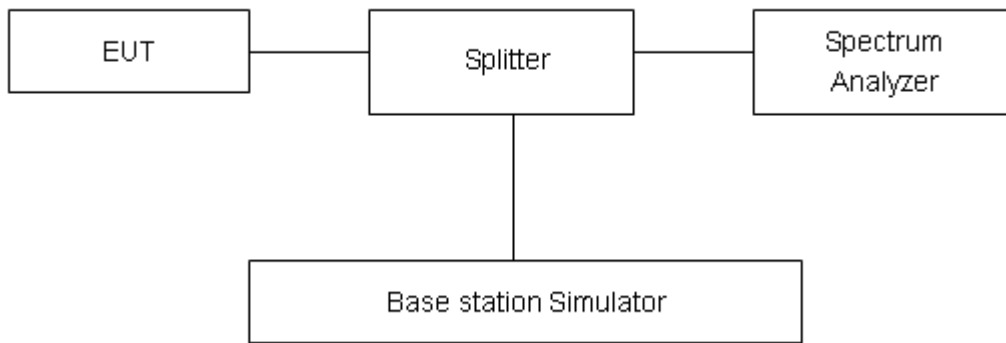

Limits

In measuring transmissions in this band using an average power technique, the peak-to-average ratio (PAR) of the transmission may not exceed 13 dB in 24.232(d).

Measurement Uncertainty

The assessed measurement uncertainty to ensure 95% confidence level for the normal distribution is with the coverage factor $k = 2$, $U = 0.4$ dB.

**Test Results**

Mode	Channel	Frequency (MHz)	Peak(dBm)	Avg(dBm)	PAPR(dB)	Limit(dB)	Conclusion
GSM 1900 (GSM)	512	1850.2	30.68	29.80	0.88	≤13	PASS
	661	1880	30.75	29.86	0.89	≤13	PASS
	810	1909.8	30.75	29.91	0.84	≤13	PASS
GPRS 1900 (GMSK)	512	1850.2	30.51	29.57	0.94	≤13	PASS
	661	1880	30.58	29.61	0.97	≤13	PASS
	810	1909.8	30.62	29.71	0.91	≤13	PASS
EGPRS 1900 (8-PSK)	512	1850.2	30.54	29.51	1.03	≤13	PASS
	661	1880	30.73	29.64	1.09	≤13	PASS
	810	1909.8	30.83	29.68	1.15	≤13	PASS
WCDMA Band II (RMC)	9262	1852.4	26.82	23.78	3.04	≤13	PASS
	9400	1880	26.84	23.78	3.06	≤13	PASS
	9538	1907.6	26.68	23.57	3.11	≤13	PASS



LTE Band 2								
Modulation	Bandwidth (MHz)	Channel	Frequency (MHz)	Peak (dBm)	Avg (dBm)	PAPR (dB)	Limit (dB)	Conclusion
QPSK	1.4	18607	1850.7	27.40	22.41	4.99	≤13	PASS
		18900	1880.0	27.48	22.65	4.83	≤13	PASS
		19193	1909.3	27.11	22.27	4.84	≤13	PASS
	3	18615	1851.5	27.57	22.44	5.13	≤13	PASS
		18900	1880	27.56	22.62	4.94	≤13	PASS
		19185	1908.5	27.33	22.30	5.03	≤13	PASS
	5	18625	1852.5	27.50	22.42	5.08	≤13	PASS
		18900	1880	27.52	22.61	4.91	≤13	PASS
		19175	1907.5	27.30	22.28	5.02	≤13	PASS
	10	18650	1855	27.61	22.50	5.11	≤13	PASS
		18900	1880	27.58	22.63	4.95	≤13	PASS
		19150	1905	27.44	22.32	5.12	≤13	PASS
	15	18675	1857.5	27.71	22.48	5.23	≤13	PASS
		18900	1880	27.54	22.59	4.95	≤13	PASS
		19125	1902.5	27.53	22.27	5.26	≤13	PASS
	20	18700	1860	27.66	22.45	5.21	≤13	PASS
		18900	1880	27.55	22.54	5.01	≤13	PASS
		19100	1900	27.47	22.23	5.24	≤13	PASS
16QAM	1.4	18607	1850.7	27.19	21.39	5.80	≤13	PASS
		18900	1880.0	27.19	21.57	5.62	≤13	PASS
		19193	1909.3	27.21	21.59	5.62	≤13	PASS
	3	18615	1851.5	27.33	21.42	5.91	≤13	PASS
		18900	1880	27.24	21.50	5.74	≤13	PASS
		19185	1908.5	27.47	21.62	5.85	≤13	PASS
	5	18625	1852.5	27.24	21.40	5.84	≤13	PASS
		18900	1880	27.12	21.46	5.66	≤13	PASS
		19175	1907.5	27.35	21.57	5.78	≤13	PASS
	10	18650	1855	27.28	21.43	5.85	≤13	PASS
		18900	1880	27.21	21.51	5.70	≤13	PASS
		19150	1905	27.55	21.61	5.94	≤13	PASS
	15	18675	1857.5	27.33	21.40	5.93	≤13	PASS
		18900	1880	27.13	21.46	5.67	≤13	PASS
		19125	1902.5	27.58	21.57	6.01	≤13	PASS
	20	18700	1860	27.34	21.38	5.96	≤13	PASS
		18900	1880	27.17	21.42	5.75	≤13	PASS
		19100	1900	27.59	21.54	6.05	≤13	PASS

5.5.Frequency Stability

Ambient condition

Temperature	Relative humidity	Pressure
23°C ~25°C	45%~50%	101.5kPa

Method of Measurement

Frequency Stability (Temperature Variation)

The temperature inside the climate chamber is varied from -40°C to +85°C in 10°C step size,

(1) With all power removed, the temperature was decreased to 0°C and permitted to stabilize for three hours.

(2) Measure the carrier frequency with the test equipment in a “call mode”. These measurements should be made within 1 minute of powering up the mobile station, to prevent significant self warming.

(3) Repeat the above measurements at 10°C increments from -40°C to +85°C. Allow at least 1.5 hours at each temperature, un-powered, before making measurements.

Frequency Stability (Voltage Variation)

The frequency stability shall be measured with variation of primary supply voltage as follows:

(1) Vary primary supply voltage from 85 to 115 percent of the nominal value for other than hand carried battery equipment.

(2) For hand carried, battery powered equipment, reduce primary supply voltage to the battery-operating end point which shall be specified by the manufacturer.

This transceiver is specified to operate with an input voltage of between 3.3 V and 4.3 V, with a nominal voltage of 3.8V.

Test setup

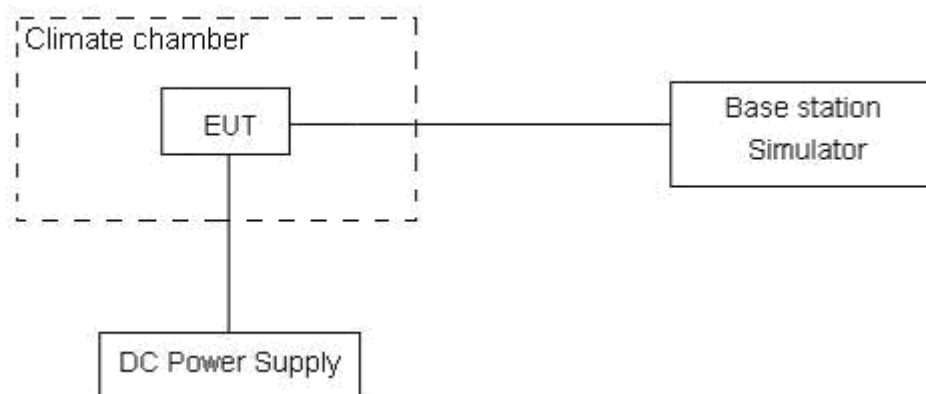

**Limits**

The frequency stability shall be sufficient to ensure that the fundamental emission stays within the authorized frequency block

Measurement Uncertainty

The assessed measurement uncertainty to ensure 99.75% confidence level for the normal distribution is with the coverage factor $k = 3$, $U = 0.01\text{ppm}$.



Test Result

GSM1900						
Condition		Freq.Error (Hz)	Freq.Error (Hz)	Frequency Stability (ppm)	Frequency Stability (ppm)	Verdict
Temperature	Voltage	GMSK	8PSK	GMSK	8PSK	
Normal (25°C)	Normal	2.14	6.56	0.00114	0.00349	PASS
Extreme (85°C)		7.91	16.38	0.00421	0.00871	PASS
Extreme (80°C)		16.72	3.49	0.00890	0.00186	PASS
Extreme (70°C)		14.12	9.88	0.00751	0.00525	PASS
Extreme (60°C)		16.54	3.55	0.00880	0.00189	PASS
Extreme (50°C)		9.53	7.64	0.00507	0.00407	PASS
Extreme (40°C)		16.77	7.62	0.00892	0.00406	PASS
Extreme (30°C)		16.01	12.86	0.00851	0.00684	PASS
Extreme (20°C)		4.27	3.09	0.00227	0.00164	PASS
Extreme (10°C)		17.72	8.65	0.00942	0.00460	PASS
Extreme (0°C)		11.98	14.42	0.00637	0.00767	PASS
Extreme (-10°C)		4.55	4.99	0.00242	0.00265	PASS
Extreme (-20°C)		8.16	7.22	0.00434	0.00384	PASS
Extreme (-30°C)		9.81	9.15	0.00522	0.00487	PASS
Extreme (-40°C)		2.63	15.20	0.00140	0.00809	PASS
25°C	LV	5.55	3.84	0.00295	0.00204	PASS
	HV	7.17	3.26	0.00382	0.00174	PASS

WCDMA Band II						
Condition		Freq.Error (Hz)	Freq.Error (Hz)	Frequency Stability (ppm)	Frequency Stability (ppm)	Verdict
Temperature	Voltage	BPSK	QPSK	BPSK	QPSK	
Normal (25°C)	Normal	15.38	11.91	0.00818	0.00634	PASS
Extreme (85°C)		12.67	3.59	0.00674	0.00191	PASS
Extreme (80°C)		9.31	3.52	0.00495	0.00187	PASS
Extreme (70°C)		9.65	2.28	0.00513	0.00121	PASS
Extreme (60°C)		6.94	3.90	0.00369	0.00208	PASS
Extreme (50°C)		15.01	10.37	0.00798	0.00551	PASS
Extreme (40°C)		11.95	13.77	0.00635	0.00732	PASS
Extreme (30°C)		7.62	6.65	0.00405	0.00354	PASS
Extreme (20°C)		16.53	11.24	0.00879	0.00598	PASS
Extreme (10°C)		8.89	1.95	0.00473	0.00104	PASS
Extreme (0°C)		6.85	14.37	0.00364	0.00764	PASS
Extreme (-10°C)		4.75	17.34	0.00253	0.00923	PASS



Extreme (-20°C)		7.16	1.28	0.00381	0.00068	PASS
Extreme (-30°C)		7.92	4.53	0.00421	0.00241	PASS
Extreme (-40°C)		6.53	4.12	0.00348	0.00219	PASS
25°C	LV	1.37	3.63	0.00073	0.00193	PASS
	HV	10.64	12.00	0.00566	0.00638	PASS

LTE Band 2						
Condition		Freq.Error (Hz)	Freq.Error (Hz)	Frequency Stability (ppm)	Frequency Stability (ppm)	Verdict
BANDWIDTH	1.4MHz					
Temperature	Voltage	16QAM	QPSK	16QAM	QPSK	
Normal (25°C)	Normal	16.29	10.21	0.00867	0.00543	PASS
Extreme (85°C)		12.52	5.78	0.00666	0.00308	PASS
Extreme (80°C)		14.49	5.46	0.00771	0.00291	PASS
Extreme (70°C)		6.71	11.17	0.00357	0.00594	PASS
Extreme (60°C)		1.20	5.78	0.00064	0.00307	PASS
Extreme (50°C)		13.84	5.45	0.00736	0.00290	PASS
Extreme (40°C)		14.81	11.46	0.00788	0.00609	PASS
Extreme (30°C)		9.68	2.27	0.00515	0.00121	PASS
Extreme (20°C)		15.59	6.64	0.00829	0.00353	PASS
Extreme (10°C)		11.57	8.95	0.00616	0.00476	PASS
Extreme (0°C)		15.14	9.00	0.00805	0.00478	PASS
Extreme (-10°C)		2.84	5.73	0.00151	0.00305	PASS
Extreme (-20°C)		2.30	9.32	0.00123	0.00496	PASS
Extreme (-30°C)		16.46	10.12	0.00876	0.00538	PASS
Extreme (-40°C)		14.36	16.83	0.00764	0.00895	PASS
25°C	LV	11.10	1.69	0.00590	0.00090	PASS
	HV	15.86	16.25	0.00844	0.00865	PASS
Condition		Freq.Error (Hz)	Freq.Error (Hz)	Frequency Stability (ppm)	Frequency Stability (ppm)	Verdict
BANDWIDTH	3MHz					
Temperature	Voltage	16QAM	QPSK	16QAM	QPSK	
Normal (25°C)	Normal	10.37	14.40	0.00551	0.00766	PASS
Extreme (85°C)		3.76	5.65	0.00200	0.00300	PASS
Extreme (80°C)		13.59	9.69	0.00723	0.00516	PASS
Extreme (70°C)		1.06	3.50	0.00057	0.00186	PASS
Extreme (60°C)		14.75	4.23	0.00785	0.00225	PASS
Extreme (50°C)		11.98	1.47	0.00637	0.00078	PASS
Extreme (40°C)		1.26	12.41	0.00067	0.00660	PASS
Extreme (30°C)		11.55	15.15	0.00614	0.00806	PASS
Extreme (20°C)		13.92	5.98	0.00740	0.00318	PASS



Extreme (10°C)		8.59	12.76	0.00457	0.00679	PASS
Extreme (0°C)		14.36	1.83	0.00764	0.00097	PASS
Extreme (-10°C)		6.85	15.33	0.00364	0.00816	PASS
Extreme (-20°C)		8.24	4.02	0.00438	0.00214	PASS
Extreme (-30°C)		15.62	2.35	0.00831	0.00125	PASS
Extreme (-40°C)		2.18	7.41	0.00116	0.00394	PASS
25°C	LV	13.55	2.74	0.00721	0.00146	PASS
	HV	10.42	7.33	0.00555	0.00390	PASS
Condition		Freq.Error (Hz)	Freq.Error (Hz)	Frequency Stability (ppm)	Frequency Stability (ppm)	Verdict
BANDWIDTH	5MHz					
Temperature	Voltage	16QAM	QPSK	16QAM	QPSK	
Normal (25°C)	Normal	13.47	2.50	0.00716	0.00133	PASS
Extreme (85°C)		9.77	12.88	0.00520	0.00685	PASS
Extreme (80°C)		7.53	6.30	0.00400	0.00335	PASS
Extreme (70°C)		16.47	15.23	0.00876	0.00810	PASS
Extreme (60°C)		16.56	14.73	0.00881	0.00784	PASS
Extreme (50°C)		2.95	1.68	0.00157	0.00089	PASS
Extreme (40°C)		11.61	14.33	0.00617	0.00762	PASS
Extreme (30°C)		9.01	12.98	0.00479	0.00690	PASS
Extreme (20°C)		9.26	9.32	0.00493	0.00496	PASS
Extreme (10°C)		5.59	9.80	0.00297	0.00521	PASS
Extreme (0°C)		4.88	9.86	0.00260	0.00525	PASS
Extreme (-10°C)		14.42	14.97	0.00767	0.00796	PASS
Extreme (-20°C)		10.39	15.74	0.00553	0.00837	PASS
Extreme (-30°C)		3.61	6.60	0.00192	0.00351	PASS
Extreme (-40°C)		9.32	5.85	0.00496	0.00311	PASS
25°C	LV	3.06	5.42	0.00163	0.00288	PASS
	HV	14.84	1.69	0.00789	0.00090	PASS
Condition		Freq.Error (Hz)	Freq.Error (Hz)	Frequency Stability (ppm)	Frequency Stability (ppm)	Verdict
BANDWIDTH	10MHz					
Temperature	Voltage	16QAM	QPSK	16QAM	QPSK	
Normal (25°C)	Normal	17.55	15.17	0.00934	0.00807	PASS
Extreme (85°C)		16.73	13.95	0.00890	0.00742	PASS
Extreme (80°C)		11.08	10.22	0.00590	0.00543	PASS
Extreme (70°C)		15.81	8.29	0.00841	0.00441	PASS
Extreme (60°C)		3.45	2.33	0.00183	0.00124	PASS
Extreme (50°C)		14.46	13.70	0.00769	0.00729	PASS
Extreme (40°C)		14.95	14.78	0.00795	0.00786	PASS
Extreme (30°C)		16.77	7.63	0.00892	0.00406	PASS
Extreme (20°C)		9.78	13.72	0.00520	0.00730	PASS



Extreme (10°C)		5.16	9.21	0.00274	0.00490	PASS
Extreme (0°C)		5.70	9.00	0.00303	0.00479	PASS
Extreme (-10°C)		5.79	15.94	0.00308	0.00848	PASS
Extreme (-20°C)		2.15	6.82	0.00114	0.00363	PASS
Extreme (-30°C)		1.72	16.96	0.00091	0.00902	PASS
Extreme (-40°C)		12.08	11.38	0.00642	0.00605	PASS
25°C	LV	16.02	7.32	0.00852	0.00389	PASS
	HV	4.72	2.02	0.00251	0.00107	PASS
Condition		Freq.Error (Hz)	Freq.Error (Hz)	Frequency Stability (ppm)	Frequency Stability (ppm)	Verdict
BANDWIDTH	15MHz					
Temperature	Voltage	16QAM	QPSK	16QAM	QPSK	
Normal (25°C)	Normal	1.79	1.38	0.00095	0.00073	PASS
Extreme (85°C)		13.51	3.84	0.00719	0.00204	PASS
Extreme (80°C)		4.61	4.12	0.00245	0.00219	PASS
Extreme (70°C)		17.34	5.53	0.00922	0.00294	PASS
Extreme (60°C)		12.91	8.24	0.00687	0.00438	PASS
Extreme (50°C)		10.27	11.24	0.00547	0.00598	PASS
Extreme (40°C)		7.36	1.87	0.00392	0.00100	PASS
Extreme (30°C)		9.11	8.54	0.00485	0.00454	PASS
Extreme (20°C)		17.40	2.58	0.00925	0.00137	PASS
Extreme (10°C)		13.82	13.43	0.00735	0.00714	PASS
Extreme (0°C)		2.25	11.68	0.00120	0.00621	PASS
Extreme (-10°C)		1.55	11.39	0.00082	0.00606	PASS
Extreme (-20°C)		13.88	11.07	0.00738	0.00589	PASS
Extreme (-30°C)		9.50	6.23	0.00505	0.00331	PASS
Extreme (-40°C)		17.08	5.98	0.00909	0.00318	PASS
25°C	LV	13.04	6.79	0.00693	0.00361	PASS
	HV	17.22	4.45	0.00916	0.00237	PASS
Condition		Freq.Error (Hz)	Freq.Error (Hz)	Frequency Stability (ppm)	Frequency Stability (ppm)	Verdict
BANDWIDTH	20MHz					
Temperature	Voltage	16QAM	QPSK	16QAM	QPSK	
Normal (25°C)	Normal	1.19	1.67	0.00063	0.00089	PASS
Extreme (85°C)		17.27	13.44	0.00919	0.00715	PASS
Extreme (80°C)		6.45	3.54	0.00343	0.00188	PASS
Extreme (70°C)		6.28	7.23	0.00334	0.00384	PASS
Extreme (60°C)		6.31	7.16	0.00336	0.00381	PASS
Extreme (50°C)		8.44	5.61	0.00449	0.00298	PASS
Extreme (40°C)		12.44	10.81	0.00662	0.00575	PASS
Extreme (30°C)		4.68	6.62	0.00249	0.00352	PASS
Extreme (20°C)		12.41	5.88	0.00660	0.00313	PASS



Extreme (10°C)		2.03	6.63	0.00108	0.00353	PASS
Extreme (0°C)		2.09	4.53	0.00111	0.00241	PASS
Extreme (-10°C)		4.77	6.08	0.00253	0.00324	PASS
Extreme (-20°C)		16.24	3.71	0.00864	0.00197	PASS
Extreme (-30°C)		14.58	2.14	0.00776	0.00114	PASS
Extreme (-40°C)		14.01	16.23	0.00745	0.00863	PASS
25°C	LV	14.02	17.17	0.00746	0.00913	PASS
	HV	13.11	14.82	0.00698	0.00788	PASS

5.6. Spurious Emissions at Antenna Terminals

Ambient condition

Temperature	Relative humidity	Pressure
23°C ~25°C	45%~50%	101.5kPa

Method of Measurement

The EUT was connected to Spectrum Analyzer and Base Station Simulator via power Splitter. The measurement is carried out using a spectrum analyzer. The spectrum analyzer scans from 9kHz to the 10th harmonic of the carrier. The peak detector is used.

RBW is set to 100kHz, VBW is set to 300kHz for 30MHz~1GHz

RBW is set to 1MHz, VBW is set to 3MHz for above 1GHz, Sweep is set to ATUO.

The modulation mode and RB allocation refer to section 5.1, using the maximum output power configuration.

Test setup

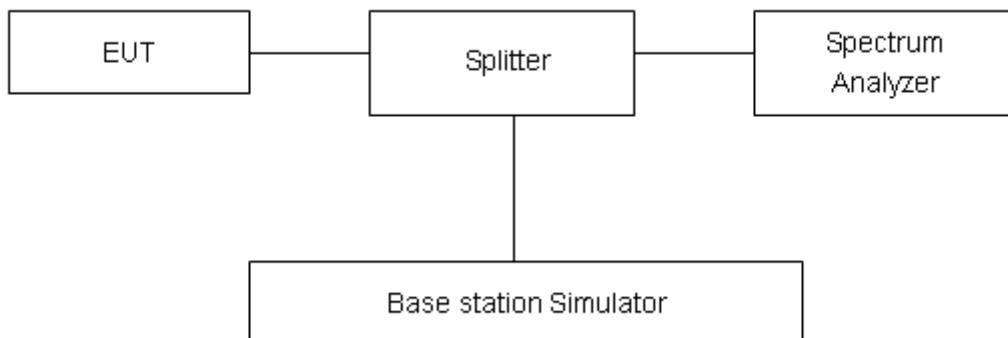

Limits

Rule Part 24.238(a) specifies that “on any frequency outside a licensee’s frequency block, the power of any emission shall be attenuated below the transmitter power (P) by at least 43 + 10 log₁₀ (P) dB.”

Limit	-13 dBm
-------	---------

Measurement Uncertainty

The assessed measurement uncertainty to ensure 99.75% confidence level for the normal distribution is with the coverage factor $k = 1.96$.

Frequency	Uncertainty
9kHz-1GHz	0.684 dB
1GHz-20GHz	1.407 dB



Test Result

Sweep the whole frequency band through the range from 9kHz to the 10th harmonic of the carrier, the emissions more than 20 dB below the limit are not reported.

The signal beyond the limit is carrier.

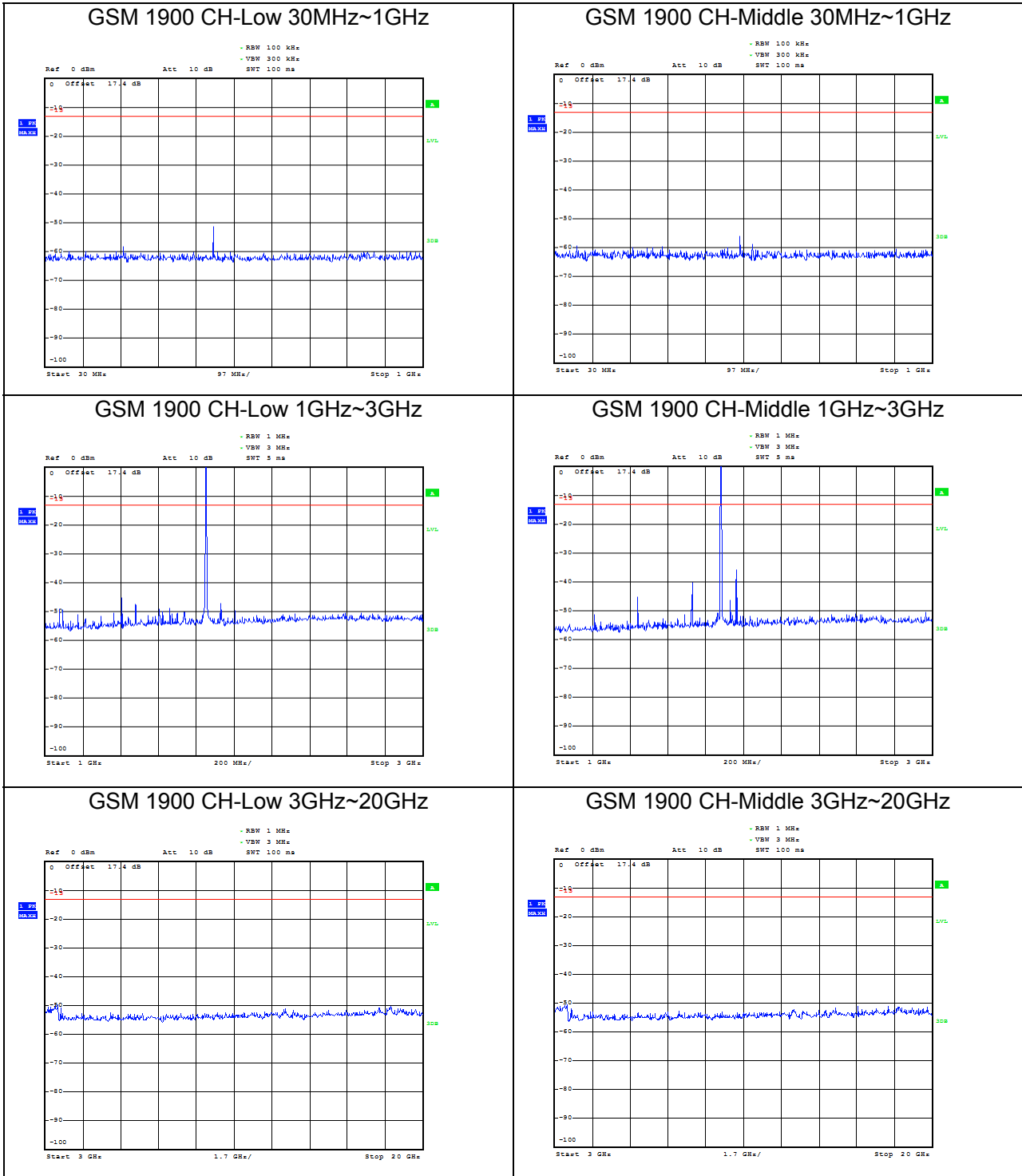



GSM 1900 CH-High 30MHz~1GHz

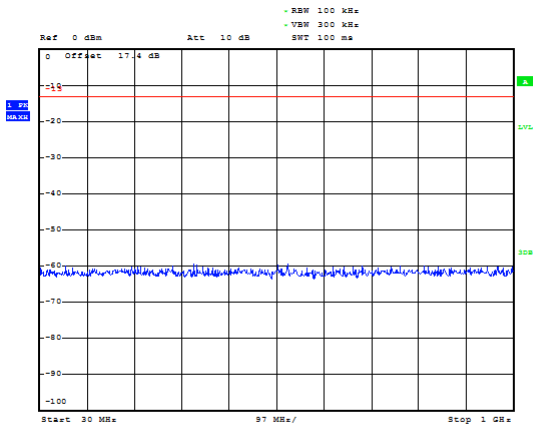

WCDMA Band II CH-Low 30MHz~1GHz

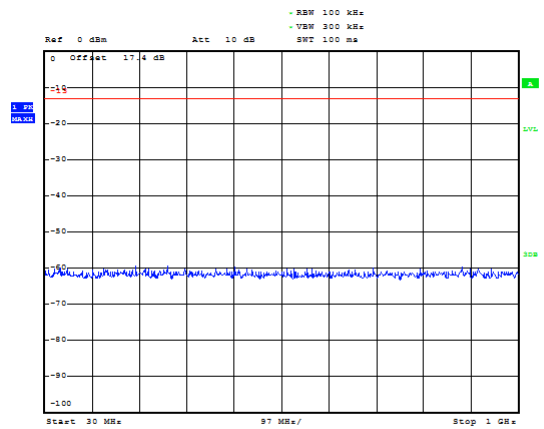

GSM 1900 CH-High 1GHz~3GHz

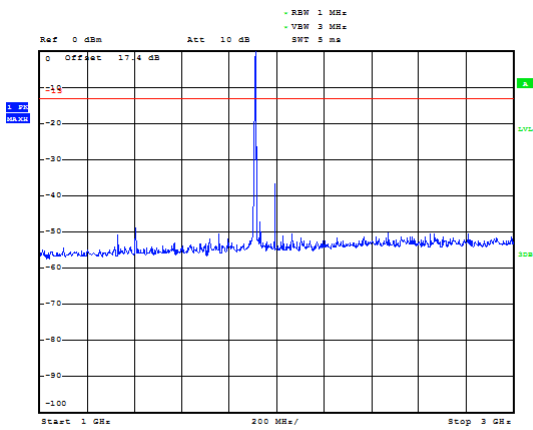

WCDMA BAND II CH-Low 1GHz~3GHz

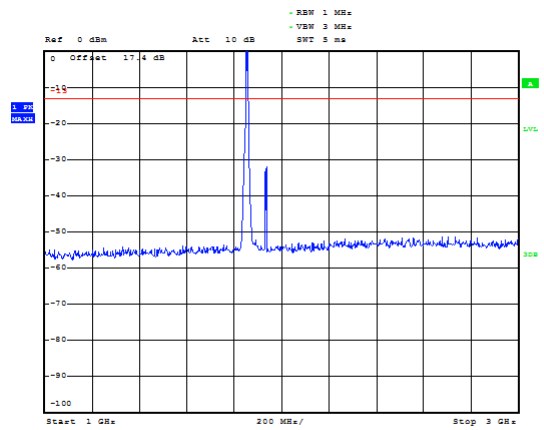

GSM 1900 CH-High 3GHz~20GHz

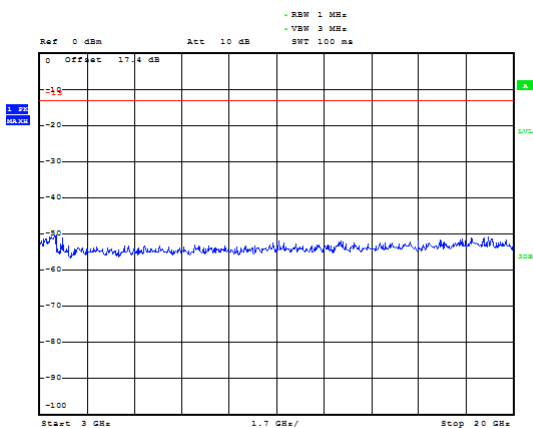

WCDMA BAND II CH-Low 3GHz~20GHz

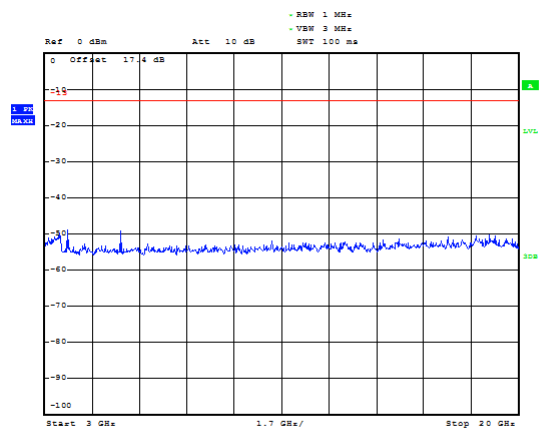



WCDMA Band II CH- Middle 30MHz~1GHz

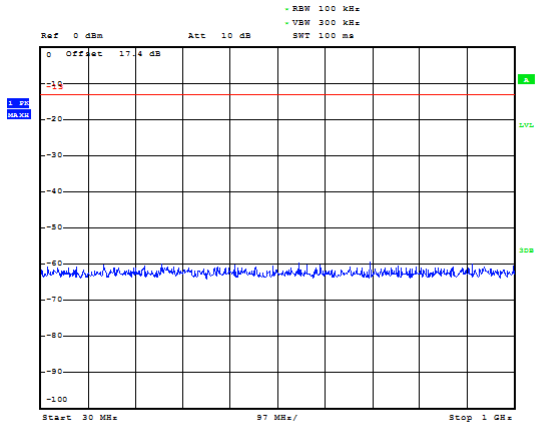

WCDMA Band II CH- High 30MHz~1GHz

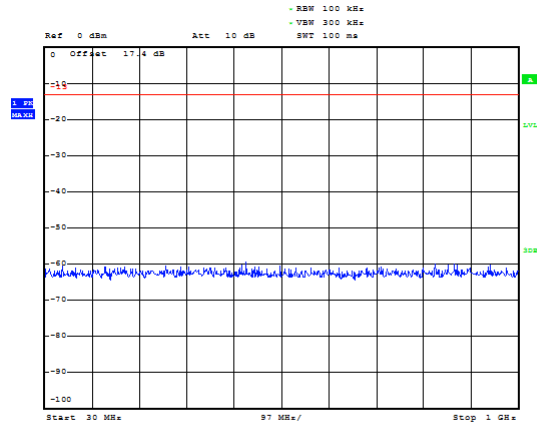

WCDMA BAND II CH-Middle 1GHz~3GHz

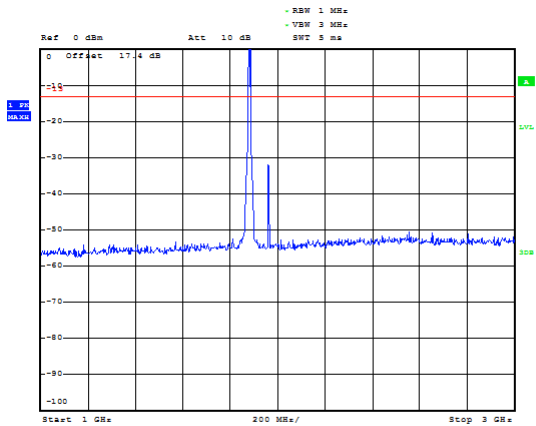

WCDMA BAND II CH-High 1GHz~3GHz

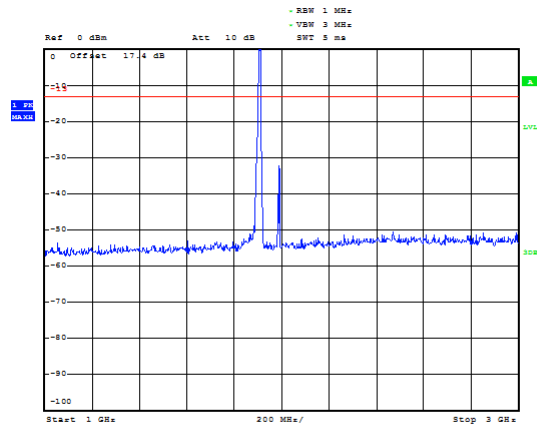

WCDMA BAND II CH-Middle 3GHz~20GHz

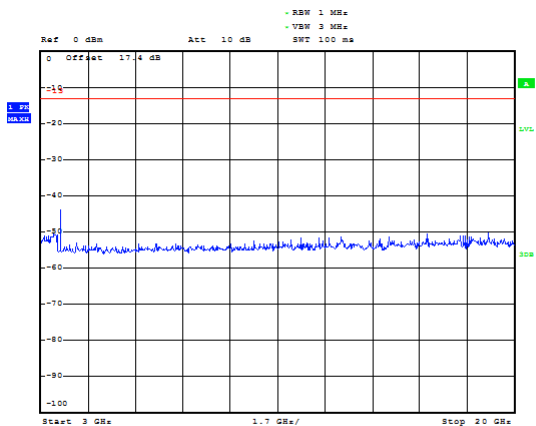

WCDMA BAND II CH-High 3GHz~20GHz

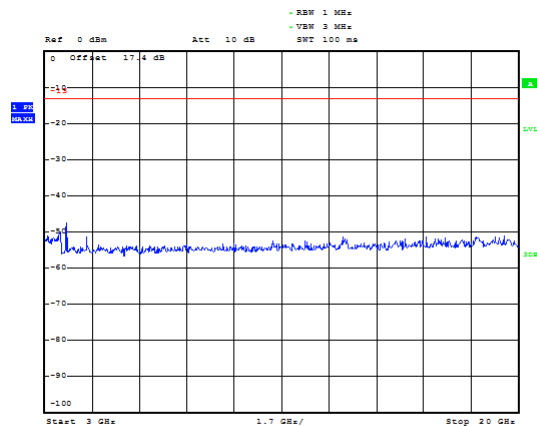



LTE Band 2 1.4MHz CH-Low 30MHz~1GHz

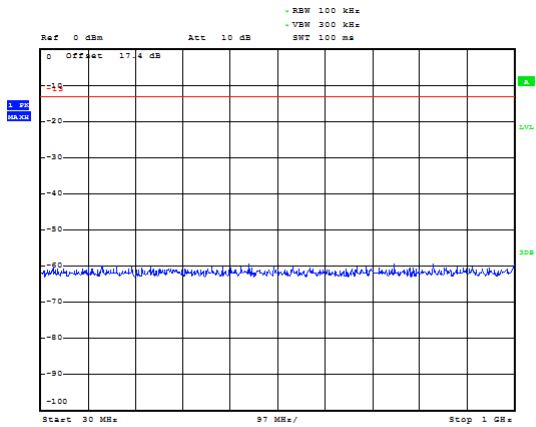

LTE Band 2 1.4MHz CH-Middle 30MHz~1GHz

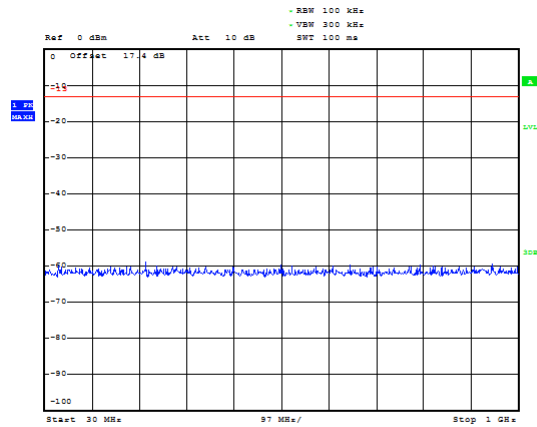

LTE Band 2 1.4MHz CH-Low 1GHz~3GHz

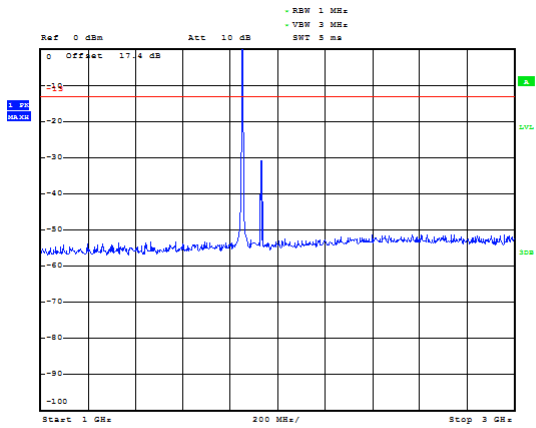

LTE Band 2 1.4MHz CH-Middle 1GHz~3GHz

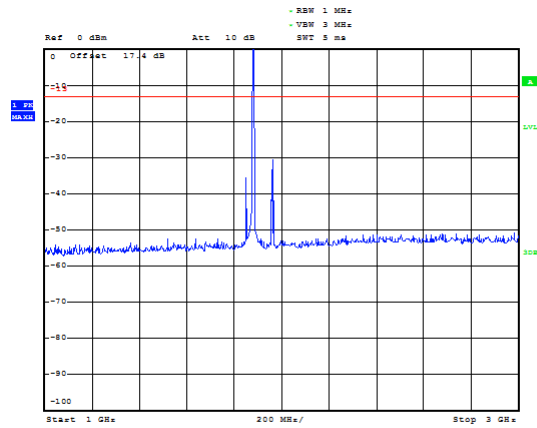

LTE Band 2 1.4MHz CH-Low 3GHz~20GHz

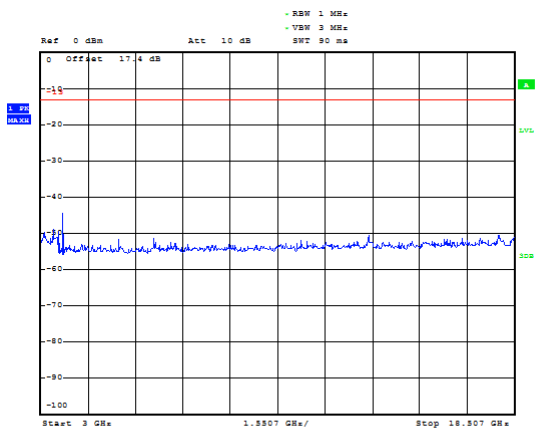

LTE Band 2 1.4MHz CH-Middle 3GHz~20GHz

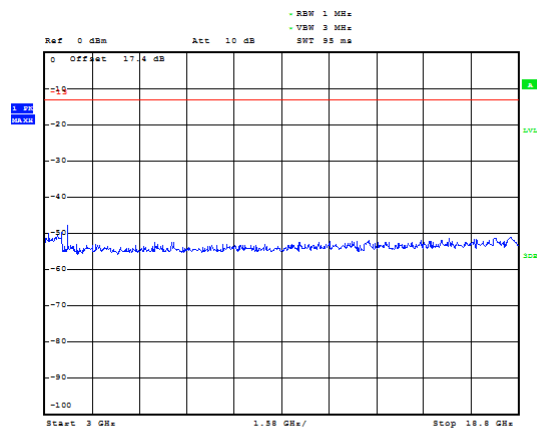



LTE Band 2 1.4MHz CH-High 30MHz~1GHz

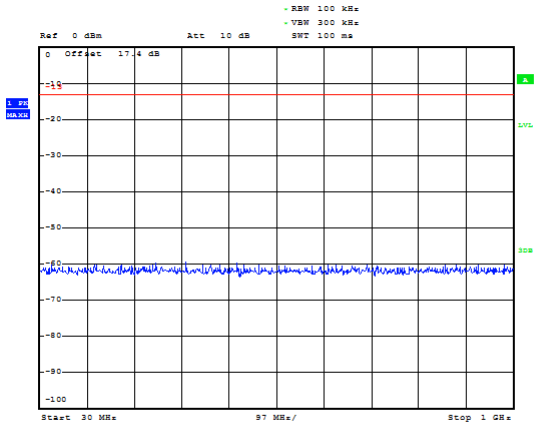

LTE Band 2 3MHz CH-Low 30MHz~1GHz

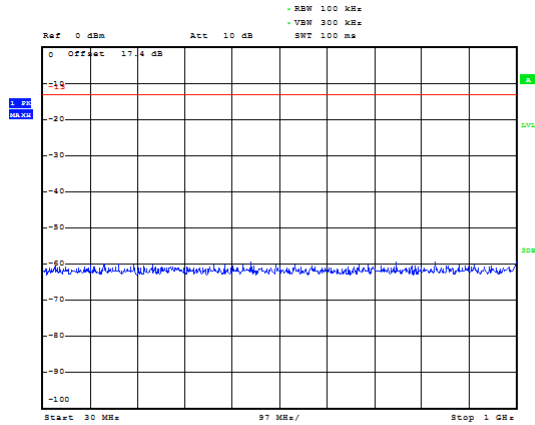

LTE Band 2 1.4MHz CH-High 1GHz~3GHz

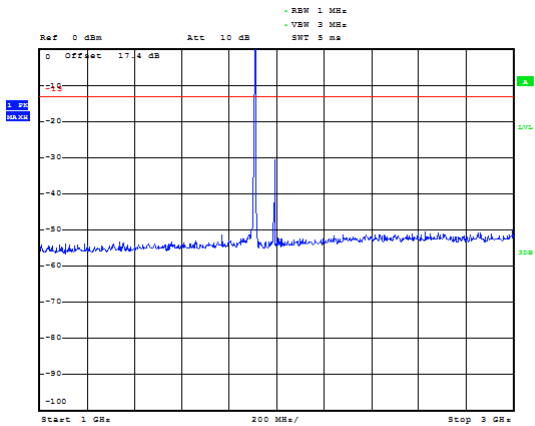

LTE Band 2 3MHz CH-Low 1GHz~3GHz

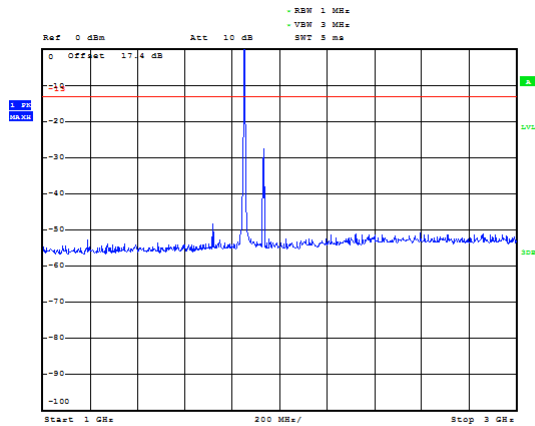

LTE Band 2 1.4MHz CH-High 3GHz~20GHz

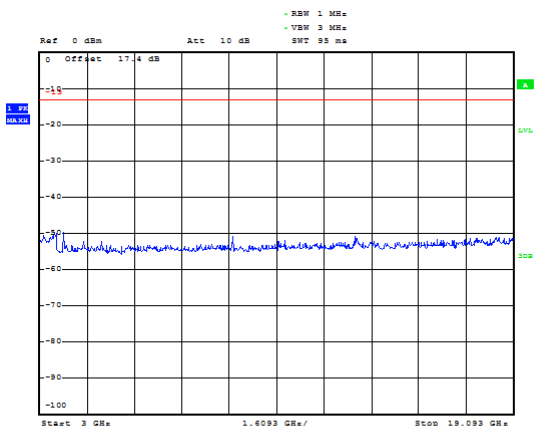

LTE Band 2 3MHz CH-Low 3GHz~20GHz

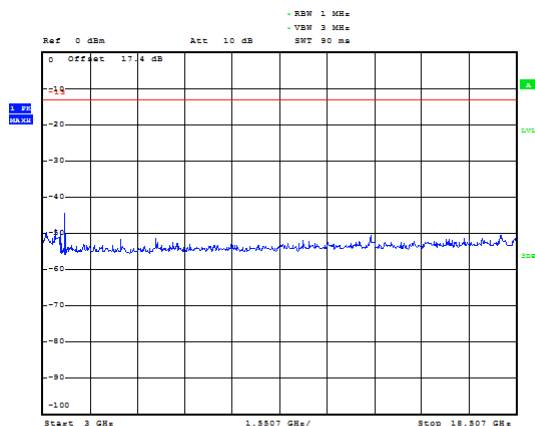



LTE Band 2 3MHz CH-Middle 30MHz~1GHz

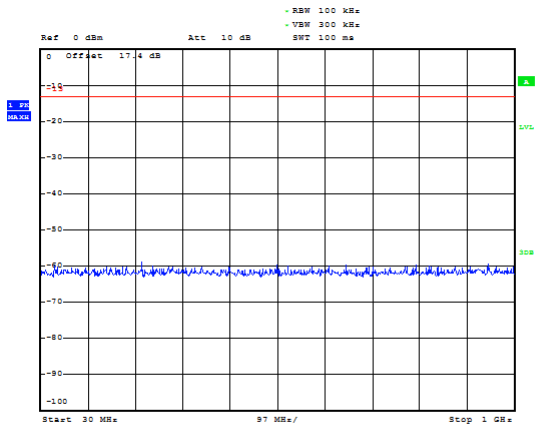

LTE Band 2 3MHz CH-High 30MHz~1GHz

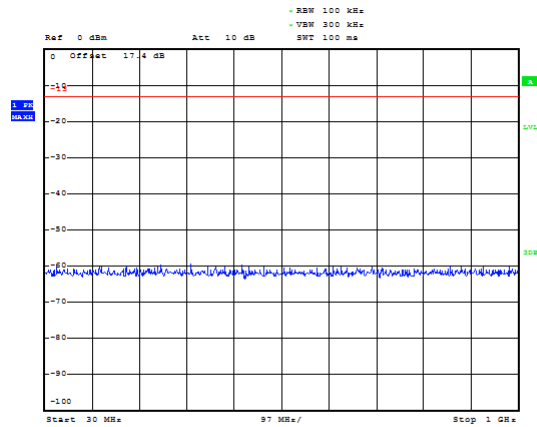

LTE Band 2 3MHz CH-Middle 1GHz~3GHz

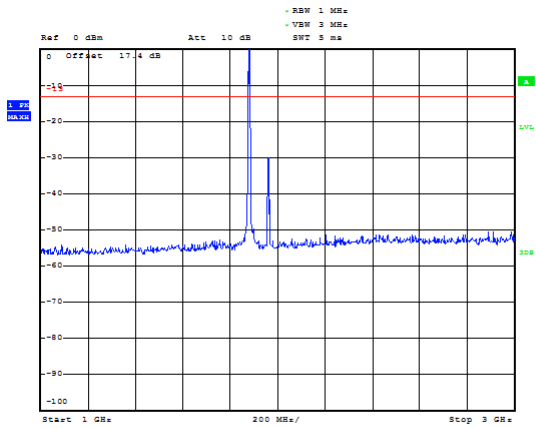

LTE Band 2 3MHz CH-High 1GHz~3GHz

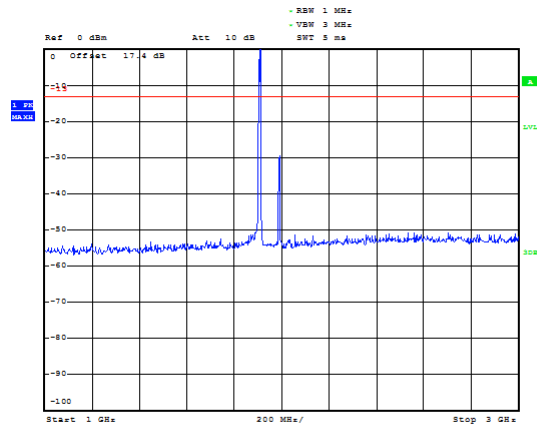

LTE Band 2 3MHz CH-Middle 3GHz~20GHz

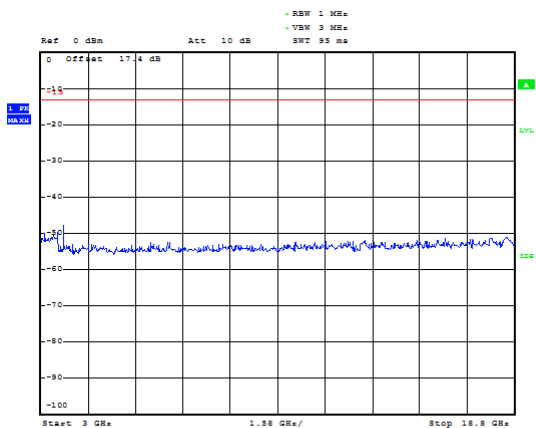

LTE Band 2 3MHz CH-High 3GHz~20GHz

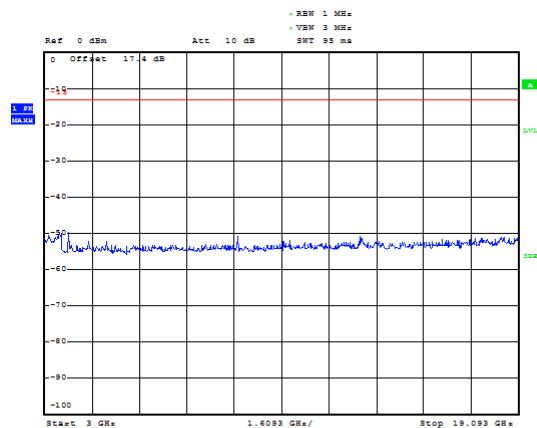



LTE Band 2 5MHz CH-Low 30MHz~1GHz

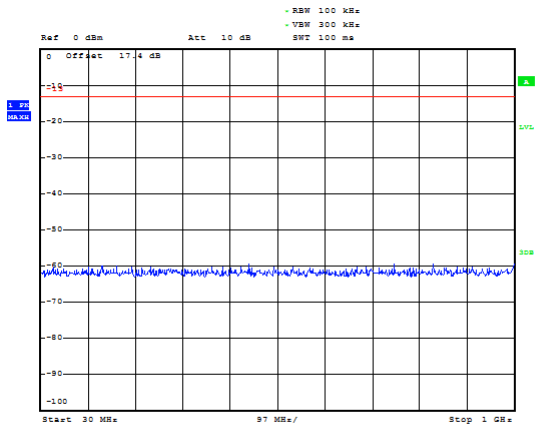

LTE Band 2 5MHz CH-Middle 30MHz~1GHz

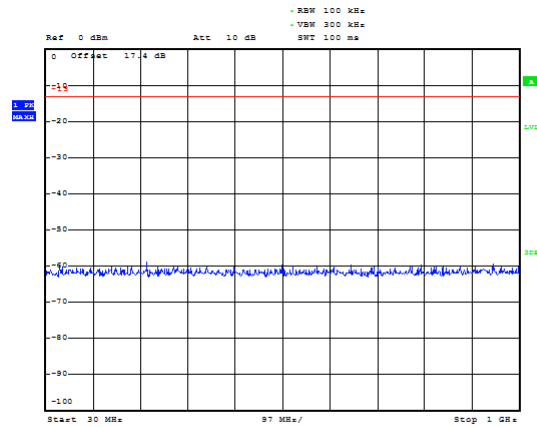

LTE Band 2 5MHz CH-Low 1GHz~3GHz

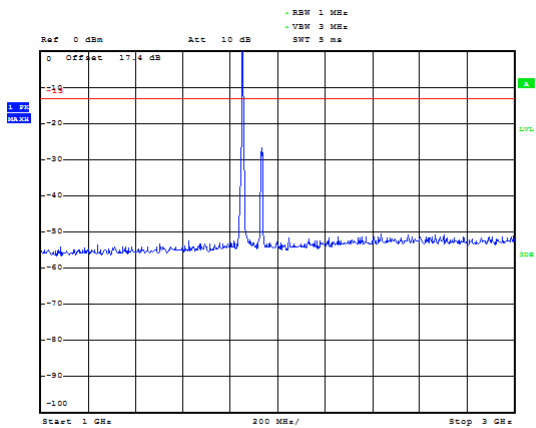

LTE Band 2 5MHz CH-Middle 1GHz~3GHz

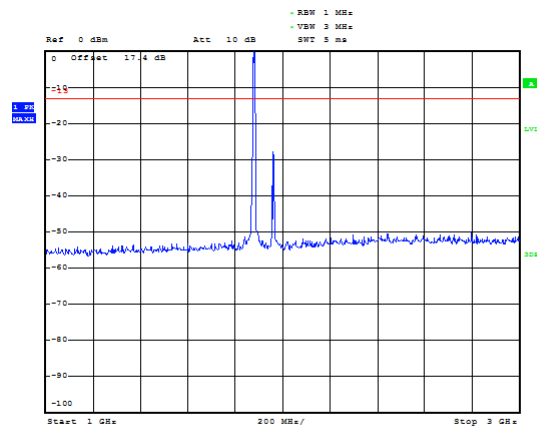

LTE Band 2 5MHz CH-Low 3GHz~20GHz

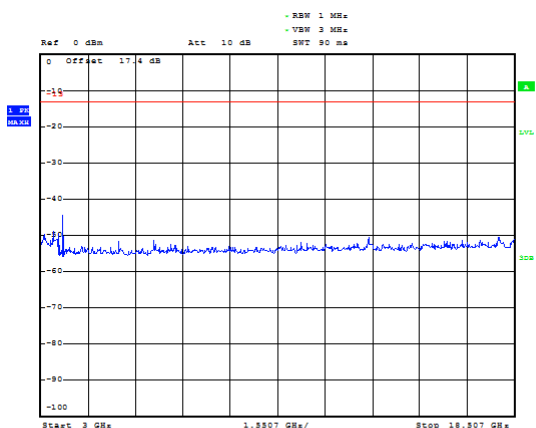

LTE Band 2 5MHz CH-Middle 3GHz~20GHz

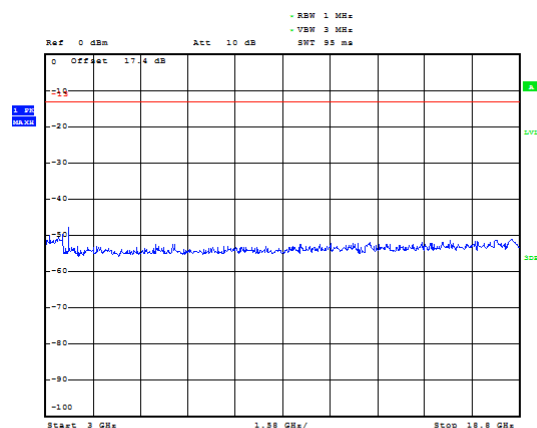



LTE Band 2 5MHz CH-High 30MHz~1GHz

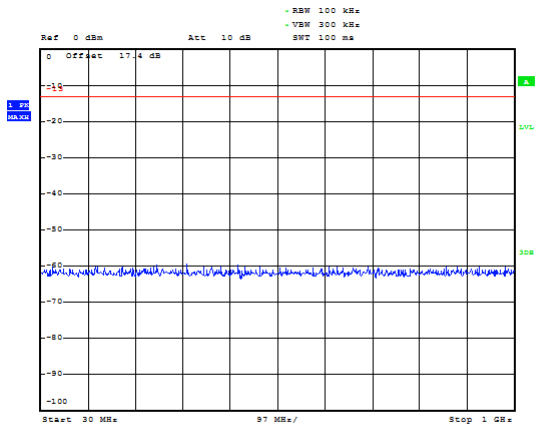

LTE Band 2 10MHz CH-Low 30MHz~1GHz

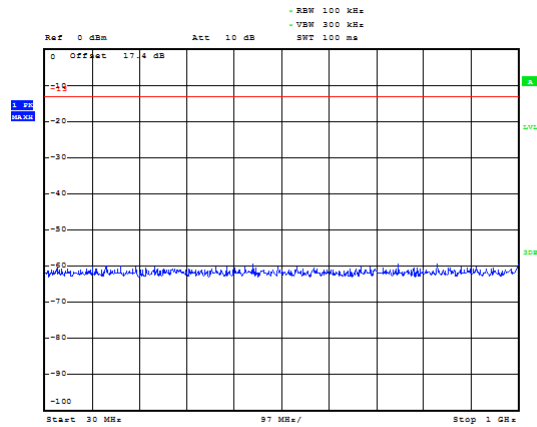

LTE Band 2 5MHz CH-High 1GHz~3GHz

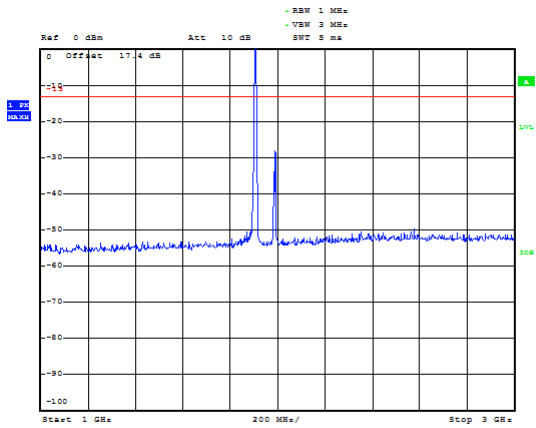

LTE Band 2 10MHz CH-Low 1GHz~3GHz

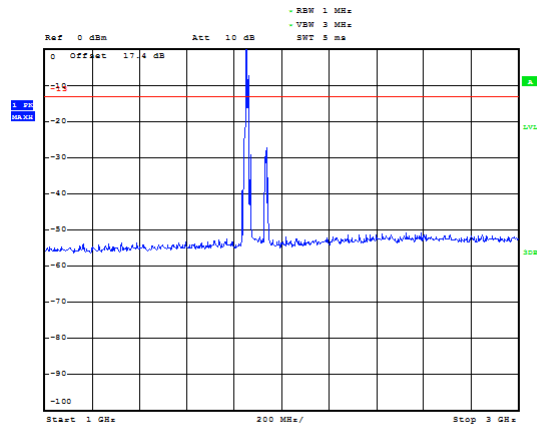

LTE Band 2 5MHz CH-High 3GHz~20GHz

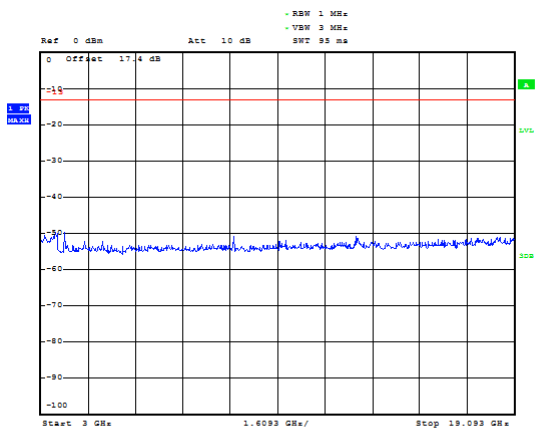

LTE Band 2 10MHz CH-Low 3GHz~20GHz

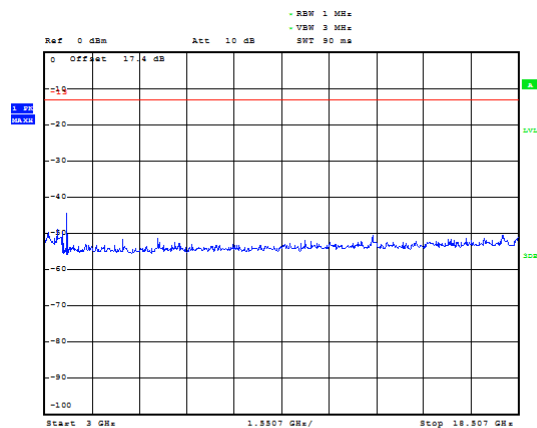



LTE Band 2 10MHz CH-Middle 30MHz~1GHz

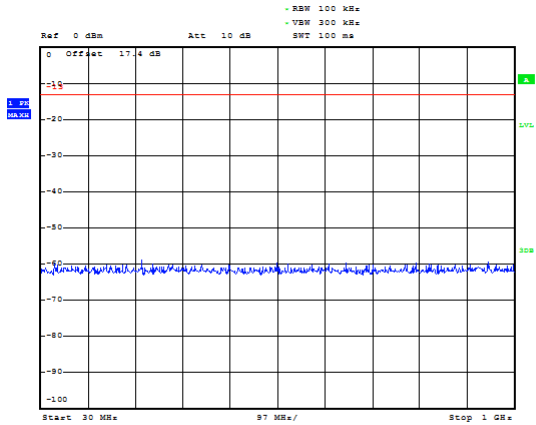

LTE Band 2 10MHz CH-High 30MHz~1GHz

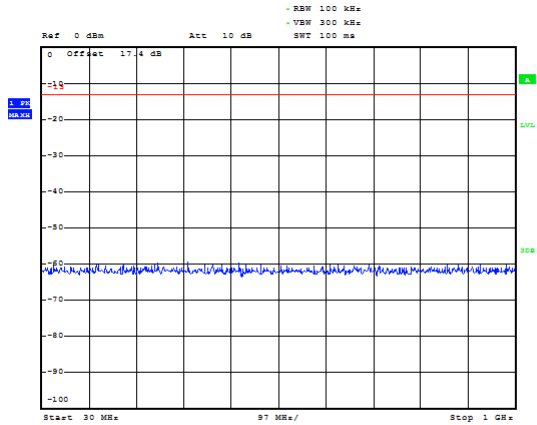

LTE Band 2 10MHz CH-Middle 1GHz~3GHz

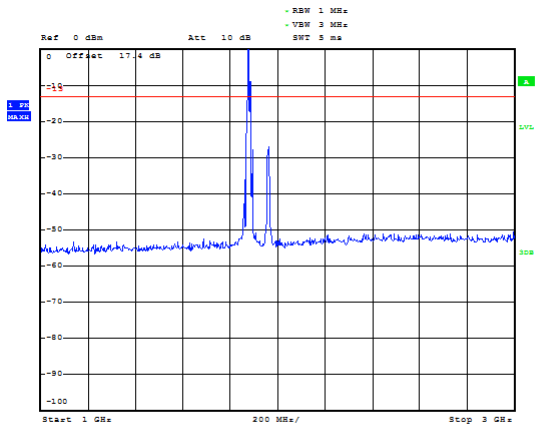

LTE Band 2 10MHz CH-High 1GHz~3GHz

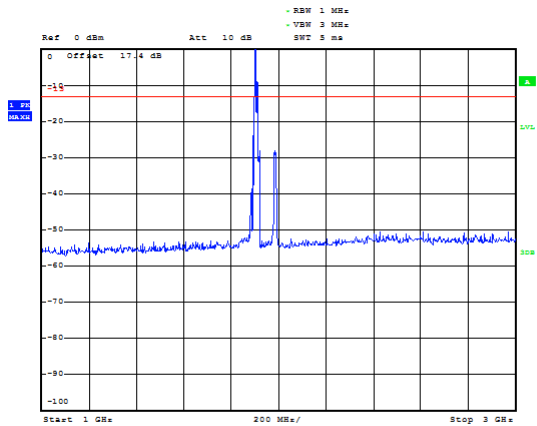

LTE Band 2 10MHz CH-Middle 3GHz~20GHz

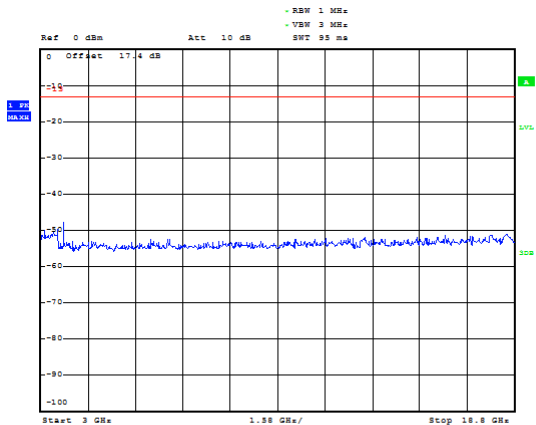

LTE Band 2 10MHz CH-High 3GHz~20GHz

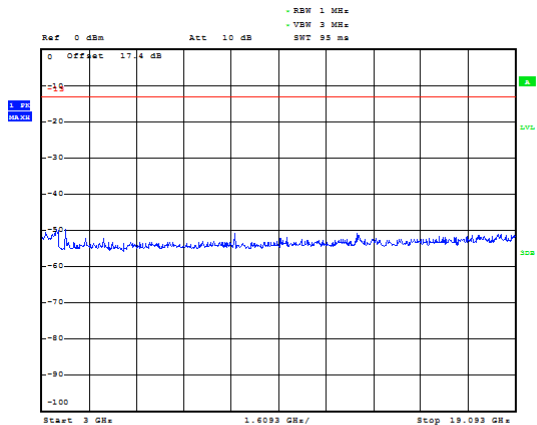



LTE Band 2 15MHz CH-Low 30MHz~1GHz

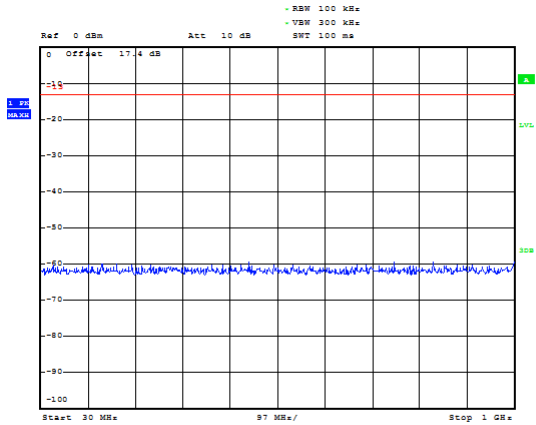

LTE Band 2 15MHz CH-Middle 30MHz~1GHz

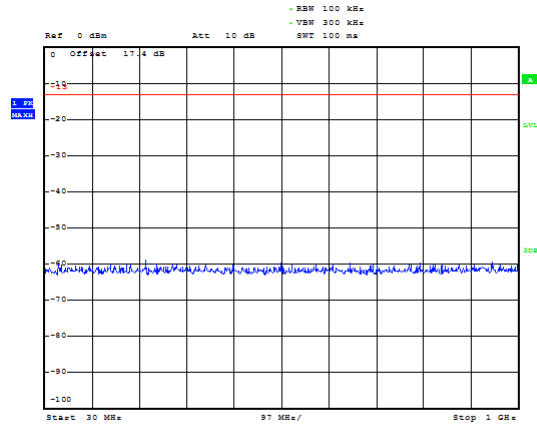

LTE Band 2 15MHz CH-Low 1GHz~3GHz

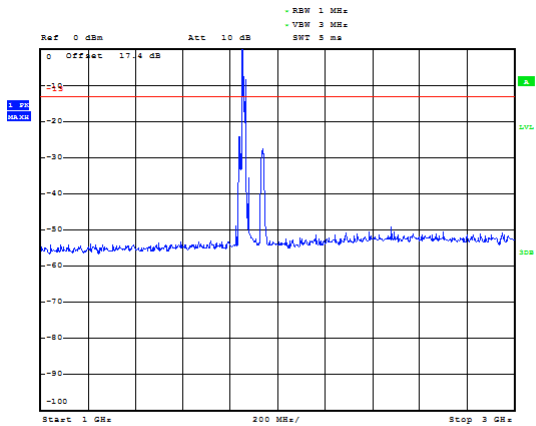

LTE Band 2 15MHz CH-Middle 1GHz~3GHz

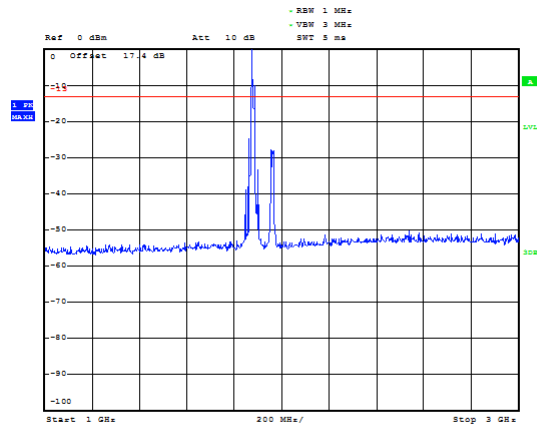

LTE Band 2 15MHz CH-Low 3GHz~20GHz

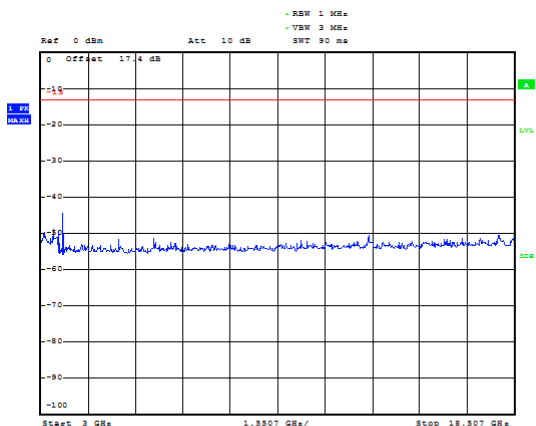

LTE Band 2 15MHz CH-Middle 3GHz~20GHz

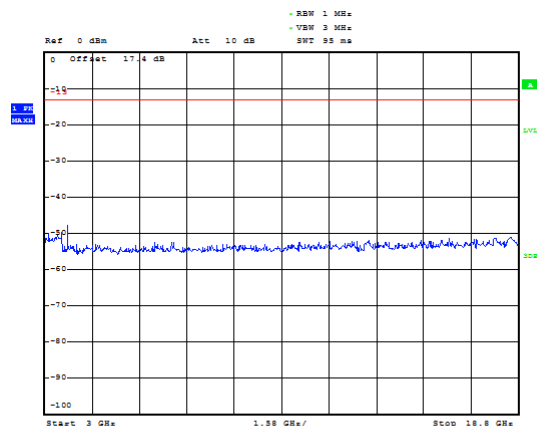



LTE Band 2 15MHz CH-High 30MHz~1GHz

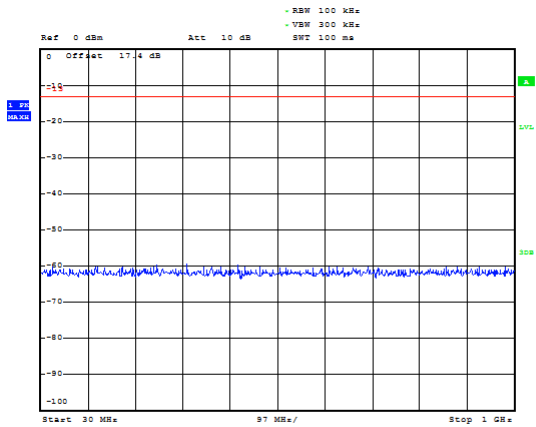

LTE Band 2 20MHz CH-Low 30MHz~1GHz

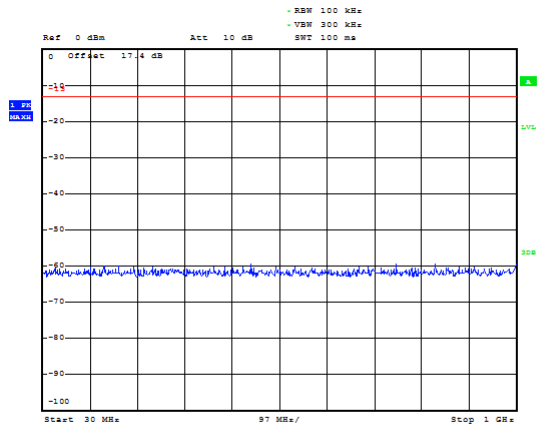

LTE Band 2 15MHz CH-High 1GHz~3GHz

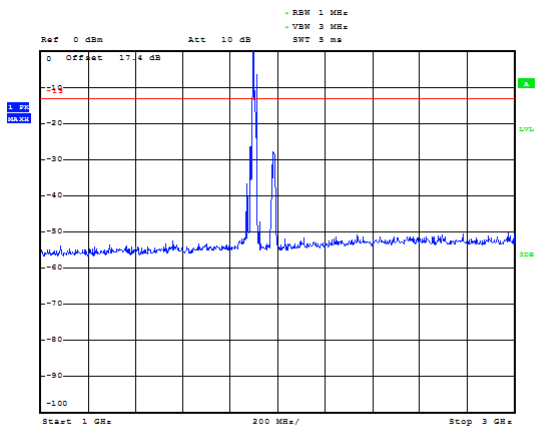

LTE Band 2 20MHz CH-Low 1GHz~3GHz

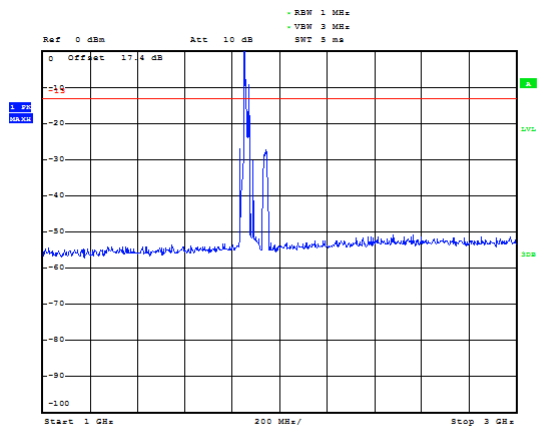

LTE Band 2 15MHz CH-High 3GHz~20GHz

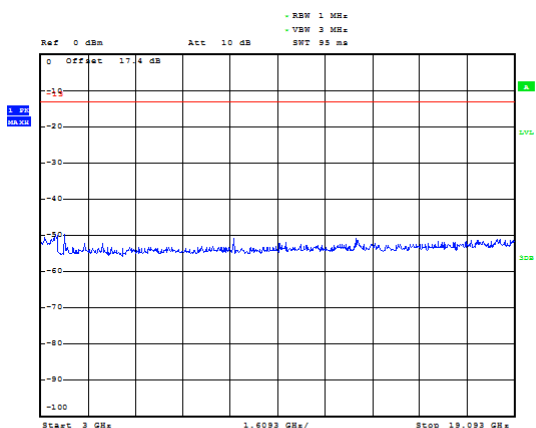

LTE Band 2 20MHz CH-Low 3GHz~20GHz

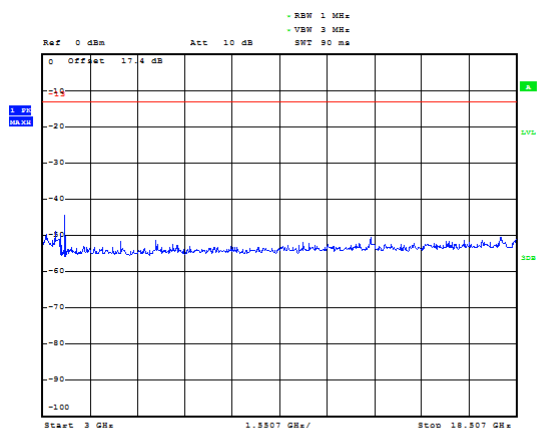



LTE Band 2 20MHz CH-Middle 30MHz~1GHz

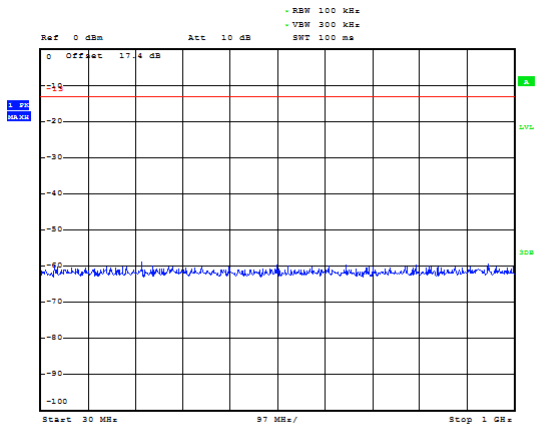

LTE Band 2 20MHz CH-High 30MHz~1GHz

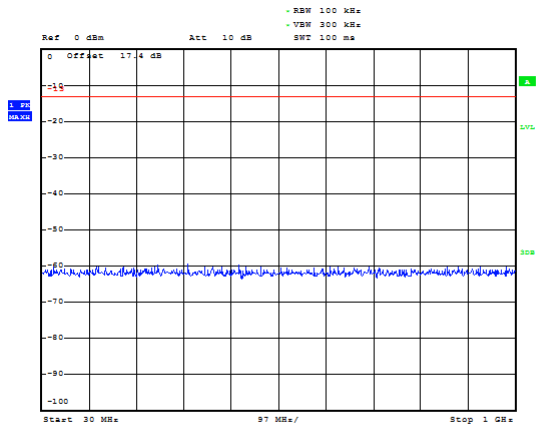

LTE Band 2 20MHz CH-Middle 1GHz~3GHz

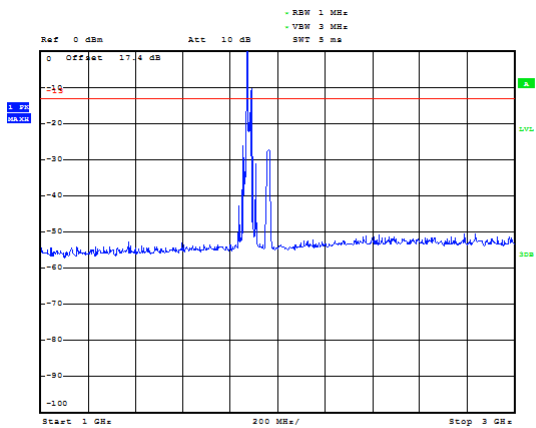

LTE Band 2 20MHz CH-High 1GHz~3GHz

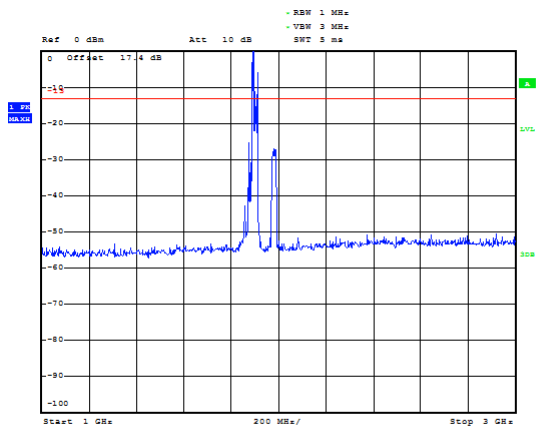

LTE Band 2 20MHz CH-Middle 3GHz~20GHz

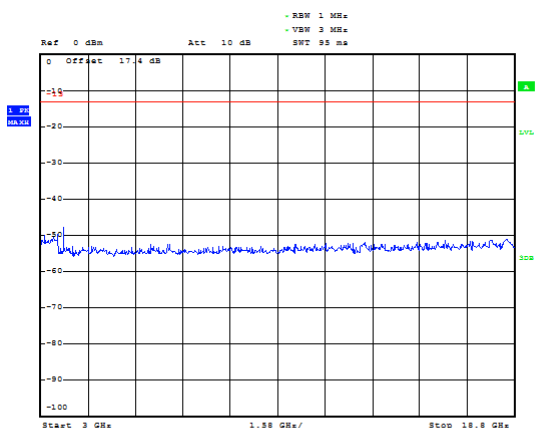

LTE Band 2 20MHz CH-High 3GHz~20GHz

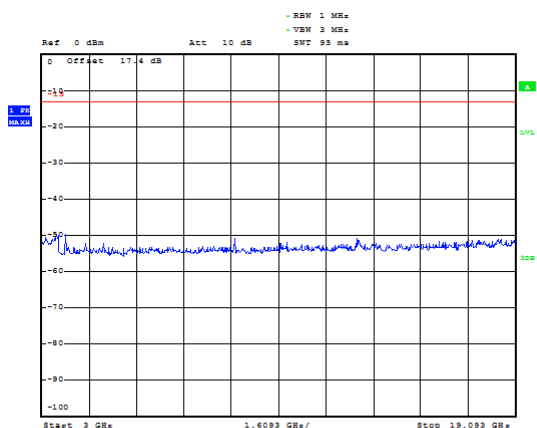

5.7. Radiates Spurious Emission

Ambient condition

Temperature	Relative humidity	Pressure
23°C ~25°C	45%~50%	101.5kPa

Method of Measurement

1. The testing follows FCC KDB 971168 v03r01 Section 5.8 and ANSI C63.26 (2015).
2. Below 1GHz: The EUT is placed on a turntable 0.8 meters above the ground in the chamber, 3 meter away from the antenna. The maximal emission value is acquired by adjusting the antenna height, polarisation and turntable azimuth. Normally, the height range of antenna is 1 m to 4 m, the azimuth range of turntable is 0° to 360°, and the receive antenna has two polarizations Vertical (V) and Horizontal (H). Above 1GHz: (Note: the FCC's permission to use 1.5m as an alternative per TCBC Conf call of Dec. 2, 2014.) The EUT is placed on a turntable 1.5 meters above the ground in the chamber, 3 meter away from the antenna. The maximal emission value is acquired by adjusting the antenna height, polarisation and turntable azimuth. Normally, the height range of antenna is 1 m to 4 m, the azimuth range of turntable is 0° to 360°, and the receive antenna has two polarizations Vertical (V) and Horizontal (H).
3. A loop antenna, A log-periodic antenna or horn antenna shall be substituted in place of the EUT. The log-periodic antenna will be driven by a signal generator and the level will be adjusted till the same power value on the spectrum analyzer or receiver. The level of the spurious emissions can be calculated through the level of the signal generator, cable loss, the gain of the substitution antenna and the reading of the spectrum analyzer or receiver.
4. The EUT is then put into continuously transmitting mode at its maximum power level during the test. Set Test Receiver or Spectrum RBW=1MHz, VBW=3MHz, and the maximum value of the receiver should be recorded as (Pr).
5. The EUT shall be replaced by a substitution antenna. In the chamber, an substitution antenna for the frequency band of interest is placed at the reference point of the chamber. An RF Signal source for the frequency band of interest is connected to the substitution antenna with a cable that has been constructed to not interfere with the radiation pattern of the antenna. A power (PMea) is applied to the input of the substitution antenna, and adjust the level of the signal generator output until the value of the receiver reach the previously recorded (Pr). The power of signal source (PMea) is recorded. The test should be performed by rotating the test item and adjusting the receiving antenna polarization.
6. A amplifier should be connected to the Signal Source output port. And the cable should be connect between the Amplifier and the Substitution Antenna. The cable loss (Pcl) ,the Substitution Antenna Gain (Ga) and the Amplifier Gain (PAg) should be recorded after test.
7. The measurement results are obtained as described below:
$$\text{Power(EIRP)} = \text{PMea} - \text{PAg} - \text{Pcl} + \text{Ga}$$

The measurement results are amend as described below:
$$\text{Power(EIRP)} = \text{PMea} - \text{Pcl} + \text{Ga}$$
8. This value is EIRP since the measurement is calibrated using an antenna of known gain (2.15 dBi) and known input power. ERP can be calculated from EIRP by subtracting the gain of the dipole, ERP

= EIRP-2.15dBi.

The modulation mode and RB allocation refer to section 5.1, using the maximum output power configuration.

Test setup

9KHz ~ 30MHz

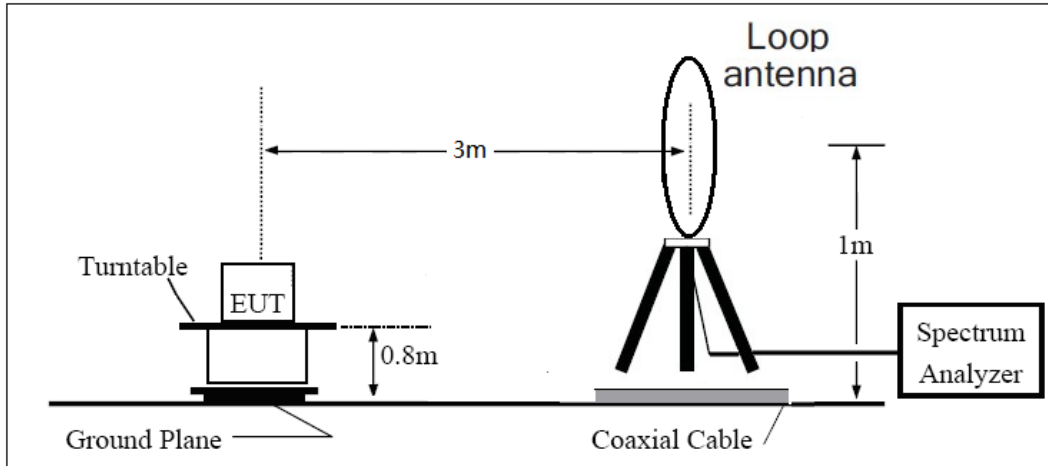

30MHz ~ 1GHz

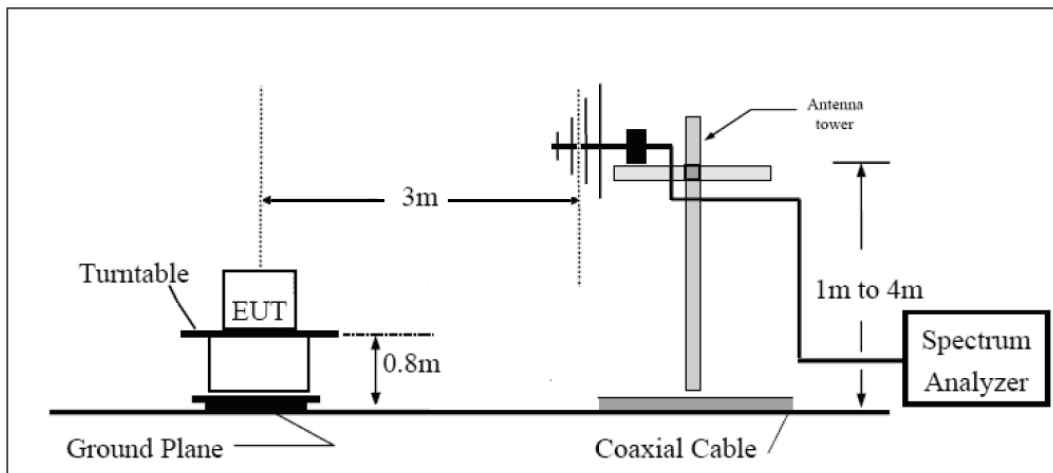

Above 1GHz

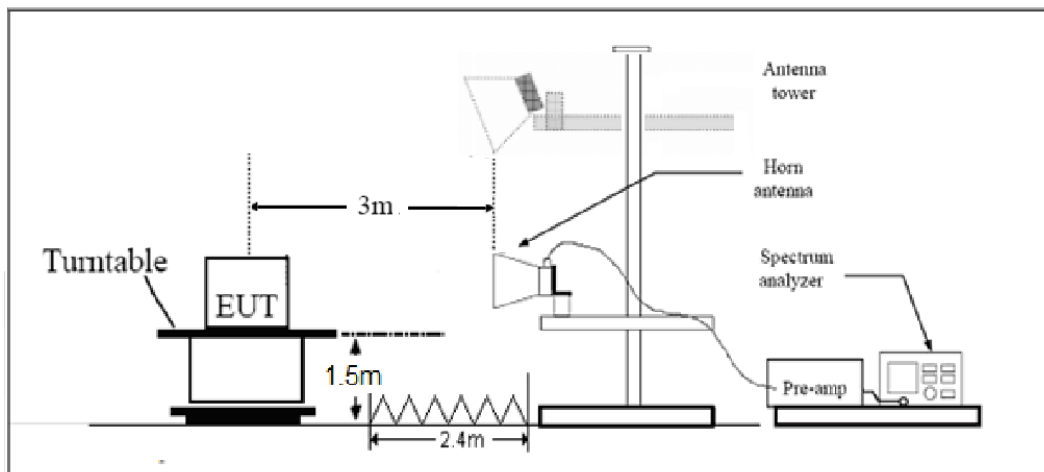

Note: Area side: 2.4mX3.6m

**Limits**

Rule Part 24.238(a) specifies that “on any frequency outside a licensee's frequency block, the power of any emission shall be attenuated below the transmitter power (P) by at least $43 + 10 \log_{10}(P)$ dB.”

Limit	-13 dBm
-------	---------

Measurement Uncertainty

The assessed measurement uncertainty to ensure 95% confidence level for the normal distribution is with the coverage factor $k = 1.96$, $U = 3.55$ dB.

Test Result

Sweep the whole frequency band through the range from 9kHz to the 10th harmonic of the carrier, the emissions below the noise floor will not be recorded in the report.

Variant

GSM 1900 CH-Middle

Harmonic	Frequency (MHz)	SG (dBm)	Cable Loss (dB)	Gain (dBi)	Antenna Polarization	EIRP Level (dBm)	Limit (dBm)	Margin (dB)	Azimuth (deg)
2	3760.0	-57.41	5.10	11.05	Horizontal	-51.46	-13.00	38.46	90
3	5640.0	-53.66	5.42	12.65	Horizontal	-46.43	-13.00	33.43	315
4	7520.0	-55.56	6.70	13.85	Horizontal	-48.41	-13.00	35.41	45
5	9400.0	-53.81	7.01	14.75	Horizontal	-46.07	-13.00	33.07	225
6	11280.0	-52.35	7.48	15.95	Horizontal	-43.88	-13.00	30.88	270
7	13160.0	-51.04	7.51	16.55	Horizontal	-42.00	-13.00	29.00	180
8	15040.0	-48.51	8.24	15.35	Horizontal	-41.40	-13.00	28.40	315
9	16920.0	-45.67	8.41	14.95	Horizontal	-39.13	-13.00	26.13	135
10	18800.0	/	/	/	/	/	/	/	/

Note: 1. The other Spurious RF Radiated emissions level is no more than noise floor.
 2. The worst emission was found in the antenna is Horizontal position.

WCDMA Band II CH-Middle

Harmonic	Frequency (MHz)	SG (dBm)	Cable Loss (dB)	Gain (dBi)	Antenna Polarization	EIRP Level (dBm)	Limit (dBm)	Margin (dB)	Azimuth (deg)
2	3760.0	-53.12	5.10	11.05	Horizontal	-47.17	-13.00	34.17	315
3	5640.0	-55.15	5.42	12.65	Horizontal	-47.92	-13.00	34.92	225
4	7520.0	-55.49	6.70	13.85	Horizontal	-48.34	-13.00	35.34	180
5	9400.0	-55.44	7.01	14.75	Horizontal	-47.70	-13.00	34.70	90
6	11280.0	-53.17	7.48	15.95	Horizontal	-44.70	-13.00	31.70	135
7	13160.0	-52.59	7.51	16.55	Horizontal	-43.55	-13.00	30.55	0
8	15040.0	-49.91	8.24	15.35	Horizontal	-42.80	-13.00	29.80	45
9	16920.0	-46.76	8.41	14.95	Horizontal	-40.22	-13.00	27.22	180
10	18800.0	/	/	/	/	/	/	/	/

Note: 1. The other Spurious RF Radiated emissions level is no more than noise floor.
 2. The worst emission was found in the antenna is Horizontal position.



LTE Band 2 1.4MHz CH-Middle

Harmonic	Frequency (MHz)	SG (dBm)	Cable Loss (dB)	Gain (dBi)	Antenna Polarization	EIRP Level (dBm)	Limit (dBm)	Margin (dB)	Azimuth (deg)
2	3759.0	-48.46	5.10	11.05	Horizontal	-42.51	-13.00	29.51	315
3	5638.9	-54.63	5.42	12.65	Horizontal	-47.40	-13.00	34.40	270
4	7520.0	-52.59	6.70	13.85	Horizontal	-45.44	-13.00	32.44	180
5	9400.0	-50.65	7.01	14.75	Horizontal	-42.91	-13.00	29.91	315
6	11280.0	-53.17	7.48	15.95	Horizontal	-44.70	-13.00	31.70	0
7	13160.0	-51.26	7.51	16.55	Horizontal	-42.22	-13.00	29.22	45
8	15040.0	-49.43	8.24	15.35	Horizontal	-42.32	-13.00	29.32	90
9	16920.0	-45.96	8.41	14.95	Horizontal	-39.42	-13.00	26.42	225
10	18800.0	/	/	/	/	/	/	/	/

Note: 1. The other Spurious RF Radiated emissions level is no more than noise floor.

2. The worst emission was found in the antenna is Horizontal position.

LTE Band 2 5MHz CH-Middle

Harmonic	Frequency (MHz)	SG (dBm)	Cable Loss (dB)	Gain (dBi)	Antenna Polarization	EIRP Level (dBm)	Limit (dBm)	Margin (dB)	Azimuth (deg)
2	3755.6	-48.73	5.10	11.05	Horizontal	-42.78	-13.00	29.78	270
3	5633.6	-55.14	5.42	12.65	Horizontal	-47.91	-13.00	34.91	180
4	7520.0	-53.92	6.70	13.85	Horizontal	-46.77	-13.00	33.77	45
5	9400.0	-50.88	7.01	14.75	Horizontal	-43.14	-13.00	30.14	135
6	11280.0	-53.28	7.48	15.95	Horizontal	-44.81	-13.00	31.81	90
7	13160.0	-50.02	7.51	16.55	Horizontal	-40.98	-13.00	27.98	225
8	15040.0	-50.73	8.24	15.35	Horizontal	-43.62	-13.00	30.62	315
9	16920.0	-46.51	8.41	14.95	Horizontal	-39.97	-13.00	26.97	0
10	18800.0	/	/	/	/	/	/	/	/

Note: 1. The other Spurious RF Radiated emissions level is no more than noise floor.

2. The worst emission was found in the antenna is Horizontal position.



LTE Band 2 20MHz CH-Middle

Harmonic	Frequency (MHz)	SG (dBm)	Cable Loss (dB)	Gain (dBi)	Antenna Polarization	EIRP Level (dBm)	Limit (dBm)	Margin (dB)	Azimuth (deg)
2	3742.1	-49.53	5.10	11.05	Horizontal	-43.58	-13.00	30.58	180
3	5613.4	-51.05	5.42	12.65	Horizontal	-43.82	-13.00	30.82	225
4	7484.6	-54.17	6.70	13.85	Horizontal	-47.02	-13.00	34.02	315
5	9355.9	-52.32	7.01	14.75	Horizontal	-44.58	-13.00	31.58	180
6	11227.1	-53.43	7.48	15.95	Horizontal	-44.96	-13.00	31.96	135
7	13098.4	-52.15	7.51	16.55	Horizontal	-43.11	-13.00	30.11	90
8	14969.6	-49.97	8.24	15.35	Horizontal	-42.86	-13.00	29.86	45
9	16840.9	-46.92	8.41	14.95	Horizontal	-40.38	-13.00	27.38	270
10	18800.0	/	/	/	/	/	/	/	/

Note: 1. The other Spurious RF Radiated emissions level is no more than noise floor.

2. The worst emission was found in the antenna is Horizontal position.

6. Main Test Instruments

Name	Manufacturer	Type	Serial Number	Calibration Date	Expiration Date
Base Station Simulator	R&S	CMU200	118133	2017-05-21	2018-05-20
Base Station Simulator	R&S	CMU200	118133	2018-05-20	2019-05-19
Base Station Simulator	R&S	CMU200	118133	2019-05-19	2020-05-18
Base Station Simulator	R&S	CMW500	113824	2017-05-21	2018-05-20
Base Station Simulator	R&S	CMW500	113824	2018-05-20	2019-05-19
Base Station Simulator	R&S	CMW500	113824	2019-05-19	2020-05-18
Power Splitter	Hua Xiang	SHX-GF2-2-13	10120101	/	/
Spectrum Analyzer	Key sight	N9010A	MY50210259	2017-05-21	2018-05-20
Spectrum Analyzer	Key sight	N9010A	MY50210259	2018-05-20	2019-05-19
Spectrum Analyzer	Key sight	N9010A	MY50210259	2019-05-19	2020-05-18
Universal Radio Communication Tester	Key sight	E5515C	MY48367192	2017-05-21	2018-05-20
Universal Radio Communication Tester	Key sight	E5515C	MY48367192	2018-05-20	2019-05-19
Universal Radio Communication Tester	Key sight	E5515C	MY48367192	2019-05-19	2020-05-18
Signal Analyzer	R&S	FSV30	100815	2017-12-17	2018-12-16
Signal Analyzer	R&S	FSV30	100815	2018-12-16	2019-12-15
Signal Analyzer	R&S	FSV30	100815	2019-12-15	2020-12-14
Loop Antenna	SCHWARZBECK	FMZB1519	1519-047	2017-09-26	2020-09-25
Trilog Antenna	SCHWARZBECK	VUBL 9163	9163-201	2017-11-18	2020-11-17
Horn Antenna	R&S	HF907	100126	2016-07-08	2018-07-07



Horn Antenna	R&S	HF907	100126	2018-07-07	2020-07-06
Horn Antenna	ETS-Lindgren	3160-09	00102643	2016-06-21	2018-06-20
Horn Antenna	ETS-Lindgren	3160-09	00102643	2018-06-20	2020-06-19
Signal generator	R&S	SMB 100A	102594	2017-05-21	2018-05-20
Signal generator	R&S	SMB 100A	102594	2018-05-20	2019-05-19
Signal generator	R&S	SMB 100A	102594	2019-05-19	2020-05-18
Climatic Chamber	ESPEC	SU-242	93000506	2017-12-17	2020-12-16
Preampfler	R&S	SCU18	102327	2017-05-21	2018-05-20
Preampfler	R&S	SCU18	102327	2018-05-20	2019-05-19
Preampfler	R&S	SCU18	102327	2019-05-19	2020-05-18
MOB COMMS DC SUPPLY	Keysight	66319D	MY43004105	2017-05-21	2018-05-20
MOB COMMS DC SUPPLY	Keysight	66319D	MY43004105	2018-05-20	2019-05-19
MOB COMMS DC SUPPLY	Keysight	66319D	MY43004105	2019-05-19	2020-05-18
RF Cable	Agilent	SMA 15cm	0001	2017-12-17	2018-06-16
RF Cable	Agilent	SMA 15cm	0001	2018-06-16	2018-12-15
RF Cable	Agilent	SMA 15cm	0001	2018-12-15	2019-06-14
RF Cable	Agilent	SMA 15cm	0001	2019-06-14	2019-12-13
RF Cable	Agilent	SMA 15cm	0001	2019-12-13	2020-06-12
Software	R&S	EMC32	9.26.0	/	/

*****END OF REPORT *****



ANNEX A: The EUT Appearance

The EUT Appearance are submitted separately.



ANNEX B: Test Setup Photos

The Test Setup Photos are submitted separately.



ANNEX C: Product Change Description

The Product Change Description are submitted separately.



ANNEX D: Verify data

The Verify data are submitted separately.