



RF TEST REPORT

Applicant Quectel Wireless Solutions Co., Ltd
FCC ID XMR202006EC25AUX
Product LTE Module
Brand Quectel
Model EC25-AUX, EC25-AUX MINIPCIE
Report No. R2108A0762-R1
Issue Date December 1, 2021

TA Technology (Shanghai) Co., Ltd. tested the above equipment in accordance with the requirements in **FCC CFR47 Part 2 (2020)/ FCC CFR 47 Part 22H (2020)**. The test results show that the equipment tested is capable of demonstrating compliance with the requirements as documented in this report.

Performed by: Peng Tao

Approved by: Kai Xu

TA Technology (Shanghai) Co., Ltd.

No.145, Jintang Rd, Tangzhen Industry Park, Pudong Shanghai, China

TEL: +86-021-50791141/2/3

FAX: +86-021-50791141/2/3-8000



TABLE OF CONTENT

1. Test Laboratory	4
1.1. Notes of the Test Report	4
1.2. Test facility	4
1.3. Testing Location	4
2. General Description of Equipment under Test.....	5
2.3. Applicant and Manufacturer Information	5
2.4. General Information.....	5
3. Applied Standards	7
4. Test Configuration.....	8
5. Test Case Results.....	10
5.1. RF Power Output and Effective Radiated Power	10
5.2. Occupied Bandwidth	18
5.3. Band Edge Compliance.....	27
5.4. Peak-to-Average Power Ratio (PAPR)	35
5.5. Frequency Stability.....	38
5.6. Spurious Emissions at Antenna Terminals	44
5.7. Radiates Spurious Emission	51
6. Main Test Instruments	57
ANNEX A: The EUT Appearance	59
ANNEX B: Test Setup Photos	60
ANNEX C: Product Change Description	61
ANNEX D: Verify data	62



Summary of measurement results

No.	Test Case	Clause in FCC rules	Verdict
1	RF Power Output and Effective Radiated Power	2.1046 22.913(a)(5)	PASS
2	Occupied Bandwidth	2.1049	PASS
3	Band Edge Compliance	2.1051 / 22.917(a)	PASS
4	Peak-to-Average Power Ratio	22.913(d)/ KDB 971168 D01(5.7)	PASS
5	Frequency Stability	2.1055 / 22.355	PASS
6	Spurious Emissions at Antenna Terminals	2.1051 / 22.917(a)	PASS
7	Radiates Spurious Emission	2.1053 / 22.917 (a)	PASS
Date of Testing: April 12, 2018~ April 18, 2018 and May 12, 2020~ May 13, 2020			
Note: All indications of Pass/Fail in this report are opinions expressed by TA Technology (Shanghai) Co., Ltd. based on interpretations and/or observations of test results. Measurement Uncertainties were not taken into account and are published for informational purposes only.			

EC25-AUX, EC25-AUX MINIPCIE (Report No.: R2108A0762-R1) is a variant model of EC25-AUX, EC25-AUX MINIPCIE (Report No.: R2005A0269-R1). There is only changed the Power Amplifier and Software Version of product.

Tested cases refer to the following table. Please refer to Appendix C for Verify data

Test Case	Original	Variant
RF Power Output and Effective Radiated Power	PASS	Retest(GSM850 /WCDMA Band V/ LTE band5)
Occupied Bandwidth	PASS	Verify the worst combination of each frequency band(GSM850 / WCDMA Band V/ LTE band5)
Band Edge Compliance	PASS	Verify the worst combination of each frequency band(GSM850 / WCDMA Band V/ LTE band5)
Peak-to-Average Power Ratio	PASS	Retest(GSM850 / WCDMA Band V/ LTE band 5)
Frequency Stability	PASS	Retest(GSM850 / WCDMA Band V/ LTE band 5)
Spurious Emissions at Antenna Terminals	PASS	Verify the worst combination of each frequency band(GSM850 / WCDMA Band V/ LTE band5)
Radiates Spurious Emission	PASS	Retest(GSM850 / WCDMA Band V/ LTE band 5)

The detailed product change description please refers to the Difference Declaration Letter.



1. Test Laboratory

1.1. Notes of the Test Report

This report shall not be reproduced in full or partial, without the written approval of **TA technology (shanghai) co., Ltd.** The results documented in this report apply only to the tested sample, under the conditions and modes of operation as described herein .Measurement Uncertainties were not taken into account and are published for informational purposes only. This report is written to support regulatory compliance of the applicable standards stated above.

1.2. Test facility

FCC (Designation number: CN1179, Test Firm Registration Number: 446626)

TA Technology (Shanghai) Co., Ltd. has been listed on the US Federal Communications Commission list of test facilities recognized to perform electromagnetic emissions measurements.

A2LA (Certificate Number: 3857.01)

TA Technology (Shanghai) Co., Ltd. has been listed by American Association for Laboratory Accreditation to perform electromagnetic emission measurement.

1.3. Testing Location

Company: TA Technology (Shanghai) Co., Ltd.
Address: No.145, Jintang Rd, Tangzhen Industry Park, Pudong
City: Shanghai
Post code: 201201
Country: P. R. China
Contact: Xu Kai
Telephone: +86-021-50791141/2/3
Fax: +86-021-50791141/2/3-8000
Website: <http://www.ta-shanghai.com>
E-mail: xukai@ta-shanghai.com

2. General Description of Equipment under Test

2.3. Applicant and Manufacturer Information

Applicant	Quectel Wireless Solutions Co., Ltd
Applicant address	Building 5, Shanghai Business Park Phase III (Area B), No.1016 Tianlin Road, Minhang District, Shanghai, China 200233
Manufacturer	Quectel Wireless Solutions Co., Ltd
Manufacturer address	Building 5, Shanghai Business Park Phase III (Area B), No.1016 Tianlin Road, Minhang District, Shanghai, China 200233

2.4. General Information

EUT Description			
Model	EC25-AUX, EC25-AUX MINIPCIE		
IMEI:	862708040005709		
Hardware Version	R2.0		
Software Version	EC25AUXGAR08A05M1G		
Power Supply	External supply power		
Antenna Type	The EUT don't have standard Antenna, The Antenna used for testing in this report is the after-market accessory (Dipole Antenna)		
Antenna Gain	1.89dBi		
Test Mode(s)	GSM 850; WCDMA Band V; LTE Band 5;		
Test Modulation	(GSM)GMSK, 8PSK; (WCDMA) BPSK, QPSK; (LTE)QPSK 16QAM;		
GPRS Multislot Class	33		
EGPRS Multislot Class	33		
HSDPA UE Category	24		
HSUPA UE Category	6		
DC-HSDPA UE Category	24		
LTE Category	4		
Maximum E.R.P.	GSM 850:	32.42dBm	
	WCDMA Band V:	23.47dBm	
	LTE Band 5:	23.47dBm	
Rated Power Supply Voltage	3.8 V		
Extreme Voltage	Minimum: 3.3 V Maximum: 4.3V		
Extreme Temperature	Lowest: -40°C Highest: +85°C		
Operating Frequency Range(s)	Band	Tx (MHz)	Rx (MHz)
	GSM850	824 ~ 849	869 ~ 894
	WCDMA Band V	824 ~ 849	869 ~ 894



	LTE Band 5	824 ~ 849	869 ~ 894
Note: 1. The EUT is sent from the applicant to TA and the information of the EUT is declared by the applicant.			

The series model number is: EC25-AUX MINIPCIE. The difference of these models are have different marketing requirement.



3. Applied Standards

According to the specifications of the manufacturer, it must comply with the requirements of the following standards:

Test standards:

FCC CFR 47 Part 22H (2020)

FCC CFR47 Part 2 (2020)

Reference standard:

ANSI C63.26 (2015)

KDB 971168 D01 Power Meas License Digital Systems v03r01

4. Test Configuration

Radiated measurements are performed by rotating the EUT in three different orthogonal test planes. EUT stand-up position (Z axis), lie-down position (X, Y axis). Receiver antenna polarization (horizontal and vertical), the worst emission was found in position (Z axis, horizontal polarization) and the worst case was recorded.

All mode and data rates and positions were investigated. Subsequently, only the worst case emissions are reported.

The following testing in GSM/WCDMA/LTE is set based on the maximum RF Output Power.

Test modes are chosen to be reported as the worst case configuration below:

Test items	Modes/Modulation	
	GSM 850	WCDMA Band V
RF Power Output and Effective Radiated power	GSM GPRS EGPRS	RMC HSDPA/HSUPA DC-HSDPA
Occupied Bandwidth	GSM GPRS(1Tx slot) EGPRS(1Tx slot)	RMC
Band Edge Compliance	GSM GPRS(1Tx slot) EGPRS(1Tx slot)	RMC
Peak-to-Average Power Ratio	GSM GPRS(1Tx slot) EGPRS(1Tx slot)	RMC
Frequency Stability	GSM GPRS(1Tx slot) EGPRS(1Tx slot)	RMC
Spurious Emissions at Antenna Terminals	GSM	RMC
Radiates Spurious Emission	GSM	RMC

Test modes are chosen as the worst case configuration below for LTE Band 5.

Test items	Bandwidth (MHz)				Modulation		RB			Test Channel		
	1.4	3	5	10	QPSK	16QAM	1	50%	100%	L	M	H
RF power output and Effective Radiated power	○	○	○	○	○	○	○	○	○	○	○	○
Occupied Bandwidth	○	○	○	○	○	○	-	-	○	-	○	-
Band Edge Compliance	○	○	○	○	○	○	○	-	○	○	-	○



Peak-to-Average Power Ratio	O	O	O	O	O	O	-	-	O	O	O	O
Frequency Stability	O	O	O	O	O	O	O	O	O	O	O	O
Spurious Emissions at Antenna Terminals	O	O	O	O	O	-	O	-	-	O	O	O
Radiates Spurious Emission	O	-	O	O	O	-	O	-	-	-	O	-
Note	1. The mark "O" means that this configuration is chosen for testing. 2. The mark "-" means that this configuration is not testing.											

5. Test Case Results

5.1. RF Power Output and Effective Radiated Power

Ambient condition

Temperature	Relative humidity	Pressure
23°C ~25°C	45%~50%	101.5kPa

Methods of Measurement

During the process of the testing, The EUT is controlled by the Base Station Simulator to ensure max power transmission and proper modulation.

The testing follows FCC KDB 971168 v03r01 Section 5.8 and ANSI C63.26 (2015).

- a) Connect the equipment as illustrated. Mount the equipment with the manufacturer specified antenna in a vertical orientation on a manufacturer specified mounting surface located on a non-conducting rotating platform of a RF anechoic chamber (preferred) or a standard radiation site.
- b) Key the transmitter, then rotate the EUT 360° azimuthally and record spectrum analyzer power level (LVL) measurements at angular increments that are sufficiently small to permit resolution of all peaks. If a standard radiation test site is used, raise and lower the test antenna to obtain a maximum reading at each angular increment. (Note: several batteries may be needed to offset the effect of battery voltage droop, which should not exceed 5% of the manufactured specified battery voltage during transmission).
- c) Replace the transmitter under test with a vertically polarized half-wave dipole (or an antenna whose gain is known relative to an ideal half-wave dipole). The center of the antenna should be at the same location as the center of the antenna under test.
- d) Connect the antenna to a signal generator with a known output power and record the path loss (in dB) as LOSS. If a standard radiation test site is used, raise and lower the test antenna to obtain a maximum reading. $LOSS = \text{Generator Output Power (dBm)} - \text{Analyzer reading (dBm)}$
- e) Determine the effective radiated output power at each angular position from the readings in steps b) and d) using the following equation: $ERP \text{ (dBm)} = \text{LVL (dBm)} + \text{LOSS (dB)}$
- f) The maximum ERP is the maximum value determined in the preceding step.
- g) When calculating ERP, in addition to knowing the antenna radiation and matching characteristics, it is necessary to know the loss values of all elements (e.g. transmission line attenuation, mismatches, filters, combiners) interposed between the point where transmitter output power is measured, and the point where power is applied to the antenna. ERP can then be calculated as follows:
 $EIRP \text{ (dBm)} = \text{Output Power (dBm)} - \text{Losses (dB)} + \text{Antenna Gain (dBi)}$
 where: dBd refers to gain relative to an ideal dipole.
 $EIRP \text{ (dBm)} = ERP \text{ (dBm)} + 2.15 \text{ (dB.)}$

The RB allocation refers to section 5.1, using the maximum output power configuration.

Test Setup

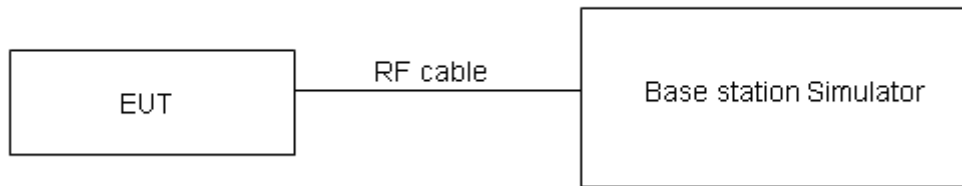

The loss between RF output port of the EUT and the input port of the tester has been taken into consideration.

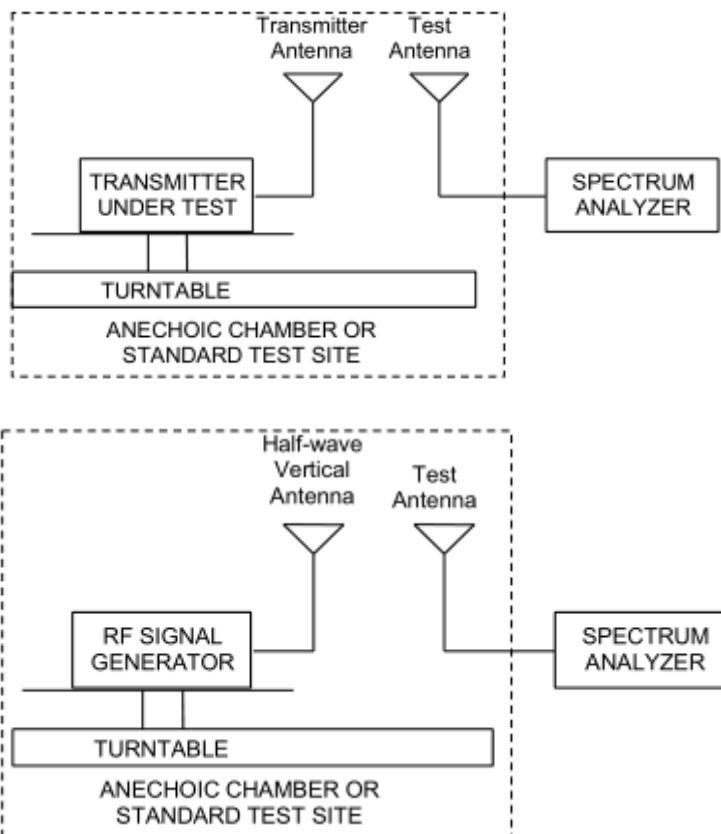

Limits

No specific RF power output requirements in part 2.1046.

Rule Part 22.913(a)(5) specifies that "Mobile/portable stations are limited to 7 watts ERP".

Limit	$\leq 7 \text{ W}$ (38.45 dBm)
-------	--------------------------------

Measurement Uncertainty

The assessed measurement uncertainty to ensure 95% confidence level for the normal distribution is with the coverage factor $k = 2$, $U = 0.4 \text{ dB}$ for RF power output, $k = 2$, $U = 1.19 \text{ dB}$ for ERP .

Test Results

GSM 850		Conducted Power (dBm)			ERP (dBm)		
		Channel 128	Channel 190	Channel 251	Channel 128	Channel 190	Channel 251
		824.2 (MHz)	836.6 (MHz)	848.8 (MHz)	824.2 (MHz)	836.6 (MHz)	848.8 (MHz)
GSM	Results	32.38	32.54	32.65	32.12	32.28	32.39
GPRS/EGPRS (GMSK)	1TXslot	32.50	32.61	32.68	32.24	32.35	32.42
	2TXslots	32.07	32.15	32.28	31.81	31.89	32.02
	3TXslots	29.66	29.91	30.03	29.40	29.65	29.77
	4TXslots	28.62	28.78	29.01	28.36	28.52	28.75
EGPRS (8PSK)	1TXslot	25.91	26.19	26.21	25.65	25.93	25.95
	2TXslots	25.73	25.87	25.96	25.47	25.61	25.70
	3TXslots	23.47	23.98	24.02	23.21	23.72	23.76
	4TXslots	22.54	22.76	22.92	22.28	22.50	22.66

WCDMA Band V		Conducted Power (dBm)			ERP (dBm)		
		Channel 4132	Channel 4183	Channel 4233	Channel 4132	Channel 4183	Channel 4233
		826.4 (MHz)	836.6 (MHz)	846.6 (MHz)	826.4 (MHz)	836.6 (MHz)	846.6 (MHz)
RMC	12.2k	23.69	23.73	23.71	23.43	23.47	23.45
HSDPA	Sub - Test 1	23.15	23.15	23.15	22.89	22.89	22.89
	Sub - Test 2	23.14	23.17	23.12	22.88	22.91	22.86
	Sub - Test 3	22.61	22.67	22.64	22.35	22.41	22.38
	Sub - Test 4	22.62	22.68	22.62	22.36	22.42	22.36
HSUPA	Sub - Test 1	23.11	23.14	23.10	22.85	22.88	22.84
	Sub - Test 2	22.10	22.12	22.09	21.84	21.86	21.83
	Sub - Test 3	22.57	22.60	22.58	22.31	22.34	22.32
	Sub - Test 4	22.03	22.09	22.06	21.77	21.83	21.80
	Sub - Test 5	23.04	23.07	23.04	22.78	22.81	22.78
DC-HSDPA	Sub - Test 1	23.03	23.09	23.05	22.77	22.83	22.79
	Sub - Test 2	23.02	23.08	23.04	22.76	22.82	22.78
	Sub - Test 3	22.60	22.57	22.55	22.34	22.31	22.29
	Sub - Test 4	22.59	22.56	22.54	22.33	22.30	22.28



Band	Bandwidth (MHz)	UL Channel	RB Size	RB Position	Modulation	Power (dBm)	ERP (dBm)	Verdict
LTE Band5	1.4	20407	1	#0	QPSK	23.57	23.31	PASS
LTE Band5	1.4	20407	1	#Mid	QPSK	23.73	23.47	PASS
LTE Band5	1.4	20407	1	#Max	QPSK	23.57	23.31	PASS
LTE Band5	1.4	20407	3	#0	QPSK	23.67	23.41	PASS
LTE Band5	1.4	20407	3	#Mid	QPSK	23.72	23.46	PASS
LTE Band5	1.4	20407	3	#Max	QPSK	23.68	23.42	PASS
LTE Band5	1.4	20407	6	#0	QPSK	22.51	22.25	PASS
LTE Band5	1.4	20407	1	#0	QAM16	22.63	22.37	PASS
LTE Band5	1.4	20407	1	#Mid	QAM16	22.69	22.43	PASS
LTE Band5	1.4	20407	1	#Max	QAM16	22.46	22.20	PASS
LTE Band5	1.4	20407	3	#0	QAM16	22.44	22.18	PASS
LTE Band5	1.4	20407	3	#Mid	QAM16	22.43	22.17	PASS
LTE Band5	1.4	20407	3	#Max	QAM16	22.44	22.18	PASS
LTE Band5	1.4	20407	6	#0	QAM16	21.36	21.10	PASS
LTE Band5	1.4	20525	1	#0	QPSK	23.52	23.26	PASS
LTE Band5	1.4	20525	1	#Mid	QPSK	23.67	23.41	PASS
LTE Band5	1.4	20525	1	#Max	QPSK	23.46	23.20	PASS
LTE Band5	1.4	20525	3	#0	QPSK	23.49	23.23	PASS
LTE Band5	1.4	20525	3	#Mid	QPSK	23.48	23.22	PASS
LTE Band5	1.4	20525	3	#Max	QPSK	23.63	23.37	PASS
LTE Band5	1.4	20525	6	#0	QPSK	22.53	22.27	PASS
LTE Band5	1.4	20525	1	#0	QAM16	22.77	22.51	PASS
LTE Band5	1.4	20525	1	#Mid	QAM16	22.93	22.67	PASS
LTE Band5	1.4	20525	1	#Max	QAM16	22.78	22.52	PASS
LTE Band5	1.4	20525	3	#0	QAM16	22.69	22.43	PASS
LTE Band5	1.4	20525	3	#Mid	QAM16	22.69	22.43	PASS
LTE Band5	1.4	20525	3	#Max	QAM16	22.78	22.52	PASS
LTE Band5	1.4	20525	6	#0	QAM16	21.46	21.20	PASS
LTE Band5	1.4	20643	1	#0	QPSK	23.48	23.22	PASS
LTE Band5	1.4	20643	1	#Mid	QPSK	23.63	23.37	PASS
LTE Band5	1.4	20643	1	#Max	QPSK	23.38	23.12	PASS
LTE Band5	1.4	20643	3	#0	QPSK	23.49	23.23	PASS
LTE Band5	1.4	20643	3	#Mid	QPSK	23.49	23.23	PASS
LTE Band5	1.4	20643	3	#Max	QPSK	23.40	23.14	PASS
LTE Band5	1.4	20643	6	#0	QPSK	22.45	22.19	PASS
LTE Band5	1.4	20643	1	#0	QAM16	22.41	22.15	PASS
LTE Band5	1.4	20643	1	#Mid	QAM16	22.77	22.51	PASS
LTE Band5	1.4	20643	1	#Max	QAM16	22.56	22.30	PASS
LTE Band5	1.4	20643	3	#0	QAM16	22.79	22.53	PASS
LTE Band5	1.4	20643	3	#Mid	QAM16	22.79	22.53	PASS



LTE Band5	1.4	20643	3	#Max	QAM16	22.73	22.47	PASS
LTE Band5	1.4	20643	6	#0	QAM16	21.74	21.48	PASS
LTE Band5	3	20415	1	#0	QPSK	23.46	23.20	PASS
LTE Band5	3	20415	1	#Mid	QPSK	23.40	23.14	PASS
LTE Band5	3	20415	1	#Max	QPSK	23.38	23.12	PASS
LTE Band5	3	20415	8	#0	QPSK	22.47	22.21	PASS
LTE Band5	3	20415	8	#Mid	QPSK	22.47	22.21	PASS
LTE Band5	3	20415	8	#Max	QPSK	22.34	22.08	PASS
LTE Band5	3	20415	15	#0	QPSK	22.39	22.13	PASS
LTE Band5	3	20415	1	#0	QAM16	22.24	21.98	PASS
LTE Band5	3	20415	1	#Mid	QAM16	22.19	21.93	PASS
LTE Band5	3	20415	1	#Max	QAM16	22.22	21.96	PASS
LTE Band5	3	20415	8	#0	QAM16	21.03	20.77	PASS
LTE Band5	3	20415	8	#Mid	QAM16	21.03	20.77	PASS
LTE Band5	3	20415	8	#Max	QAM16	20.87	20.61	PASS
LTE Band5	3	20415	15	#0	QAM16	21.47	21.21	PASS
LTE Band5	3	20525	1	#0	QPSK	23.70	23.44	PASS
LTE Band5	3	20525	1	#Mid	QPSK	23.64	23.38	PASS
LTE Band5	3	20525	1	#Max	QPSK	23.58	23.32	PASS
LTE Band5	3	20525	8	#0	QPSK	22.47	22.21	PASS
LTE Band5	3	20525	8	#Mid	QPSK	22.47	22.21	PASS
LTE Band5	3	20525	8	#Max	QPSK	22.53	22.27	PASS
LTE Band5	3	20525	15	#0	QPSK	22.44	22.18	PASS
LTE Band5	3	20525	1	#0	QAM16	22.99	22.73	PASS
LTE Band5	3	20525	1	#Mid	QAM16	22.93	22.67	PASS
LTE Band5	3	20525	1	#Max	QAM16	23.35	23.09	PASS
LTE Band5	3	20525	8	#0	QAM16	21.56	21.30	PASS
LTE Band5	3	20525	8	#Mid	QAM16	21.57	21.31	PASS
LTE Band5	3	20525	8	#Max	QAM16	21.61	21.35	PASS
LTE Band5	3	20525	15	#0	QAM16	21.52	21.26	PASS
LTE Band5	3	20635	1	#0	QPSK	23.45	23.19	PASS
LTE Band5	3	20635	1	#Mid	QPSK	23.39	23.13	PASS
LTE Band5	3	20635	1	#Max	QPSK	23.36	23.10	PASS
LTE Band5	3	20635	8	#0	QPSK	22.19	21.93	PASS
LTE Band5	3	20635	8	#Mid	QPSK	22.20	21.94	PASS
LTE Band5	3	20635	8	#Max	QPSK	22.09	21.83	PASS
LTE Band5	3	20635	15	#0	QPSK	22.03	21.77	PASS
LTE Band5	3	20635	1	#0	QAM16	21.99	21.73	PASS
LTE Band5	3	20635	1	#Mid	QAM16	22.12	21.86	PASS
LTE Band5	3	20635	1	#Max	QAM16	21.95	21.69	PASS
LTE Band5	3	20635	8	#0	QAM16	20.89	20.63	PASS
LTE Band5	3	20635	8	#Mid	QAM16	20.81	20.55	PASS



LTE Band5	3	20635	8	#Max	QAM16	20.95	20.69	PASS
LTE Band5	3	20635	15	#0	QAM16	20.82	20.56	PASS
LTE Band5	5	20425	1	#0	QPSK	23.47	23.21	PASS
LTE Band5	5	20425	1	#Mid	QPSK	23.38	23.12	PASS
LTE Band5	5	20425	1	#Max	QPSK	23.36	23.10	PASS
LTE Band5	5	20425	12	#0	QPSK	22.63	22.37	PASS
LTE Band5	5	20425	12	#Mid	QPSK	22.63	22.37	PASS
LTE Band5	5	20425	12	#Max	QPSK	22.53	22.27	PASS
LTE Band5	5	20425	25	#0	QPSK	22.62	22.36	PASS
LTE Band5	5	20425	1	#0	QAM16	22.48	22.22	PASS
LTE Band5	5	20425	1	#Mid	QAM16	22.12	21.86	PASS
LTE Band5	5	20425	1	#Max	QAM16	22.07	21.81	PASS
LTE Band5	5	20425	12	#0	QAM16	21.50	21.24	PASS
LTE Band5	5	20425	12	#Mid	QAM16	21.50	21.24	PASS
LTE Band5	5	20425	12	#Max	QAM16	21.31	21.05	PASS
LTE Band5	5	20425	25	#0	QAM16	21.66	21.40	PASS
LTE Band5	5	20525	1	#0	QPSK	23.41	23.15	PASS
LTE Band5	5	20525	1	#Mid	QPSK	23.36	23.10	PASS
LTE Band5	5	20525	1	#Max	QPSK	23.04	22.78	PASS
LTE Band5	5	20525	12	#0	QPSK	22.57	22.31	PASS
LTE Band5	5	20525	12	#Mid	QPSK	22.61	22.35	PASS
LTE Band5	5	20525	12	#Max	QPSK	22.29	22.03	PASS
LTE Band5	5	20525	25	#0	QPSK	22.52	22.26	PASS
LTE Band5	5	20525	1	#0	QAM16	22.59	22.33	PASS
LTE Band5	5	20525	1	#Mid	QAM16	22.65	22.39	PASS
LTE Band5	5	20525	1	#Max	QAM16	22.58	22.32	PASS
LTE Band5	5	20525	12	#0	QAM16	21.14	20.88	PASS
LTE Band5	5	20525	12	#Mid	QAM16	21.18	20.92	PASS
LTE Band5	5	20525	12	#Max	QAM16	20.98	20.72	PASS
LTE Band5	5	20525	25	#0	QAM16	21.35	21.09	PASS
LTE Band5	5	20625	1	#0	QPSK	23.03	22.77	PASS
LTE Band5	5	20625	1	#Mid	QPSK	23.28	23.02	PASS
LTE Band5	5	20625	1	#Max	QPSK	23.01	22.75	PASS
LTE Band5	5	20625	12	#0	QPSK	22.11	21.85	PASS
LTE Band5	5	20625	12	#Mid	QPSK	22.11	21.85	PASS
LTE Band5	5	20625	12	#Max	QPSK	22.03	21.77	PASS
LTE Band5	5	20625	25	#0	QPSK	21.99	21.73	PASS
LTE Band5	5	20625	1	#0	QAM16	22.48	22.22	PASS
LTE Band5	5	20625	1	#Mid	QAM16	22.30	22.04	PASS
LTE Band5	5	20625	1	#Max	QAM16	21.94	21.68	PASS
LTE Band5	5	20625	12	#0	QAM16	20.90	20.64	PASS
LTE Band5	5	20625	12	#Mid	QAM16	20.91	20.65	PASS



LTE Band5	5	20625	12	#Max	QAM16	21.10	20.84	PASS
LTE Band5	5	20625	25	#0	QAM16	20.84	20.58	PASS
LTE Band5	10	20450	1	#0	QPSK	23.71	23.45	PASS
LTE Band5	10	20450	1	#Mid	QPSK	23.36	23.10	PASS
LTE Band5	10	20450	1	#Max	QPSK	23.40	23.14	PASS
LTE Band5	10	20450	25	#0	QPSK	22.59	22.33	PASS
LTE Band5	10	20450	25	#Mid	QPSK	22.56	22.30	PASS
LTE Band5	10	20450	25	#Max	QPSK	22.48	22.22	PASS
LTE Band5	10	20450	50	#0	QPSK	22.58	22.32	PASS
LTE Band5	10	20450	1	#0	QAM16	22.67	22.41	PASS
LTE Band5	10	20450	1	#Mid	QAM16	22.21	21.95	PASS
LTE Band5	10	20450	1	#Max	QAM16	22.95	22.69	PASS
LTE Band5	10	20450	25	#0	QAM16	21.67	21.41	PASS
LTE Band5	10	20450	25	#Mid	QAM16	21.65	21.39	PASS
LTE Band5	10	20450	25	#Max	QAM16	21.28	21.02	PASS
LTE Band5	10	20450	50	#0	QAM16	21.59	21.33	PASS
LTE Band5	10	20525	1	#0	QPSK	23.35	23.09	PASS
LTE Band5	10	20525	1	#Mid	QPSK	23.70	23.44	PASS
LTE Band5	10	20525	1	#Max	QPSK	23.01	22.75	PASS
LTE Band5	10	20525	25	#0	QPSK	22.52	22.26	PASS
LTE Band5	10	20525	25	#Mid	QPSK	22.56	22.30	PASS
LTE Band5	10	20525	25	#Max	QPSK	22.37	22.11	PASS
LTE Band5	10	20525	50	#0	QPSK	22.59	22.33	PASS
LTE Band5	10	20525	1	#0	QAM16	22.93	22.67	PASS
LTE Band5	10	20525	1	#Mid	QAM16	23.56	23.30	PASS
LTE Band5	10	20525	1	#Max	QAM16	22.47	22.21	PASS
LTE Band5	10	20525	25	#0	QAM16	21.57	21.31	PASS
LTE Band5	10	20525	25	#Mid	QAM16	21.59	21.33	PASS
LTE Band5	10	20525	25	#Max	QAM16	21.11	20.85	PASS
LTE Band5	10	20525	50	#0	QAM16	21.37	21.11	PASS
LTE Band5	10	20600	1	#0	QPSK	23.26	23.00	PASS
LTE Band5	10	20600	1	#Mid	QPSK	23.40	23.14	PASS
LTE Band5	10	20600	1	#Max	QPSK	23.19	22.93	PASS
LTE Band5	10	20600	25	#0	QPSK	22.26	22.00	PASS
LTE Band5	10	20600	25	#Mid	QPSK	22.25	21.99	PASS
LTE Band5	10	20600	25	#Max	QPSK	22.05	21.79	PASS
LTE Band5	10	20600	50	#0	QPSK	22.13	21.87	PASS
LTE Band5	10	20600	1	#0	QAM16	21.89	21.63	PASS
LTE Band5	10	20600	1	#Mid	QAM16	21.74	21.48	PASS
LTE Band5	10	20600	1	#Max	QAM16	22.12	21.86	PASS
LTE Band5	10	20600	25	#0	QAM16	21.05	20.79	PASS
LTE Band5	10	20600	25	#Mid	QAM16	21.04	20.78	PASS



LTE Band5	10	20600	25	#Max	QAM16	21.21	20.95	PASS
LTE Band5	10	20600	50	#0	QAM16	20.78	20.52	PASS

5.2. Occupied Bandwidth

Ambient condition

Temperature	Relative humidity	Pressure
23°C ~25°C	45%~50%	101.5kPa

Method of Measurement

The EUT was connected to Spectrum Analyzer and Base Station Simulator via power Splitter. The occupied bandwidth is measured using spectrum analyzer.

RBW is set to 3kHz, VBW is set to 10kHz for GSM 850,

RBW is set to 51kHz, VBW is set to 160kHz for WCDMA Band V,

RBW is set to 30 kHz, VBW is set to 91kHz for LTE Band 5 (1.4MHz),

RBW is set to 62 kHz, VBW is set to 180kHz for LTE Band 5 (3MHz),

RBW is set to 100 kHz, VBW is set to 300kHz for LTE Band 5 (5MHz),

RBW is set to 200 kHz, VBW is set to 620kHz for LTE Band 5 (10MHz),

99% power and -26dBc occupied bandwidths are recorded. Spectrum analyzer plots are included on the following pages.

Test Setup

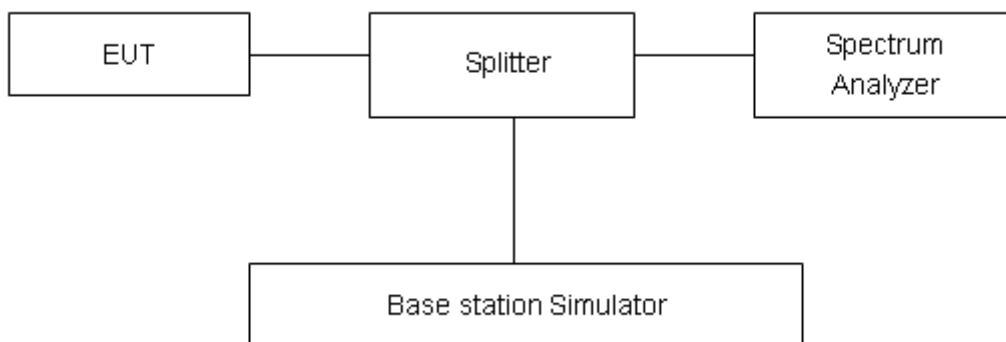

Limits

No specific occupied bandwidth requirements in part 2.1049.

Measurement Uncertainty

The assessed measurement uncertainty to ensure 95% confidence level for the normal distribution is with the coverage factor $k = 2$, $U = 624\text{Hz}$.

Test Result

Mode	Channel	Frequency (MHz)	99% Power Bandwidth (MHz)	-26dBc Bandwidth(MHz)
GSM 850 (GSM)	128	824.2	0.2417	0.2976
	190	836.6	0.2398	0.2968
	251	848.8	0.2437	0.295
GPRS 850 (GMSK)	128	824.2	0.2411	0.314
	190	836.6	0.2463	0.3105
	251	848.8	0.2452	0.3067
EGPRS 850 (8-PSK)	128	824.2	0.2469	0.3098
	190	836.6	0.2408	0.298
	251	848.8	0.2446	0.3079
WCDMA Band V (RMC)	4132	826.4	4.1255	4.691
	4183	836.6	4.1177	4.692
	4233	846.6	4.1181	4.672

LTE Band 5						
RB	Modulation	Bandwidth (MHz)	Channel	Frequency (MHz)	99% Power Bandwidth(MHz)	-26dBc Bandwidth(MHz)
100%	QPSK	1.4	20407	824.7	1.1023	1.272
			20525	836.5	1.0959	1.297
			20643	848.3	1.0948	1.292
		3	20415	825.5	2.6953	2.957
			20525	836.5	2.7015	2.973
			20635	847.5	2.6927	2.992
		5	20425	826.5	4.5189	4.987
			20525	836.5	4.5030	4.956
			20625	846.5	4.5131	4.981
		10	20450	829	8.9738	9.775
			20525	836.5	8.9754	9.838
			20600	844	8.9635	9.756
	16QAM	1.4	20407	824.7	1.097	1.32
			20525	836.5	1.1012	1.292
			20643	848.3	1.0905	1.267



		3	20415	825.5	2.6872	2.921
			20525	836.5	2.7067	2.993
			20635	847.5	2.7018	3.011
		5	20425	826.5	4.5025	4.923
			20525	836.5	4.5175	4.981
			20625	846.5	4.5141	4.972
		10	20450	829	8.9595	9.815
			20525	836.5	8.9681	9.797
			20600	844	8.9603	9.758

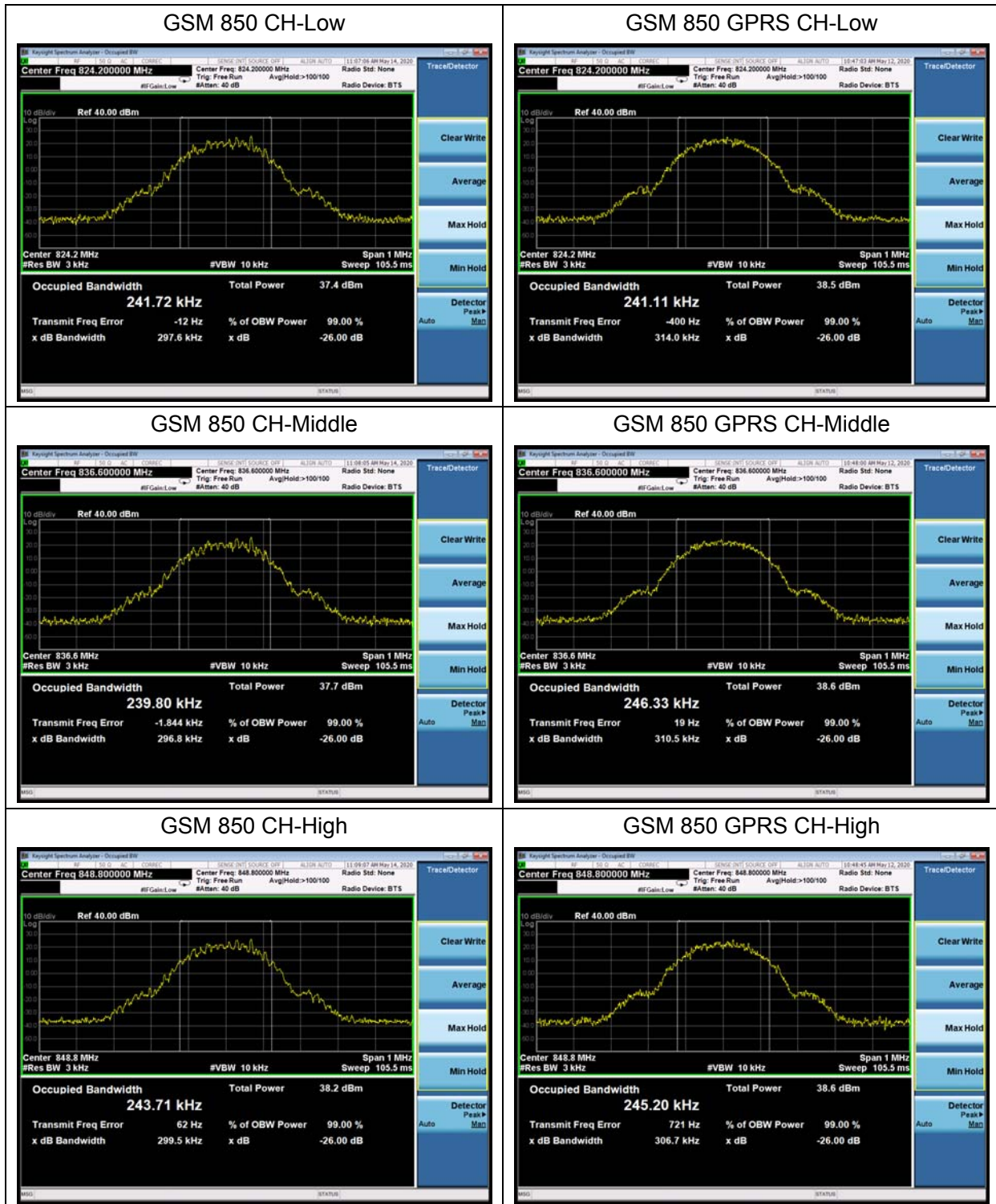

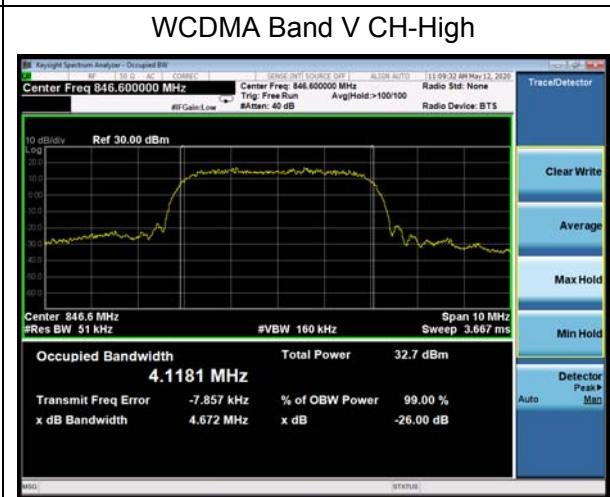
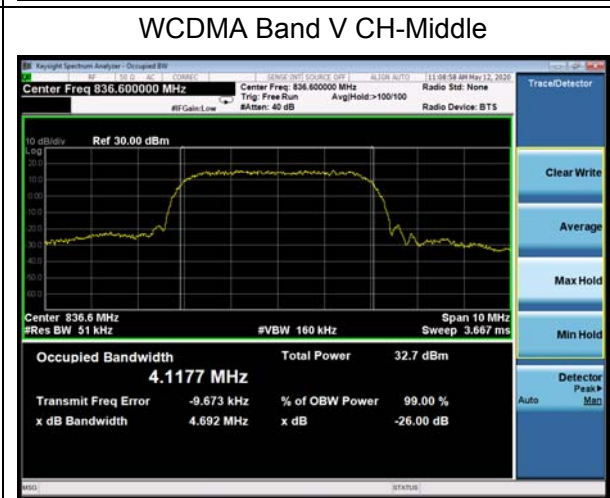
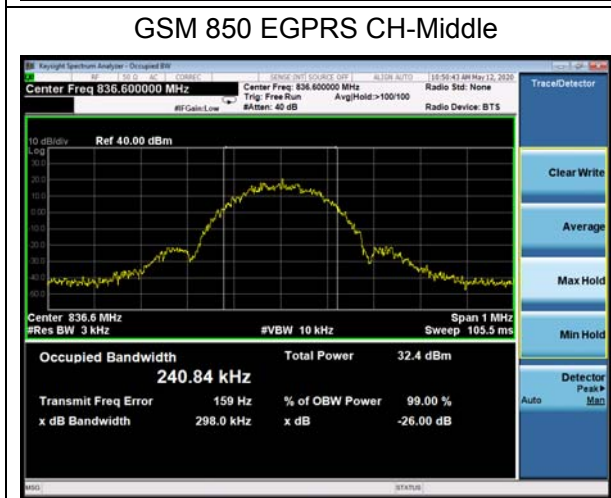
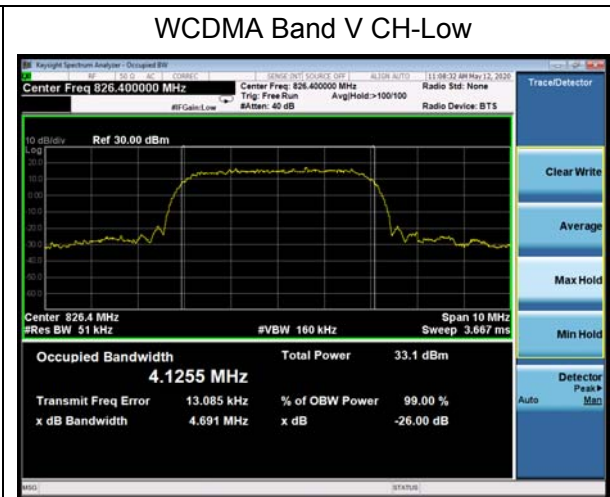
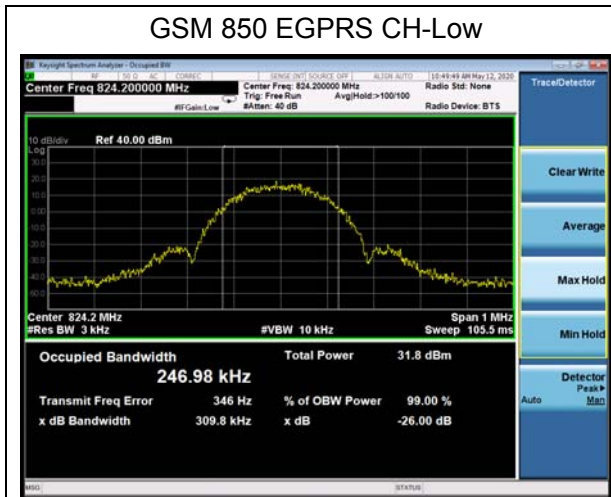

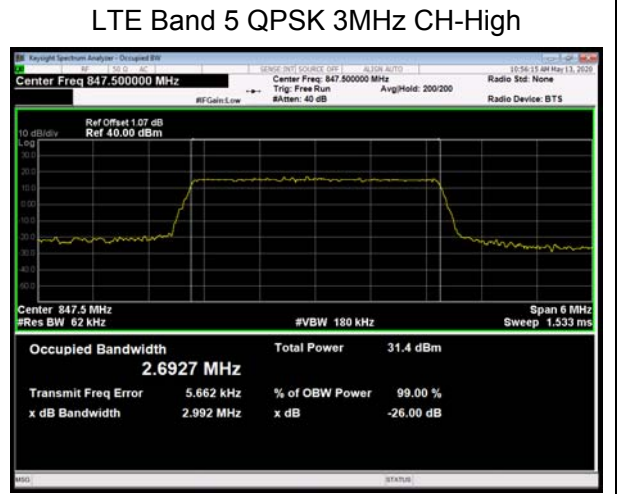
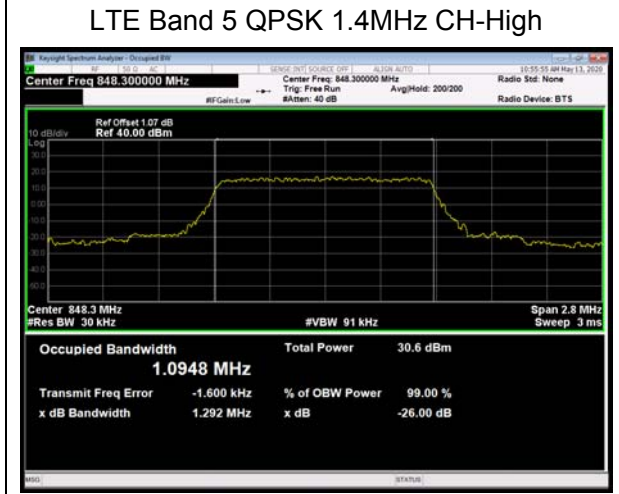
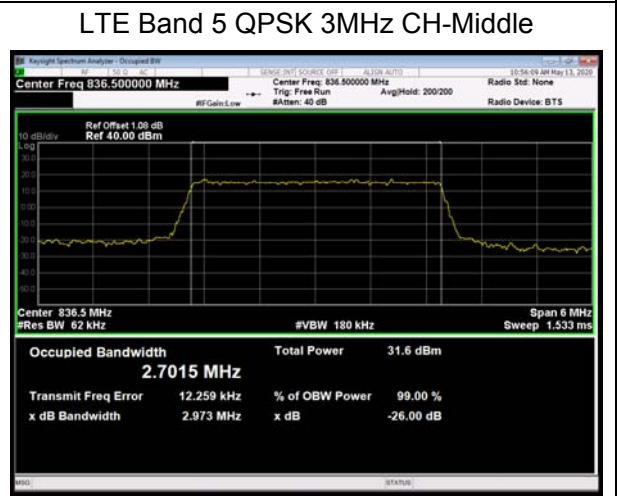
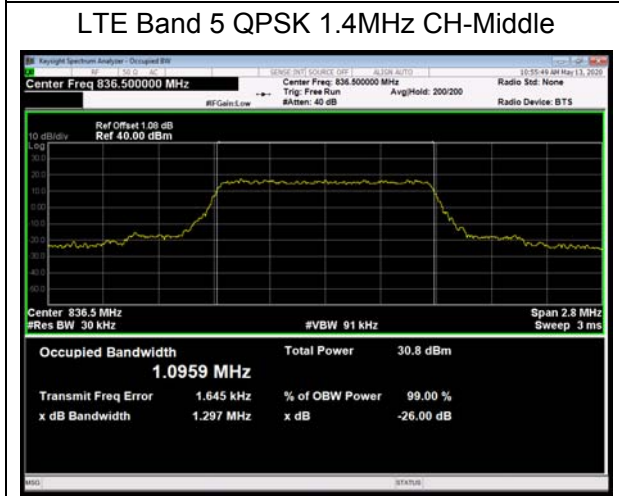
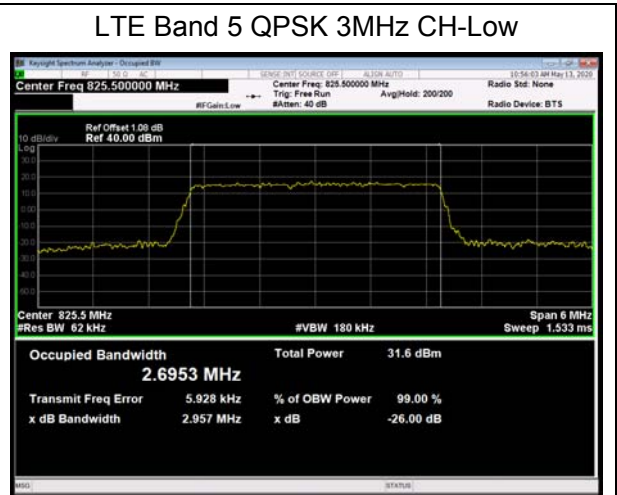
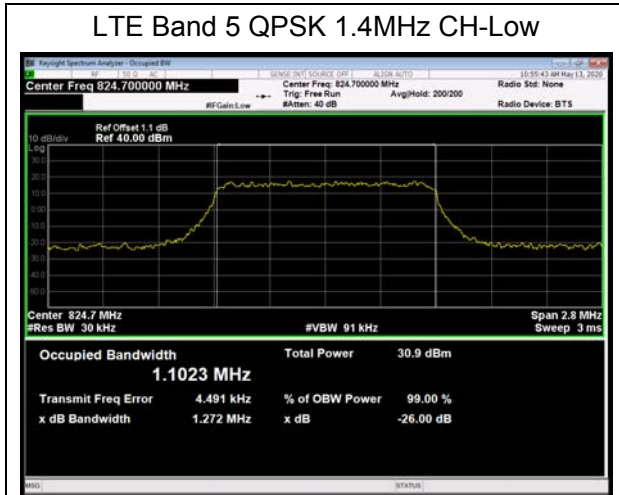

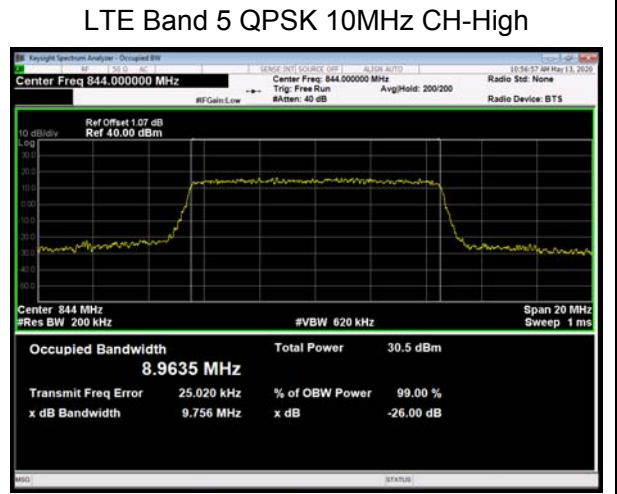
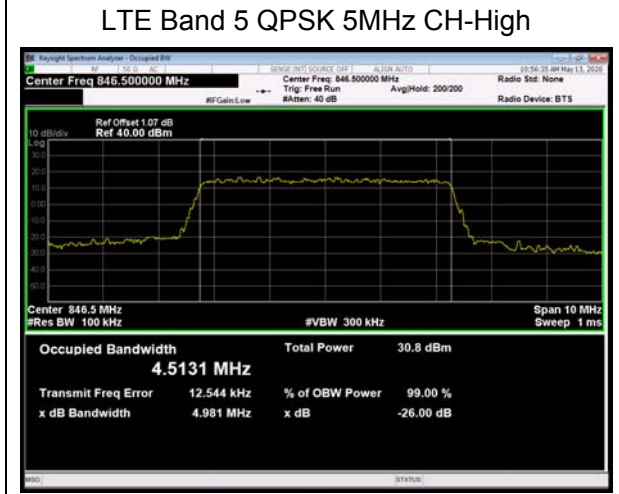
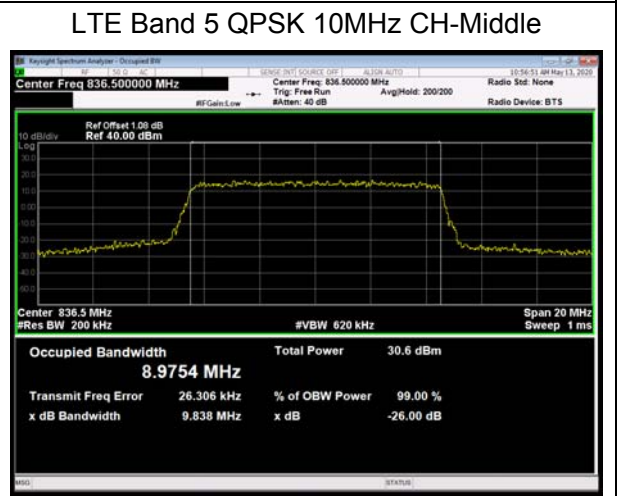
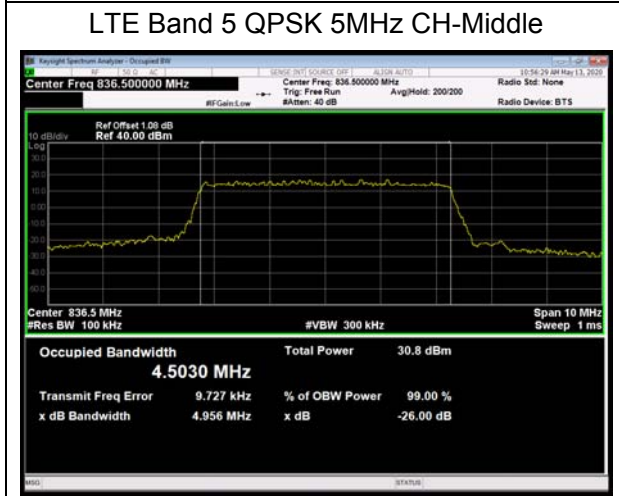
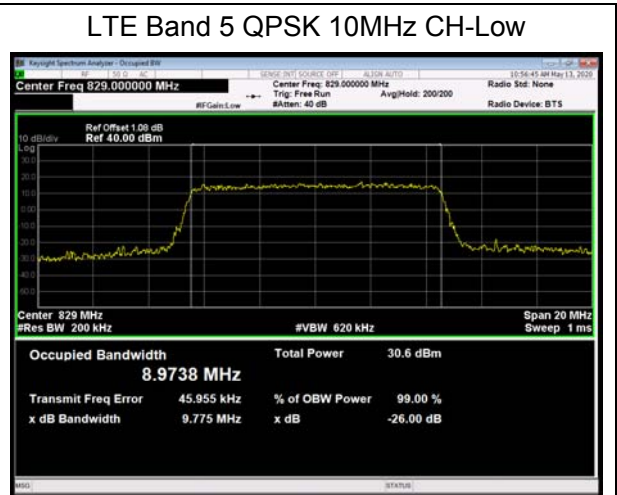
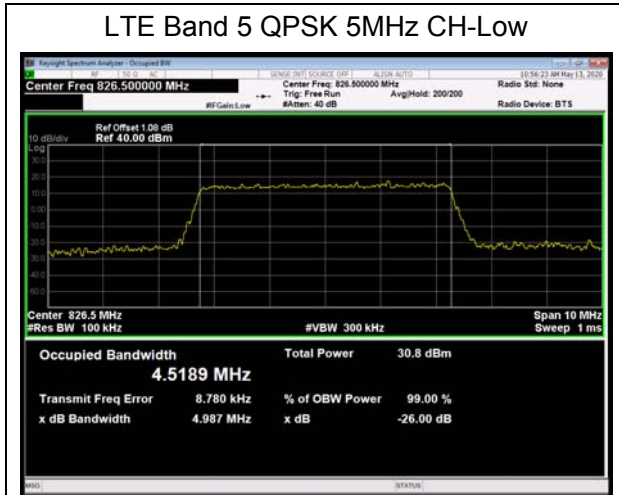

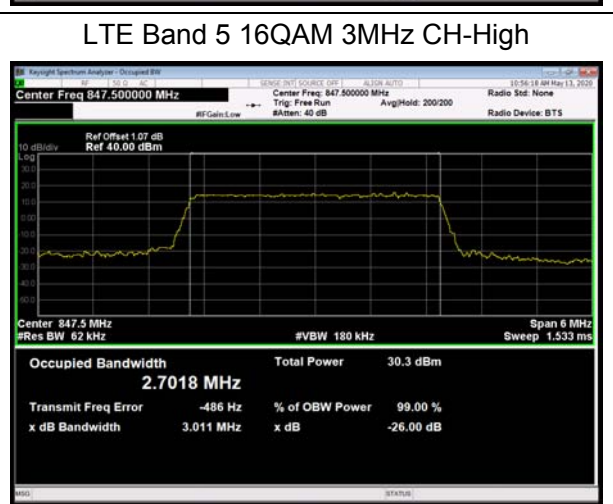
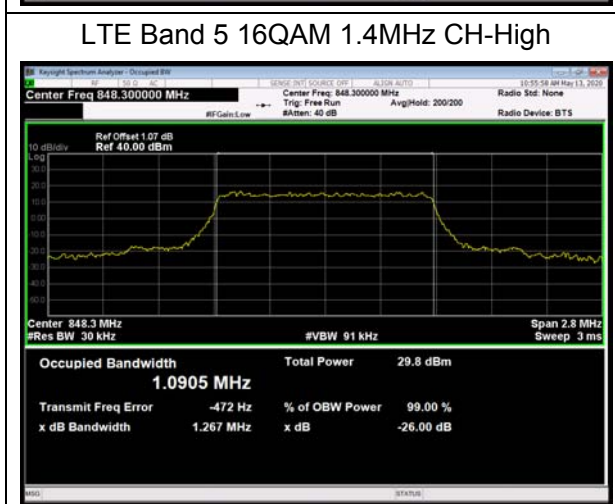
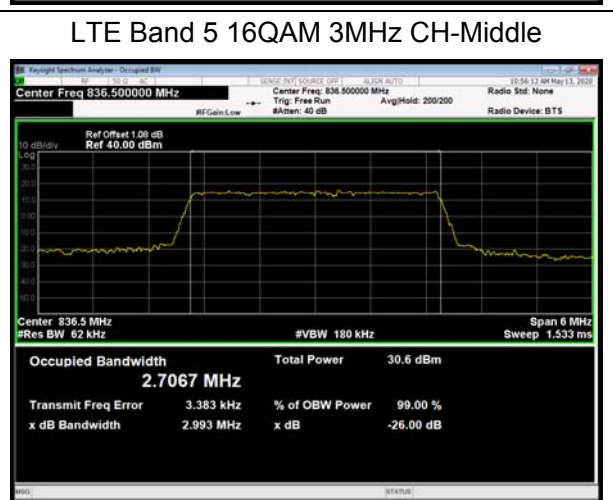
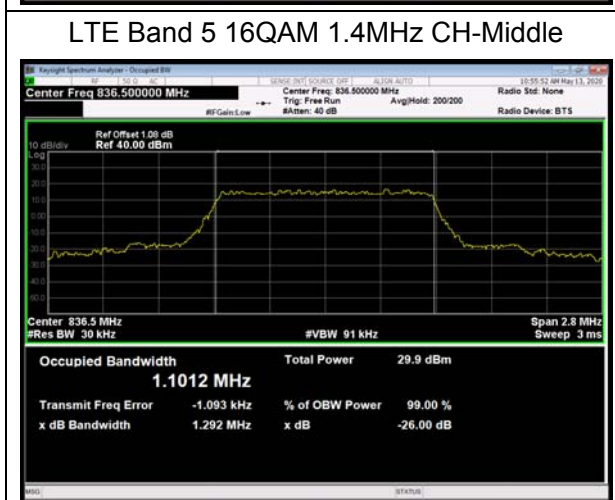
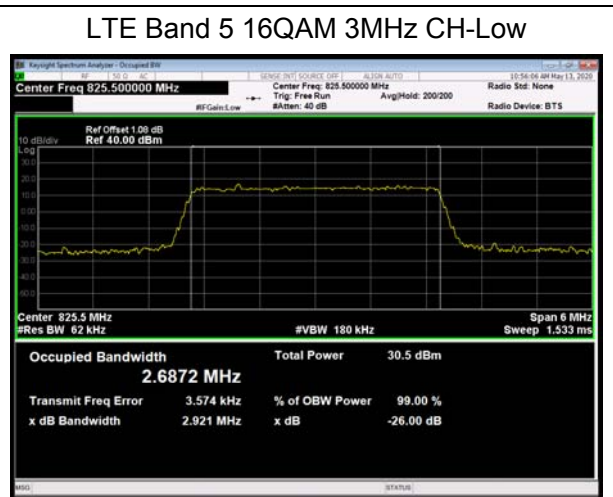
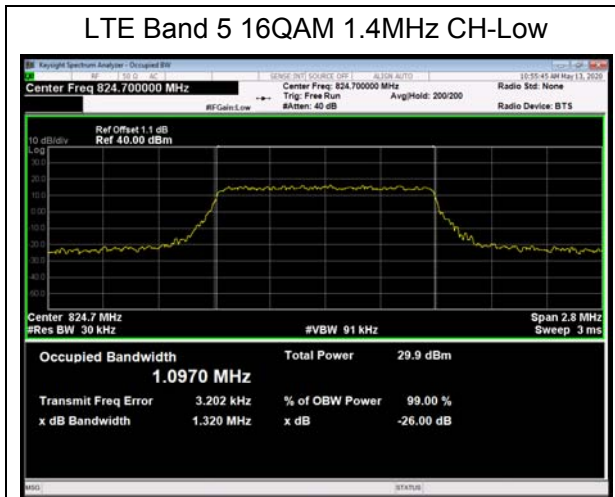

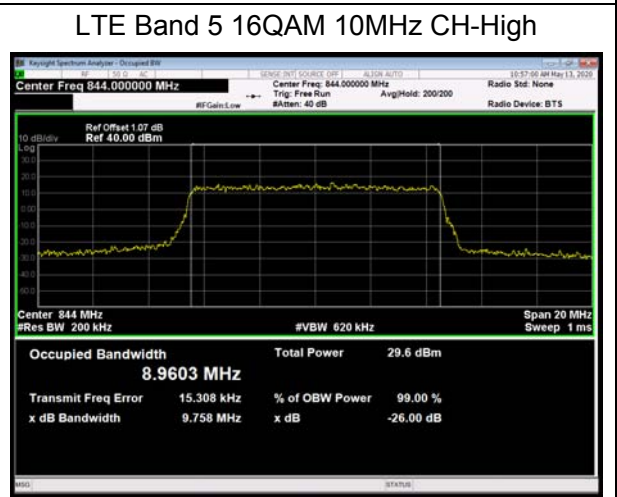
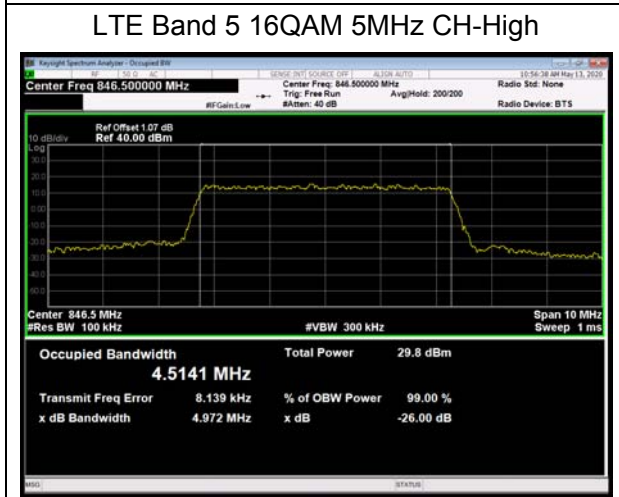
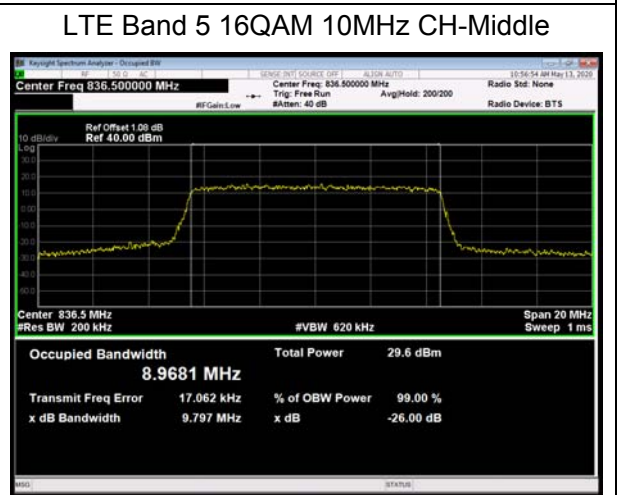
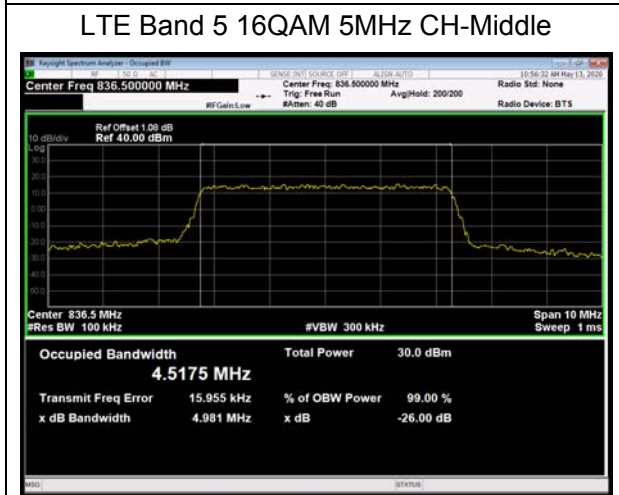
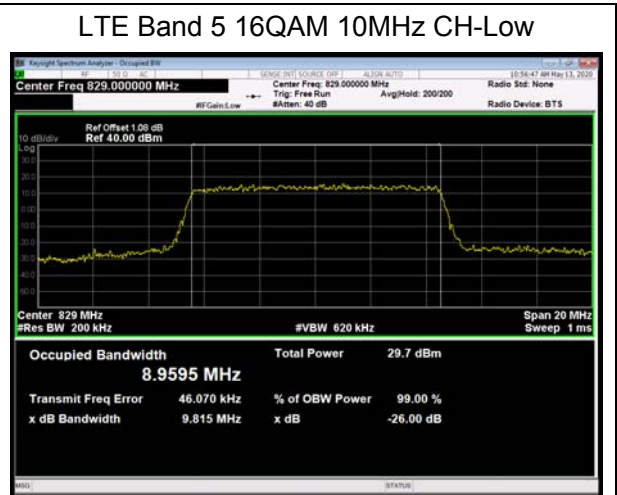
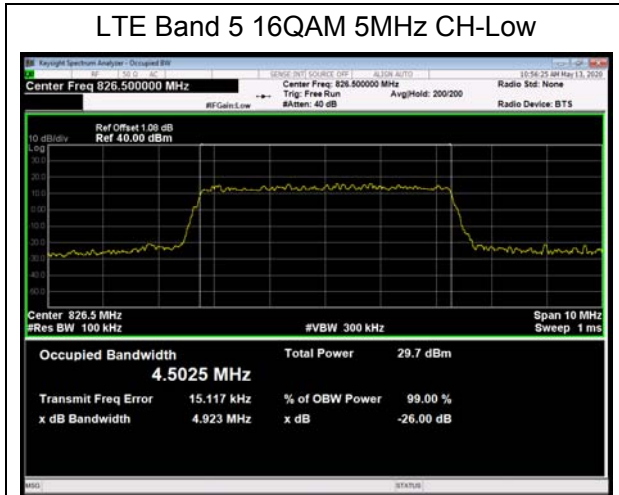

5.3. Band Edge Compliance

Ambient condition

Temperature	Relative humidity	Pressure
23°C ~25°C	45%~50%	101.5kPa

Method of Measurement

The EUT was connected to Spectrum Analyzer and Base Station Simulator via power Splitter. The band edge of the lowest and highest channels were measured. The average detector is used. RBW is set to 3kHz, VBW is set to 10kHz for GSM 850, RBW is set to 51kHz, VBW is set to 160kHz for WCDMA Band V, RBW is set to 15kHz, VBW is set to 43kHz for LTE Band 5 (1.4MHz), RBW is set to 30kHz, VBW is set to 91kHz for LTE Band 5 (3MHz), RBW is set to 51kHz, VBW is set to 150kHz for LTE Band 5 (5MHz), RBW is set to 100kHz, VBW is set to 300kHz for LTE Band 5 (10MHz), Spectrum analyzer plots are included on the following pages.

Test Setup

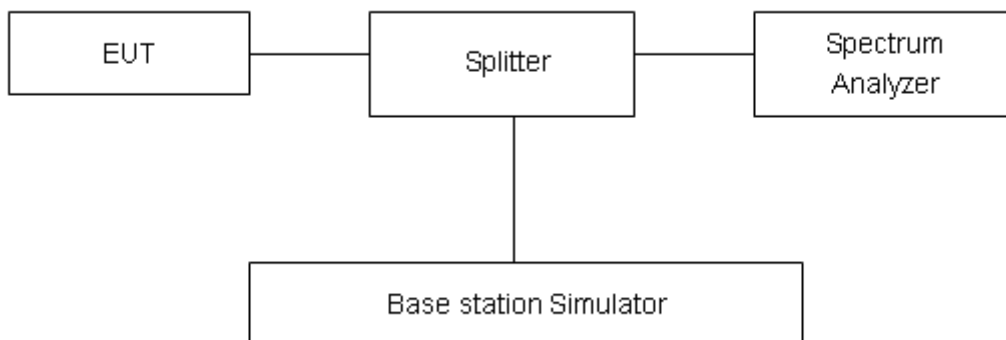

Limits

Rule Part 22.917(a) specifies that “The power of any emission outside of the authorized operating frequency ranges must be attenuated below the transmitting power (P) by a factor of at least 43 + 10 log(P) dB.”

Limit	-13 dBm
-------	---------

Measurement Uncertainty

The assessed measurement uncertainty to ensure 95% confidence level for the normal distribution is with the coverage factor $k = 1.96$, $U=0.684$ dB.



Test Result:

GSM 850 CH-Low



GSM 850 CH-High



GSM 850 GPRS CH-Low

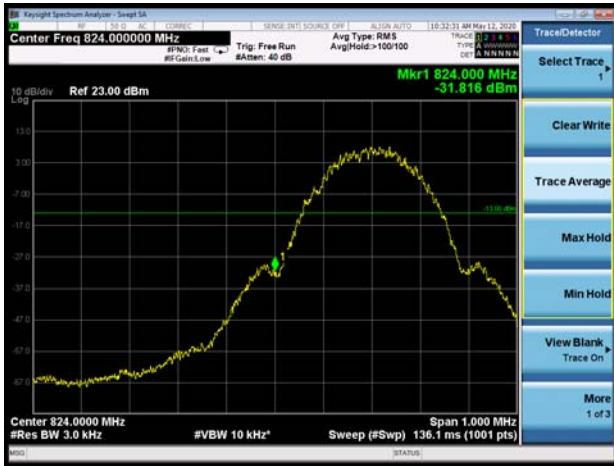

GSM 850 GPRS CH-High



GSM 850 EGPRS CH-Low

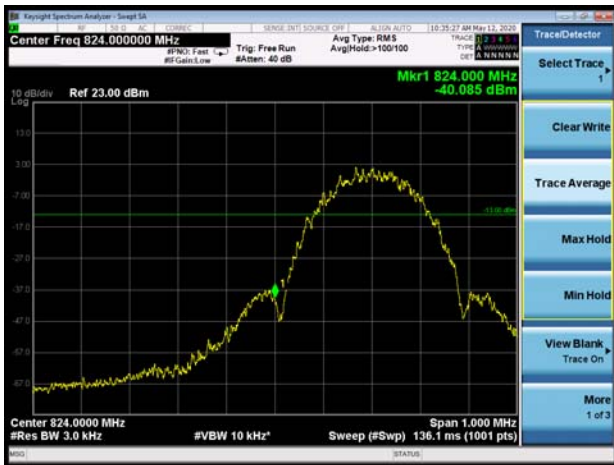

GSM 850 EGPRS CH-High





WCDMA Band V CH-Low



WCDMA Band V CH-High



LTE Band 5 QPSK 1.4MHz CH-Low 1RB

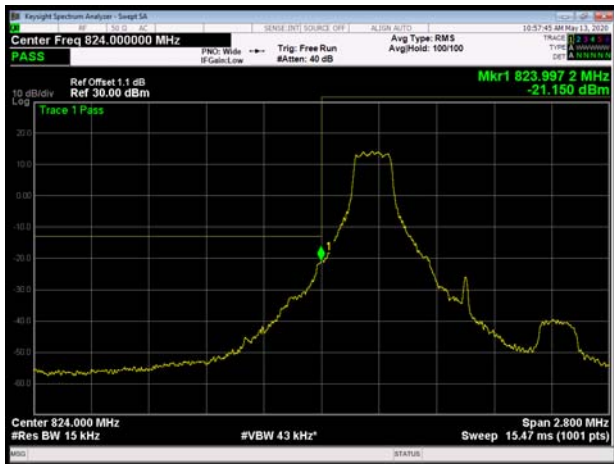

LTE Band 5 QPSK 1.4MHz CH-High 1RB

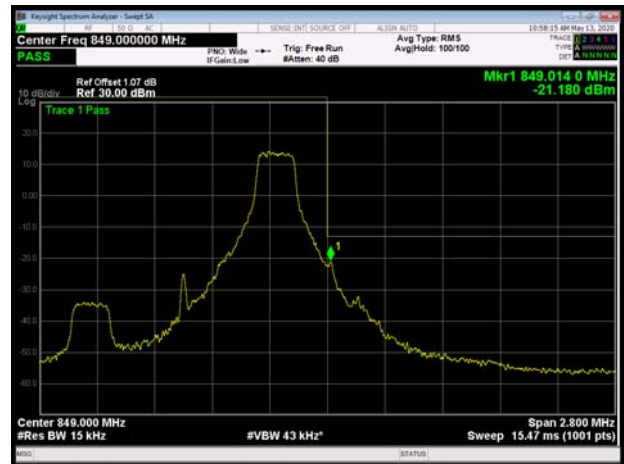

LTE Band 5 QPSK 1.4MHz CH-Low 100%RB



LTE Band 5 QPSK 1.4MHz CH-High 100%RB





LTE Band 5 QPSK 3MHz CH-Low 1RB

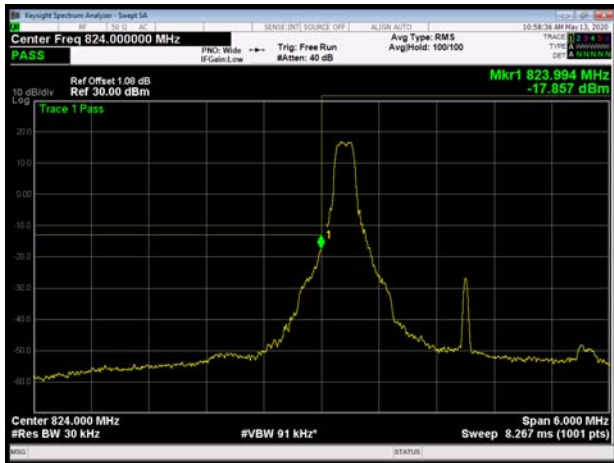

LTE Band 5 QPSK 3MHz CH-High 1RB

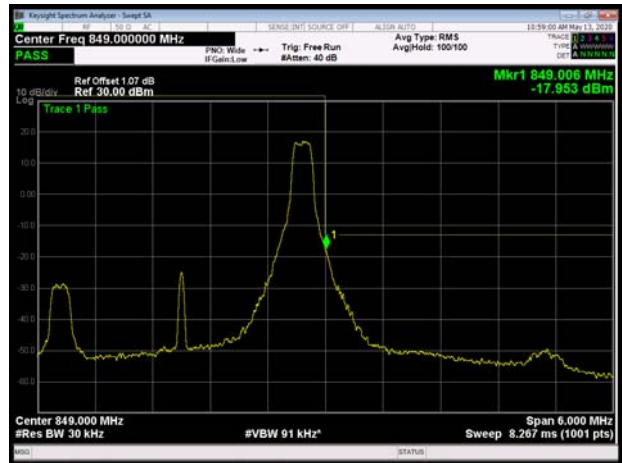

LTE Band 5 QPSK 3MHz CH-Low 100%RB

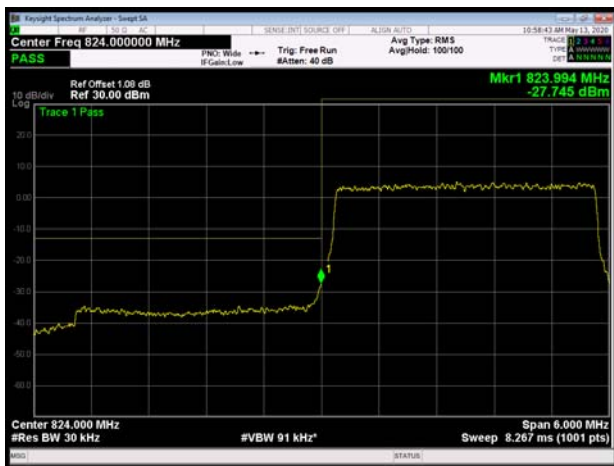

LTE Band 5 QPSK 3MHz CH-High 100%RB



LTE Band 5 QPSK 5MHz CH-Low 1RB

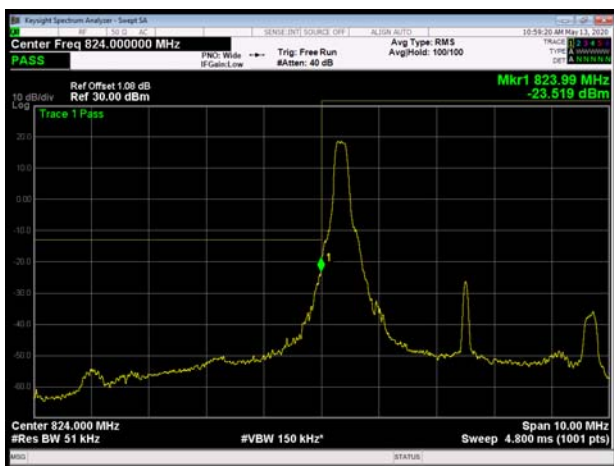

LTE Band 5 QPSK 5MHz CH-High 1RB

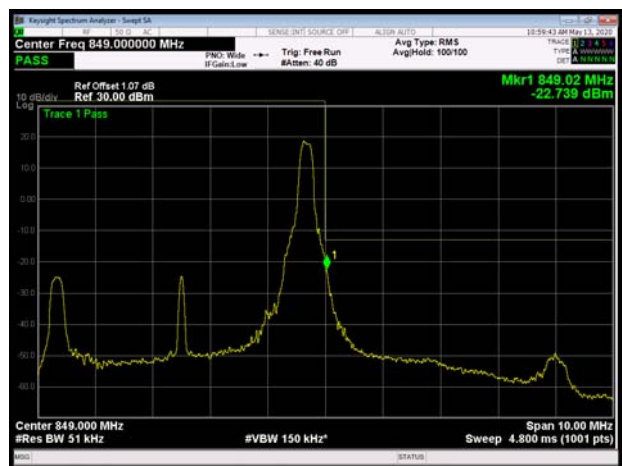



LTE Band 5 QPSK 5MHz CH-Low 100%RB



LTE Band 5 QPSK 5MHz CH-High 100%RB



LTE Band 5 QPSK 10MHz CH-Low 1RB

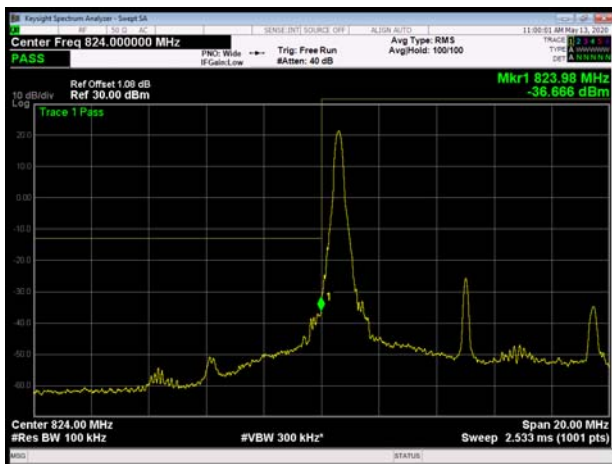

LTE Band 5 QPSK 10MHz CH-High 1RB

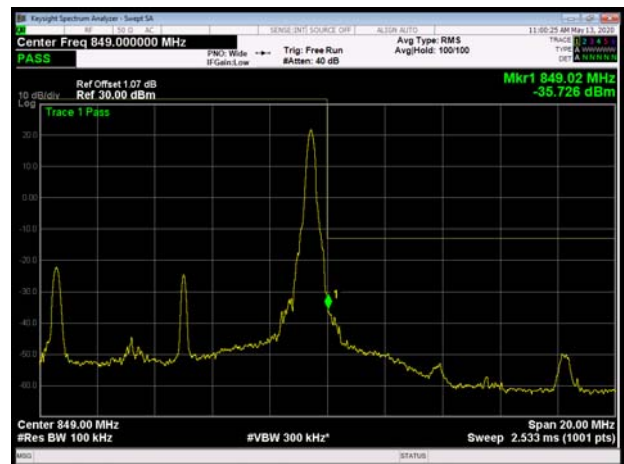

LTE Band 5 QPSK 10MHz CH-Low 100%RB

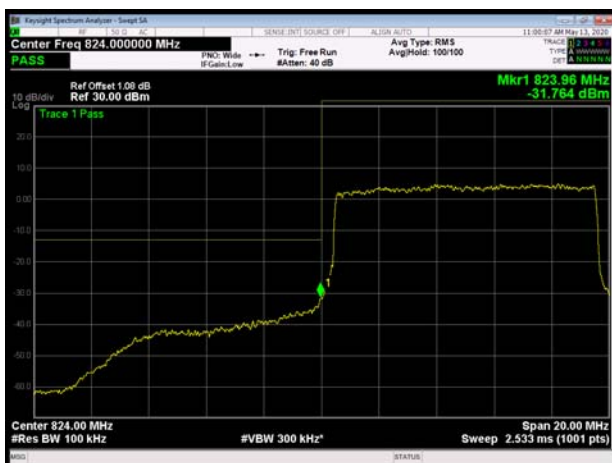

LTE Band 5 QPSK 10MHz CH-High 100%RB

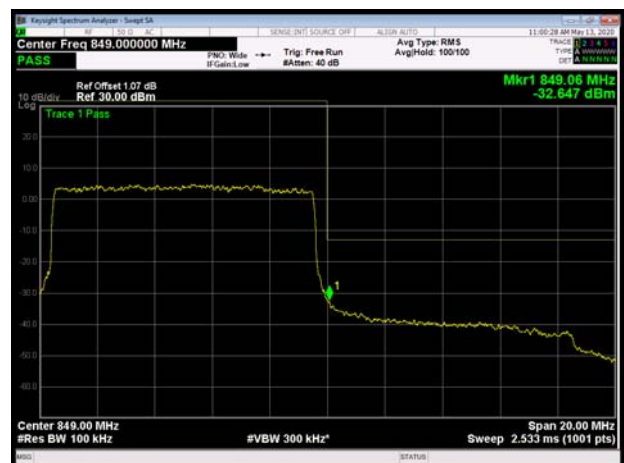



LTE Band 5 16QAM 1.4MHz CH-Low 1RB

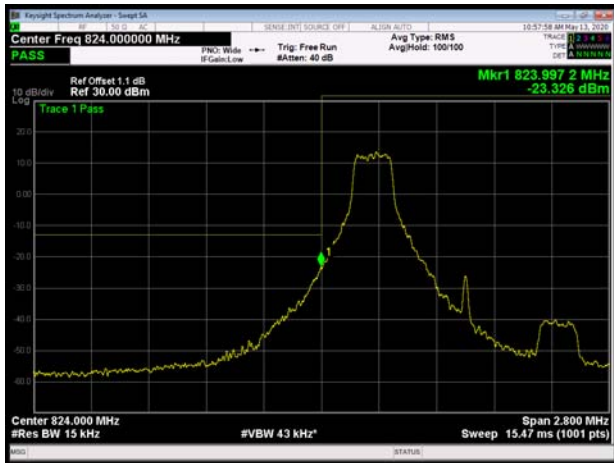

LTE Band 5 16QAM 1.4MHz CH-High 1RB

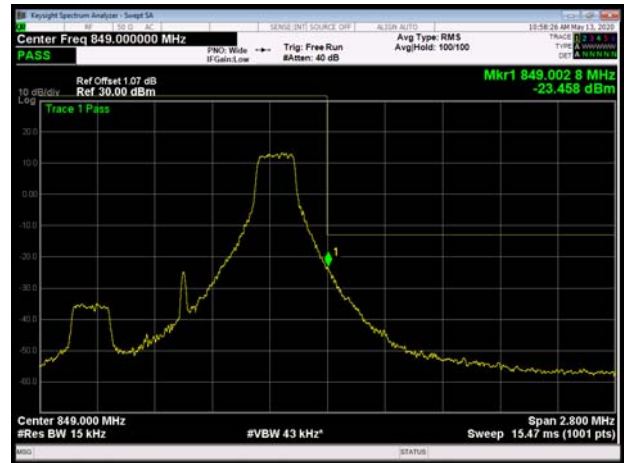

LTE Band 5 16QAM 1.4MHz CH-Low 100%RB

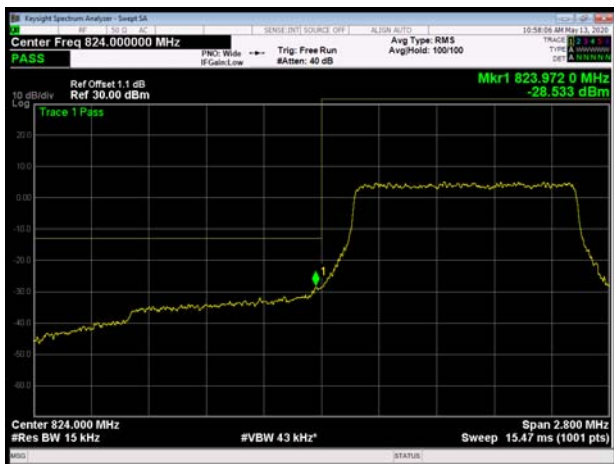

LTE Band 5 16QAM 1.4MHz CH-High 100%RB



LTE Band 5 16QAM 3MHz CH-Low 1RB

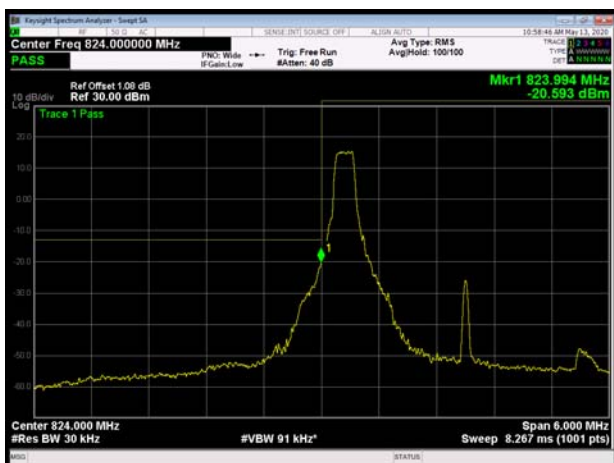

LTE Band 5 16QAM 3MHz CH-High 1RB

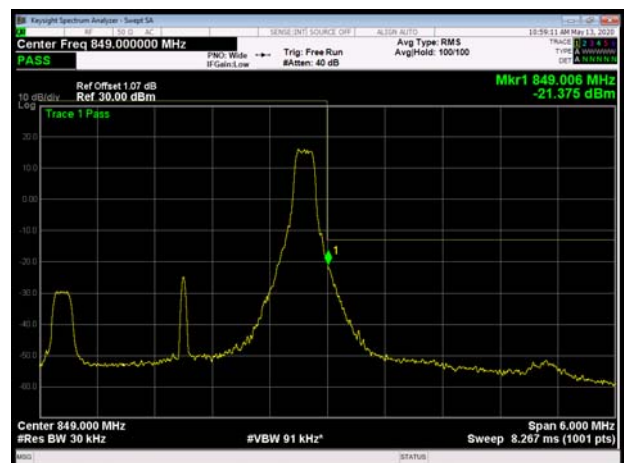



LTE Band 5 16QAM 3MHz CH-Low 100%RB

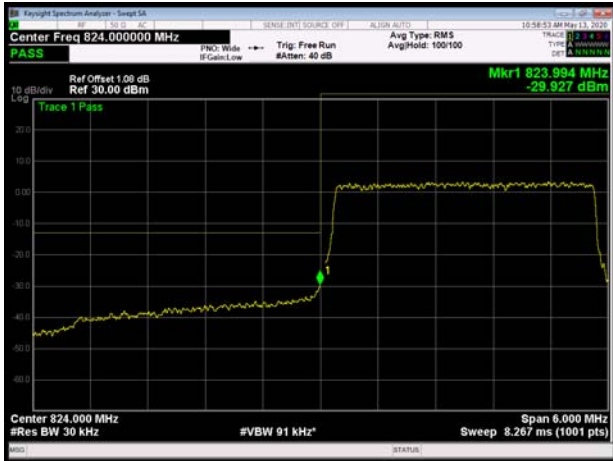

LTE Band 5 16QAM 3MHz CH-High 100%RB

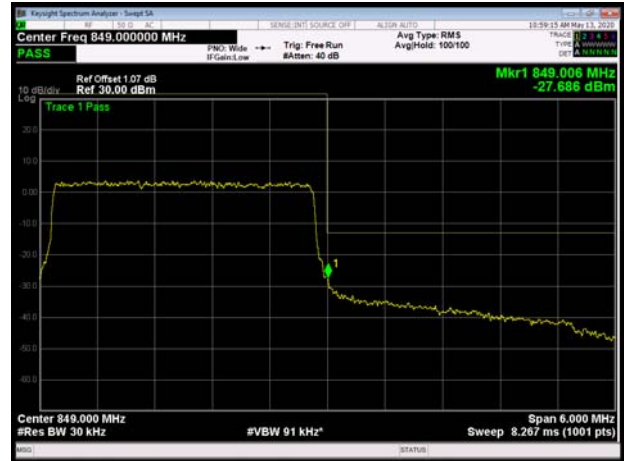

LTE Band 5 16QAM 5MHz CH-Low 1RB

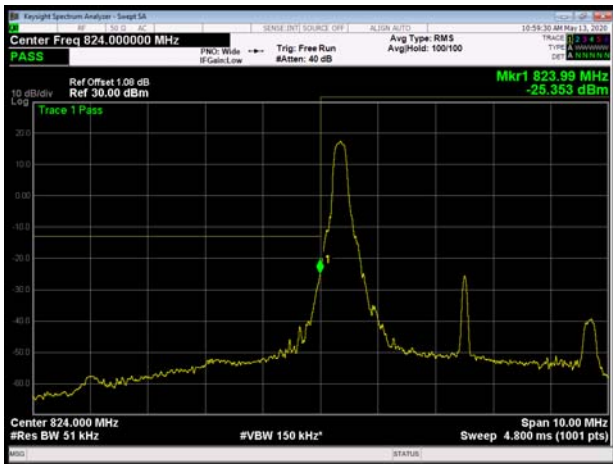

LTE Band 5 16QAM 5MHz CH-High 1RB

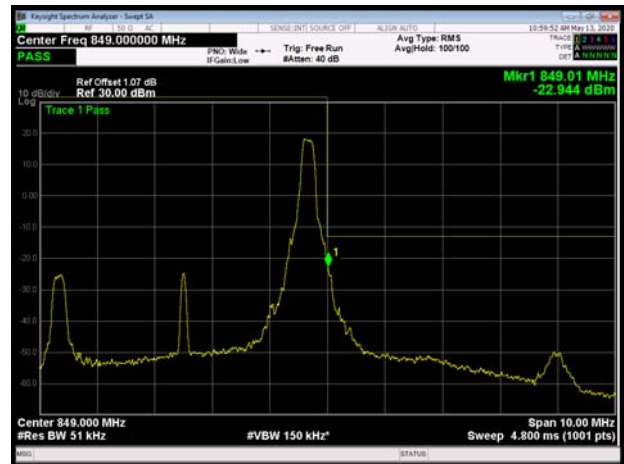

LTE Band 5 16QAM 5MHz CH-Low 100%RB

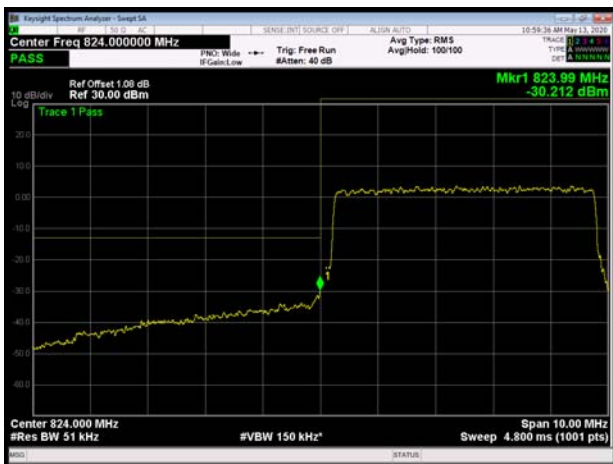

LTE Band 5 16QAM 5MHz CH-High 100%RB

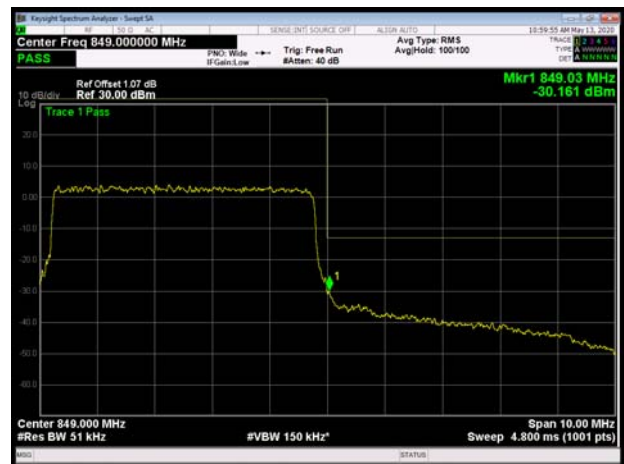



LTE Band 5 16QAM 10MHz CH-Low 1RB

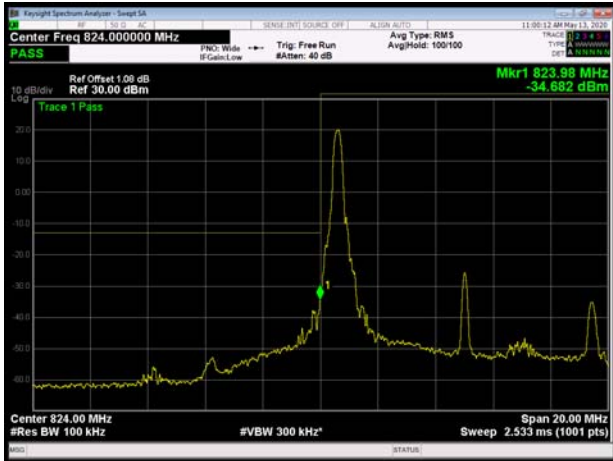

LTE Band 5 16QAM 10MHz CH-High 1RB

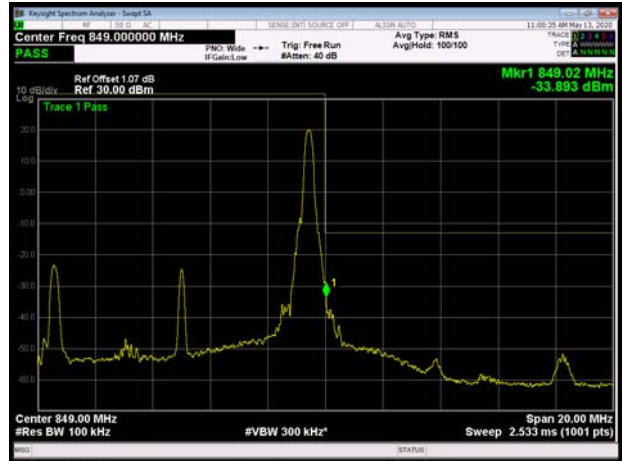

LTE Band 5 16QAM 10MHz CH-Low 100%RB

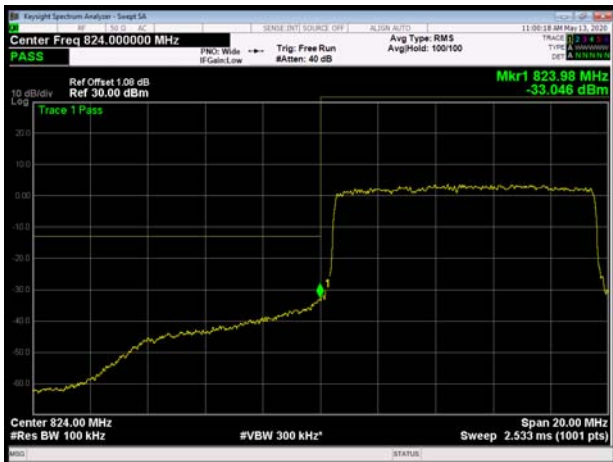

LTE Band 5 16QAM 10MHz CH-High 100%RB

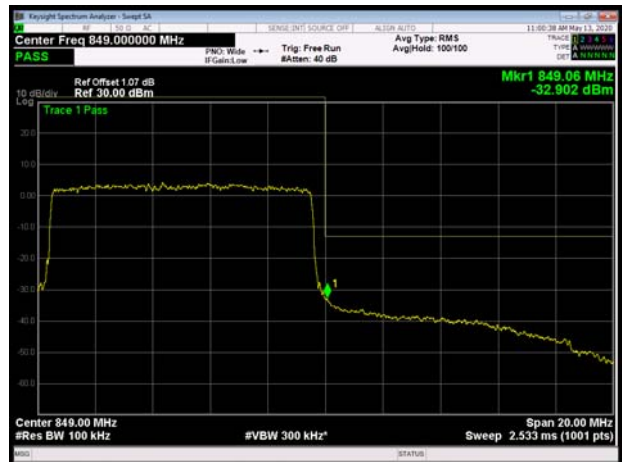

5.4. Peak-to-Average Power Ratio (PAPR)

Ambient condition

Temperature	Relative humidity	Pressure
23°C ~25°C	45%~50%	101.5kPa

Methods of Measurement

Measure the total peak power and record as P_{Pk} . And measure the total average power and record as P_{Avg} . Both the peak and average power levels must be expressed in the same logarithmic units (e.g., dBm). Determine the PAPR from:

$$PAPR (dB) = P_{Pk} (dBm) - P_{Avg} (dBm).$$

Test Setup

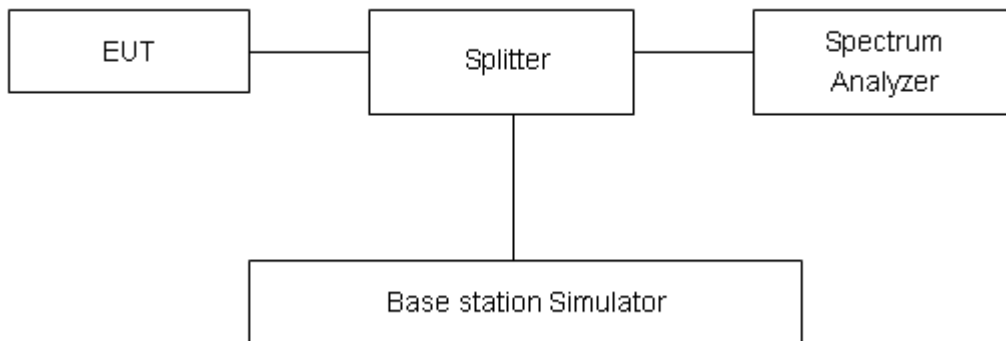

Limits

According to the Sec. 22.913(d), The peak-to-average ratio (PAR) of the transmission must not exceed 13 dB.

Measurement Uncertainty

The assessed measurement uncertainty to ensure 95% confidence level for the normal distribution is with the coverage factor $k = 2$, $U = 0.4$ dB.

Test Results

Mode	Channel	Frequency (MHz)	Peak (dBm)	Avg (dBm)	PAPR (dB)	Limit (dB)	Conclusion
GSM 850 (GSM)	128	824.2	34.65	33.67	0.98	≤13	PASS
	190	836.6	34.35	33.48	0.87	≤13	PASS
	251	848.8	34.58	33.65	0.93	≤13	PASS
GPRS 850 (GMSK)	128	824.2	30.62	29.60	1.02	≤13	PASS
	190	836.6	30.59	29.54	1.05	≤13	PASS
	251	848.8	30.62	29.61	1.01	≤13	PASS
EGPRS 850 (8-PSK)	128	824.2	30.55	29.43	1.12	≤13	PASS
	190	836.6	30.52	29.46	1.06	≤13	PASS
	251	848.8	30.72	29.61	1.11	≤13	PASS
WCDMA Band V (RMC)	4132	826.4	26.68	23.80	2.88	≤13	PASS
	4183	836.6	26.87	23.98	2.89	≤13	PASS
	4233	846.6	26.82	23.89	2.93	≤13	PASS

LTE Band 5								
Modulation	Bandwidth (MHz)	Channel	Frequency (MHz)	Peak (dBm)	Avg (dBm)	PAPR (dB)	Limit (dB)	Conclusion
QPSK	1.4	20407	824.7	28.17	23.07	5.10	≤13	PASS
		20525	836.5	28.03	23.03	5.00	≤13	PASS
		20643	848.3	28.10	23.07	5.03	≤13	PASS
	3	20415	825.5	28.38	23.16	5.22	≤13	PASS
		20525	836.5	28.23	23.08	5.15	≤13	PASS
		20635	847.5	28.29	23.12	5.17	≤13	PASS
	5	20425	826.5	28.34	23.14	5.20	≤13	PASS
		20525	836.5	28.19	23.04	5.15	≤13	PASS
		20625	846.5	28.21	23.07	5.14	≤13	PASS
	10	20450	829	28.31	23.11	5.20	≤13	PASS
		20525	836.5	28.13	22.99	5.14	≤13	PASS
		20600	844	28.14	23.03	5.11	≤13	PASS
16QAM	1.4	20407	824.7	27.41	21.52	5.89	≤13	PASS
		20525	836.5	27.52	21.72	5.80	≤13	PASS
		20643	848.3	27.64	21.77	5.87	≤13	PASS
	3	20415	825.5	27.58	21.56	6.02	≤13	PASS
		20525	836.5	27.75	21.77	5.98	≤13	PASS
		20635	847.5	27.76	21.79	5.97	≤13	PASS
	5	20425	826.5	27.51	21.53	5.98	≤13	PASS
		20525	836.5	27.66	21.72	5.94	≤13	PASS
		20625	846.5	27.64	21.75	5.89	≤13	PASS
	10	20450	829	27.51	21.51	6.00	≤13	PASS
		20525	836.5	27.61	21.68	5.93	≤13	PASS
		20600	844	27.62	21.72	5.90	≤13	PASS

5.5. Frequency Stability

Ambient condition

Temperature	Relative humidity	Pressure
23°C ~25°C	45%~50%	101.5kPa

Method of Measurement

Frequency Stability (Temperature Variation)

The temperature inside the climate chamber is varied from -40°C to +85°C in 10°C step size,

(1) With all power removed, the temperature was decreased to 0°C and permitted to stabilize for three hours.

(2) Measure the carrier frequency with the test equipment in a “call mode”. These measurements should be made within 1 minute of powering up the mobile station, to prevent significant self warming.

(3) Repeat the above measurements at 10°C increments from -40°C to +85°. Allow at least 1.5 hours at each temperature, un-powered, before making measurements.

Frequency Stability (Voltage Variation)

The frequency stability shall be measured with variation of primary supply voltage as follows:

(1) Vary primary supply voltage from 85 to 115 percent of the nominal value for other than hand carried battery equipment.

(2) For hand carried, battery powered equipment, reduce primary supply voltage to the battery-operating end point which shall be specified by the manufacturer.

This transceiver is specified to operate with an input voltage of between 3.3 V and 4.3 V, with a nominal voltage of 3.8V.

Test setup

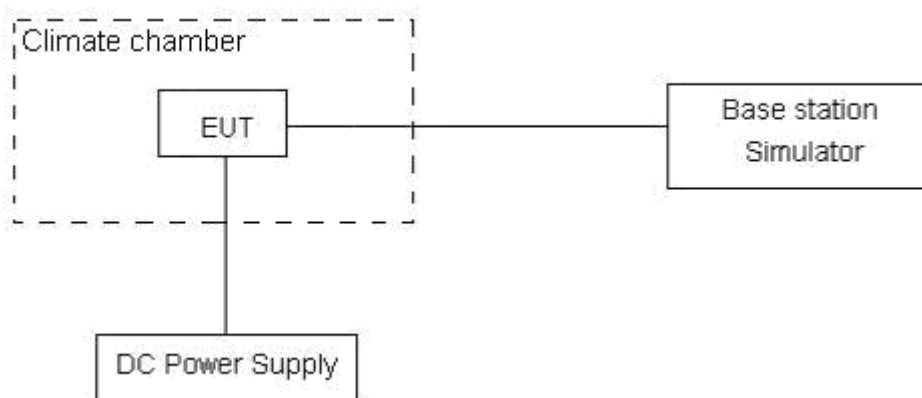



Limits

According to the Sec. 22.355, the frequency stability of the carrier shall be accurate to within 2.5 ppm of the received frequency for mobile stations.

Limits	≤ 2.5 ppm
--------	----------------

Measurement Uncertainty

The assessed measurement uncertainty to ensure 99.75% confidence level for the normal distribution is with the coverage factor $k = 3$, $U = 0.01$ ppm.

Test Result

GSM850						
Condition		Freq.Error (Hz)	Freq.Error (Hz)	Frequency Stability (ppm)	Frequency Stability (ppm)	Verdict
Temperature	Voltage	GMSK	8PSK	GMSK	8PSK	
Normal (25°C)	Normal	6.30	12.29	0.00335	0.00654	PASS
Extreme (85°C)		1.80	3.15	0.00096	0.00168	PASS
Extreme (80°C)		11.83	5.44	0.00629	0.00289	PASS
Extreme (70°C)		4.46	4.77	0.00237	0.00254	PASS
Extreme (60°C)		2.46	9.47	0.00131	0.00504	PASS
Extreme (50°C)		2.42	7.83	0.00129	0.00417	PASS
Extreme (40°C)		17.43	4.25	0.00927	0.00226	PASS
Extreme (30°C)		6.74	14.26	0.00359	0.00759	PASS
Extreme (20°C)		15.39	12.08	0.00819	0.00643	PASS
Extreme (10°C)		15.50	13.01	0.00825	0.00692	PASS
Extreme (0°C)		10.94	13.47	0.00582	0.00716	PASS
Extreme (-10°C)		15.80	6.73	0.00840	0.00358	PASS
Extreme (-20°C)		17.69	13.27	0.00941	0.00706	PASS
Extreme (-30°C)		1.25	14.10	0.00066	0.00750	PASS
Extreme (-40°C)		2.27	9.59	0.00121	0.00510	PASS
25°C		LV	14.54	4.61	0.00774	0.00245
	HV	10.55	2.95	0.00561	0.00157	PASS

WCDMA Band 5						
Condition		Freq.Error (Hz)	Freq.Error (Hz)	Frequency Stability (ppm)	Frequency Stability (ppm)	Verdict
Temperature	Voltage	BPSK	QPSK	BPSK	QPSK	
Normal (25°C)	Normal	10.54	13.49	0.00561	0.00717	PASS
Extreme (85°C)		11.20	11.74	0.00596	0.00624	PASS
Extreme (80°C)		9.39	10.15	0.00500	0.00540	PASS
Extreme (70°C)		16.43	2.75	0.00874	0.00146	PASS
Extreme (60°C)		1.64	9.08	0.00087	0.00483	PASS
Extreme (50°C)		9.39	12.90	0.00499	0.00686	PASS
Extreme (40°C)		8.18	11.06	0.00435	0.00588	PASS
Extreme (30°C)		6.90	6.60	0.00367	0.00351	PASS
Extreme (20°C)		6.97	16.30	0.00371	0.00867	PASS
Extreme (10°C)		13.79	15.86	0.00734	0.00843	PASS
Extreme (0°C)		13.25	10.27	0.00705	0.00547	PASS
Extreme (-10°C)		17.11	11.28	0.00910	0.00600	PASS
Extreme (-20°C)		17.77	4.51	0.00945	0.00240	PASS
Extreme (-30°C)		15.33	1.04	0.00815	0.00055	PASS
Extreme (-40°C)		1.48	4.12	0.00079	0.00219	PASS
25°C	LV	13.15	1.98	0.00699	0.00105	PASS
	HV	11.70	8.88	0.00622	0.00472	PASS

LTE Band 5						
Condition		Freq.Error (Hz)	Freq.Error (Hz)	Frequency Stability (ppm)	Frequency Stability (ppm)	Verdict
BANDWIDTH	1.4MHz					
Temperature	Voltage	16QAM	QPSK	16QAM	QPSK	
Normal (25°C)	Normal	3.96	9.13	0.00211	0.00485	PASS
Extreme (85°C)		14.06	16.22	0.00748	0.00863	PASS
Extreme (80°C)		8.99	17.77	0.00478	0.00945	PASS
Extreme (70°C)		5.11	5.47	0.00272	0.00291	PASS
Extreme (60°C)		7.72	10.17	0.00411	0.00541	PASS
Extreme (50°C)		13.38	11.00	0.00712	0.00585	PASS
Extreme (40°C)		15.05	10.40	0.00800	0.00553	PASS
Extreme (30°C)		11.66	13.50	0.00620	0.00718	PASS
Extreme (20°C)		2.65	10.83	0.00141	0.00576	PASS
Extreme (10°C)		1.25	9.01	0.00067	0.00479	PASS
Extreme (0°C)		5.94	11.65	0.00316	0.00620	PASS



Extreme (-10°C)		13.56	9.40	0.00722	0.00500	PASS
Extreme (-20°C)		9.60	11.12	0.00511	0.00591	PASS
Extreme (-30°C)		1.63	2.25	0.00086	0.00120	PASS
Extreme (-40°C)		12.37	2.65	0.00658	0.00141	PASS
25°C	LV	11.75	14.48	0.00625	0.00770	PASS
	HV	10.00	15.41	0.00532	0.00820	PASS
Condition		Freq.Error (Hz)	Freq.Error (Hz)	Frequency Stability (ppm)	Frequency Stability (ppm)	Verdict
BANDWIDTH	3MHz					
Temperature	Voltage	16QAM	QPSK	16QAM	QPSK	
Normal (25°C)	Normal	7.11	17.16	0.00378	0.00913	PASS
Extreme (85°C)		15.75	17.62	0.00838	0.00937	PASS
Extreme (80°C)		4.39	7.71	0.00234	0.00410	PASS
Extreme (70°C)		8.92	14.00	0.00474	0.00745	PASS
Extreme (60°C)		6.68	9.08	0.00356	0.00483	PASS
Extreme (50°C)		1.99	2.32	0.00106	0.00124	PASS
Extreme (40°C)		7.72	15.11	0.00411	0.00804	PASS
Extreme (30°C)		13.00	15.63	0.00691	0.00831	PASS
Extreme (20°C)		6.03	8.32	0.00321	0.00443	PASS
Extreme (10°C)		2.28	15.86	0.00121	0.00843	PASS
Extreme (0°C)		3.22	15.15	0.00171	0.00806	PASS
Extreme (-10°C)		14.64	13.52	0.00779	0.00719	PASS
Extreme (-20°C)		12.45	6.25	0.00662	0.00332	PASS
Extreme (-30°C)		10.29	6.14	0.00547	0.00327	PASS
Extreme (-40°C)		13.41	8.99	0.00713	0.00478	PASS
25°C		LV	2.01	11.68	0.00107	0.00621
	HV	11.23	13.58	0.00597	0.00723	PASS
Condition		Freq.Error (Hz)	Freq.Error (Hz)	Frequency Stability (ppm)	Frequency Stability (ppm)	Verdict
BANDWIDTH	5MHz					
Temperature	Voltage	16QAM	QPSK	16QAM	QPSK	
Normal (25°C)	Normal	9.30	10.33	0.00495	0.00550	PASS
Extreme (85°C)		15.63	3.23	0.00832	0.00172	PASS
Extreme (80°C)		3.88	8.75	0.00206	0.00466	PASS
Extreme (70°C)		1.55	14.73	0.00082	0.00784	PASS
Extreme (60°C)		3.67	17.11	0.00195	0.00910	PASS
Extreme (50°C)		17.51	1.06	0.00931	0.00056	PASS
Extreme (40°C)		17.45	1.17	0.00928	0.00062	PASS
Extreme (30°C)		16.14	16.29	0.00859	0.00866	PASS
Extreme (20°C)		9.30	9.97	0.00495	0.00530	PASS
Extreme (10°C)		12.95	2.01	0.00689	0.00107	PASS



Extreme (0°C)		14.92	3.22	0.00794	0.00171	PASS
Extreme (-10°C)		14.99	4.57	0.00797	0.00243	PASS
Extreme (-20°C)		8.65	16.15	0.00460	0.00859	PASS
Extreme (-30°C)		9.63	15.01	0.00512	0.00798	PASS
Extreme (-40°C)		17.51	14.61	0.00931	0.00777	PASS
25°C	LV	14.66	13.08	0.00780	0.00696	PASS
	HV	4.39	8.86	0.00233	0.00471	PASS
Condition		Freq.Error (Hz)	Freq.Error (Hz)	Frequency Stability (ppm)	Frequency Stability (ppm)	Verdict
BANDWIDTH	10MHz					
Temperature	Voltage	16QAM	QPSK	16QAM	QPSK	
Normal (25°C)	Normal	15.11	15.55	0.00804	0.00827	PASS
Extreme (85°C)		2.28	6.92	0.00122	0.00368	PASS
Extreme (80°C)		6.45	16.38	0.00343	0.00871	PASS
Extreme (70°C)		9.36	11.32	0.00498	0.00602	PASS
Extreme (60°C)		14.55	10.83	0.00774	0.00576	PASS
Extreme (50°C)		17.30	1.71	0.00920	0.00091	PASS
Extreme (40°C)		1.96	3.65	0.00104	0.00194	PASS
Extreme (30°C)		2.30	7.46	0.00122	0.00397	PASS
Extreme (20°C)		14.01	8.94	0.00745	0.00476	PASS
Extreme (10°C)		17.21	5.60	0.00915	0.00298	PASS
Extreme (0°C)		8.25	13.53	0.00439	0.00720	PASS
Extreme (-10°C)		16.50	1.84	0.00877	0.00098	PASS
Extreme (-20°C)		4.27	5.22	0.00227	0.00278	PASS
Extreme (-30°C)		1.75	3.90	0.00093	0.00207	PASS
Extreme (-40°C)		12.38	9.48	0.00658	0.00504	PASS
25°C	LV	3.36	9.28	0.00179	0.00494	PASS
	HV	5.08	11.32	0.00270	0.00602	PASS

5.6. Spurious Emissions at Antenna Terminals

Ambient condition

Temperature	Relative humidity	Pressure
23°C ~25°C	45%~50%	101.5kPa

Method of Measurement

The EUT was connected to Spectrum Analyzer and Base Station Simulator via power Splitter. The measurement is carried out using a spectrum analyzer. The spectrum analyzer scans from 9kHz to the 10th harmonic of the carrier.

The peak detector is used. RBW are set to 100 kHz and VBW are set to 300 kHz for below 1G, RBW are set to 1MHz and VBW are set to 3MHz for above 1G, Sweep is set to ATUO.

The modulation mode and RB allocation refer to section 5.1, using the maximum output power configuration.

Test setup

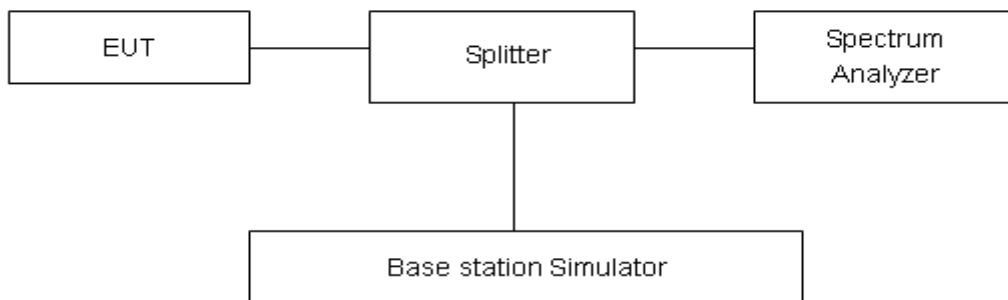

Limits

Rule Part 22.917(a) specifies that “The power of any emission outside of the authorized operating frequency ranges must be attenuated below the transmitting power (P) by a factor of at least 43 + 10 log (P) dB.”

Limit	-13 dBm
-------	---------

Measurement Uncertainty

The assessed measurement uncertainty to ensure 99.75% confidence level for the normal distribution is with the coverage factor $k = 1.96$.

Frequency	Uncertainty
9kHz-1GHz	0.684 dB
1GHz-18GHz	1.407 dB



Test Result

Sweep the whole frequency band through the range from 9kHz to the 10th harmonic of the carrier, the emissions more than 20 dB below the limit are not reported.

The signal beyond the limit is carrier.

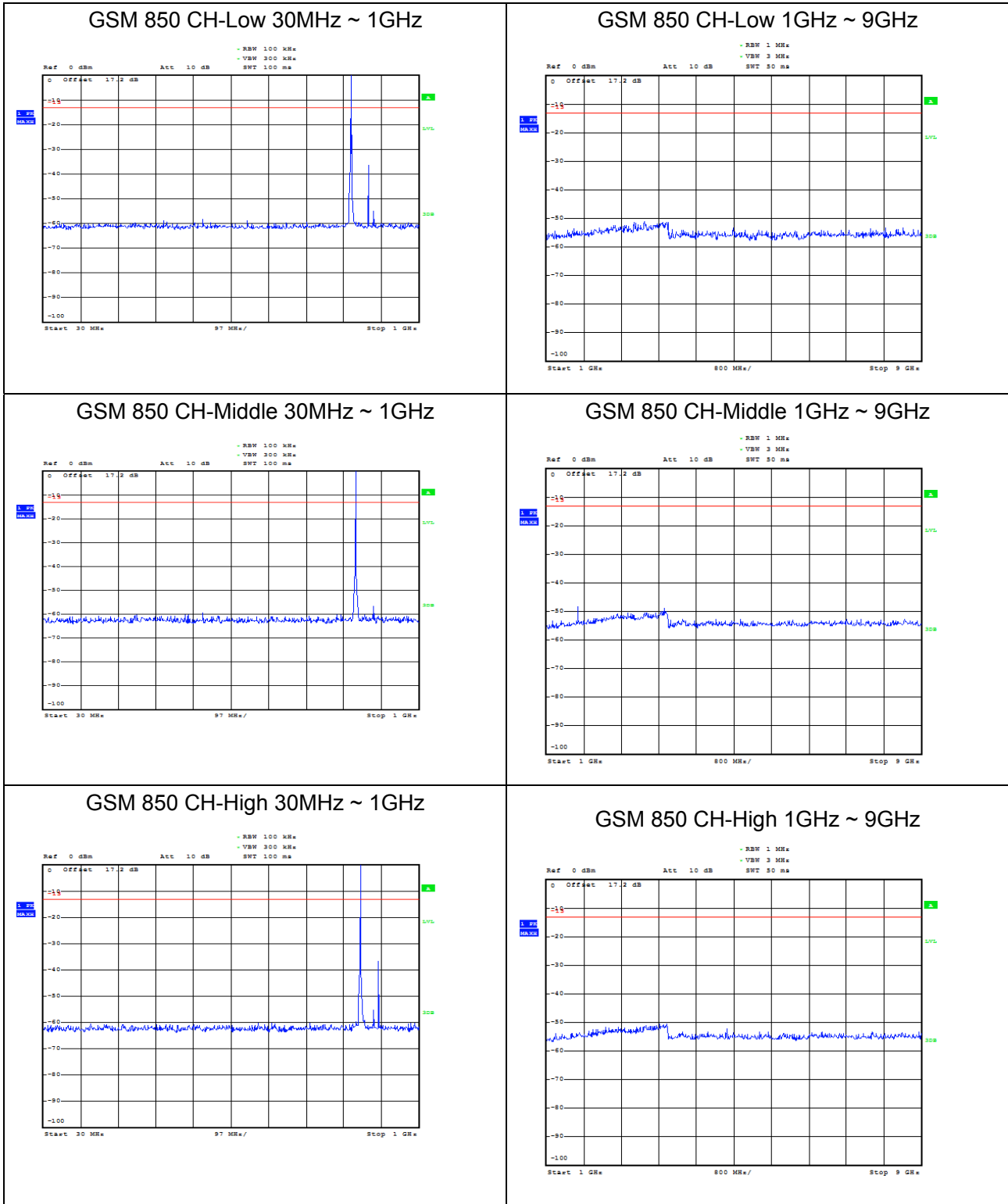



WCDMA Band V CH-Low 30MHz ~ 1GHz

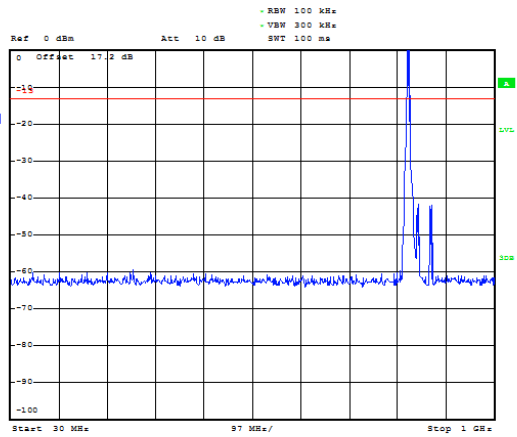

WCDMA Band V CH-Low 1GHz ~ 9GHz

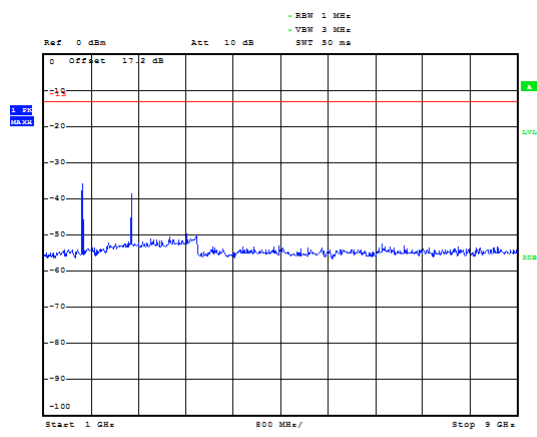

WCDMA Band V CH-Middle 30MHz ~ 1GHz

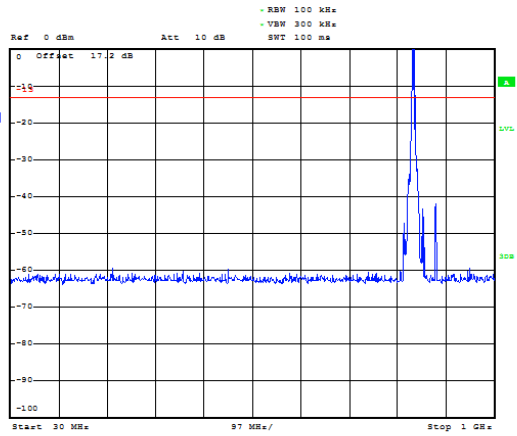

WCDMA Band V CH-Middle 1GHz ~ 9GHz

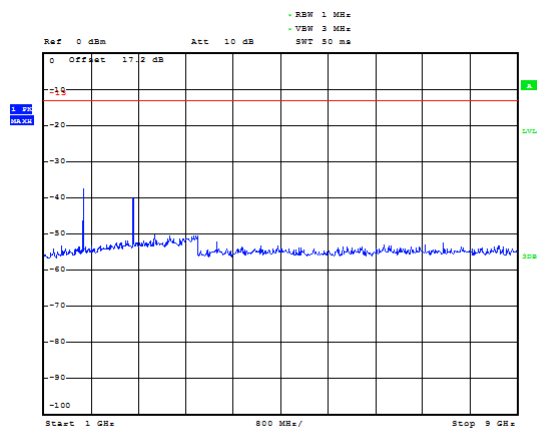

WCDMA Band V CH-High 30MHz ~ 1GHz

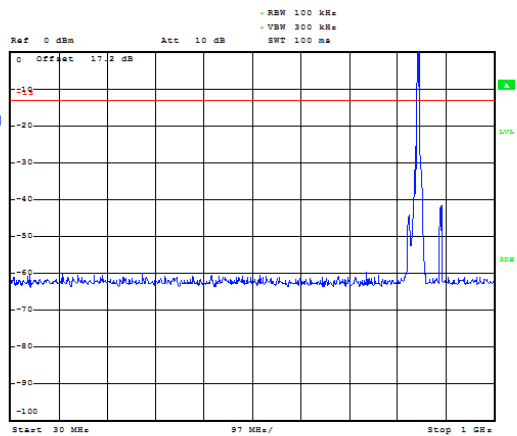

WCDMA Band V CH-High 1GHz ~ 9GHz

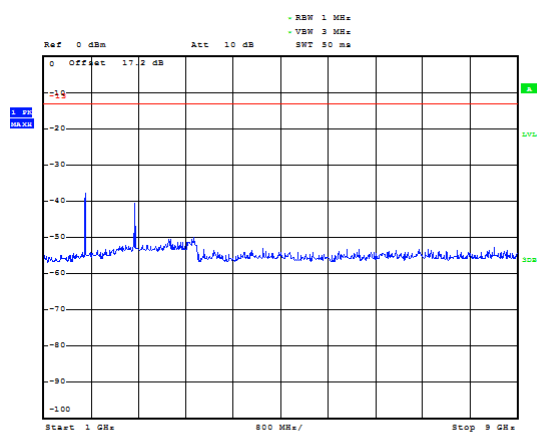



LTE Band 5 1.4MHz CH-Low 30MHz~1GHz

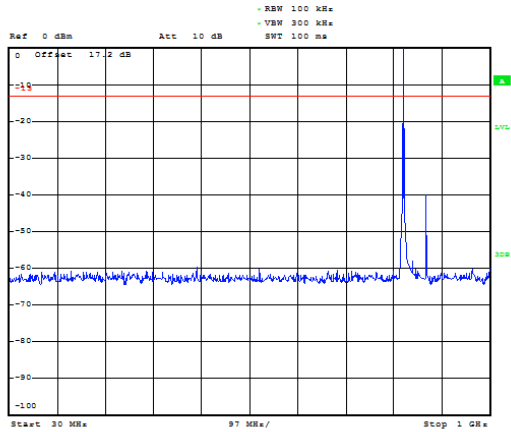

LTE Band 5 1.4MHz CH-Low 1GHz~9GHz

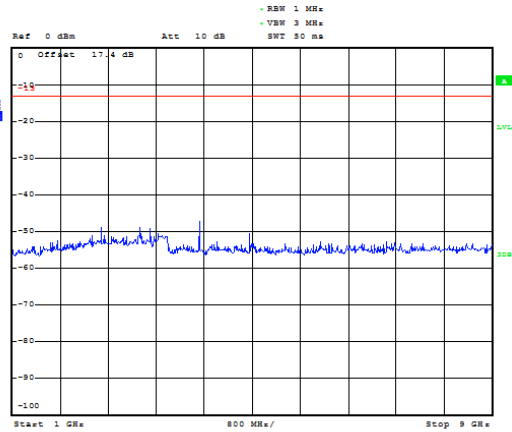

LTE Band 5 1.4MHz CH-Middle 30MHz~1GHz

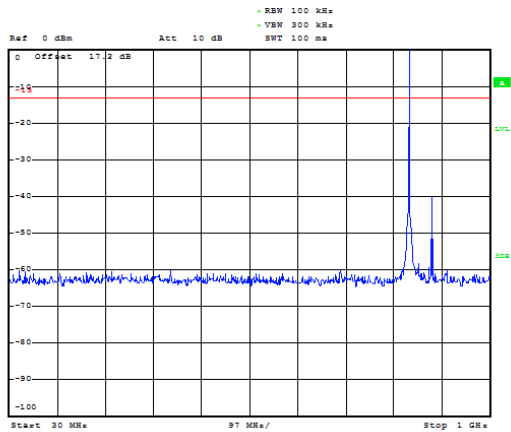

LTE Band 5 1.4MHz CH-Middle 1GHz~9GHz

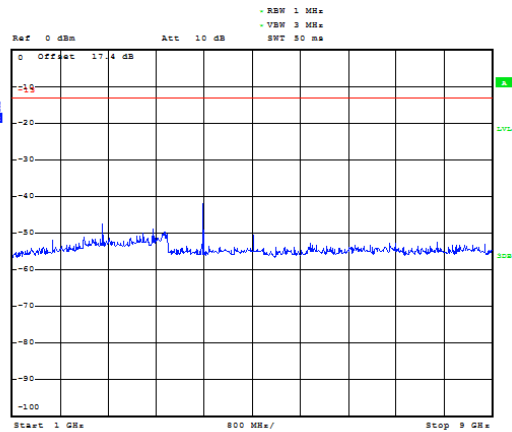

LTE Band 5 1.4MHz CH-High 30MHz~1GHz

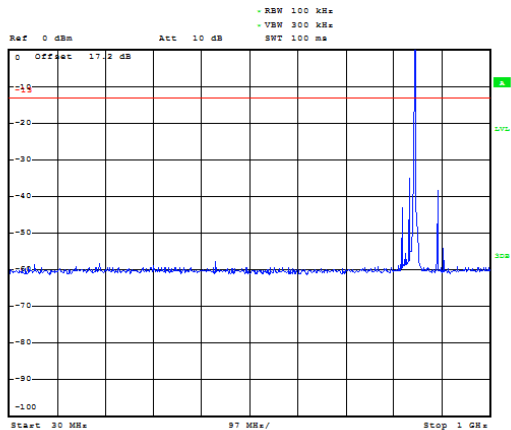

LTE Band 5 1.4MHz CH-High 1GHz~9GHz

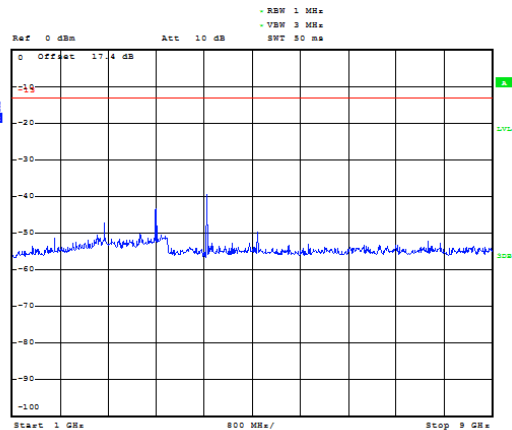



LTE Band 5 3MHz CH-Low 30MHz~1GHz

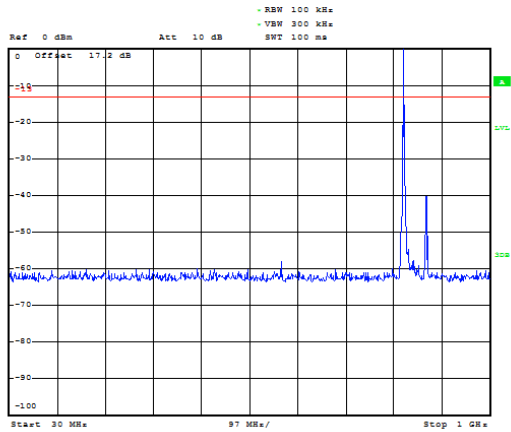

LTE Band 5 3MHz CH-Low 1GHz~9GHz

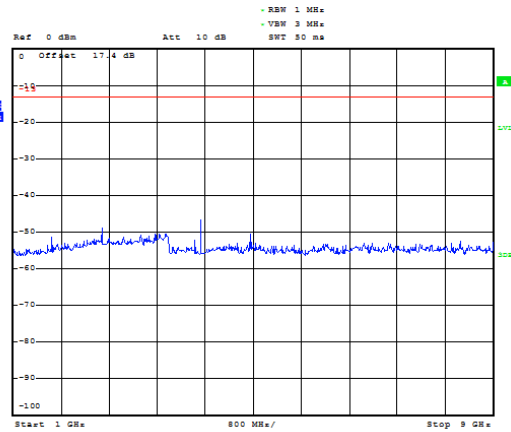

LTE Band 5 3MHz CH-Middle 30MHz~1GHz

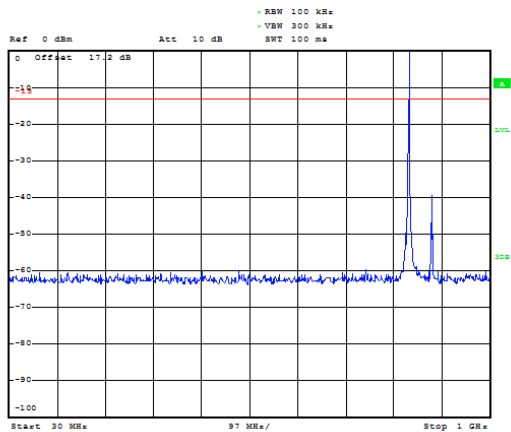

LTE Band 5 3MHz CH-Middle 1GHz~9GHz

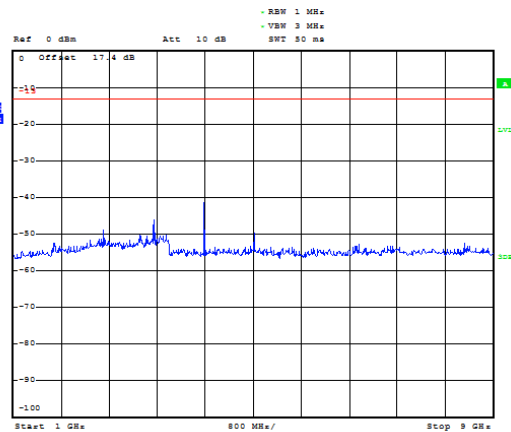

LTE Band 5 3MHz CH-High 30MHz~1GHz

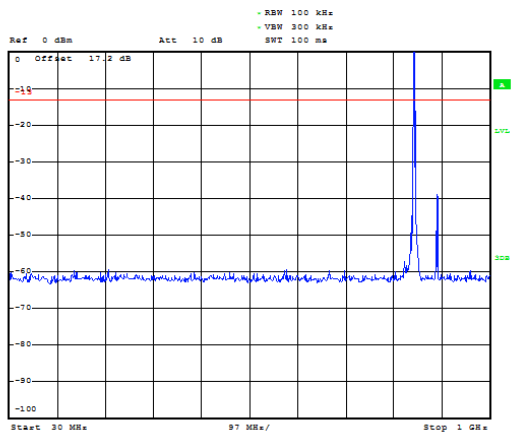

LTE Band 5 3MHz CH-High 1GHz~9GHz

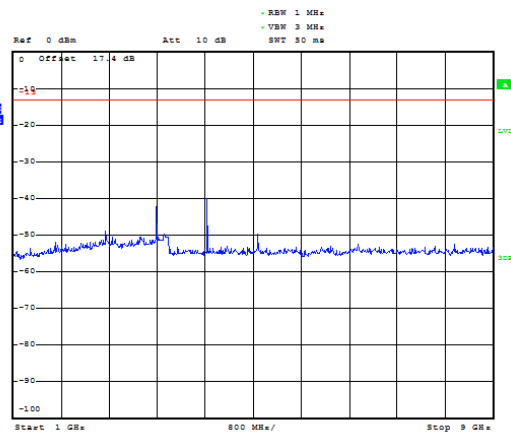



LTE Band 5 5MHz CH-Low 30MHz~1GHz

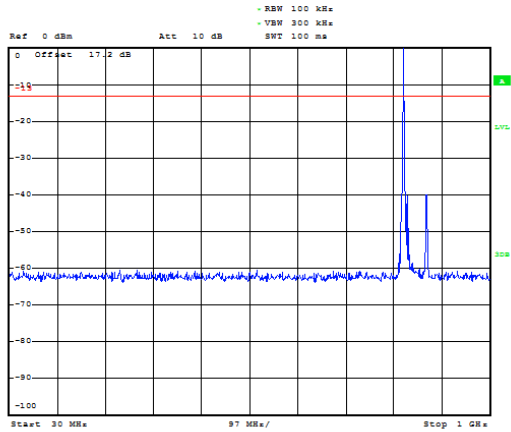

LTE Band 5 5MHz CH-Low 1GHz~9GHz

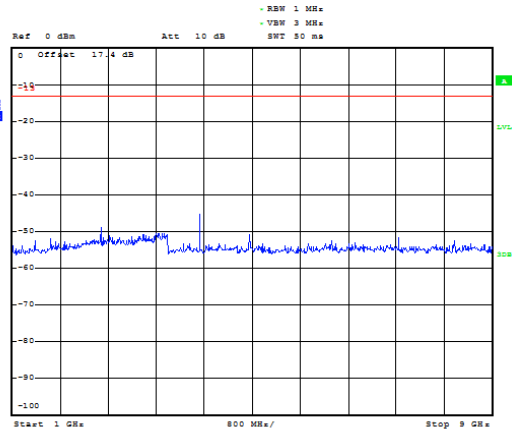

LTE Band 5 5MHz CH-Middle 30MHz~1GHz

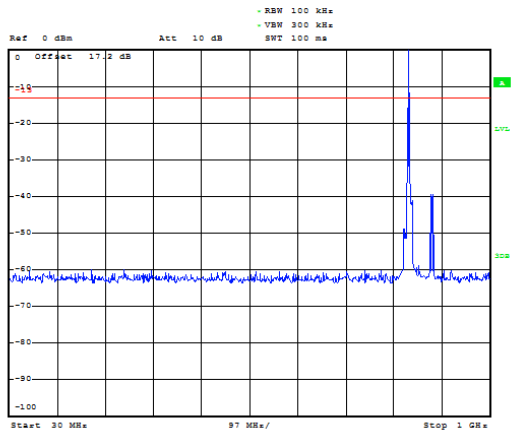

LTE Band 5 5MHz CH-Middle 1GHz~9GHz

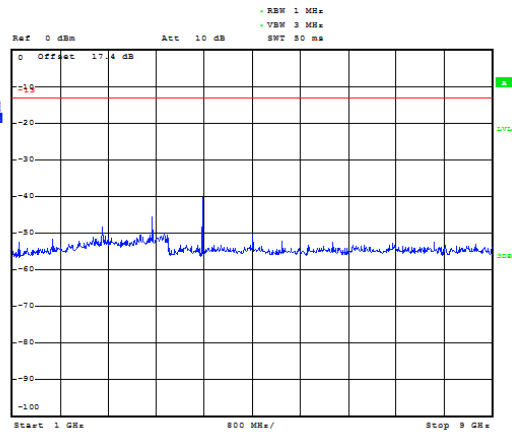

LTE Band 5 5MHz CH-High 30MHz~1GHz

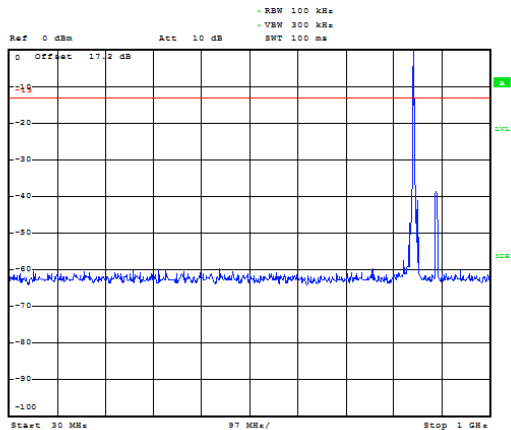

LTE Band 5 5MHz CH-High 1GHz~9GHz

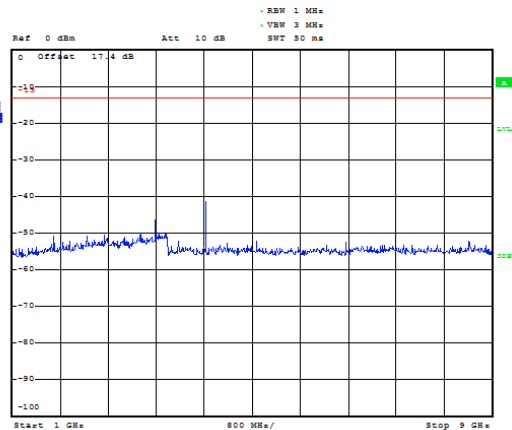



LTE Band 5 10MHz CH-Low 30MHz~1GHz

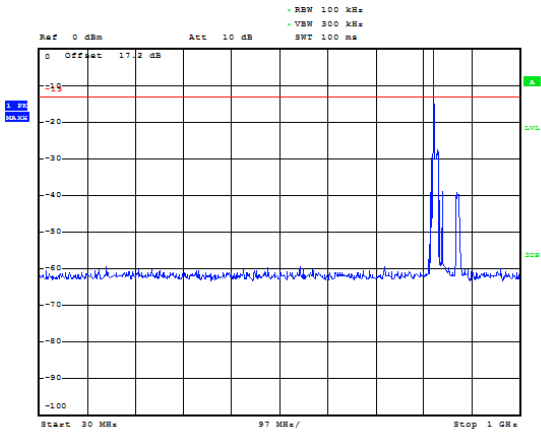

LTE Band 5 10MHz CH-Low 1GHz~9GHz

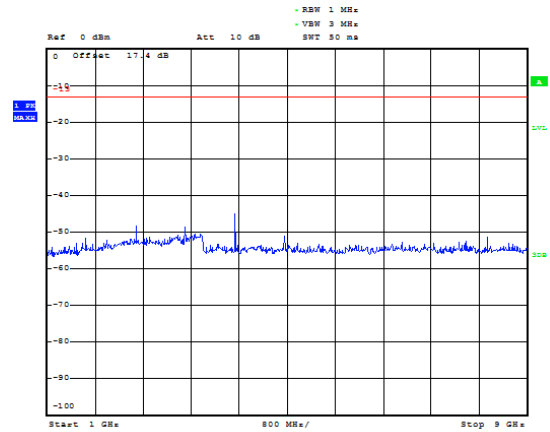

LTE Band 5 10MHz CH-Middle 30MHz~1GHz

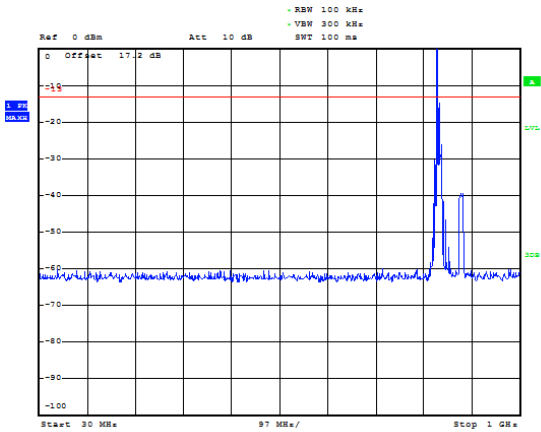

LTE Band 5 10MHz CH-Middle 1GHz~9GHz

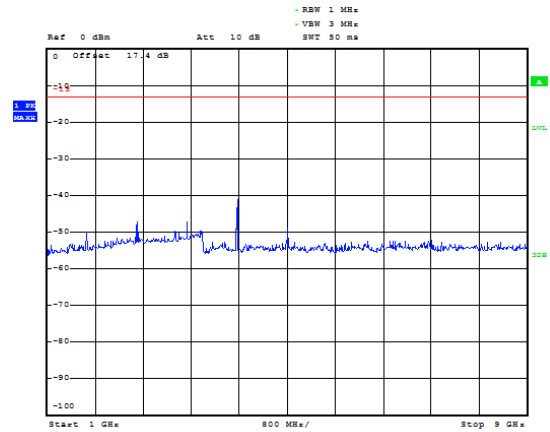

LTE Band 5 10MHz CH-High 30MHz~1GHz

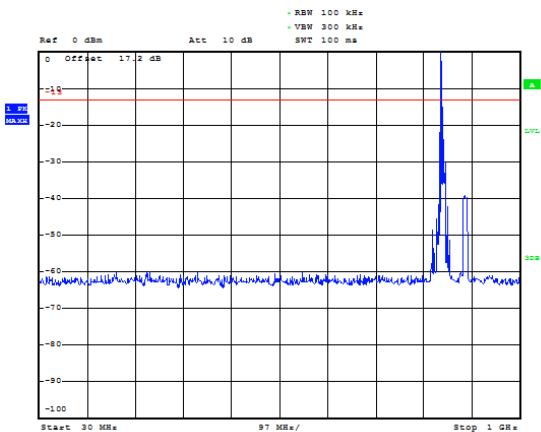

LTE Band 5 10MHz CH-High 1GHz~9GHz

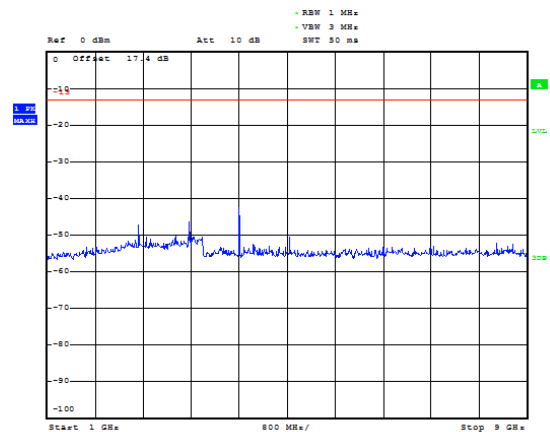

5.7. Radiates Spurious Emission

Ambient condition

Temperature	Relative humidity	Pressure
23°C ~25°C	45%~50%	101.5kPa

Method of Measurement

1. The testing follows FCC KDB 971168 v03r01 Section 5.8 and ANSI C63.26 (2015).
2. Below 1GHz: The EUT is placed on a turntable 0.8 meters above the ground in the chamber, 3 meter away from the antenna. The maximal emission value is acquired by adjusting the antenna height, polarisation and turntable azimuth. Normally, the height range of antenna is 1 m to 4 m, the azimuth range of turntable is 0° to 360°, and the receive antenna has two polarizations Vertical (V) and Horizontal (H). Above 1GHz: (Note: the FCC's permission to use 1.5m as an alternative per TCBC Conf call of Dec. 2, 2014.) The EUT is placed on a turntable 1.5 meters above the ground in the chamber, 3 meter away from the antenna. The maximal emission value is acquired by adjusting the antenna height, polarisation and turntable azimuth. Normally, the height range of antenna is 1 m to 4 m, the azimuth range of turntable is 0° to 360°, and the receive antenna has two polarizations Vertical (V) and Horizontal (H).
3. A loop antenna, A log-periodic antenna or horn antenna shall be substituted in place of the EUT. The log-periodic antenna will be driven by a signal generator and the level will be adjusted till the same power value on the spectrum analyzer or receiver. The level of the spurious emissions can be calculated through the level of the signal generator, cable loss, the gain of the substitution antenna and the reading of the spectrum analyzer or receiver.
4. The EUT is then put into continuously transmitting mode at its maximum power level during the test. Set Test Receiver or Spectrum RBW=100kHz,VBW=300kHz, and the maximum value of the receiver should be recorded as (Pr).
5. The EUT shall be replaced by a substitution antenna. In the chamber, an substitution antenna for the frequency band of interest is placed at the reference point of the chamber. An RF Signal source for the frequency band of interest is connected to the substitution antenna with a cable that has been constructed to not interfere with the radiation pattern of the antenna. A power (PMea) is applied to the input of the substitution antenna, and adjust the level of the signal generator output until the value of the receiver reach the previously recorded (Pr). The power of signal source (PMea) is recorded. The test should be performed by rotating the test item and adjusting the receiving antenna polarization.
6. A amplifier should be connected to the Signal Source output port. And the cable should be connect between the Amplifier and the Substitution Antenna. The cable loss (Pcl), the Substitution Antenna Gain (Ga) and the Amplifier Gain (PAg) should be recorded after test.
7. The measurement results are obtained as described below:
Power(EIRP)=PMea- PAg - Pcl + Ga
The measurement results are amend as described below:
Power(EIRP)=PMea- Pcl + Ga
8. This value is EIRP since the measurement is calibrated using an antenna of known gain (2.15 dBi) and known input power. ERP can be calculated from EIRP by subtracting the gain of the dipole, ERP

= EIRP-2.15dBi.

The modulation mode and RB allocation refer to section 5.1, using the maximum output power configuration.

Test setup

9KHz ~ 30MHz

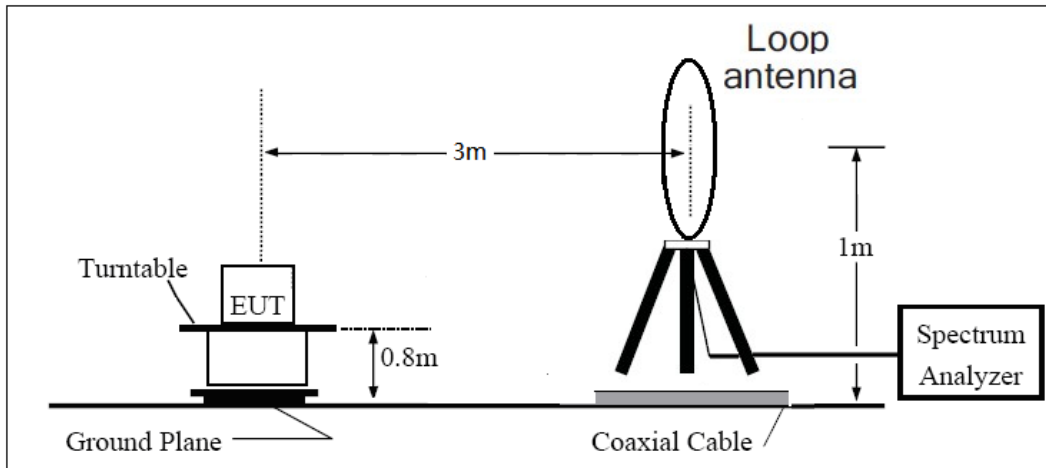

30MHz ~ 1GHz

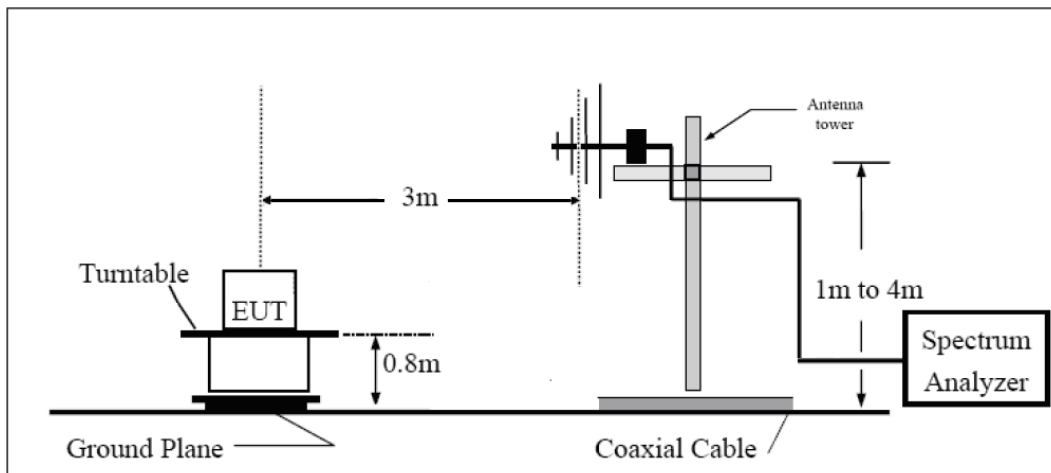

Above 1GHz

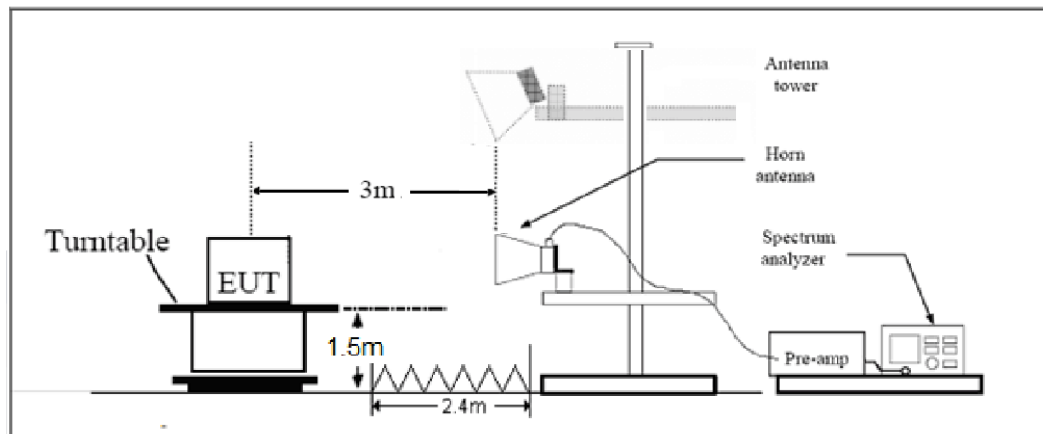

Note: Area side:2.4mX3.6m

**Limits**

Rule Part 22.917(a) specifies that “The power of any emission outside of the authorized operating frequency ranges must be attenuated below the transmitting power (P) by a factor of at least $43 + 10 \log (P)$ dB.”

Limit	-13 dBm
-------	---------

Measurement Uncertainty

The assessed measurement uncertainty to ensure 95% confidence level for the normal distribution is with the coverage factor $k = 1.96$, $U = 3.55$ dB.

**Test Result**

Sweep the whole frequency band through the range from 9kHz to the 10th harmonic of the carrier, the emissions below the noise floor will not be recorded in the report.

GSM 850 CH-Middle

Harmonic	Frequency (MHz)	SG (dBm)	Cable Loss (dB)	Gain (dBi)	Antenna Polarization	ERP Level (dBm)	Limit (dBm)	Margin (dB)	Azimuth (deg)
2	1672.9	-45.05	1.70	8.70	Horizontal	-40.20	-13.00	27.20	270
3	2509.8	-52.46	2.30	12.00	Horizontal	-44.91	-13.00	31.91	90
4	3346.4	-61.71	2.70	12.70	Horizontal	-53.86	-13.00	40.86	135
5	4183.0	-58.95	3.00	12.50	Horizontal	-51.60	-13.00	38.60	225
6	5019.6	-56.05	3.40	12.50	Horizontal	-49.10	-13.00	36.10	180
7	5856.2	-58.24	3.40	12.80	Horizontal	-50.99	-13.00	37.99	315
8	6692.8	-57.73	4.10	11.50	Horizontal	-52.48	-13.00	39.48	135
9	7529.4	-54.36	4.20	12.20	Horizontal	-48.51	-13.00	35.51	0
10	8366.0	-55.58	4.30	12.50	Horizontal	-49.53	-13.00	36.53	45

Note: 1.The other Spurious RF Radiated emissions level is no more than noise floor.

2.The worst emission was found in the antenna is Horizontal position.

WCDMA Band V CH-Middle

Harmonic	Frequency (MHz)	SG (dBm)	Cable Loss (dB)	Gain (dBi)	Antenna Polarization	ERP Level (dBm)	Limit (dBm)	Margin (dB)	Azimuth (deg)
2	1673.2	-64.39	1.70	8.70	Horizontal	-59.54	-13.00	46.54	90
3	2509.8	-63.36	2.30	12.00	Horizontal	-55.81	-13.00	42.81	135
4	3346.4	-61.34	2.70	12.70	Horizontal	-53.49	-13.00	40.49	45
5	4183.0	-59.45	3.00	12.50	Horizontal	-52.10	-13.00	39.10	180
6	5019.6	-57.17	3.40	12.50	Horizontal	-50.22	-13.00	37.22	315
7	5856.2	-58.06	3.40	12.80	Horizontal	-50.81	-13.00	37.81	225
8	6692.8	-57.67	4.10	11.50	Horizontal	-52.42	-13.00	39.42	45
9	7529.4	-53.66	4.20	12.20	Horizontal	-47.81	-13.00	34.81	270
10	8366.0	-55.11	4.30	12.50	Horizontal	-49.06	-13.00	36.06	180

Note: 1.The other Spurious RF Radiated emissions level is no more than noise floor.

2.The worst emission was found in the antenna is Horizontal position.



LTE Band 5 1.4MHz CH-Middle

Harmonic	Frequency (MHz)	SG (dBm)	Cable Loss (dB)	Gain (dBi)	Antenna Polarization	ERP Level (dBm)	Limit (dBm)	Margin (dB)	Azimuth (deg)
2	1671.9	-65.08	1.70	8.70	Horizontal	-60.23	-13.00	47.23	135
3	2507.9	-50.02	2.30	12.00	Horizontal	-42.47	-13.00	29.47	45
4	3343.9	-50.36	2.70	12.70	Horizontal	-42.51	-13.00	29.51	270
5	4180.1	-55.66	3.00	12.50	Horizontal	-48.31	-13.00	35.31	180
6	5016.4	-57.52	3.40	12.50	Horizontal	-50.57	-13.00	37.57	90
7	5852.6	-58.68	3.40	12.80	Horizontal	-51.43	-13.00	38.43	315
8	6688.9	-58.31	4.10	11.50	Horizontal	-53.06	-13.00	40.06	225
9	7525.1	-54.14	4.20	12.20	Horizontal	-48.29	-13.00	35.29	135
10	8361.4	-55.05	4.30	12.50	Horizontal	-49.00	-13.00	36.00	45

Note: 1.The other Spurious RF Radiated emissions level is no more than noise floor.

2.The worst emission was found in the antenna is Horizontal position.

LTE Band 5 5MHz CH-Middle

Harmonic	Frequency (MHz)	SG (dBm)	Cable Loss (dB)	Gain (dBi)	Antenna Polarization	ERP Level (dBm)	Limit (dBm)	Margin (dB)	Azimuth (deg)
2	1673.0	-64.07	1.70	8.70	Horizontal	-59.22	-13.00	46.22	270
3	2509.5	-60.91	2.30	12.00	Horizontal	-53.36	-13.00	40.36	135
4	3346.0	-65.81	2.70	12.70	Horizontal	-57.96	-13.00	44.96	180
5	4182.5	-65.97	3.00	12.50	Horizontal	-58.62	-13.00	45.62	90
6	5019.0	-63.45	3.40	12.50	Horizontal	-56.50	-13.00	43.50	270
7	5855.5	-64.29	3.40	12.80	Horizontal	-57.04	-13.00	44.04	135
8	6692.0	-57.54	4.10	11.50	Horizontal	-52.29	-13.00	39.29	90
9	7528.5	-61.28	4.20	12.20	Horizontal	-55.43	-13.00	42.43	315
10	8365.0	-59.40	4.30	12.50	Horizontal	-53.35	-13.00	40.35	180

Note: 1.The other Spurious RF Radiated emissions level is no more than noise floor.

2.The worst emission was found in the antenna is Horizontal position.

LTE Band 5 5MHz CH-High

Harmonic	Frequency (MHz)	SG (dBm)	Cable Loss (dB)	Gain (dBi)	Antenna Polarization	ERP Level (dBm)	Limit (dBm)	Margin (dB)	Azimuth (deg)
2	1668.6	-64.53	1.70	8.70	Horizontal	-59.68	-13.00	46.68	90
3	2502.8	-51.39	2.30	12.00	Horizontal	-43.84	-13.00	30.84	315
4	3337.1	-50.90	2.70	12.70	Horizontal	-43.05	-13.00	30.05	90
5	4171.9	-54.77	3.00	12.50	Horizontal	-47.42	-13.00	34.42	135
6	5006.6	-57.46	3.40	12.50	Horizontal	-50.51	-13.00	37.51	270
7	5841.4	-58.87	3.40	12.80	Horizontal	-51.62	-13.00	38.62	180
8	6676.1	-58.18	4.10	11.50	Horizontal	-52.93	-13.00	39.93	90
9	7510.9	-55.02	4.20	12.20	Horizontal	-49.17	-13.00	36.17	315
10	8345.6	-55.55	4.30	12.50	Horizontal	-49.50	-13.00	36.50	225

Note: 1.The other Spurious RF Radiated emissions level is no more than noise floor.
 2.The worst emission was found in the antenna is Horizontal position.

LTE Band 5 10MHz CH-Middle

Harmonic	Frequency (MHz)	SG (dBm)	Cable Loss (dB)	Gain (dBi)	Antenna Polarization	ERP Level (dBm)	Limit (dBm)	Margin (dB)	Azimuth (deg)
2	1664.3	-64.01	1.70	8.70	Horizontal	-59.16	-13.00	46.16	180
3	2496.2	-54.81	2.30	12.00	Horizontal	-47.26	-13.00	34.26	135
4	3328.1	-53.83	2.70	12.70	Horizontal	-45.98	-13.00	32.98	135
5	4160.3	-53.08	3.00	12.50	Horizontal	-45.73	-13.00	32.73	315
6	4992.4	-57.62	3.40	12.50	Horizontal	-50.67	-13.00	37.67	180
7	5824.5	-57.79	3.40	12.80	Horizontal	-50.54	-13.00	37.54	90
8	6656.6	-57.99	4.10	11.50	Horizontal	-52.74	-13.00	39.74	0
9	7488.8	-54.14	4.20	12.20	Horizontal	-48.29	-13.00	35.29	45
10	8320.9	-55.74	4.30	12.50	Horizontal	-49.69	-13.00	36.69	315

Note: 1.The other Spurious RF Radiated emissions level is no more than noise floor.
 2. The worst emission was found in the antenna is Horizontal position.

6. Main Test Instruments

Name	Manufacturer	Type	Serial Number	Calibration Date	Expiration Date
Base Station Simulator	R&S	CMW500	113824	2017-05-21	2018-05-20
Base Station Simulator	R&S	CMW500	113824	2018-05-20	2019-05-19
Base Station Simulator	R&S	CMW500	113824	2019-05-19	2020-05-18
Power Splitter	Hua Xiang	SHX-GF2-2-13	10120101	/	/
Spectrum Analyzer	Key sight	N9010A	MY50210259	2017-05-21	2018-05-20
Spectrum Analyzer	Key sight	N9010A	MY50210259	2018-05-20	2019-05-19
Spectrum Analyzer	Key sight	N9010A	MY50210259	2019-05-19	2020-05-18
Universal Radio Communication Tester	Key sight	E5515C	MY48367192	2017-05-21	2018-05-20
Universal Radio Communication Tester	Key sight	E5515C	MY48367192	2018-05-20	2019-05-19
Universal Radio Communication Tester	Key sight	E5515C	MY48367192	2019-05-19	2020-05-18
Signal Analyzer	R&S	FSV30	100815	2017-12-17	2018-12-16
Signal Analyzer	R&S	FSV30	100815	2018-12-16	2019-12-15
Signal Analyzer	R&S	FSV30	100815	2019-12-15	2020-12-14
Loop Antenna	SCHWARZBECK	FMZB1519	1519-047	2017-09-26	2020-09-25
Trilog Antenna	SCHWARZBECK	VUBL 9163	9163-201	2017-11-18	2020-11-17
Horn Antenna	R&S	HF907	100126	2016-07-08	2018-07-07
Horn Antenna	R&S	HF907	100126	2018-07-07	2020-07-06
Horn Antenna	ETS-Lindgren	3160-09	00102643	2016-06-21	2018-06-20
Horn Antenna	ETS-Lindgren	3160-09	00102643	2018-06-20	2020-06-19
Signal generator	R&S	SMB 100A	102594	2017-05-21	2018-05-20



Signal generator	R&S	SMB 100A	102594	2018-05-20	2019-05-19
Signal generator	R&S	SMB 100A	102594	2019-05-19	2020-05-18
Climatic Chamber	ESPEC	SU-242	93000506	2017-12-17	2020-12-16
Preampfier	R&S	SCU18	102327	2017-05-21	2018-05-20
Preampfier	R&S	SCU18	102327	2018-05-20	2019-05-19
Preampfier	R&S	SCU18	102327	2019-05-19	2020-05-18
MOB COMMS DC SUPPLY	Keysight	66319D	MY43004105	2017-05-21	2018-05-20
MOB COMMS DC SUPPLY	Keysight	66319D	MY43004105	2018-05-20	2019-05-19
MOB COMMS DC SUPPLY	Keysight	66319D	MY43004105	2019-05-19	2020-05-18
RF Cable	Agilent	SMA 15cm	0001	2017-12-17	2018-06-16
RF Cable	Agilent	SMA 15cm	0001	2018-06-16	2018-12-15
RF Cable	Agilent	SMA 15cm	0001	2018-12-15	2019-06-14
RF Cable	Agilent	SMA 15cm	0001	2019-06-14	2019-12-13
RF Cable	Agilent	SMA 15cm	0001	2019-12-13	2020-06-12
Software	R&S	EMC32	9.26.0	/	/

*****END OF REPORT *****



ANNEX A: The EUT Appearance

The EUT Appearance are submitted separately.



ANNEX B: Test Setup Photos

The Test Setup Photos are submitted separately.



ANNEX C: Product Change Description

The Product Change Description are submitted separately.



ANNEX D: Verify data

The Verify data are submitted separately.