



RF TEST REPORT

Applicant Quectel Wireless Solutions Co., Ltd
FCC ID XMR202005BG95M5
Product LTE Cat M1 & Cat NB2 & EGPRS Module
Brand Quectel
Model BG95-M5
Marketing Quectel BG95-M5
Report No. R2108A0767-R7V2
Issue Date November 29, 2021

TA Technology (Shanghai) Co., Ltd. tested the above equipment in accordance with the requirements in **FCC CFR47 Part 2 (2020)/ FCC CFR47 Part 27C (2020)**. The test results show that the equipment tested is capable of demonstrating compliance with the requirements as documented in this report.

Performed by: Peng Tao

Approved by: Kai Xu

TA Technology (Shanghai) Co., Ltd.

No.145, Jintang Rd, Tangzhen Industry Park, Pudong Shanghai, China

TEL: +86-021-50791141/2/3

FAX: +86-021-50791141/2/3-8000



TABLE OF CONTENT

1	Test Laboratory	6
1.1	Notes of the Test Report	6
1.2.	Test facility	6
1.3	Testing Location	6
2	General Description of Equipment under Test	7
2.1	Applicant and Manufacturer Information	7
2.2	General information	7
3	Applied Standards	9
4	Test Configuration	10
5	Test Case Results	12
5.1	RF Power Output and Effective Isotropic Radiated Power	12
5.2	Occupied Bandwidth	17
5.3	Band Edge Compliance	38
5.4	Peak-to-Average Power Ratio (PAPR)	54
5.5	Frequency Stability	56
5.6	Spurious Emissions at Antenna Terminals	64
5.7	Radiates Spurious Emission	73
6	Main Test Instruments	86
ANNEX A: The EUT Appearance		87
ANNEX B: Test Setup Photos		88
ANNEX C: Verify data		89
ANNEX D: Product Change Description		90



Version	Revision description	Issue Date
Rev.0	Initial issue of report.	September 24, 2021
Rev.1	Update data. Update description	November 11, 2021
Rev.2	Update description	November 29, 2021
Note: This revised report (Report No. R2108A0767-R7V2) supersedes and replaces the previously issued report (Report No. R2108A0767-R7V1). Please discard or destroy the previously issued report and dispose of it accordingly.		



Summary of Measurement Results

Number	Test Case	Clause in FCC rules	Verdict
1	RF Power Output and Effective Isotropic Radiated Power	2.1046 27.50(d)(4) /27.50(b)(10) /27.50(c)(10)	PASS
2	Occupied Bandwidth	2.1049	PASS
3	Band Edge Compliance	27.53(h) /27.53(g) /27.53(f) /27.53(c)	PASS
4	Peak-to-Average Power Ratio	27.50(d)/KDB971168 D01(5.7)	PASS
5	Frequency Stability	2.1055 / 27.54	PASS
6	Spurious Emissions at Antenna Terminals	2.1051 /27.53(h) /27.53(g) /27.53(f) /27.53(c)	PASS
7	Radiates Spurious Emission	2.1053 /27.53(h) /27.53(g) /27.53(f) /27.53(c)	PASS
Date of Testing (original): May 24, 2020~ June 16, 2020 (variant): August 31, 2021 ~ November 5, 2021			
Note: PASS: The EUT complies with the essential requirements in the standard. FAIL: The EUT does not comply with the essential requirements in the standard. All indications of Pass/Fail in this report are opinions expressed by TA Technology (Shanghai) Co., Ltd. based on interpretations and/or observations of test results. Measurement Uncertainties were not taken into account and are published for informational purposes only.			

BG95-M5 (Report No.: R2108A0767-R7V2) is a variant model of BG95-M5 (Report No.: R2005A0283-R7). There is only changed the Power Amplifier and Software Version of product. Tested cases refer to the following table. Please refer to Appendix C for Verify data

Test Case	Original	Variant
RF Power Output and Effective Radiated Power	PASS	Retest(NB-IoT 4/66/12/13/71/85)
Occupied Bandwidth	PASS	Verify the worst combination of each frequency band(NB-IoT 4/66/12/13/71/85)
Band Edge Compliance	PASS	Verify the worst combination of each frequency band(NB-IoT 4/66/12/13/71/85)



Peak-to-Average Power Ratio	PASS	Retest(NB-IoT 4/66/12/13/71/85)
Frequency Stability	PASS	Verify the worst combination of each frequency band(NB-IoT 4/66/12/13/71/85)
Spurious Emissions at Antenna Terminals	PASS	Verify the worst combination of each frequency band(NB-IoT 4/66/12/13/71/85)
Radiates Spurious Emission	PASS	Verify the worst combination of each frequency band(NB-IoT 4/66/12/13/71/85)

The detailed product change description please refers to the Difference Declaration Letter.



1 Test Laboratory

1.1 Notes of the Test Report

This report shall not be reproduced in full or partial, without the written approval of **TA technology (shanghai) co., Ltd.** The results documented in this report apply only to the tested sample, under the conditions and modes of operation as described herein .Measurement Uncertainties were not taken into account and are published for informational purposes only. This report is written to support regulatory compliance of the applicable standards stated above.

1.2. Test facility

FCC (Designation number: CN1179, Test Firm Registration Number: 446626)

TA Technology (Shanghai) Co., Ltd. has been listed on the US Federal Communications Commission list of test facilities recognized to perform electromagnetic emissions measurements.

A2LA (Certificate Number: 3857.01)

TA Technology (Shanghai) Co., Ltd. has been listed by American Association for Laboratory Accreditation to perform electromagnetic emission measurement.

1.3 Testing Location

Company: TA Technology (Shanghai) Co., Ltd.
Address: No.145, Jintang Rd, Tangzhen Industry Park, Pudong Shanghai, China
City: Shanghai
Post code: 201201
Country: P. R. China
Contact: Xu Kai
Telephone: +86-021-50791141/2/3
Fax: +86-021-50791141/2/3-8000
Website: <http://www.ta-shanghai.com>
E-mail: xukai@ta-shanghai.com

2 General Description of Equipment under Test

2.1 Applicant and Manufacturer Information

Applicant	Quectel Wireless Solutions Co., Ltd
Applicant address	Building 5, Shanghai Business Park Phase III (Area B), No.1016 Tianlin Road, Minhang District, Shanghai, China 200233
Manufacturer	Quectel Wireless Solutions Co., Ltd
Manufacturer address	Building 5, Shanghai Business Park Phase III (Area B), No.1016 Tianlin Road, Minhang District, Shanghai, China 200233

2.2 General information

EUT Description		
Model	BG95-M5	
IMEI	Original	866833040004456
	Variant	866833040047463
Hardware Version	R1.1	
Software Version	BG95M5LAR02A03	
Power Supply	External power supply	
Antenna Type	The EUT don't have standard Antenna, The Antenna used for testing in this report is the after-market accessory (Dipole Antenna)	
Antenna Gain	Frequency(MHz)	Gain(dBi)
	700	1.66
	710	3.26
	780	4.45
	1720	1.94
	1740	2.00
	1780	0.97
Test Mode(s)	NB-IoT Band 4/12/13/66/71/85	
Test Modulation	BPSK, QPSK	
Category	NB2	
Deployment	stand-alone	
Sub-carrier spacing	3.75KHz, 15KHz	
Ntones	single-tone, multi-tone	
Maximum E.I.R.P	NB-IoT Band 4	25.68dBm
	NB-IoT Band 66	25.54dBm
Maximum E.R.P.	NB-IoT Band 12	25.12dBm
	NB-IoT Band 13	26.01dBm
	NB-IoT Band 71	23.20dBm



	NB-IoT Band 85	25.27dBm	
Rated Power Supply Voltage:	3.8V		
Extreme Voltage	Minimum: 3.3V Maximum: 4.3V		
Extreme Temperature	Lowest: -40°C Highest: +85°C		
Frequency Range(s)	Mode	Tx (MHz)	Rx (MHz)
	NB-IoT Band 4	1710 ~ 1755	2110 ~ 2155
	NB-IoT Band 12	699 ~ 716	729 ~ 746
	NB-IoT Band 13	777 ~ 787	746 ~ 756
	NB-IoT Band 66	1710 ~ 1780	2110 ~ 2180
	NB-IoT Band 71	663 ~ 698	617 ~ 652
	NB-IoT Band 85	698 ~ 716	728 ~ 746
Note: 1. The EUT is sent from the applicant to TA and the information of the EUT is declared by the applicant.			



3 Applied Standards

According to the specifications of the manufacturer, it must comply with the requirements of the following standards:

Test standards:

FCC CFR47 Part 27C (2020)

ANSI C63.26 (2015)

Reference standard:

FCC CFR47 Part 2 (2020)

KDB 971168 D01 Power Meas License Digital Systems v03r01

4 Test Configuration

Radiated measurements are performed by rotating the EUT in three different orthogonal test planes. EUT stand-up position (Z axis), lie-down position (X, Y axis). Receiver antenna polarization (horizontal and vertical), the worst emission was found in position (Z axis, horizontal polarization) and the worst case was recorded.

All modes as Subcarrier Spacing, modulations, Channel were investigated.

Subsequently, only the worst case emissions are reported.

The following testing in NB-IoT is set based on the maximum RF Output Power.

The following testing in different mode is set to detail in the following table:

Test modes are chosen to be reported as the worst case configuration below for NB-IoT Band 4/12/13/66/71/85:

Test items	Mode	Deployment mode	Subcarrier Spacing (kHz)		Modulation		Test Channel		
		Stand-alone	3.75	15	BPSK	QPSK	L	M	H
RF Power Output and Effective Isotropic Radiated Power	NB-IoT B4	O	O	O	O	O	O	O	O
	NB-IoT B12	O	O	O	O	O	O	O	O
	NB-IoT B13	O	O	O	O	O	O	O	O
	NB-IoT B66	O	O	O	O	O	O	O	O
	NB-IoT B71	O	O	O	O	O	O	O	O
	NB-IoT B85	O	O	O	O	O	O	O	O
Occupied Bandwidth	NB-IoT B4	O	O	O	O	O	O	O	O
	NB-IoT B12	O	O	O	O	O	O	O	O
	NB-IoT B13	O	O	O	O	O	O	O	O
	NB-IoT B66	O	O	O	O	O	O	O	O
	NB-IoT B71	O	O	O	O	O	O	O	O
	NB-IoT B85	O	O	O	O	O	O	O	O
Band Edge Compliance	NB-IoT B4	O	O	O	O	O	O	-	O
	NB-IoT B12	O	O	O	O	O	O	-	O
	NB-IoT B13	O	O	O	O	O	O	-	O
	NB-IoT B66	O	O	O	O	O	O	-	O
	NB-IoT B71	O	O	O	O	O	O	-	O
	NB-IoT B85	O	O	O	O	O	O	-	O
Peak-to-Average Power Ratio	NB-IoT B4	O	O	O	O	O	-	O	-
	NB-IoT B12	O	O	O	O	O	-	O	-
	NB-IoT B13	O	O	O	O	O	-	O	-
	NB-IoT B66	O	O	O	O	O	-	O	-
	NB-IoT B71	O	O	O	O	O	-	O	-
	NB-IoT B85	O	O	O	O	O	-	O	-



Frequency Stability	NB-IoT B4	O	O	O	O	O	O	O	O
	NB-IoT B12	O	O	O	O	O	O	O	O
	NB-IoT B13	O	O	O	O	O	O	O	O
	NB-IoT B66	O	O	O	O	O	O	O	O
	NB-IoT B71	O	O	O	O	O	O	O	O
	NB-IoT B85	O	O	O	O	O	O	O	O
Conducted Spurious Emissions	NB-IoT B4	O	-	O	-	O	O	O	O
	NB-IoT B12	O	-	O	-	O	O	O	O
	NB-IoT B13	O	-	O	-	O	O	O	O
	NB-IoT B66	O	-	O	-	O	O	O	O
	NB-IoT B71	O	-	O	-	O	O	O	O
	NB-IoT B85	O	-	O	-	O	O	O	O
Radiates Spurious Emission	NB-IoT B4	O	-	O	-	O	O	O	O
	NB-IoT B12	O	-	O	-	O	O	O	O
	NB-IoT B13	O	-	O	-	O	O	O	O
	NB-IoT B66	O	-	O	-	O	O	O	O
	NB-IoT B71	O	-	O	-	O	O	O	O
	NB-IoT B85	O	-	O	-	O	O	O	O
<p>Note</p> <p>1. The mark "O" means that this configuration is chosen for testing.</p> <p>2. The mark "-" means that this configuration is not testing.</p>									

5 Test Case Results

5.1 RF Power Output and Effective Isotropic Radiated Power

Ambient condition

Temperature	Relative humidity	Pressure
23°C ~25°C	45%~50%	101.5kPa

Methods of Measurement

During the process of the testing, The EUT is controlled by the Base Station Simulator to ensure max power transmission and proper modulation.

1. The testing follows FCC KDB 971168 D01 v03r01 Section 5.8 and ANSI C63.26 (2015).

- a) Connect the equipment as illustrated. Mount the equipment with the manufacturer specified antenna in a vertical orientation on a manufacturer specified mounting surface located on a non-conducting rotating platform of a RF anechoic chamber (preferred) or a standard radiation site.
- b) Key the transmitter, then rotate the EUT 360° azimuthally and record spectrum analyzer power level (LVL) measurements at angular increments that are sufficiently small to permit resolution of all peaks. If a standard radiation test site is used, raise and lower the test antenna to obtain a maximum reading at each angular increment. (Note: several batteries may be needed to offset the effect of battery voltage droop, which should not exceed 5% of the manufactured specified battery voltage during transmission).
- c) Replace the transmitter under test with a vertically polarized half-wave dipole (or an antenna whose gain is known relative to an ideal half-wave dipole). The center of the antenna should be at the same location as the center of the antenna under test.
- d) Connect the antenna to a signal generator with a known output power and record the path loss (in dB) as LOSS. If a standard radiation test site is used, raise and lower the test antenna to obtain a maximum reading. $LOSS = \text{Generator Output Power (dBm)} - \text{Analyzer reading (dBm)}$
- e) Determine the effective radiated output power at each angular position from the readings in steps b) and d) using the following equation: $ERP \text{ (dBm)} = \text{LVL (dBm)} + \text{LOSS (dB)}$
- f) The maximum ERP is the maximum value determined in the preceding step.
- g) When calculating ERP, in addition to knowing the antenna radiation and matching characteristics, it is necessary to know the loss values of all elements (e.g. transmission line attenuation, mismatches, filters, combiners) interposed between the point where transmitter output power is measured, and the point where power is applied to the antenna. ERP can then be calculated as follows:

$$EIRP \text{ (dBm)} = \text{Output Power (dBm)} - \text{Losses (dB)} + \text{Antenna Gain (dBi)}$$

where: dBd refers to gain relative to an ideal dipole.

$$EIRP \text{ (dBm)} = ERP \text{ (dBm)} + 2.15 \text{ (dB.)}$$

The RB allocation refers to section 5.1, using the maximum output power configuration.

Test Setup

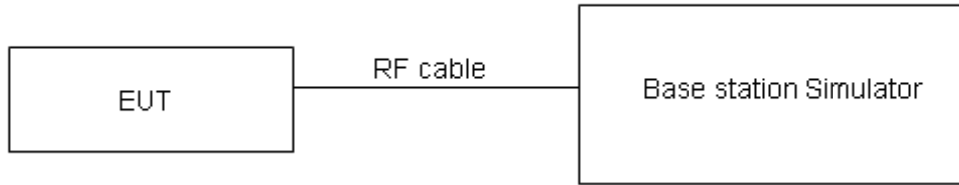

The loss between RF output port of the EUT and the input port of the tester has been taken into consideration.

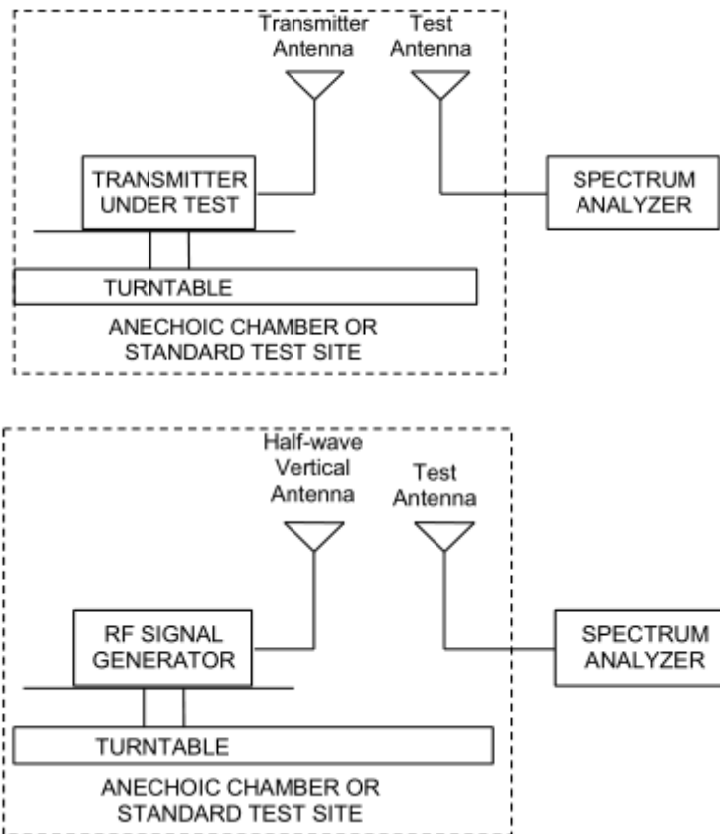

Note: Area side:2.4mX3.6m

The radiated emission was measured in the following position: EUT stand-up position (Z axis), lie-down position (X, Y axis). The worst emission was found in stand-up position (Z axis) and the worst case was recorded.

Limits

No specific RF power output requirements in part 2.1046.

Rule Part 27.50(b) (10) specifies that “Portable stations (hand-held devices) transmitting in the 746-757 MHz, 776-788 MHz, and 805-806 MHz bands are limited to 3 watts ERP”

Rule Part 27.50(c) (10) specifies that “Portable stations (hand-held devices) in the 600 MHz uplink band and the 698-746 MHz band, and fixed and mobile stations in the 600 MHz uplink band are limited to 3 watts ERP”



Rule Part 27.50(d) (4) specifies that “Fixed, mobile and portable (hand-held) stations operating in the 1710–1755 MHz band are limited to 1 watt EIRP”

Part 27.50(b)(10)Limit	$\leq 3 \text{ W}$ (34.77 dBm)
Part 27.50(c)(10)Limit	$\leq 3 \text{ W}$ (34.77 dBm)
Part 27.50(d)(4)Limit	$\leq 1 \text{ W}$ (30 dBm)

Measurement Uncertainty

The assessed measurement uncertainty to ensure 95% confidence level for the normal distribution is with the coverage factor $k = 2$, $U=0.4$ dB for RF power output, $k = 2$, $U= 1.19$ dB for ERP/EIRP.



Test Results

Mode	Modulation	Sub-carrier spacing (KHz)	Ntones	Conducted Power (dBm) for low/middle/high channel			EIRP(dBm)		
				19952 /1710.2	20175 /1732.5	20398 /1754.8	19952 /1710.2	20175 /1732.5	20398 /1754.8
NB-IoT Band 4 Standalone	BPSK	3.75	1@0	23.74	23.62	23.67	25.68	25.62	25.24
			1@47	23.58	23.52	23.59	25.52	25.52	25.16
		15	1@0	23.59	23.45	23.66	25.53	25.45	25.23
			1@11	23.57	23.44	23.64	25.51	25.44	25.21
	QPSK	3.75	1@0	23.59	23.47	23.60	25.53	25.47	25.17
			1@47	23.65	23.45	23.58	25.59	25.45	25.15
		15	1@0	23.52	23.45	23.74	25.46	25.45	25.31
			1@11	23.55	23.48	23.69	25.49	25.48	25.26
		15	12@0	21.60	21.47	21.63	23.54	23.47	23.20
		ERP(dBm)	23012 /699.2	23095 /707.5	23178 /715.8	23012 /699.2	23095 /707.5	23178 /715.8	
23.30	23.29		23.21	22.81	24.40	25.01			
NB-IoT Band 12 Standalone	BPSK	3.75	1@0	23.30	23.29	23.21	22.81	24.40	25.01
			1@47	23.24	23.22	23.23	22.75	24.33	25.03
		15	1@0	23.44	23.30	23.28	22.95	24.41	25.08
			1@11	23.38	23.25	23.25	22.89	24.36	25.05
	QPSK	3.75	1@0	23.30	23.30	23.16	22.81	24.41	24.96
			1@47	23.37	23.24	23.26	22.88	24.35	25.06
		15	1@0	23.41	23.37	23.31	22.92	24.48	25.11
			1@11	23.34	23.32	23.32	22.85	24.43	25.12
		15	12@0	21.34	21.26	21.27	20.85	22.37	23.07
		ERP(dBm)	23182 /777.2	23230 /782	23278 /786.8	23182 /777.2	23230 /782	23278 /786.8	
23.40	23.40		23.37	25.70	25.70	24.85			
NB-IoT Band 13 Standalone	BPSK	3.75	1@0	23.40	23.40	23.37	25.70	25.70	24.85
			1@47	23.30	23.33	23.31	25.60	25.63	24.79
		15	1@0	23.62	23.65	23.48	25.92	25.95	24.96
			1@11	23.56	23.61	23.42	25.86	25.91	24.90
	QPSK	3.75	1@0	23.39	23.39	23.37	25.69	25.69	24.85
			1@47	23.32	23.40	23.35	25.62	25.70	24.83
		15	1@0	23.51	23.62	23.40	25.81	25.92	24.88
			1@11	23.56	23.71	23.46	25.86	26.01	24.94
		15	12@0	21.32	21.39	21.27	23.62	23.69	22.75
		ERP(dBm)	131974	132322	132670	131974	132322	132670	



Mode	Modulation	Sub-carrier spacing (KHz)	Ntones	Conducted Power (dBm) for low/middle/high channel			ERP(dBm)			
				133124 /663.2	133297 /680.5	133470 /697.8	133124 /663.2	133297 /680.5	133470 /697.8	
NB-IoT Band 66 Standalone	BPSK	3.75	1@0	/1710.2	/1745	/1779.8	/1710.2	/1745	/1779.8	
			1@47	23.57	23.47	23.67	25.51	25.47	24.64	
		15	1@0	23.54	23.41	23.61	25.48	25.41	24.58	
			1@11	23.57	23.42	23.63	25.51	25.42	24.60	
	QPSK	3.75	1@0	23.48	23.36	23.58	25.42	25.36	24.55	
			1@47	23.49	23.47	23.66	25.43	25.47	24.63	
		15	1@0	23.44	23.54	23.67	25.38	25.54	24.64	
			1@11	23.58	23.31	23.56	25.52	25.31	24.53	
	15	12@0	23.56	23.37	23.54	25.50	25.37	24.51		
	12@0	21.55	21.37	21.66	23.49	23.37	22.63			
	NB-IoT Band 71 Standalone	BPSK	3.75	1@0	23.67	23.57	23.52	23.18	23.08	23.03
				1@47	23.66	23.45	23.42	23.17	22.96	22.93
15			1@0	23.47	23.47	23.43	22.98	22.98	22.94	
			1@11	23.50	23.38	23.40	23.01	22.89	22.91	
QPSK		3.75	1@0	23.60	23.48	23.44	23.11	22.99	22.95	
			1@47	23.69	23.48	23.37	23.20	22.99	22.88	
		15	1@0	23.52	23.37	23.42	23.03	22.88	22.93	
			1@11	23.45	23.52	23.40	22.96	23.03	22.91	
15		12@0	21.42	21.38	21.44	20.93	20.89	20.95		
NB-IoT Band 85 Standalone		BPSK	3.75	1@0	134004 /698.2	134092 /707	134180 /715.8	134004 /698.2	134092 /707	134180 /715.8
				1@47	23.54	23.23	23.47	23.05	24.34	25.27
			15	1@0	23.41	23.22	23.32	22.92	24.33	25.12
	1@11			23.48	23.31	23.43	22.99	24.42	25.23	
	QPSK	3.75	1@0	23.42	23.29	23.40	22.93	24.40	25.20	
			1@47	23.46	23.26	23.33	22.97	24.37	25.13	
		15	1@0	23.44	23.13	23.25	22.95	24.24	25.05	
			1@11	23.37	23.26	23.38	22.88	24.37	25.18	
	15	12@0	23.51	23.25	23.46	23.02	24.36	25.26		
	12@0	21.35	21.12	21.32	20.86	22.23	23.12			

5.2 Occupied Bandwidth

Ambient condition

Temperature	Relative humidity	Pressure
23°C ~25°C	45%~50%	101.5kPa

Method of Measurement

The EUT was connected to Spectrum Analyzer and Base Station Simulator via power Splitter. The occupied bandwidth is measured using spectrum analyzer.

RBW is set to 2kHz, VBW is set to 6.2kHz for NB-IoT Band 4/12/13/66/71/85.

99% power and -26dBc occupied bandwidths are recorded. Spectrum analyzer plots are included on the following pages.

Test Setup

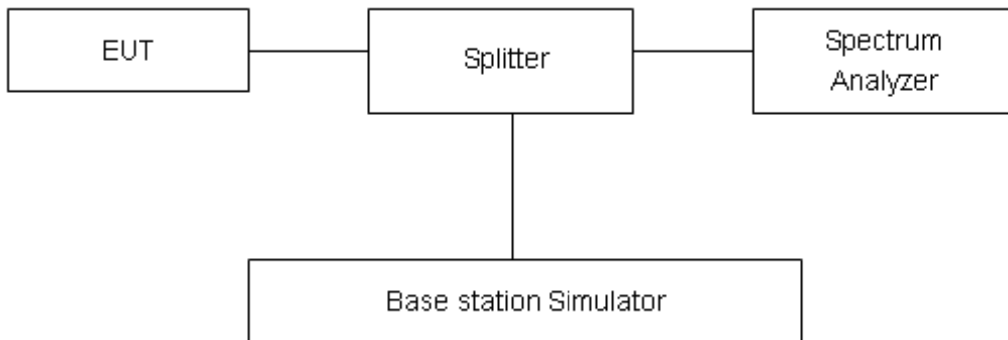

Limits

No specific occupied bandwidth requirements in part 2.1049.

Measurement Uncertainty

The assessed measurement uncertainty to ensure 95% confidence level for the normal distribution is with the coverage factor $k = 2$, $U=624\text{Hz}$.



Test Result

Mode	Modulation	Sub-carrier spacing (KHz)	Ntones	Bandwidth(KHz) for low/middle/high channel					
				19952/1710.2		20175/1732.5		20398/1754.8	
				99% Power	-26dBc	99% Power	-26dBc	99% Power	-26dBc
NB-IoT Band 4 Standalone	BPSK	3.75	1@0	55.94	38.03	55.70	36.12	53.15	37.57
	QPSK	3.75	1@0	61.03	41.84	59.66	39.05	62.34	39.95
	BPSK	15	1@0	131.66	113.60	128.32	114.60	133.81	132.30
	QPSK	15	1@0	117.21	103.00	116.09	117.00	118.06	117.50
	QPSK	15	12@0	183.53	239.60	183.50	239.50	184.45	252.30
Mode	Modulation	Sub-carrier spacing (KHz)	Ntones	Bandwidth(KHz) for low/ middle/high channel					
				23012/699.2		23095/707.5		23178/715.8	
				99% Power	-26dBc	99% Power	-26dBc	99% Power	-26dBc
NB-IoT Band 12 Standalone	BPSK	3.75	1@0	53.48	37.77	55.82	38.81	57.30	38.58
	QPSK	3.75	1@0	59.52	39.67	60.05	39.46	59.93	39.53
	BPSK	15	1@0	134.16	119.20	132.64	116.70	127.53	118.00
	QPSK	15	1@0	118.53	116.00	116.47	118.00	118.29	130.30
	QPSK	15	12@0	184.50	257.30	183.12	248.70	183.30	248.50
Mode	Modulation	Sub-carrier spacing (KHz)	Ntones	Bandwidth(KHz) for low/ middle/high channel					
				23182/777.2		23230/782		23278/786.8	
				99% Power	-26dBc	99% Power	-26dBc	99% Power	-26dBc
Band 13 Standalone	BPSK	3.75	1@0	53.78	37.83	55.18	37.68	54.26	37.80
	QPSK	3.75	1@0	61.68	41.11	60.37	39.72	59.82	39.31
	BPSK	15	1@0	128.09	117.20	119.21	112.80	118.09	100.90
	QPSK	15	1@0	119.19	130.90	116.89	102.20	116.30	117.90
	QPSK	15	12@0	182.40	240.10	185.96	249.20	183.66	238.10
Mode	Modulation	Sub-carrier spacing (KHz)	Ntones	Bandwidth(KHz) for low/ middle/high channel					
				131974/1710.2		132322/1745		132670/1779.8	
				99% Power	-26dBc	99% Power	-26dBc	99% Power	-26dBc
NB-IoT Band 66 Standalone	BPSK	3.75	1@0	53.35	37.75	54.09	37.90	54.19	37.82
	QPSK	3.75	1@0	60.68	39.66	61.43	42.56	61.10	39.41
	BPSK	15	1@0	125.40	104.40	121.05	102.20	126.67	104.70
	QPSK	15	1@0	123.25	118.00	117.73	129.70	113.46	102.40
	QPSK	15	12@0	184.61	239.00	185.86	259.60	184.61	234.00
Mode	Modulation	Sub-carrier spacing (KHz)	Ntones	Bandwidth(KHz) for low/ middle/high channel					
				133124/663.2		133297/680.5		133470/697.8	
				99% Power	-26dBc	99% Power	-26dBc	99% Power	-26dBc
Band 71 Standalone	BPSK	3.75	1@0	53.87	37.56	54.51	37.84	54.54	37.60
	QPSK	3.75	1@0	59.48	39.47	61.04	39.64	59.79	39.53
	BPSK	15	1@0	124.84	112.90	128.80	103.00	128.56	101.10
	QPSK	15	1@0	117.72	104.00	119.13	130.10	117.27	116.10
	QPSK	15	12@0	184.09	249.70	184.05	240.90	184.15	249.10



Mode	Modulation	Sub-carrier spacing (KHz)	Ntones	Bandwidth(KHz) for low/ middle/high channel					
				134004/698.2		134092/707		134180/715.8	
				99% Power	-26dBc	99% Power	-26dBc	99% Power	-26dBc
NB-IoT Band 85 Standalone	BPSK	3.75	1@0	54.26	37.64	53.84	37.83	58.46	38.80
	QPSK	3.75	1@0	60.52	39.45	59.78	39.47	60.36	39.55
	BPSK	15	1@0	129.76	105.60	127.11	117.90	120.64	117.30
	QPSK	15	1@0	119.44	115.90	115.68	103.00	120.77	116.00
	QPSK	15	12@0	183.20	247.20	180.95	235.00	184.35	239.60



NB-IoT Band 4 BPSK 3.75KHz 1@0 CH-Low

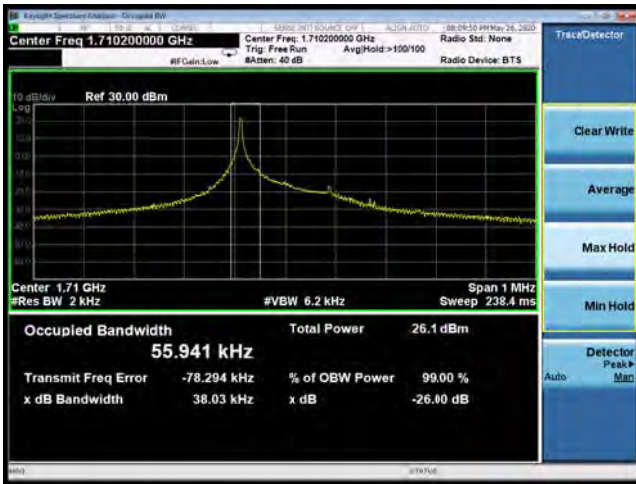

NB-IoT Band 4 BPSK 15KHz 1@0 CH-Low



NB-IoT Band 4 BPSK 3.75KHz 1@0 CH-Middle

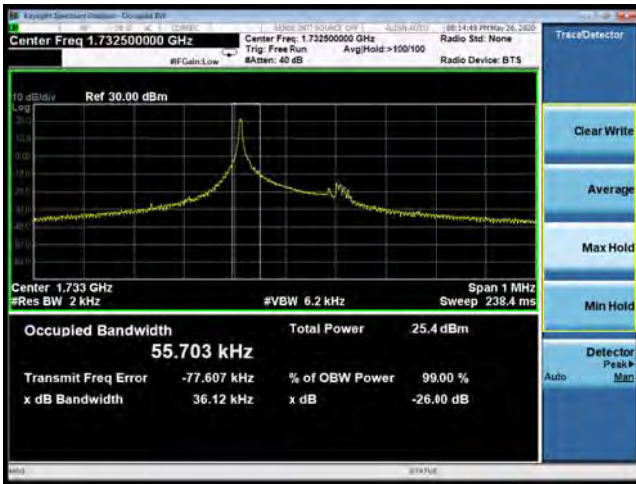

NB-IoT Band 4 BPSK 15KHz 1@0 CH-Middle



NB-IoT Band 4 BPSK 3.75KHz 1@0 CH-High

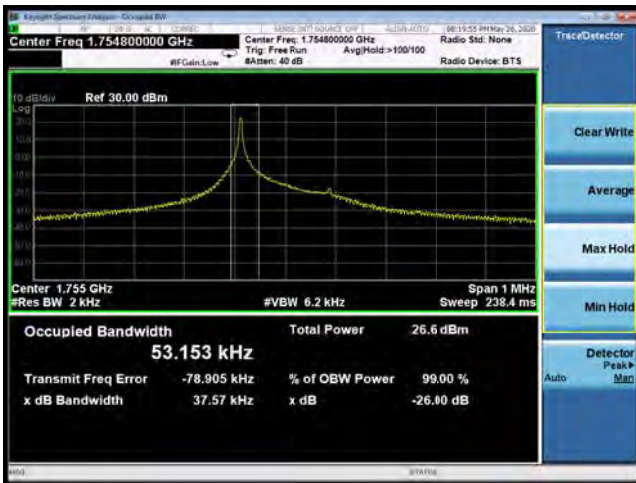

NB-IoT Band 4 BPSK 15KHz 1@0 CH-High



NB-IoT Band 4 QPSK 3.75KHz 1@0 CH-Low

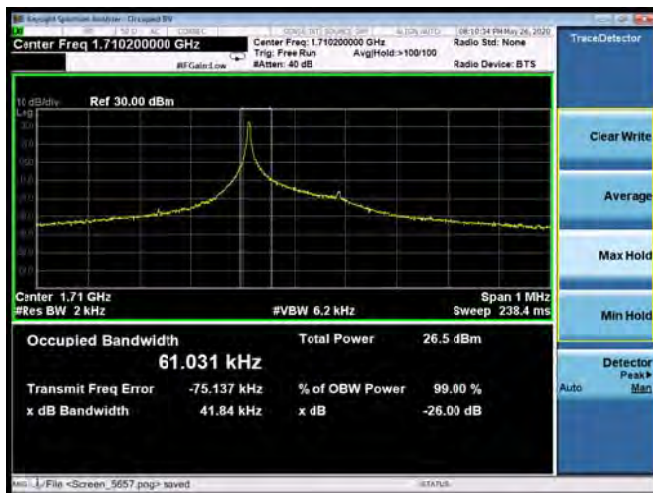

NB-IoT Band 4 QPSK 15KHz 1@0 CH-Low



NB-IoT Band 4 QPSK 3.75KHz 1@0 CH-Middle

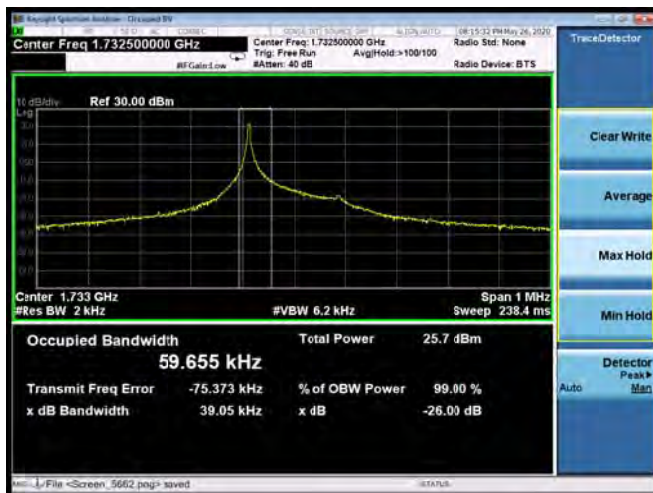

NB-IoT Band 4 QPSK 15KHz 1@0 CH-Middle



NB-IoT Band 4 QPSK 3.75KHz 1@0 CH-High

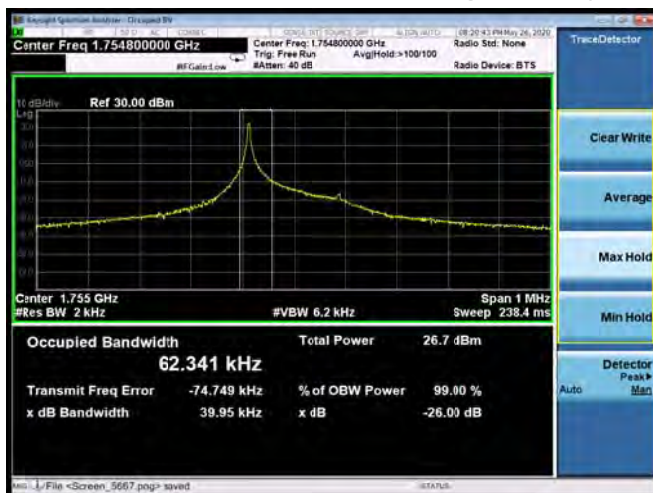

NB-IoT Band 4 QPSK 15KHz 1@0 CH-High



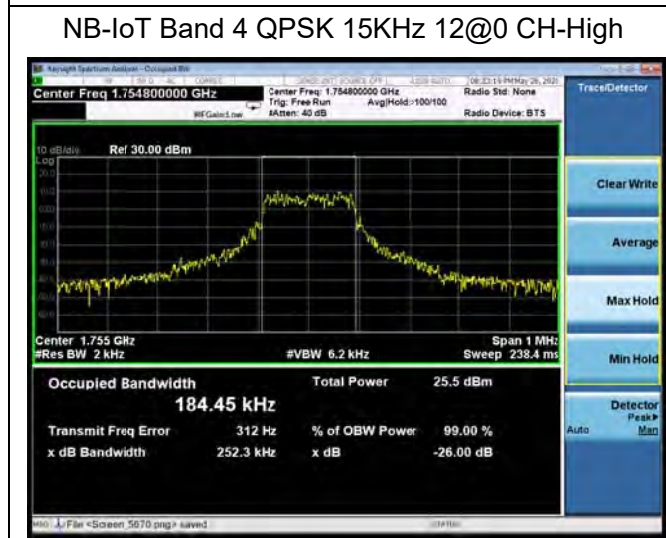
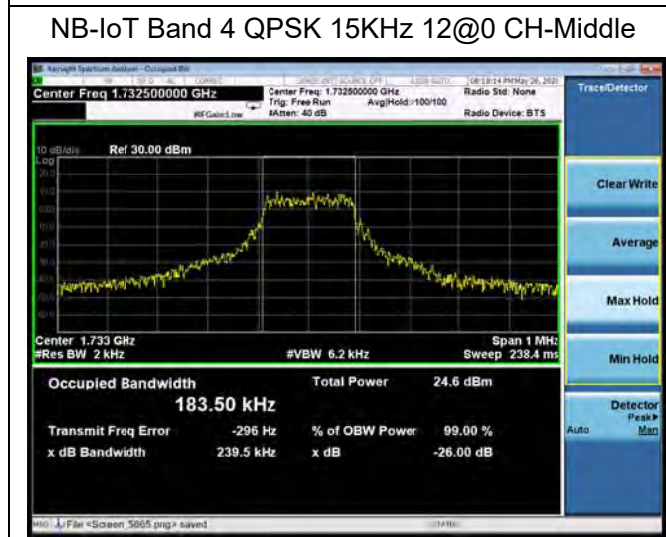
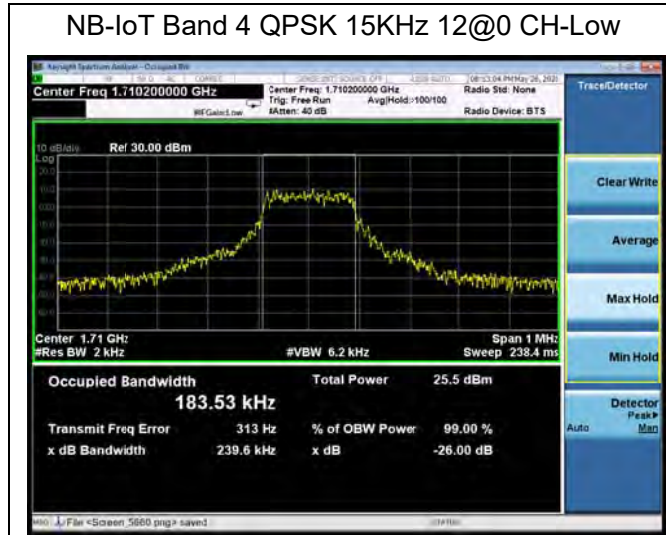



NB-IoT Band 12 BPSK 3.75KHz 1@0 CH-Low



NB-IoT Band 12 BPSK 15KHz 1@0 CH-Low



NB-IoT Band 12 BPSK 3.75KHz 1@0 CH-Middle

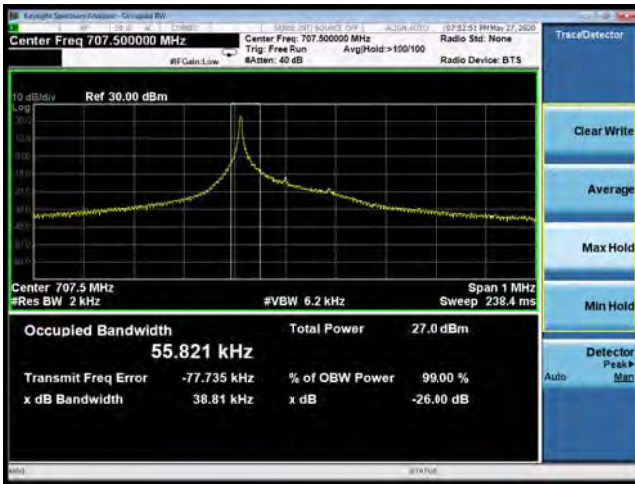

NB-IoT Band 12 BPSK 15KHz 1@0 CH-Middle



NB-IoT Band 12 BPSK 3.75KHz 1@0 CH-High

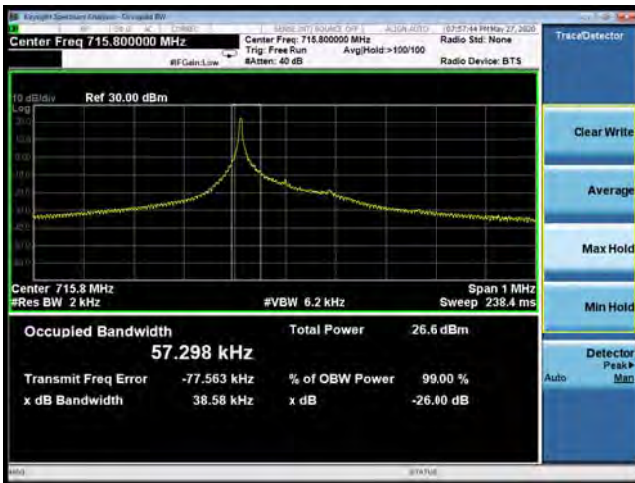

NB-IoT Band 12 BPSK 15KHz 1@0 CH-High





NB-IoT Band 12 QPSK 3.75KHz 1@0 CH-Low

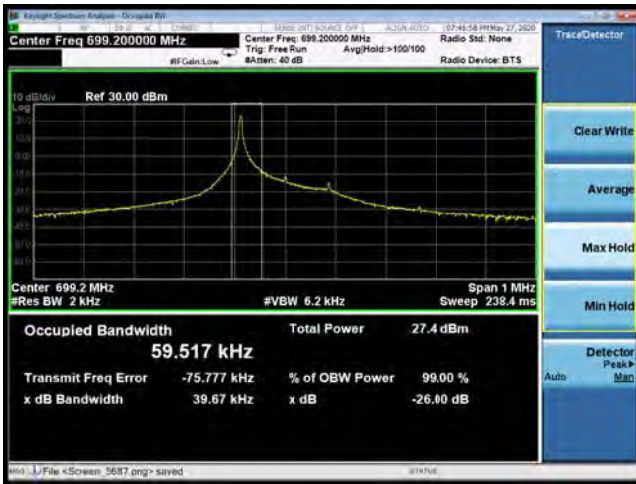

NB-IoT Band 12 QPSK 15KHz 1@0 CH-Low



NB-IoT Band 12 QPSK 3.75KHz 1@0 CH-Middle

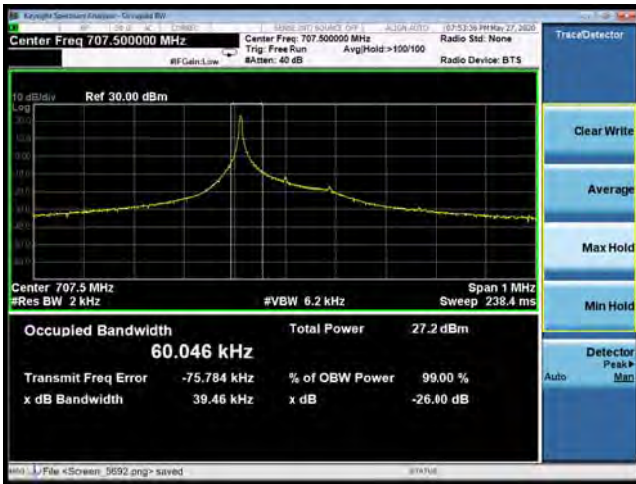

NB-IoT Band 12 QPSK 15KHz 1@0 CH-Middle



NB-IoT Band 12 QPSK 3.75KHz 1@0 CH-High

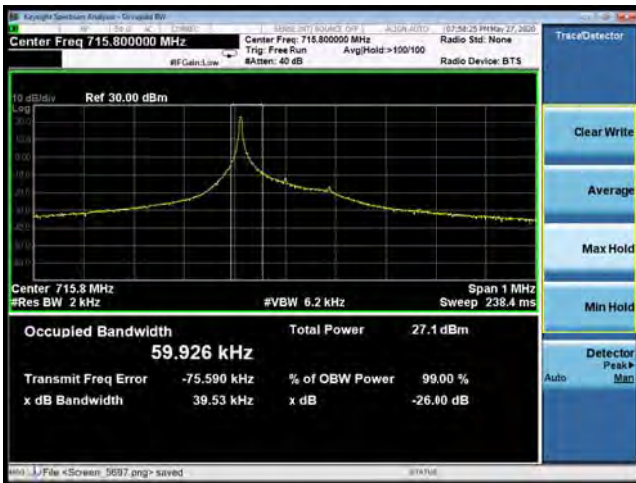

NB-IoT Band 12 QPSK 15KHz 1@0 CH-High



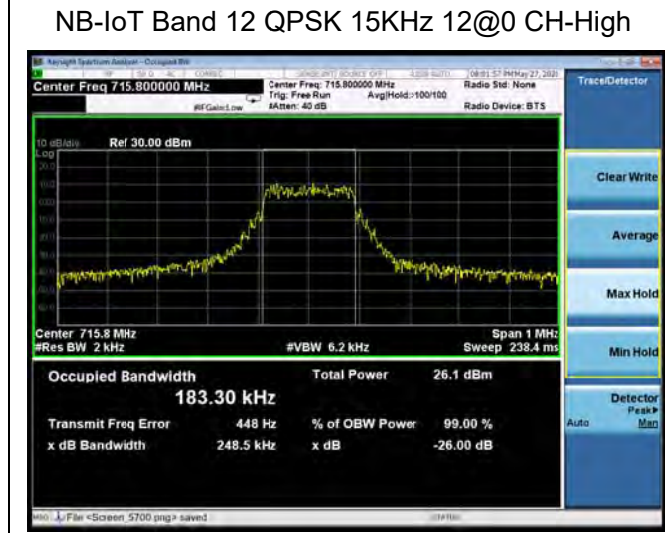
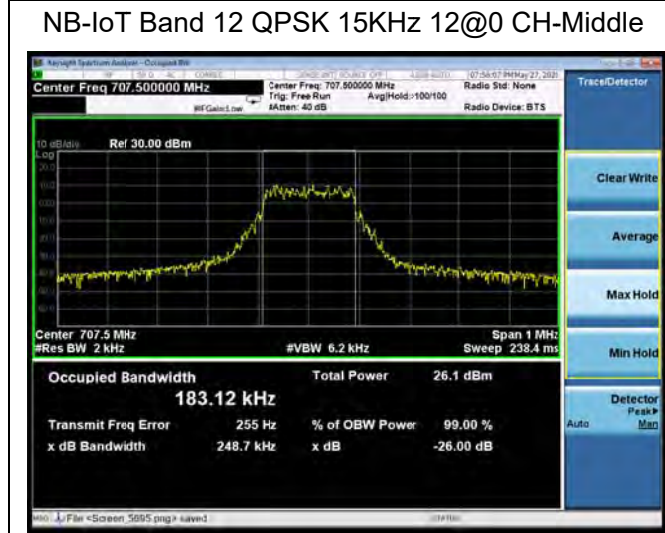
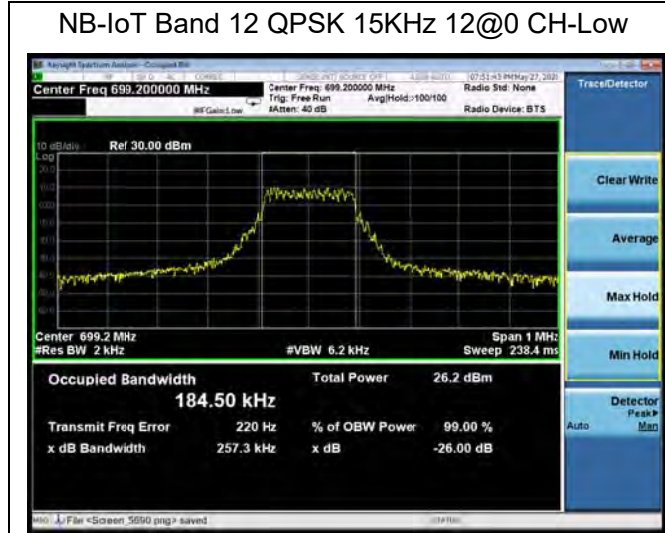



NB-IoT Band 13 BPSK 3.75KHz 1@0 CH-Low



NB-IoT Band 13 BPSK 15KHz 1@0 CH-Low



NB-IoT Band 13 BPSK 3.75KHz 1@0 CH-Middle

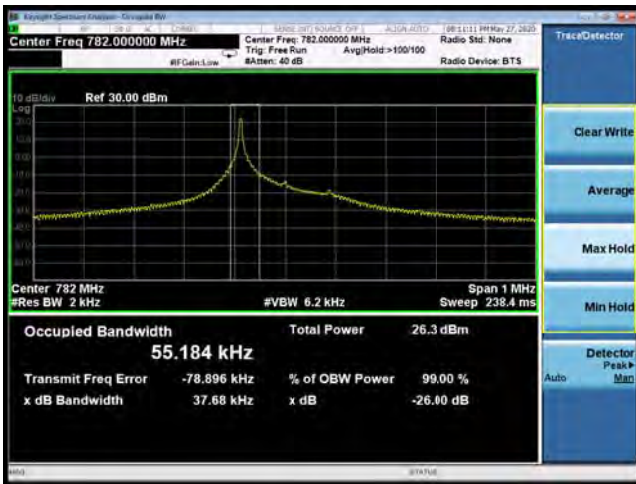

NB-IoT Band 13 BPSK 15KHz 1@0 CH-Middle



NB-IoT Band 13 BPSK 3.75KHz 1@0 CH-High

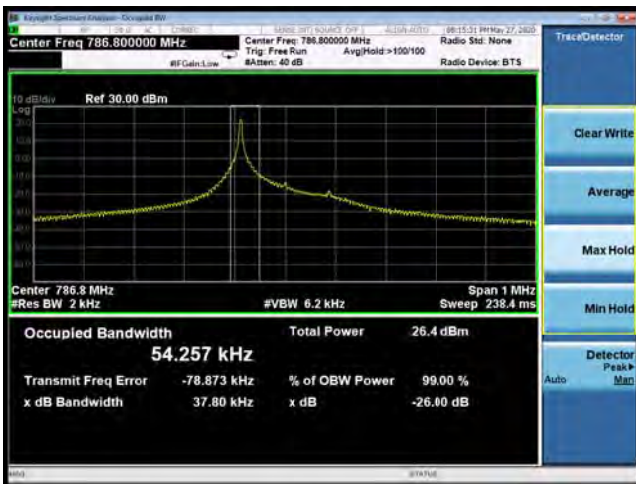

NB-IoT Band 13 BPSK 15KHz 1@0 CH-High





NB-IoT Band 13 QPSK 3.75KHz 1@0 CH-Low

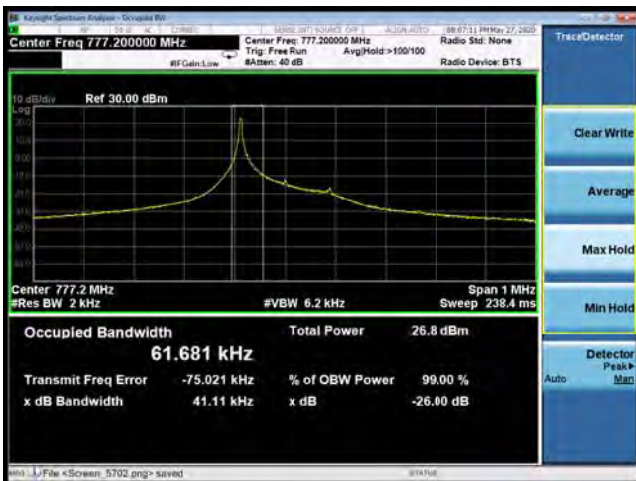

NB-IoT Band 13 QPSK 15KHz 1@0 CH-Low



NB-IoT Band 13 QPSK 3.75KHz 1@0 CH-Middle

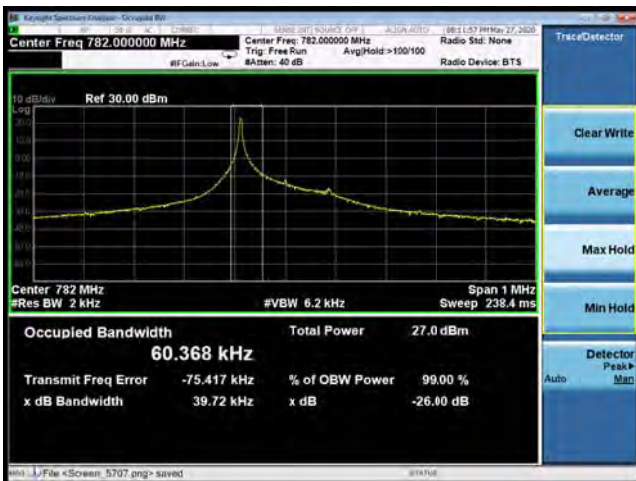

NB-IoT Band 13 QPSK 15KHz 1@0 CH-Middle



NB-IoT Band 13 QPSK 3.75KHz 1@0 CH-High

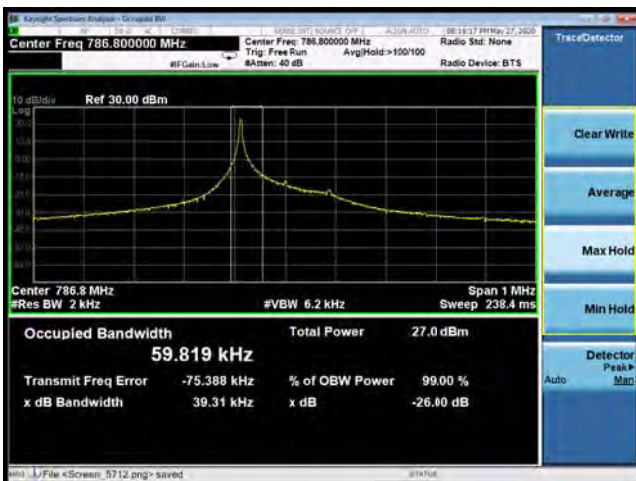

NB-IoT Band 13 QPSK 15KHz 1@0 CH-High



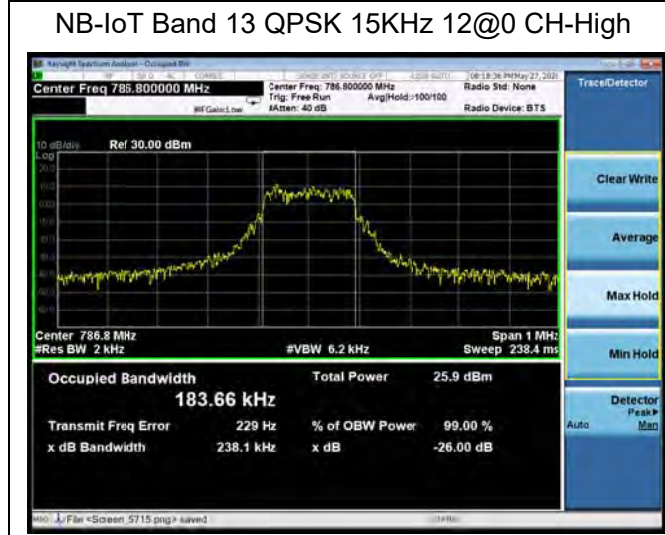
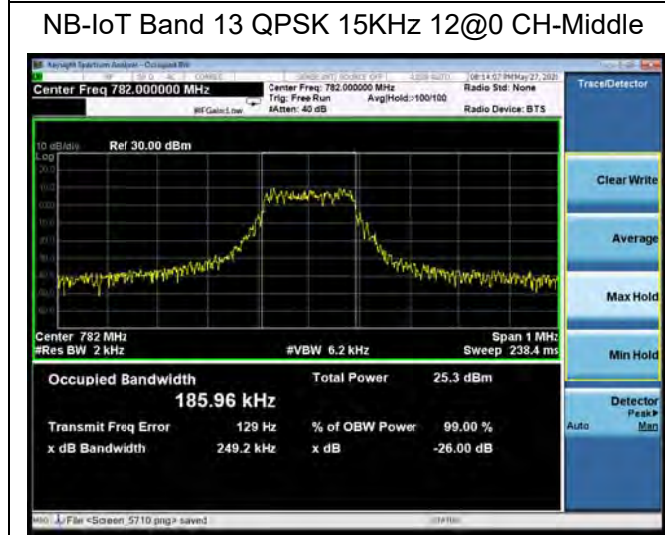
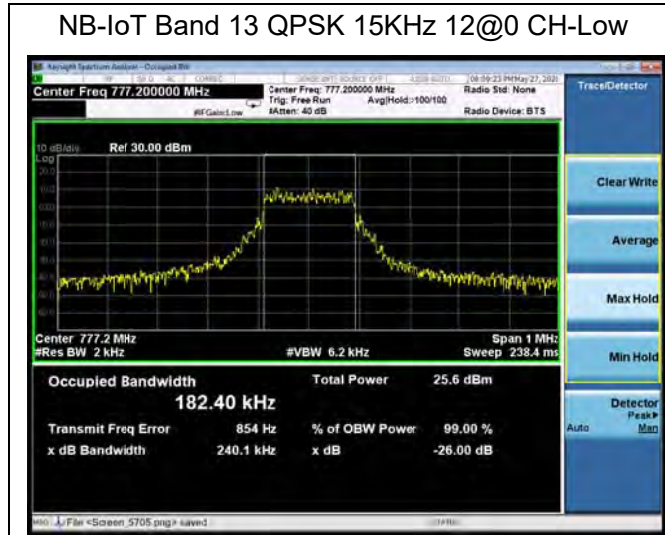



NB-IoT Band 66 BPSK 3.75KHz 1@0 CH-Low

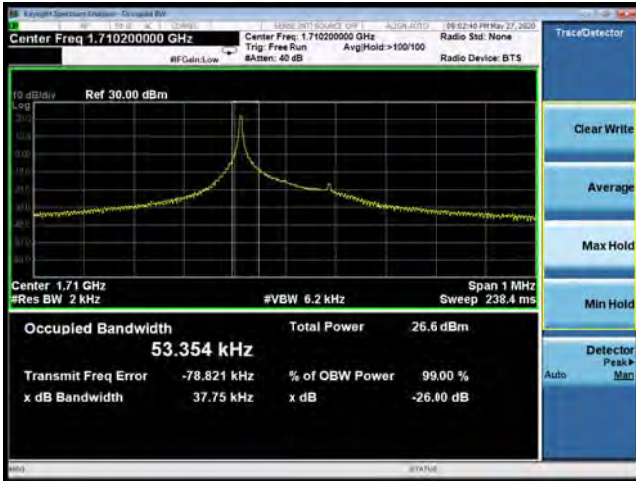

NB-IoT Band 66 BPSK 15KHz 1@0 CH-Low



NB-IoT Band 66 BPSK 3.75KHz 1@0 CH-Middle

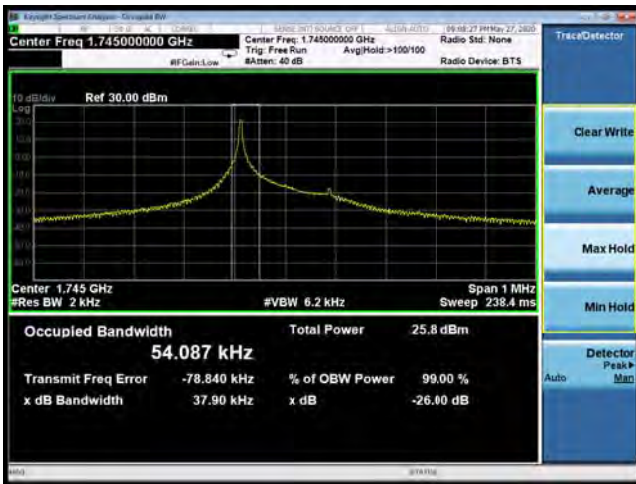

NB-IoT Band 66 BPSK 15KHz 1@0 CH-Middle



NB-IoT Band 66 BPSK 3.75KHz 1@0 CH-High



NB-IoT Band 66 BPSK 15KHz 1@0 CH-High





NB-IoT Band 66 QPSK 3.75KHz 1@0 CH-Low

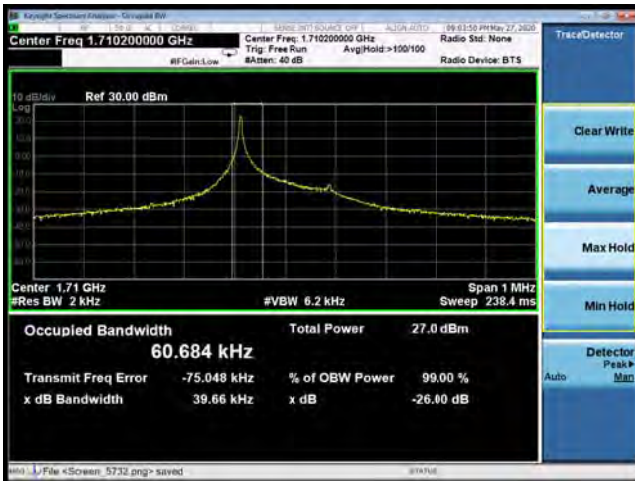

NB-IoT Band 66 QPSK 15KHz 1@0 CH-Low



NB-IoT Band 66 QPSK 3.75KHz 1@0 CH-Middle

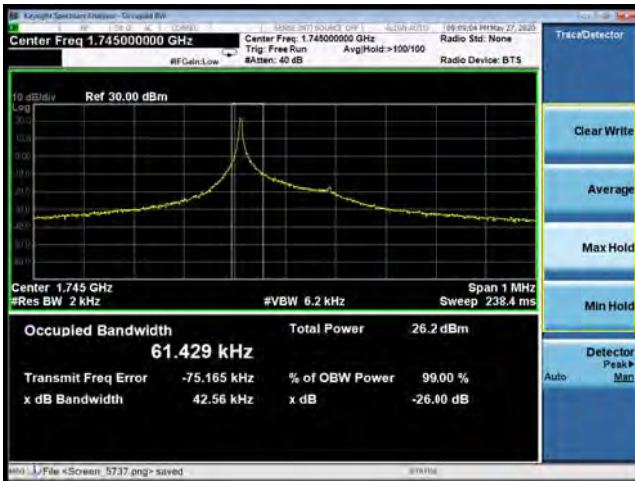

NB-IoT Band 66 QPSK 15KHz 1@0 CH-Middle



NB-IoT Band 66 QPSK 3.75KHz 1@0 CH-High

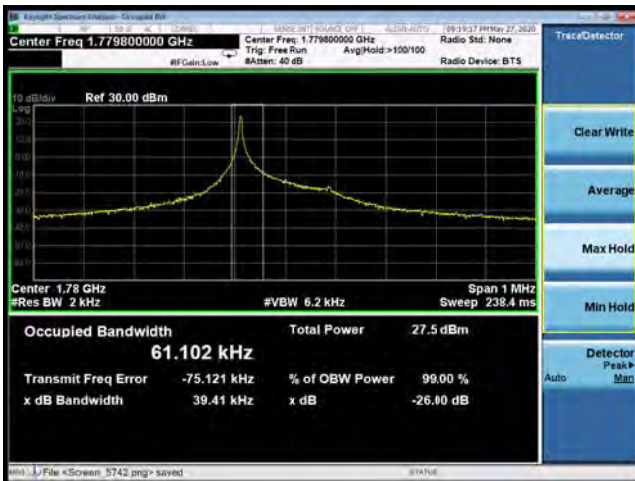

NB-IoT Band 66 QPSK 15KHz 1@0 CH-High



NB-IoT Band 66 QPSK 15KHz 12@0 CH-Low



NB-IoT Band 66 QPSK 15KHz 12@0 CH-Middle



NB-IoT Band 66 QPSK 15KHz 12@0 CH-High





NB-IoT Band 71 BPSK 3.75KHz 1@0 CH-Low

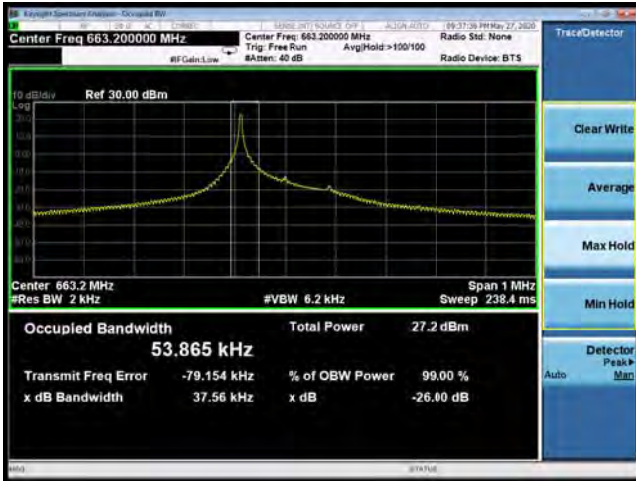

NB-IoT Band 71 BPSK 15KHz 1@0 CH-Low



NB-IoT Band 71 BPSK 3.75KHz 1@0 CH-Middle



NB-IoT Band 71 BPSK 15KHz 1@0 CH-Middle



NB-IoT Band 71 BPSK 3.75KHz 1@0 CH-High

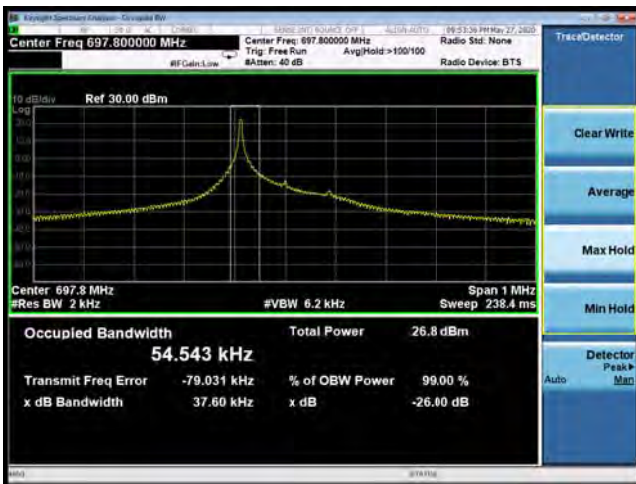

NB-IoT Band 71 BPSK 15KHz 1@0 CH-High





NB-IoT Band 71 QPSK 3.75KHz 1@0 CH-Low

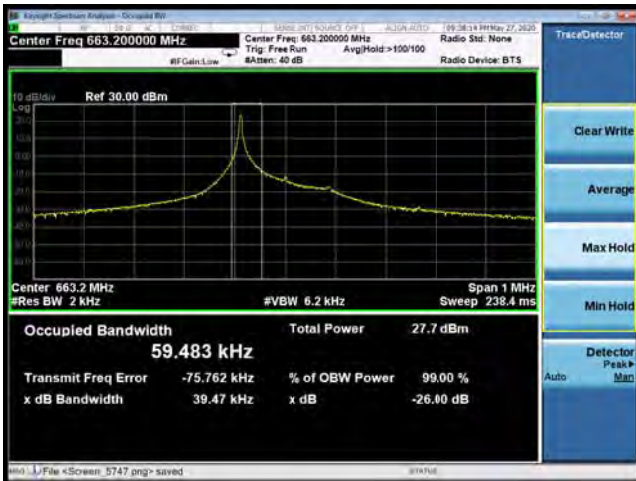

NB-IoT Band 71 QPSK 15KHz 1@0 CH-Low



NB-IoT Band 71 QPSK 3.75KHz 1@0 CH-Middle



NB-IoT Band 71 QPSK 15KHz 1@0 CH-Middle



NB-IoT Band 71 QPSK 3.75KHz 1@0 CH-High

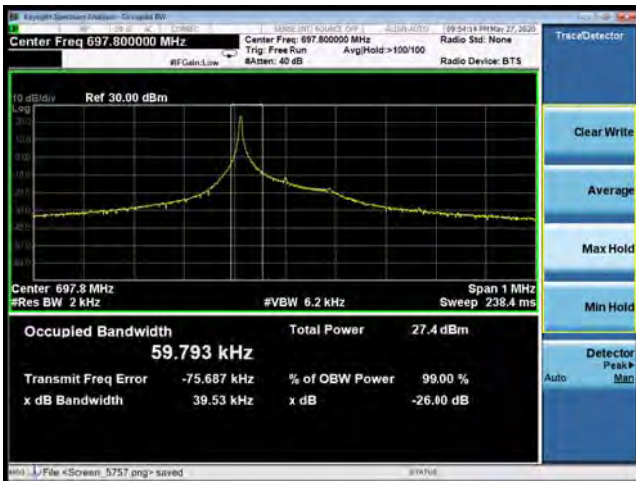

NB-IoT Band 71 QPSK 15KHz 1@0 CH-High



NB-IoT Band 71 QPSK 15KHz 12@0 CH-Low



NB-IoT Band 71 QPSK 15KHz 12@0 CH-Middle



NB-IoT Band 71 QPSK 15KHz 12@0 CH-High





NB-IoT Band 85 BPSK 3.75KHz 1@0 CH-Low

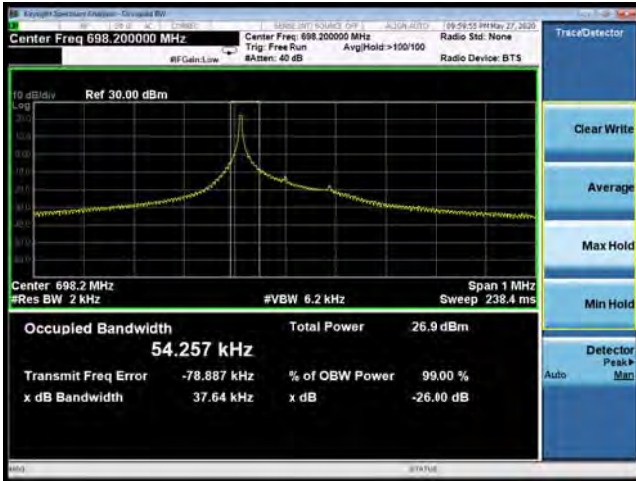

NB-IoT Band 85 BPSK 15KHz 1@0 CH-Low



NB-IoT Band 85 BPSK 3.75KHz 1@0 CH-Middle



NB-IoT Band 85 BPSK 15KHz 1@0 CH-Middle



NB-IoT Band 85 BPSK 3.75KHz 1@0 CH-High



NB-IoT Band 85 BPSK 15KHz 1@0 CH-High





NB-IoT Band 85 QPSK 3.75KHz 1@0 CH-Low

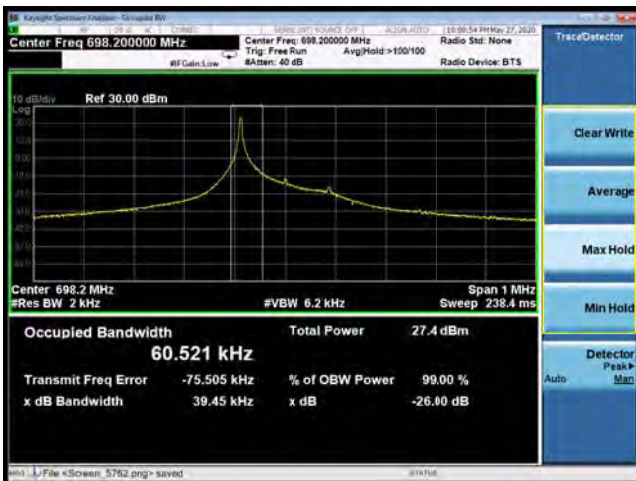

NB-IoT Band 85 QPSK 15KHz 1@0 CH-Low



NB-IoT Band 85 QPSK 3.75KHz 1@0 CH-Middle

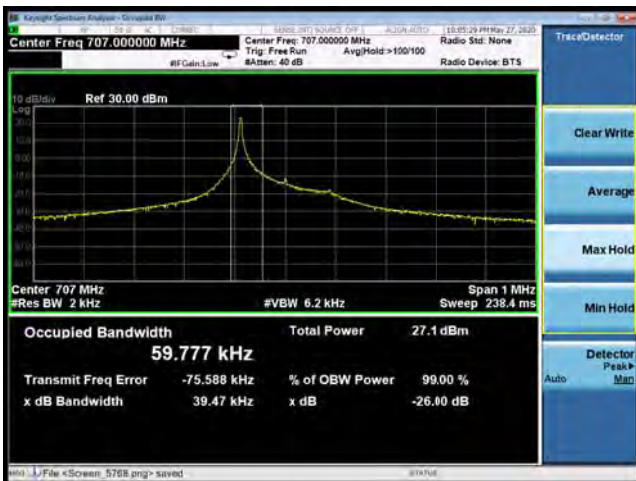

NB-IoT Band 85 QPSK 15KHz 1@0 CH-Middle



NB-IoT Band 85 QPSK 3.75KHz 1@0 CH-High

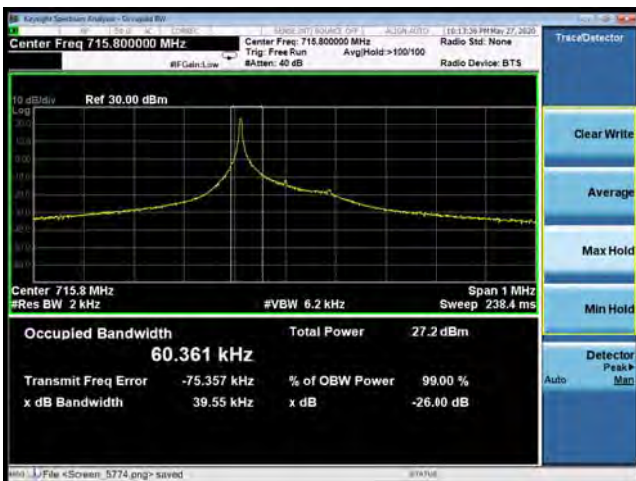

NB-IoT Band 85 QPSK 15KHz 1@0 CH-High



NB-IoT Band 85 QPSK 15KHz 12@0 CH-Low



NB-IoT Band 85 QPSK 15KHz 12@0 CH-Middle



NB-IoT Band 85 QPSK 15KHz 12@0 CH-High



5.3 Band Edge Compliance

Ambient condition

Temperature	Relative humidity	Pressure
23°C ~25°C	45%~50%	101.5kPa

Method of Measurement

The EUT was connected to Spectrum Analyzer and Base Station Simulator via power Splitter. The band edge of the lowest and highest channels were measured.

The testing follows KDB 971168 D01 v03r01 Section 6.0

The EUT was connected to spectrum analyzer and system simulator via a power divider.

The band edges of low and high channels for the highest RF powers were measured.

RBW is set to $\geq 1\%EBW$, VBW is set to 3x RBW.

on spectrum analyzer.

Set spectrum analyzer with RMS detector.

The RF fundamental frequency should be excluded against the limit line in the operating frequency band.

Checked that all the results comply with the emission limit line.

Test Setup

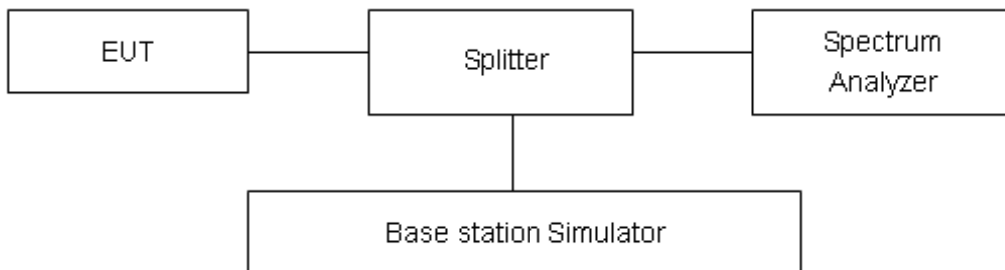

Limits

Rule Part 27.53(h) specifies that “ for operations in the 1695-1710 MHz, 1710-1755 MHz, 1755-1780 MHz, 1915-1920 MHz, 1995-2000 MHz, 2000-2020 MHz, 2110-2155 MHz, 2155-2180 MHz, and 2180-2200 bands, the power of any emission outside a licensee's frequency block shall be attenuated below the transmitter power (P) in watts by at least $43 + 10 \log_{10} (P)$ dB”

Rule Part 27.53(g) For operations in the 600 MHz band and the 698-746 MHz band, the power of any emission outside a licensee's frequency band(s) of operation shall be attenuated below the transmitter power (P) within the licensed band(s) of operation, measured in watts, by at least $43 + 10 \log (P)$ dB. Compliance with this provision is based on the use of measurement instrumentation



employing a resolution bandwidth of 100 kilohertz or greater. However, in the 100 kilohertz bands immediately outside and adjacent to a licensee's frequency block, a resolution bandwidth of at least 30 kHz may be employed.

Rule Part 27.53(f) For operations in the 746-758 MHz, 775-788 MHz, and 805-806 MHz bands, emissions in the band 1559-1610 MHz shall be limited to -70 dBW/MHz equivalent isotropically radiated power (EIRP) for wideband signals, and -80 dBW EIRP for discrete emissions of less than 700 Hz bandwidth. For the purpose of equipment authorization, a transmitter shall be tested with an antenna that is representative of the type that will be used with the equipment in normal operation.

Rule Part 27.53 (c) For operations in the 746-758 MHz band and the 776-788 MHz band, the power of any emission outside the licensee's frequency band(s) of operation shall be attenuated below the transmitter power (P) within the licensed band(s) of operation, measured in watts, in accordance with the following:

- (1) On any frequency outside the 746-758 MHz band, the power of any emission shall be attenuated outside the band below the transmitter power (P) by at least $43 + 10 \log (P)$ dB;
- (2) On any frequency outside the 776-788 MHz band, the power of any emission shall be attenuated outside the band below the transmitter power (P) by at least $43 + 10 \log (P)$ dB;
- (3) On all frequencies between 763-775 MHz and 793-805 MHz, by a factor not less than $76 + 10 \log (P)$ dB in a 6.25 kHz band segment, for base and fixed stations;
- (4) On all frequencies between 763-775 MHz and 793-805 MHz, by a factor not less than $65 + 10 \log (P)$ dB in a 6.25 kHz band segment, for mobile and portable stations;
- (5) Compliance with the provisions of paragraphs (c)(1) and (c)(2) of this section is based on the use of measurement instrumentation employing a resolution bandwidth of 100 kHz or greater. However, in the 100 kHz bands immediately outside and adjacent to the frequency block, a resolution bandwidth of at least 30 kHz may be employed;

Measurement Uncertainty

The assessed measurement uncertainty to ensure 95% confidence level for the normal distribution is with the coverage factor $k = 1.96$, $U=0.684$ dB.

Test Result

All the test traces in the plots shows the test results clearly.

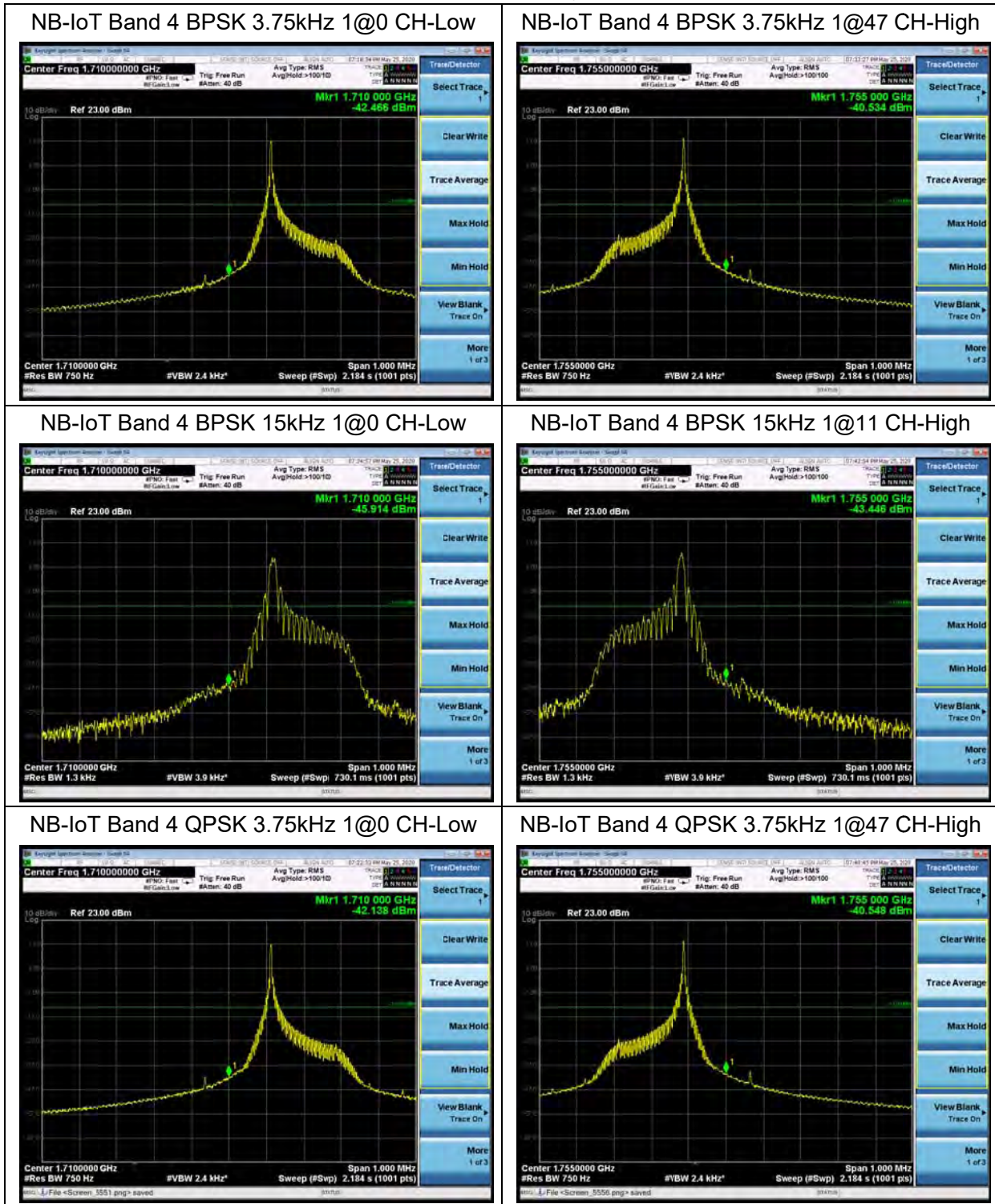

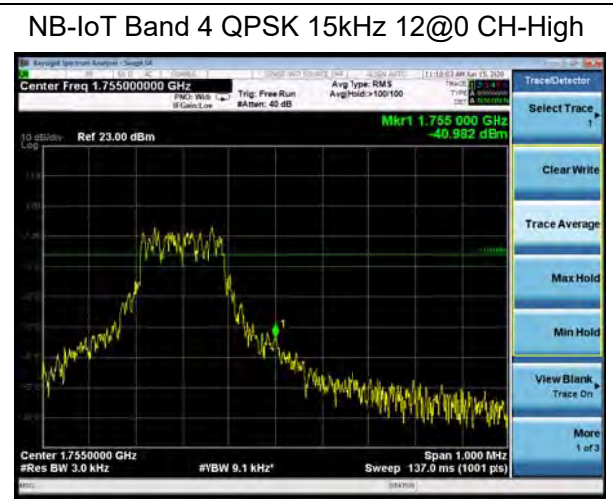
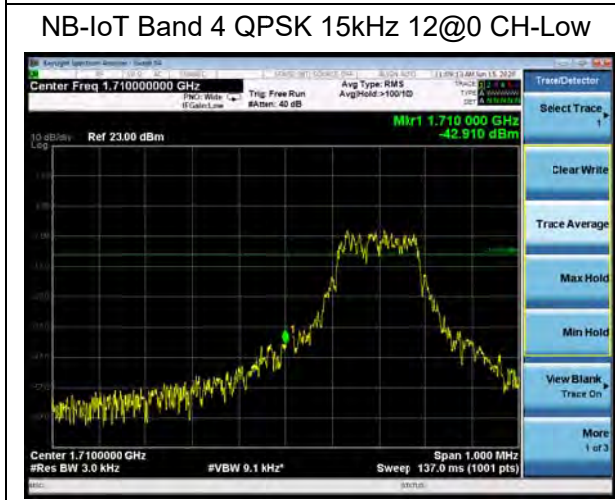
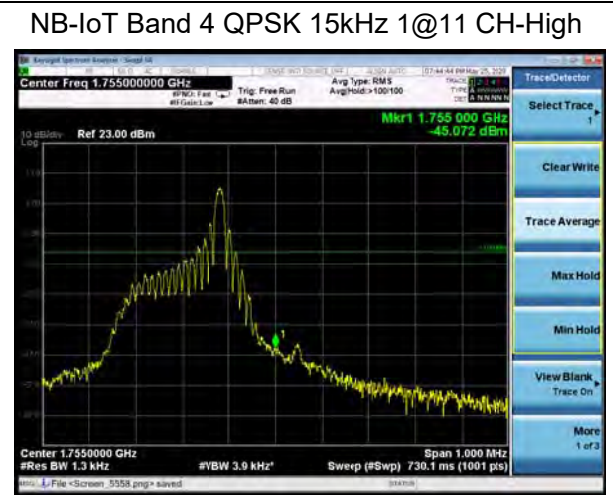
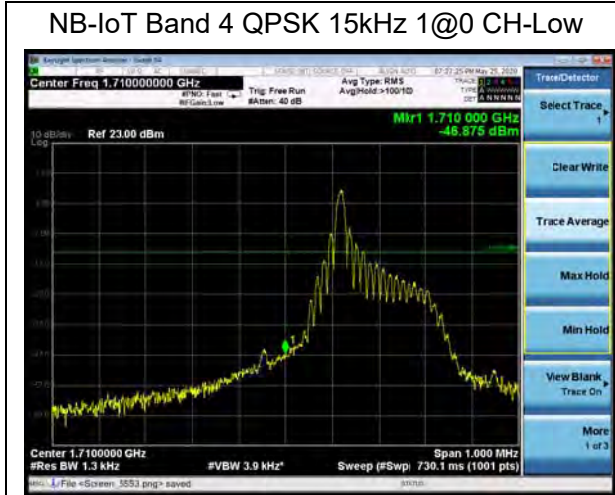



NB-IoT Band 12 BPSK 3.75kHz 1@0 CH-Low



NB-IoT Band 12 BPSK 3.75kHz 1@47 CH-High



NB-IoT Band 12 BPSK 15kHz 1@0 CH-Low



NB-IoT Band 12 BPSK 15kHz 1@11 CH-High



NB-IoT Band 12 QPSK 3.75kHz 1@0 CH-Low



NB-IoT Band 12 QPSK 3.75kHz 1@47 CH-High





NB-IoT Band 12 QPSK 15kHz 1@0 CH-Low



NB-IoT Band 12 QPSK 15kHz 1@11 CH-High



NB-IoT Band 12 QPSK 15kHz 12@0 CH-Low



NB-IoT Band 12 QPSK 15kHz 12@0 CH-High





NB-IoT Band 13 BPSK 3.75kHz 1@0 CH-Low



NB-IoT Band 13 BPSK 3.75kHz 1@47 CH-High



NB-IoT Band 13 BPSK 15kHz 1@0 CH-Low



NB-IoT Band 13 BPSK 15kHz 1@11 CH-High



NB-IoT Band 13 QPSK 3.75kHz 1@0 CH-Low



NB-IoT Band 13 QPSK 3.75kHz 1@47 CH-High





NB-IoT Band 13 QPSK 15kHz 1@0 CH-Low



NB-IoT Band 13 QPSK 15kHz 1@11 CH-High



NB-IoT Band 13 QPSK 15kHz 12@0 CH-Low



NB-IoT Band 13 QPSK 15kHz 12@0 CH-High





NB-IoT Band 13 BPSK 3.75kHz 1@0
763MHz-775MHz

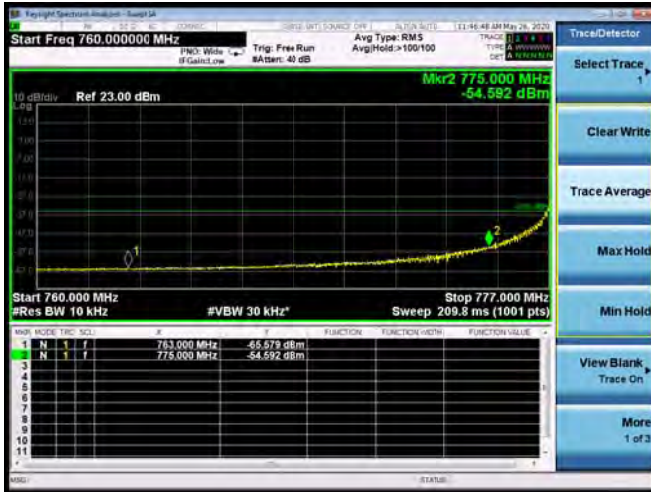

NB-IoT Band 13 BPSK 3.75kHz 1@47
793MHz -805MHz



NB-IoT Band 13 BPSK 15kHz 1@0
763MHz-775MHz



NB-IoT Band 13 BPSK 15kHz 1@11
793MHz -805MHz

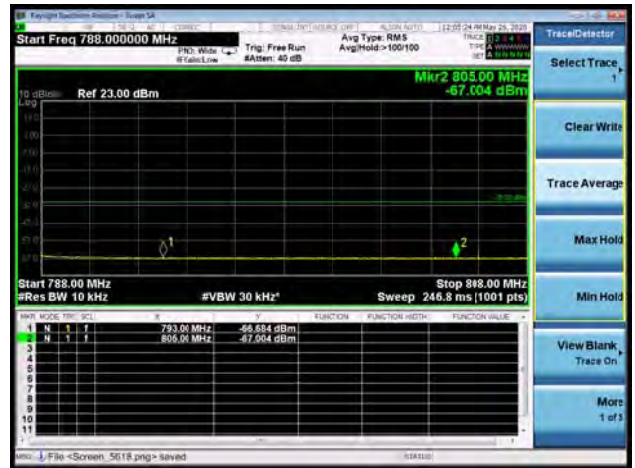

NB-IoT Band 13 QPSK 3.75kHz 1@0
763MHz-775MHz

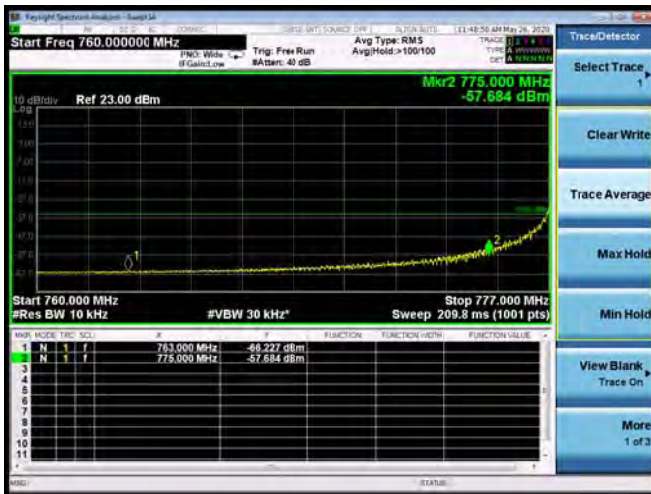

NB-IoT Band 13 QPSK 3.75kHz 1@47
793MHz -805MHz





NB-IoT Band 13 QPSK 15kHz 1@0
763MHz-775MHz



NB-IoT Band 13 QPSK 15kHz 1@11
793MHz -805MHz

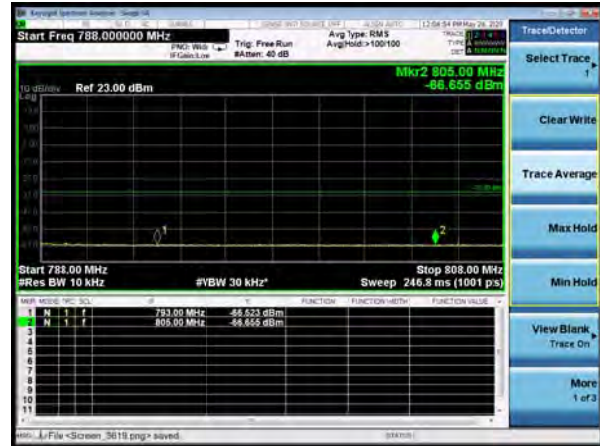

NB-IoT Band 13 QPSK 15kHz 12@0
763MHz-775MHz

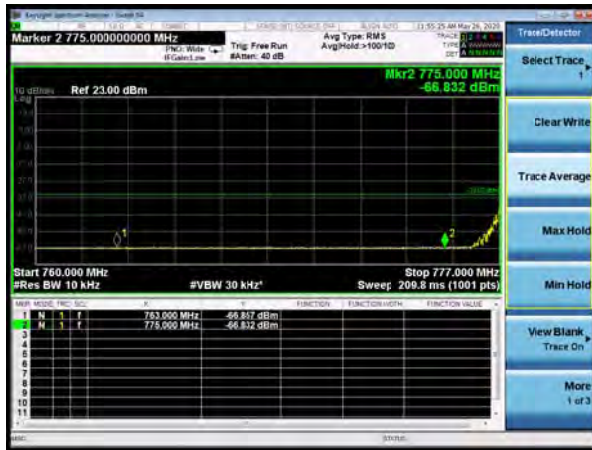

NB-IoT Band 13 QPSK 15kHz 12@0
793MHz -805MHz

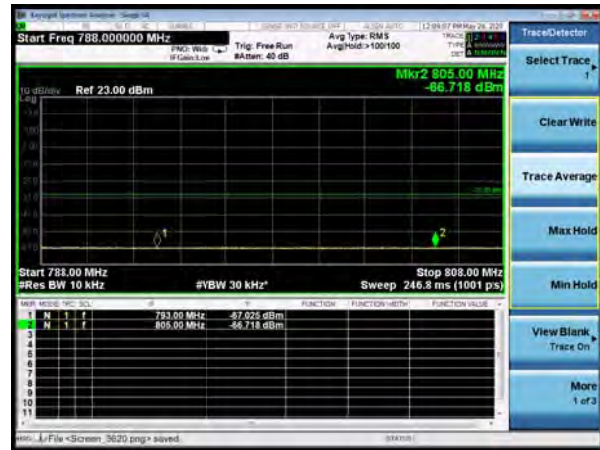



NB-IoT Band 66 BPSK 3.75kHz 1@0 CH-Low

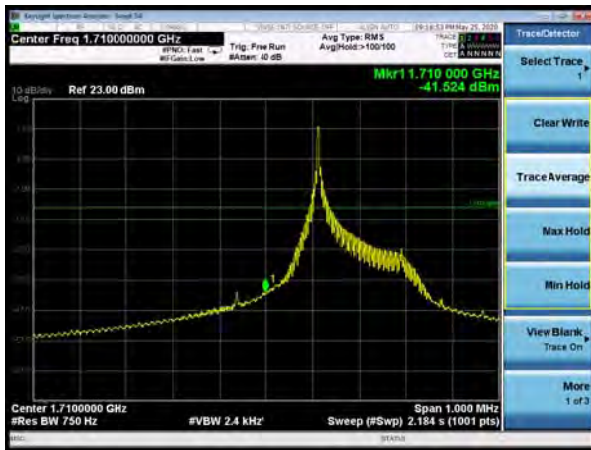

NB-IoT Band 66 BPSK 3.75kHz 1@47 CH-High



NB-IoT Band 66 BPSK 15kHz 1@0 CH-Low

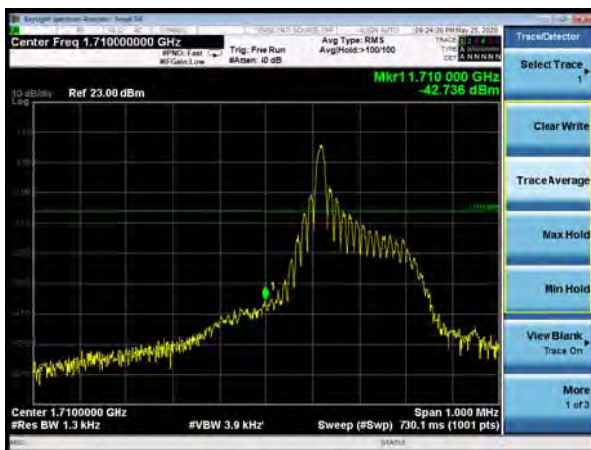

NB-IoT Band 66 BPSK 15kHz 1@11 CH-High

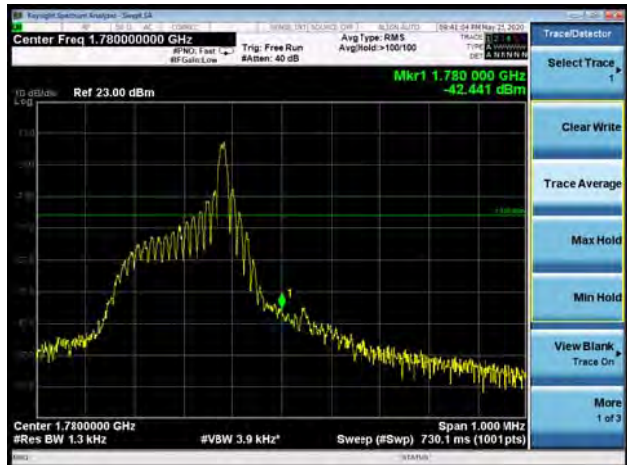

NB-IoT Band 66 QPSK 3.75kHz 1@0 CH-Low

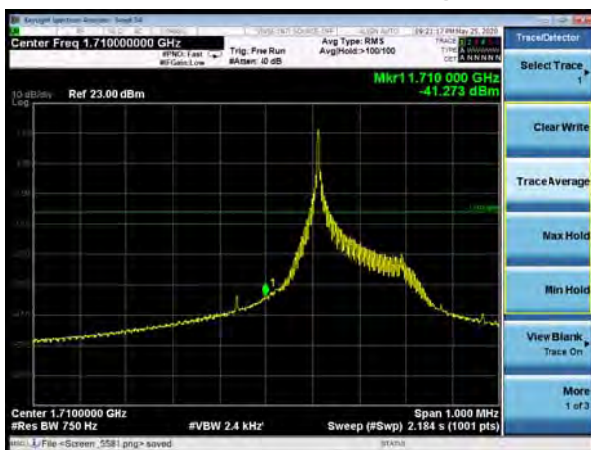

NB-IoT Band 66 QPSK 3.75kHz 1@47 CH-High





NB-IoT Band 66 QPSK 15kHz 1@0 CH-Low

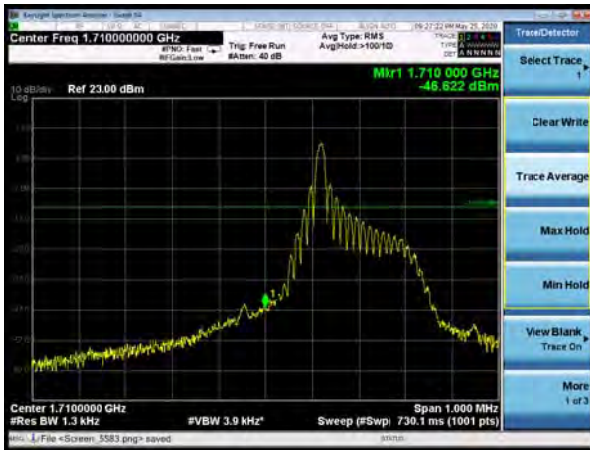

NB-IoT Band 66 QPSK 15kHz 1@11 CH-High

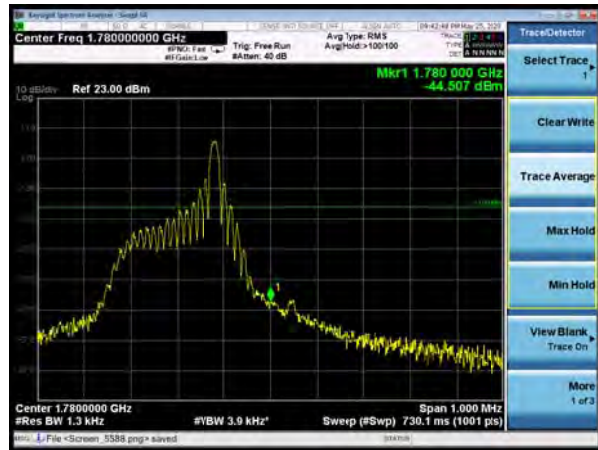

NB-IoT Band 66 QPSK 15kHz 12@0 CH-Low

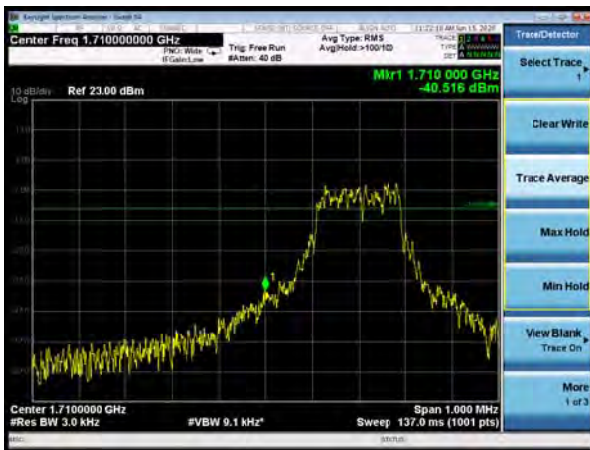

NB-IoT Band 66 QPSK 15kHz 12@0 CH-High

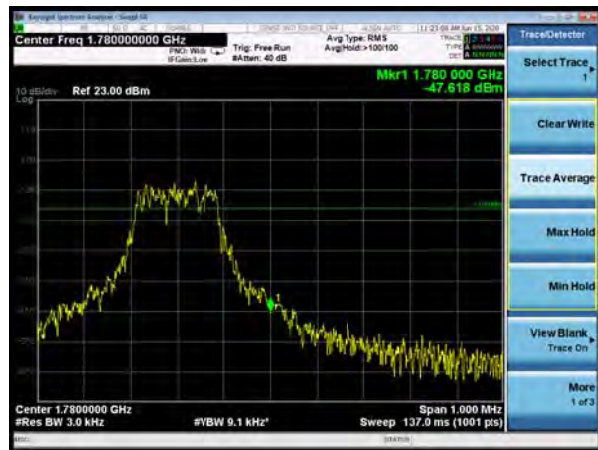



NB-IoT Band 71 BPSK 3.75kHz 1@0 CH-Low



NB-IoT Band 71 BPSK 3.75kHz 1@47 CH-High



NB-IoT Band 71 BPSK 15kHz 1@0 CH-Low



NB-IoT Band 71 BPSK 15kHz 1@11 CH-High



NB-IoT Band 71 QPSK 3.75kHz 1@0 CH-Low



NB-IoT Band 71 QPSK 3.75kHz 1@47 CH-High





NB-IoT Band 71 QPSK 15kHz 1@0 CH-Low



NB-IoT Band 71 QPSK 15kHz 1@11 CH-High



NB-IoT Band 71 QPSK 15kHz 12@0 CH-Low

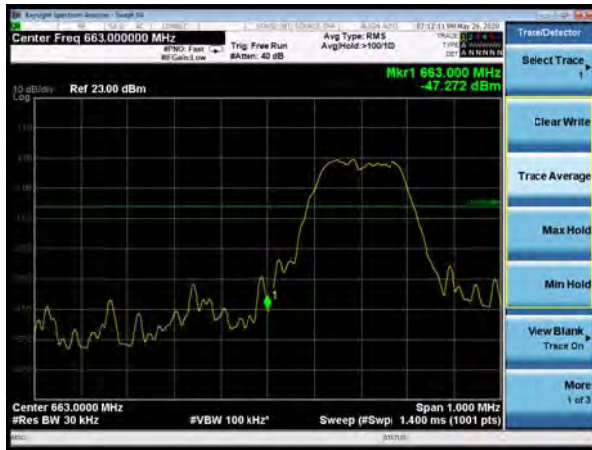

NB-IoT Band 71 QPSK 15kHz 12@0 CH-High





NB-IoT Band 85 BPSK 3.75kHz 1@0 CH-Low



NB-IoT Band 85 BPSK 3.75kHz 1@47 CH-High



NB-IoT Band 85 BPSK 15kHz 1@0 CH-Low



NB-IoT Band 85 BPSK 15kHz 1@11 CH-High



NB-IoT Band 85 QPSK 3.75kHz 1@0 CH-Low



NB-IoT Band 85 QPSK 3.75kHz 1@47 CH-High





NB-IoT Band 85 QPSK 15kHz 1@0 CH-Low



NB-IoT Band 85 QPSK 15kHz 1@11 CH-High

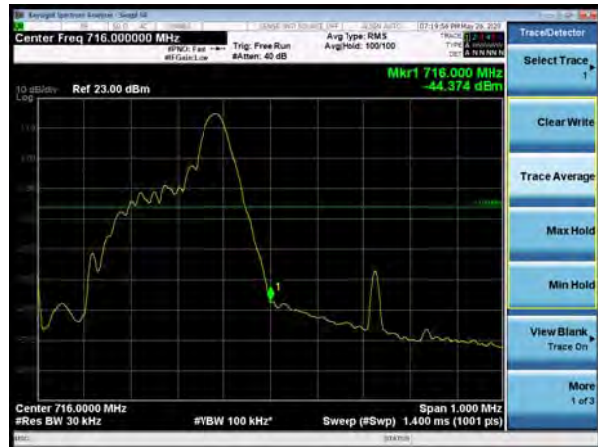

NB-IoT Band 85 QPSK 15kHz 12@0 CH-Low



NB-IoT Band 85 QPSK 15kHz 12@0 CH-High



5.4 Peak-to-Average Power Ratio (PAPR)

Ambient condition

Temperature	Relative humidity	Pressure
23°C ~25°C	45%~50%	101.5kPa

Methods of Measurement

Measure the total peak power and record as PPK. And measure the total average power and record as PAvg. Both the peak and average power levels must be expressed in the same logarithmic units (e.g., dBm). Determine the PAPR from:

$$PAPR (dB) = PPK (dBm) - PAvg (dBm).$$

Test Setup

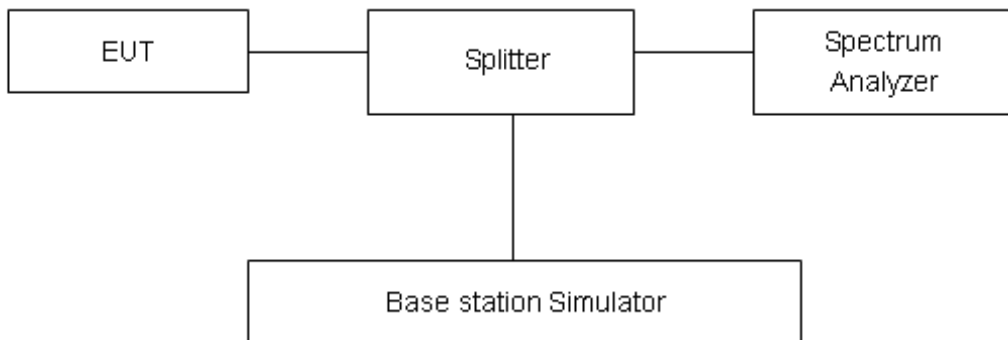

Limits

Rule Part 27.50(d)(5) Equipment employed must be authorized in accordance with the provisions of 24.51. Power measurements for transmissions by stations authorized under this section may be made either in accordance with a Commission-approved average power technique or in compliance with paragraph (d)(6) of this section. In measuring transmissions in this band using an average power technique, the peak-to-average ratio (PAR) of the transmission may not exceed 13 dB.

Measurement Uncertainty

The assessed measurement uncertainty to ensure 95% confidence level for the normal distribution is with the coverage factor $k = 2$, $U = 0.4$ dB.



Test Results

Mode	Modulation	Sub-carrier spacing (KHz)	Channel/ Frequency(MHz)	Peak-to-Average Power Ratio (PAPR)			Limit (dB)	Conclusion
				Peak(dBm)	Avg(dBm)	PAPR(dB)		
Band 4 Standalone	BPSK	3.75	20175/1732.5	25.12	20.27	4.85	≤13	PASS
	QPSK	3.75	20175/1732.5	24.42	20.25	4.17	≤13	PASS
	BPSK	15	20175/1732.5	24.65	17.35	7.30	≤13	PASS
	QPSK	15	20175/1732.5	24.34	17.43	6.91	≤13	PASS
Mode	Modulation	Sub-carrier spacing (KHz)	Channel/ Frequency(MHz)	Peak-to-Average Power Ratio (PAPR)			Limit (dB)	Conclusion
				Peak(dBm)	Avg(dBm)	PAPR(dB)		
Band 12 Standalone	BPSK	3.75	23095/707.5	25.54	20.79	4.75	≤13	PASS
	QPSK	3.75	23095/707.5	24.82	20.72	4.10	≤13	PASS
	BPSK	15	23095/707.5	25.13	17.93	7.20	≤13	PASS
	QPSK	15	23095/707.5	24.80	17.94	6.86	≤13	PASS
Mode	Modulation	Sub-carrier spacing (KHz)	Channel/ Frequency(MHz)	Peak-to-Average Power Ratio (PAPR)			Limit (dB)	Conclusion
				Peak(dBm)	Avg(dBm)	PAPR(dB)		
Band 13 Standalone	BPSK	3.75	23230/782	25.26	20.55	4.71	≤13	PASS
	QPSK	3.75	23230/782	24.59	20.50	4.09	≤13	PASS
	BPSK	15	23230/782	24.92	17.75	7.17	≤13	PASS
	QPSK	15	23230/782	24.58	17.78	6.80	≤13	PASS
Mode	Modulation	Sub-carrier spacing (KHz)	Channel/ Frequency(MHz)	Peak-to-Average Power Ratio (PAPR)			Limit (dB)	Conclusion
				Peak(dBm)	Avg(dBm)	PAPR(dB)		
Band 66 Standalone	BPSK	3.75	132322/1745	25.40	20.56	4.84	≤13	PASS
	QPSK	3.75	132322/1745	24.73	20.57	4.16	≤13	PASS
	BPSK	15	132322/1745	24.53	17.56	6.97	≤13	PASS
	QPSK	15	132322/1745	24.87	17.58	7.29	≤13	PASS
Mode	Modulation	Sub-carrier spacing (KHz)	Channel/ Frequency(MHz)	Peak-to-Average Power Ratio (PAPR)			Limit (dB)	Conclusion
				Peak(dBm)	Avg(dBm)	PAPR(dB)		
Band 71 Standalone	BPSK	3.75	133297/680.5	25.98	21.20	4.78	≤13	PASS
	QPSK	3.75	133297/680.5	25.35	21.23	4.12	≤13	PASS
	BPSK	15	133297/680.5	25.51	18.28	7.23	≤13	PASS
	QPSK	15	133297/680.5	25.17	18.30	6.87	≤13	PASS
Mode	Modulation	Sub-carrier spacing (KHz)	Channel/ Frequency(MHz)	Peak-to-Average Power Ratio (PAPR)			Limit (dB)	Conclusion
				Peak(dBm)	Avg(dBm)	PAPR(dB)		
Band 85 Standalone	BPSK	3.75	134092/707	25.53	20.78	4.75	≤13	PASS
	QPSK	3.75	134092/707	24.86	20.76	4.10	≤13	PASS
	BPSK	15	134092/707	25.12	17.95	7.17	≤13	PASS
	QPSK	15	134092/707	24.79	17.89	6.90	≤13	PASS

5.5 Frequency Stability

Ambient condition

Temperature	Relative humidity	Pressure
23°C ~25°C	45%~50%	101.5kPa

Method of Measurement

Frequency Stability (Temperature Variation)

The temperature inside the climate chamber is varied from -40°C to +85°C in 10°C step size.

(1) With all power removed, the temperature was decreased to -10°C and permitted to stabilize for three hours.

(2) Measure the carrier frequency with the test equipment in a “call mode”. These measurements should be made within 1 minute of powering up the mobile station, to prevent significant self warming.

(3) Repeat the above measurements at 10°C increments from -40°C to +85°C. Allow at least 1.5 hours at each temperature, un-powered, before making measurements.

Frequency Stability (Voltage Variation)

The frequency stability shall be measured with variation of primary supply voltage as follows:

(1) Vary primary supply voltage from 85 to 115 percent of the nominal value for other than hand carried battery equipment.

(2) For hand carried, battery powered equipment, reduce primary supply voltage to the battery-operating end point which shall be specified by the manufacturer.

This transceiver is specified to operate with an input voltage of between 3.3 V and 4.3 V, with a nominal voltage of 3.8V.

Test setup

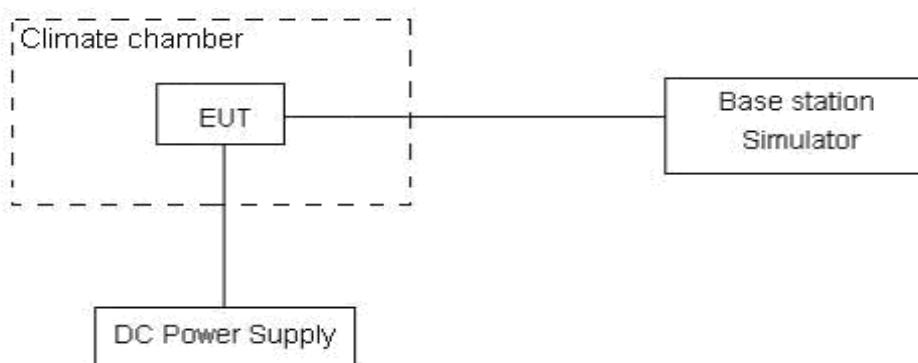

Limits

The frequency stability shall be sufficient to ensure that the fundamental emissions stay within the authorized bands of operation.

Measurement Uncertainty

The assessed measurement uncertainty to ensure 99.75% confidence level for the normal distribution is with the coverage factor $k = 3, U = 0.01\text{ppm}$.



Test Result

NB-IoT Band 4						
Condition		Freq.Error (Hz)	Freq.Error (Hz)	Frequency Stability(ppm)	Frequency Stability(ppm)	Verdict
Sub-carrier spacing (KHz)	3.75					
Temperature	Voltage	BPSK	QPSK	BPSK	QPSK	
Normal(25°C)	Normal	9.35	17.74	0.00497	0.00944	PASS
Extreme(85°C)		4.37	12.09	0.00233	0.00643	PASS
Extreme(80°C)		4.60	7.06	0.00245	0.00376	PASS
Extreme(70°C)		11.79	9.34	0.00627	0.00497	PASS
Extreme(60°C)		3.84	15.70	0.00204	0.00835	PASS
Extreme(50°C)		7.35	4.69	0.00391	0.00250	PASS
Extreme(40°C)		4.59	1.56	0.00244	0.00083	PASS
Extreme(30°C)		6.68	12.26	0.00355	0.00652	PASS
Extreme(20°C)		17.37	11.59	0.00924	0.00616	PASS
Extreme(10°C)		6.11	9.18	0.00325	0.00488	PASS
Extreme(0°C)		12.14	4.06	0.00646	0.00216	PASS
Extreme(-10°C)		15.50	9.76	0.00824	0.00519	PASS
Extreme(-20°C)		4.67	6.05	0.00249	0.00322	PASS
Extreme(-30°C)		6.49	11.72	0.00345	0.00624	PASS
Extreme(-40°C)		1.54	1.39	0.00082	0.00074	PASS
25°C		LV	3.56	10.25	0.00189	0.00545
	HV	12.70	2.17	0.00675	0.00116	PASS
Condition		Freq.Error (Hz)	Freq.Error (Hz)	Frequency Stability(ppm)	Frequency Stability(ppm)	Verdict
Sub-carrier spacing (KHz)	15					
Temperature	Voltage	BPSK	QPSK	BPSK	QPSK	
Normal(25°C)	Normal	13.28	16.32	0.00706	0.00868	PASS
Extreme(85°C)		11.81	6.50	0.00628	0.00346	PASS
Extreme(80°C)		10.68	17.23	0.00568	0.00917	PASS
Extreme(70°C)		4.61	12.46	0.00245	0.00663	PASS
Extreme(60°C)		10.34	2.42	0.00550	0.00129	PASS
Extreme(50°C)		15.82	10.63	0.00842	0.00565	PASS
Extreme(40°C)		4.07	4.95	0.00216	0.00263	PASS
Extreme(30°C)		7.52	5.39	0.00400	0.00287	PASS
Extreme(20°C)		13.73	15.52	0.00730	0.00825	PASS
Extreme(10°C)		2.43	11.38	0.00129	0.00605	PASS
Extreme(0°C)		2.69	3.58	0.00143	0.00191	PASS
Extreme(-10°C)		12.91	4.74	0.00687	0.00252	PASS
Extreme(-20°C)		11.32	15.04	0.00602	0.00800	PASS



Extreme(-30°C)		7.75	8.43	0.00412	0.00448	PASS
Extreme(-40°C)		9.42	1.81	0.00501	0.00096	PASS
25°C	LV	6.50	5.77	0.00346	0.00307	PASS
	HV	13.85	11.71	0.00737	0.00623	PASS

NB-IoT Band 12						
Condition		Freq.Error (Hz)	Freq.Error (Hz)	Frequency Stability(ppm)	Frequency Stability(ppm)	Verdict
Sub-carrier spacing (KHz)	3.75					
Temperature	Voltage	BPSK	QPSK	BPSK	QPSK	
Normal(25°C)	Normal	7.77	4.42	0.00413	0.00235	PASS
Extreme(85°C)		3.28	10.93	0.00174	0.00581	PASS
Extreme(80°C)		4.32	9.79	0.00230	0.00521	PASS
Extreme(70°C)		8.31	6.32	0.00442	0.00336	PASS
Extreme(60°C)		6.52	6.50	0.00347	0.00346	PASS
Extreme(50°C)		5.93	6.61	0.00315	0.00352	PASS
Extreme(40°C)		5.27	4.22	0.00280	0.00225	PASS
Extreme(30°C)		17.47	10.06	0.00929	0.00535	PASS
Extreme(20°C)		15.05	5.74	0.00800	0.00305	PASS
Extreme(10°C)		3.25	1.95	0.00173	0.00104	PASS
Extreme(0°C)		17.59	15.76	0.00936	0.00838	PASS
Extreme(-10°C)		8.63	16.86	0.00459	0.00897	PASS
Extreme(-20°C)		7.11	1.20	0.00378	0.00064	PASS
Extreme(-30°C)		11.91	16.50	0.00633	0.00878	PASS
Extreme(-40°C)		10.23	3.57	0.00544	0.00190	PASS
25°C	LV	3.60	10.64	0.00191	0.00566	PASS
	HV	1.17	15.62	0.00062	0.00831	PASS
Condition		Freq.Error (Hz)	Freq.Error (Hz)	Frequency Stability(ppm)	Frequency Stability(ppm)	Verdict
Sub-carrier spacing (KHz)	15					
Temperature	Voltage	BPSK	QPSK	BPSK	QPSK	
Normal(25°C)	Normal	2.34	16.25	0.00125	0.00864	PASS
Extreme(85°C)		1.29	15.04	0.00069	0.00800	PASS
Extreme(80°C)		1.23	17.58	0.00065	0.00935	PASS
Extreme(70°C)		11.45	12.74	0.00609	0.00677	PASS
Extreme(60°C)		14.97	16.23	0.00796	0.00863	PASS
Extreme(50°C)		6.63	16.48	0.00353	0.00876	PASS
Extreme(40°C)		9.10	16.68	0.00484	0.00887	PASS
Extreme(30°C)		1.01	8.25	0.00054	0.00439	PASS



Extreme(20°C)		6.67	11.97	0.00355	0.00637	PASS
Extreme(10°C)		3.67	15.78	0.00195	0.00839	PASS
Extreme(0°C)		2.71	14.12	0.00144	0.00751	PASS
Extreme(-10°C)		14.68	3.32	0.00781	0.00176	PASS
Extreme(-20°C)		2.86	5.09	0.00152	0.00271	PASS
Extreme(-30°C)		17.71	11.70	0.00942	0.00622	PASS
Extreme(-40°C)		15.82	10.20	0.00841	0.00542	PASS
25°C	LV	17.72	7.48	0.00943	0.00398	PASS
	HV	1.17	16.18	0.00062	0.00861	PASS

NB-IoT Band 13						
Condition		Freq.Error (Hz)	Freq.Error (Hz)	Frequency Stability(ppm)	Frequency Stability(ppm)	Verdict
Sub-carrier spacing (KHz)	3.75					
Temperature	Voltage	BPSK	QPSK	BPSK	QPSK	
Normal(25°C)	Normal	5.05	7.10	0.00269	0.00378	PASS
Extreme(85°C)		12.29	16.72	0.00654	0.00889	PASS
Extreme(80°C)		10.56	13.78	0.00561	0.00733	PASS
Extreme(70°C)		10.41	15.70	0.00554	0.00835	PASS
Extreme(60°C)		2.42	16.95	0.00129	0.00901	PASS
Extreme(50°C)		2.01	3.14	0.00107	0.00167	PASS
Extreme(40°C)		16.17	3.90	0.00860	0.00207	PASS
Extreme(30°C)		12.61	7.30	0.00671	0.00388	PASS
Extreme(20°C)		15.74	1.42	0.00837	0.00076	PASS
Extreme(10°C)		4.59	13.26	0.00244	0.00705	PASS
Extreme(0°C)		10.94	15.74	0.00582	0.00837	PASS
Extreme(-10°C)		4.05	11.94	0.00215	0.00635	PASS
Extreme(-20°C)		8.01	2.49	0.00426	0.00132	PASS
Extreme(-30°C)		10.45	15.21	0.00556	0.00809	PASS
Extreme(-40°C)		1.21	6.44	0.00065	0.00343	PASS
25°C		LV	7.38	14.67	0.00392	0.00780
	HV	3.75	15.52	0.00199	0.00825	PASS
Condition		Freq.Error (Hz)	Freq.Error (Hz)	Frequency Stability(ppm)	Frequency Stability(ppm)	Verdict
Sub-carrier spacing (KHz)	15					
Temperature	Voltage	BPSK	QPSK	BPSK	QPSK	
Normal(25°C)	Normal	15.38	9.08	0.00818	0.00483	PASS
Extreme(85°C)		9.76	15.42	0.00519	0.00820	PASS
Extreme(80°C)		6.81	3.01	0.00362	0.00160	PASS



Extreme(70°C)		2.88	9.74	0.00153	0.00518	PASS
Extreme(60°C)		17.82	9.95	0.00948	0.00529	PASS
Extreme(50°C)		16.49	3.83	0.00877	0.00204	PASS
Extreme(40°C)		8.98	1.05	0.00478	0.00056	PASS
Extreme(30°C)		12.39	15.08	0.00659	0.00802	PASS
Extreme(20°C)		15.34	8.85	0.00816	0.00471	PASS
Extreme(10°C)		2.30	2.84	0.00122	0.00151	PASS
Extreme(0°C)		8.70	7.94	0.00463	0.00422	PASS
Extreme(-10°C)		9.46	9.89	0.00503	0.00526	PASS
Extreme(-20°C)		13.39	8.02	0.00712	0.00426	PASS
Extreme(-30°C)		10.82	11.43	0.00575	0.00608	PASS
Extreme(-40°C)		16.84	14.29	0.00896	0.00760	PASS
25°C	LV	12.55	16.15	0.00668	0.00859	PASS
	HV	17.76	13.53	0.00945	0.00720	PASS

NB-IoT Band 66						
Condition		Freq.Error (Hz)	Freq.Error (Hz)	Frequency Stability(ppm)	Frequency Stability(ppm)	Verdict
Sub-carrier spacing (KHz)	3.75	BPSK	QPSK	BPSK	QPSK	
Temperature	Voltage					
Normal(25°C)	Normal	14.89	17.35	0.00792	0.00923	PASS
Extreme(85°C)		16.65	14.36	0.00886	0.00764	PASS
Extreme(80°C)		16.23	1.41	0.00863	0.00075	PASS
Extreme(70°C)		17.96	17.62	0.00955	0.00937	PASS
Extreme(60°C)		6.77	1.77	0.00360	0.00094	PASS
Extreme(50°C)		16.80	8.42	0.00894	0.00448	PASS
Extreme(40°C)		11.16	14.95	0.00594	0.00795	PASS
Extreme(30°C)		8.67	3.09	0.00461	0.00164	PASS
Extreme(20°C)		12.53	3.09	0.00667	0.00164	PASS
Extreme(10°C)		3.33	5.75	0.00177	0.00306	PASS
Extreme(0°C)		7.50	10.16	0.00399	0.00540	PASS
Extreme(-10°C)		3.21	14.81	0.00171	0.00788	PASS
Extreme(-20°C)		15.33	6.30	0.00815	0.00335	PASS
Extreme(-30°C)		8.91	5.76	0.00474	0.00306	PASS
Extreme(-40°C)		3.81	11.29	0.00203	0.00600	PASS
25°C	LV	10.02	16.64	0.00533	0.00885	PASS
	HV	15.14	2.21	0.00805	0.00117	PASS
Condition		Freq.Error (Hz)	Freq.Error (Hz)	Frequency Stability(ppm)	Frequency Stability(ppm)	Verdict
Sub-carrier spacing	15					



(KHz)						
Temperature	Voltage	BPSK	QPSK	BPSK	QPSK	
Normal(25°C)	Normal	10.50	4.20	0.00558	0.00224	PASS
Extreme(85°C)		6.95	9.57	0.00370	0.00509	PASS
Extreme(80°C)		17.89	2.48	0.00952	0.00132	PASS
Extreme(70°C)		7.03	15.87	0.00374	0.00844	PASS
Extreme(60°C)		2.13	8.55	0.00113	0.00455	PASS
Extreme(50°C)		12.88	14.89	0.00685	0.00792	PASS
Extreme(40°C)		6.49	3.42	0.00345	0.00182	PASS
Extreme(30°C)		7.30	11.05	0.00388	0.00588	PASS
Extreme(20°C)		16.08	4.82	0.00855	0.00256	PASS
Extreme(10°C)		16.50	4.52	0.00878	0.00241	PASS
Extreme(0°C)		13.64	4.99	0.00726	0.00266	PASS
Extreme(-10°C)		5.68	10.87	0.00302	0.00578	PASS
Extreme(-20°C)		7.51	1.51	0.00400	0.00080	PASS
Extreme(-30°C)		4.30	15.36	0.00229	0.00817	PASS
Extreme(-40°C)		10.79	17.04	0.00574	0.00906	PASS
25°C	LV	12.23	4.49	0.00651	0.00239	PASS
	HV	17.63	2.74	0.00938	0.00146	PASS

NB-IoT Band 71						
Condition		Freq.Error (Hz)	Freq.Error (Hz)	Frequency Stability(ppm)	Frequency Stability(ppm)	Verdict
Sub-carrier spacing (KHz)	3.75					
Temperature	Voltage	BPSK	QPSK	BPSK	QPSK	
Normal(25°C)	Normal	14.67	2.50	0.00780	0.00133	PASS
Extreme(85°C)		13.31	5.46	0.00708	0.00290	PASS
Extreme(80°C)		8.05	12.64	0.00428	0.00672	PASS
Extreme(70°C)		12.01	14.95	0.00639	0.00795	PASS
Extreme(60°C)		16.74	7.29	0.00891	0.00388	PASS
Extreme(50°C)		14.53	2.41	0.00773	0.00128	PASS
Extreme(40°C)		17.14	5.44	0.00912	0.00290	PASS
Extreme(30°C)		12.25	6.63	0.00652	0.00352	PASS
Extreme(20°C)		12.95	16.81	0.00689	0.00894	PASS
Extreme(10°C)		11.52	1.48	0.00613	0.00079	PASS
Extreme(0°C)		9.28	6.43	0.00493	0.00342	PASS
Extreme(-10°C)		8.04	7.82	0.00428	0.00416	PASS
Extreme(-20°C)		6.57	3.94	0.00349	0.00210	PASS
Extreme(-30°C)		17.21	17.26	0.00916	0.00918	PASS
Extreme(-40°C)		16.19	11.66	0.00861	0.00620	PASS



Condition		Freq.Error (Hz)	Freq.Error (Hz)	Frequency Stability(ppm)	Frequency Stability(ppm)	Verdict
Sub-carrier spacing (KHz)	15					
Temperature	Voltage	BPSK	QPSK	BPSK	QPSK	
25°C	LV	9.20	2.80	0.00490	0.00149	PASS
	HV	12.77	6.45	0.00679	0.00343	PASS
Normal(25°C)	Normal	5.01	13.18	0.00267	0.00701	PASS
Extreme(85°C)		17.41	11.03	0.00926	0.00587	PASS
Extreme(80°C)		7.25	16.80	0.00385	0.00893	PASS
Extreme(70°C)		14.05	6.18	0.00747	0.00329	PASS
Extreme(60°C)		4.93	15.17	0.00262	0.00807	PASS
Extreme(50°C)		4.85	10.77	0.00258	0.00573	PASS
Extreme(40°C)		13.96	10.00	0.00743	0.00532	PASS
Extreme(30°C)		4.90	5.55	0.00260	0.00295	PASS
Extreme(20°C)		9.80	14.13	0.00521	0.00752	PASS
Extreme(10°C)		4.30	16.91	0.00229	0.00900	PASS
Extreme(0°C)		16.61	16.45	0.00883	0.00875	PASS
Extreme(-10°C)		17.81	16.96	0.00947	0.00902	PASS
Extreme(-20°C)		8.68	4.56	0.00462	0.00243	PASS
Extreme(-30°C)		8.37	8.76	0.00445	0.00466	PASS
Extreme(-40°C)	12.51	9.82	0.00665	0.00522	PASS	
25°C	LV	10.43	3.73	0.00555	0.00199	PASS
	HV	2.61	12.63	0.00139	0.00672	PASS

NB-IoT Band 85						
Condition		Freq.Error (Hz)	Freq.Error (Hz)	Frequency Stability(ppm)	Frequency Stability(ppm)	Verdict
Sub-carrier spacing (KHz)	3.75					
Temperature	Voltage	BPSK	QPSK	BPSK	QPSK	
Normal(25°C)	Normal	13.68	17.44	0.00727	0.00928	PASS
Extreme(85°C)		3.74	9.43	0.00199	0.00502	PASS
Extreme(80°C)		1.27	7.58	0.00068	0.00403	PASS
Extreme(70°C)		6.30	6.28	0.00335	0.00334	PASS
Extreme(60°C)		5.25	13.25	0.00279	0.00705	PASS
Extreme(50°C)		13.23	9.26	0.00704	0.00493	PASS
Extreme(40°C)		1.40	4.77	0.00074	0.00254	PASS
Extreme(30°C)		14.95	17.77	0.00795	0.00945	PASS
Extreme(20°C)		1.09	14.81	0.00058	0.00788	PASS
Extreme(10°C)		4.43	16.87	0.00236	0.00898	PASS



Extreme(0°C)		12.90	11.94	0.00686	0.00635	PASS
Extreme(-10°C)		11.65	10.24	0.00619	0.00545	PASS
Extreme(-20°C)		11.96	10.94	0.00636	0.00582	PASS
Extreme(-30°C)		16.91	11.18	0.00899	0.00595	PASS
Extreme(-40°C)		10.39	5.87	0.00553	0.00312	PASS
25°C	LV	11.65	8.67	0.00620	0.00461	PASS
	HV	15.84	2.98	0.00843	0.00159	PASS
Condition		Freq.Error	Freq.Error	Frequency	Frequency	Verdict
Sub-carrier spacing (KHz)	15	(Hz)	(Hz)	Stability(ppm)	Stability(ppm)	
Temperature	Voltage	BPSK	QPSK	BPSK	QPSK	
Normal(25°C)	Normal	6.51	2.39	0.00347	0.00127	PASS
Extreme(85°C)		13.71	10.76	0.00729	0.00572	PASS
Extreme(80°C)		5.00	8.39	0.00266	0.00446	PASS
Extreme(70°C)		4.91	16.65	0.00261	0.00885	PASS
Extreme(60°C)		7.78	2.37	0.00414	0.00126	PASS
Extreme(50°C)		1.09	13.26	0.00058	0.00705	PASS
Extreme(40°C)		2.09	12.76	0.00111	0.00679	PASS
Extreme(30°C)		10.34	2.50	0.00550	0.00133	PASS
Extreme(20°C)		7.17	14.52	0.00382	0.00772	PASS
Extreme(10°C)		6.16	10.65	0.00328	0.00567	PASS
Extreme(0°C)		9.77	3.46	0.00520	0.00184	PASS
Extreme(-10°C)		17.46	5.38	0.00929	0.00286	PASS
Extreme(-20°C)		13.75	8.57	0.00731	0.00456	PASS
Extreme(-30°C)		13.37	3.91	0.00711	0.00208	PASS
Extreme(-40°C)		1.85	8.11	0.00099	0.00431	PASS
25°C	LV	10.51	2.77	0.00559	0.00147	PASS
	HV	7.52	11.11	0.00400	0.00591	PASS

5.6 Spurious Emissions at Antenna Terminals

Ambient condition

Temperature	Relative humidity	Pressure
23°C ~25°C	45%~50%	101.5kPa

Method of Measurement

The EUT was connected to Spectrum Analyzer and Base Station Simulator via power Splitter. The measurement is carried out using a spectrum analyzer. The spectrum analyzer scans from 9kHz to the 10th harmonic of the carrier. The peak detector is used.

RBW is set to 100kHz, VBW is set to 300kHz for 30MHz~1GHz

RBW is set to 1MHz, VBW is set to 3MHz for above 1GHz, Sweep is set to ATUO.

Of those disturbances below (limit – 20 dB), the mark is not required for the EUT.

The modulation mode and RB allocation refer to section 5.1, using the maximum output power configuration.

Test setup

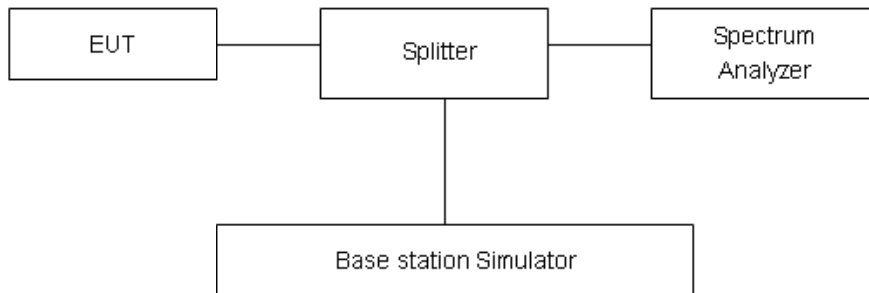

Limits

Rule Part 27.53(h) specifies that “for operations in the 1695-1710 MHz, 1710-1755 MHz, 1755-1780 MHz, 1915-1920 MHz, 1995-2000 MHz, 2000-2020 MHz, 2110-2155 MHz, 2155-2180 MHz, and 2180-2200 bands, the power of any emission outside a licensee's frequency block shall be attenuated below the transmitter power (P) in watts by at least $43 + 10 \log_{10}(P)$ dB..”

Rule Part 27.53 (g) For operations in the 600 MHz band and the 698-746 MHz band, the power of any emission outside a licensee's frequency band(s) of operation shall be attenuated below the transmitter power (P) within the licensed band(s) of operation, measured in watts, by at least $43 + 10 \log(P)$ dB. Compliance with this provision is based on the use of measurement instrumentation employing a resolution bandwidth of 100 kilohertz or greater. However, in the 100 kilohertz bands immediately outside and adjacent to a licensee's frequency block, a resolution bandwidth of at least 30 kHz may be employed.

Rule Part 27.53(f) For operations in the 746-758 MHz, 775-788 MHz, and 805-806 MHz bands,



emissions in the band 1559-1610 MHz shall be limited to -70 dBW/MHz equivalent isotropically radiated power (EIRP) for wideband signals, and -80 dBW EIRP for discrete emissions of less than 700 Hz bandwidth. For the purpose of equipment authorization, a transmitter shall be tested with an antenna that is representative of the type that will be used with the equipment in normal operation.

Part 27.53 (c) For operations in the 746-758 MHz band and the 776-788 MHz band, the power of any emission outside the licensee's frequency band(s) of operation shall be attenuated below the transmitter power (P) within the licensed band(s) of operation, measured in watts, in accordance with the following:

- (1) On any frequency outside the 746-758 MHz band, the power of any emission shall be attenuated outside the band below the transmitter power (P) by at least $43 + 10 \log (P)$ dB;
- (2) On any frequency outside the 776-788 MHz band, the power of any emission shall be attenuated outside the band below the transmitter power (P) by at least $43 + 10 \log (P)$ dB;
- (3) On all frequencies between 763-775 MHz and 793-805 MHz, by a factor not less than $76 + 10 \log (P)$ dB in a 6.25 kHz band segment, for base and fixed stations;
- (4) On all frequencies between 763-775 MHz and 793-805 MHz, by a factor not less than $65 + 10 \log (P)$ dB in a 6.25 kHz band segment, for mobile and portable stations;
- (5) Compliance with the provisions of paragraphs (c)(1) and (c)(2) of this section is based on the use of measurement instrumentation employing a resolution bandwidth of 100 kHz or greater. However, in the 100 kHz bands immediately outside and adjacent to the frequency block, a resolution bandwidth of at least 30 kHz may be employed;

Part 27.53(h)/(g) Limit		-13 dBm
Part 27.53(f) Limit	Limit out of the band 1559-1610 MHz	-13 dBm
	Limit in the band 1559-1610 MHz	-40 dBm

Measurement Uncertainty

The assessed measurement uncertainty to ensure 99.75% confidence level for the normal distribution is with the coverage factor $k = 1.96$.

Frequency	Uncertainty
9kHz-1GHz	0.684 dB
1GHz-27GHz	1.407 dB



Test Result

Sweep the whole frequency band through the range from 9kHz to the 10th harmonic of the carrier, the emissions more than 20 dB below the limit are not reported.

The signal beyond the limit is carrier.

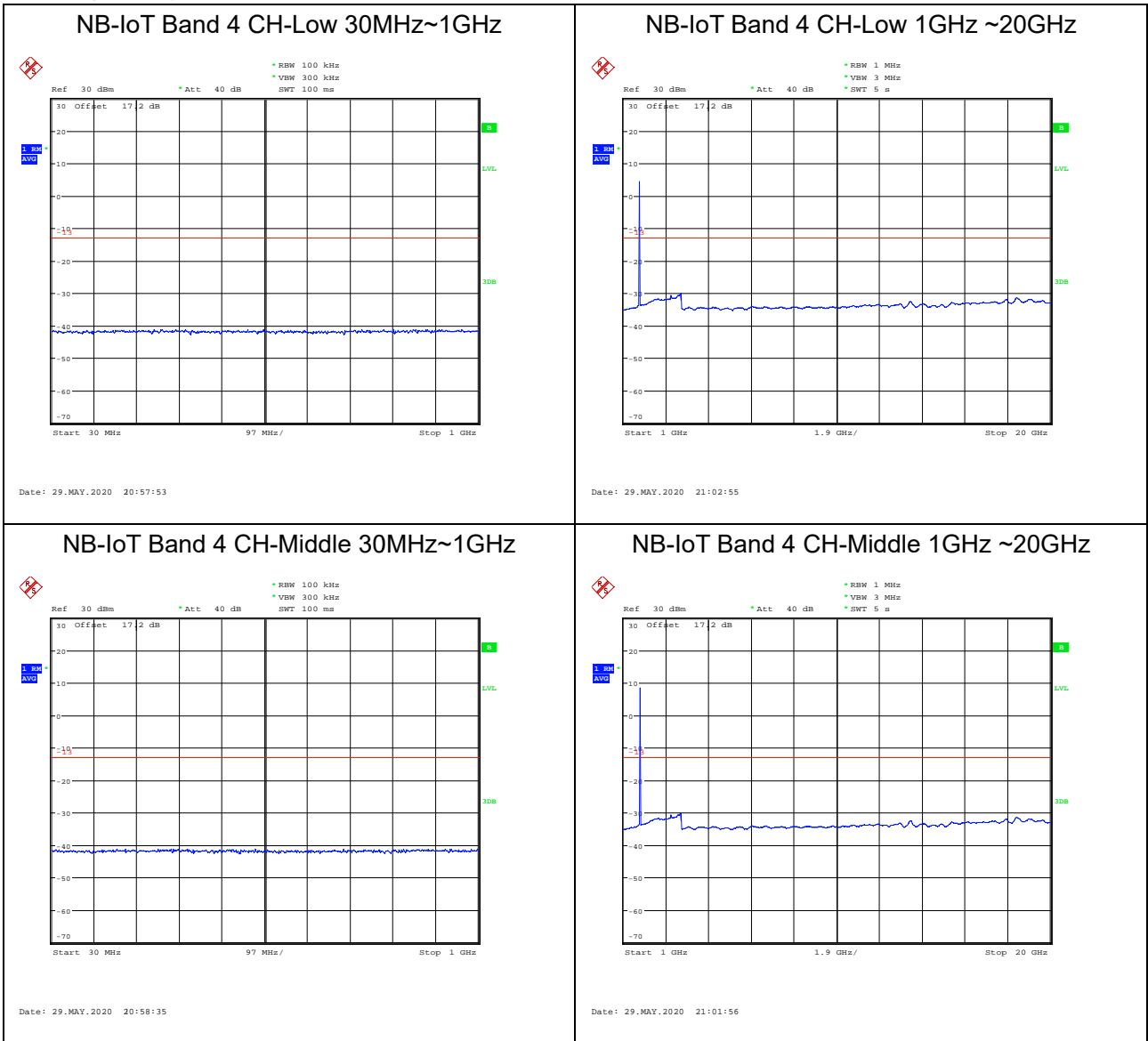



NB-IoT Band 4 CH-High 30MHz~1GHz

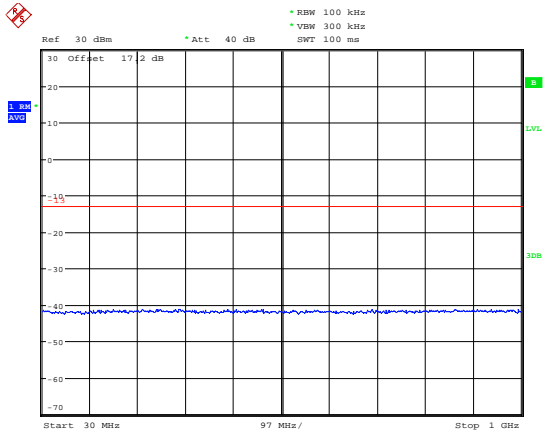

Date: 29.MAY.2020 21:00:12

NB-IoT Band 4 CH-High 1GHz ~20GHz

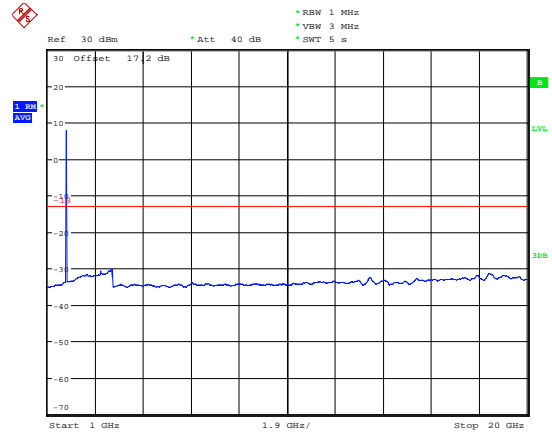

Date: 29.MAY.2020 21:00:40



NB-IoT Band 12 CH-Low 30MHz~1GHz

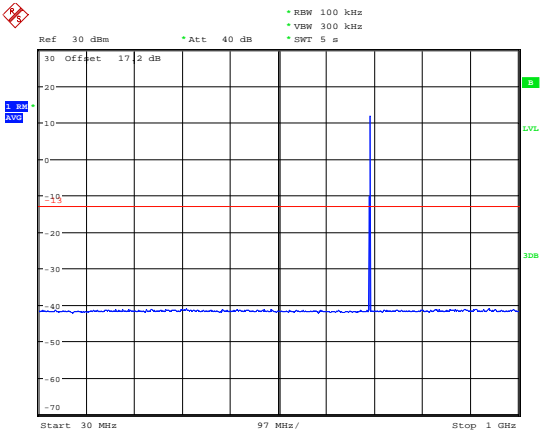

Date: 29.MAY.2020 21:11:46

NB-IoT Band 12 CH-Low 1GHz ~9GHz

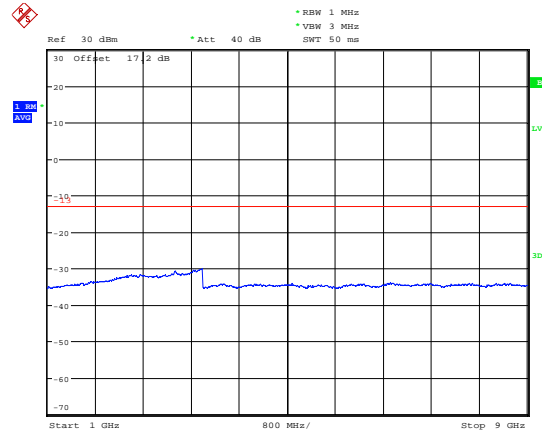

Date: 29.MAY.2020 21:17:31

NB-IoT Band 12 CH-Middle 30MHz~1GHz

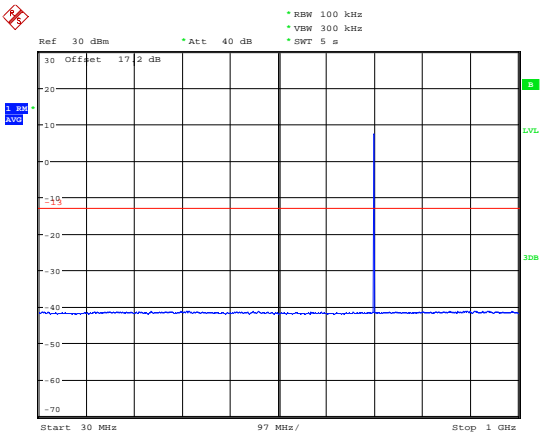

Date: 29.MAY.2020 21:15:59

NB-IoT Band 12 CH-Middle 1GHz ~9GHz

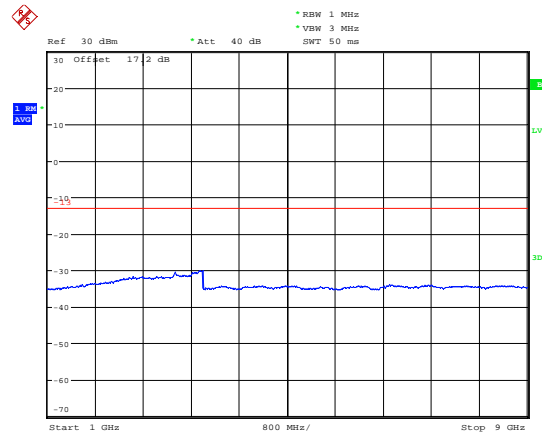

Date: 29.MAY.2020 21:17:47

NB-IoT Band 12 CH-High 30MHz~1GHz

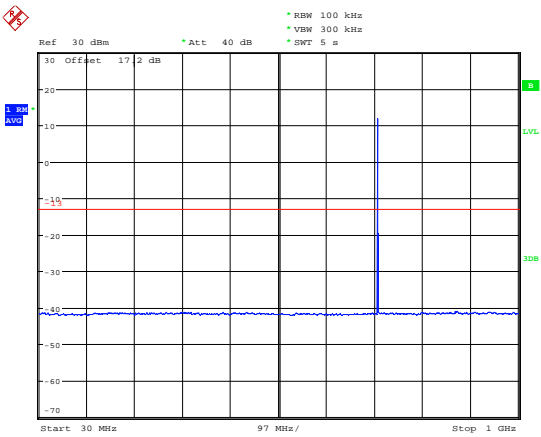

Date: 29.MAY.2020 21:17:08

NB-IoT Band 12 CH-High 1GHz ~9GHz

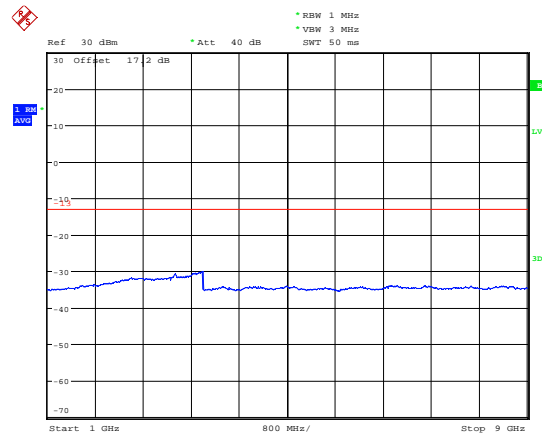

Date: 29.MAY.2020 21:17:56



NB-IoT Band 13 CH-Low 30MHz~1GHz

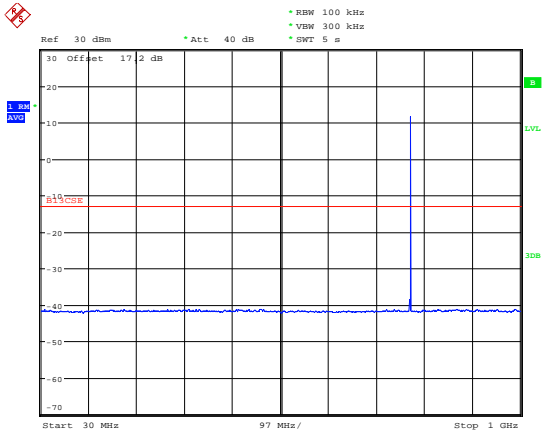

Date: 29.MAY.2020 21:22:17

NB-IoT Band 13 CH-Low 1GHz ~9GHz

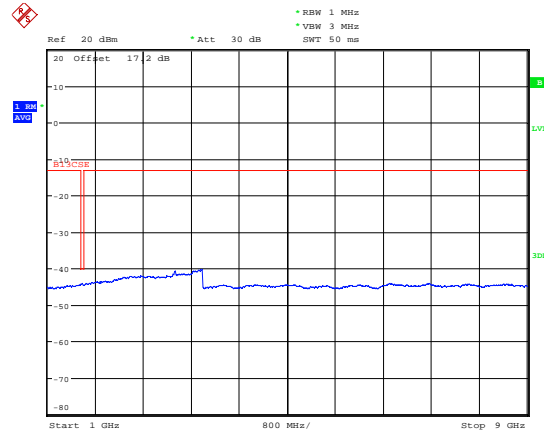

Date: 29.MAY.2020 21:26:25

NB-IoT Band 13 CH-Middle 30MHz~1GHz

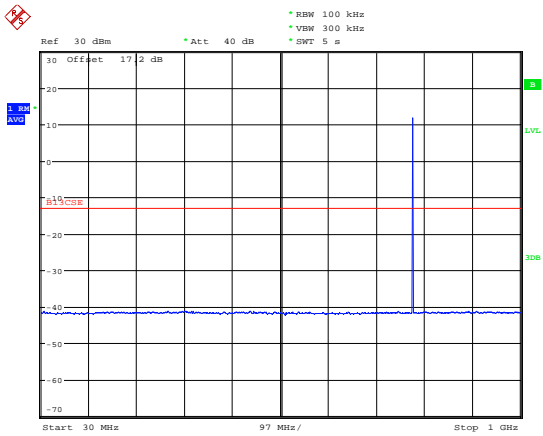

Date: 29.MAY.2020 21:24:09

NB-IoT Band 13 CH-Middle 1GHz ~9GHz

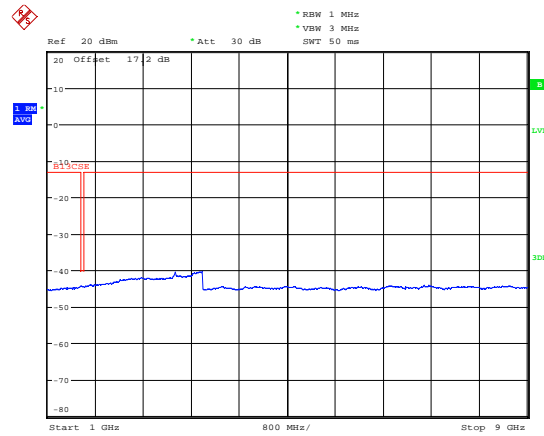

Date: 29.MAY.2020 21:27:25

NB-IoT Band 13 CH-High 30MHz~1GHz

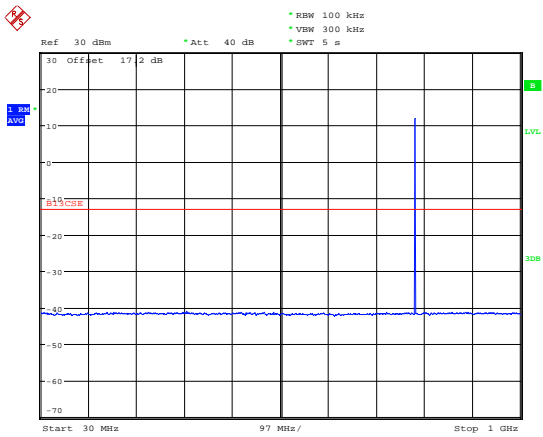

Date: 29.MAY.2020 21:25:33

NB-IoT Band 13 CH-High 1GHz ~9GHz

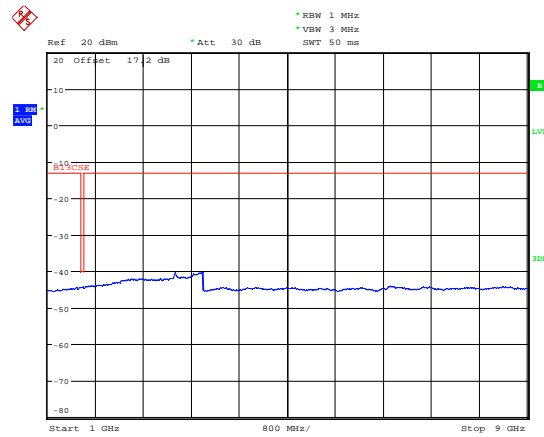

Date: 29.MAY.2020 21:28:02



NB-IoT Band 66 CH-Low 30MHz~1GHz

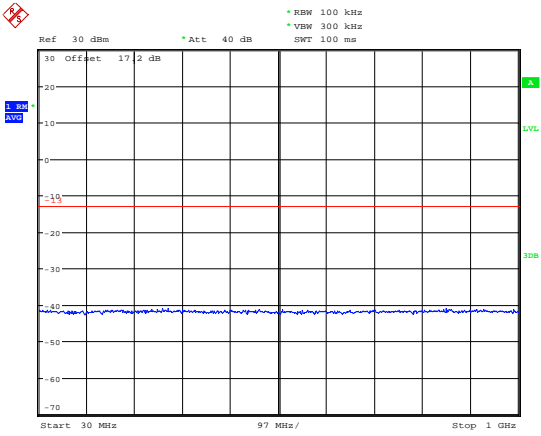

Date: 29.MAY.2020 21:37:05

NB-IoT Band 66 CH-Low 1GHz ~20GHz

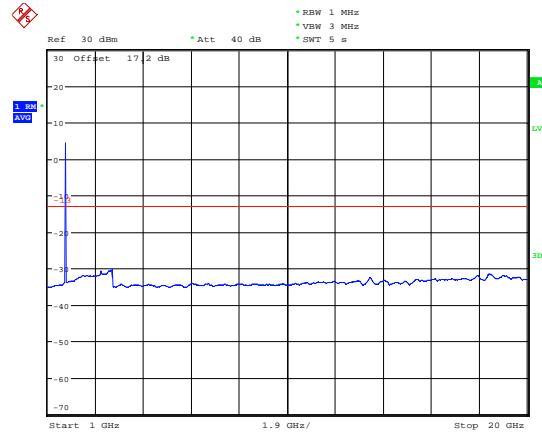

Date: 29.MAY.2020 21:38:08

NB-IoT Band 66 CH-Middle 30MHz~1GHz

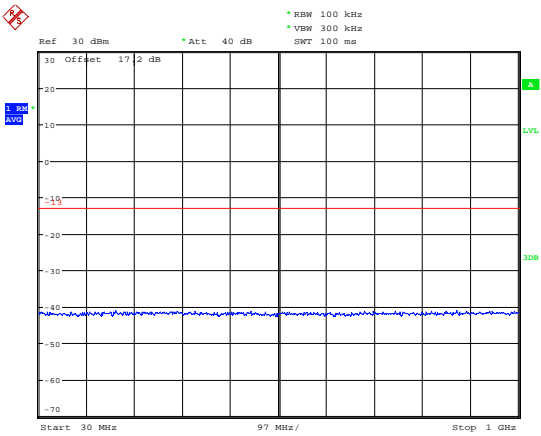

Date: 29.MAY.2020 21:37:25

NB-IoT Band 66 CH-Middle 1GHz ~20GHz

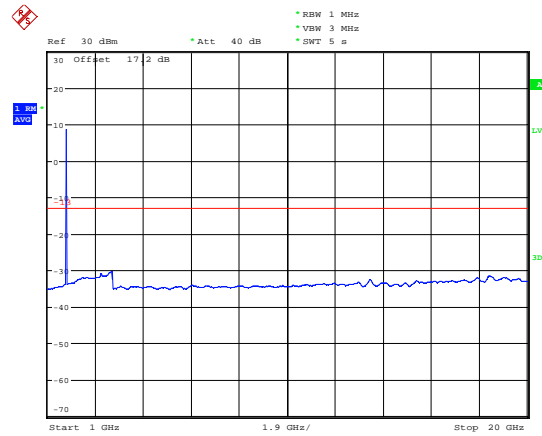

Date: 29.MAY.2020 21:39:06

NB-IoT Band 66 CH-High 30MHz~1GHz

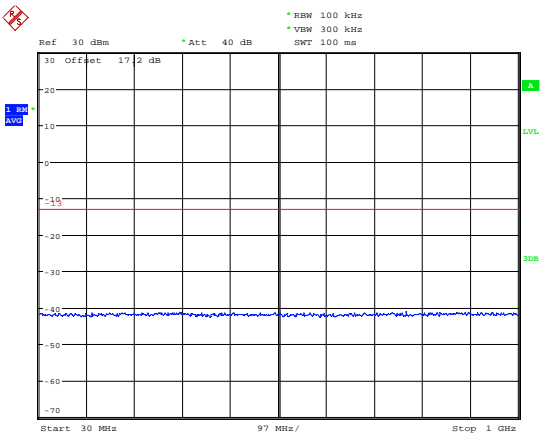

Date: 29.MAY.2020 21:37:34

NB-IoT Band 66 CH-High 1GHz ~20GHz

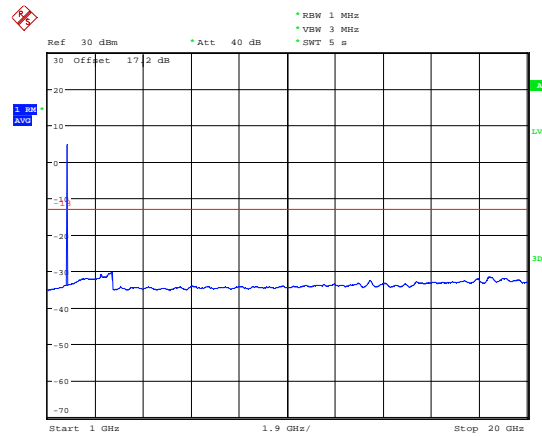

Date: 29.MAY.2020 21:41:14



NB-IoT Band 71 CH-Low 30MHz~1GHz

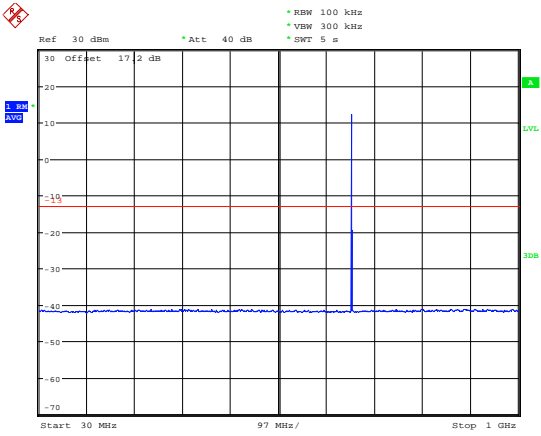

Date: 29.MAY.2020 21:42:51

NB-IoT Band 71 CH-Low 1GHz ~9GHz

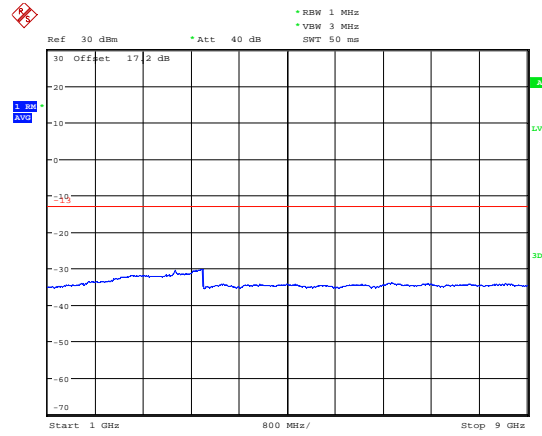

Date: 29.MAY.2020 21:46:54

NB-IoT Band 71 CH-Middle 30MHz~1GHz

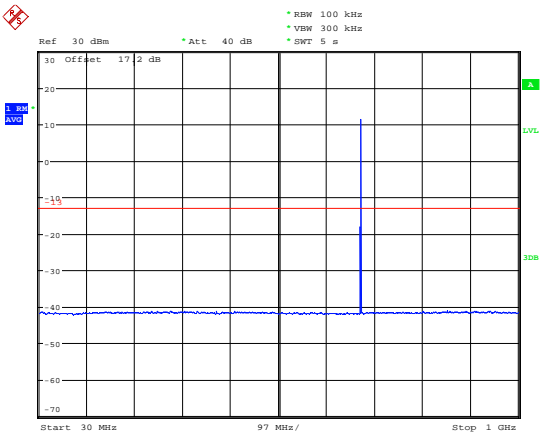

Date: 29.MAY.2020 21:45:30

NB-IoT Band 71 CH-Middle 1GHz ~9GHz

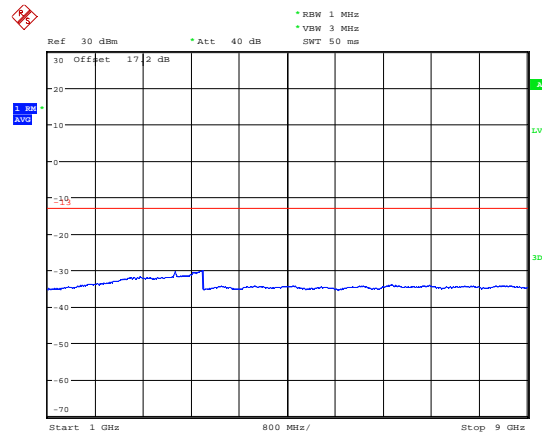

Date: 29.MAY.2020 21:47:06

NB-IoT Band 71 CH-High 30MHz~1GHz

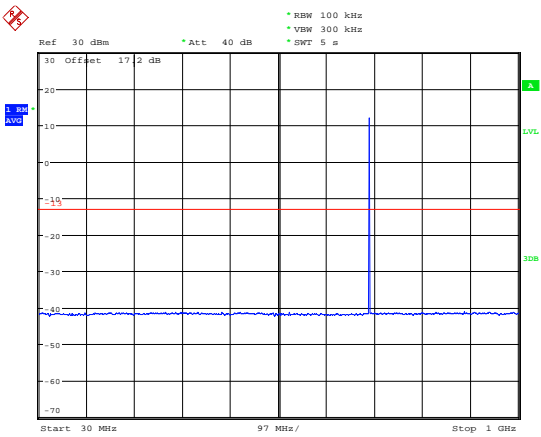

Date: 29.MAY.2020 21:46:30

NB-IoT Band 71 CH-High 1GHz ~9GHz

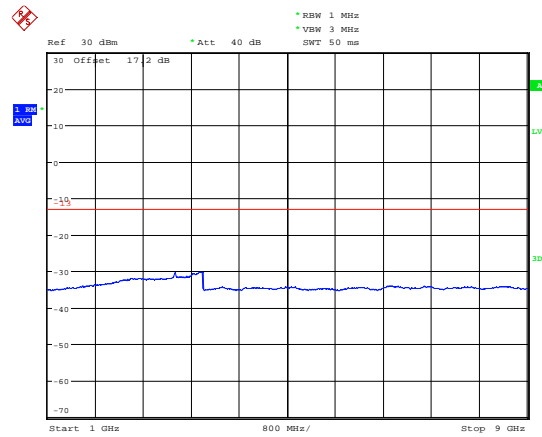

Date: 29.MAY.2020 21:47:20



NB-IoT Band 85 CH-Low 30MHz~1GHz

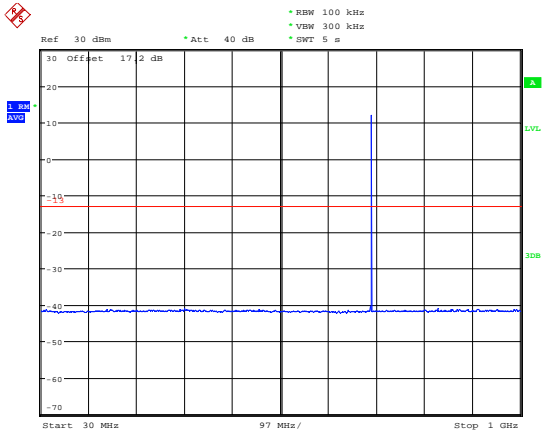

Date: 29.MAY.2020 21:49:42

NB-IoT Band 85 CH-Low 1GHz ~9GHz

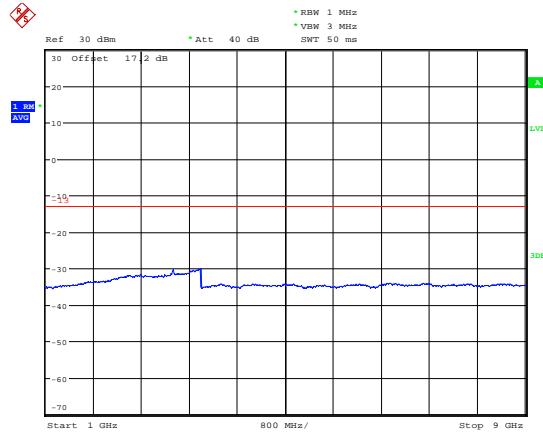

Date: 29.MAY.2020 21:49:10

NB-IoT Band 85 CH-Middle 30MHz~1GHz

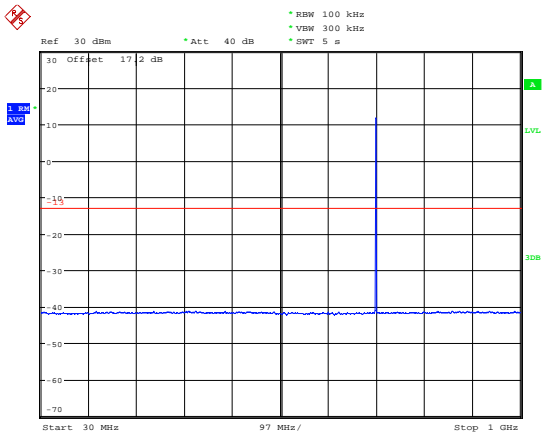

Date: 29.MAY.2020 21:50:36

NB-IoT Band 85 CH-Middle 1GHz ~9GHz

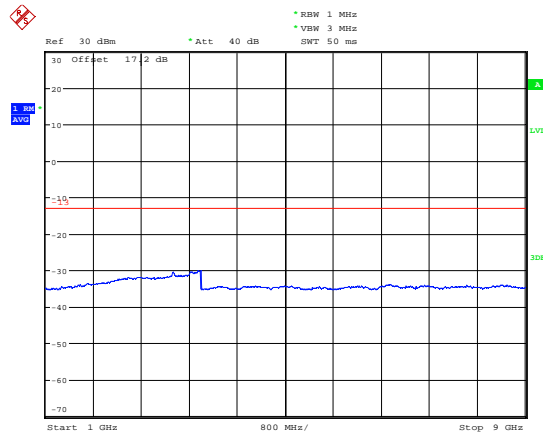

Date: 29.MAY.2020 21:48:59

NB-IoT Band 85 CH-High 30MHz~1GHz

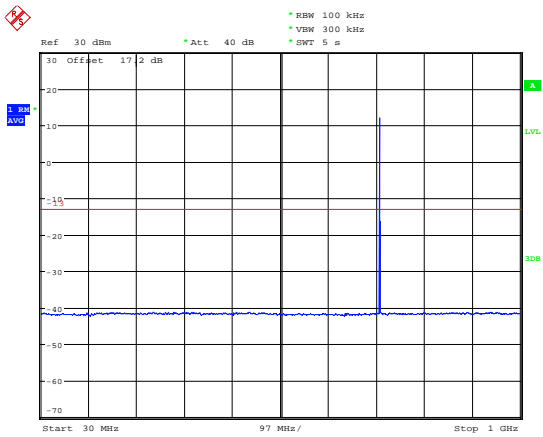

Date: 29.MAY.2020 21:51:20

NB-IoT Band 85 CH-High 1GHz ~9GHz

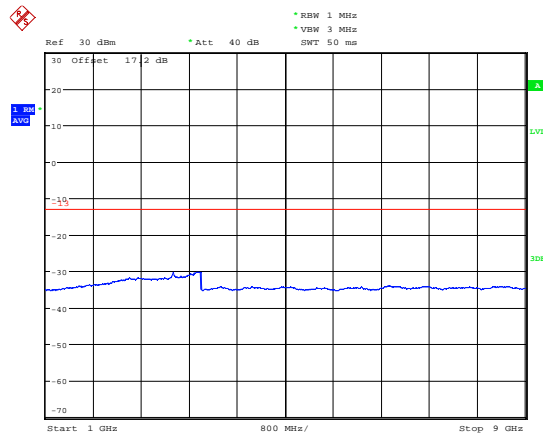

Date: 29.MAY.2020 21:48:49

5.7 Radiates Spurious Emission

Ambient condition

Temperature	Relative humidity	Pressure
23°C ~25°C	45%~50%	101.5kPa

Method of Measurement

- The testing follows FCC KDB 971168 D01 v03r01 Section 5.8 and ANSI C63.26 (2015).
- Below 1GHz: The EUT is placed on a turntable 0.8 meters above the ground in the chamber, 3 meter away from the antenna. The maximal emission value is acquired by adjusting the antenna height, polarisation and turntable azimuth. Normally, the height range of antenna is 1 m to 4 m, the azimuth range of turntable is 0° to 360°, and the receive antenna has two polarizations Vertical (V) and Horizontal (H). Above 1GHz: (Note: the FCC's permission to use 1.5m as an alternative per TCBC Conf call of Dec. 2, 2014.) The EUT is placed on a turntable 1.5 meters above the ground in the chamber, 3 meter away from the antenna. The maximal emission value is acquired by adjusting the antenna height, polarisation and turntable azimuth. Normally, the height range of antenna is 1 m to 4 m, the azimuth range of turntable is 0° to 360°, and the receive antenna has two polarizations Vertical (V) and Horizontal (H).
- A loop antenna, A log-periodic antenna or horn antenna shall be substituted in place of the EUT. The log-periodic antenna will be driven by a signal generator and the level will be adjusted till the same power value on the spectrum analyzer or receiver. The level of the spurious emissions can be calculated through the level of the signal generator, cable loss, the gain of the substitution antenna and the reading of the spectrum analyzer or receiver.
- The EUT is then put into continuously transmitting mode at its maximum power level during the test. Set Test Receiver or Spectrum RBW=200Hz,VBW=600Hz for 9kHz-150kHz , RBW=10kHz, VBW=30kHz 150kHz-30MHz ,RBW=100kHz,VBW=300kHz for 30MHz to 1GHz and RBW=1MHz, VBW=3MHz for above 1GHz And the maximum value of the receiver should be recorded as (Pr).
- The EUT shall be replaced by a substitution antenna. In the chamber, an substitution antenna for the frequency band of interest is placed at the reference point of the chamber. An RF Signal source for the frequency band of interest is connected to the substitution antenna with a cable that has been constructed to not interfere with the radiation pattern of the antenna. A power (PMea) is applied to the input of the substitution antenna, and adjust the level of the signal generator output until the value of the receiver reach the previously recorded (Pr). The power of signal source (PMea) is recorded. The test should be performed by rotating the test item and adjusting the receiving antenna polarization.
- A amplifier should be connected to the Signal Source output port. And the cable should be connect between the Amplifier and the Substitution Antenna. The cable loss (Pcl) ,the Substitution Antenna Gain (Ga) and the Amplifier Gain (PAG) should be recorded after test.
- The measurement results are obtained as described below:
 $Power(EIRP)=PMea- PAG - Pcl + Ga$
 The measurement results are amend as described below:
 $Power(EIRP)=PMea- Pcl + Ga$
- This value is EIRP since the measurement is calibrated using an antenna of known gain (2.15 dBi) and known input power. ERP can be calculated from EIRP by subtracting the gain of the dipole, ERP

= EIRP-2.15dBi.

The modulation mode and RB allocation refer to section 5.1, using the maximum output power configuration.

Test setup

9KHz ~ 30MHz

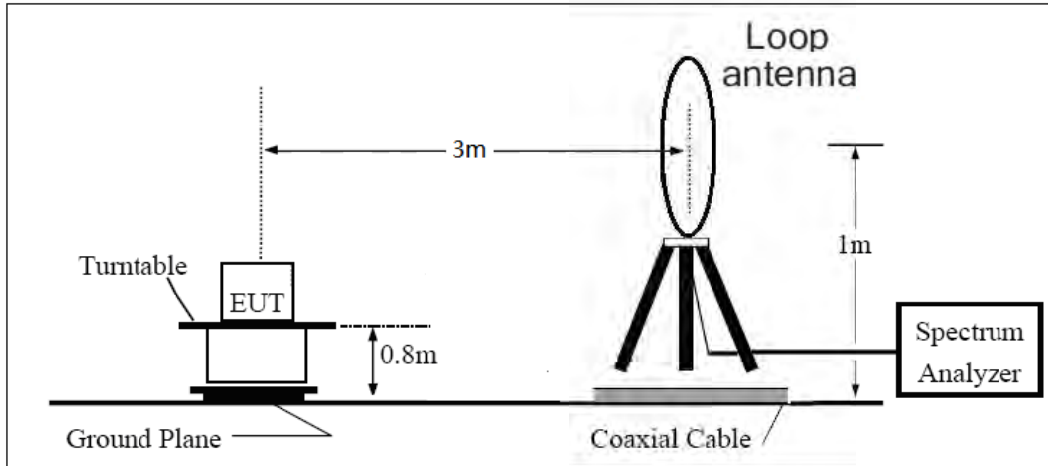

30MHz ~ 1GHz

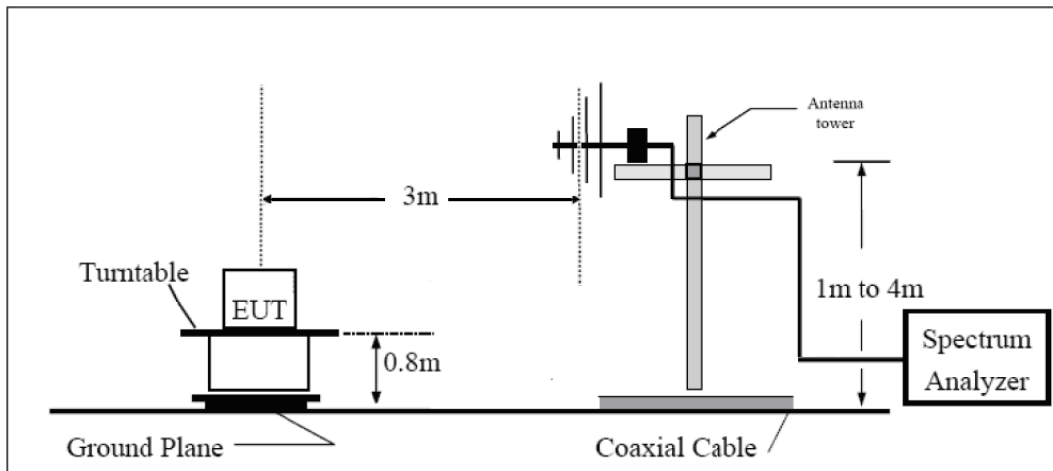

Above 1GHz

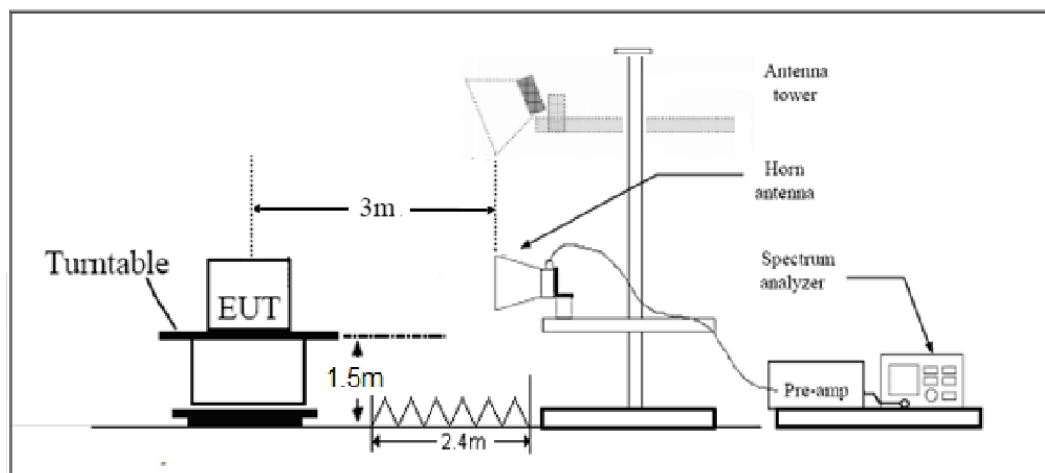

Note: Area side:2.4mX3.6m

**Limits**

Rule Part 27.53(h) specifies that “for operations in the 1695-1710 MHz, 1710-1755 MHz, 1755-1780 MHz, 1915-1920 MHz, 1995-2000 MHz, 2000-2020 MHz, 2110-2155 MHz, 2155-2180 MHz, and 2180-2200 bands, the power of any emission outside a licensee's frequency block shall be attenuated below the transmitter power (P) in watts by at least $43 + 10 \log_{10}(P)$ dB.”

Rule Part 27.53 (g) For operations in the 600 MHz band and the 698-746 MHz band, the power of any emission outside a licensee's frequency band(s) of operation shall be attenuated below the transmitter power (P) within the licensed band(s) of operation, measured in watts, by at least $43 + 10 \log(P)$ dB. Compliance with this provision is based on the use of measurement instrumentation employing a resolution bandwidth of 100 kilohertz or greater. However, in the 100 kilohertz bands immediately outside and adjacent to a licensee's frequency block, a resolution bandwidth of at least 30 kHz may be employed.

Rule Part 27.53(f) For operations in the 746-758 MHz, 775-788 MHz, and 805-806 MHz bands, emissions in the band 1559-1610 MHz shall be limited to -70 dBW/MHz equivalent isotropically radiated power (EIRP) for wideband signals, and -80 dBW EIRP for discrete emissions of less than 700 Hz bandwidth. For the purpose of equipment authorization, a transmitter shall be tested with an antenna that is representative of the type that will be used with the equipment in normal operation.

Part 27.53 (c) For operations in the 746-758 MHz band and the 776-788 MHz band, the power of any emission outside the licensee's frequency band(s) of operation shall be attenuated below the transmitter power (P) within the licensed band(s) of operation, measured in watts, in accordance with the following:

- (1) On any frequency outside the 746-758 MHz band, the power of any emission shall be attenuated outside the band below the transmitter power (P) by at least $43 + 10 \log(P)$ dB;
- (2) On any frequency outside the 776-788 MHz band, the power of any emission shall be attenuated outside the band below the transmitter power (P) by at least $43 + 10 \log(P)$ dB;
- (3) On all frequencies between 763-775 MHz and 793-805 MHz, by a factor not less than $76 + 10 \log(P)$ dB in a 6.25 kHz band segment, for base and fixed stations;
- (4) On all frequencies between 763-775 MHz and 793-805 MHz, by a factor not less than $65 + 10 \log(P)$ dB in a 6.25 kHz band segment, for mobile and portable stations;
- (5) Compliance with the provisions of paragraphs (c)(1) and (c)(2) of this section is based on the use of measurement instrumentation employing a resolution bandwidth of 100 kHz or greater. However, in the 100 kHz bands immediately outside and adjacent to the frequency block, a resolution bandwidth of at least 30 kHz may be employed;

Part 27.53 (h)/(g) Limit		-13 dBm
Part 27.53(f) Limit	Limit out of the band 1559-1610 MHz	-13 dBm
	Limit in the band 1559-1610 MHz	-40 dBm

Measurement Uncertainty



The assessed measurement uncertainty to ensure 95% confidence level for the normal distribution is with the coverage factor $k = \pm 1.96$, $U = \pm 3.55$ dB.

**Test Result**

Sweep the whole frequency band through the range from 9kHz to the 10th harmonic of the carrier, the emissions below the noise floor will not be recorded in the report.

NB-IoT Band 4 15kHz QPSK CH-Low

Harmonic	Frequency (MHz)	SG (dBm)	Cable Loss (dB)	Gain (dBi)	Antenna Polarization	EIRP Level (dBm)	Limit (dBm)	Margin (dB)	Azimuth (deg)
2	3420.0	-44.07	2.6	10.15	Horizontal	-36.52	-13.00	23.52	45
3	5130.0	-58.45	2.4	11.35	Horizontal	-49.50	-13.00	36.50	135
4	6840.0	-58.97	4.5	10.85	Horizontal	-52.62	-13.00	39.62	90
5	8550.0	-55.03	5.1	11.35	Horizontal	-48.78	-13.00	35.78	135
6	10260.0	-51.57	5.3	11.95	Horizontal	-44.92	-13.00	31.92	315
7	11970.0	-52.21	5.5	13.55	Horizontal	-44.16	-13.00	31.16	90
8	13680.0	-49.76	6.3	13.75	Horizontal	-42.31	-13.00	29.31	45
9	15390.0	-49.07	6.7	13.85	Horizontal	-41.92	-13.00	28.92	315
10	17100.0	-48.59	6.8	14.25	Horizontal	-41.14	-13.00	28.14	225

Note: 1.The other Spurious RF Radiated emissions level is no more than noise floor.

2. The worst emission was found in the antenna is Horizontal position.

NB-IoT Band 4 15kHz QPSK CH-Middle

Harmonic	Frequency (MHz)	SG (dBm)	Cable Loss (dB)	Gain (dBi)	Antenna Polarization	EIRP Level (dBm)	Limit (dBm)	Margin (dB)	Azimuth (deg)
2	3465.0	-45.40	2.6	10.75	Horizontal	-37.25	-13.00	24.25	90
3	5197.5	-56.72	2.4	11.05	Horizontal	-48.07	-13.00	35.07	0
4	6930.0	-60.28	4.5	11.15	Horizontal	-53.63	-13.00	40.63	45
5	8662.5	-55.48	5.1	11.35	Horizontal	-49.23	-13.00	36.23	90
6	10395.0	-50.83	5.3	11.95	Horizontal	-44.18	-13.00	31.18	225
7	12127.5	-51.36	5.5	13.55	Horizontal	-43.31	-13.00	30.31	45
8	13860.0	-49.44	6.3	13.75	Horizontal	-41.99	-13.00	28.99	90
9	15592.5	-49.05	6.7	13.85	Horizontal	-41.90	-13.00	28.90	270
10	17325.0	-47.67	6.8	14.25	Horizontal	-40.22	-13.00	27.22	135

Note: 1.The other Spurious RF Radiated emissions level is no more than noise floor.

2. The worst emission was found in the antenna is Horizontal position.



NB-IoT Band 4 15kHz QPSK CH-High

Harmonic	Frequency (MHz)	SG (dBm)	Cable Loss (dB)	Gain (dBi)	Antenna Polarization	EIRP Level (dBm)	Limit (dBm)	Margin (dB)	Azimuth (deg)
2	3509.8	-47.64	2.6	10.15	Horizontal	-40.09	-13.00	27.09	225
3	5264.7	-55.88	2.4	11.05	Horizontal	-47.23	-13.00	34.23	45
4	7019.6	-56.82	4.5	11.15	Horizontal	-50.17	-13.00	37.17	135
5	8774.5	-54.58	5.1	11.35	Horizontal	-48.33	-13.00	35.33	225
6	10529.4	-52.22	5.3	11.95	Horizontal	-45.57	-13.00	32.57	90
7	12284.3	-52.61	5.5	13.55	Horizontal	-44.56	-13.00	31.56	45
8	14039.2	-50.83	6.3	13.75	Horizontal	-43.38	-13.00	30.38	0
9	15794.1	-49.09	6.7	13.85	Horizontal	-41.94	-13.00	28.94	0
10	17549.0	-47.73	6.8	14.25	Horizontal	-40.28	-13.00	27.28	270

Note: 1.The other Spurious RF Radiated emissions level is no more than noise floor.

2. The worst emission was found in the antenna is Horizontal position.

NB-IoT Band 12 15kHz QPSK CH-Low

Harmonic	Frequency (MHz)	SG (dBm)	Cable Loss (dB)	Gain (dBi)	Antenna Polarization	ERP Level (dBm)	Limit (dBm)	Margin (dB)	Azimuth (deg)
2	1398.2	-49.80	2.00	10.15	Horizontal	-43.80	-13.00	30.80	225
3	2097.3	-52.40	2.50	11.35	Horizontal	-45.70	-13.00	32.70	90
4	2796.4	-59.40	4.20	10.85	Horizontal	-54.90	-13.00	41.90	0
5	3495.5	-56.80	5.20	11.35	Horizontal	-52.80	-13.00	39.80	45
6	4194.6	-55.90	5.50	11.95	Horizontal	-51.60	-13.00	38.60	90
7	4893.7	-55.20	5.70	13.55	Horizontal	-49.50	-13.00	36.50	315
8	5592.8	-55.30	6.30	13.75	Horizontal	-50.00	-13.00	37.00	135
9	6291.9	-56.00	6.80	13.85	Horizontal	-51.10	-13.00	38.10	225
10	6991.0	-58.40	6.90	14.25	Horizontal	-53.20	-13.00	40.20	90

Note: 1.The other Spurious RF Radiated emissions level is no more than noise floor.

2. The worst emission was found in the antenna is Horizontal position.



NB-IoT Band 12 15kHz QPSK CH-Middle

Harmonic	Frequency (MHz)	SG (dBm)	Cable Loss (dB)	Gain (dBi)	Antenna Polarization	ERP Level (dBm)	Limit (dBm)	Margin (dB)	Azimuth (deg)
2	1415.0	-48.70	2.00	10.75	Horizontal	-42.10	-13.00	29.10	90
3	2122.5	-56.79	2.51	11.05	Horizontal	-50.40	-13.00	37.40	225
4	2830.0	-58.40	4.20	11.15	Horizontal	-53.60	-13.00	40.60	90
5	3525.5	-56.00	5.20	11.15	Horizontal	-52.20	-13.00	39.20	225
6	4230.6	-54.60	5.50	11.95	Horizontal	-50.30	-13.00	37.30	135
7	4935.7	-55.60	5.70	13.55	Horizontal	-49.90	-13.00	36.90	270
8	5640.8	-55.20	6.30	13.75	Horizontal	-49.90	-13.00	36.90	315
9	6345.9	-54.50	6.80	13.85	Horizontal	-49.60	-13.00	36.60	45
10	7051.0	-56.17	6.90	14.25	Horizontal	-50.97	-13.00	37.97	180

Note: 1. The other Spurious RF Radiated emissions level is no more than noise floor.
2. The worst emission was found in the antenna is Horizontal position.

NB-IoT Band 12 15kHz QPSK CH-High

Harmonic	Frequency (MHz)	SG (dBm)	Cable Loss (dB)	Gain (dBi)	Antenna Polarization	ERP Level (dBm)	Limit (dBm)	Margin (dB)	Azimuth (deg)
2	1431.8	-47.20	2.00	10.15	Horizontal	-41.20	-13.00	28.20	45
3	2147.7	-59.09	2.51	11.05	Horizontal	-52.70	-13.00	39.70	90
4	2863.6	-60.50	4.20	11.15	Horizontal	-55.70	-13.00	42.70	225
5	3579.5	-56.60	5.20	11.15	Horizontal	-52.80	-13.00	39.80	0
6	4295.4	-54.10	5.50	11.95	Horizontal	-49.80	-13.00	36.80	0
7	5011.3	-55.80	5.70	13.55	Horizontal	-50.10	-13.00	37.10	90
8	5727.2	-55.40	6.30	13.75	Horizontal	-50.10	-13.00	37.10	45
9	6443.1	-55.40	6.80	13.85	Horizontal	-50.50	-13.00	37.50	135
10	7159.0	-56.60	6.90	14.25	Horizontal	-51.40	-13.00	38.40	225

Note: 1. The other Spurious RF Radiated emissions level is no more than noise floor.
2. The worst emission was found in the antenna is Horizontal position.



NB-IoT Band 13 15kHz QPSK CH-Low

Harmonic	Frequency (MHz)	SG (dBm)	Cable Loss (dB)	Gain (dBi)	Antenna Polarization	ERP Level (dBm)	Limit (dBm)	Margin (dB)	Azimuth (deg)
2	1554.2	-52.20	2.00	10.15	Horizontal	-46.20	-13.00	33.20	225
3	2331.3	-53.30	2.50	11.35	Horizontal	-46.60	-13.00	33.60	90
4	3108.4	-58.30	4.20	10.85	Horizontal	-53.80	-13.00	40.80	0
5	3885.5	-54.70	5.20	11.35	Horizontal	-50.70	-13.00	37.70	45
6	4662.6	-55.27	5.50	11.95	Horizontal	-50.97	-13.00	37.97	225
7	5439.7	-55.20	5.70	13.55	Horizontal	-49.50	-13.00	36.50	90
8	6216.8	-56.20	6.30	13.75	Horizontal	-50.90	-13.00	37.90	0
9	6993.9	-56.40	6.80	13.85	Horizontal	-51.50	-13.00	38.50	45
10	7771.0	-54.40	6.90	14.25	Horizontal	-49.20	-13.00	36.20	315

Note: 1. The other Spurious RF Radiated emissions level is no more than noise floor.

2. The worst emission was found in the antenna is Horizontal position.

NB-IoT Band 13 15kHz QPSK CH-Middle

Harmonic	Frequency (MHz)	SG (dBm)	Cable Loss (dB)	Gain (dBi)	Antenna Polarization	EIRP Level (dBm)	Limit (dBm)	Margin (dB)	Azimuth (deg)
2	1564.0	-55.85	2.00	10.75	Horizontal	-47.10	-40.00	7.10	90
Harmonic	Frequency (MHz)	SG (dBm)	Cable Loss (dB)	Gain (dBi)	Antenna Polarization	ERP Level (dBm)	Limit (dBm)	Margin (dB)	Azimuth (deg)
3	2346.0	-53.19	2.51	11.05	Horizontal	-46.80	-13.00	33.80	0
4	3128.0	-56.70	4.20	11.15	Horizontal	-51.90	-13.00	38.90	0
5	3910.0	-55.50	5.20	11.15	Horizontal	-51.70	-13.00	38.70	270
6	4692.0	-55.00	5.50	11.95	Horizontal	-50.70	-13.00	37.70	225
7	5474.0	-55.40	5.70	13.55	Horizontal	-49.70	-13.00	36.70	135
8	6256.0	-56.29	6.30	13.75	Horizontal	-50.99	-13.00	37.99	90
9	7038.0	-55.10	6.80	13.85	Horizontal	-50.20	-13.00	37.20	45
10	7820.0	-54.60	6.90	14.25	Horizontal	-49.40	-13.00	36.40	270

Note: 1. The other Spurious RF Radiated emissions level is no more than noise floor.

2. The worst emission was found in the antenna is Horizontal position.



NB-IoT Band 13 15kHz QPSK CH-High

Harmonic	Frequency (MHz)	SG (dBm)	Cable Loss (dB)	Gain (dBi)	Antenna Polarization	EIRP Level (dBm)	Limit (dBm)	Margin (dB)	Azimuth (deg)
2	1573.8	-55.45	2.00	10.15	Horizontal	-47.30	-40.00	7.30	225
Harmonic	Frequency (MHz)	SG (dBm)	Cable Loss (dB)	Gain (dBi)	Antenna Polarization	ERP Level (dBm)	Limit (dBm)	Margin (dB)	Azimuth (deg)
3	2360.7	-55.49	2.51	11.05	Horizontal	-49.10	-13.00	36.10	135
4	3147.6	-56.00	4.20	11.15	Horizontal	-51.20	-13.00	38.20	225
5	3934.5	-55.30	5.20	11.15	Horizontal	-51.50	-13.00	38.50	135
6	4721.4	-54.60	5.50	11.95	Horizontal	-50.30	-13.00	37.30	0
7	5508.3	-56.10	5.70	13.55	Horizontal	-50.40	-13.00	37.40	45
8	6295.2	-56.20	6.30	13.75	Horizontal	-50.90	-13.00	37.90	315
9	7082.1	-56.10	6.80	13.85	Horizontal	-51.20	-13.00	38.20	45
10	7869.0	-53.60	6.90	14.25	Horizontal	-48.40	-13.00	35.40	270

Note: 1. The other Spurious RF Radiated emissions level is no more than noise floor.
2. The worst emission was found in the antenna is Horizontal position.

NB-IoT Band 66 15kHz QPSK CH-Low

Harmonic	Frequency (MHz)	SG (dBm)	Cable Loss (dB)	Gain (dBi)	Antenna Polarization	EIRP Level (dBm)	Limit (dBm)	Margin (dB)	Azimuth (deg)
2	3420.2	-40.54	2.6	10.15	Horizontal	-32.99	-13.00	19.99	0
3	5130.3	-59.15	2.4	11.35	Horizontal	-50.20	-13.00	37.20	45
4	6840.4	-58.65	4.5	10.85	Horizontal	-52.30	-13.00	39.30	315
5	8550.5	-54.25	5.1	11.35	Horizontal	-48.00	-13.00	35.00	180
6	10260.6	-50.55	5.3	11.95	Horizontal	-43.90	-13.00	30.90	270
7	11970.7	-51.35	5.5	13.55	Horizontal	-43.30	-13.00	30.30	45
8	13680.8	-48.85	6.3	13.75	Horizontal	-41.40	-13.00	28.40	90
9	15390.9	-47.55	6.7	13.85	Horizontal	-40.40	-13.00	27.40	225
10	17101.0	-46.65	6.8	14.25	Horizontal	-39.20	-13.00	26.20	315

Note: 1. The other Spurious RF Radiated emissions level is no more than noise floor.
2. The worst emission was found in the antenna is Horizontal position.



NB-IoT Band 66 15kHz QPSK CH-Middle

Harmonic	Frequency (MHz)	SG (dBm)	Cable Loss (dB)	Gain (dBi)	Antenna Polarization	EIRP Level (dBm)	Limit (dBm)	Margin (dB)	Azimuth (deg)
2	3510.0	-44.65	2.6	10.75	Horizontal	-36.50	-13.00	23.50	180
3	5265.0	-54.95	2.4	11.05	Horizontal	-46.30	-13.00	33.30	135
4	7020.0	-56.95	4.5	11.15	Horizontal	-50.30	-13.00	37.30	0
5	8775.0	-54.75	5.1	11.35	Horizontal	-48.50	-13.00	35.50	90
6	10530.0	-51.63	5.3	11.95	Horizontal	-44.98	-13.00	31.98	45
7	12285.0	-51.42	5.5	13.55	Horizontal	-43.37	-13.00	30.37	315
8	14040.0	-49.44	6.3	13.75	Horizontal	-41.99	-13.00	28.99	45
9	15795.0	-48.25	6.7	13.85	Horizontal	-41.10	-13.00	28.10	225
10	17550.0	-47.95	6.8	14.25	Horizontal	-40.50	-13.00	27.50	90

Note: 1. The other Spurious RF Radiated emissions level is no more than noise floor.

2. The worst emission was found in the antenna is Horizontal position.

NB-IoT Band 66 15kHz QPSK CH-High

Harmonic	Frequency (MHz)	SG (dBm)	Cable Loss (dB)	Gain (dBi)	Antenna Polarization	EIRP Level (dBm)	Limit (dBm)	Margin (dB)	Azimuth (deg)
2	3559.8	-50.65	2.6	10.15	Horizontal	-43.10	-13.00	30.10	270
3	5339.7	-56.25	2.4	11.05	Horizontal	-47.60	-13.00	34.60	135
4	7119.6	-57.85	4.5	11.15	Horizontal	-51.20	-13.00	38.20	225
5	8899.5	-53.85	5.1	11.35	Horizontal	-47.60	-13.00	34.60	90
6	10679.4	-52.35	5.3	11.95	Horizontal	-45.70	-13.00	32.70	0
7	12459.3	-52.25	5.5	13.55	Horizontal	-44.20	-13.00	31.20	0
8	14239.2	-49.15	6.3	13.75	Horizontal	-41.70	-13.00	28.70	45
9	16019.1	-48.15	6.7	13.85	Horizontal	-41.00	-13.00	28.00	315
10	17799.0	-48.25	6.8	14.25	Horizontal	-40.80	-13.00	27.80	225

Note: 1. The other Spurious RF Radiated emissions level is no more than noise floor.

2. The worst emission was found in the antenna is Horizontal position.



NB-IoT Band 71 15kHz QPSK CH-Low

Harmonic	Frequency (MHz)	SG (dBm)	Cable Loss (dB)	Gain (dBi)	Antenna Polarization	ERP Level (dBm)	Limit (dBm)	Margin (dB)	Azimuth (deg)
2	1326.2	-52.60	2.6	10.15	Horizontal	-47.20	-13.00	34.20	45
3	1989.3	-53.20	2.4	11.35	Horizontal	-46.40	-13.00	33.40	225
4	2652.4	-58.50	4.5	10.85	Horizontal	-54.30	-13.00	41.30	90
5	3315.5	-57.90	5.1	11.35	Horizontal	-53.80	-13.00	40.80	270
6	3978.6	-55.40	5.3	11.95	Horizontal	-50.90	-13.00	37.90	315
7	4641.7	-56.70	5.5	13.55	Horizontal	-50.80	-13.00	37.80	90
8	5304.8	-55.70	6.3	13.75	Horizontal	-50.40	-13.00	37.40	225
9	5967.9	-55.80	6.7	13.85	Horizontal	-50.80	-13.00	37.80	45
10	6631.0	-57.27	6.8	14.25	Horizontal	-51.97	-13.00	38.97	135

Note: 1.The other Spurious RF Radiated emissions level is no more than noise floor.

2. The worst emission was found in the antenna is Horizontal position.

NB-IoT Band 71 15kHz QPSK CH-Middle

Harmonic	Frequency (MHz)	SG (dBm)	Cable Loss (dB)	Gain (dBi)	Antenna Polarization	ERP Level (dBm)	Limit (dBm)	Margin (dB)	Azimuth (deg)
2	1361.0	-52.40	2.6	10.75	Horizontal	-46.40	-13.00	33.40	0
3	2041.5	-52.10	2.4	11.05	Horizontal	-45.60	-13.00	32.60	180
4	2722.0	-58.40	4.5	11.15	Horizontal	-53.90	-13.00	40.90	315
5	3402.5	-57.30	5.1	11.35	Horizontal	-53.20	-13.00	40.20	45
6	4083.0	-56.10	5.3	11.95	Horizontal	-51.60	-13.00	38.60	135
7	4763.5	-56.30	5.5	13.55	Horizontal	-50.40	-13.00	37.40	180
8	5444.0	-55.40	6.3	13.75	Horizontal	-50.10	-13.00	37.10	90
9	6124.5	-55.90	6.7	13.85	Horizontal	-50.90	-13.00	37.90	45
10	6805.0	-57.80	6.8	14.25	Horizontal	-52.50	-13.00	39.50	225

Note: 1.The other Spurious RF Radiated emissions level is no more than noise floor.

2. The worst emission was found in the antenna is Horizontal position.



NB-IoT Band 71 15kHz QPSK CH-High

Harmonic	Frequency (MHz)	SG (dBm)	Cable Loss (dB)	Gain (dBi)	Antenna Polarization	ERP Level (dBm)	Limit (dBm)	Margin (dB)	Azimuth (deg)
2	1395.8	-47.20	2.6	10.15	Horizontal	-41.80	-13.00	28.80	45
3	2093.7	-52.40	2.4	11.05	Horizontal	-45.90	-13.00	32.90	225
4	2791.6	-59.00	4.5	11.15	Horizontal	-54.50	-13.00	41.50	90
5	3489.5	-57.50	5.1	11.35	Horizontal	-53.40	-13.00	40.40	225
6	4187.4	-56.30	5.3	11.95	Horizontal	-51.80	-13.00	38.80	0
7	4885.3	-56.10	5.5	13.55	Horizontal	-50.20	-13.00	37.20	90
8	5583.2	-55.10	6.3	13.75	Horizontal	-49.80	-13.00	36.80	45
9	6281.1	-55.70	6.7	13.85	Horizontal	-50.70	-13.00	37.70	135
10	6979.0	-58.00	6.8	14.25	Horizontal	-52.70	-13.00	39.70	270

Note: 1. The other Spurious RF Radiated emissions level is no more than noise floor.

2. The worst emission was found in the antenna is Horizontal position.

NB-IoT Band 85 15kHz QPSK CH-Low

Harmonic	Frequency (MHz)	SG (dBm)	Cable Loss (dB)	Gain (dBi)	Antenna Polarization	ERP Level (dBm)	Limit (dBm)	Margin (dB)	Azimuth (deg)
2	1396.2	-49.10	2.6	10.15	Horizontal	-43.70	-13.00	30.70	135
3	2094.3	-53.00	2.4	11.35	Horizontal	-46.20	-13.00	33.20	225
4	2792.4	-58.30	4.5	10.85	Horizontal	-54.10	-13.00	41.10	315
5	3490.5	-55.80	5.1	11.35	Horizontal	-51.70	-13.00	38.70	180
6	4188.6	-56.60	5.3	11.95	Horizontal	-52.10	-13.00	39.10	270
7	4886.7	-56.20	5.5	13.55	Horizontal	-50.30	-13.00	37.30	90
8	5584.8	-55.86	6.3	13.75	Horizontal	-50.56	-13.00	37.56	0
9	6282.9	-56.30	6.7	13.85	Horizontal	-51.30	-13.00	38.30	45
10	6981.0	-58.25	6.8	14.25	Horizontal	-52.95	-13.00	39.95	135

Note: 1. The other Spurious RF Radiated emissions level is no more than noise floor.

2. The worst emission was found in the antenna is Horizontal position.



NB-IoT Band 85 15kHz QPSK CH-Middle

Harmonic	Frequency (MHz)	SG (dBm)	Cable Loss (dB)	Gain (dBi)	Antenna Polarization	ERP Level (dBm)	Limit (dBm)	Margin (dB)	Azimuth (deg)
2	1414.0	-48.20	2.6	10.75	Horizontal	-42.20	-13.00	29.20	135
3	2121.0	-55.90	2.4	11.05	Horizontal	-49.40	-13.00	36.40	225
4	2828.0	-60.00	4.5	11.15	Horizontal	-55.50	-13.00	42.50	90
5	3535.0	-57.40	5.1	11.35	Horizontal	-53.30	-13.00	40.30	0
6	4242.0	-54.40	5.3	11.95	Horizontal	-49.90	-13.00	36.90	90
7	4949.0	-55.30	5.5	13.55	Horizontal	-49.40	-13.00	36.40	45
8	5656.0	-55.90	6.3	13.75	Horizontal	-50.60	-13.00	37.60	135
9	6363.0	-56.60	6.7	13.85	Horizontal	-51.60	-13.00	38.60	180
10	7070.0	-55.50	6.8	14.25	Horizontal	-50.20	-13.00	37.20	315

Note: 1. The other Spurious RF Radiated emissions level is no more than noise floor.

2. The worst emission was found in the antenna is Horizontal position.

NB-IoT Band 85 15kHz QPSK CH-High

Harmonic	Frequency (MHz)	SG (dBm)	Cable Loss (dB)	Gain (dBi)	Antenna Polarization	ERP Level (dBm)	Limit (dBm)	Margin (dB)	Azimuth (deg)
2	1431.8	-47.10	2.6	10.15	Horizontal	-41.70	-13.00	28.70	135
3	2147.7	-59.60	2.4	11.05	Horizontal	-53.10	-13.00	40.10	45
4	2863.6	-60.20	4.5	11.15	Horizontal	-55.70	-13.00	42.70	90
5	3579.5	-57.50	5.1	11.35	Horizontal	-53.40	-13.00	40.40	0
6	4295.4	-53.20	5.3	11.95	Horizontal	-48.70	-13.00	35.70	90
7	5011.3	-56.30	5.5	13.55	Horizontal	-50.40	-13.00	37.40	45
8	5727.2	-55.80	6.3	13.75	Horizontal	-50.50	-13.00	37.50	315
9	6443.1	-56.96	6.7	13.85	Horizontal	-51.96	-13.00	38.96	45
10	7159.0	-56.90	6.8	14.25	Horizontal	-51.60	-13.00	38.60	90

Note: 1. The other Spurious RF Radiated emissions level is no more than noise floor.

2. The worst emission was found in the antenna is Horizontal position.



6 Main Test Instruments

Name	Manufacturer	Type	Serial Number	Calibration Date	Expiration Date
Base Station Simulator	R&S	CMW500	113824	2020-05-18	2021-05-17
Power Splitter	Hua Xiang	SHX-GF2-2-13	10120101	/	/
Spectrum Analyzer	Key sight	N9010A	MY50210259	2020-05-18	2021-05-17
Signal Analyzer	R&S	FSV30	100815	2019-12-15	2020-12-14
Loop Antenna	SCHWARZBECK	FMZB1519	1519-047	2017-09-26	2020-09-25
Trilog Antenna	SCHWARZBECK	VUBL 9163	9163-201	2017-11-18	2020-11-17
Horn Antenna	R&S	HF907	102723	2018-08-11	2021-08-10
Horn Antenna	ETS-Lindgren	3160-09	00102643	2018-06-20	2021-06-19
Signal generator	R&S	SMB 100A	102594	2020-05-18	2021-05-17
Climatic Chamber	ESPEC	SU-242	93000506	2017-12-17	2020-12-16
Preamplifier	R&S	SCU18	102327	2020-05-18	2021-05-17
MOB COMMS DC SUPPLY	Keysight	66319D	MY43004105	2020-05-18	2021-05-17
RF Cable	Agilent	SMA 15cm	0001	2019-12-13	2020-06-12
RF Cable	Agilent	SMA 15cm	0001	2020-06-12	2020-12-11
Software	R&S	EMC32	9.26.0	/	/

*****END OF REPORT *****



ANNEX A: The EUT Appearance

The EUT Appearance are submitted separately.



ANNEX B: Test Setup Photos

The Test Setup Photos are submitted separately.



ANNEX C: Verify data

The Verify data are submitted separately.



ANNEX D: Product Change Description

The Product Change Description are submitted separately.