

### 5.4 Peak-to-Average Power Ratio (PAPR)

#### Ambient condition

Temperature	Relative humidity	Pressure
23°C ~25°C	45%~50%	101.5kPa

#### Methods of Measurement

Measure the total peak power and record as PPK. And measure the total average power and record as PAvg. Both the peak and average power levels must be expressed in the same logarithmic units (e.g., dBm). Determine the PAPR from:

$$PAPR (dB) = PPK (dBm) - PAvg (dBm).$$

#### Test Setup

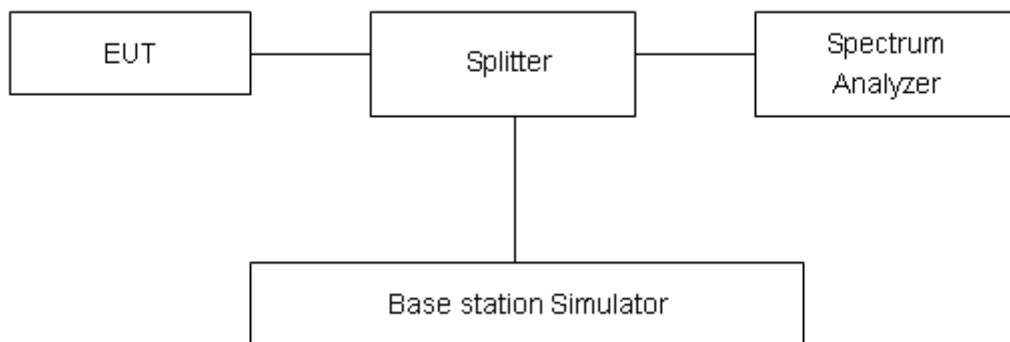

#### Limits

Rule Part 27.50(d)(5) Equipment employed must be authorized in accordance with the provisions of 24.51. Power measurements for transmissions by stations authorized under this section may be made either in accordance with a Commission-approved average power technique or in compliance with paragraph (d)(6) of this section. In measuring transmissions in this band using an average power technique, the peak-to-average ratio (PAR) of the transmission may not exceed 13 dB.

#### Measurement Uncertainty

The assessed measurement uncertainty to ensure 95% confidence level for the normal distribution is with the coverage factor  $k = 2$ ,  $U = 0.4$  dB.



## Test Results

Mode	Modulation	Sub-carrier spacing (KHz)	Channel/ Frequency(MHz)	Peak-to-Average Power Ratio (PAPR)			Limit (dB)	Conclusion
				Peak(dBm)	Avg(dBm)	PAPR(dB)		
Band 4 Standalone	BPSK	3.75	20175/1732.5	25.12	20.27	4.85	≤13	PASS
	QPSK	3.75	20175/1732.5	24.42	20.25	4.17	≤13	PASS
	BPSK	15	20175/1732.5	24.65	17.35	7.30	≤13	PASS
	QPSK	15	20175/1732.5	24.34	17.43	6.91	≤13	PASS
Mode	Modulation	Sub-carrier spacing (KHz)	Channel/ Frequency(MHz)	Peak-to-Average Power Ratio (PAPR)			Limit (dB)	Conclusion
Peak(dBm)	Avg(dBm)	PAPR(dB)						
Band 12 Standalone	BPSK	3.75	23095/707.5	25.54	20.79	4.75	≤13	PASS
	QPSK	3.75	23095/707.5	24.82	20.72	4.10	≤13	PASS
	BPSK	15	23095/707.5	25.13	17.93	7.20	≤13	PASS
	QPSK	15	23095/707.5	24.80	17.94	6.86	≤13	PASS
Mode	Modulation	Sub-carrier spacing (KHz)	Channel/ Frequency(MHz)	Peak-to-Average Power Ratio (PAPR)			Limit (dB)	Conclusion
Peak(dBm)	Avg(dBm)	PAPR(dB)						
Band 13 Standalone	BPSK	3.75	23230/782	25.26	20.55	4.71	≤13	PASS
	QPSK	3.75	23230/782	24.59	20.50	4.09	≤13	PASS
	BPSK	15	23230/782	24.92	17.75	7.17	≤13	PASS
	QPSK	15	23230/782	24.58	17.78	6.80	≤13	PASS
Mode	Modulation	Sub-carrier spacing (KHz)	Channel/ Frequency(MHz)	Peak-to-Average Power Ratio (PAPR)			Limit (dB)	Conclusion
Peak(dBm)	Avg(dBm)	PAPR(dB)						
Band 66 Standalone	BPSK	3.75	132322/1745	25.40	20.56	4.84	≤13	PASS
	QPSK	3.75	132322/1745	24.73	20.57	4.16	≤13	PASS
	BPSK	15	132322/1745	24.53	17.56	6.97	≤13	PASS
	QPSK	15	132322/1745	24.87	17.58	7.29	≤13	PASS
Mode	Modulation	Sub-carrier spacing (KHz)	Channel/ Frequency(MHz)	Peak-to-Average Power Ratio (PAPR)			Limit (dB)	Conclusion
Peak(dBm)	Avg(dBm)	PAPR(dB)						
Band 71 Standalone	BPSK	3.75	133297/680.5	25.98	21.20	4.78	≤13	PASS
	QPSK	3.75	133297/680.5	25.35	21.23	4.12	≤13	PASS
	BPSK	15	133297/680.5	25.51	18.28	7.23	≤13	PASS
	QPSK	15	133297/680.5	25.17	18.30	6.87	≤13	PASS
Mode	Modulation	Sub-carrier spacing (KHz)	Channel/ Frequency(MHz)	Peak-to-Average Power Ratio (PAPR)			Limit (dB)	Conclusion
Peak(dBm)	Avg(dBm)	PAPR(dB)						
Band 85 Standalone	BPSK	3.75	134092/707	25.53	20.78	4.75	≤13	PASS
	QPSK	3.75	134092/707	24.86	20.76	4.10	≤13	PASS
	BPSK	15	134092/707	25.12	17.95	7.17	≤13	PASS
	QPSK	15	134092/707	24.79	17.89	6.90	≤13	PASS

## 5.5 Frequency Stability

### Ambient condition

Temperature	Relative humidity	Pressure
23°C ~25°C	45%~50%	101.5kPa

### Method of Measurement

#### Frequency Stability (Temperature Variation)

The temperature inside the climate chamber is varied from -40°C to +85°C in 10°C step size.

(1) With all power removed, the temperature was decreased to -10°C and permitted to stabilize for three hours.

(2) Measure the carrier frequency with the test equipment in a “call mode”. These measurements should be made within 1 minute of powering up the mobile station, to prevent significant self warming.

(3) Repeat the above measurements at 10°C increments from -40°C to +85°C. Allow at least 1.5 hours at each temperature, un-powered, before making measurements.

#### Frequency Stability (Voltage Variation)

The frequency stability shall be measured with variation of primary supply voltage as follows:

(1) Vary primary supply voltage from 85 to 115 percent of the nominal value for other than hand carried battery equipment.

(2) For hand carried, battery powered equipment, reduce primary supply voltage to the battery-operating end point which shall be specified by the manufacturer.

This transceiver is specified to operate with an input voltage of between 3.3 V and 4.3 V, with a nominal voltage of 3.8V.

### Test setup

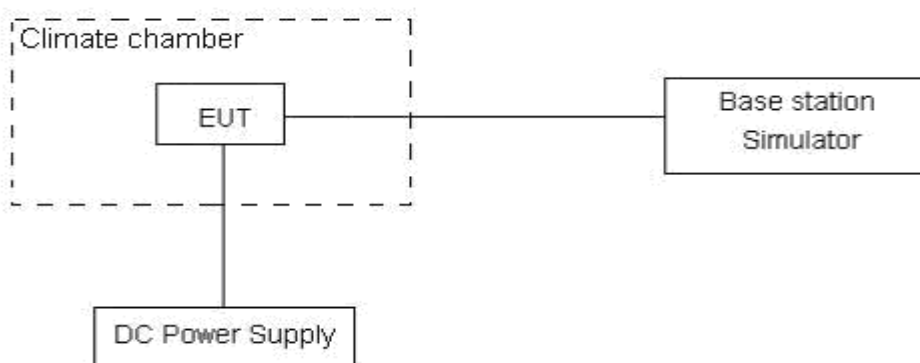

### Limits

The frequency stability shall be sufficient to ensure that the fundamental emissions stay within the authorized bands of operation.

### Measurement Uncertainty

The assessed measurement uncertainty to ensure 99.75% confidence level for the normal distribution is with the coverage factor  $k = 3, U = 0.01\text{ppm}$ .



## Test Result

NB-IOT Band 4						
Condition		Freq.Error (Hz)	Freq.Error (Hz)	Frequency Stability(ppm)	Frequency Stability(ppm)	Verdict
Sub-carrier spacing (KHz)	3.75					
Temperature	Voltage	BPSK	QPSK	BPSK	QPSK	
Normal(25°C)	Normal	9.35	17.74	0.00497	0.00944	PASS
Extreme(85°C)		4.37	12.09	0.00233	0.00643	PASS
Extreme(80°C)		4.60	7.06	0.00245	0.00376	PASS
Extreme(70°C)		11.79	9.34	0.00627	0.00497	PASS
Extreme(60°C)		3.84	15.70	0.00204	0.00835	PASS
Extreme(50°C)		7.35	4.69	0.00391	0.00250	PASS
Extreme(40°C)		4.59	1.56	0.00244	0.00083	PASS
Extreme(30°C)		6.68	12.26	0.00355	0.00652	PASS
Extreme(20°C)		17.37	11.59	0.00924	0.00616	PASS
Extreme(10°C)		6.11	9.18	0.00325	0.00488	PASS
Extreme(0°C)		12.14	4.06	0.00646	0.00216	PASS
Extreme(-10°C)		15.50	9.76	0.00824	0.00519	PASS
Extreme(-20°C)		4.67	6.05	0.00249	0.00322	PASS
Extreme(-30°C)		6.49	11.72	0.00345	0.00624	PASS
Extreme(-40°C)		1.54	1.39	0.00082	0.00074	PASS
25°C		LV	3.56	10.25	0.00189	0.00545
	HV	12.70	2.17	0.00675	0.00116	PASS
Condition		Freq.Error (Hz)	Freq.Error (Hz)	Frequency Stability(ppm)	Frequency Stability(ppm)	Verdict
Sub-carrier spacing (KHz)	15					
Temperature	Voltage	BPSK	QPSK	BPSK	QPSK	
Normal(25°C)	Normal	13.28	16.32	0.00706	0.00868	PASS
Extreme(85°C)		11.81	6.50	0.00628	0.00346	PASS
Extreme(80°C)		10.68	17.23	0.00568	0.00917	PASS
Extreme(70°C)		4.61	12.46	0.00245	0.00663	PASS
Extreme(60°C)		10.34	2.42	0.00550	0.00129	PASS
Extreme(50°C)		15.82	10.63	0.00842	0.00565	PASS
Extreme(40°C)		4.07	4.95	0.00216	0.00263	PASS
Extreme(30°C)		7.52	5.39	0.00400	0.00287	PASS
Extreme(20°C)		13.73	15.52	0.00730	0.00825	PASS
Extreme(10°C)		2.43	11.38	0.00129	0.00605	PASS
Extreme(0°C)		2.69	3.58	0.00143	0.00191	PASS
Extreme(-10°C)		12.91	4.74	0.00687	0.00252	PASS
Extreme(-20°C)		11.32	15.04	0.00602	0.00800	PASS



Extreme(-30°C)		7.75	8.43	0.00412	0.00448	PASS
Extreme(-40°C)		9.42	1.81	0.00501	0.00096	PASS
25°C	LV	6.50	5.77	0.00346	0.00307	PASS
	HV	13.85	11.71	0.00737	0.00623	PASS

NB-IOT Band 12						
Condition		Freq.Error (Hz)	Freq.Error (Hz)	Frequency Stability(ppm)	Frequency Stability(ppm)	Verdict
Sub-carrier spacing (KHz)	3.75	BPSK	QPSK	BPSK	QPSK	
Temperature	Voltage	BPSK	QPSK	BPSK	QPSK	
Normal(25°C)	Normal	7.77	4.42	0.00413	0.00235	PASS
Extreme(85°C)		3.28	10.93	0.00174	0.00581	PASS
Extreme(80°C)		4.32	9.79	0.00230	0.00521	PASS
Extreme(70°C)		8.31	6.32	0.00442	0.00336	PASS
Extreme(60°C)		6.52	6.50	0.00347	0.00346	PASS
Extreme(50°C)		5.93	6.61	0.00315	0.00352	PASS
Extreme(40°C)		5.27	4.22	0.00280	0.00225	PASS
Extreme(30°C)		17.47	10.06	0.00929	0.00535	PASS
Extreme(20°C)		15.05	5.74	0.00800	0.00305	PASS
Extreme(10°C)		3.25	1.95	0.00173	0.00104	PASS
Extreme(0°C)		17.59	15.76	0.00936	0.00838	PASS
Extreme(-10°C)		8.63	16.86	0.00459	0.00897	PASS
Extreme(-20°C)		7.11	1.20	0.00378	0.00064	PASS
Extreme(-30°C)		11.91	16.50	0.00633	0.00878	PASS
Extreme(-40°C)		10.23	3.57	0.00544	0.00190	PASS
25°C	LV	3.60	10.64	0.00191	0.00566	PASS
	HV	1.17	15.62	0.00062	0.00831	PASS
Condition		Freq.Error (Hz)	Freq.Error (Hz)	Frequency Stability(ppm)	Frequency Stability(ppm)	Verdict
Sub-carrier spacing (KHz)	15	BPSK	QPSK	BPSK	QPSK	
Temperature	Voltage	BPSK	QPSK	BPSK	QPSK	
Normal(25°C)	Normal	2.34	16.25	0.00125	0.00864	PASS
Extreme(85°C)		1.29	15.04	0.00069	0.00800	PASS
Extreme(80°C)		1.23	17.58	0.00065	0.00935	PASS
Extreme(70°C)		11.45	12.74	0.00609	0.00677	PASS
Extreme(60°C)		14.97	16.23	0.00796	0.00863	PASS
Extreme(50°C)		6.63	16.48	0.00353	0.00876	PASS
Extreme(40°C)		9.10	16.68	0.00484	0.00887	PASS
Extreme(30°C)		1.01	8.25	0.00054	0.00439	PASS



Extreme(20°C)		6.67	11.97	0.00355	0.00637	PASS
Extreme(10°C)		3.67	15.78	0.00195	0.00839	PASS
Extreme(0°C)		2.71	14.12	0.00144	0.00751	PASS
Extreme(-10°C)		14.68	3.32	0.00781	0.00176	PASS
Extreme(-20°C)		2.86	5.09	0.00152	0.00271	PASS
Extreme(-30°C)		17.71	11.70	0.00942	0.00622	PASS
Extreme(-40°C)		15.82	10.20	0.00841	0.00542	PASS
25°C	LV	17.72	7.48	0.00943	0.00398	PASS
	HV	1.17	16.18	0.00062	0.00861	PASS

NB-IOT Band 13						
Condition		Freq.Error (Hz)	Freq.Error (Hz)	Frequency Stability(ppm)	Frequency Stability(ppm)	Verdict
Sub-carrier spacing (KHz)	3.75	BPSK	QPSK	BPSK	QPSK	
Temperature	Voltage	BPSK	QPSK	BPSK	QPSK	
Normal(25°C)	Normal	5.05	7.10	0.00269	0.00378	PASS
Extreme(85°C)		12.29	16.72	0.00654	0.00889	PASS
Extreme(80°C)		10.56	13.78	0.00561	0.00733	PASS
Extreme(70°C)		10.41	15.70	0.00554	0.00835	PASS
Extreme(60°C)		2.42	16.95	0.00129	0.00901	PASS
Extreme(50°C)		2.01	3.14	0.00107	0.00167	PASS
Extreme(40°C)		16.17	3.90	0.00860	0.00207	PASS
Extreme(30°C)		12.61	7.30	0.00671	0.00388	PASS
Extreme(20°C)		15.74	1.42	0.00837	0.00076	PASS
Extreme(10°C)		4.59	13.26	0.00244	0.00705	PASS
Extreme(0°C)		10.94	15.74	0.00582	0.00837	PASS
Extreme(-10°C)		4.05	11.94	0.00215	0.00635	PASS
Extreme(-20°C)		8.01	2.49	0.00426	0.00132	PASS
Extreme(-30°C)		10.45	15.21	0.00556	0.00809	PASS
Extreme(-40°C)		1.21	6.44	0.00065	0.00343	PASS
25°C		LV	7.38	14.67	0.00392	0.00780
	HV	3.75	15.52	0.00199	0.00825	PASS
Condition		Freq.Error (Hz)	Freq.Error (Hz)	Frequency Stability(ppm)	Frequency Stability(ppm)	Verdict
Sub-carrier spacing (KHz)	15	BPSK	QPSK	BPSK	QPSK	
Temperature	Voltage	BPSK	QPSK	BPSK	QPSK	
Normal(25°C)	Normal	15.38	9.08	0.00818	0.00483	PASS
Extreme(85°C)		9.76	15.42	0.00519	0.00820	PASS
Extreme(80°C)		6.81	3.01	0.00362	0.00160	PASS



Extreme(70°C)		2.88	9.74	0.00153	0.00518	PASS
Extreme(60°C)		17.82	9.95	0.00948	0.00529	PASS
Extreme(50°C)		16.49	3.83	0.00877	0.00204	PASS
Extreme(40°C)		8.98	1.05	0.00478	0.00056	PASS
Extreme(30°C)		12.39	15.08	0.00659	0.00802	PASS
Extreme(20°C)		15.34	8.85	0.00816	0.00471	PASS
Extreme(10°C)		2.30	2.84	0.00122	0.00151	PASS
Extreme(0°C)		8.70	7.94	0.00463	0.00422	PASS
Extreme(-10°C)		9.46	9.89	0.00503	0.00526	PASS
Extreme(-20°C)		13.39	8.02	0.00712	0.00426	PASS
Extreme(-30°C)		10.82	11.43	0.00575	0.00608	PASS
Extreme(-40°C)		16.84	14.29	0.00896	0.00760	PASS
25°C	LV	12.55	16.15	0.00668	0.00859	PASS
	HV	17.76	13.53	0.00945	0.00720	PASS

NB-IOT Band 66						
Condition		Freq.Error (Hz)	Freq.Error (Hz)	Frequency Stability(ppm)	Frequency Stability(ppm)	Verdict
Sub-carrier spacing (KHz)	3.75	BPSK	QPSK	BPSK	QPSK	
Temperature	Voltage					
Normal(25°C)	Normal	14.89	17.35	0.00792	0.00923	PASS
Extreme(85°C)		16.65	14.36	0.00886	0.00764	PASS
Extreme(80°C)		16.23	1.41	0.00863	0.00075	PASS
Extreme(70°C)		17.96	17.62	0.00955	0.00937	PASS
Extreme(60°C)		6.77	1.77	0.00360	0.00094	PASS
Extreme(50°C)		16.80	8.42	0.00894	0.00448	PASS
Extreme(40°C)		11.16	14.95	0.00594	0.00795	PASS
Extreme(30°C)		8.67	3.09	0.00461	0.00164	PASS
Extreme(20°C)		12.53	3.09	0.00667	0.00164	PASS
Extreme(10°C)		3.33	5.75	0.00177	0.00306	PASS
Extreme(0°C)		7.50	10.16	0.00399	0.00540	PASS
Extreme(-10°C)		3.21	14.81	0.00171	0.00788	PASS
Extreme(-20°C)		15.33	6.30	0.00815	0.00335	PASS
Extreme(-30°C)		8.91	5.76	0.00474	0.00306	PASS
Extreme(-40°C)		3.81	11.29	0.00203	0.00600	PASS
25°C	LV	10.02	16.64	0.00533	0.00885	PASS
	HV	15.14	2.21	0.00805	0.00117	PASS
Condition		Freq.Error (Hz)	Freq.Error (Hz)	Frequency Stability(ppm)	Frequency Stability(ppm)	Verdict
Sub-carrier spacing	15					





(KHz)						
Temperature	Voltage	BPSK	QPSK	BPSK	QPSK	
Normal(25°C)	Normal	10.50	4.20	0.00558	0.00224	PASS
Extreme(85°C)		6.95	9.57	0.00370	0.00509	PASS
Extreme(80°C)		17.89	2.48	0.00952	0.00132	PASS
Extreme(70°C)		7.03	15.87	0.00374	0.00844	PASS
Extreme(60°C)		2.13	8.55	0.00113	0.00455	PASS
Extreme(50°C)		12.88	14.89	0.00685	0.00792	PASS
Extreme(40°C)		6.49	3.42	0.00345	0.00182	PASS
Extreme(30°C)		7.30	11.05	0.00388	0.00588	PASS
Extreme(20°C)		16.08	4.82	0.00855	0.00256	PASS
Extreme(10°C)		16.50	4.52	0.00878	0.00241	PASS
Extreme(0°C)		13.64	4.99	0.00726	0.00266	PASS
Extreme(-10°C)		5.68	10.87	0.00302	0.00578	PASS
Extreme(-20°C)		7.51	1.51	0.00400	0.00080	PASS
Extreme(-30°C)		4.30	15.36	0.00229	0.00817	PASS
Extreme(-40°C)		10.79	17.04	0.00574	0.00906	PASS
25°C	LV	12.23	4.49	0.00651	0.00239	PASS
	HV	17.63	2.74	0.00938	0.00146	PASS

NB-IOT Band 71						
Condition		Freq.Error (Hz)	Freq.Error (Hz)	Frequency Stability(ppm)	Frequency Stability(ppm)	Verdict
Sub-carrier spacing (KHz)	3.75					
Temperature	Voltage	BPSK	QPSK	BPSK	QPSK	
Normal(25°C)	Normal	14.67	2.50	0.00780	0.00133	PASS
Extreme(85°C)		13.31	5.46	0.00708	0.00290	PASS
Extreme(80°C)		8.05	12.64	0.00428	0.00672	PASS
Extreme(70°C)		12.01	14.95	0.00639	0.00795	PASS
Extreme(60°C)		16.74	7.29	0.00891	0.00388	PASS
Extreme(50°C)		14.53	2.41	0.00773	0.00128	PASS
Extreme(40°C)		17.14	5.44	0.00912	0.00290	PASS
Extreme(30°C)		12.25	6.63	0.00652	0.00352	PASS
Extreme(20°C)		12.95	16.81	0.00689	0.00894	PASS
Extreme(10°C)		11.52	1.48	0.00613	0.00079	PASS
Extreme(0°C)		9.28	6.43	0.00493	0.00342	PASS
Extreme(-10°C)		8.04	7.82	0.00428	0.00416	PASS
Extreme(-20°C)		6.57	3.94	0.00349	0.00210	PASS
Extreme(-30°C)		17.21	17.26	0.00916	0.00918	PASS
Extreme(-40°C)		16.19	11.66	0.00861	0.00620	PASS



Condition		Freq.Error (Hz)	Freq.Error (Hz)	Frequency Stability(ppm)	Frequency Stability(ppm)	Verdict
Sub-carrier spacing (KHz)	15					
Temperature	Voltage	BPSK	QPSK	BPSK	QPSK	
25°C	LV	9.20	2.80	0.00490	0.00149	PASS
	HV	12.77	6.45	0.00679	0.00343	PASS
Normal(25°C)	Normal	5.01	13.18	0.00267	0.00701	PASS
Extreme(85°C)		17.41	11.03	0.00926	0.00587	PASS
Extreme(80°C)		7.25	16.80	0.00385	0.00893	PASS
Extreme(70°C)		14.05	6.18	0.00747	0.00329	PASS
Extreme(60°C)		4.93	15.17	0.00262	0.00807	PASS
Extreme(50°C)		4.85	10.77	0.00258	0.00573	PASS
Extreme(40°C)		13.96	10.00	0.00743	0.00532	PASS
Extreme(30°C)		4.90	5.55	0.00260	0.00295	PASS
Extreme(20°C)		9.80	14.13	0.00521	0.00752	PASS
Extreme(10°C)		4.30	16.91	0.00229	0.00900	PASS
Extreme(0°C)		16.61	16.45	0.00883	0.00875	PASS
Extreme(-10°C)		17.81	16.96	0.00947	0.00902	PASS
Extreme(-20°C)		8.68	4.56	0.00462	0.00243	PASS
Extreme(-30°C)		8.37	8.76	0.00445	0.00466	PASS
Extreme(-40°C)		12.51	9.82	0.00665	0.00522	PASS
25°C	LV	10.43	3.73	0.00555	0.00199	PASS
	HV	2.61	12.63	0.00139	0.00672	PASS

NB-IOT Band 85						
Condition		Freq.Error (Hz)	Freq.Error (Hz)	Frequency Stability(ppm)	Frequency Stability(ppm)	Verdict
Sub-carrier spacing (KHz)	3.75					
Temperature	Voltage	BPSK	QPSK	BPSK	QPSK	
Normal(25°C)	Normal	13.68	17.44	0.00727	0.00928	PASS
Extreme(85°C)		3.74	9.43	0.00199	0.00502	PASS
Extreme(80°C)		1.27	7.58	0.00068	0.00403	PASS
Extreme(70°C)		6.30	6.28	0.00335	0.00334	PASS
Extreme(60°C)		5.25	13.25	0.00279	0.00705	PASS
Extreme(50°C)		13.23	9.26	0.00704	0.00493	PASS
Extreme(40°C)		1.40	4.77	0.00074	0.00254	PASS
Extreme(30°C)		14.95	17.77	0.00795	0.00945	PASS
Extreme(20°C)		1.09	14.81	0.00058	0.00788	PASS
Extreme(10°C)		4.43	16.87	0.00236	0.00898	PASS



Extreme(0°C)		12.90	11.94	0.00686	0.00635	PASS
Extreme(-10°C)		11.65	10.24	0.00619	0.00545	PASS
Extreme(-20°C)		11.96	10.94	0.00636	0.00582	PASS
Extreme(-30°C)		16.91	11.18	0.00899	0.00595	PASS
Extreme(-40°C)		10.39	5.87	0.00553	0.00312	PASS
25°C	LV	11.65	8.67	0.00620	0.00461	PASS
	HV	15.84	2.98	0.00843	0.00159	PASS
Condition		Freq.Error	Freq.Error	Frequency	Frequency	Verdict
Sub-carrier spacing	15	(Hz)	(Hz)	Stability(ppm)	Stability(ppm)	
(KHz)						
Temperature	Voltage	BPSK	QPSK	BPSK	QPSK	
Normal(25°C)	Normal	6.51	2.39	0.00347	0.00127	PASS
Extreme(85°C)		13.71	10.76	0.00729	0.00572	PASS
Extreme(80°C)		5.00	8.39	0.00266	0.00446	PASS
Extreme(70°C)		4.91	16.65	0.00261	0.00885	PASS
Extreme(60°C)		7.78	2.37	0.00414	0.00126	PASS
Extreme(50°C)		1.09	13.26	0.00058	0.00705	PASS
Extreme(40°C)		2.09	12.76	0.00111	0.00679	PASS
Extreme(30°C)		10.34	2.50	0.00550	0.00133	PASS
Extreme(20°C)		7.17	14.52	0.00382	0.00772	PASS
Extreme(10°C)		6.16	10.65	0.00328	0.00567	PASS
Extreme(0°C)		9.77	3.46	0.00520	0.00184	PASS
Extreme(-10°C)		17.46	5.38	0.00929	0.00286	PASS
Extreme(-20°C)		13.75	8.57	0.00731	0.00456	PASS
Extreme(-30°C)		13.37	3.91	0.00711	0.00208	PASS
Extreme(-40°C)		1.85	8.11	0.00099	0.00431	PASS
25°C	LV	10.51	2.77	0.00559	0.00147	PASS
	HV	7.52	11.11	0.00400	0.00591	PASS

## 5.6 Spurious Emissions at Antenna Terminals

### Ambient condition

Temperature	Relative humidity	Pressure
23°C ~25°C	45%~50%	101.5kPa

### Method of Measurement

The EUT was connected to Spectrum Analyzer and Base Station Simulator via power Splitter. The measurement is carried out using a spectrum analyzer. The spectrum analyzer scans from 9kHz to the 10th harmonic of the carrier. The peak detector is used.

RBW is set to 100kHz, VBW is set to 300kHz for 30MHz~1GHz

RBW is set to 1MHz, VBW is set to 3MHz for above 1GHz, Sweep is set to ATUO.

Of those disturbances below (limit – 20 dB), the mark is not required for the EUT.

The modulation mode and RB allocation refer to section 5.1, using the maximum output power configuration.

### Test setup

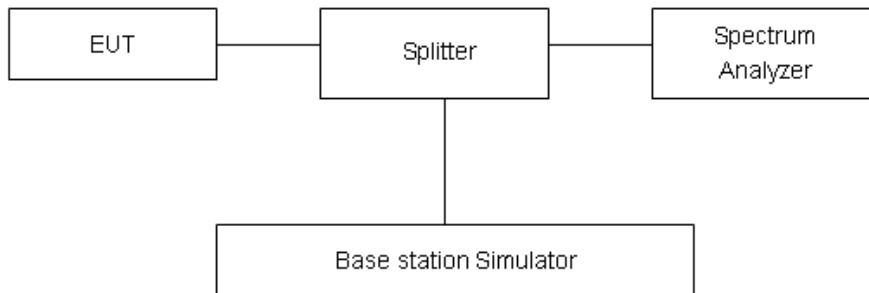

### Limits

Rule Part 27.53(h) specifies that “for operations in the 1695-1710 MHz, 1710-1755 MHz, 1755-1780 MHz, 1915-1920 MHz, 1995-2000 MHz, 2000-2020 MHz, 2110-2155 MHz, 2155-2180 MHz, and 2180-2200 bands, the power of any emission outside a licensee's frequency block shall be attenuated below the transmitter power (P) in watts by at least  $43 + 10 \log_{10}(P)$  dB..”

Rule Part 27.53 (g) For operations in the 600 MHz band and the 698-746 MHz band, the power of any emission outside a licensee's frequency band(s) of operation shall be attenuated below the transmitter power (P) within the licensed band(s) of operation, measured in watts, by at least  $43 + 10 \log(P)$  dB. Compliance with this provision is based on the use of measurement instrumentation employing a resolution bandwidth of 100 kilohertz or greater. However, in the 100 kilohertz bands immediately outside and adjacent to a licensee's frequency block, a resolution bandwidth of at least 30 kHz may be employed.

Rule Part 27.53(f) For operations in the 746-758 MHz, 775-788 MHz, and 805-806 MHz bands,



emissions in the band 1559-1610 MHz shall be limited to  $-70$  dBW/MHz equivalent isotropically radiated power (EIRP) for wideband signals, and  $-80$  dBW EIRP for discrete emissions of less than 700 Hz bandwidth. For the purpose of equipment authorization, a transmitter shall be tested with an antenna that is representative of the type that will be used with the equipment in normal operation.

Part 27.53 (c) For operations in the 746-758 MHz band and the 776-788 MHz band, the power of any emission outside the licensee's frequency band(s) of operation shall be attenuated below the transmitter power (P) within the licensed band(s) of operation, measured in watts, in accordance with the following:

- (1) On any frequency outside the 746-758 MHz band, the power of any emission shall be attenuated outside the band below the transmitter power (P) by at least  $43 + 10 \log (P)$  dB;
- (2) On any frequency outside the 776-788 MHz band, the power of any emission shall be attenuated outside the band below the transmitter power (P) by at least  $43 + 10 \log (P)$  dB;
- (3) On all frequencies between 763-775 MHz and 793-805 MHz, by a factor not less than  $76 + 10 \log (P)$  dB in a 6.25 kHz band segment, for base and fixed stations;
- (4) On all frequencies between 763-775 MHz and 793-805 MHz, by a factor not less than  $65 + 10 \log (P)$  dB in a 6.25 kHz band segment, for mobile and portable stations;
- (5) Compliance with the provisions of paragraphs (c)(1) and (c)(2) of this section is based on the use of measurement instrumentation employing a resolution bandwidth of 100 kHz or greater. However, in the 100 kHz bands immediately outside and adjacent to the frequency block, a resolution bandwidth of at least 30 kHz may be employed;

Part 27.53(h)/(g) Limit		-13 dBm
Part 27.53(f) Limit	Limit out of the band 1559-1610 MHz	-13 dBm
	Limit in the band 1559-1610 MHz	-40 dBm

### Measurement Uncertainty

The assessed measurement uncertainty to ensure 99.75% confidence level for the normal distribution is with the coverage factor  $k = 1.96$ .

Frequency	Uncertainty
9kHz-1GHz	0.684 dB
1GHz-27GHz	1.407 dB



### Test Result

Sweep the whole frequency band through the range from 9kHz to the 10th harmonic of the carrier, the emissions more than 20 dB below the limit are not reported.

The signal beyond the limit is carrier.

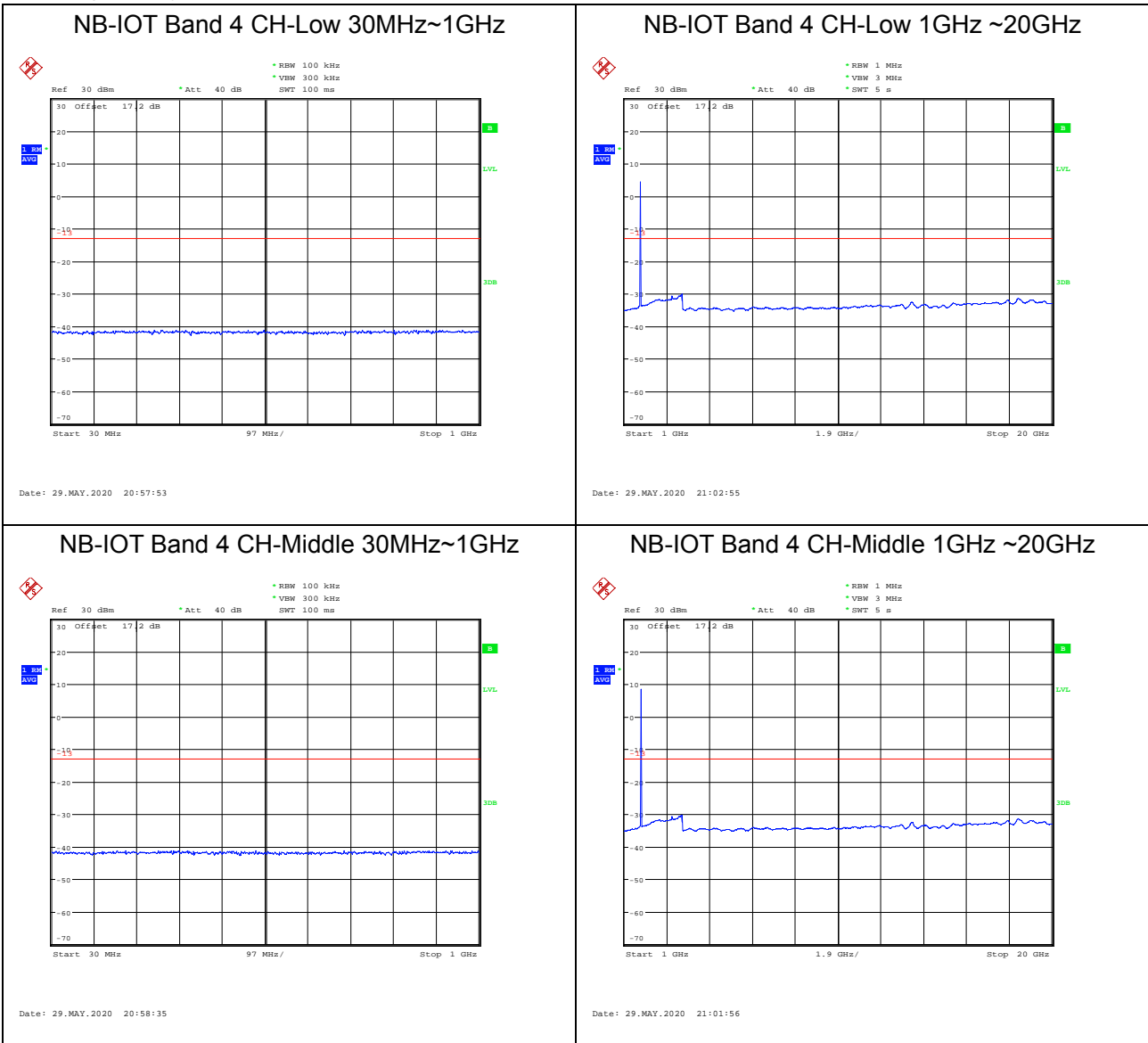



### NB-IOT Band 4 CH-High 30MHz~1GHz

### NB-IOT Band 4 CH-High 1GHz ~20GHz

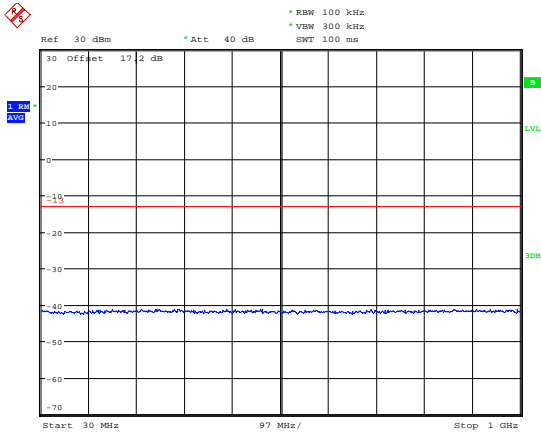

Date: 29.MAY.2020 21:00:12

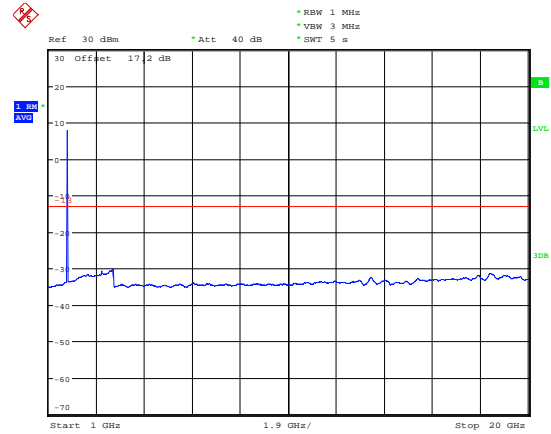

Date: 29.MAY.2020 21:00:40



### NB-IOT Band 12 CH-Low 30MHz~1GHz

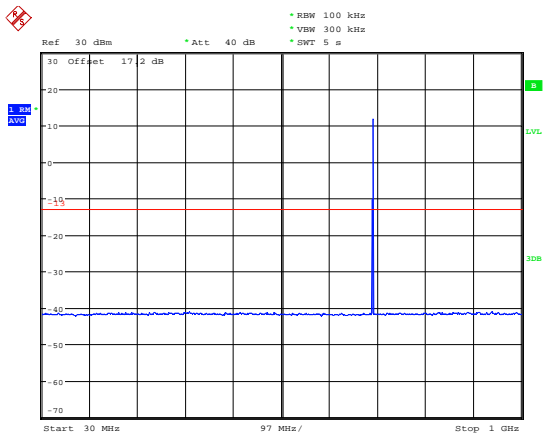

Date: 29.MAY.2020 21:11:46

### NB-IOT Band 12 CH-Low 1GHz ~9GHz

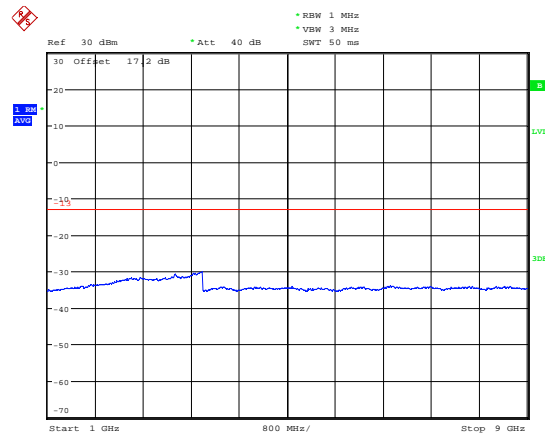

Date: 29.MAY.2020 21:17:31

### NB-IOT Band 12 CH-Middle 30MHz~1GHz

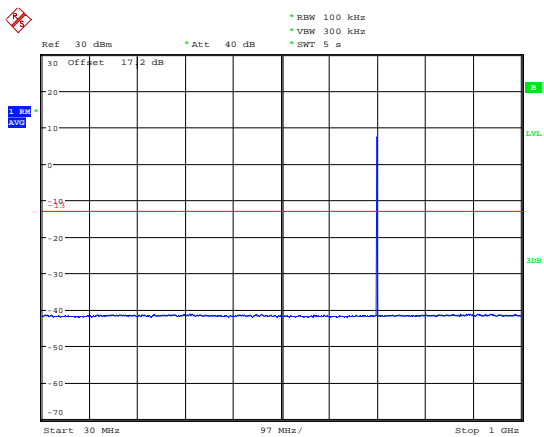

Date: 29.MAY.2020 21:15:59

### NB-IOT Band 12 CH-Middle 1GHz ~9GHz

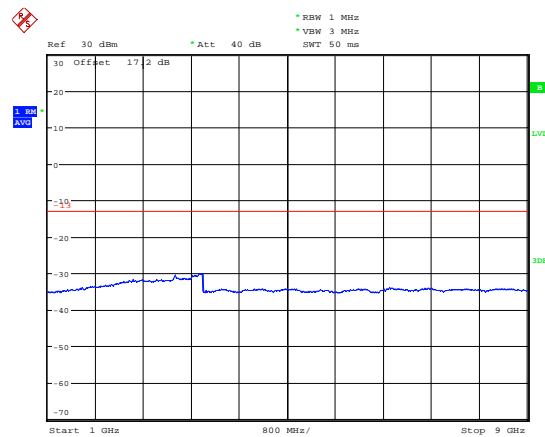

Date: 29.MAY.2020 21:17:47

### NB-IOT Band 12 CH-High 30MHz~1GHz

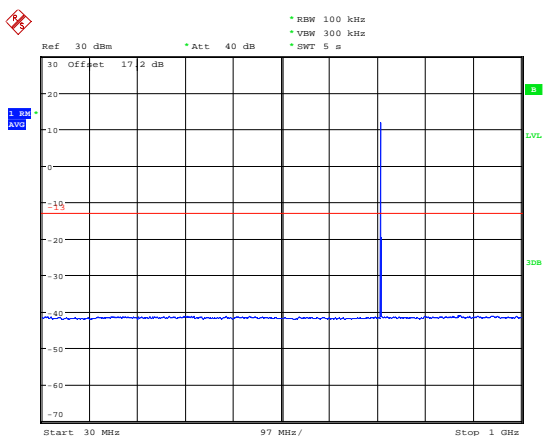

Date: 29.MAY.2020 21:17:08

### NB-IOT Band 12 CH-High 1GHz ~9GHz

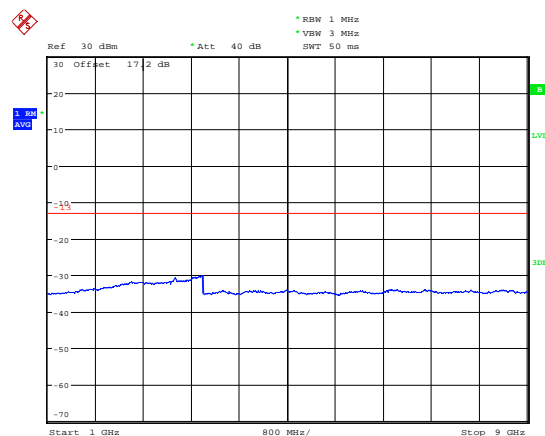

Date: 29.MAY.2020 21:17:56





### NB-IOT Band 13 CH-Low 30MHz~1GHz

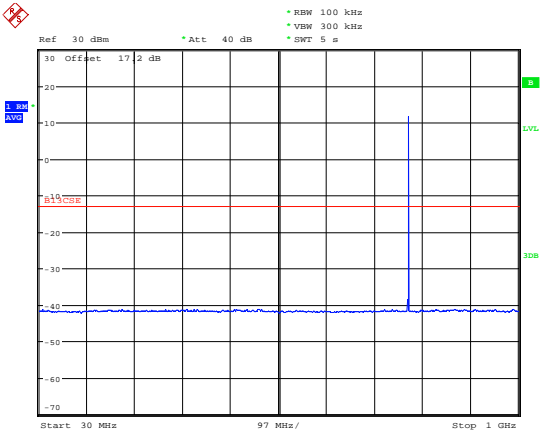

Date: 29.MAY.2020 21:22:17

### NB-IOT Band 13 CH-Low 1GHz ~9GHz

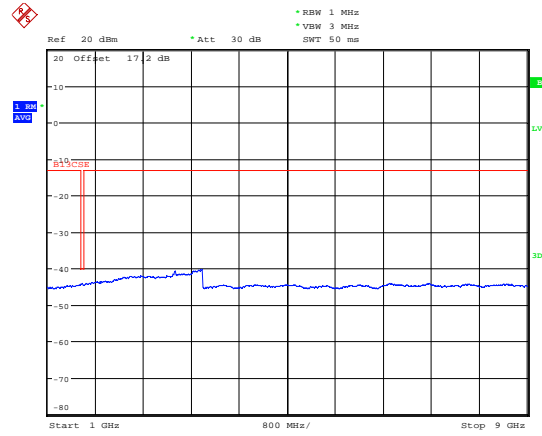

Date: 29.MAY.2020 21:26:25

### NB-IOT Band 13 CH-Middle 30MHz~1GHz

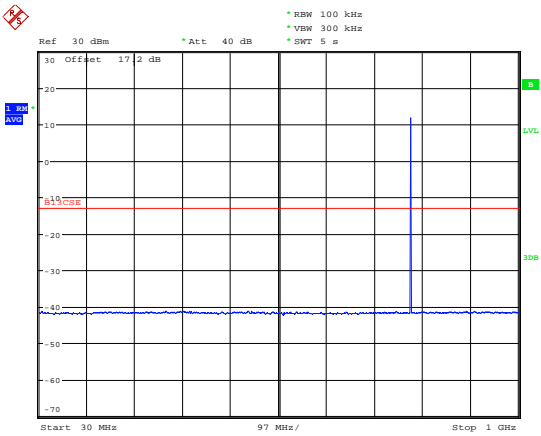

Date: 29.MAY.2020 21:24:09

### NB-IOT Band 13 CH-Middle 1GHz ~9GHz

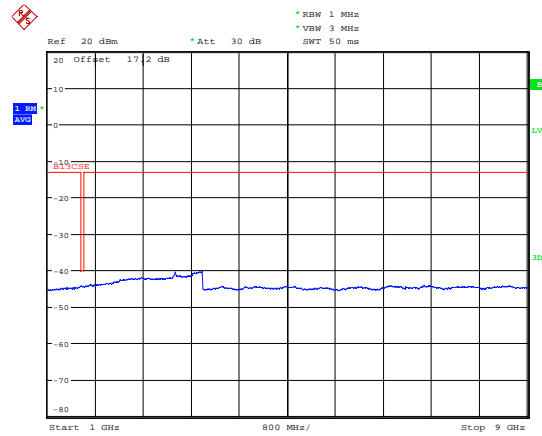

Date: 29.MAY.2020 21:27:25

### NB-IOT Band 13 CH-High 30MHz~1GHz

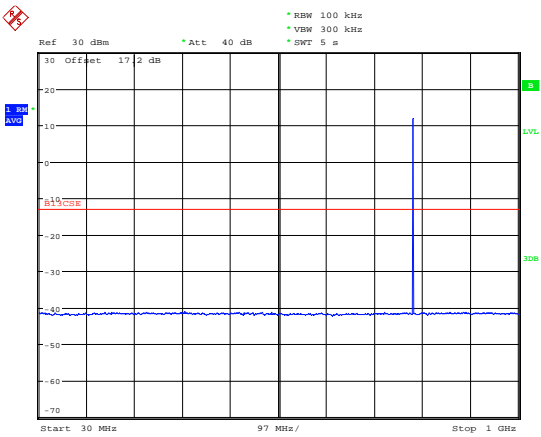

Date: 29.MAY.2020 21:25:33

### NB-IOT Band 13 CH-High 1GHz ~9GHz

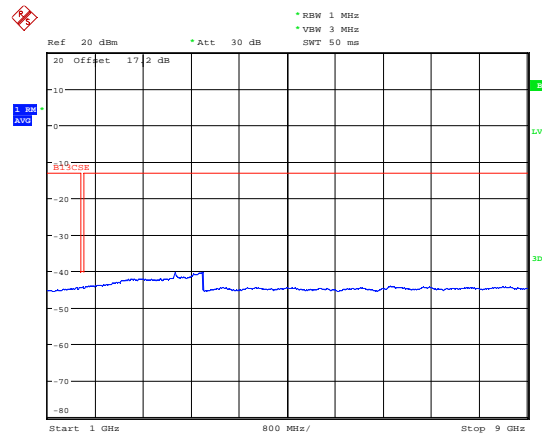

Date: 29.MAY.2020 21:28:02



### NB-IOT Band 66 CH-Low 30MHz~1GHz

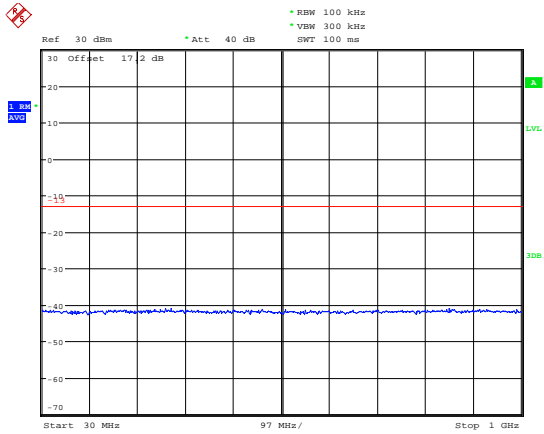

Date: 29.MAY.2020 21:37:05

### NB-IOT Band 66 CH-Low 1GHz ~20GHz

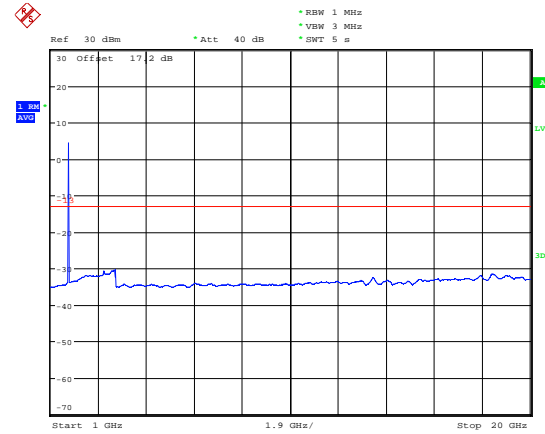

Date: 29.MAY.2020 21:38:08

### NB-IOT Band 66 CH-Middle 30MHz~1GHz

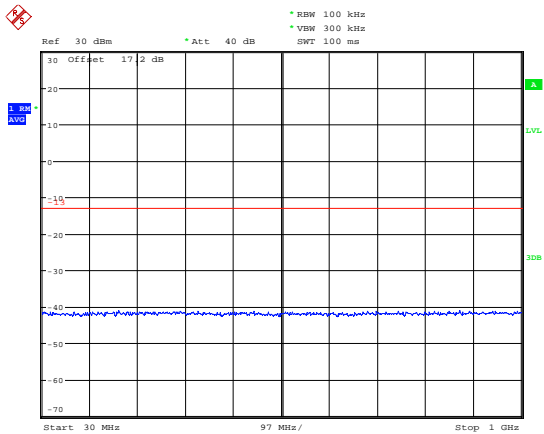

Date: 29.MAY.2020 21:37:25

### NB-IOT Band 66 CH-Middle 1GHz ~20GHz

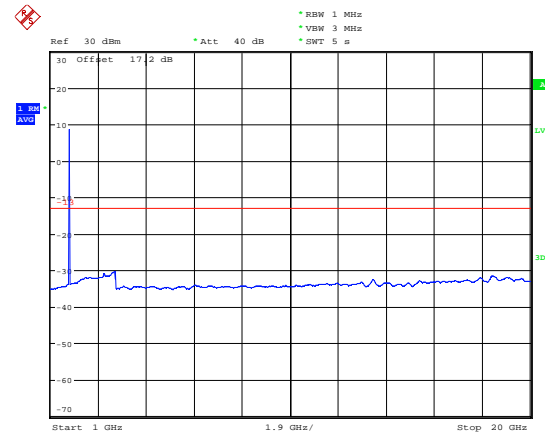

Date: 29.MAY.2020 21:39:06

### NB-IOT Band 66 CH-High 30MHz~1GHz

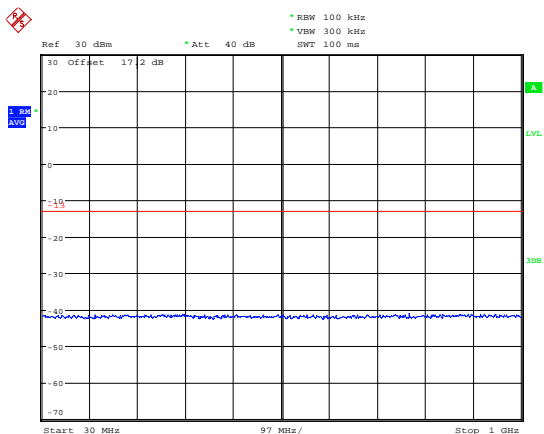

Date: 29.MAY.2020 21:37:34

### NB-IOT Band 66 CH-High 1GHz ~20GHz

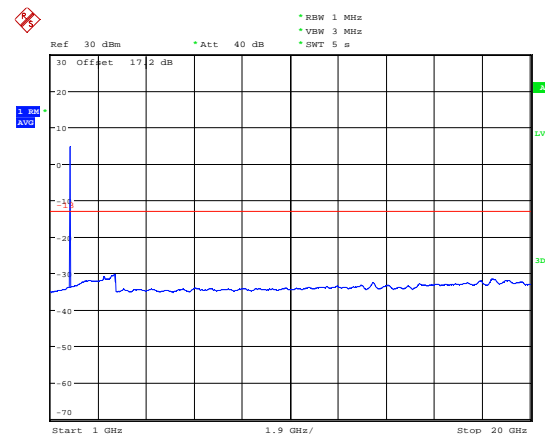

Date: 29.MAY.2020 21:41:14



### NB-IOT Band 71 CH-Low 30MHz~1GHz

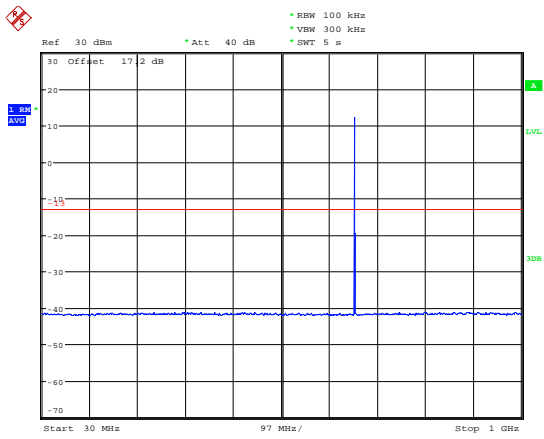

Date: 29.MAY.2020 21:42:51

### NB-IOT Band 71 CH-Low 1GHz ~9GHz

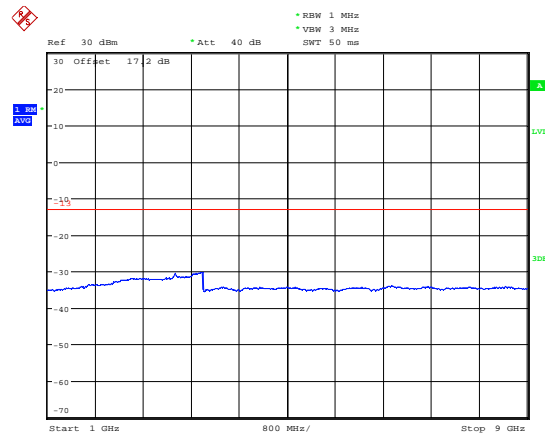

Date: 29.MAY.2020 21:46:54

### NB-IOT Band 71 CH-Middle 30MHz~1GHz

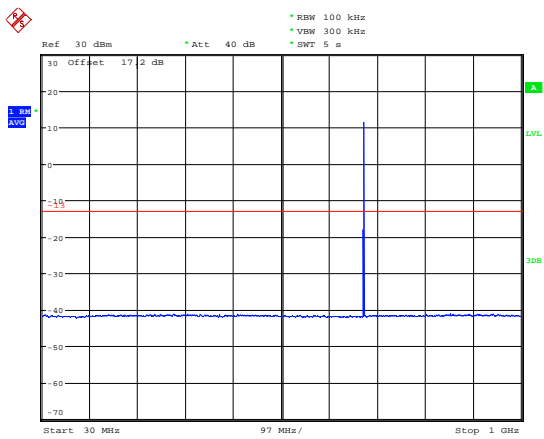

Date: 29.MAY.2020 21:45:30

### NB-IOT Band 71 CH-Middle 1GHz ~9GHz

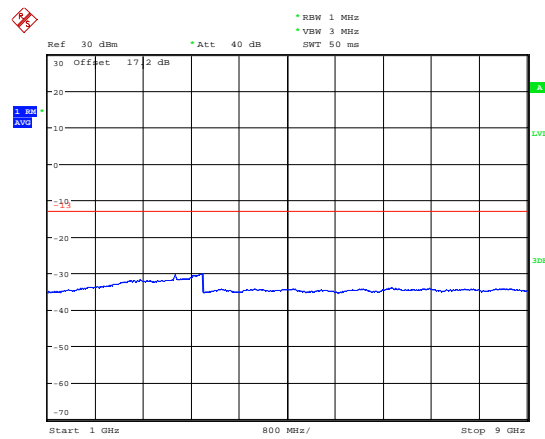

Date: 29.MAY.2020 21:47:06

### NB-IOT Band 71 CH-High 30MHz~1GHz

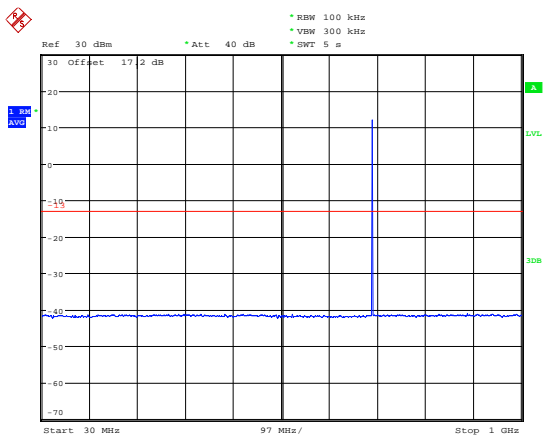

Date: 29.MAY.2020 21:46:30

### NB-IOT Band 71 CH-High 1GHz ~9GHz

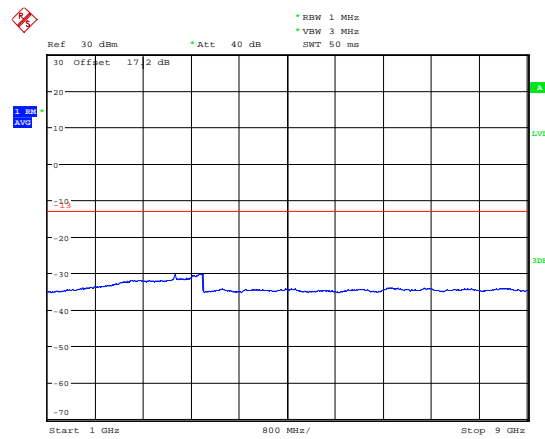

Date: 29.MAY.2020 21:47:20



### NB-IOT Band 85 CH-Low 30MHz~1GHz

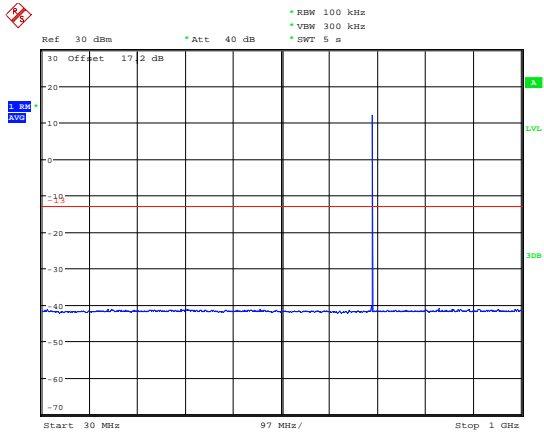

Date: 29.MAY.2020 21:49:42

### NB-IOT Band 85 CH-Low 1GHz ~9GHz

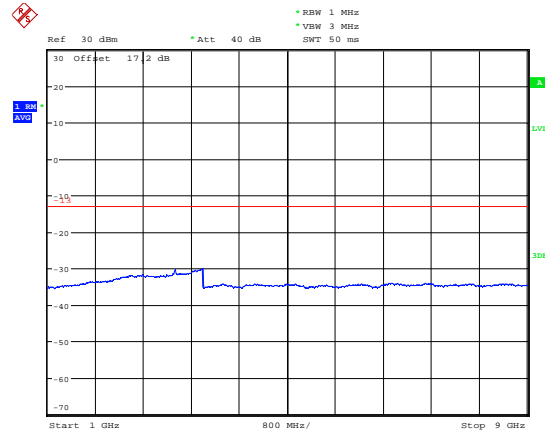

Date: 29.MAY.2020 21:49:10

### NB-IOT Band 85 CH-Middle 30MHz~1GHz

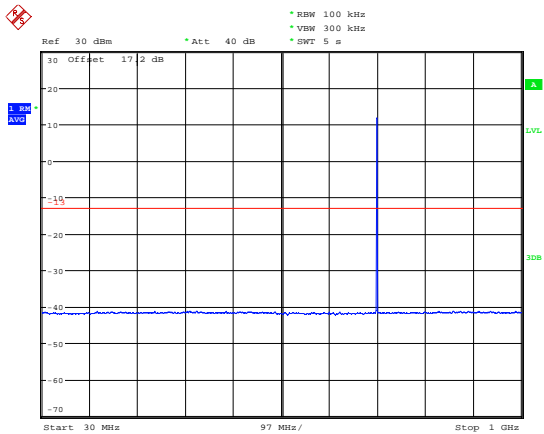

Date: 29.MAY.2020 21:50:36

### NB-IOT Band 85 CH-Middle 1GHz ~9GHz

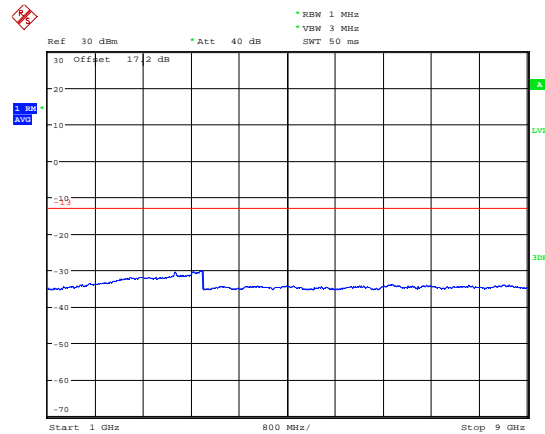

Date: 29.MAY.2020 21:48:59

### NB-IOT Band 85 CH-High 30MHz~1GHz

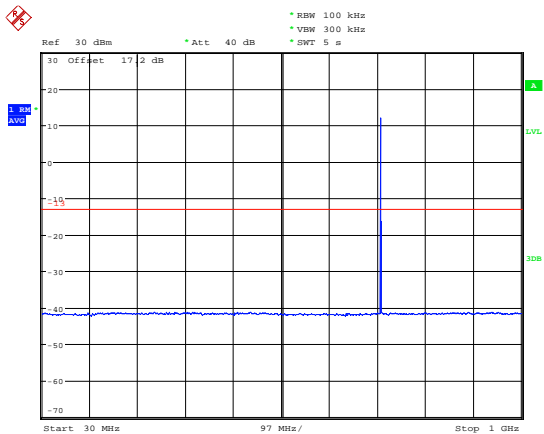

Date: 29.MAY.2020 21:51:20

### NB-IOT Band 85 CH-High 1GHz ~9GHz

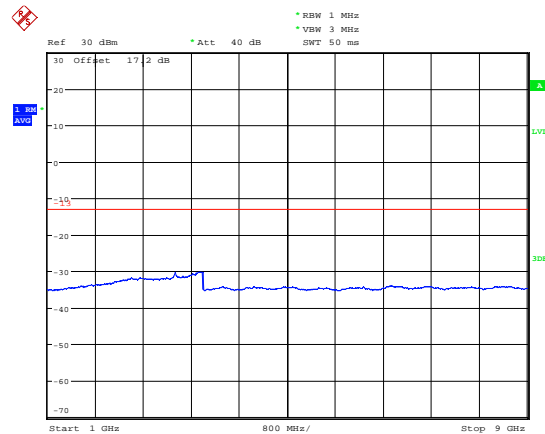

Date: 29.MAY.2020 21:48:49

## 5.7 Radiates Spurious Emission

### Ambient condition

Temperature	Relative humidity	Pressure
23°C ~25°C	45%~50%	101.5kPa

### Method of Measurement

- The testing follows FCC KDB 971168 D01 v03r01 Section 5.8 and ANSI C63.26 (2015).
- Below 1GHz: The EUT is placed on a turntable 0.8 meters above the ground in the chamber, 3 meter away from the antenna. The maximal emission value is acquired by adjusting the antenna height, polarisation and turntable azimuth. Normally, the height range of antenna is 1 m to 4 m, the azimuth range of turntable is 0° to 360°, and the receive antenna has two polarizations Vertical (V) and Horizontal (H). Above 1GHz: (Note: the FCC's permission to use 1.5m as an alternative per TCBC Conf call of Dec. 2, 2014.) The EUT is placed on a turntable 1.5 meters above the ground in the chamber, 3 meter away from the antenna. The maximal emission value is acquired by adjusting the antenna height, polarisation and turntable azimuth. Normally, the height range of antenna is 1 m to 4 m, the azimuth range of turntable is 0° to 360°, and the receive antenna has two polarizations Vertical (V) and Horizontal (H).
- A loop antenna, A log-periodic antenna or horn antenna shall be substituted in place of the EUT. The log-periodic antenna will be driven by a signal generator and the level will be adjusted till the same power value on the spectrum analyzer or receiver. The level of the spurious emissions can be calculated through the level of the signal generator, cable loss, the gain of the substitution antenna and the reading of the spectrum analyzer or receiver.
- The EUT is then put into continuously transmitting mode at its maximum power level during the test. Set Test Receiver or Spectrum RBW=200Hz,VBW=600Hz for 9kHz150kHz , RBW=10kHz, VBW=30kHz 150kHz-30MHz ,RBW=100kHz,VBW=300kHz for 30MHz to 1GHz and RBW=1MHz, VBW=3MHz for above 1GHz And the maximum value of the receiver should be recorded as (Pr).
- The EUT shall be replaced by a substitution antenna. In the chamber, an substitution antenna for the frequency band of interest is placed at the reference point of the chamber. An RF Signal source for the frequency band of interest is connected to the substitution antenna with a cable that has been constructed to not interfere with the radiation pattern of the antenna. A power (PMea) is applied to the input of the substitution antenna, and adjust the level of the signal generator output until the value of the receiver reach the previously recorded (Pr). The power of signal source (PMea) is recorded. The test should be performed by rotating the test item and adjusting the receiving antenna polarization.
- A amplifier should be connected to the Signal Source output port. And the cable should be connect between the Amplifier and the Substitution Antenna. The cable loss (Pcl) ,the Substitution Antenna Gain (Ga) and the Amplifier Gain (PAg) should be recorded after test.
- The measurement results are obtained as described below:  
 $Power(EIRP)=PMea- PAg - Pcl + Ga$   
 The measurement results are amend as described below:  
 $Power(EIRP)=PMea- Pcl + Ga$
- This value is EIRP since the measurement is calibrated using an antenna of known gain (2.15 dBi) and known input power. ERP can be calculated from EIRP by subtracting the gain of the dipole, ERP

= EIRP-2.15dBi.

The modulation mode and RB allocation refer to section 5.1, using the maximum output power configuration.

**Test setup**

**9KHz ~ 30MHz**

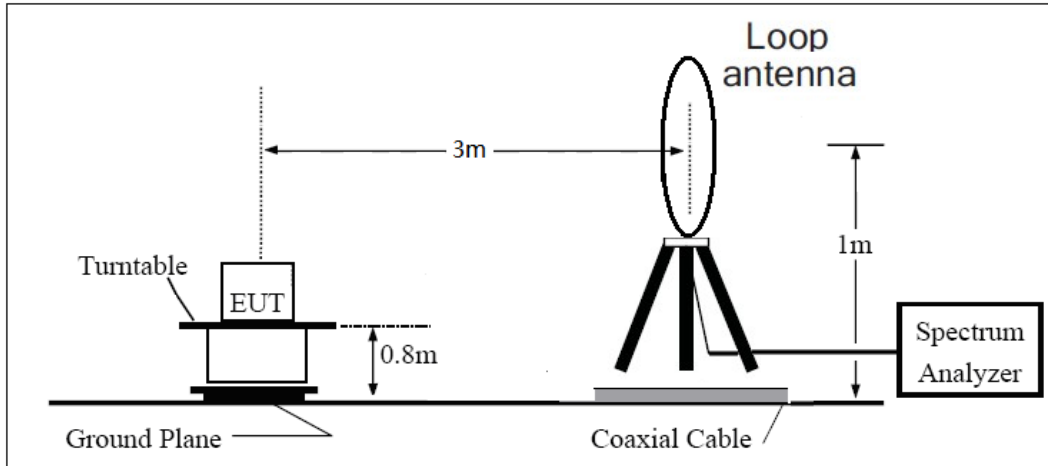

**30MHz ~ 1GHz**

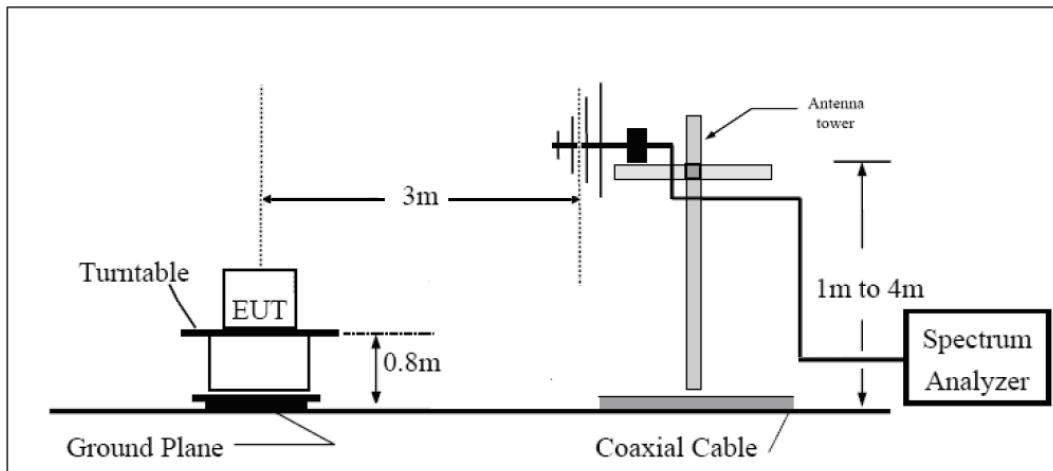

**Above 1GHz**

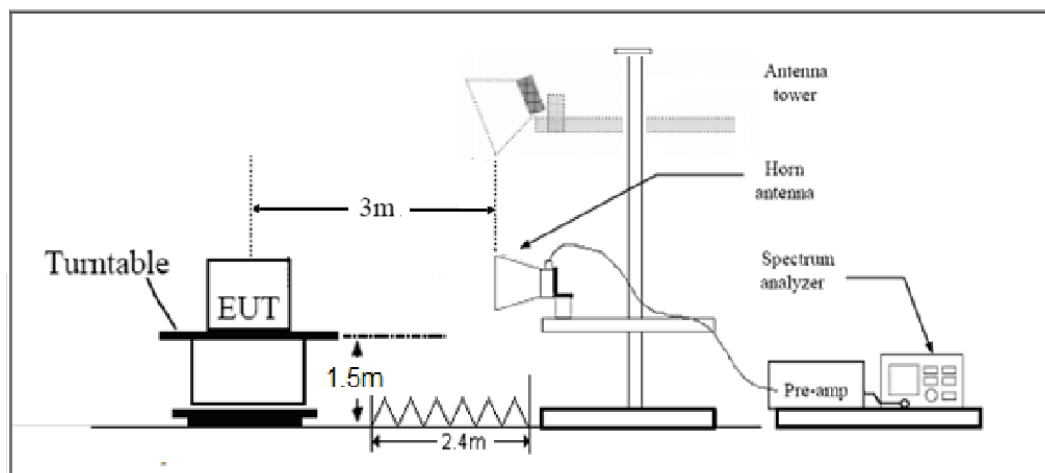

Note: Area side:2.4mX3.6m

**Limits**

Rule Part 27.53(h) specifies that “for operations in the 1695-1710 MHz, 1710-1755 MHz, 1755-1780 MHz, 1915-1920 MHz, 1995-2000 MHz, 2000-2020 MHz, 2110-2155 MHz, 2155-2180 MHz, and 2180-2200 bands, the power of any emission outside a licensee's frequency block shall be attenuated below the transmitter power (P) in watts by at least  $43 + 10 \log_{10}(P)$  dB.”

Rule Part 27.53 (g) For operations in the 600 MHz band and the 698-746 MHz band, the power of any emission outside a licensee's frequency band(s) of operation shall be attenuated below the transmitter power (P) within the licensed band(s) of operation, measured in watts, by at least  $43 + 10 \log(P)$  dB. Compliance with this provision is based on the use of measurement instrumentation employing a resolution bandwidth of 100 kilohertz or greater. However, in the 100 kilohertz bands immediately outside and adjacent to a licensee's frequency block, a resolution bandwidth of at least 30 kHz may be employed.

Rule Part 27.53(f) For operations in the 746-758 MHz, 775-788 MHz, and 805-806 MHz bands, emissions in the band 1559-1610 MHz shall be limited to  $-70$  dBW/MHz equivalent isotropically radiated power (EIRP) for wideband signals, and  $-80$  dBW EIRP for discrete emissions of less than 700 Hz bandwidth. For the purpose of equipment authorization, a transmitter shall be tested with an antenna that is representative of the type that will be used with the equipment in normal operation.

Part 27.53 (c) For operations in the 746-758 MHz band and the 776-788 MHz band, the power of any emission outside the licensee's frequency band(s) of operation shall be attenuated below the transmitter power (P) within the licensed band(s) of operation, measured in watts, in accordance with the following:

- (1) On any frequency outside the 746-758 MHz band, the power of any emission shall be attenuated outside the band below the transmitter power (P) by at least  $43 + 10 \log(P)$  dB;
- (2) On any frequency outside the 776-788 MHz band, the power of any emission shall be attenuated outside the band below the transmitter power (P) by at least  $43 + 10 \log(P)$  dB;
- (3) On all frequencies between 763-775 MHz and 793-805 MHz, by a factor not less than  $76 + 10 \log(P)$  dB in a 6.25 kHz band segment, for base and fixed stations;
- (4) On all frequencies between 763-775 MHz and 793-805 MHz, by a factor not less than  $65 + 10 \log(P)$  dB in a 6.25 kHz band segment, for mobile and portable stations;
- (5) Compliance with the provisions of paragraphs (c)(1) and (c)(2) of this section is based on the use of measurement instrumentation employing a resolution bandwidth of 100 kHz or greater. However, in the 100 kHz bands immediately outside and adjacent to the frequency block, a resolution bandwidth of at least 30 kHz may be employed;

Part 27.53 (h)/(g) Limit		-13 dBm
Part 27.53(f) Limit	Limit out of the band 1559-1610 MHz	-13 dBm
	Limit in the band 1559-1610 MHz	-40 dBm

**Measurement Uncertainty**



The assessed measurement uncertainty to ensure 95% confidence level for the normal distribution is with the coverage factor  $k = \pm 1.96$ ,  $U = \pm 3.55$  dB.



**Test Result**

Sweep the whole frequency band through the range from 9kHz to the 10th harmonic of the carrier, the emissions below the noise floor will not be recorded in the report.

NB-IOT Band 4 15kHz QPSK CH-Low

Harmonic	Frequency (MHz)	SG (dBm)	Cable Loss (dB)	Gain (dBi)	Antenna Polarization	EIRP Level (dBm)	Limit (dBm)	Margin (dB)	Azimuth (deg)
2	3420.0	-44.07	2.6	10.15	Horizontal	-36.52	-13.00	23.52	45
3	5130.0	-58.45	2.4	11.35	Horizontal	-49.50	-13.00	36.50	135
4	6840.0	-58.97	4.5	10.85	Horizontal	-52.62	-13.00	39.62	90
5	8550.0	-55.03	5.1	11.35	Horizontal	-48.78	-13.00	35.78	135
6	10260.0	-51.57	5.3	11.95	Horizontal	-44.92	-13.00	31.92	315
7	11970.0	-52.21	5.5	13.55	Horizontal	-44.16	-13.00	31.16	90
8	13680.0	-49.76	6.3	13.75	Horizontal	-42.31	-13.00	29.31	45
9	15390.0	-49.07	6.7	13.85	Horizontal	-41.92	-13.00	28.92	315
10	17100.0	-48.59	6.8	14.25	Horizontal	-41.14	-13.00	28.14	225

Note: 1.The other Spurious RF Radiated emissions level is no more than noise floor.

2. The worst emission was found in the antenna is Horizontal position.

NB-IOT Band 4 15kHz QPSK CH-Middle

Harmonic	Frequency (MHz)	SG (dBm)	Cable Loss (dB)	Gain (dBi)	Antenna Polarization	EIRP Level (dBm)	Limit (dBm)	Margin (dB)	Azimuth (deg)
2	3465.0	-45.40	2.6	10.75	Horizontal	-37.25	-13.00	24.25	90
3	5197.5	-56.72	2.4	11.05	Horizontal	-48.07	-13.00	35.07	0
4	6930.0	-60.28	4.5	11.15	Horizontal	-53.63	-13.00	40.63	45
5	8662.5	-55.48	5.1	11.35	Horizontal	-49.23	-13.00	36.23	90
6	10395.0	-50.83	5.3	11.95	Horizontal	-44.18	-13.00	31.18	225
7	12127.5	-51.36	5.5	13.55	Horizontal	-43.31	-13.00	30.31	45
8	13860.0	-49.44	6.3	13.75	Horizontal	-41.99	-13.00	28.99	90
9	15592.5	-49.05	6.7	13.85	Horizontal	-41.90	-13.00	28.90	270
10	17325.0	-47.67	6.8	14.25	Horizontal	-40.22	-13.00	27.22	135

Note: 1.The other Spurious RF Radiated emissions level is no more than noise floor.

2. The worst emission was found in the antenna is Horizontal position.



## NB-IOT Band 4 15kHz QPSK CH-High

Harmonic	Frequency (MHz)	SG (dBm)	Cable Loss (dB)	Gain (dBi)	Antenna Polarization	EIRP Level (dBm)	Limit (dBm)	Margin (dB)	Azimuth (deg)
2	3509.8	-47.64	2.6	10.15	Horizontal	-40.09	-13.00	27.09	225
3	5264.7	-55.88	2.4	11.05	Horizontal	-47.23	-13.00	34.23	45
4	7019.6	-56.82	4.5	11.15	Horizontal	-50.17	-13.00	37.17	135
5	8774.5	-54.58	5.1	11.35	Horizontal	-48.33	-13.00	35.33	225
6	10529.4	-52.22	5.3	11.95	Horizontal	-45.57	-13.00	32.57	90
7	12284.3	-52.61	5.5	13.55	Horizontal	-44.56	-13.00	31.56	45
8	14039.2	-50.83	6.3	13.75	Horizontal	-43.38	-13.00	30.38	0
9	15794.1	-49.09	6.7	13.85	Horizontal	-41.94	-13.00	28.94	0
10	17549.0	-47.73	6.8	14.25	Horizontal	-40.28	-13.00	27.28	270

Note: 1.The other Spurious RF Radiated emissions level is no more than noise floor.

2. The worst emission was found in the antenna is Horizontal position.

## NB-IOT Band 12 15kHz QPSK CH-Low

Harmonic	Frequency (MHz)	SG (dBm)	Cable Loss (dB)	Gain (dBi)	Antenna Polarization	ERP Level (dBm)	Limit (dBm)	Margin (dB)	Azimuth (deg)
2	1398.2	-49.80	2.00	10.15	Horizontal	-43.80	-13.00	30.80	225
3	2097.3	-52.40	2.50	11.35	Horizontal	-45.70	-13.00	32.70	90
4	2796.4	-59.40	4.20	10.85	Horizontal	-54.90	-13.00	41.90	0
5	3495.5	-56.80	5.20	11.35	Horizontal	-52.80	-13.00	39.80	45
6	4194.6	-55.90	5.50	11.95	Horizontal	-51.60	-13.00	38.60	90
7	4893.7	-55.20	5.70	13.55	Horizontal	-49.50	-13.00	36.50	315
8	5592.8	-55.30	6.30	13.75	Horizontal	-50.00	-13.00	37.00	135
9	6291.9	-56.00	6.80	13.85	Horizontal	-51.10	-13.00	38.10	225
10	6991.0	-58.40	6.90	14.25	Horizontal	-53.20	-13.00	40.20	90

Note: 1.The other Spurious RF Radiated emissions level is no more than noise floor.

2. The worst emission was found in the antenna is Horizontal position.



## NB-IOT Band 12 15kHz QPSK CH-Middle

Harmonic	Frequency (MHz)	SG (dBm)	Cable Loss (dB)	Gain (dBi)	Antenna Polarization	ERP Level (dBm)	Limit (dBm)	Margin (dB)	Azimuth (deg)
2	1415.0	-48.70	2.00	10.75	Horizontal	-42.10	-13.00	29.10	90
3	2122.5	-56.79	2.51	11.05	Horizontal	-50.40	-13.00	37.40	225
4	2830.0	-58.40	4.20	11.15	Horizontal	-53.60	-13.00	40.60	90
5	3525.5	-56.00	5.20	11.15	Horizontal	-52.20	-13.00	39.20	225
6	4230.6	-54.60	5.50	11.95	Horizontal	-50.30	-13.00	37.30	135
7	4935.7	-55.60	5.70	13.55	Horizontal	-49.90	-13.00	36.90	270
8	5640.8	-55.20	6.30	13.75	Horizontal	-49.90	-13.00	36.90	315
9	6345.9	-54.50	6.80	13.85	Horizontal	-49.60	-13.00	36.60	45
10	7051.0	-56.17	6.90	14.25	Horizontal	-50.97	-13.00	37.97	180

Note: 1. The other Spurious RF Radiated emissions level is no more than noise floor.  
2. The worst emission was found in the antenna is Horizontal position.

## NB-IOT Band 12 15kHz QPSK CH-High

Harmonic	Frequency (MHz)	SG (dBm)	Cable Loss (dB)	Gain (dBi)	Antenna Polarization	ERP Level (dBm)	Limit (dBm)	Margin (dB)	Azimuth (deg)
2	1431.8	-47.20	2.00	10.15	Horizontal	-41.20	-13.00	28.20	45
3	2147.7	-59.09	2.51	11.05	Horizontal	-52.70	-13.00	39.70	90
4	2863.6	-60.50	4.20	11.15	Horizontal	-55.70	-13.00	42.70	225
5	3579.5	-56.60	5.20	11.15	Horizontal	-52.80	-13.00	39.80	0
6	4295.4	-54.10	5.50	11.95	Horizontal	-49.80	-13.00	36.80	0
7	5011.3	-55.80	5.70	13.55	Horizontal	-50.10	-13.00	37.10	90
8	5727.2	-55.40	6.30	13.75	Horizontal	-50.10	-13.00	37.10	45
9	6443.1	-55.40	6.80	13.85	Horizontal	-50.50	-13.00	37.50	135
10	7159.0	-56.60	6.90	14.25	Horizontal	-51.40	-13.00	38.40	225

Note: 1. The other Spurious RF Radiated emissions level is no more than noise floor.  
2. The worst emission was found in the antenna is Horizontal position.



## NB-IOT Band 13 15kHz QPSK CH-Low

Harmonic	Frequency (MHz)	SG (dBm)	Cable Loss (dB)	Gain (dBi)	Antenna Polarization	ERP Level (dBm)	Limit (dBm)	Margin (dB)	Azimuth (deg)
2	1554.2	-52.20	2.00	10.15	Horizontal	-46.20	-13.00	33.20	225
3	2331.3	-53.30	2.50	11.35	Horizontal	-46.60	-13.00	33.60	90
4	3108.4	-58.30	4.20	10.85	Horizontal	-53.80	-13.00	40.80	0
5	3885.5	-54.70	5.20	11.35	Horizontal	-50.70	-13.00	37.70	45
6	4662.6	-55.27	5.50	11.95	Horizontal	-50.97	-13.00	37.97	225
7	5439.7	-55.20	5.70	13.55	Horizontal	-49.50	-13.00	36.50	90
8	6216.8	-56.20	6.30	13.75	Horizontal	-50.90	-13.00	37.90	0
9	6993.9	-56.40	6.80	13.85	Horizontal	-51.50	-13.00	38.50	45
10	7771.0	-54.40	6.90	14.25	Horizontal	-49.20	-13.00	36.20	315

Note: 1.The other Spurious RF Radiated emissions level is no more than noise floor.

2. The worst emission was found in the antenna is Horizontal position.

## NB-IOT Band 13 15kHz QPSK CH-Middle

Harmonic	Frequency (MHz)	SG (dBm)	Cable Loss (dB)	Gain (dBi)	Antenna Polarization	EIRP Level (dBm)	Limit (dBm)	Margin (dB)	Azimuth (deg)
2	1564.0	-55.85	2.00	10.75	Horizontal	-47.10	-40.00	7.10	90
Harmonic	Frequency (MHz)	SG (dBm)	Cable Loss (dB)	Gain (dBi)	Antenna Polarization	ERP Level (dBm)	Limit (dBm)	Margin (dB)	Azimuth (deg)
3	2346.0	-53.19	2.51	11.05	Horizontal	-46.80	-13.00	33.80	0
4	3128.0	-56.70	4.20	11.15	Horizontal	-51.90	-13.00	38.90	0
5	3910.0	-55.50	5.20	11.15	Horizontal	-51.70	-13.00	38.70	270
6	4692.0	-55.00	5.50	11.95	Horizontal	-50.70	-13.00	37.70	225
7	5474.0	-55.40	5.70	13.55	Horizontal	-49.70	-13.00	36.70	135
8	6256.0	-56.29	6.30	13.75	Horizontal	-50.99	-13.00	37.99	90
9	7038.0	-55.10	6.80	13.85	Horizontal	-50.20	-13.00	37.20	45
10	7820.0	-54.60	6.90	14.25	Horizontal	-49.40	-13.00	36.40	270

Note: 1.The other Spurious RF Radiated emissions level is no more than noise floor.

2. The worst emission was found in the antenna is Horizontal position.



## NB-IOT Band 13 15kHz QPSK CH-High

Harmonic	Frequency (MHz)	SG (dBm)	Cable Loss (dB)	Gain (dBi)	Antenna Polarization	EIRP Level (dBm)	Limit (dBm)	Margin (dB)	Azimuth (deg)
2	1573.8	-55.45	2.00	10.15	Horizontal	-47.30	-40.00	7.30	225
Harmonic	Frequency (MHz)	SG (dBm)	Cable Loss (dB)	Gain (dBi)	Antenna Polarization	ERP Level (dBm)	Limit (dBm)	Margin (dB)	Azimuth (deg)
3	2360.7	-55.49	2.51	11.05	Horizontal	-49.10	-13.00	36.10	135
4	3147.6	-56.00	4.20	11.15	Horizontal	-51.20	-13.00	38.20	225
5	3934.5	-55.30	5.20	11.15	Horizontal	-51.50	-13.00	38.50	135
6	4721.4	-54.60	5.50	11.95	Horizontal	-50.30	-13.00	37.30	0
7	5508.3	-56.10	5.70	13.55	Horizontal	-50.40	-13.00	37.40	45
8	6295.2	-56.20	6.30	13.75	Horizontal	-50.90	-13.00	37.90	315
9	7082.1	-56.10	6.80	13.85	Horizontal	-51.20	-13.00	38.20	45
10	7869.0	-53.60	6.90	14.25	Horizontal	-48.40	-13.00	35.40	270

Note: 1. The other Spurious RF Radiated emissions level is no more than noise floor.  
2. The worst emission was found in the antenna is Horizontal position.

## NB-IOT Band 66 15kHz QPSK CH-Low

Harmonic	Frequency (MHz)	SG (dBm)	Cable Loss (dB)	Gain (dBi)	Antenna Polarization	EIRP Level (dBm)	Limit (dBm)	Margin (dB)	Azimuth (deg)
2	3420.2	-40.54	2.6	10.15	Horizontal	-32.99	-13.00	19.99	0
3	5130.3	-59.15	2.4	11.35	Horizontal	-50.20	-13.00	37.20	45
4	6840.4	-58.65	4.5	10.85	Horizontal	-52.30	-13.00	39.30	315
5	8550.5	-54.25	5.1	11.35	Horizontal	-48.00	-13.00	35.00	180
6	10260.6	-50.55	5.3	11.95	Horizontal	-43.90	-13.00	30.90	270
7	11970.7	-51.35	5.5	13.55	Horizontal	-43.30	-13.00	30.30	45
8	13680.8	-48.85	6.3	13.75	Horizontal	-41.40	-13.00	28.40	90
9	15390.9	-47.55	6.7	13.85	Horizontal	-40.40	-13.00	27.40	225
10	17101.0	-46.65	6.8	14.25	Horizontal	-39.20	-13.00	26.20	315

Note: 1. The other Spurious RF Radiated emissions level is no more than noise floor.  
2. The worst emission was found in the antenna is Horizontal position.



## NB-IOT Band 66 15kHz QPSK CH-Middle

Harmonic	Frequency (MHz)	SG (dBm)	Cable Loss (dB)	Gain (dBi)	Antenna Polarization	EIRP Level (dBm)	Limit (dBm)	Margin (dB)	Azimuth (deg)
2	3510.0	-44.65	2.6	10.75	Horizontal	-36.50	-13.00	23.50	180
3	5265.0	-54.95	2.4	11.05	Horizontal	-46.30	-13.00	33.30	135
4	7020.0	-56.95	4.5	11.15	Horizontal	-50.30	-13.00	37.30	0
5	8775.0	-54.75	5.1	11.35	Horizontal	-48.50	-13.00	35.50	90
6	10530.0	-51.63	5.3	11.95	Horizontal	-44.98	-13.00	31.98	45
7	12285.0	-51.42	5.5	13.55	Horizontal	-43.37	-13.00	30.37	315
8	14040.0	-49.44	6.3	13.75	Horizontal	-41.99	-13.00	28.99	45
9	15795.0	-48.25	6.7	13.85	Horizontal	-41.10	-13.00	28.10	225
10	17550.0	-47.95	6.8	14.25	Horizontal	-40.50	-13.00	27.50	90

Note: 1. The other Spurious RF Radiated emissions level is no more than noise floor.

2. The worst emission was found in the antenna is Horizontal position.

## NB-IOT Band 66 15kHz QPSK CH-High

Harmonic	Frequency (MHz)	SG (dBm)	Cable Loss (dB)	Gain (dBi)	Antenna Polarization	EIRP Level (dBm)	Limit (dBm)	Margin (dB)	Azimuth (deg)
2	3559.8	-50.65	2.6	10.15	Horizontal	-43.10	-13.00	30.10	270
3	5339.7	-56.25	2.4	11.05	Horizontal	-47.60	-13.00	34.60	135
4	7119.6	-57.85	4.5	11.15	Horizontal	-51.20	-13.00	38.20	225
5	8899.5	-53.85	5.1	11.35	Horizontal	-47.60	-13.00	34.60	90
6	10679.4	-52.35	5.3	11.95	Horizontal	-45.70	-13.00	32.70	0
7	12459.3	-52.25	5.5	13.55	Horizontal	-44.20	-13.00	31.20	0
8	14239.2	-49.15	6.3	13.75	Horizontal	-41.70	-13.00	28.70	45
9	16019.1	-48.15	6.7	13.85	Horizontal	-41.00	-13.00	28.00	315
10	17799.0	-48.25	6.8	14.25	Horizontal	-40.80	-13.00	27.80	225

Note: 1. The other Spurious RF Radiated emissions level is no more than noise floor.

2. The worst emission was found in the antenna is Horizontal position.



## NB-IOT Band 71 15kHz QPSK CH-Low

Harmonic	Frequency (MHz)	SG (dBm)	Cable Loss (dB)	Gain (dBi)	Antenna Polarization	ERP Level (dBm)	Limit (dBm)	Margin (dB)	Azimuth (deg)
2	1326.2	-52.60	2.6	10.15	Horizontal	-47.20	-13.00	34.20	45
3	1989.3	-53.20	2.4	11.35	Horizontal	-46.40	-13.00	33.40	225
4	2652.4	-58.50	4.5	10.85	Horizontal	-54.30	-13.00	41.30	90
5	3315.5	-57.90	5.1	11.35	Horizontal	-53.80	-13.00	40.80	270
6	3978.6	-55.40	5.3	11.95	Horizontal	-50.90	-13.00	37.90	315
7	4641.7	-56.70	5.5	13.55	Horizontal	-50.80	-13.00	37.80	90
8	5304.8	-55.70	6.3	13.75	Horizontal	-50.40	-13.00	37.40	225
9	5967.9	-55.80	6.7	13.85	Horizontal	-50.80	-13.00	37.80	45
10	6631.0	-57.27	6.8	14.25	Horizontal	-51.97	-13.00	38.97	135

Note: 1.The other Spurious RF Radiated emissions level is no more than noise floor.

2. The worst emission was found in the antenna is Horizontal position.

## NB-IOT Band 71 15kHz QPSK CH-Middle

Harmonic	Frequency (MHz)	SG (dBm)	Cable Loss (dB)	Gain (dBi)	Antenna Polarization	ERP Level (dBm)	Limit (dBm)	Margin (dB)	Azimuth (deg)
2	1361.0	-52.40	2.6	10.75	Horizontal	-46.40	-13.00	33.40	0
3	2041.5	-52.10	2.4	11.05	Horizontal	-45.60	-13.00	32.60	180
4	2722.0	-58.40	4.5	11.15	Horizontal	-53.90	-13.00	40.90	315
5	3402.5	-57.30	5.1	11.35	Horizontal	-53.20	-13.00	40.20	45
6	4083.0	-56.10	5.3	11.95	Horizontal	-51.60	-13.00	38.60	135
7	4763.5	-56.30	5.5	13.55	Horizontal	-50.40	-13.00	37.40	180
8	5444.0	-55.40	6.3	13.75	Horizontal	-50.10	-13.00	37.10	90
9	6124.5	-55.90	6.7	13.85	Horizontal	-50.90	-13.00	37.90	45
10	6805.0	-57.80	6.8	14.25	Horizontal	-52.50	-13.00	39.50	225

Note: 1.The other Spurious RF Radiated emissions level is no more than noise floor.

2. The worst emission was found in the antenna is Horizontal position.



## NB-IOT Band 71 15kHz QPSK CH-High

Harmonic	Frequency (MHz)	SG (dBm)	Cable Loss (dB)	Gain (dBi)	Antenna Polarization	ERP Level (dBm)	Limit (dBm)	Margin (dB)	Azimuth (deg)
2	1395.8	-47.20	2.6	10.15	Horizontal	-41.80	-13.00	28.80	45
3	2093.7	-52.40	2.4	11.05	Horizontal	-45.90	-13.00	32.90	225
4	2791.6	-59.00	4.5	11.15	Horizontal	-54.50	-13.00	41.50	90
5	3489.5	-57.50	5.1	11.35	Horizontal	-53.40	-13.00	40.40	225
6	4187.4	-56.30	5.3	11.95	Horizontal	-51.80	-13.00	38.80	0
7	4885.3	-56.10	5.5	13.55	Horizontal	-50.20	-13.00	37.20	90
8	5583.2	-55.10	6.3	13.75	Horizontal	-49.80	-13.00	36.80	45
9	6281.1	-55.70	6.7	13.85	Horizontal	-50.70	-13.00	37.70	135
10	6979.0	-58.00	6.8	14.25	Horizontal	-52.70	-13.00	39.70	270

Note: 1.The other Spurious RF Radiated emissions level is no more than noise floor.

2. The worst emission was found in the antenna is Horizontal position.

## NB-IOT Band 85 15kHz QPSK CH-Low

Harmonic	Frequency (MHz)	SG (dBm)	Cable Loss (dB)	Gain (dBi)	Antenna Polarization	ERP Level (dBm)	Limit (dBm)	Margin (dB)	Azimuth (deg)
2	1396.2	-49.10	2.6	10.15	Horizontal	-43.70	-13.00	30.70	135
3	2094.3	-53.00	2.4	11.35	Horizontal	-46.20	-13.00	33.20	225
4	2792.4	-58.30	4.5	10.85	Horizontal	-54.10	-13.00	41.10	315
5	3490.5	-55.80	5.1	11.35	Horizontal	-51.70	-13.00	38.70	180
6	4188.6	-56.60	5.3	11.95	Horizontal	-52.10	-13.00	39.10	270
7	4886.7	-56.20	5.5	13.55	Horizontal	-50.30	-13.00	37.30	90
8	5584.8	-55.86	6.3	13.75	Horizontal	-50.56	-13.00	37.56	0
9	6282.9	-56.30	6.7	13.85	Horizontal	-51.30	-13.00	38.30	45
10	6981.0	-58.25	6.8	14.25	Horizontal	-52.95	-13.00	39.95	135

Note: 1.The other Spurious RF Radiated emissions level is no more than noise floor.

2. The worst emission was found in the antenna is Horizontal position.





## NB-IOT Band 85 15kHz QPSK CH-Middle

Harmonic	Frequency (MHz)	SG (dBm)	Cable Loss (dB)	Gain (dBi)	Antenna Polarization	ERP Level (dBm)	Limit (dBm)	Margin (dB)	Azimuth (deg)
2	1414.0	-48.20	2.6	10.75	Horizontal	-42.20	-13.00	29.20	135
3	2121.0	-55.90	2.4	11.05	Horizontal	-49.40	-13.00	36.40	225
4	2828.0	-60.00	4.5	11.15	Horizontal	-55.50	-13.00	42.50	90
5	3535.0	-57.40	5.1	11.35	Horizontal	-53.30	-13.00	40.30	0
6	4242.0	-54.40	5.3	11.95	Horizontal	-49.90	-13.00	36.90	90
7	4949.0	-55.30	5.5	13.55	Horizontal	-49.40	-13.00	36.40	45
8	5656.0	-55.90	6.3	13.75	Horizontal	-50.60	-13.00	37.60	135
9	6363.0	-56.60	6.7	13.85	Horizontal	-51.60	-13.00	38.60	180
10	7070.0	-55.50	6.8	14.25	Horizontal	-50.20	-13.00	37.20	315

Note: 1. The other Spurious RF Radiated emissions level is no more than noise floor.

2. The worst emission was found in the antenna is Horizontal position.

## NB-IOT Band 85 15kHz QPSK CH-High

Harmonic	Frequency (MHz)	SG (dBm)	Cable Loss (dB)	Gain (dBi)	Antenna Polarization	ERP Level (dBm)	Limit (dBm)	Margin (dB)	Azimuth (deg)
2	1431.8	-47.10	2.6	10.15	Horizontal	-41.70	-13.00	28.70	135
3	2147.7	-59.60	2.4	11.05	Horizontal	-53.10	-13.00	40.10	45
4	2863.6	-60.20	4.5	11.15	Horizontal	-55.70	-13.00	42.70	90
5	3579.5	-57.50	5.1	11.35	Horizontal	-53.40	-13.00	40.40	0
6	4295.4	-53.20	5.3	11.95	Horizontal	-48.70	-13.00	35.70	90
7	5011.3	-56.30	5.5	13.55	Horizontal	-50.40	-13.00	37.40	45
8	5727.2	-55.80	6.3	13.75	Horizontal	-50.50	-13.00	37.50	315
9	6443.1	-56.96	6.7	13.85	Horizontal	-51.96	-13.00	38.96	45
10	7159.0	-56.90	6.8	14.25	Horizontal	-51.60	-13.00	38.60	90

Note: 1. The other Spurious RF Radiated emissions level is no more than noise floor.

2. The worst emission was found in the antenna is Horizontal position.



## 6 Main Test Instruments

Name	Manufacturer	Type	Serial Number	Calibration Date	Expiration Date
Base Station Simulator	R&S	CMW500	113824	2020-05-18	2021-05-17
Power Splitter	Hua Xiang	SHX-GF2-2-13	10120101	/	/
Spectrum Analyzer	Key sight	N9010A	MY50210259	2020-05-18	2021-05-17
Signal Analyzer	R&S	FSV30	100815	2019-12-15	2020-12-14
Loop Antenna	SCHWARZBECK	FMZB1519	1519-047	2017-09-26	2020-09-25
Trilog Antenna	SCHWARZBECK	VUBL 9163	9163-201	2017-11-18	2020-11-17
Horn Antenna	R&S	HF907	102723	2018-08-11	2021-08-10
Horn Antenna	ETS-Lindgren	3160-09	00102643	2018-06-20	2021-06-19
Signal generator	R&S	SMB 100A	102594	2020-05-18	2021-05-17
Climatic Chamber	ESPEC	SU-242	93000506	2017-12-17	2020-12-16
Preamplifier	R&S	SCU18	102327	2020-05-18	2021-05-17
MOB COMMS DC SUPPLY	Keysight	66319D	MY43004105	2020-05-18	2021-05-17
RF Cable	Agilent	SMA 15cm	0001	2019-12-13	2020-06-12
RF Cable	Agilent	SMA 15cm	0001	2020-06-12	2020-12-11
Software	R&S	EMC32	9.26.0	/	/

\*\*\*\*\*END OF REPORT \*\*\*\*\*