



RF TEST REPORT

Applicant Quectel Wireless Solutions Co., Ltd
FCC ID XMR202004BG600LM3
Product LTE Cat M1 & Cat NB2 & EGPRS Module
Brand Quectel
Model BG600L-M3
Report No. R2003A0168-R6V1
Issue Date July 21, 2020

TA Technology (Shanghai) Co., Ltd. tested the above equipment in accordance with the requirements in **FCC CFR47 Part 2 (2019)/ FCC CFR 47 Part 24E (2019)**. The test results show that the equipment tested is capable of demonstrating compliance with the requirements as documented in this report.

Performed by: Peng Tao

Approved by: Kai Xu

TA Technology (Shanghai) Co., Ltd.

No.145, Jintang Rd, Tangzhen Industry Park, Pudong Shanghai, China

TEL: +86-021-50791141/2/3

FAX: +86-021-50791141/2/3-8000



TABLE OF CONTENT

- 1. Test Laboratory4
 - 1.1. Notes of the test report.....4
 - 1.2. Test facility.....4
 - 1.3. Testing Location4
- 2. General Description of Equipment under Test.....5
 - 2.3. Applicant and Manufacturer Information5
 - 2.4. General information5
- 3. Applied Standards.....7
- 4. Test Configuration.....8
- 5. Test Case Results.....10
 - 5.1. RF Power Output and Effective Isotropic Radiated Power10
 - 5.2. Occupied Bandwidth14
 - 5.3. Band Edge Compliance.....24
 - 5.4. Peak-to-Average Power Ratio (PAPR)30
 - 5.5. Frequency Stability32
 - 5.6. Spurious Emissions at Antenna Terminals37
 - 5.7. Radiates Spurious Emission44
- 6. Main Test Instruments51



Summary of measurement results

No.	Test Case	Clause in FCC rules	Verdict
1	RF Power Output and Effective Isotropic Radiated Power	2.1046 24.232(c)	PASS
2	Occupied Bandwidth	2.1049	PASS
3	Band Edge Compliance	2.1051 /24.238(a)	PASS
4	Peak-to-Average Power Ratio	24.232/KDB 971168 D01(5.7)	PASS
5	Frequency Stability	2.1055 / 24.235	PASS
6	Spurious Emissions at Antenna Terminals	2.1051 / 24.238(a)	PASS
7	Radiates Spurious Emission	2.1053 / 24.238(a)	PASS
Date of Testing: April 20, 2020~ May 21, 2020 and June 8, 2020			
<p>Note: PASS: The EUT complies with the essential requirements in the standard. FAIL: The EUT does not comply with the essential requirements in the standard. All indications of Pass/Fail in this report are opinions expressed by TA Technology (Shanghai) Co., Ltd. based on interpretations and/or observations of test results. Measurement Uncertainties were not taken into account and are published for informational purposes only.</p>			

Version	Revision description	Issue Date
Rev.0	/	June 18, 2020
Rev.1	Update RF Power Output data in Page 13	July 21, 2020
<p>Note: This revised report (Report No.: R2003A0168-R6V1) supersedes and replaces the previously issued report (Report No.: R2003A0168-R6). Please discard or destroy the previously issued report and dispose of it accordingly.</p>		

1. Test Laboratory

1.1. Notes of the test report

This report shall not be reproduced in full or partial, without the written approval of **TA technology (shanghai) co., Ltd.** The results documented in this report apply only to the tested sample, under the conditions and modes of operation as described herein. Measurement Uncertainties were not taken into account and are published for informational purposes only. This report is written to support regulatory compliance of the applicable standards stated above.

1.2. Test facility

FCC (Designation number: CN1179, Test Firm Registration Number: 446626)

TA Technology (Shanghai) Co., Ltd. has been listed on the US Federal Communications Commission list of test facilities recognized to perform electromagnetic emissions measurements.

A2LA (Certificate Number: 3857.01)

TA Technology (Shanghai) Co., Ltd. has been listed by American Association for Laboratory Accreditation to perform electromagnetic emission measurement.

1.3. Testing Location

Company: TA Technology (Shanghai) Co., Ltd.
Address: No.145, Jintang Rd, Tangzhen Industry Park, Pudong
City: Shanghai
Post code: 201201
Country: P. R. China
Contact: Xu Kai
Telephone: +86-021-50791141/2/3
Fax: +86-021-50791141/2/3-8000
Website: <http://www.ta-shanghai.com>
E-mail: xukai@ta-shanghai.com

2. General Description of Equipment under Test

2.3. Applicant and Manufacturer Information

Applicant	Quectel Wireless Solutions Co., Ltd
Applicant address	Building 5, Shanghai Business Park Phase III (Area B), No.1016 Tianlin Road, Minhang District, Shanghai, China 200233
Manufacturer	Quectel Wireless Solutions Co., Ltd
Manufacturer address	Building 5, Shanghai Business Park Phase III (Area B), No.1016 Tianlin Road, Minhang District, Shanghai, China 200233

2.4. General information

EUT Description			
Model	BG600L-M3		
IMEI	860873040012816		
Hardware Version	R1.2		
Software Version	BG600LM3LAR02A03		
Power Supply	External power supply		
Antenna Type	The EUT don't have standard Antenna, The Antenna used for testing in this report is the after-market accessory (Dipole Antenna)		
Antenna Gain	GSM1900	Low channel	1.25dBi
		Middle channel	1.38dBi
		High channel	1.59dBi
	NB-IOT Band 2	Low channel	1.25dBi
		Middle channel	1.38dBi
		High channel	1.59dBi
	NB-IOT Band 25	Low channel	1.25dBi
		Middle channel	1.38dBi
		High channel	1.36dBi
Test Mode(s)	GSM1900; NB-IOT Band 2/25;		
Test Modulation:	(GSM/ GPRS)GMSK, (EGPRS) GMSK/8PSK; (NB-IOT)BPSK, QPSK		
GPRS Multislot Class	33		
EGPRS Multislot Class	33		
Category	NB2		
Deployment:	stand-alone		
Sub-carrier spacing:	3.75KHz, 15KHz		
Ntones:	single-tone, multi-tone		
Maximum E.I.R.P	GSM 1900:	31.19dBm	
	NB-IOT Band 2:	23.66dBm	
	NB-IOT Band 25:	23.36dBm	



Rated Power Supply Voltage	3.8V		
Extreme Voltage	Minimum: 3.3V Maximum: 4.3V		
Extreme Temperature	Lowest: -40°C Highest: +85°C		
Operating Frequency Range(s)	Band	Tx (MHz)	Rx (MHz)
	GSM1900	1850 ~ 1910	1930 ~ 1990
	NB-IOT Band 2	1850 ~ 1910	1930 ~ 1990
	NB-IOT Band 25	1850 ~ 1915	1930 ~ 1995
Note: 1. The EUT is sent from the applicant to TA and the information of the EUT is declared by the applicant.			

3. Applied Standards

According to the specifications of the manufacturer, it must comply with the requirements of the following standards:

Test standards:

FCC CFR 47 Part 24E (2019)

ANSI C63.26 (2015)

Reference standard:

FCC CFR47 Part 2 (2019)

KDB 971168 D01 Power Meas License Digital Systems v03r01

4. Test Configuration

Radiated measurements are performed by rotating the EUT in three different orthogonal test planes. EUT stand-up position (Z axis), lie-down position (X, Y axis). Receiver antenna polarization (horizontal and vertical), the worst emission was found in position (X axis, horizontal polarization) and the worst case was recorded.

All modes as Subcarrier Spacing, modulations, Channel were investigated.

Subsequently, only the worst case emissions are reported.

The following testing in GSM/NB-IOT is set based on the maximum RF Output Power.

The following testing in different mode is set to detail in the following table:

Test modes are chosen to be reported as the worst case configuration below:

Test items	Modes/Modulation
	GSM 1900
RF Power Output and Effective Isotropic Radiated Power	GSM GPRS EGPRS
Occupied Bandwidth	GSM GPRS(1Tx slot) EGPRS(1Tx slot)
Band Edge Compliance	GSM GPRS(1Tx slot) EGPRS(1Tx slot)
Peak-to-Average Power Ratio	GSM GPRS(1Tx slot) EGPRS(1Tx slot)
Frequency Stability	GSM GPRS(1Tx slot) EGPRS(1Tx slot)
Spurious Emissions at Antenna Terminals	GSM
Radiates Spurious Emission	GSM



Test modes are chosen to be reported as the worst case configuration below for NB-IOT Band 2/25:

Test items		Deployment mode	Subcarrier Spacing (kHz)		Modulation		Test Channel		
		Stand-alone	3.75	15	BPSK	QPSK	L	M	H
RF Power Output and Effective Isotropic Radiated Power	NB-IOT Band 2	O	O	O	O	O	O	O	O
	NB-IOT Band 25	O	O	O	O	O	O	O	O
Occupied Bandwidth	NB-IOT Band 2	O	O	O	O	O	O	O	O
	NB-IOT Band 25	O	O	O	O	O	O	O	O
Band Edge Compliance	NB-IOT Band 2	O	O	O	O	O	O	-	O
	NB-IOT Band 25	O	O	O	O	O	O	-	O
Peak-to-Average Power Ratio	NB-IOT Band 2	O	O	O	O	O	-	O	-
	NB-IOT Band 25	O	O	O	O	O	-	O	-
Frequency Stability	NB-IOT Band 2	O	O	O	O	O	O	O	O
	NB-IOT Band 25	O	O	O	O	O	O	O	O
Conducted Spurious Emissions	NB-IOT Band 2	O	-	O	-	O	O	O	O
	NB-IOT Band 25	O	-	O	-	O	O	O	O
Radiates Spurious Emission	NB-IOT Band 2	O	-	O	-	O	O	O	O
	NB-IOT Band 25	O	-	O	-	O	O	O	O

Note

1. The mark "O" means that this configuration is chosen for testing.
2. The mark "-" means that this configuration is not testing.

5. Test Case Results

5.1.RF Power Output and Effective Isotropic Radiated Power

Ambient condition

Temperature	Relative humidity	Pressure
23°C ~25°C	45%~50%	101.5kPa

Methods of Measurement

During the process of the testing, The EUT is controlled by the Base Station Simulator to ensure max power transmission and proper modulation.

The testing follows FCC KDB 971168 v03r01 Section 5.8 and ANSI C63.26 (2015).

- a) Connect the equipment as illustrated. Mount the equipment with the manufacturer specified antenna in a vertical orientation on a manufacturer specified mounting surface located on a non-conducting rotating platform of a RF anechoic chamber (preferred) or a standard radiation site.
- b) Key the transmitter, then rotate the EUT 360° azimuthally and record spectrum analyzer power level (LVL) measurements at angular increments that are sufficiently small to permit resolution of all peaks. If a standard radiation test site is used, raise and lower the test antenna to obtain a maximum reading at each angular increment. (Note: several batteries may be needed to offset the effect of battery voltage droop, which should not exceed 5% of the manufactured specified battery voltage during transmission).
- c) Replace the transmitter under test with a vertically polarized half-wave dipole (or an antenna whose gain is known relative to an ideal half-wave dipole). The center of the antenna should be at the same location as the center of the antenna under test.
- d) Connect the antenna to a signal generator with a known output power and record the path loss (in dB) as LOSS. If a standard radiation test site is used, raise and lower the test antenna to obtain a maximum reading. $LOSS = \text{Generator Output Power (dBm)} - \text{Analyzer reading (dBm)}$
- e) Determine the effective radiated output power at each angular position from the readings in steps b) and d) using the following equation: $ERP \text{ (dBm)} = \text{LVL (dBm)} + \text{LOSS (dB)}$
- f) The maximum ERP is the maximum value determined in the preceding step.
- g) When calculating ERP, in addition to knowing the antenna radiation and matching characteristics, it is necessary to know the loss values of all elements (e.g.transmission line attenuation, mismatches, filters, combiners) interposed between the point where transmitter output power is measured, and the point where power is applied to the antenna. ERP can then be calculated as follows:
 $EIRP \text{ (dBm)} = \text{Output Power (dBm)} - \text{Losses (dB)} + \text{Antenna Gain (dBi)}$
where:dBd refers to gain relative to an ideal dipole.
 $EIRP \text{ (dBm)} = ERP \text{ (dBm)} + 2.15 \text{ (dB.)}$

The RB allocation refers to section 5.1, using the maximum output power configuration.

Test Setup

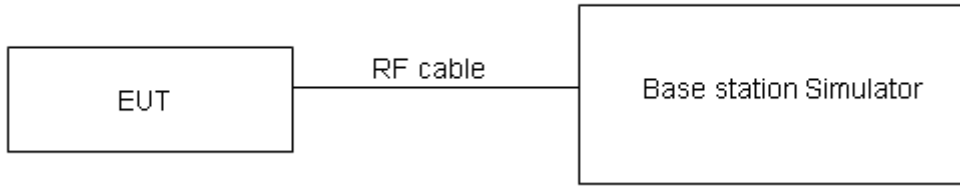

The loss between RF output port of the EUT and the input port of the tester has been taken into consideration.

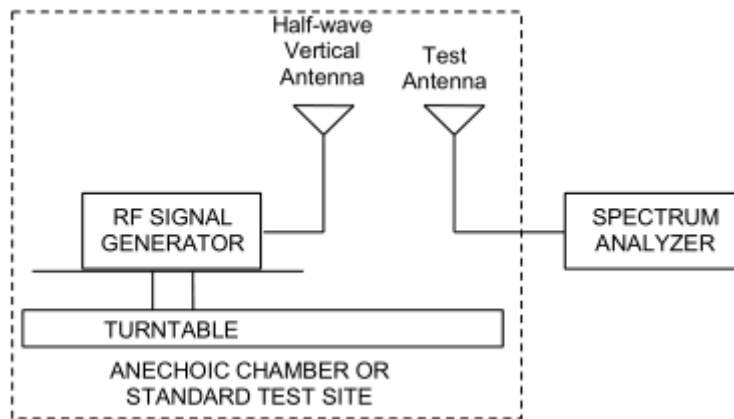
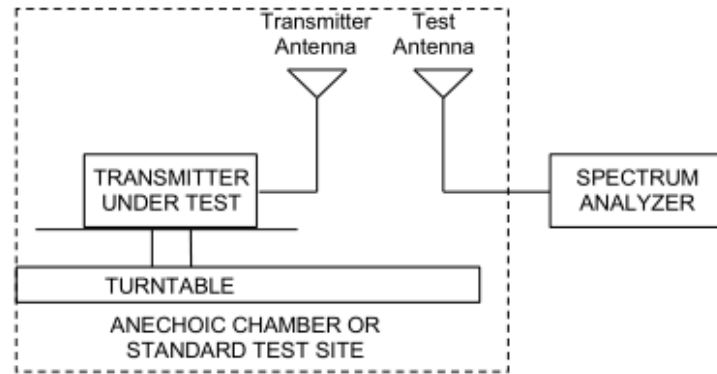

Limits

No specific RF power output requirements in part 2.1046.

Rule Part 24.232(c) Mobile and portable stations are limited to 2 watts EIRP.

Rule Part 24.232(e) Peak transmit power must be measured over any interval of continuous transmission using instrumentation calibrated in terms of an rms-equivalent voltage.

Limit	$\leq 2\text{ W (33 dBm)}$
-------	----------------------------

**Measurement Uncertainty**

The assessed measurement uncertainty to ensure 95% confidence level for the normal distribution is with the coverage factor $k = 2$, $U = 0.4$ dB for RF power output, $k = 2$, $U = 1.19$ dB for EIRP.



Test Results

GSM 1900		Conducted Power (dBm)			EIRP (dBm)		
		Channel 512	Channel 661	Channel 810	Channel 512	Channel 661	Channel 810
		1850.2 (MHz)	1880 (MHz)	1909.8 (MHz)	1850.2 (MHz)	1880 (MHz)	1909.8 (MHz)
GSM(GMSK)	Results	29.13	29.32	29.05	30.38	30.70	30.64
GPRS (GMSK)	1TXslot	29.42	29.52	29.60	30.67	30.90	31.19
	2TXslots	28.76	28.55	28.65	30.01	29.93	30.24
	3TXslots	27.23	26.96	27.41	28.48	28.34	29.00
	4TXslots	26.70	26.71	26.45	27.95	28.09	28.04
EGPRS (8PSK)	1TXslot	26.31	26.21	26.04	27.56	27.59	27.63
	2TXslots	24.40	24.34	24.20	25.65	25.72	25.79
	3TXslots	22.53	22.51	22.42	23.78	23.89	24.01
	4TXslots	21.46	21.32	21.17	22.71	22.70	22.76

Mode	Modulation	Sub-carrier spacing (KHz)	Ntones	Conducted Power (dBm) for low/middle/high channel			EIRP(dBm)				
				18602 /1850.2	18900 /1880.0	19198 /1909.8	18602 /1850.2	18900 /1880.0	19198 /1909.8		
NB-IOT Band 2 Standalone	BPSK	3.75	1@0	21.66	21.52	22.07	22.91	22.90	23.66		
			1@47	21.68	21.44	21.96	22.93	22.82	23.55		
		15	1@0	21.64	21.52	22.00	22.89	22.90	23.59		
			1@11	21.65	21.51	21.89	22.90	22.89	23.48		
	QPSK	3.75	1@0	21.67	21.58	22.06	22.92	22.96	23.65		
			1@47	21.62	21.51	21.95	22.87	22.89	23.54		
		15	1@0	21.67	21.56	21.93	22.92	22.94	23.52		
			1@11	21.69	21.44	21.84	22.94	22.82	23.43		
		15	12@0	19.79	19.61	19.89	21.04	20.99	21.48		
Mode	Modulation	Sub-carrier spacing (KHz)	Ntones	Conducted Power (dBm) for low/middle/high channel			EIRP(dBm)				
				26042 /1850.2	26365 /1882.5	26688 /1914.8	26042 /1850.2	26365 /1882.5	26688 /1914.8		
NB-IOT Band 25 Standalone	BPSK	3.75	1@0	21.47	21.41	21.87	22.72	22.79	23.23		
			1@47	21.39	21.36	21.88	22.64	22.74	23.24		
		15	1@0	21.59	21.63	21.93	22.84	23.01	23.29		
			1@11	21.57	21.43	22.00	22.82	22.81	23.36		
	QPSK	3.75	1@0	21.48	21.35	21.94	22.73	22.73	23.30		
			1@47	21.51	21.42	21.84	22.76	22.80	23.20		
		15	1@0	21.53	21.47	21.97	22.78	22.85	23.33		
			1@11	21.67	21.36	21.89	22.92	22.74	23.25		
				15	12@0	19.57	19.47	19.87	20.82	20.85	21.23

5.2.Occupied Bandwidth

Ambient condition

Temperature	Relative humidity	Pressure
23°C ~25°C	45%~50%	101.5kPa

Method of Measurement

The EUT was connected to Spectrum Analyzer and Base Station Simulator via power Splitter. The occupied bandwidth is measured using spectrum analyzer.

RBW is set to 3kHz, VBW is set to 10kHz for GSM

RBW is set to 2kHz, VBW is set to 6.2kHz for NB-IOT Band 2/25

99% power and -26dBc occupied bandwidths are recorded. Spectrum analyzer plots are included on the following pages.

Test Setup

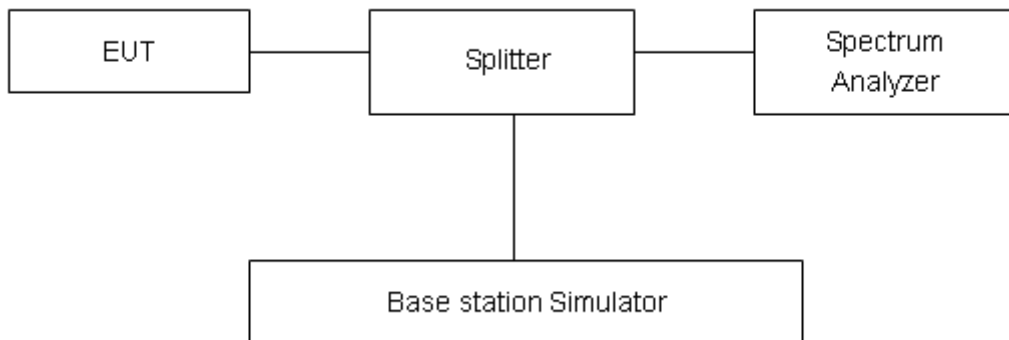

Limits

No specific occupied bandwidth requirements in part 2.1049.

Measurement Uncertainty

The assessed measurement uncertainty to ensure 95% confidence level for the normal distribution is with the coverage factor $k = 2$, $U = 624\text{Hz}$.

Test Result

Mode	Channel	Frequency (MHz)	99% Power Bandwidth (MHz)	-26dBc Bandwidth(MHz)
GSM 1900 (GMSK)	512	1850.2	0.2463	0.306
	661	1880.0	0.2445	0.300
	810	1909.8	0.2435	0.300
GPRS 1900 (GMSK)	512	1850.2	0.2446	0.317
	661	1880.0	0.2453	0.313
	810	1909.8	0.2440	0.307
EGPRS 1900 (8PSK)	512	1850.2	0.2474	0.310
	661	1880.0	0.2463	0.315
	810	1909.8	0.2440	0.307

Mode	Modulation	Sub-carrier spacing (KHz)	Ntones	Bandwidth(KHz) for low/middle/high channel					
				18602/1850.2		18900/1880.0		19198/1909.8	
				99% Power	-26dBc	99% Power	-26dBc	99% Power	-26dBc
NB-IOT Band 2 Standalone	BPSK	3.75	1@0	60.17	41.23	60.75	41.30	61.22	40.94
	QPSK	3.75	1@0	67.69	39.36	66.95	40.01	66.45	39.92
	BPSK	15	1@0	125.93	112.50	125.50	105.90	124.38	104.00
	QPSK	15	1@0	117.38	117.40	122.40	131.30	117.23	117.80
	QPSK	15	12@0	183.58	252.00	184.17	237.40	183.93	250.50
Mode	Modulation	Sub-carrier spacing (KHz)	Ntones	Bandwidth(KHz) for low/middle/high channel					
				26042/1850.2		26365/1882.5		26688/1914.8	
				99% Power	-26dBc	99% Power	-26dBc	99% Power	-26dBc
NB-IOT Band 25 Standalone	BPSK	3.75	1@0	61.82	40.93	60.32	41.10	61.16	41.14
	QPSK	3.75	1@0	68.91	40.12	69.13	39.22	67.87	39.76
	BPSK	15	1@0	127.63	104.60	119.91	103.10	126.37	111.80
	QPSK	15	1@0	117.34	104.10	114.80	104.10	116.11	104.30
	QPSK	15	12@0	184.92	250.40	184.04	239.60	183.56	251.90

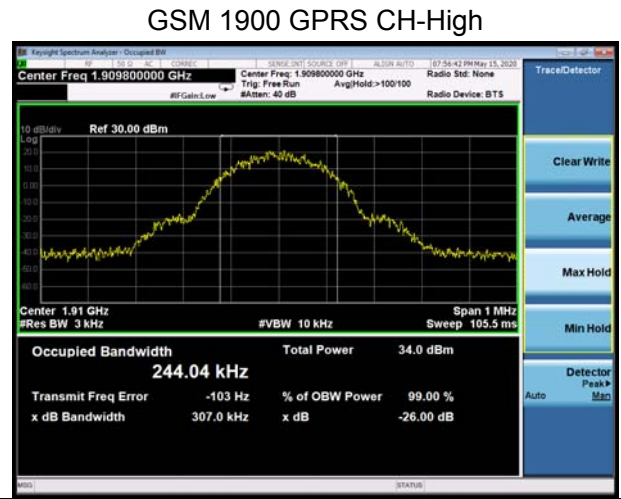
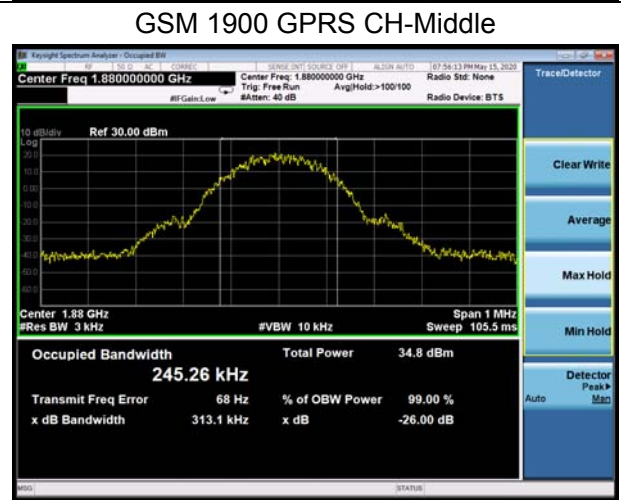
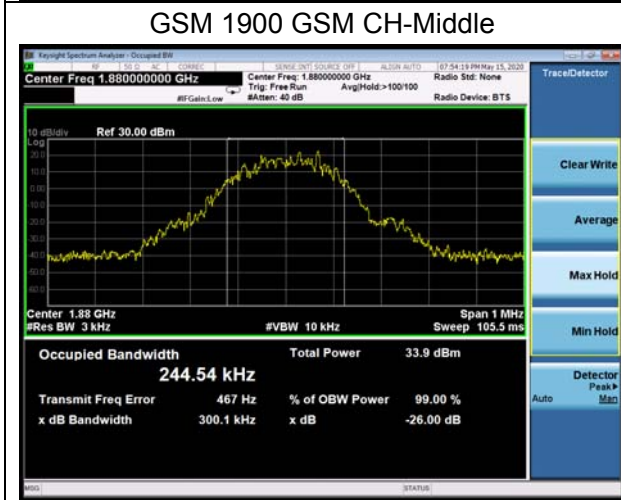
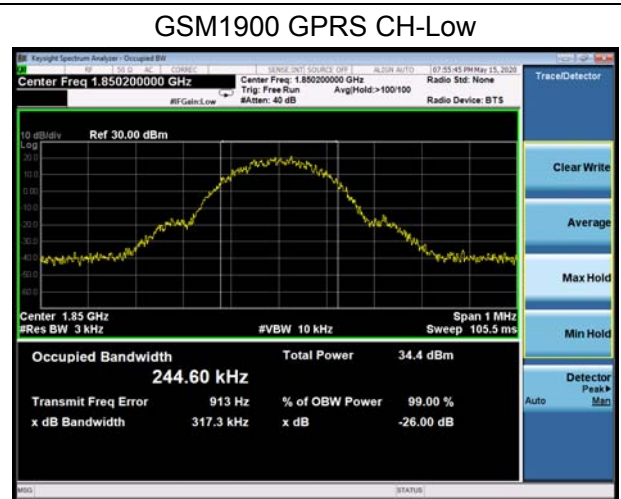
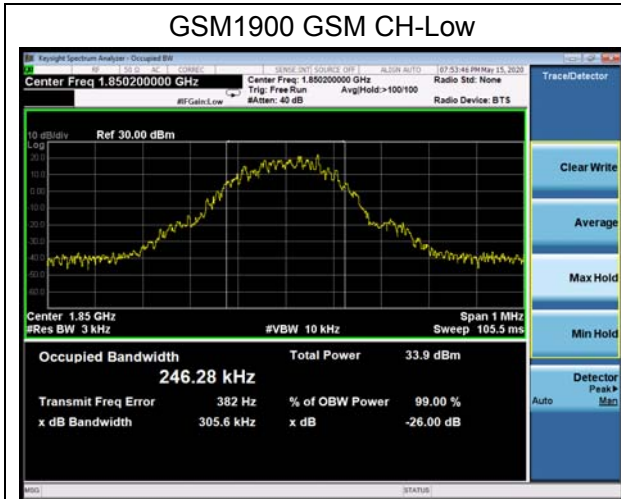

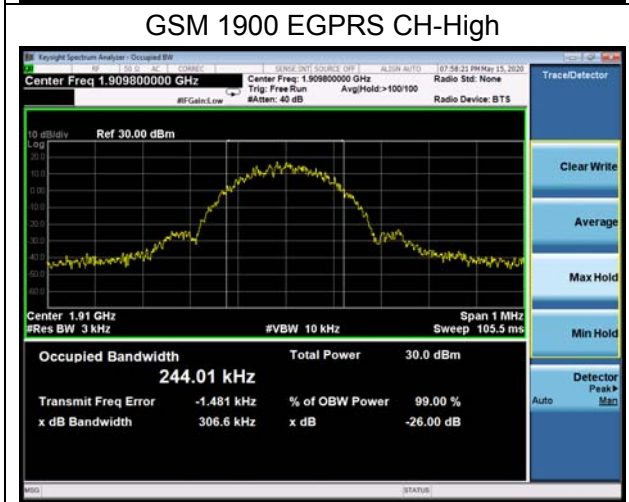
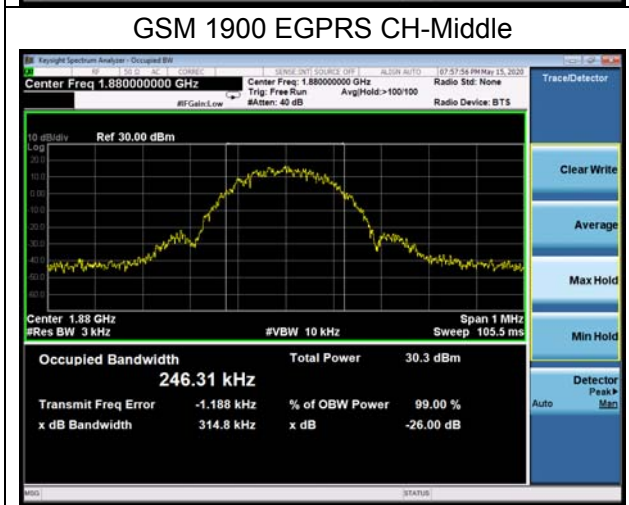
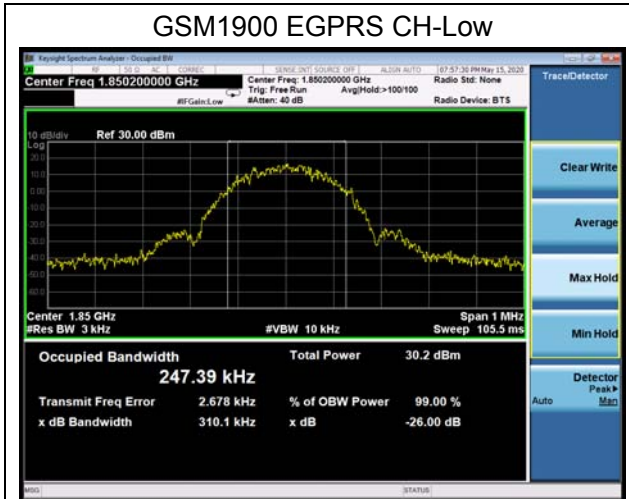

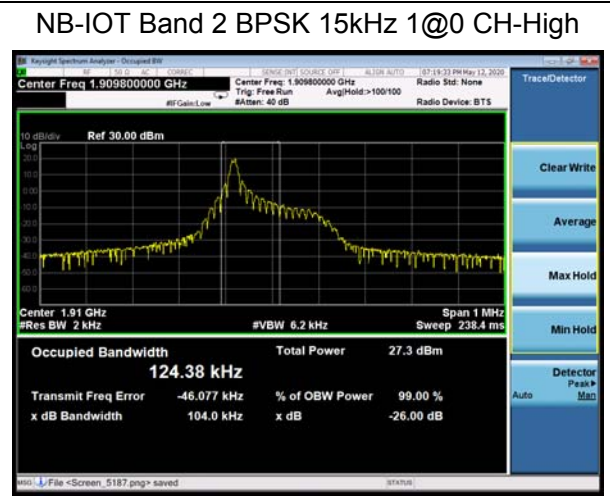
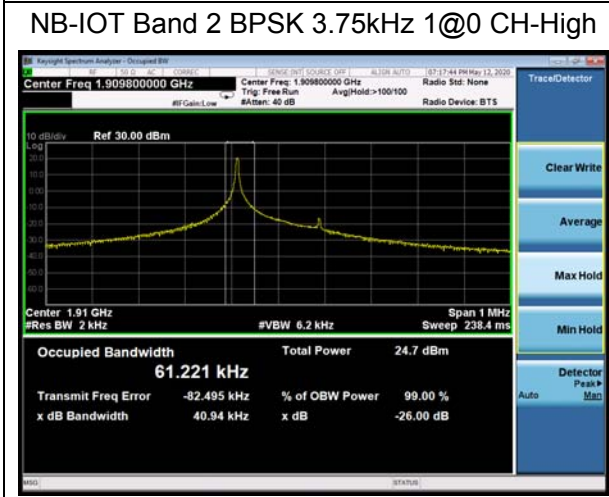
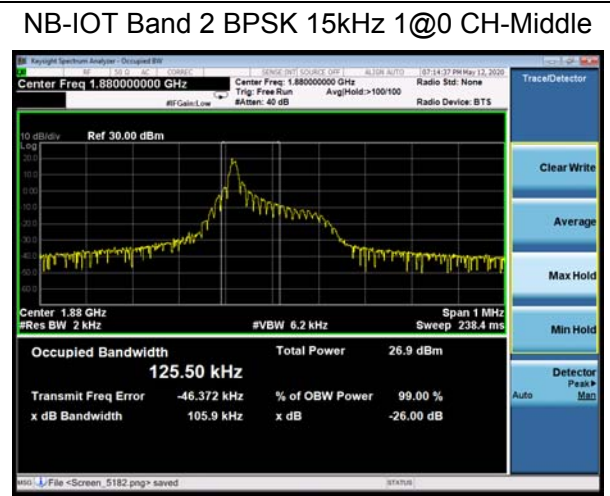
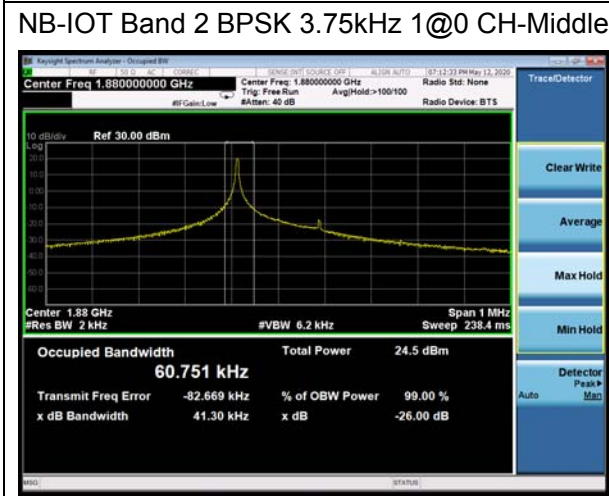
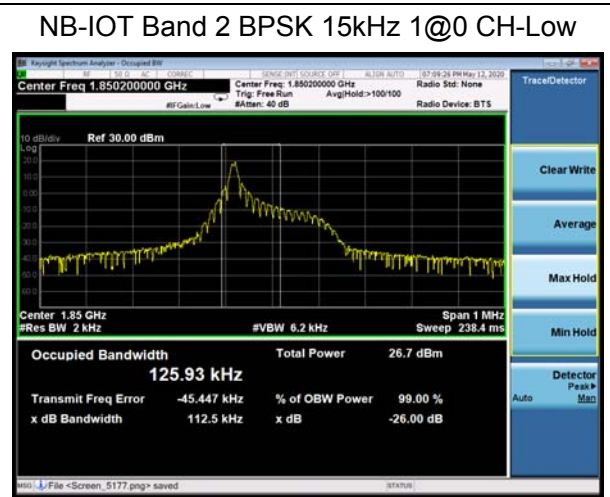
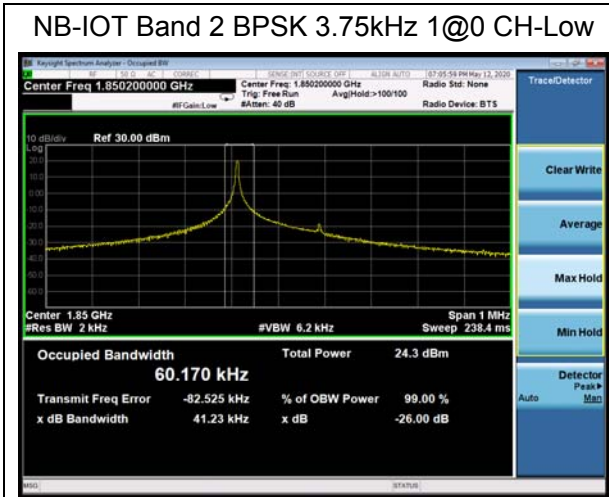

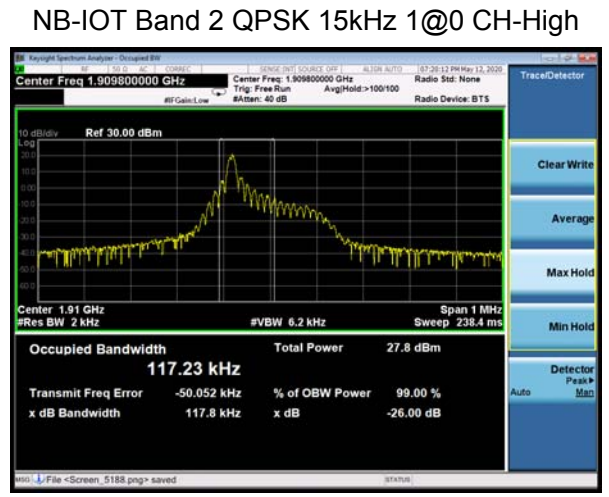
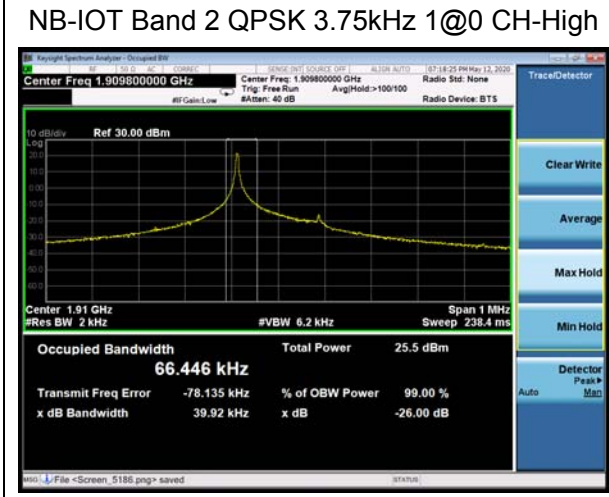
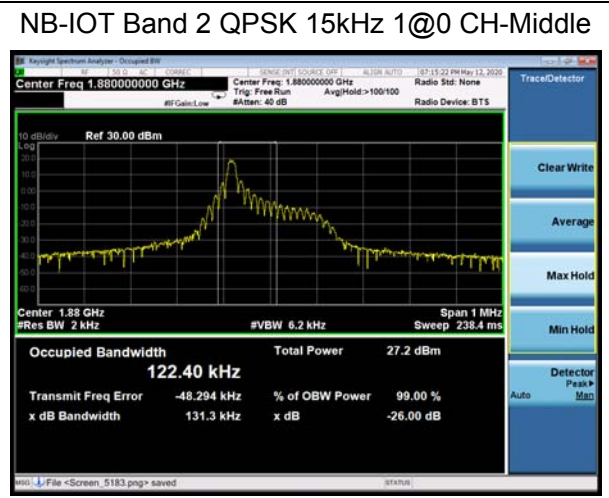
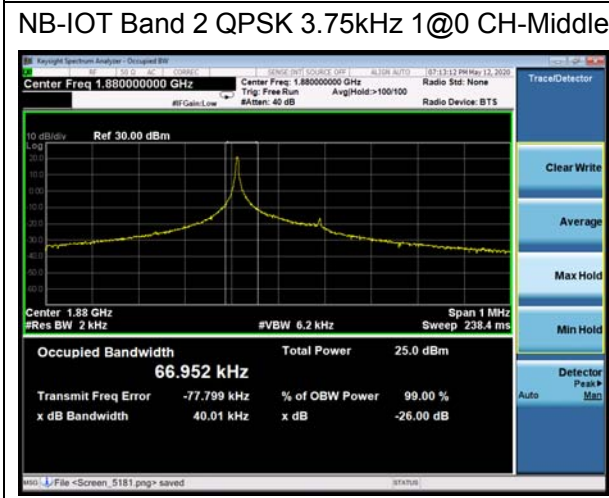
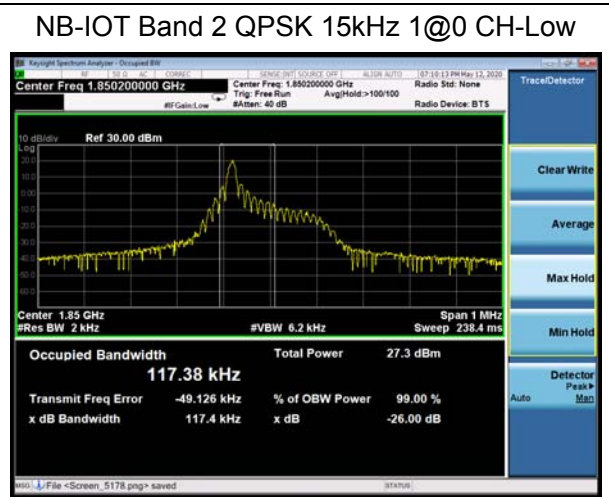
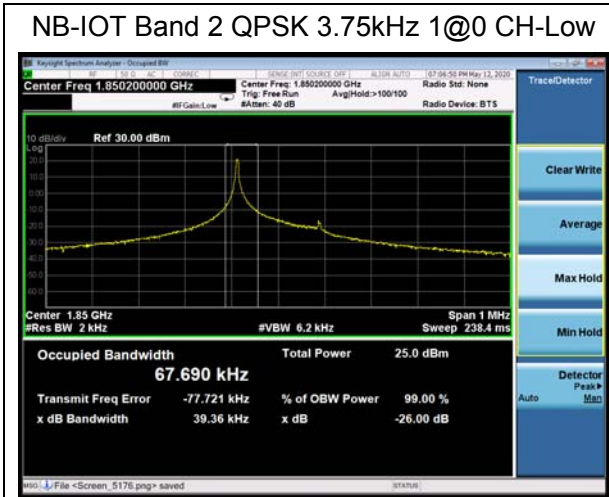

NB-IOT Band 2 QPSK 15kHz 12@0 CH-Low



NB-IOT Band 2 QPSK 15kHz 12@0 CH-Middle



NB-IOT Band 2 QPSK 15kHz 12@0 CH-High



NB-IOT Band 25 BPSK 3.75kHz 1@0 CH-Low



NB-IOT Band 25 BPSK 15kHz 1@0 CH-Low



NB-IOT Band 25 BPSK 3.75kHz 1@0 CH-Middle

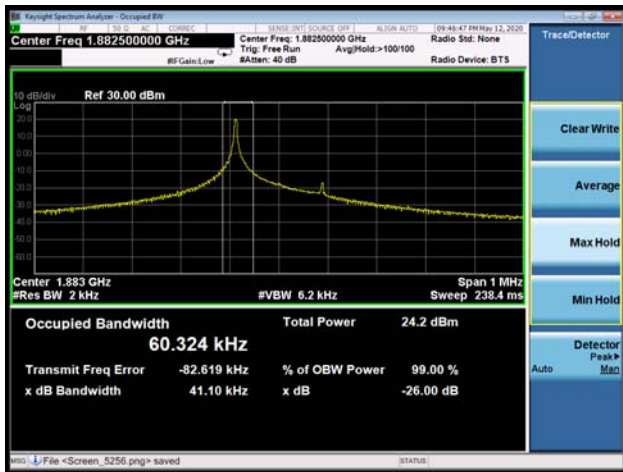

NB-IOT Band 25 BPSK 15kHz 1@0 CH-Middle



NB-IOT Band 25 BPSK 3.75kHz 1@0 CH-High

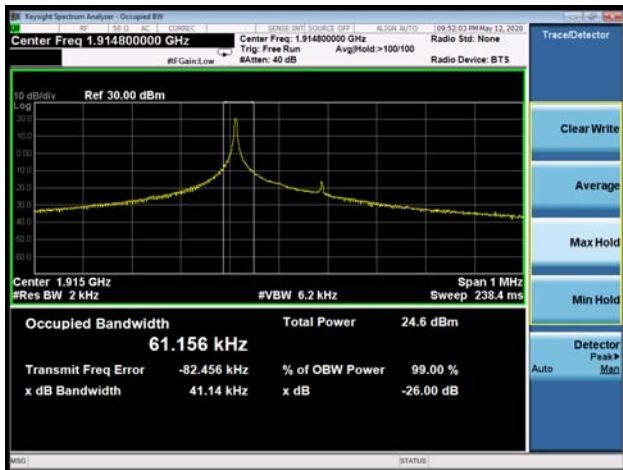

NB-IOT Band 25 BPSK 15kHz 1@0 CH-High



NB-IOT Band 25 QPSK 3.75kHz 1@0 CH-Low



NB-IOT Band 25 QPSK 15kHz 1@0 CH-Low



NB-IOT Band 25 QPSK 3.75kHz 1@0 CH-Middle



NB-IOT Band 25 QPSK 15kHz 1@0 CH-Middle



NB-IOT Band 25 QPSK 3.75kHz 1@0 CH-High



NB-IOT Band 25 QPSK 15kHz 1@0 CH-High



NB-IOT Band 25 QPSK 15kHz 12@0 CH-Low



NB-IOT Band 25 QPSK 15kHz 12@0 CH-Middle



NB-IOT Band 25 QPSK 15kHz 12@0 CH-High



5.3. Band Edge Compliance

Ambient condition

Temperature	Relative humidity	Pressure
23°C ~25°C	45%~50%	101.5kPa

Method of Measurement

The EUT was connected to Spectrum Analyzer and Base Station Simulator via power Splitter. The band edge of the lowest and highest channels were measured. The Average detector is used and RBW is set to 3kHz, VBW is set to 10kHz for GSM 1900
 RBW is set to $\geq 1\%EBW$, VBW is set to 3x RBW.

Spectrum analyzer plots are included on the following pages.

Test Setup

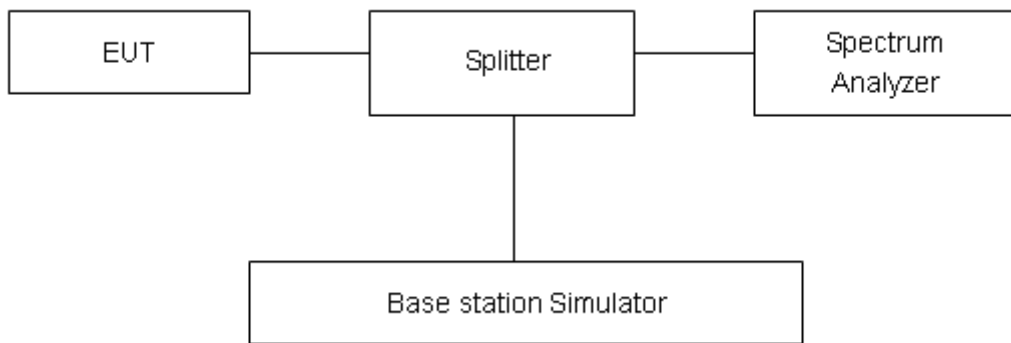

Limits

Rule Part 24.238(a) specifies that “on any frequency outside a licensee's frequency block, the power of any emission shall be attenuated below the transmitter power (P) by at least 43 + 10 log10 (P) dB.”

Limit	-13 dBm
-------	---------

Measurement Uncertainty

The assessed measurement uncertainty to ensure 95% confidence level for the normal distribution is with the coverage factor $k = 1.96$, $U=0.684dB$.



Test Result:

GSM 1900 GSM CH-Low



GSM 1900 GSM CH-High

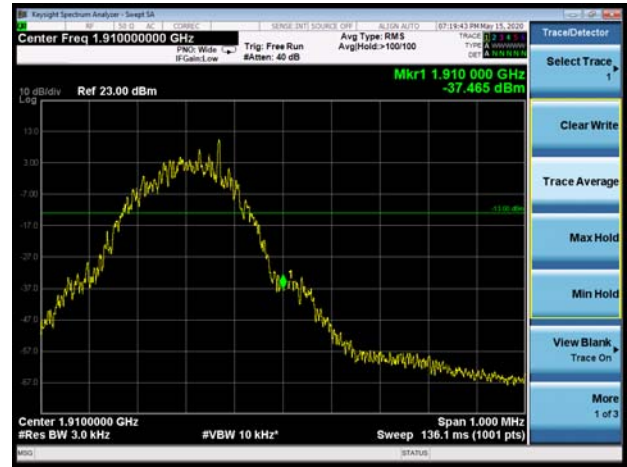

GSM 1900 GPRS CH-Low

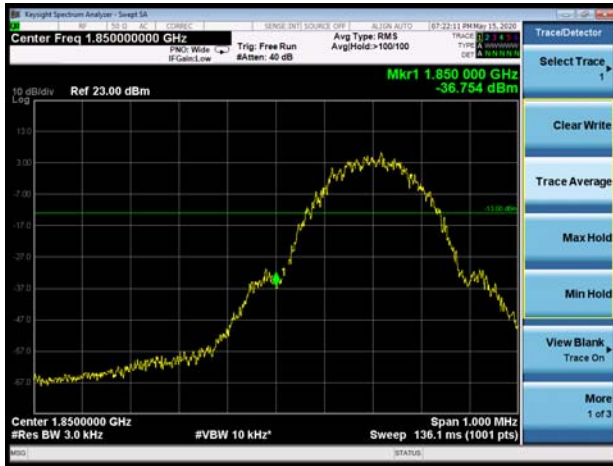

GSM 1900 GPRS CH-High

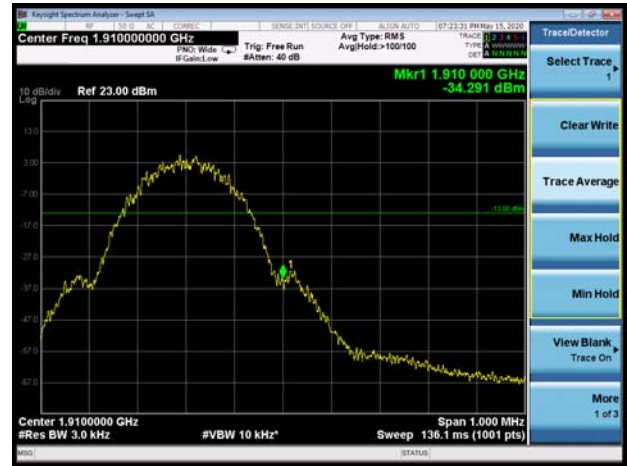

GSM 1900 EGPRS CH-Low

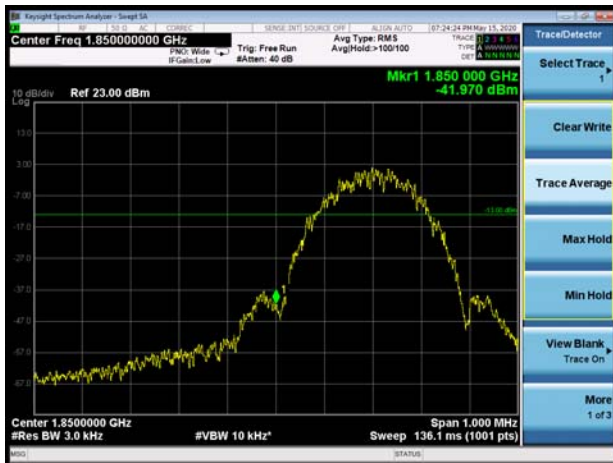

GSM 1900 EGPRS CH-High



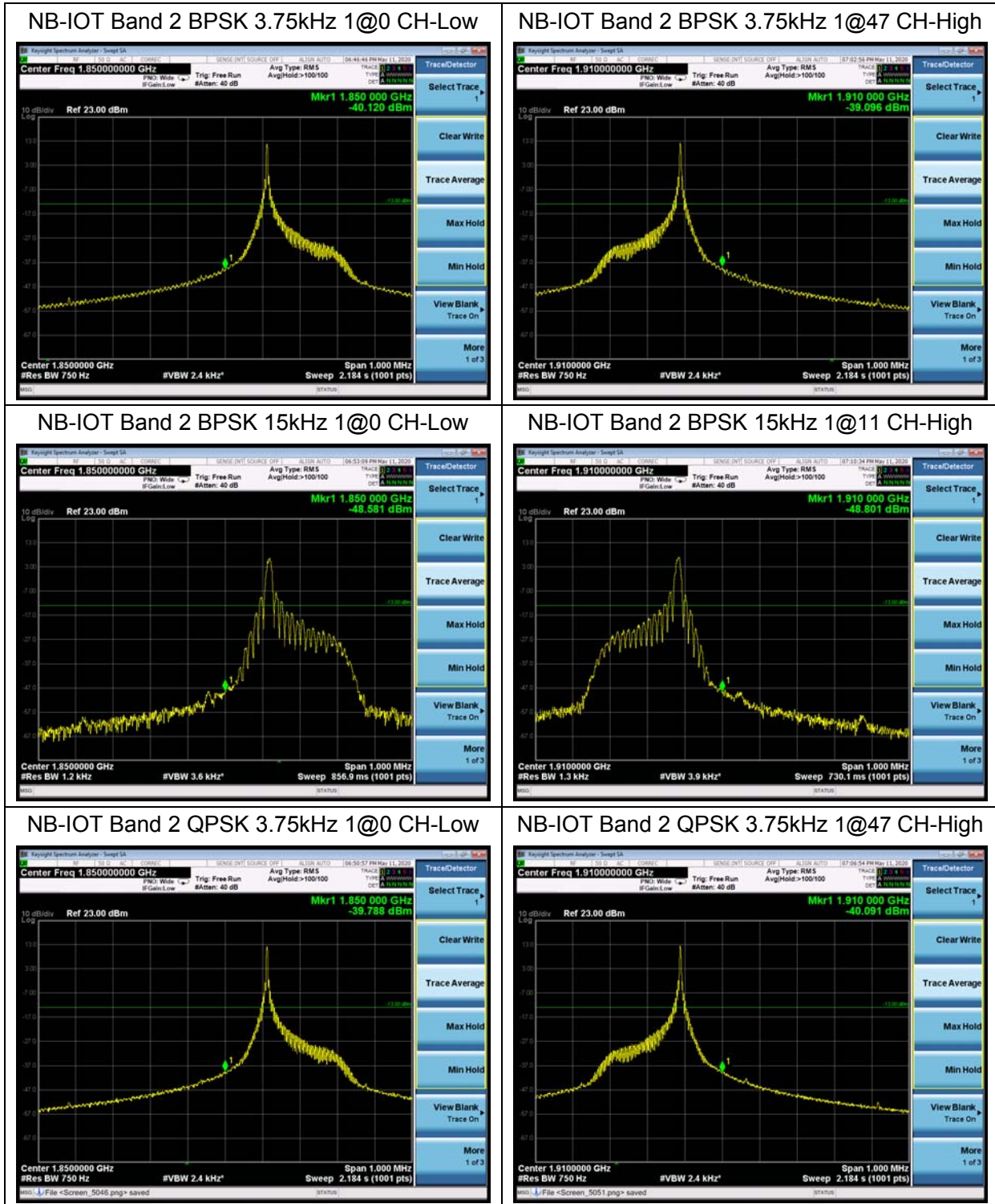

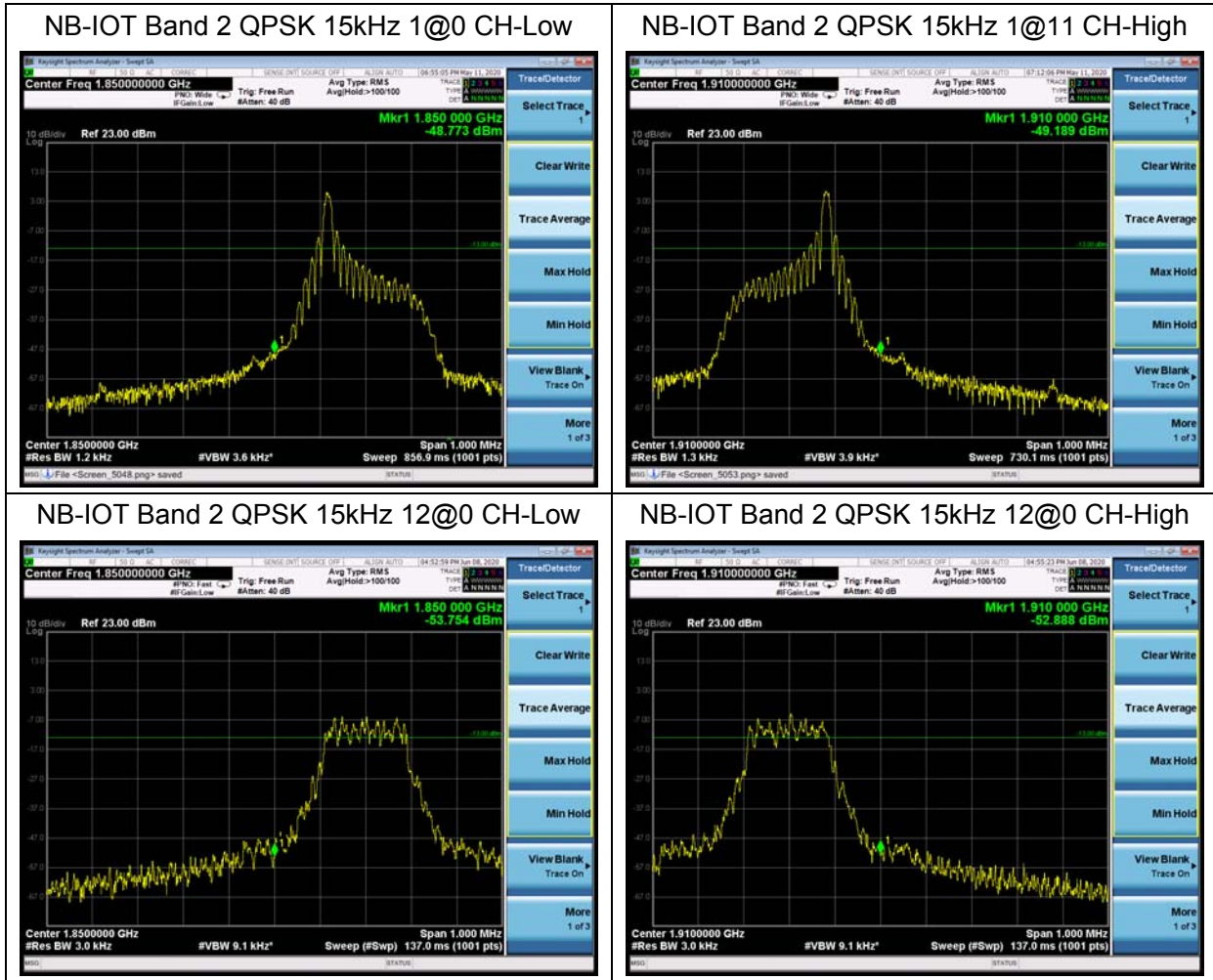

NB-IOT Band 25 BPSK 3.75kHz 1@0 CH-Low

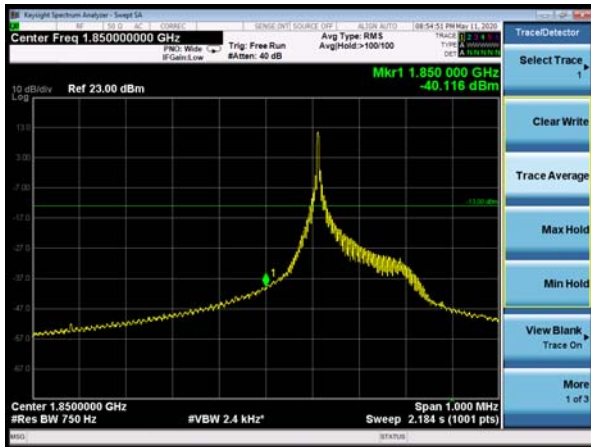

NB-IOT Band 25 BPSK 3.75kHz 1@47 CH-High

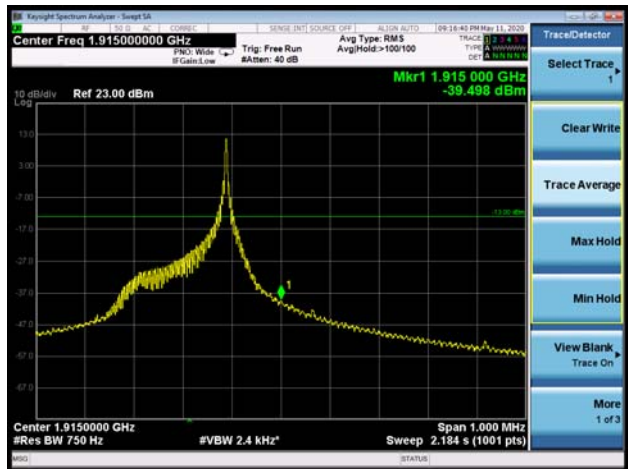

NB-IOT Band 25 BPSK 15kHz 1@0 CH-Low



NB-IOT Band 25 BPSK 15kHz 1@11 CH-High

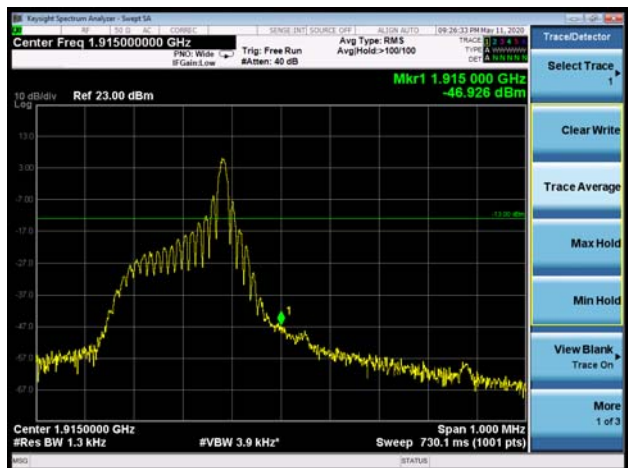

NB-IOT Band 25 QPSK 3.75kHz 1@0 CH-Low

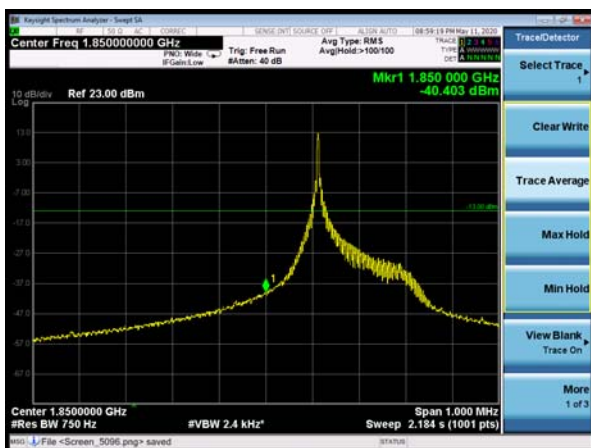

NB-IOT Band 25 QPSK 3.75kHz 1@47 CH-High

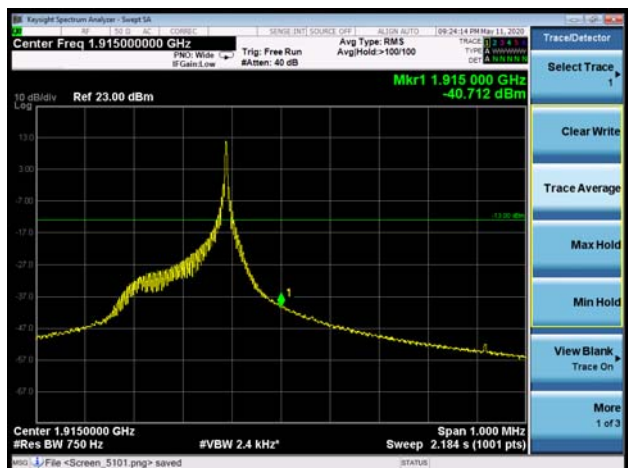

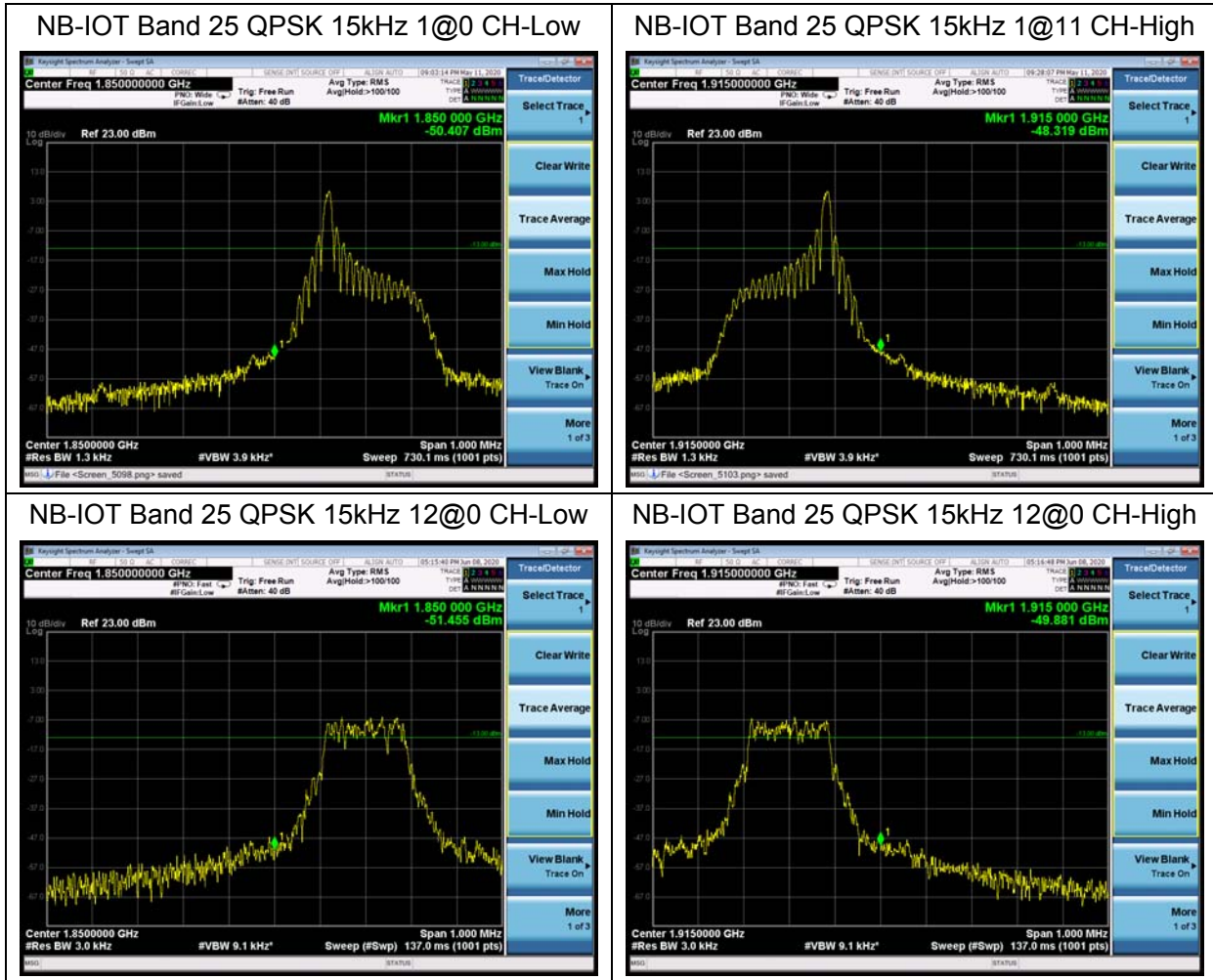

5.4. Peak-to-Average Power Ratio (PAPR)

Ambient condition

Temperature	Relative humidity	Pressure
23°C ~25°C	45%~50%	101.5kPa

Methods of Measurement

Measure the total peak power and record as PPk. And measure the total average power and record as PAvg. Both the peak and average power levels must be expressed in the same logarithmic units (e.g., dBm). Determine the PAPR from:

$$PAPR (dB) = PPk (dBm) - PAvg (dBm).$$

Test Setup

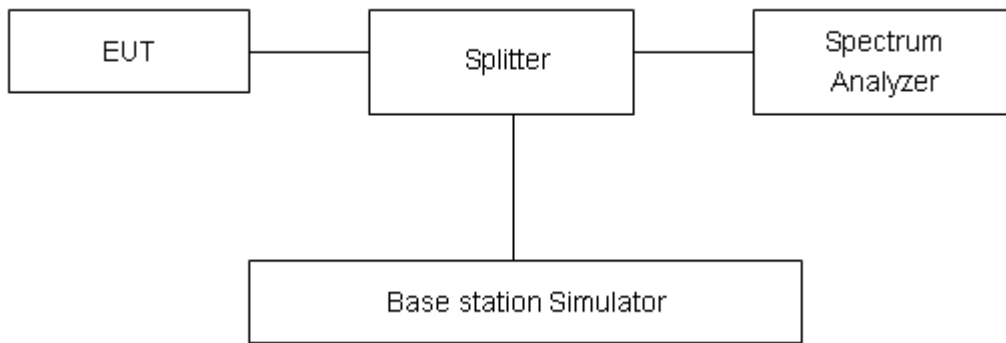

Limits

In measuring transmissions in this band using an average power technique, the peak-to-average ratio (PAR) of the transmission may not exceed 13 dB in 24.232(d).

Measurement Uncertainty

The assessed measurement uncertainty to ensure 95% confidence level for the normal distribution is with the coverage factor $k = 2$, $U = 0.4$ dB.



Test Results

Mode	Channel	Frequency (MHz)	Peak(dBm)	Avg(dBm)	PAPR(dB)	Limit(dB)	Conclusion
GSM 1900 (GMSK)	512	1850.2	29.63	29.13	0.50	≤13	PASS
	661	1880	29.88	29.32	0.56	≤13	PASS
	810	1909.8	29.71	29.05	0.66	≤13	PASS
GPRS 1900 (GMSK)	512	1850.2	30.13	29.42	0.71	≤13	PASS
	661	1880	30.27	29.52	0.75	≤13	PASS
	810	1909.8	30.39	29.60	0.79	≤13	PASS
EGPRS 1900 (8PSK)	512	1850.2	27.71	26.31	1.40	≤13	PASS
	661	1880	27.62	26.21	1.41	≤13	PASS
	810	1909.8	27.56	26.04	1.52	≤13	PASS

Mode	Modulation	Sub-carrier spacing (KHz)	Channel/ Frequency(MHz)	Peak-to-Average Power Ratio (PAPR)			Limit(dB)	Conclusion
				Peak(dBm)	Avg(dBm)	PAPR(dB)		
NB-IOT Band 2 Standalone	BPSK	3.75	18900/1880.0	22.51	17.68	4.83	≤13	PASS
	QPSK	3.75	18900/1880.0	21.82	17.64	4.18	≤13	PASS
	BPSK	15	18900/1880.0	21.99	14.74	7.25	≤13	PASS
	QPSK	15	18900/1880.0	21.62	14.71	6.91	≤13	PASS
Mode	Modulation	Sub-carrier spacing (KHz)	Channel/ Frequency(MHz)	Peak-to-Average Power Ratio (PAPR)			Limit(dB)	Conclusion
Peak(dBm)	Avg(dBm)	PAPR(dB)						
NB-IOT Band 25 Standalone	BPSK	3.75	26365/1882.5	22.41	17.56	4.85	≤13	PASS
	QPSK	3.75	26365/1882.5	21.69	17.51	4.18	≤13	PASS
	BPSK	15	26365/1882.5	22.02	14.77	7.25	≤13	PASS
	QPSK	15	26365/1882.5	21.67	14.79	6.88	≤13	PASS

5.5.Frequency Stability

Ambient condition

Temperature	Relative humidity	Pressure
23°C ~25°C	45%~50%	101.5kPa

Method of Measurement

Frequency Stability (Temperature Variation)

The temperature inside the climate chamber is varied from -40°C to +85°C in 10°C step size,

(1) With all power removed, the temperature was decreased to 0°C and permitted to stabilize for three hours.

(2) Measure the carrier frequency with the test equipment in a “call mode”. These measurements should be made within 1 minute of powering up the mobile station, to prevent significant self warming.

(3) Repeat the above measurements at 10°C increments from -40°C to +85°C. Allow at least 1.5 hours at each temperature, un-powered, before making measurements.

Frequency Stability (Voltage Variation)

The frequency stability shall be measured with variation of primary supply voltage as follows:

(1) Vary primary supply voltage from 85 to 115 percent of the nominal value for other than hand carried battery equipment.

(2) For hand carried, battery powered equipment, reduce primary supply voltage to the battery-operating end point which shall be specified by the manufacturer.

This transceiver is specified to operate with an input voltage of between 3.3 V and 4.3 V, with a nominal voltage of 3.8V.

Test setup

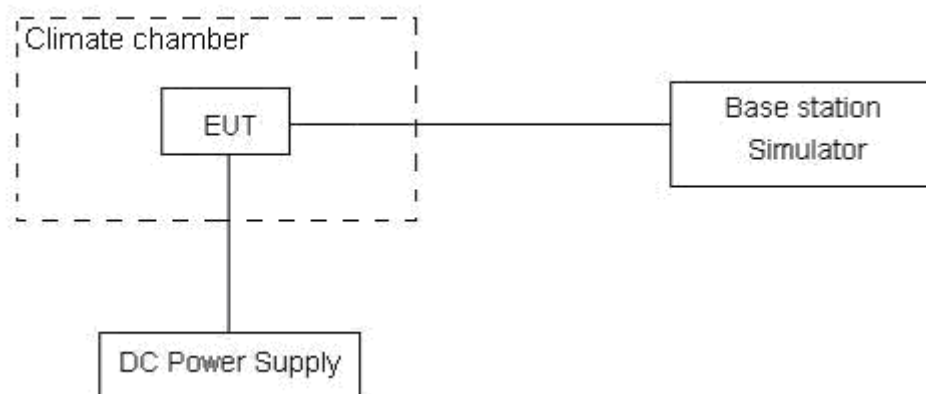

**Limits**

The frequency stability shall be sufficient to ensure that the fundamental emission stays within the authorized frequency block

Measurement Uncertainty

The assessed measurement uncertainty to ensure 99.75% confidence level for the normal distribution is with the coverage factor $k = 3$, $U = 0.01\text{ppm}$.

Test Result

GSM 1900						
Condition		Freq.Error (Hz)	Freq.Error (Hz)	Frequency Stability(ppm)	Frequency Stability(ppm)	Verdict
Temperature	Voltage	GMSK	8PSK	GMSK	8PSK	
Normal(25°C)	Normal	16.00	6.00	0.00851	0.00319	PASS
Extreme(85°C)		5.00	6.00	0.00266	0.00319	PASS
Extreme(80°C)		1.00	13.00	0.00053	0.00691	PASS
Extreme(70°C)		16.00	6.00	0.00851	0.00319	PASS
Extreme(60°C)		4.00	3.00	0.00213	0.00160	PASS
Extreme(50°C)		16.00	12.00	0.00851	0.00638	PASS
Extreme(40°C)		3.00	12.00	0.00160	0.00638	PASS
Extreme(30°C)		8.00	17.00	0.00426	0.00904	PASS
Extreme(20°C)		5.00	1.00	0.00266	0.00053	PASS
Extreme(10°C)		3.00	9.00	0.00160	0.00479	PASS
Extreme(0°C)		6.00	5.00	0.00319	0.00266	PASS
Extreme(-10°C)		4.00	6.00	0.00213	0.00319	PASS
Extreme(-20°C)		2.00	14.00	0.00106	0.00745	PASS
Extreme(-30°C)		15.00	3.00	0.00798	0.00160	PASS
Extreme(-40°C)		15.00	7.00	0.00798	0.00372	PASS
25°C	LV	9.00	5.00	0.00479	0.00266	PASS
	HV	13.00	15.00	0.00691	0.00798	PASS

NB-IOT Band 2						
Condition		Freq.Error (Hz)	Freq.Error (Hz)	Frequency Stability(ppm)	Frequency Stability(ppm)	Verdict
Sub-carrier spacing (KHz)	3.75					
Temperature	Voltage	BPSK	QPSK	BPSK	QPSK	
Normal(25°C)	Normal	2.41	13.53	0.00128	0.00720	PASS
Extreme(85°C)		17.48	3.68	0.00930	0.00196	PASS
Extreme(80°C)		10.19	1.29	0.00542	0.00069	PASS
Extreme(70°C)		14.60	2.38	0.00777	0.00127	PASS
Extreme(60°C)		5.39	3.87	0.00286	0.00206	PASS
Extreme(50°C)		2.66	9.44	0.00141	0.00502	PASS
Extreme(40°C)		11.05	1.97	0.00588	0.00105	PASS
Extreme(30°C)		8.89	9.05	0.00473	0.00481	PASS
Extreme(20°C)		3.62	10.71	0.00193	0.00570	PASS
Extreme(10°C)		13.31	8.95	0.00708	0.00476	PASS
Extreme(0°C)		15.33	9.32	0.00816	0.00496	PASS



Condition		Freq.Error (Hz)	Freq.Error (Hz)	Frequency Stability(ppm)	Frequency Stability(ppm)	Verdict
Sub-carrier spacing (KHz)	15					
Temperature	Voltage	BPSK	QPSK	BPSK	QPSK	
Extreme(-10°C)		17.95	12.10	0.00955	0.00644	PASS
Extreme(-20°C)		5.67	12.08	0.00302	0.00642	PASS
Extreme(-30°C)		4.52	17.94	0.00241	0.00954	PASS
Extreme(-40°C)		2.25	1.22	0.00120	0.00065	PASS
25°C	LV	4.51	9.73	0.00240	0.00518	PASS
	HV	5.34	8.22	0.00284	0.00437	PASS
Normal(25°C) <td rowspan="16">Normal</td> <td>16.17</td> <td>4.63</td> <td>0.00860</td> <td>0.00246</td> <td>PASS</td>	Normal	16.17	4.63	0.00860	0.00246	PASS
Extreme(85°C)		9.58	15.37	0.00510	0.00817	PASS
Extreme(80°C)		10.26	15.84	0.00546	0.00842	PASS
Extreme(70°C)		15.25	6.33	0.00811	0.00337	PASS
Extreme(60°C)		8.45	9.74	0.00450	0.00518	PASS
Extreme(50°C)		15.86	11.36	0.00844	0.00605	PASS
Extreme(40°C)		12.24	5.05	0.00651	0.00269	PASS
Extreme(30°C)		8.90	9.36	0.00473	0.00498	PASS
Extreme(20°C)		14.62	16.78	0.00778	0.00892	PASS
Extreme(10°C)		8.09	14.91	0.00430	0.00793	PASS
Extreme(0°C)		15.62	5.85	0.00831	0.00311	PASS
Extreme(-10°C)		10.11	12.24	0.00538	0.00651	PASS
Extreme(-20°C)		4.79	17.95	0.00255	0.00955	PASS
Extreme(-30°C)		3.22	1.58	0.00171	0.00084	PASS
Extreme(-40°C)		11.04	12.53	0.00587	0.00666	PASS
25°C		LV	3.72	10.57	0.00198	0.00562
	HV	3.06	13.80	0.00163	0.00734	PASS

NB-IOT Band 25						
Condition		Freq.Error (Hz)	Freq.Error (Hz)	Frequency Stability(ppm)	Frequency Stability(ppm)	Verdict
Sub-carrier spacing (KHz)	3.75					
Temperature	Voltage	BPSK	QPSK	BPSK	QPSK	
Normal(25°C)	Normal	9.34	9.49	0.00497	0.00505	PASS
Extreme(85°C)		11.20	16.29	0.00596	0.00866	PASS
Extreme(80°C)		13.05	17.12	0.00694	0.00911	PASS
Extreme(70°C)		16.70	8.00	0.00888	0.00425	PASS
Extreme(60°C)		7.45	16.93	0.00396	0.00901	PASS
Extreme(50°C)		5.29	16.17	0.00282	0.00860	PASS



Extreme(40°C)		10.99	14.43	0.00584	0.00768	PASS
Extreme(30°C)		8.42	9.22	0.00448	0.00490	PASS
Extreme(20°C)		2.09	1.79	0.00111	0.00095	PASS
Extreme(10°C)		10.26	12.64	0.00546	0.00672	PASS
Extreme(0°C)		2.68	7.08	0.00143	0.00377	PASS
Extreme(-10°C)		3.35	3.26	0.00178	0.00174	PASS
Extreme(-20°C)		14.02	11.90	0.00746	0.00633	PASS
Extreme(-30°C)		5.21	17.42	0.00277	0.00927	PASS
Extreme(-40°C)		9.08	15.70	0.00483	0.00835	PASS
25°C	LV	6.76	2.84	0.00359	0.00151	PASS
	HV	11.00	3.30	0.00585	0.00175	PASS
Condition		Freq.Error (Hz)	Freq.Error (Hz)	Frequency Stability(ppm)	Frequency Stability(ppm)	Verdict
Sub-carrier spacing (KHz)	15					
Temperature	Voltage	BPSK	QPSK	BPSK	QPSK	
Normal(25°C)	Normal	5.65	4.89	0.00301	0.00260	PASS
Extreme(85°C)		12.43	1.76	0.00661	0.00094	PASS
Extreme(80°C)		1.10	13.90	0.00059	0.00740	PASS
Extreme(70°C)		1.78	8.06	0.00095	0.00429	PASS
Extreme(60°C)		8.17	7.06	0.00434	0.00376	PASS
Extreme(50°C)		13.50	4.92	0.00718	0.00261	PASS
Extreme(40°C)		4.13	14.75	0.00220	0.00785	PASS
Extreme(30°C)		3.48	13.23	0.00185	0.00704	PASS
Extreme(20°C)		2.78	16.53	0.00148	0.00879	PASS
Extreme(10°C)		16.91	3.09	0.00899	0.00164	PASS
Extreme(0°C)		1.24	15.35	0.00066	0.00817	PASS
Extreme(-10°C)		17.54	17.20	0.00933	0.00915	PASS
Extreme(-20°C)		4.97	9.92	0.00264	0.00528	PASS
Extreme(-30°C)		12.28	16.67	0.00653	0.00887	PASS
Extreme(-40°C)		14.65	7.95	0.00779	0.00423	PASS
25°C	LV	12.58	9.33	0.00669	0.00496	PASS
	HV	15.31	8.84	0.00814	0.00470	PASS

5.6. Spurious Emissions at Antenna Terminals

Ambient condition

Temperature	Relative humidity	Pressure
23°C ~25°C	45%~50%	101.5kPa

Method of Measurement

The EUT was connected to Spectrum Analyzer and Base Station Simulator via power Splitter. The measurement is carried out using a spectrum analyzer. The spectrum analyzer scans from 9kHz to the 10th harmonic of the carrier. The peak detector is used.

RBW is set to 100kHz, VBW is set to 300kHz for 30MHz~1GHz

RBW is set to 1MHz, VBW is set to 3MHz for above 1GHz, Sweep is set to ATUO.

The modulation mode and RB allocation refer to section 5.1, using the maximum output power configuration.

Test setup

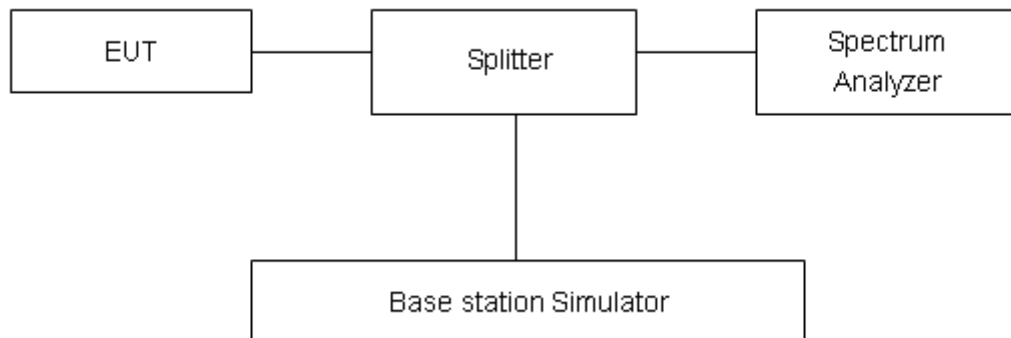

Limits

Rule Part 24.238(a) specifies that “on any frequency outside a licensee's frequency block, the power of any emission shall be attenuated below the transmitter power (P) by at least 43 + 10 log₁₀ (P) dB.”

Limit	-13 dBm
-------	---------

Measurement Uncertainty

The assessed measurement uncertainty to ensure 99.75% confidence level for the normal distribution is with the coverage factor $k = 1.96$.

Frequency	Uncertainty
30MHz-1GHz	0.684 dB
1GHz-20GHz	1.407 dB

Test Result

Sweep the whole frequency band through the range from 9kHz to the 10th harmonic of the carrier, the emissions more than 20 dB below the limit are not reported.

The signal beyond the limit is carrier.

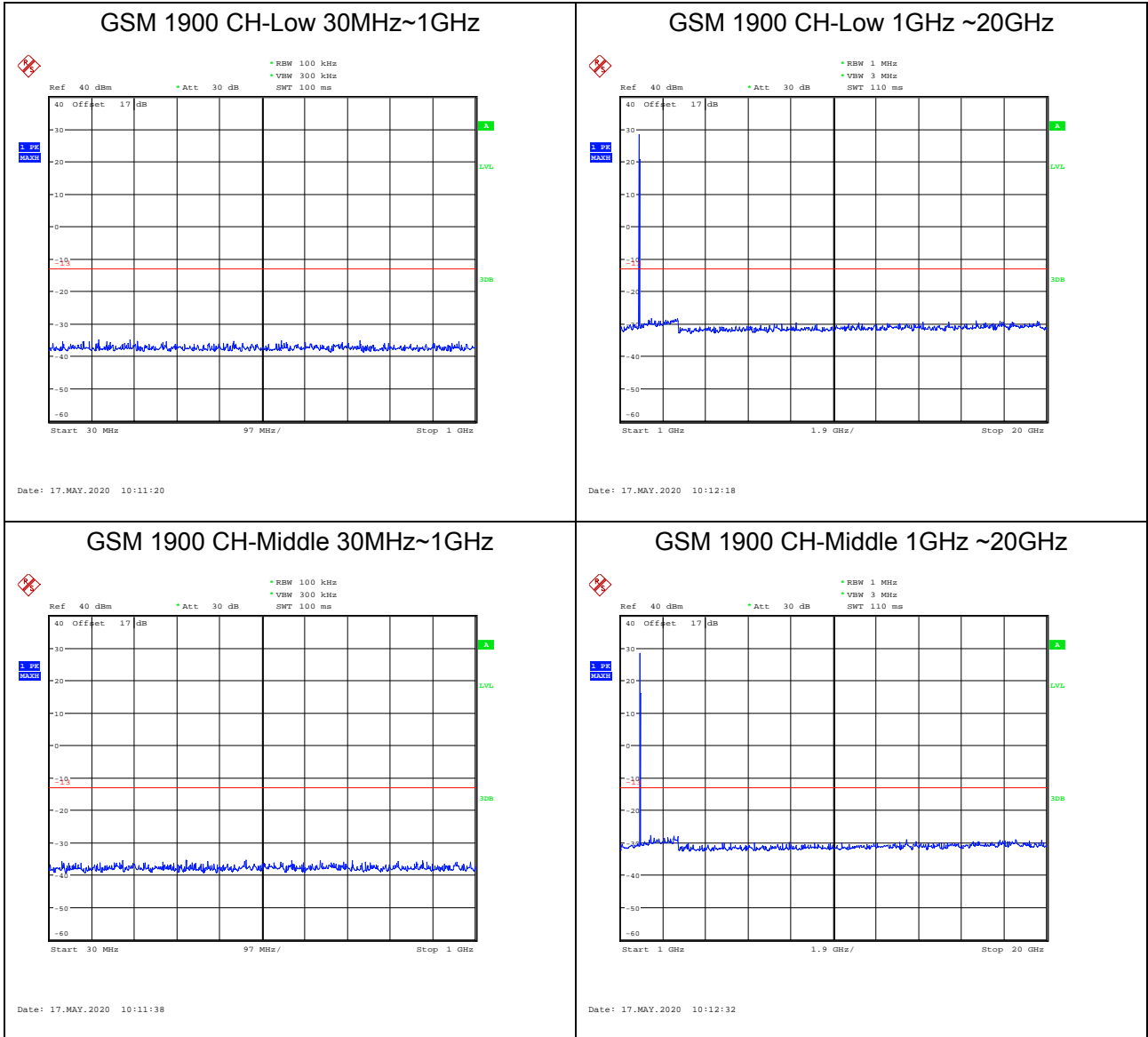

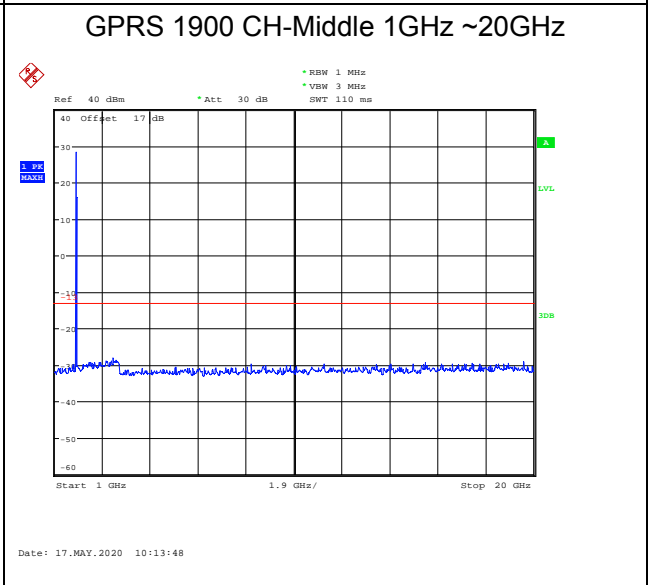
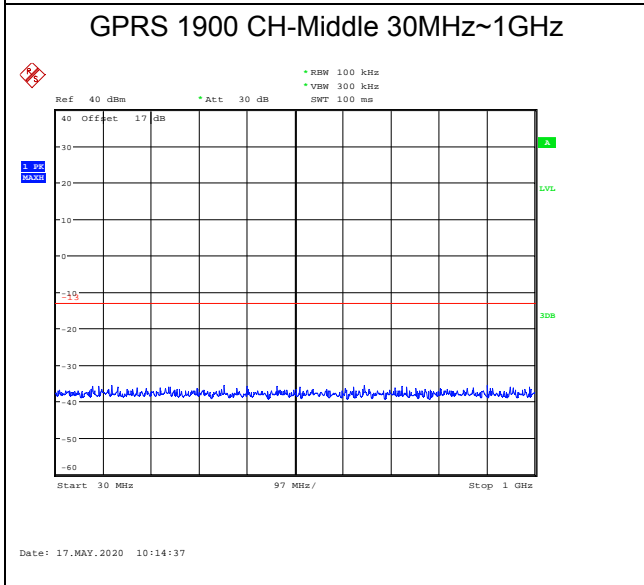
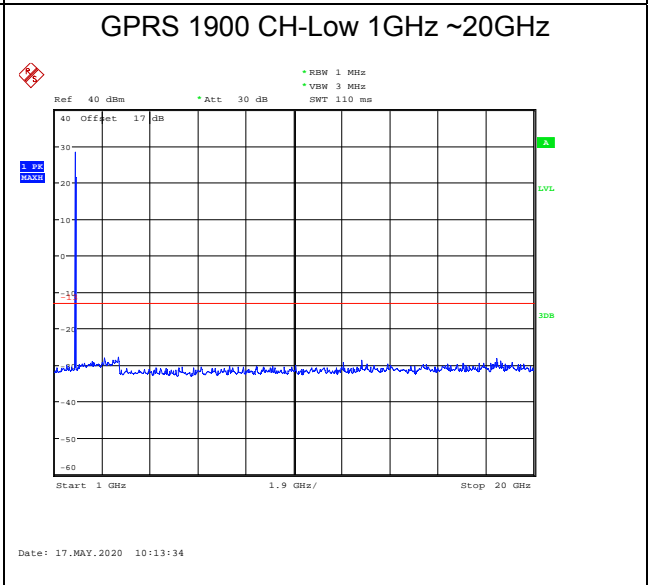
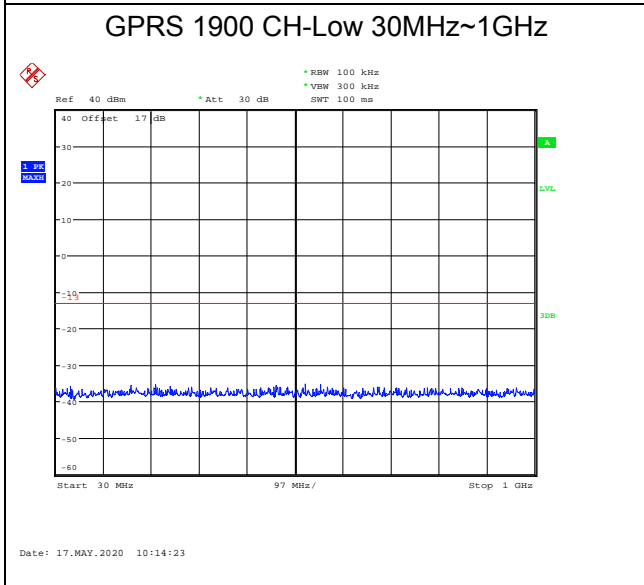
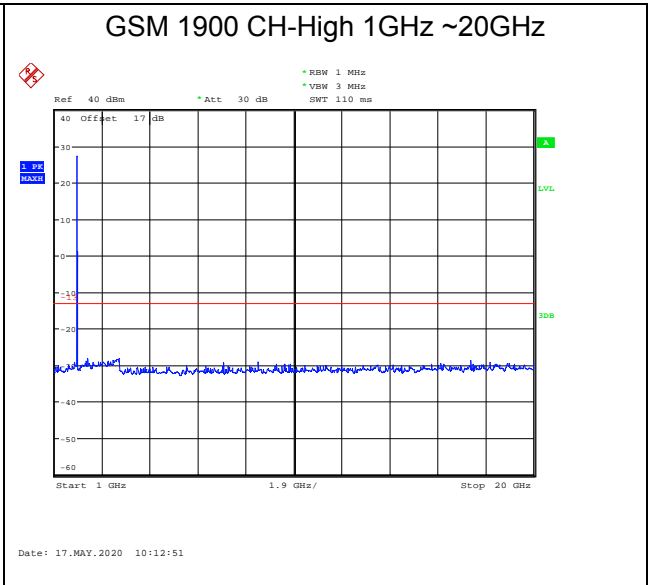
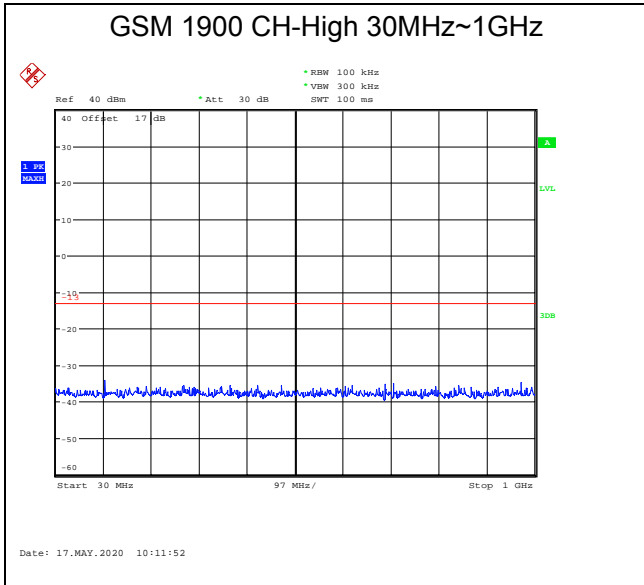



GPRS 1900 CH-High 30MHz~1GHz

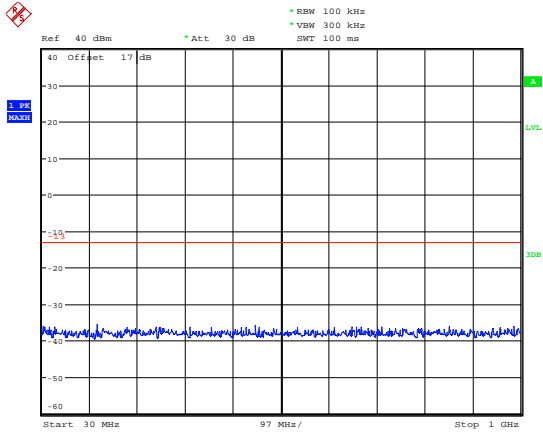

Date: 17.MAY.2020 10:14:49

GPRS 1900 CH-High 1GHz ~20GHz

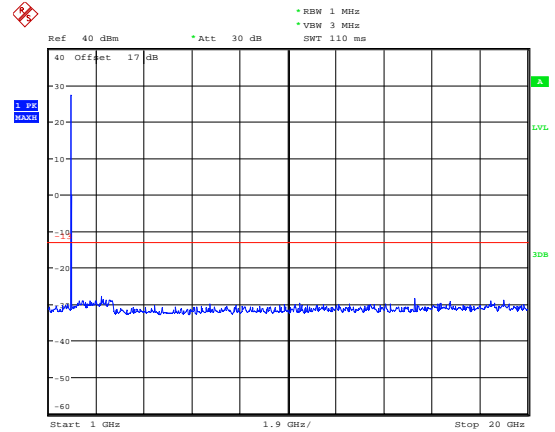

Date: 17.MAY.2020 10:14:01

EGPRS 1900 CH-Low 30MHz~1GHz

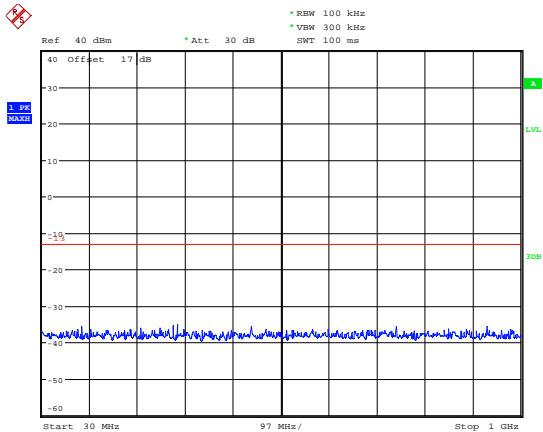

Date: 17.MAY.2020 10:16:00

EGPRS 1900 CH-Low 1GHz ~20GHz

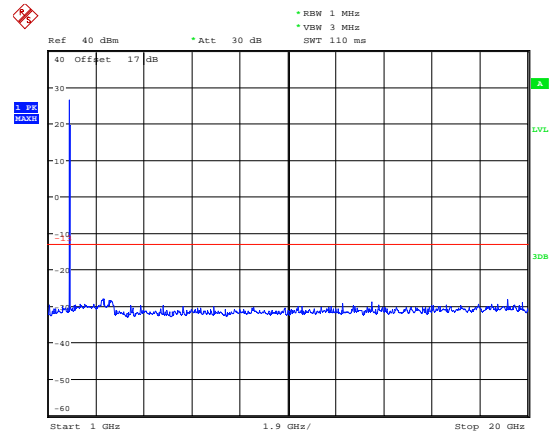

Date: 17.MAY.2020 10:17:20

EGPRS 1900 CH-Middle 30MHz~1GHz

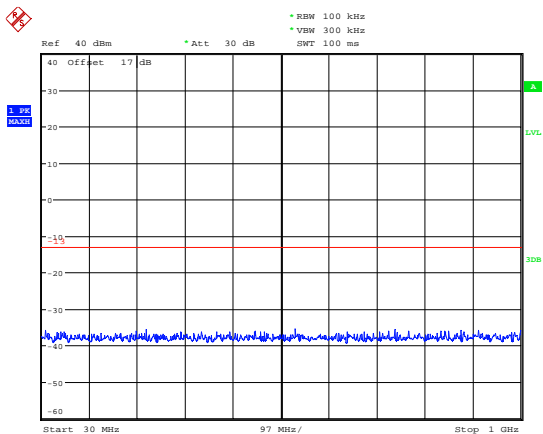

Date: 17.MAY.2020 10:16:43

EGPRS 1900 CH-Middle 1GHz ~20GHz

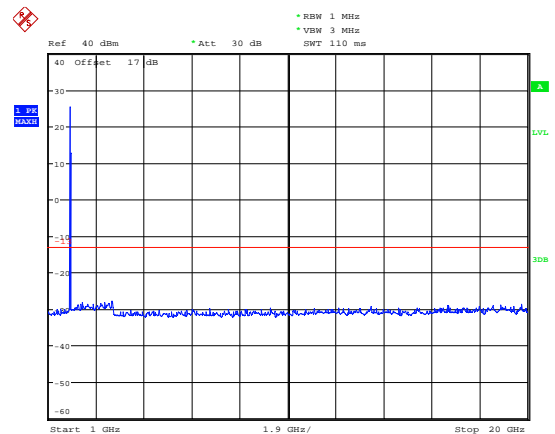

Date: 17.MAY.2020 10:17:42

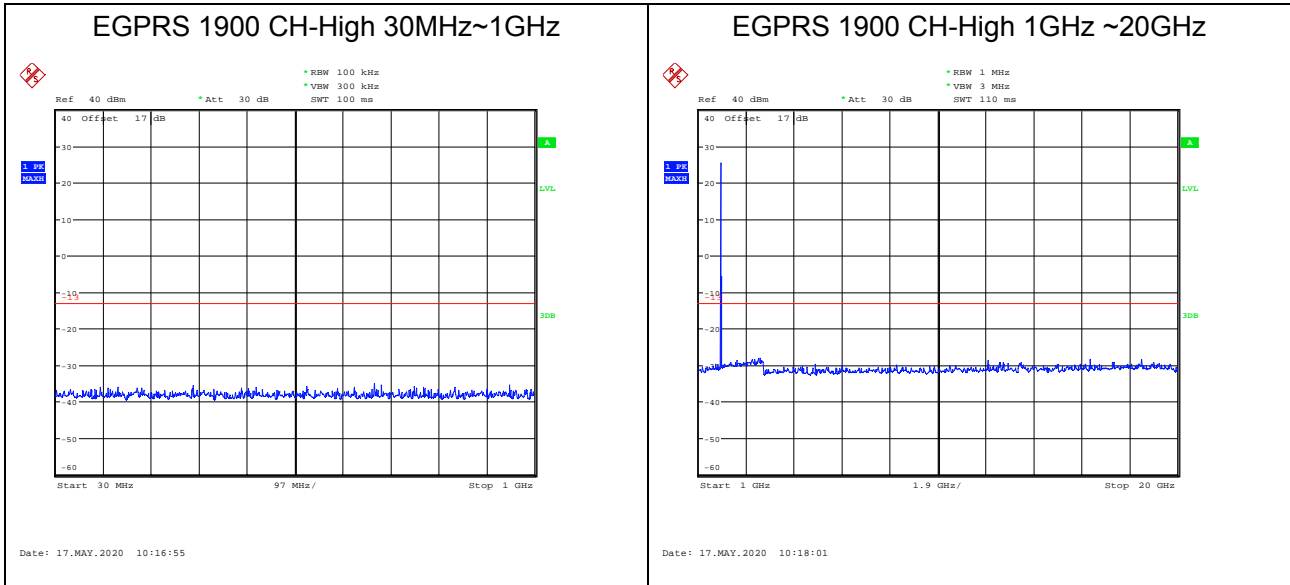



NB-IOT Band 2 CH-Low 30MHz~1GHz

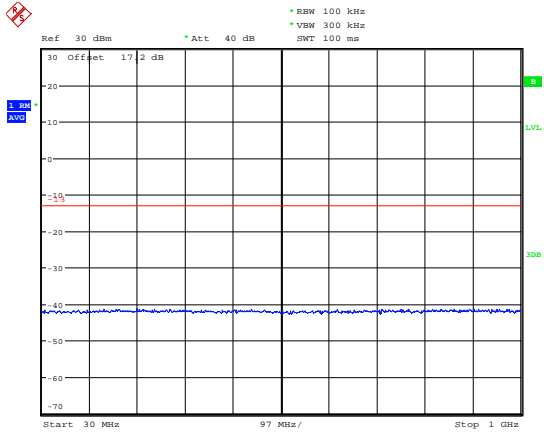

Date: 14.MAY.2020 16:44:34

NB-IOT Band 2 CH-Low 1GHz ~20GHz

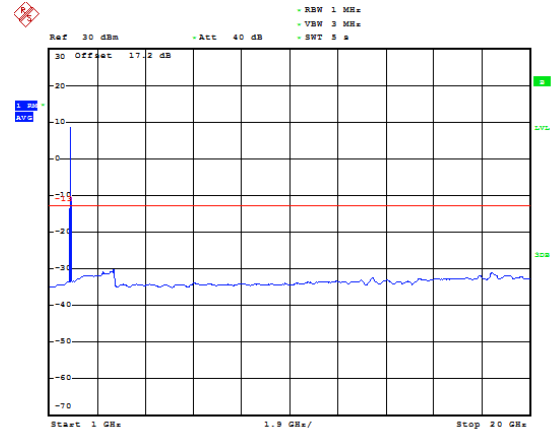

Date: 14.MAY.2020 16:47:52

NB-IOT Band 2 CH-Middle 30MHz~1GHz

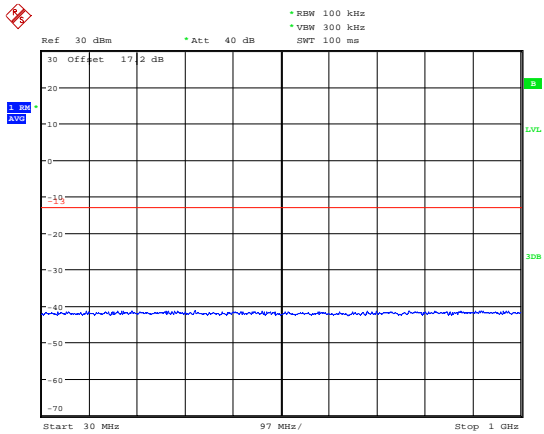

Date: 14.MAY.2020 16:45:28

NB-IOT Band 2 CH-Middle 1GHz ~20GHz

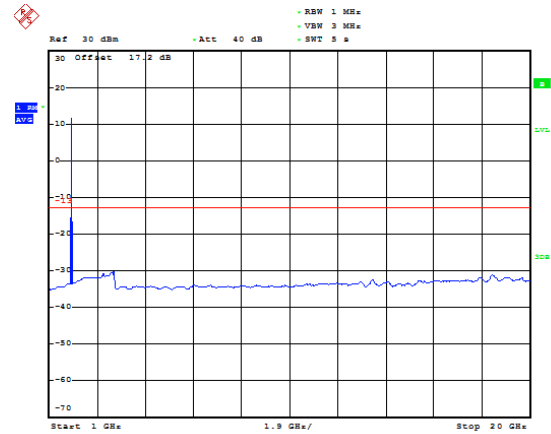

Date: 14.MAY.2020 16:48:50

NB-IOT Band 2 CH-High 30MHz~1GHz

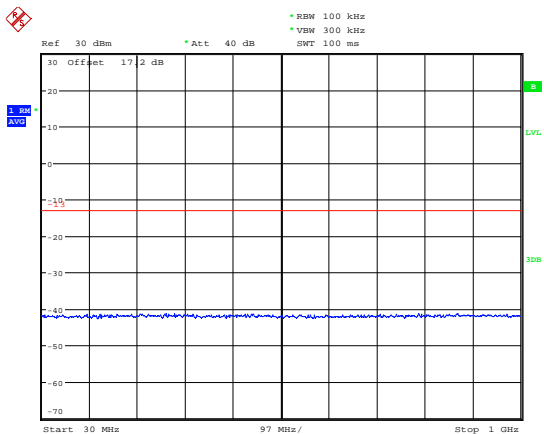

Date: 14.MAY.2020 16:46:35

NB-IOT Band 2 CH-High 1GHz ~20GHz

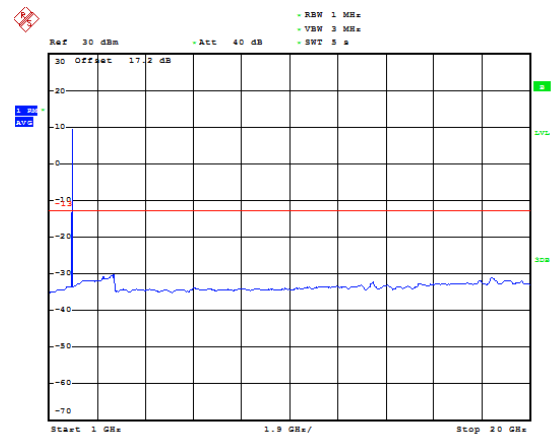

Date: 14.MAY.2020 16:50:08



NB-IOT Band 25 CH-Low 30MHz~1GHz

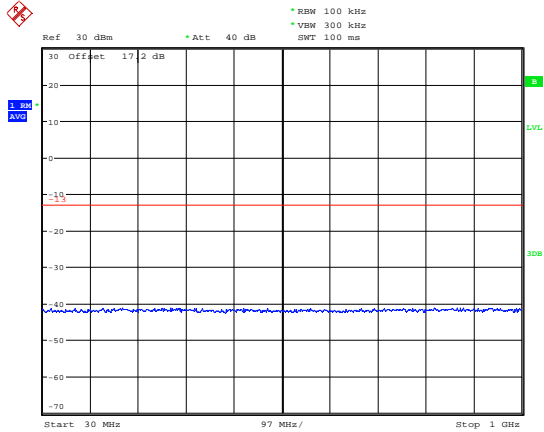

Date: 14.MAY.2020 17:31:07

NB-IOT Band 25 CH-Low 1GHz ~20GHz

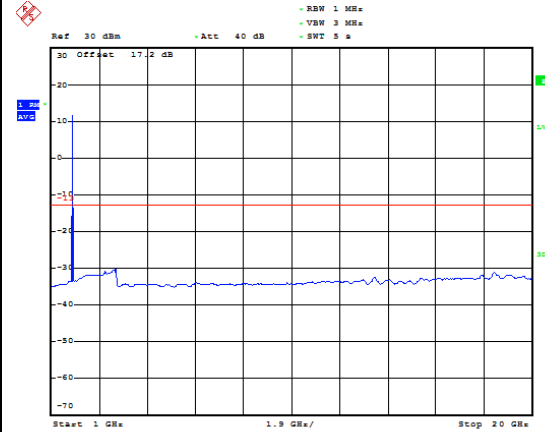

Date: 14.MAY.2020 17:31:59

NB-IOT Band 25 CH-Middle 30MHz~1GHz

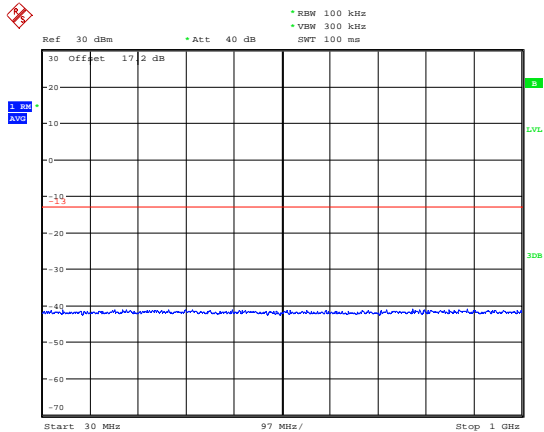

Date: 14.MAY.2020 17:31:17

NB-IOT Band 25 CH-Middle 1GHz ~20GHz

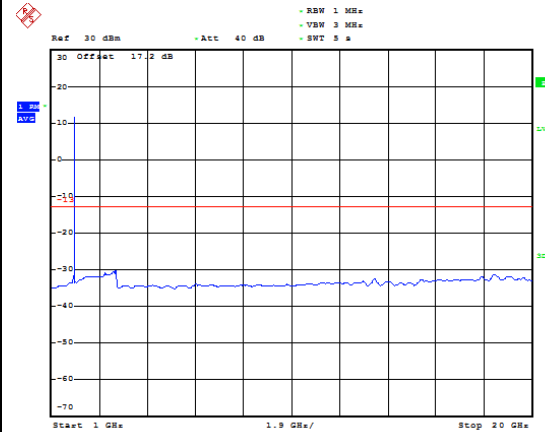

Date: 14.MAY.2020 17:32:56

NB-IOT Band 25 CH-High 30MHz~1GHz

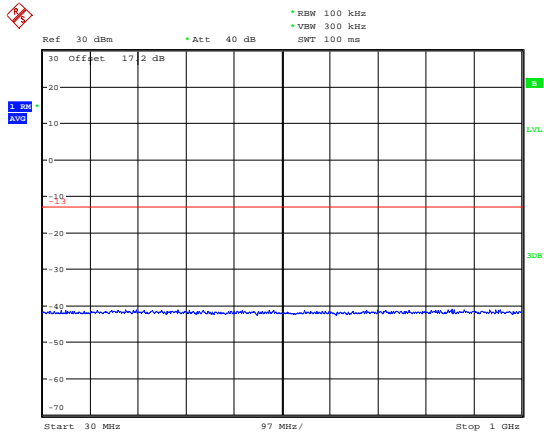

Date: 14.MAY.2020 17:31:25

NB-IOT Band 25 CH-High 1GHz ~20GHz

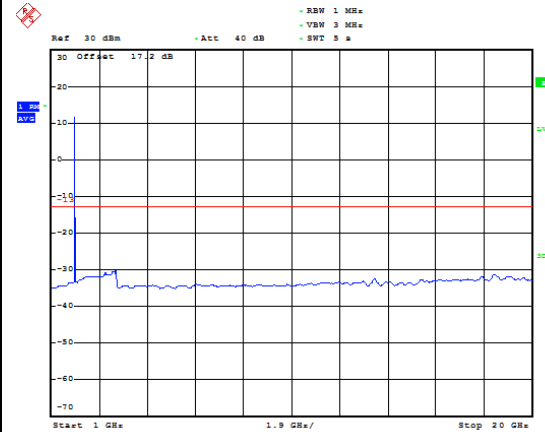

Date: 14.MAY.2020 17:34:12

5.7. Radiates Spurious Emission

Ambient condition

Temperature	Relative humidity	Pressure
23°C ~25°C	45%~50%	101.5kPa

Method of Measurement

1. The testing follows FCC KDB 971168 v03r01 Section 5.8 and ANSI C63.26 (2015).
2. Below 1GHz: The EUT is placed on a turntable 0.8 meters above the ground in the chamber, 3 meter away from the antenna. The maximal emission value is acquired by adjusting the antenna height, polarisation and turntable azimuth. Normally, the height range of antenna is 1 m to 4 m, the azimuth range of turntable is 0° to 360°, and the receive antenna has two polarizations Vertical (V) and Horizontal (H). Above 1GHz: (Note: the FCC's permission to use 1.5m as an alternative per TCBC Conf call of Dec. 2, 2014.) The EUT is placed on a turntable 1.5 meters above the ground in the chamber, 3 meter away from the antenna. The maximal emission value is acquired by adjusting the antenna height, polarisation and turntable azimuth. Normally, the height range of antenna is 1 m to 4 m, the azimuth range of turntable is 0° to 360°, and the receive antenna has two polarizations Vertical (V) and Horizontal (H).
3. A loop antenna, A log-periodic antenna or horn antenna shall be substituted in place of the EUT. The log-periodic antenna will be driven by a signal generator and the level will be adjusted till the same power value on the spectrum analyzer or receiver. The level of the spurious emissions can be calculated through the level of the signal generator, cable loss, the gain of the substitution antenna and the reading of the spectrum analyzer or receiver.
4. The EUT is then put into continuously transmitting mode at its maximum power level during the test. Set Test Receiver or Spectrum RBW=200Hz,VBW=600Hz for 9kHz150kHz , RBW=10kHz, VBW=30kHz 150kHz-30MHz , RBW=100kHz,VBW=300kHz for 30MHz to 1GHz and RBW=1MHz, VBW=3MHz for above 1GHz, And the maximum value of the receiver should be recorded as (Pr).
5. The EUT shall be replaced by a substitution antenna. In the chamber, an substitution antenna for the frequency band of interest is placed at the reference point of the chamber. An RF Signal source for the frequency band of interest is connected to the substitution antenna with a cable that has been constructed to not interfere with the radiation pattern of the antenna. A power (PMea) is applied to the input of the substitution antenna, and adjust the level of the signal generator output until the value of the receiver reach the previously recorded (Pr). The power of signal source (PMea) is recorded. The test should be performed by rotating the test item and adjusting the receiving antenna polarization.
6. A amplifier should be connected to the Signal Source output port. And the cable should be connect between the Amplifier and the Substitution Antenna. The cable loss (Pcl) ,the Substitution Antenna Gain (Ga) and the Amplifier Gain (PAg) should be recorded after test.
7. The measurement results are obtained as described below:
$$\text{Power(EIRP)} = \text{PMea} - \text{PAg} - \text{Pcl} + \text{Ga}$$

The measurement results are amend as described below:
$$\text{Power(EIRP)} = \text{PMea} - \text{Pcl} + \text{Ga}$$
8. This value is EIRP since the measurement is calibrated using an antenna of known gain (2.15 dBi)

and known input power. ERP can be calculated from EIRP by subtracting the gain of the dipole, $ERP = EIRP - 2.15\text{dBi}$.

The modulation mode and RB allocation refer to section 5.1, using the maximum output power configuration.

Test setup

9KHz ~ 30MHz

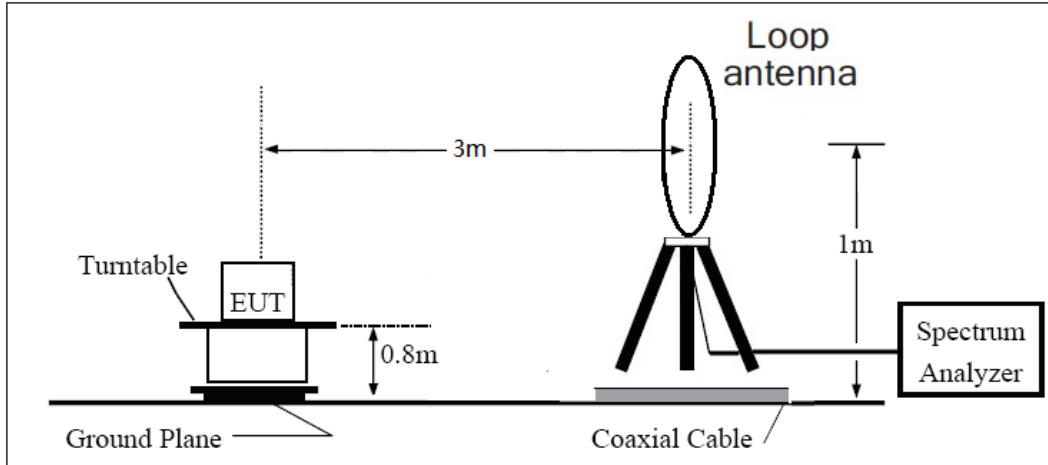

30MHz ~ 1GHz

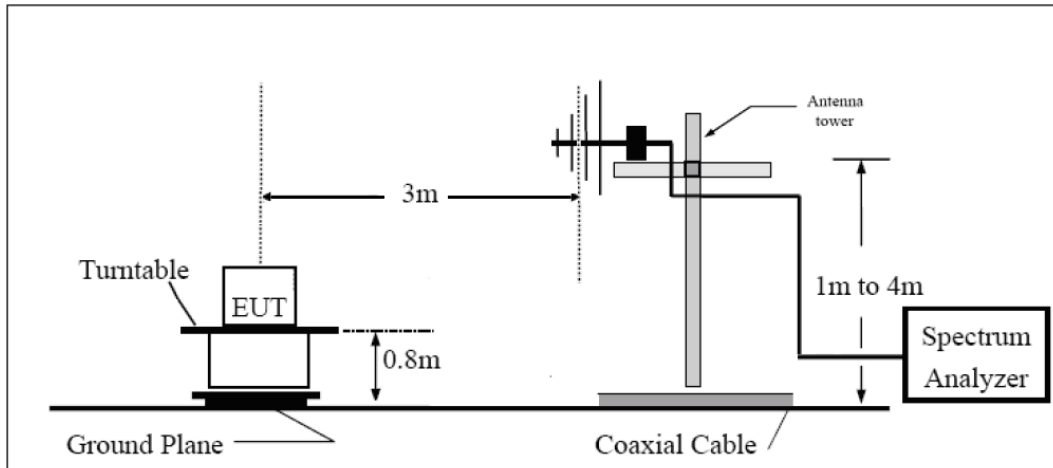

Above 1GHz

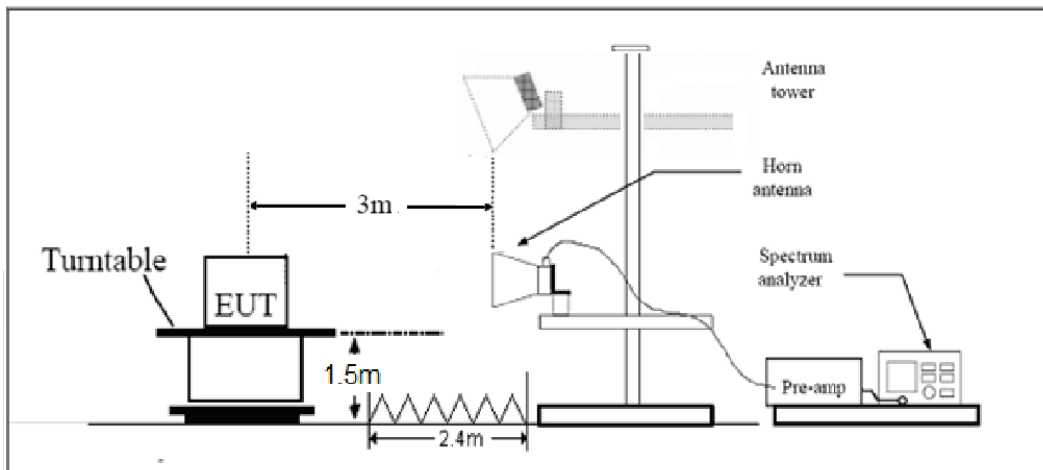



Note: Area side: 2.4mX3.6m

Limits

Rule Part 24.238(a) specifies that “on any frequency outside a licensee's frequency block, the power of any emission shall be attenuated below the transmitter power (P) by at least $43 + 10 \log_{10}(P)$ dB.”

Limit	-13 dBm
-------	---------

Measurement Uncertainty

The assessed measurement uncertainty to ensure 95% confidence level for the normal distribution is with the coverage factor $k = 1.96$, $U = 3.55$ dB.

Test Result

Sweep the whole frequency band through the range from 9kHz to the 10th harmonic of the carrier, the emissions below the noise floor will not be recorded in the report.

GSM 1900 CH-Middle

Harmonic	Frequency (MHz)	SG (dBm)	Cable Loss (dB)	Gain (dBi)	Antenna Polarization	EIRP Level (dBm)	Limit (dBm)	Margin (dB)	Azimuth (deg)
2	3760.0	-56.72	5.10	11.05	Horizontal	-50.77	-13.00	37.77	225
3	5640.0	-61.63	5.42	12.65	Horizontal	-54.40	-13.00	41.40	90
4	7520.0	-57.25	6.70	13.85	Horizontal	-50.10	-13.00	37.10	315
5	9400.0	-55.34	7.01	14.75	Horizontal	-47.60	-13.00	34.60	225
6	11280.0	-55.07	7.48	15.95	Horizontal	-46.60	-13.00	33.60	45
7	13160.0	-55.34	7.51	16.55	Horizontal	-46.30	-13.00	33.30	0
8	15040.0	-52.31	8.24	15.35	Horizontal	-45.20	-13.00	32.20	90
9	16920.0	-48.49	8.41	14.95	Horizontal	-41.95	-13.00	28.95	45
10	18800.0	-	-	-	-	-	-	-	-

Note: 1.The other Spurious RF Radiated emissions level is no more than noise floor.
 2. The worst emission was found in the antenna is Horizontal position.

NB-IOT Band 2 15kHz QPSK CH-Low

Harmonic	Frequency (MHz)	SG (dBm)	Cable Loss (dB)	Gain (dBi)	Antenna Polarization	EIRP Level (dBm)	Limit (dBm)	Margin (dB)	Azimuth (deg)
2	3700.2	-62.23	5.10	11.05	Horizontal	-56.28	-13.00	43.28	90
3	5550.3	-61.68	5.42	12.65	Horizontal	-54.45	-13.00	41.45	270
4	7400.4	-57.51	6.70	13.85	Horizontal	-50.36	-13.00	37.36	45
5	9250.5	-56.43	7.01	14.75	Horizontal	-48.69	-13.00	35.69	315
6	11100.6	-55.24	7.48	15.95	Horizontal	-46.77	-13.00	33.77	0
7	12950.7	-54.18	7.51	16.55	Horizontal	-45.14	-13.00	32.14	45
8	14800.8	-50.82	8.24	15.35	Horizontal	-43.71	-13.00	30.71	45
9	16650.9	-51.44	8.41	14.95	Horizontal	-44.90	-13.00	31.90	270
10	18501.0	-	-	-	-	-	-	-	-

Note: 1.The other Spurious RF Radiated emissions level is no more than noise floor.
 2. The worst emission was found in the antenna is Horizontal position.

NB-IOT Band 2 15kHz QPSK CH-Middle

Harmonic	Frequency (MHz)	SG (dBm)	Cable Loss (dB)	Gain (dBi)	Antenna Polarization	EIRP Level (dBm)	Limit (dBm)	Margin (dB)	Azimuth (deg)
2	3760.0	-62.33	5.10	11.05	Horizontal	-56.38	-13.00	43.38	90
3	5640.0	-62.76	5.42	12.65	Horizontal	-55.53	-13.00	42.53	45
4	7520.0	-58.84	6.70	13.85	Horizontal	-51.69	-13.00	38.69	270
5	9400.0	-55.70	7.01	14.75	Horizontal	-47.96	-13.00	34.96	0
6	11280.0	-54.39	7.48	15.95	Horizontal	-45.92	-13.00	32.92	0
7	13160.0	-55.19	7.51	16.55	Horizontal	-46.15	-13.00	33.15	315
8	15040.0	-53.06	8.24	15.35	Horizontal	-45.95	-13.00	32.95	135
9	16920.0	-51.60	8.41	14.95	Horizontal	-45.06	-13.00	32.06	45
10	18800.0	-	-	-	-	-	-	-	-

Note: 1.The other Spurious RF Radiated emissions level is no more than noise floor.
 2. The worst emission was found in the antenna is Horizontal position.

NB-IOT Band 2 15kHz QPSK CH-High

Harmonic	Frequency (MHz)	SG (dBm)	Cable Loss (dB)	Gain (dBi)	Antenna Polarization	EIRP Level (dBm)	Limit (dBm)	Margin (dB)	Azimuth (deg)
2	3819.8	-59.59	5.10	11.05	Horizontal	-53.64	-13.00	40.64	270
3	5729.7	-62.14	5.42	12.65	Horizontal	-54.91	-13.00	41.91	45
4	7639.6	-57.11	6.70	13.85	Horizontal	-49.96	-13.00	36.96	90
5	9549.5	-55.95	7.01	14.75	Horizontal	-48.21	-13.00	35.21	90
6	11459.4	-53.48	7.48	15.95	Horizontal	-45.01	-13.00	32.01	0
7	13369.3	-54.15	7.51	16.55	Horizontal	-45.11	-13.00	32.11	315
8	15279.2	-51.73	8.24	15.35	Horizontal	-44.62	-13.00	31.62	180
9	17189.1	-50.06	8.41	14.95	Horizontal	-43.52	-13.00	30.52	45
10	19099.0	-	-	-	-	-	-	-	-

Note: 1.The other Spurious RF Radiated emissions level is no more than noise floor.
 2. The worst emission was found in the antenna is Horizontal position.

NB-IOT Band 25 15kHz QPSK CH-Low

Harmonic	Frequency (MHz)	SG (dBm)	Cable Loss (dB)	Gain (dBi)	Antenna Polarization	EIRP Level (dBm)	Limit (dBm)	Margin (dB)	Azimuth (deg)
2	3700.2	-63.38	5.10	11.05	Horizontal	-57.43	-13.00	44.43	90
3	5550.3	-62.84	5.42	12.65	Horizontal	-55.61	-13.00	42.61	135
4	7400.4	-57.85	6.70	13.85	Horizontal	-50.70	-13.00	37.70	180
5	9250.5	-56.41	7.01	14.75	Horizontal	-48.67	-13.00	35.67	315
6	11100.6	-56.78	7.48	15.95	Horizontal	-48.31	-13.00	35.31	45
7	12950.7	-54.14	7.51	16.55	Horizontal	-45.10	-13.00	32.10	270
8	14800.8	-52.34	8.24	15.35	Horizontal	-45.23	-13.00	32.23	180
9	16650.9	-51.03	8.41	14.95	Horizontal	-44.49	-13.00	31.49	225
10	18501.0	-	-	-	-	-	-	-	-

Note: 1.The other Spurious RF Radiated emissions level is no more than noise floor.
 2. The worst emission was found in the antenna is Horizontal position.

NB-IOT Band 25 15kHz QPSK CH-Middle

Harmonic	Frequency (MHz)	SG (dBm)	Cable Loss (dB)	Gain (dBi)	Antenna Polarization	EIRP Level (dBm)	Limit (dBm)	Margin (dB)	Azimuth (deg)
2	3765.0	-62.62	5.10	11.05	Horizontal	-56.67	-13.00	43.67	225
3	5647.5	-62.94	5.42	12.65	Horizontal	-55.71	-13.00	42.71	0
4	7530.0	-58.24	6.70	13.85	Horizontal	-51.09	-13.00	38.09	180
5	9412.5	-56.39	7.01	14.75	Horizontal	-48.65	-13.00	35.65	315
6	11295.0	-55.60	7.48	15.95	Horizontal	-47.13	-13.00	34.13	90
7	13177.5	-55.24	7.51	16.55	Horizontal	-46.20	-13.00	33.20	45
8	15060.0	-52.35	8.24	15.35	Horizontal	-45.24	-13.00	32.24	315
9	16942.5	-50.52	8.41	14.95	Horizontal	-43.98	-13.00	30.98	180
10	18825.0	-	-	-	-	-	-	-	-

Note: 1.The other Spurious RF Radiated emissions level is no more than noise floor.
 2. The worst emission was found in the antenna is Horizontal position.



NB-IOT Band 25 15kHz QPSK CH-High

Harmonic	Frequency (MHz)	SG (dBm)	Cable Loss (dB)	Gain (dBi)	Antenna Polarization	EIRP Level (dBm)	Limit (dBm)	Margin (dB)	Azimuth (deg)
2	3829.8	-58.86	5.10	11.05	Horizontal	-52.91	-13.00	39.91	135
3	5744.7	-62.31	5.42	12.65	Horizontal	-55.08	-13.00	42.08	45
4	7659.6	-57.29	6.70	13.85	Horizontal	-50.14	-13.00	37.14	0
5	9574.5	-57.04	7.01	14.75	Horizontal	-49.30	-13.00	36.30	90
6	11489.4	-54.56	7.48	15.95	Horizontal	-46.09	-13.00	33.09	180
7	13404.3	-54.41	7.51	16.55	Horizontal	-45.37	-13.00	32.37	315
8	15319.2	-53.88	8.24	15.35	Horizontal	-46.77	-13.00	33.77	270
9	17234.1	-50.82	8.41	14.95	Horizontal	-44.28	-13.00	31.28	225
10	19149.0	-	-	-	-	-	-	-	-

Note: 1. The other Spurious RF Radiated emissions level is no more than noise floor.

2. The worst emission was found in the antenna is Horizontal position.



6. Main Test Instruments

Name	Manufacturer	Type	Serial Number	Calibration Date	Expiration Date
Base Station Simulator	R&S	CMU200	118133	2019-05-19	2020-05-18
Base Station Simulator	R&S	CMU200	118133	2020-05-18	2021-05-17
Base Station Simulator	R&S	CMW500	113824	2019-05-19	2020-05-18
Base Station Simulator	R&S	CMW500	113824	2020-05-18	2021-05-17
Power Splitter	Hua Xiang	SHX-GF2-2-13	10120101	/	/
Spectrum Analyzer	Key sight	N9010A	MY50210259	2019-12-15	2020-12-14
Universal Radio Communication Tester	Key sight	E5515C	MY48367192	2019-05-19	2020-05-18
Universal Radio Communication Tester	Key sight	E5515C	MY48367192	2020-05-18	2021-05-17
Signal Analyzer	R&S	FSV30	100815	2019-12-15	2020-12-14
Loop Antenna	SCHWARZBECK	FMZB1519	1519-047	2017-09-26	2020-09-25
Trilog Antenna	SCHWARZBECK	VUBL 9163	9163-201	2017-11-18	2020-11-17
Horn Antenna	R&S	HF907	100126	2018-07-07	2020-07-06
Horn Antenna	ETS-Lindgren	3160-09	00102643	2018-06-20	2020-06-19
Signal generator	R&S	SMB 100A	102594	2019-05-19	2020-05-18
Signal generator	R&S	SMB 100A	102594	2020-05-18	2021-05-17
Climatic Chamber	ESPEC	SU-242	93000506	2017-12-17	2020-12-16
Preampfier	R&S	SCU18	102327	2019-05-19	2020-05-18
Preampfier	R&S	SCU18	102327	2020-05-18	2021-05-17
MOB COMMS DC SUPPLY	Keysight	66319D	MY43004105	2019-05-19	2020-05-18
MOB COMMS DC SUPPLY	Keysight	66319D	MY43004105	2020-05-18	2021-05-17
RF Cable	Agilent	SMA 15cm	0001	2019-12-13	2020-06-12
Software	R&S	EMC32	9.26.0	/	/

*****END OF REPORT *****