



# RF TEST REPORT

**Applicant**      Quectel Wireless Solutions Co., Ltd  
**FCC ID**          XMR202004BG600LM3  
**Product**        LTE Cat M1 & Cat NB2 & EGPRS Module  
**Brand**            Quectel  
**Model**            BG600L-M3  
**Report No.**      R2003A0168-R4  
**Issue Date**     June 8, 2020

TA Technology (Shanghai) Co., Ltd. tested the above equipment in accordance with the requirements in **FCC CFR47 Part 2 (2019)/ FCC CFR 47 Part 22H (2019)**. The test results show that the equipment tested is capable of demonstrating compliance with the requirements as documented in this report.

*Performed by: Peng Tao*

*Approved by: Kai Xu*

---

## TA Technology (Shanghai) Co., Ltd.

*No.145, Jintang Rd, Tangzhen Industry Park, Pudong Shanghai, China*

*TEL: +86-021-50791141/2/3*

*FAX: +86-021-50791141/2/3-8000*



## TABLE OF CONTENT

1. Test Laboratory .....	4
1.1. Notes of the Test Report .....	4
1.2. Test facility .....	4
1.3. Testing Location .....	4
2. General Description of Equipment under Test.....	5
2.3. Applicant and Manufacturer Information .....	5
2.4. General Information.....	5
3. Applied Standards .....	6
4. Test Configuration.....	7
5. Test Case Results.....	8
5.1. RF Power Output and Effective Radiated Power .....	8
5.2. Occupied Bandwidth .....	11
5.3. Band Edge Compliance.....	14
5.4. Peak-to-Average Power Ratio (PAPR) .....	21
5.5. Frequency Stability .....	23
5.6. Spurious Emissions at Antenna Terminals .....	28
5.7. Radiates Spurious Emission .....	33
6. Main Test Instruments .....	38



### Summary of measurement results

No.	Test Case	Clause in FCC rules	Verdict
1	RF Power Output and Effective Radiated Power	2.1046 22.913(a)(5)	PASS
2	Occupied Bandwidth	2.1049	PASS
3	Band Edge Compliance	2.1051 / 22.917(a)	PASS
4	Peak-to-Average Power Ratio	22.913(d)/ KDB 971168 D01(5.7)	PASS
5	Frequency Stability	2.1055 / 22.355	PASS
6	Spurious Emissions at Antenna Terminals	2.1051 / 22.917(a)	PASS
7	Radiates Spurious Emission	2.1053 / 22.917 (a)	PASS

Date of Testing: April 20, 2020~ May 21, 2020

Note: All indications of Pass/Fail in this report are opinions expressed by TA Technology (Shanghai) Co., Ltd. based on interpretations and/or observations of test results. Measurement Uncertainties were not taken into account and are published for informational purposes only.



## 1. Test Laboratory

### 1.1. Notes of the Test Report

This report shall not be reproduced in full or partial, without the written approval of **TA technology (shanghai) co., Ltd.** The results documented in this report apply only to the tested sample, under the conditions and modes of operation as described herein .Measurement Uncertainties were not taken into account and are published for informational purposes only. This report is written to support regulatory compliance of the applicable standards stated above.

### 1.2. Test facility

#### **FCC (Designation number: CN1179, Test Firm Registration Number: 446626)**

TA Technology (Shanghai) Co., Ltd. has been listed on the US Federal Communications Commission list of test facilities recognized to perform electromagnetic emissions measurements.

#### **A2LA (Certificate Number: 3857.01)**

TA Technology (Shanghai) Co., Ltd. has been listed by American Association for Laboratory Accreditation to perform electromagnetic emission measurement.

### 1.3. Testing Location

Company: TA Technology (Shanghai) Co., Ltd.  
Address: No.145, Jintang Rd, Tangzhen Industry Park, Pudong  
City: Shanghai  
Post code: 201201  
Country: P. R. China  
Contact: Xu Kai  
Telephone: +86-021-50791141/2/3  
Fax: +86-021-50791141/2/3-8000  
Website: <http://www.ta-shanghai.com>  
E-mail: [xukai@ta-shanghai.com](mailto:xukai@ta-shanghai.com)

## 2. General Description of Equipment under Test

### 2.3. Applicant and Manufacturer Information

Applicant	Quectel Wireless Solutions Co., Ltd
Applicant address	Building 5, Shanghai Business Park Phase III (Area B), No.1016 Tianlin Road, Minhang District, Shanghai, China 200233
Manufacturer	Quectel Wireless Solutions Co., Ltd
Manufacturer address	Building 5, Shanghai Business Park Phase III (Area B), No.1016 Tianlin Road, Minhang District, Shanghai, China 200233

### 2.4. General Information

EUT Description			
Model	BG600L-M3		
IMEI	860873040012816		
Hardware Version	R1.2		
Software Version	BG600LM3LAR02A03		
Power Supply	External Power Supply		
Antenna Type	The EUT don't have standard Antenna, The Antenna used for testing in this report is the after-market accessory (Dipole Antenna)		
Antenna Gain	Frequency(MHz)	Gain(dBi)	
	820	2.53	
	840	1.89	
	850	2.29	
Test Mode(s)	LTE Band 5;		
Test Modulation	(LTE)QPSK 16QAM;		
LTE Category	M1		
Maximum E.R.P.	LTE Band 5:	22.06dBm	
Rated Power Supply Voltage	3.8V		
Extreme Voltage	Minimum: 3.3V Maximum: 4.3V		
Extreme Temperature	Lowest: -40°C Highest: +85°C		
Operating Frequency Range(s)	Band	Tx (MHz)	Rx (MHz)
	LTE Band 5	824 ~ 849	869 ~ 894
Note: 1. The EUT is sent from the applicant to TA and the information of the EUT is declared by the applicant.			



### 3. Applied Standards

According to the specifications of the manufacturer, it must comply with the requirements of the following standards:

**Test standards:**

**FCC CFR 47 Part 22H (2019)**

**ANSI C63.26 (2015)**

**Reference standard:**

**FCC CFR47 Part 2 (2019)**

**KDB 971168 D01 Power Meas License Digital Systems v03r01**

## 4. Test Configuration

Radiated measurements are performed by rotating the EUT in three different orthogonal test planes. EUT stand-up position (Z axis), lie-down position (X, Y axis). Receiver antenna polarization (horizontal and vertical), the worst emission was found in position (Z axis, horizontal polarization) and the worst case was recorded.

All mode and data rates and positions were investigated. Subsequently, only the worst case emissions are reported.

The following testing in LTE is set based on the maximum RF Output Power.

Test modes are chosen as the worst case configuration below for LTE Band 5.

Test items	Bandwidth (MHz)				Modulation		RB			Test Channel		
	1.4	3	5	10	QPSK	16QAM	1	50%	100%	L	M	H
RF power output and Effective Radiated power	O	O	O	O	O	O	O	O	O	O	O	O
Occupied Bandwidth	O	O	O	O	O	O	-	-	O	-	O	-
Band Edge Compliance	O	O	O	O	O	O	O	-	O	O	-	O
Peak-to-Average Power Ratio	O	O	O	O	O	O	-	-	O	-	O	-
Frequency Stability	O	O	O	O	O	O	O	O	O	O	O	O
Spurious Emissions at Antenna Terminals	O	O	O	O	O	-	O	-	-	O	O	O
Radiates Spurious Emission	O	-	O	O	O	-	O	-	-	-	O	-
Note	1. The mark "O" means that this configuration is chosen for testing. 2. The mark "-" means that this configuration is not testing.											

## 5. Test Case Results

### 5.1. RF Power Output and Effective Radiated Power

#### Ambient condition

Temperature	Relative humidity	Pressure
23°C ~25°C	45%~50%	101.5kPa

#### Methods of Measurement

During the process of the testing, The EUT is controlled by the Base Station Simulator to ensure max power transmission and proper modulation.

The testing follows FCC KDB 971168 v03r01 Section 5.8 and ANSI C63.26 (2015).

a) Connect the equipment as illustrated. Mount the equipment with the manufacturer specified antenna in a vertical orientation on a manufacturer specified mounting surface located on a non-conducting rotating platform of a RF anechoic chamber (preferred) or a standard radiation site.

b) Key the transmitter, then rotate the EUT 360° azimuthally and record spectrum analyzer power level (LVL) measurements at angular increments that are sufficiently small to permit resolution of all peaks. If a standard radiation test site is used, raise and lower the test antenna to obtain a maximum reading at each angular increment. (Note: several batteries may be needed to offset the effect of battery voltage droop, which should not exceed 5% of the manufactured specified battery voltage during transmission).

c) Replace the transmitter under test with a vertically polarized half-wave dipole (or an antenna whose gain is known relative to an ideal half-wave dipole). The center of the antenna should be at the same location as the center of the antenna under test.

d) Connect the antenna to a signal generator with a known output power and record the path loss (in dB) as LOSS. If a standard radiation test site is used, raise and lower the test antenna to obtain a maximum reading.  $LOSS = \text{Generator Output Power (dBm)} - \text{Analyzer reading (dBm)}$

e) Determine the effective radiated output power at each angular position from the readings in steps b) and d) using the following equation:  $ERP \text{ (dBm)} = \text{LVL (dBm)} + \text{LOSS (dB)}$

f) The maximum ERP is the maximum value determined in the preceding step.

g) When calculating ERP, in addition to knowing the antenna radiation and matching characteristics, it is necessary to know the loss values of all elements (e.g. transmission line attenuation, mismatches, filters, combiners) interposed between the point where transmitter output power is measured, and the point where power is applied to the antenna. ERP can then be calculated as follows:

$$EIRP \text{ (dBm)} = \text{Output Power (dBm)} - \text{Losses (dB)} + \text{Antenna Gain (dBi)}$$

where: dBd refers to gain relative to an ideal dipole.

$$EIRP \text{ (dBm)} = ERP \text{ (dBm)} + 2.15 \text{ (dB.)}$$

The RB allocation refers to section 5.1, using the maximum output power configuration.



**Test Setup**

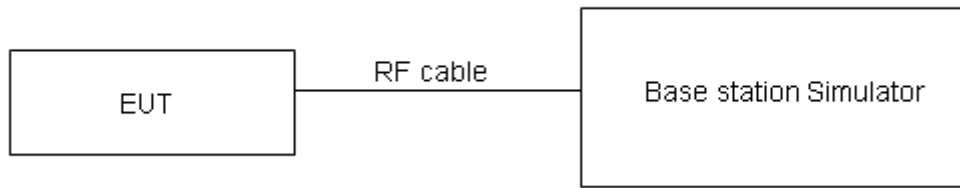

The loss between RF output port of the EUT and the input port of the tester has been taken into consideration.

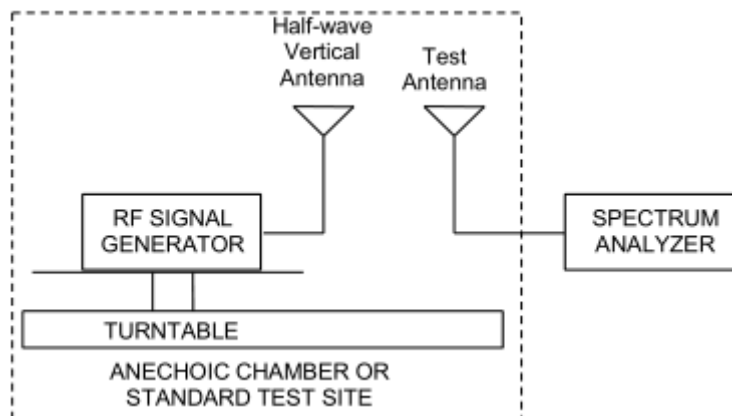
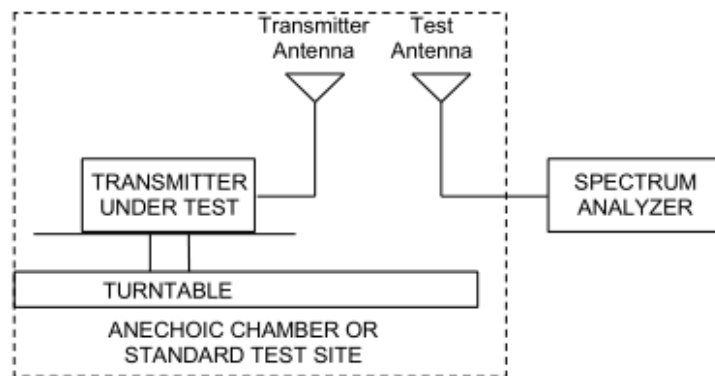

**Limits**

No specific RF power output requirements in part 2.1046.

Rule Part 22.913(a)(5) specifies that "Mobile/portable stations are limited to 7 watts ERP".

Limit	$\leq 7 \text{ W}$ (38.45 dBm)
-------	--------------------------------

**Measurement Uncertainty**

The assessed measurement uncertainty to ensure 95% confidence level for the normal distribution is with the coverage factor  $k = 2$ ,  $U = 0.4 \text{ dB}$  for RF power output,  $k = 2$ ,  $U = 1.19 \text{ dB}$  for ERP .



## Test Results

LTE Band 5	Channel/ Frequency(MHz)	Index	RB# RBstart	Conducted Power (dBm)		ERP (dBm)	
				QPSK	16QAM	QPSK	16QAM
1.4MHz	20407/824.7	0	1#0	21.02	20.67	21.40	21.05
		0	6#0	19.21	19.07	19.59	19.45
	20525/836.5	0	1#0	21.75	19.96	21.49	19.70
		0	6#0	19.32	19.97	19.06	19.71
	20643/848.3	0	1#5	21.50	20.07	21.64	20.21
		0	6#0	19.33	19.92	19.47	20.06
3MHz	20415/825.5	0	1#0	21.42	20.05	21.80	20.43
		0	6#0	19.14	19.62	19.52	20.00
	20525/836.5	0	1#0	21.57	20.46	21.31	20.20
		0	6#0	19.27	19.44	19.01	19.18
	20635/847.5	1	1#5	21.27	20.04	21.41	20.18
		1	6#0	19.31	19.61	19.45	19.75
5MHz	20425/826.5	0	1#0	21.20	20.80	21.58	21.18
		0	6#0	20.24	20.44	20.62	20.82
	20525/836.5	0	1#0	21.28	20.95	21.02	20.69
		0	6#0	20.33	20.50	20.07	20.24
	20625/846.5	3	1#5	21.14	20.95	21.28	21.09
		3	6#0	20.25	20.38	20.39	20.52
10MHz	20450/829	0	1#0	21.23	20.80	21.61	21.18
		0	4#0	21.28	21.68	21.66	22.06
	20525/836.5	0	1#0	21.33	20.75	21.07	20.49
		0	4#0	21.36	21.46	21.10	21.20
	20600/844	7	1#5	21.15	20.74	21.29	20.88
		7	4#2	21.22	21.30	21.36	21.44

## 5.2. Occupied Bandwidth

### Ambient condition

Temperature	Relative humidity	Pressure
23°C ~25°C	45%~50%	101.5kPa

### Method of Measurement

The EUT was connected to Spectrum Analyzer and Base Station Simulator via power Splitter. The occupied bandwidth is measured using spectrum analyzer.

RBW is set to 51kHz, VBW is set to 160kHz for LTE Band 5

99% power and -26dBc occupied bandwidths are recorded. Spectrum analyzer plots are included on the following pages.

### Test Setup

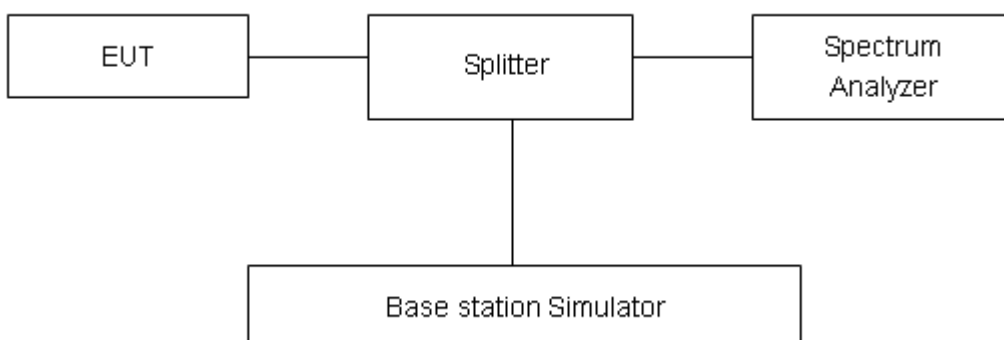

### Limits

No specific occupied bandwidth requirements in part 2.1049.

### Measurement Uncertainty

The assessed measurement uncertainty to ensure 95% confidence level for the normal distribution is with the coverage factor  $k = 2$ ,  $U = 624\text{Hz}$ .

Test Result

Mode	Bandwidth	Modulation	Channel/ Frequency(MHz)	RB	Index	Bandwidth(MHz)	
						99% Power	-26dBc
LTE Band 5	1.4MHz	QPSK	20525/836.5	6#0	0	1.1066	1.360
		16QAM	20525/836.5	6#0	0	0.9399	1.163
	3MHz	QPSK	20525/836.5	6#0	0	1.1106	1.368
		16QAM	20525/836.5	6#0	0	0.9402	1.140
	5MHz	QPSK	20525/836.5	6#0	0	1.1098	1.313
		16QAM	20525/836.5	6#0	0	0.9488	1.197
10MHz	QPSK	20525/836.5	6#0	0	1.1187	1.336	
	16QAM	20525/836.5	6#0	0	0.9619	1.191	

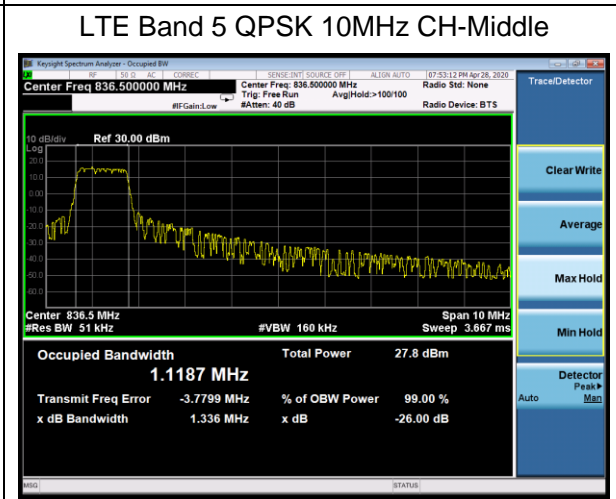
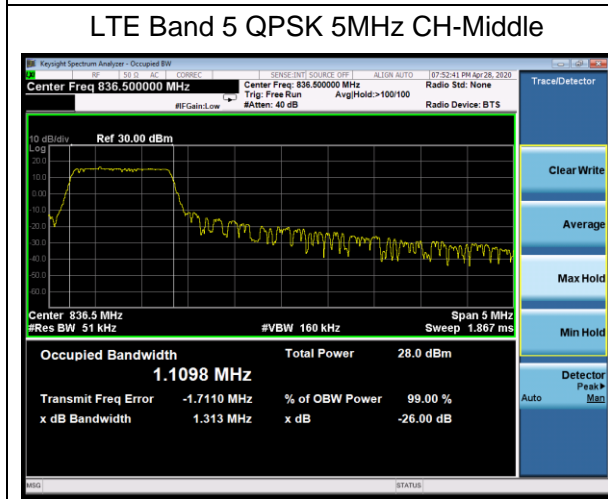
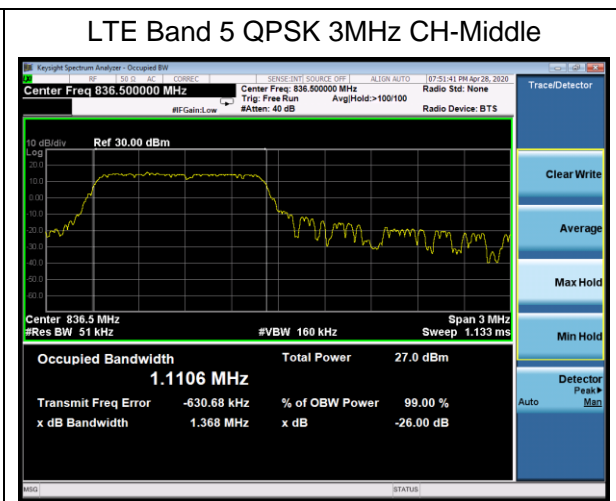
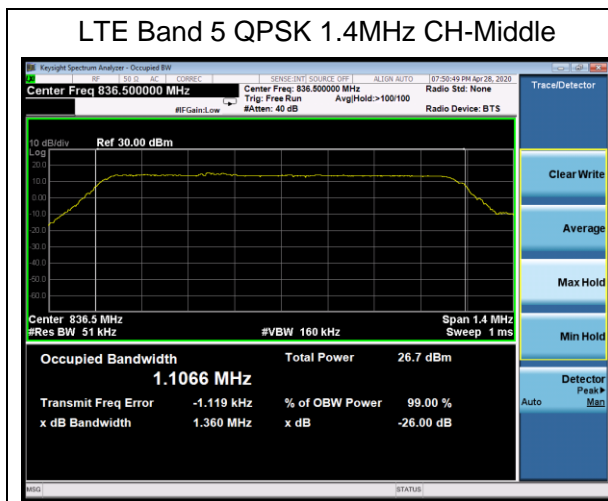

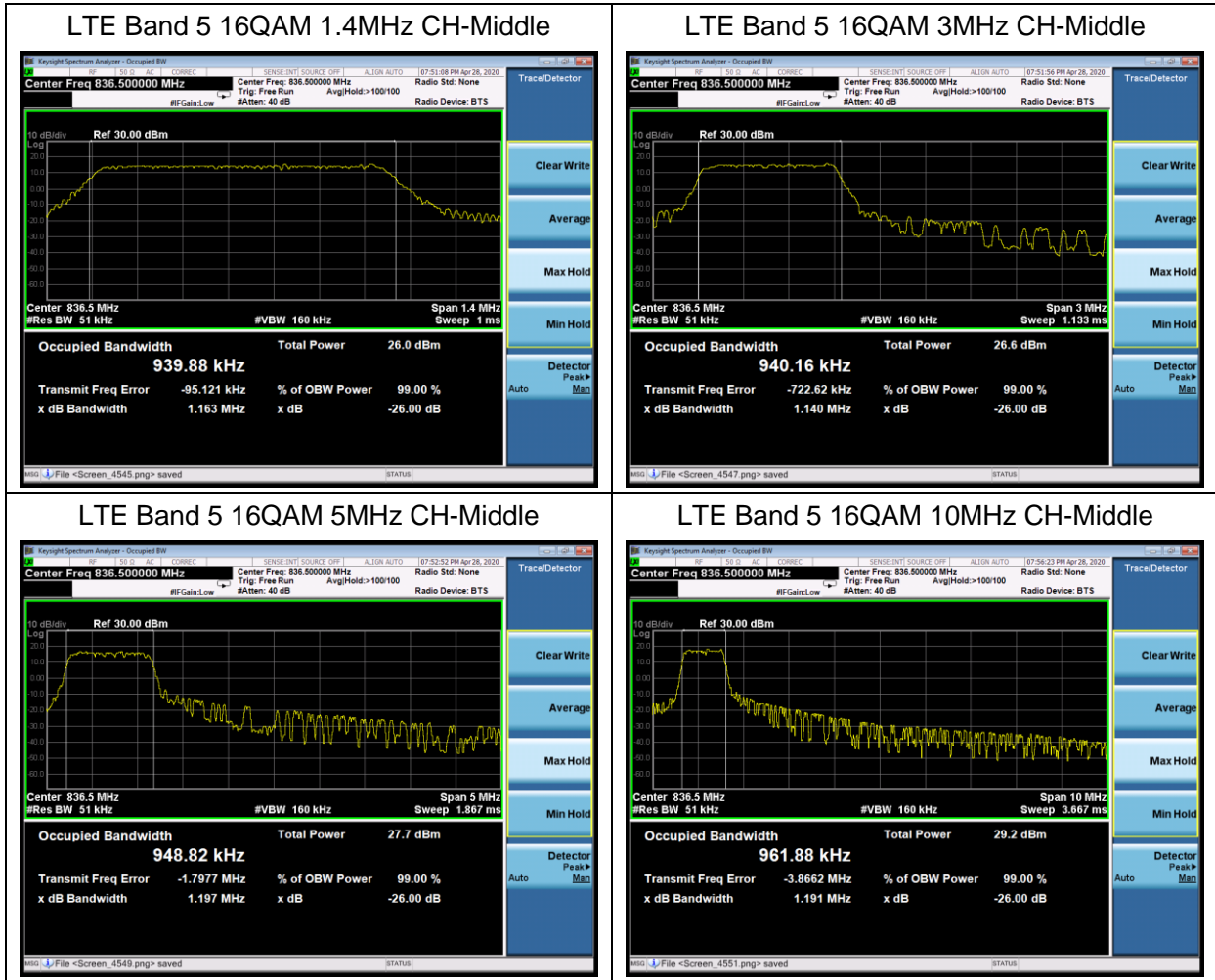

### 5.3. Band Edge Compliance

#### Ambient condition

Temperature	Relative humidity	Pressure
23°C ~25°C	45%~50%	101.5kPa

#### Method of Measurement

The EUT was connected to Spectrum Analyzer and Base Station Simulator via power Splitter. The band edge of the lowest and highest channels were measured. The average detector is used. RBW is set to 51kHz, VBW is set to 160kHz for LTE Band 5

Spectrum analyzer plots are included on the following pages.

#### Test Setup

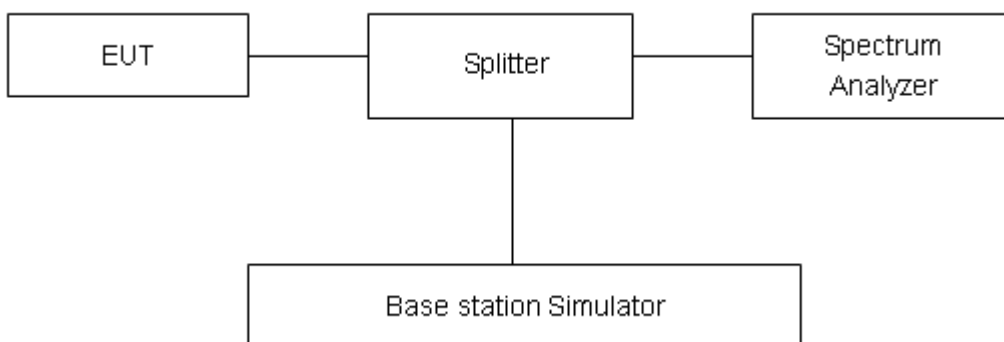

#### Limits

Rule Part 22.917(a) specifies that “The power of any emission outside of the authorized operating frequency ranges must be attenuated below the transmitting power (P) by a factor of at least 43 + 10 log(P) dB.”

Limit	-13 dBm
-------	---------

#### Measurement Uncertainty

The assessed measurement uncertainty to ensure 95% confidence level for the normal distribution is with the coverage factor  $k = 1.96$ ,  $U=0.684$ dB.



Test Result:

LTE Band 5 QPSK 1.4MHz CH-Low 1RB

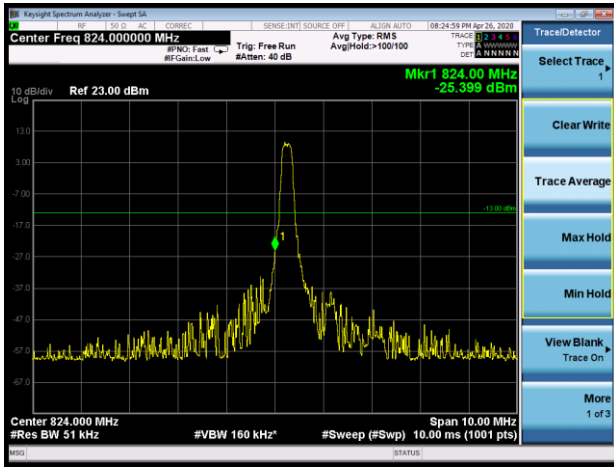

LTE Band 5 QPSK 1.4MHz CH-High 1RB

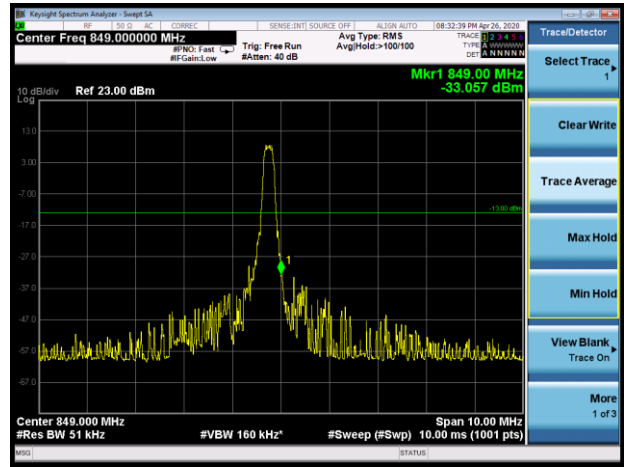

LTE Band 5 QPSK 1.4MHz CH-Low 100%RB

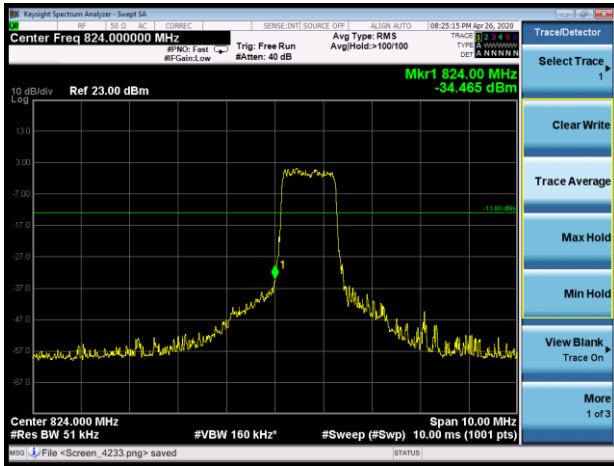

LTE Band 5 QPSK 1.4MHz CH-High 100%RB

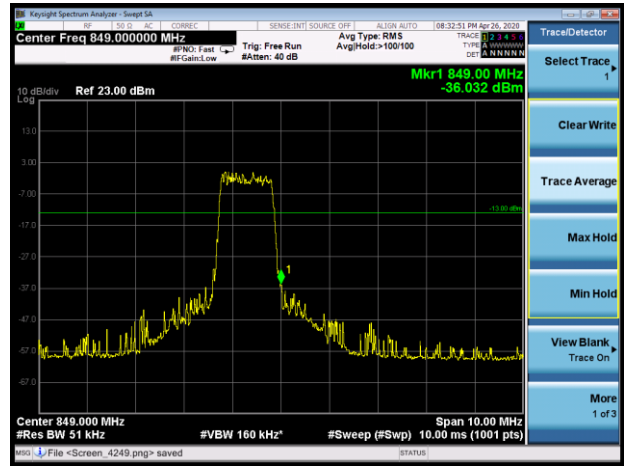

LTE Band 5 QPSK 3MHz CH-Low 1RB

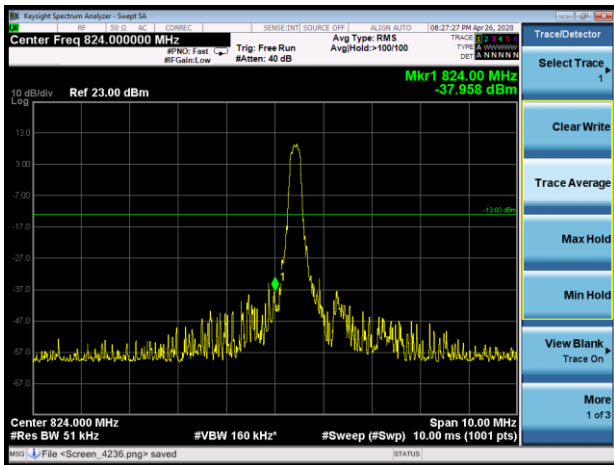

LTE Band 5 QPSK 3MHz CH-High 1RB

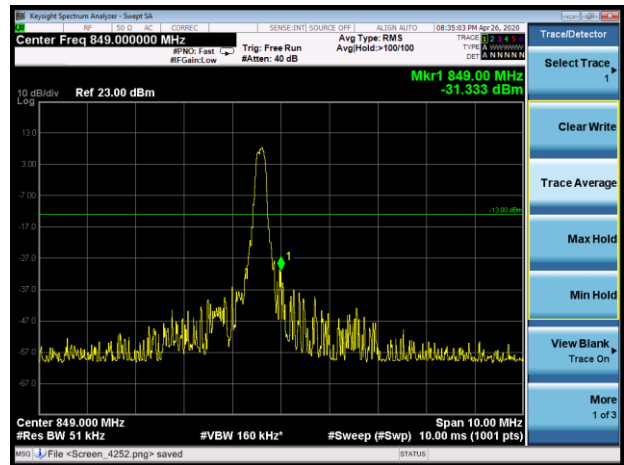

LTE Band 5 QPSK 3MHz CH-Low 100%RB

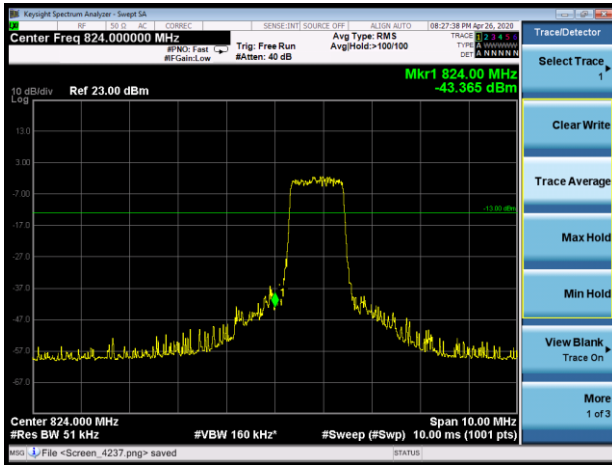

LTE Band 5 QPSK 3MHz CH-High 100%RB

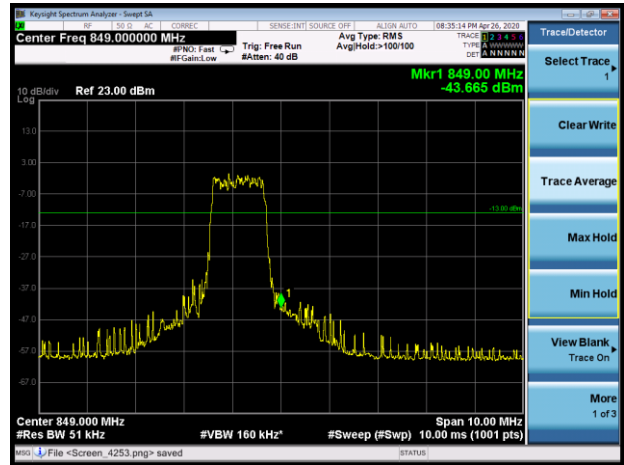

LTE Band 5 QPSK 5MHz CH-Low 1RB

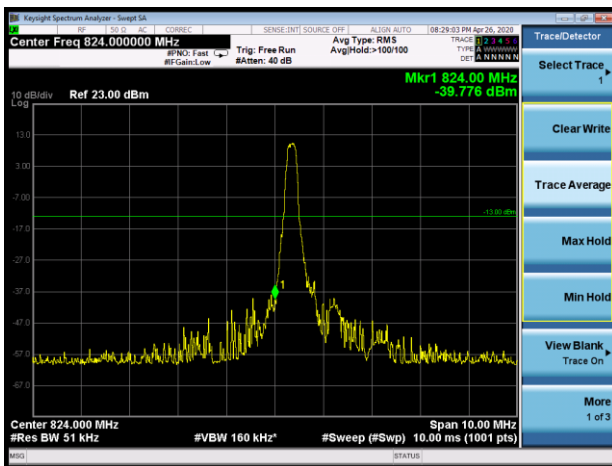

LTE Band 5 QPSK 5MHz CH-High 1RB

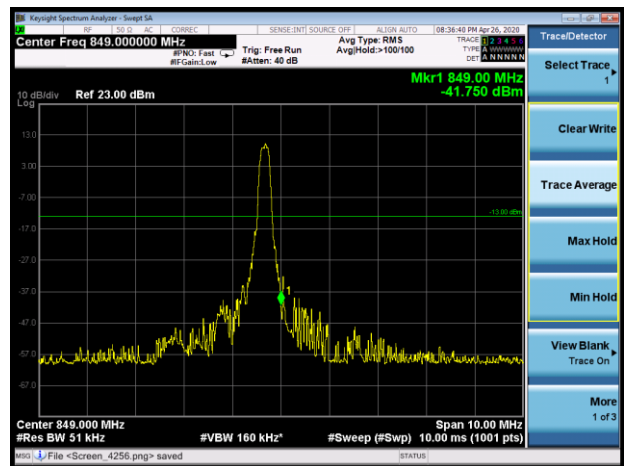

LTE Band 5 QPSK 5MHz CH-Low 100%RB

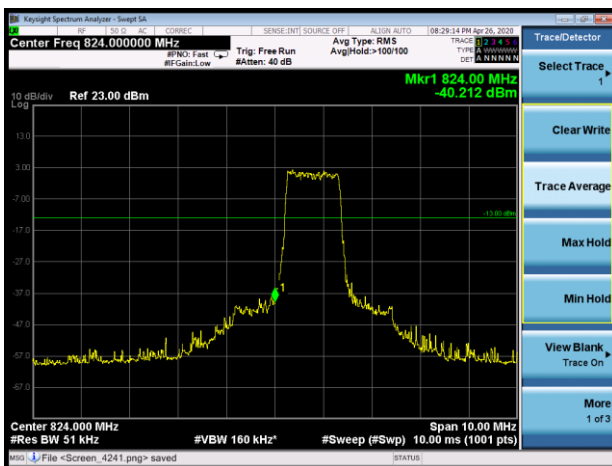

LTE Band 5 QPSK 5MHz CH-High 100%RB

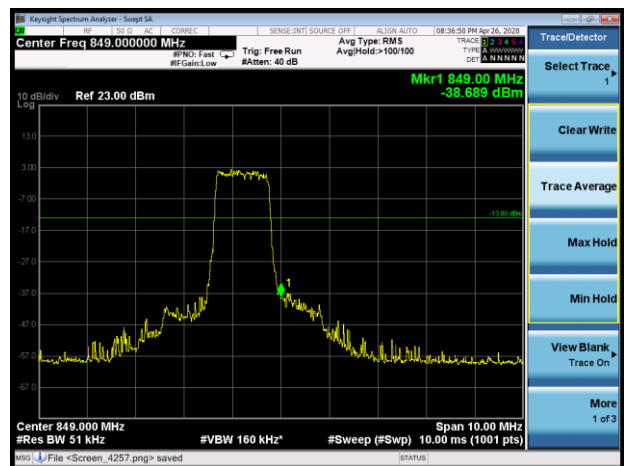





### LTE Band 5 QPSK 10MHz CH-Low 1RB

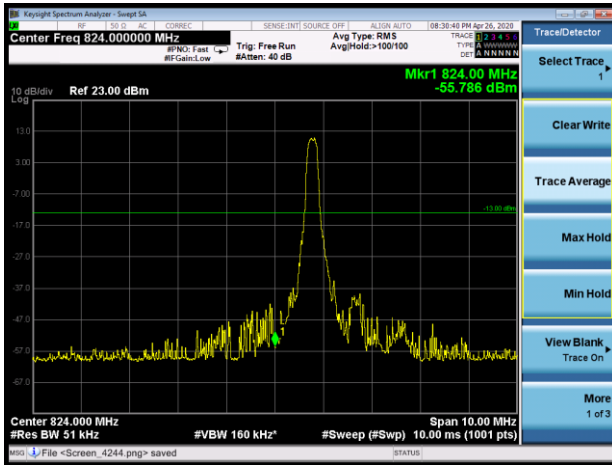

### LTE Band 5 QPSK 10MHz CH-High 1RB

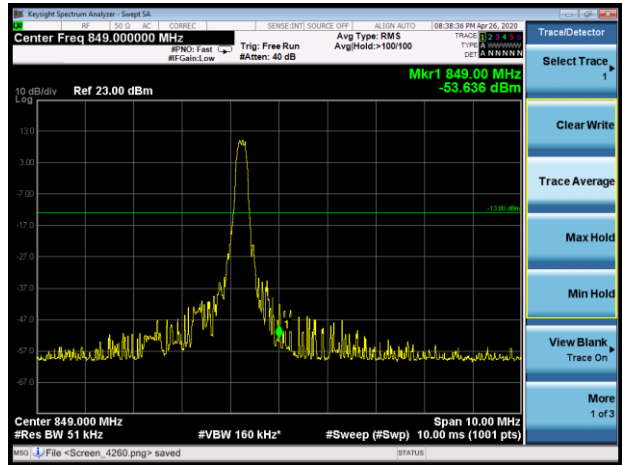

### LTE Band 5 QPSK 10MHz CH-Low 100%RB

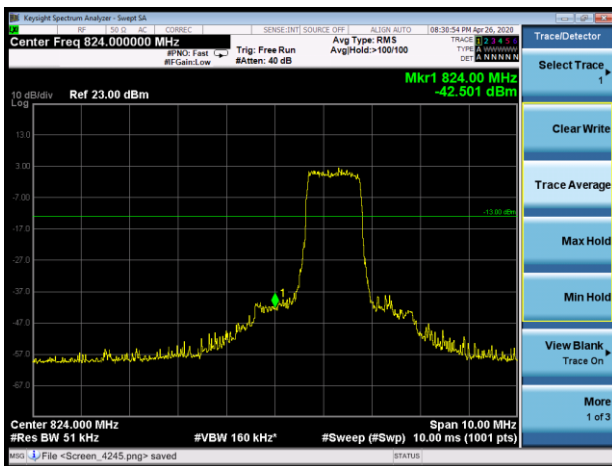

### LTE Band 5 QPSK 10MHz CH-High 100%RB

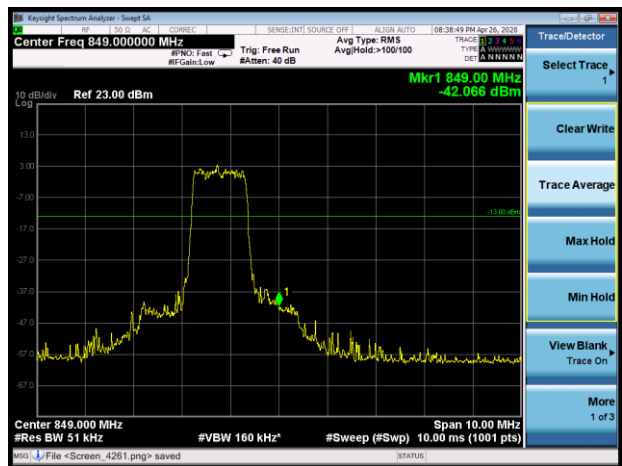

### LTE Band 5 16QAM 1.4MHz CH-Low 1RB

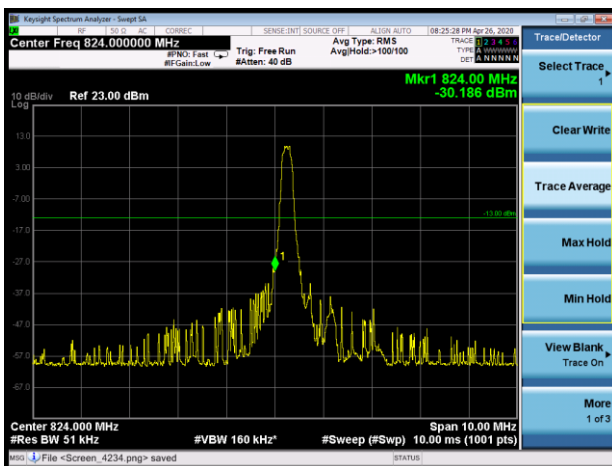

### LTE Band 5 16QAM 1.4MHz CH-High 1RB

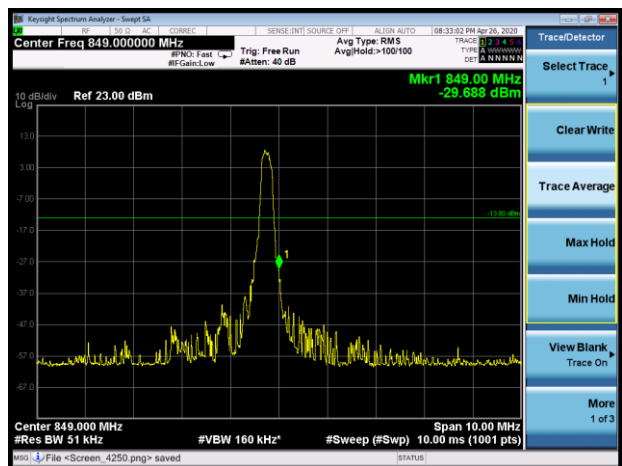



LTE Band 5 16QAM 1.4MHz CH-Low 100%RB

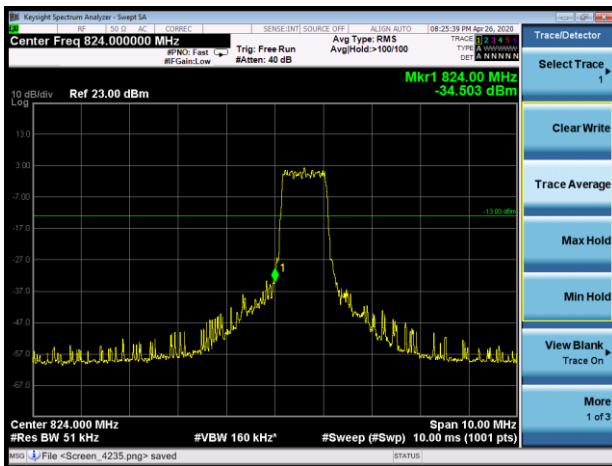

LTE Band 5 16QAM 1.4MHz CH-High 100%RB

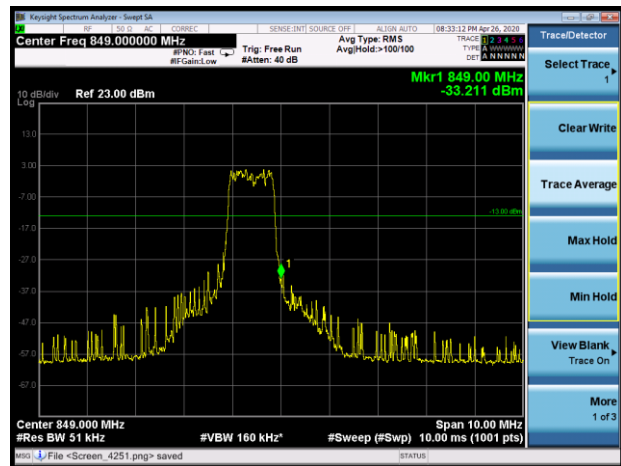

LTE Band 5 16QAM 3MHz CH-Low 1RB

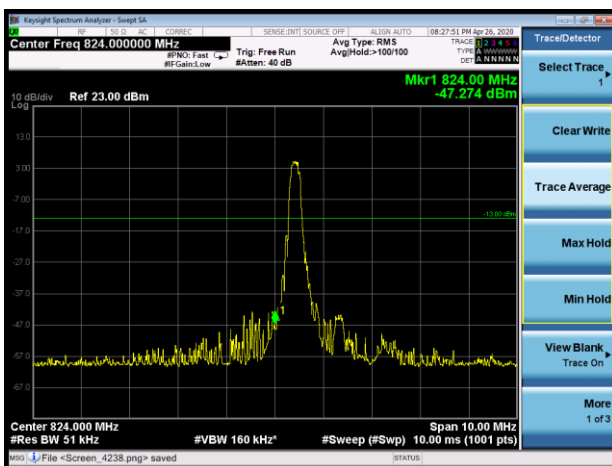

LTE Band 5 16QAM 3MHz CH-High 1RB

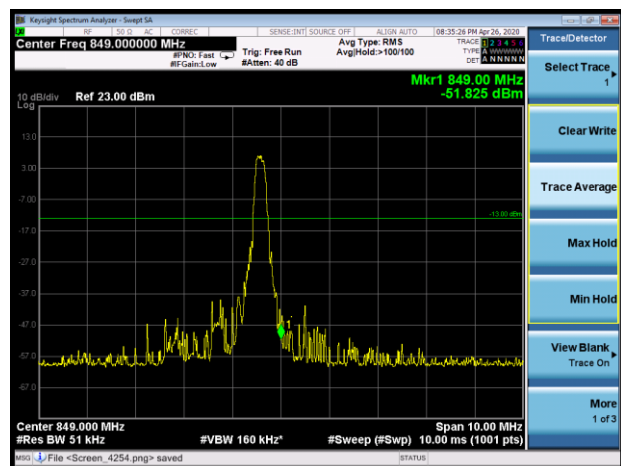

LTE Band 5 16QAM 3MHz CH-Low 100%RB

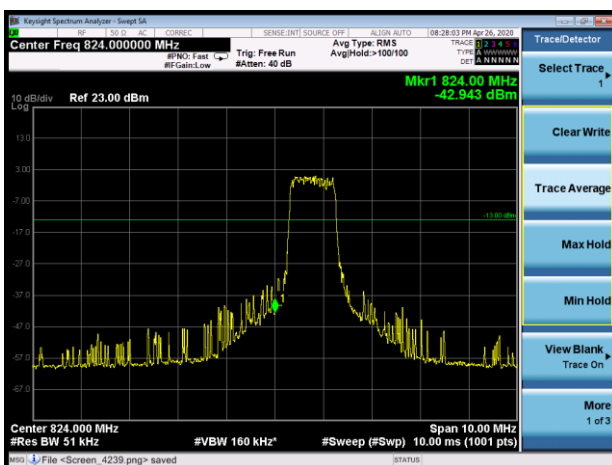

LTE Band 5 16QAM 3MHz CH-High 100%RB

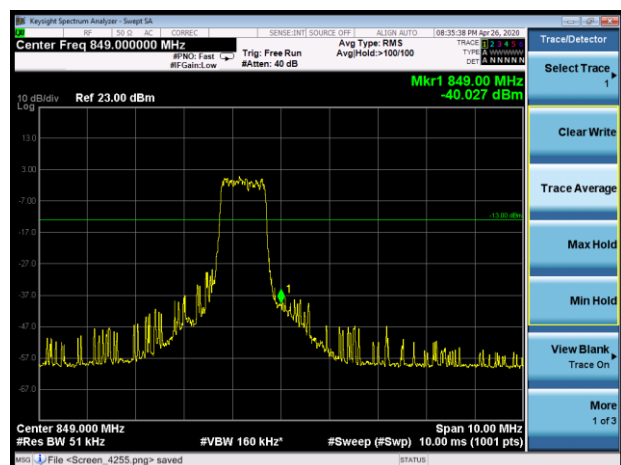



### LTE Band 5 16QAM 5MHz CH-Low 1RB

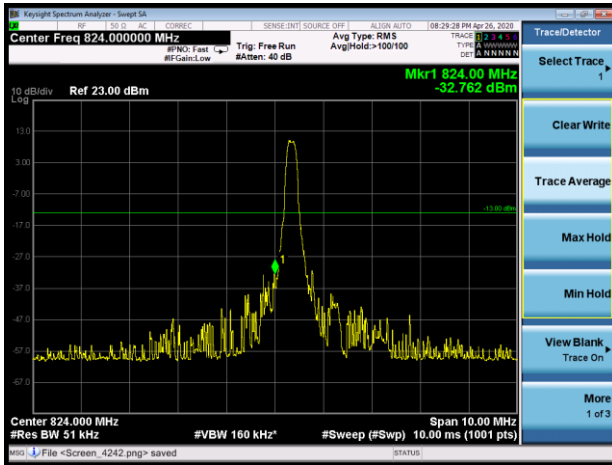

### LTE Band 5 16QAM 5MHz CH-High 1RB

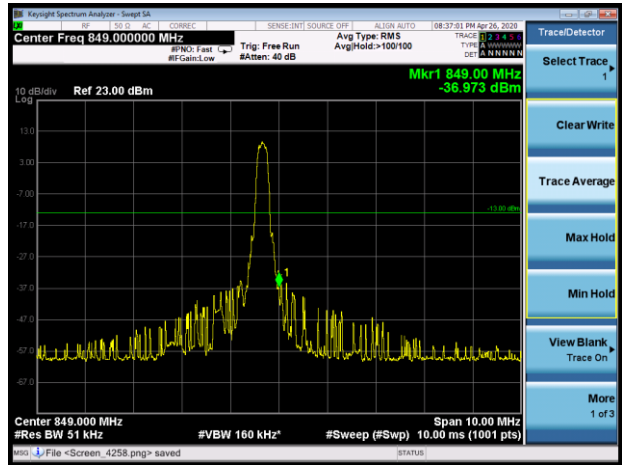

### LTE Band 5 16QAM 5MHz CH-Low 100%RB

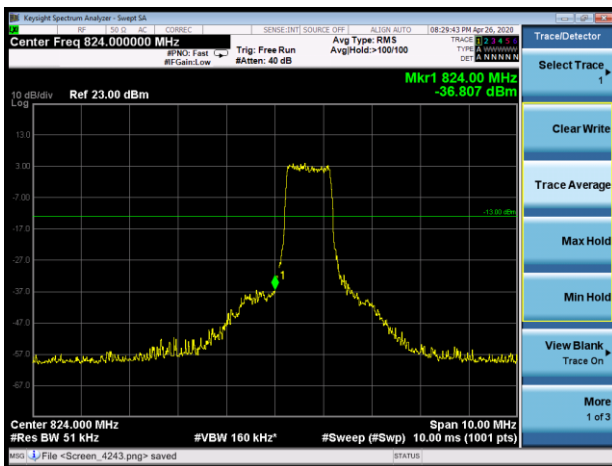

### LTE Band 5 16QAM 5MHz CH-High 100%RB

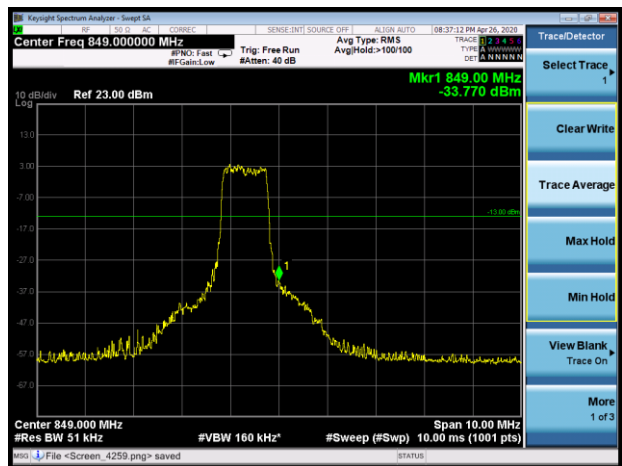

### LTE Band 5 16QAM 10MHz CH-Low 1RB

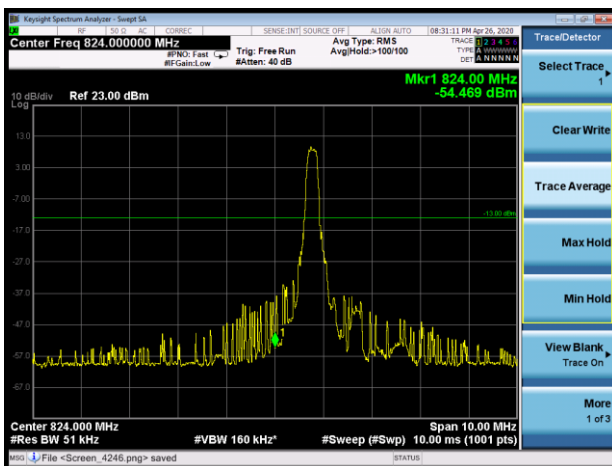

### LTE Band 5 16QAM 10MHz CH-High 1RB

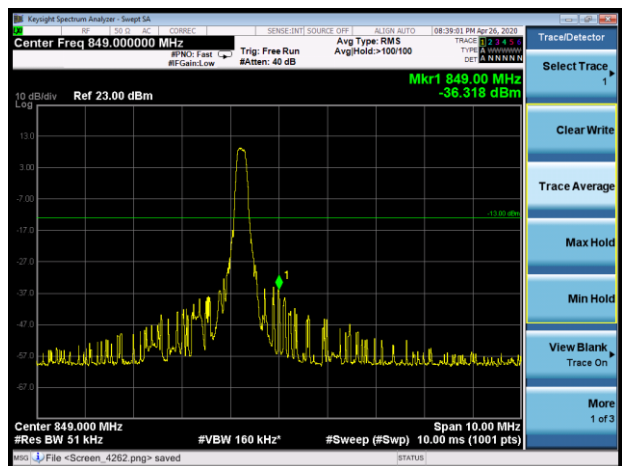



LTE Band 5 16QAM 10MHz CH-Low 100%RB

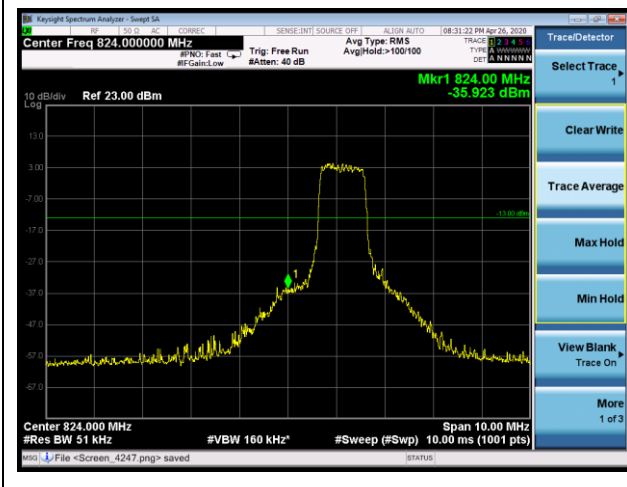

LTE Band 5 16QAM 10MHz CH-High 100%RB

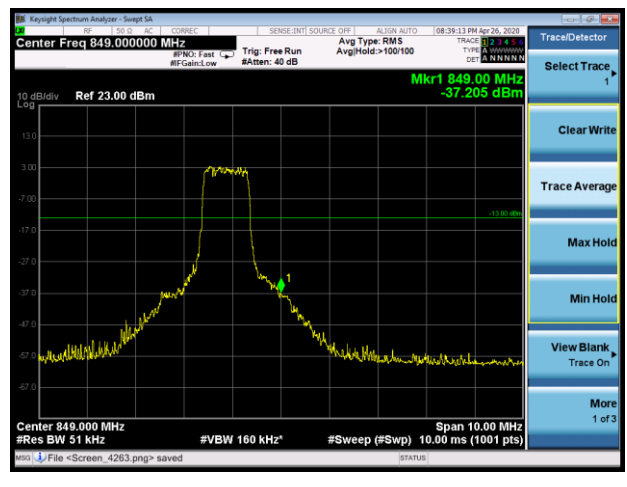

## 5.4. Peak-to-Average Power Ratio (PAPR)

### Ambient condition

Temperature	Relative humidity	Pressure
23°C ~25°C	45%~50%	101.5kPa

### Methods of Measurement

Measure the total peak power and record as  $P_{Pk}$ . And measure the total average power and record as  $P_{Avg}$ . Both the peak and average power levels must be expressed in the same logarithmic units (e.g., dBm). Determine the PAPR from:

$$PAPR (dB) = P_{Pk} (dBm) - P_{Avg} (dBm).$$

### Test Setup

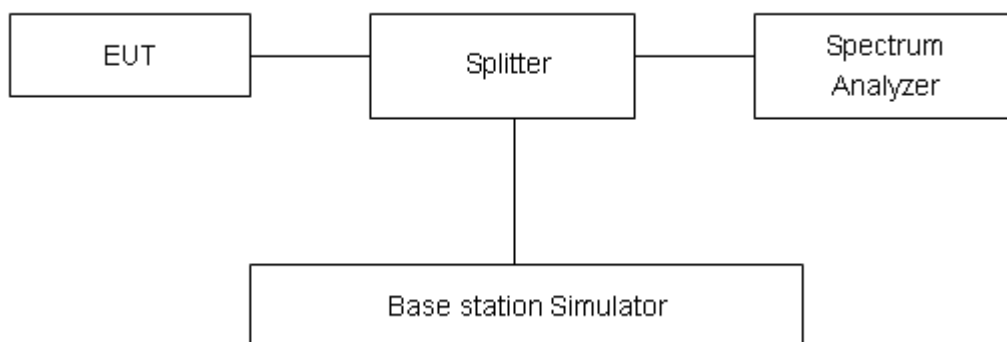

### Limits

According to the Sec. 22.913(d), The peak-to-average ratio (PAR) of the transmission must not exceed 13 dB.

### Measurement Uncertainty

The assessed measurement uncertainty to ensure 95% confidence level for the normal distribution is with the coverage factor  $k = 2$ ,  $U = 0.4$  dB.

**Test Results**

Mode	Bandwidth	Modulation	Channel/ Frequency (MHz)	Peak-to-Average Power Ratio (PAPR)			Limit (dB)	Conclusion
				Peak (dBm)	Avg (dBm)	PAPR (dB)		
LTE Band 5	1.4MHz	QPSK	20525/836.5	22.74	11.15	11.59	≤13	PASS
		16QAM	20525/836.5	24.07	11.85	12.22	≤13	PASS
	3MHz	QPSK	20525/836.5	22.87	12.81	10.06	≤13	PASS
		16QAM	20525/836.5	23.73	12.65	11.08	≤13	PASS
	5MHz	QPSK	20525/836.5	23.93	14.06	9.87	≤13	PASS
		16QAM	20525/836.5	24.67	14.35	10.32	≤13	PASS
	10MHz	QPSK	20525/836.5	23.83	13.93	9.90	≤13	PASS
		16QAM	20525/836.5	25.13	14.87	10.26	≤13	PASS

## 5.5. Frequency Stability

### Ambient condition

Temperature	Relative humidity	Pressure
23°C ~25°C	45%~50%	101.5kPa

### Method of Measurement

#### Frequency Stability (Temperature Variation)

The temperature inside the climate chamber is varied from -40°C to +85°C in 10°C step size,

(1) With all power removed, the temperature was decreased to 0°C and permitted to stabilize for three hours.

(2) Measure the carrier frequency with the test equipment in a “call mode”. These measurements should be made within 1 minute of powering up the mobile station, to prevent significant self warming.

(3) Repeat the above measurements at 10°C increments from -40°C to +85°C. Allow at least 1.5 hours at each temperature, un-powered, before making measurements.

#### Frequency Stability (Voltage Variation)

The frequency stability shall be measured with variation of primary supply voltage as follows:

(1) Vary primary supply voltage from 85 to 115 percent of the nominal value for other than hand carried battery equipment.

(2) For hand carried, battery powered equipment, reduce primary supply voltage to the battery-operating end point which shall be specified by the manufacturer.

This transceiver is specified to operate with an input voltage of between 3.3 V and 4.3 V, with a nominal voltage of 3.8V.

### Test setup

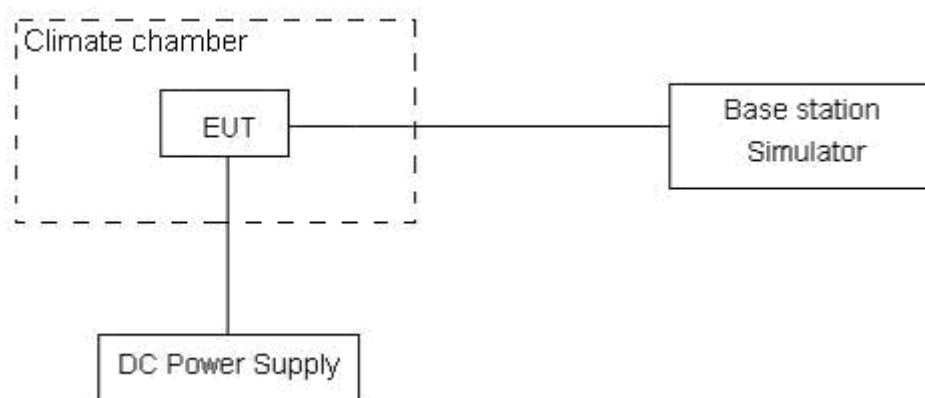

**Limits**

According to the Sec. 22.355, the frequency stability of the carrier shall be accurate to within 2.5 ppm of the received frequency for mobile stations.

Limits	$\leq 2.5$ ppm
--------	----------------

**Measurement Uncertainty**

The assessed measurement uncertainty to ensure 99.75% confidence level for the normal distribution is with the coverage factor  $k = 3$ ,  $U = 0.01$  ppm.





## Test Result

LTE Band 5						
Condition		Freq.Error (Hz)	Freq.Error (Hz)	Frequency Stability (ppm)	Frequency Stability (ppm)	Verdict
BANDWIDTH	1.4MHz					
Temperature	Voltage	16QAM	QPSK	16QAM	QPSK	
Normal (25°C)	Normal	17.81	7.95	0.00947	0.00423	PASS
Extreme (85°C)		9.96	5.85	0.00530	0.00311	PASS
Extreme (80°C)		11.42	12.74	0.00607	0.00678	PASS
Extreme (70°C)		10.28	1.82	0.00547	0.00097	PASS
Extreme (60°C)		12.68	16.35	0.00674	0.00870	PASS
Extreme (50°C)		14.86	7.75	0.00791	0.00412	PASS
Extreme (40°C)		12.18	15.46	0.00648	0.00822	PASS
Extreme (30°C)		14.82	4.16	0.00788	0.00221	PASS
Extreme (20°C)		5.55	9.36	0.00295	0.00498	PASS
Extreme (10°C)		17.09	6.62	0.00909	0.00352	PASS
Extreme (0°C)		13.81	13.08	0.00735	0.00696	PASS
Extreme (-10°C)		7.92	2.12	0.00421	0.00113	PASS
Extreme (-20°C)		7.32	5.05	0.00390	0.00269	PASS
Extreme (-30°C)		2.35	10.51	0.00125	0.00559	PASS
Extreme (-40°C)		11.12	14.30	0.00592	0.00761	PASS
25°C	LV	13.90	17.98	0.00739	0.00957	PASS
	HV	9.49	4.80	0.00505	0.00255	PASS
Condition		Freq.Error (Hz)	Freq.Error (Hz)	Frequency Stability (ppm)	Frequency Stability (ppm)	Verdict
BANDWIDTH	3MHz					
Temperature	Voltage	16QAM	QPSK	16QAM	QPSK	
Normal (25°C)	Normal	13.34	5.19	0.00710	0.00276	PASS
Extreme (85°C)		13.48	13.90	0.00717	0.00740	PASS
Extreme (80°C)		16.64	1.92	0.00885	0.00102	PASS
Extreme (70°C)		15.79	13.95	0.00840	0.00742	PASS
Extreme (60°C)		1.18	6.32	0.00063	0.00336	PASS
Extreme (50°C)		3.86	11.43	0.00206	0.00608	PASS
Extreme (40°C)		6.21	13.70	0.00330	0.00729	PASS
Extreme (30°C)		6.56	13.68	0.00349	0.00728	PASS
Extreme (20°C)		4.91	9.51	0.00261	0.00506	PASS
Extreme (10°C)		5.84	16.99	0.00310	0.00904	PASS
Extreme (0°C)		13.83	6.82	0.00736	0.00363	PASS
Extreme (-10°C)		10.69	12.54	0.00569	0.00667	PASS
Extreme (-20°C)		6.79	1.06	0.00361	0.00056	PASS
Extreme (-30°C)		13.13	15.84	0.00698	0.00842	PASS



Extreme (-40°C)		11.63	7.92	0.00618	0.00421	PASS
25°C	LV	8.16	2.85	0.00434	0.00152	PASS
	HV	6.52	14.92	0.00347	0.00793	PASS
Condition		Freq.Error (Hz)	Freq.Error (Hz)	Frequency Stability (ppm)	Frequency Stability (ppm)	Verdict
BANDWIDTH	5MHz					
Temperature	Voltage	16QAM	QPSK	16QAM	QPSK	
Normal (25°C)	Normal	2.04	1.77	0.00109	0.00094	PASS
Extreme (85°C)		16.12	7.21	0.00858	0.00384	PASS
Extreme (80°C)		10.42	3.28	0.00554	0.00175	PASS
Extreme (70°C)		9.29	11.46	0.00494	0.00610	PASS
Extreme (60°C)		16.43	6.84	0.00874	0.00364	PASS
Extreme (50°C)		11.70	10.67	0.00622	0.00567	PASS
Extreme (40°C)		8.48	15.16	0.00451	0.00806	PASS
Extreme (30°C)		8.61	11.59	0.00458	0.00616	PASS
Extreme (20°C)		7.39	4.63	0.00393	0.00246	PASS
Extreme (10°C)		14.91	15.03	0.00793	0.00800	PASS
Extreme (0°C)		6.61	2.49	0.00351	0.00133	PASS
Extreme (-10°C)		16.34	1.23	0.00869	0.00066	PASS
Extreme (-20°C)		15.58	4.95	0.00829	0.00264	PASS
Extreme (-30°C)		2.64	10.97	0.00141	0.00583	PASS
Extreme (-40°C)		9.92	16.06	0.00528	0.00854	PASS
25°C	LV	6.54	15.85	0.00348	0.00843	PASS
	HV	16.47	16.82	0.00876	0.00895	PASS
Condition		Freq.Error (Hz)	Freq.Error (Hz)	Frequency Stability (ppm)	Frequency Stability (ppm)	Verdict
BANDWIDTH	10MHz					
Temperature	Voltage	16QAM	QPSK	16QAM	QPSK	
Normal (25°C)	Normal	8.97	10.12	0.00477	0.00538	PASS
Extreme (85°C)		13.68	5.00	0.00728	0.00266	PASS
Extreme (80°C)		16.19	17.43	0.00861	0.00927	PASS
Extreme (70°C)		8.93	11.47	0.00475	0.00610	PASS
Extreme (60°C)		12.87	3.86	0.00685	0.00205	PASS
Extreme (50°C)		6.05	13.01	0.00322	0.00692	PASS
Extreme (40°C)		12.64	7.53	0.00672	0.00400	PASS
Extreme (30°C)		16.94	6.72	0.00901	0.00357	PASS
Extreme (20°C)		8.01	14.36	0.00426	0.00764	PASS
Extreme (10°C)		17.41	7.45	0.00926	0.00396	PASS
Extreme (0°C)		5.65	9.69	0.00301	0.00515	PASS
Extreme (-10°C)		7.60	4.16	0.00404	0.00221	PASS
Extreme (-20°C)		2.04	11.94	0.00108	0.00635	PASS
Extreme (-30°C)	16.89	7.73	0.00898	0.00411	PASS	



Extreme (-40°C)		11.44	2.36	0.00608	0.00126	PASS
25°C	LV	4.55	12.27	0.00242	0.00653	PASS
	HV	4.92	16.35	0.00262	0.00870	PASS

## 5.6. Spurious Emissions at Antenna Terminals

### Ambient condition

Temperature	Relative humidity	Pressure
23°C ~25°C	45%~50%	101.5kPa

### Method of Measurement

The EUT was connected to Spectrum Analyzer and Base Station Simulator via power Splitter. The measurement is carried out using a spectrum analyzer. The spectrum analyzer scans from 9kHz to the 10th harmonic of the carrier.

The peak detector is used. RBW are set to 100 kHz and VBW are set to 300 kHz for below 1G, RBW are set to 1MHz and VBW are set to 3MHz for above 1G, Sweep is set to ATUO.

The modulation mode and RB allocation refer to section 5.1, using the maximum output power configuration.

### Test setup

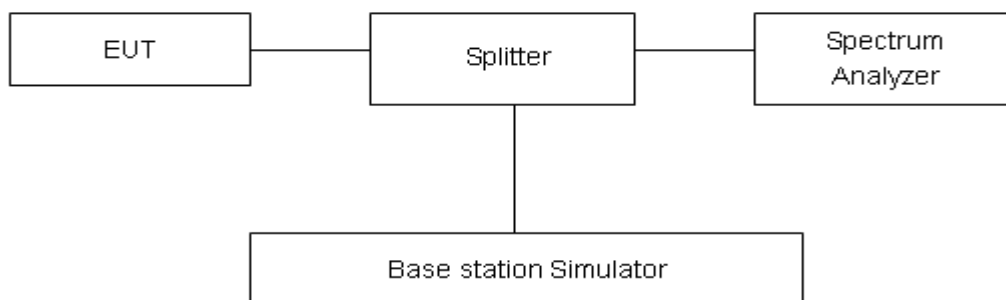

### Limits

Rule Part 22.917(a) specifies that “The power of any emission outside of the authorized operating frequency ranges must be attenuated below the transmitting power (P) by a factor of at least 43 + 10 log (P) dB.”

Limit	-13 dBm
-------	---------

### Measurement Uncertainty

The assessed measurement uncertainty to ensure 99.75% confidence level for the normal distribution is with the coverage factor  $k = 1.96$ .

Frequency	Uncertainty
30MHz-1GHz	0.684 dB
1GHz-9GHz	1.407 dB



### Test Result

Sweep the whole frequency band through the range from 9kHz to the 10th harmonic of the carrier, the emissions more than 20 dB below the limit are not reported.

The signal beyond the limit is carrier.

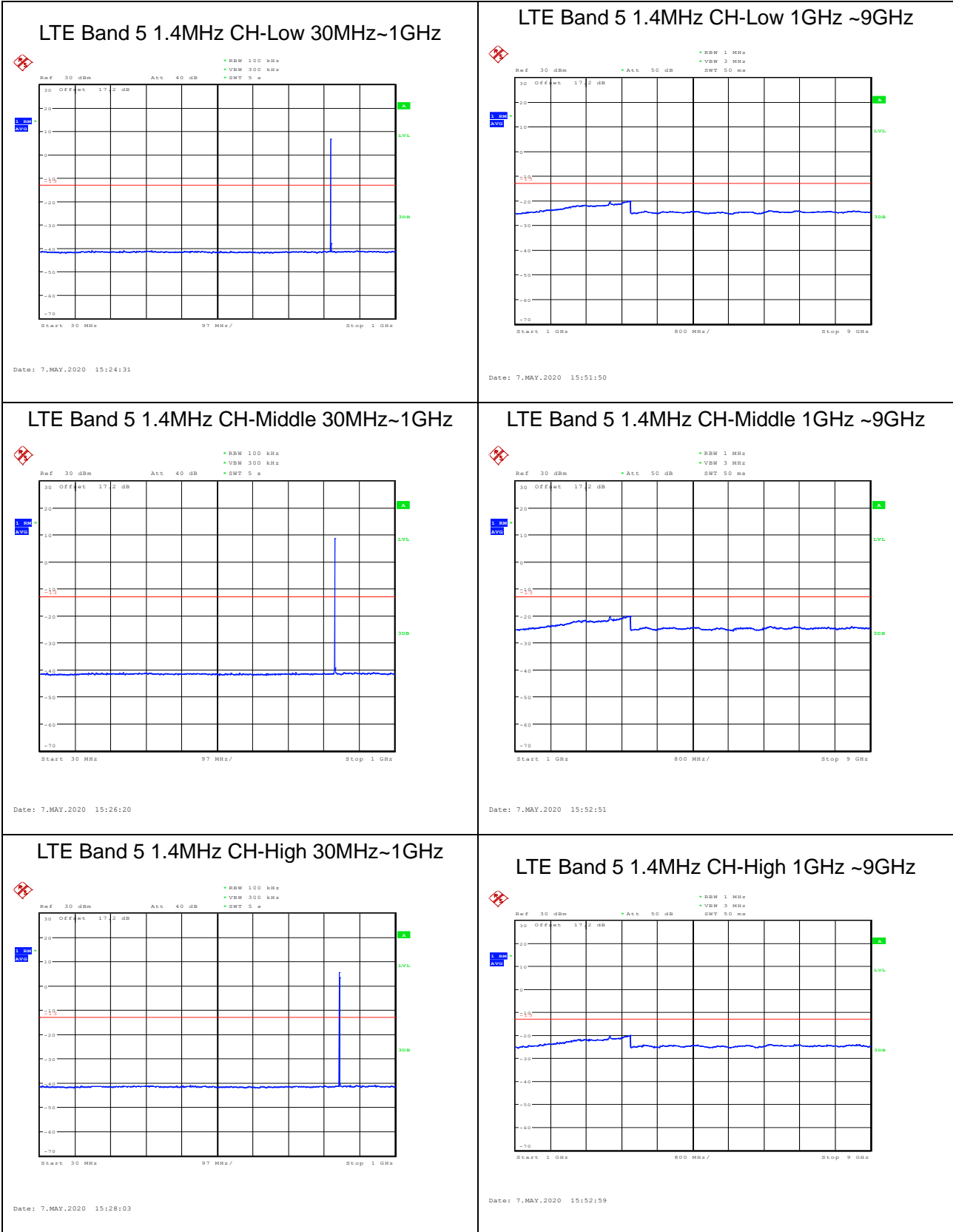



### LTE Band 5 3MHz CH-Low 30MHz~1GHz

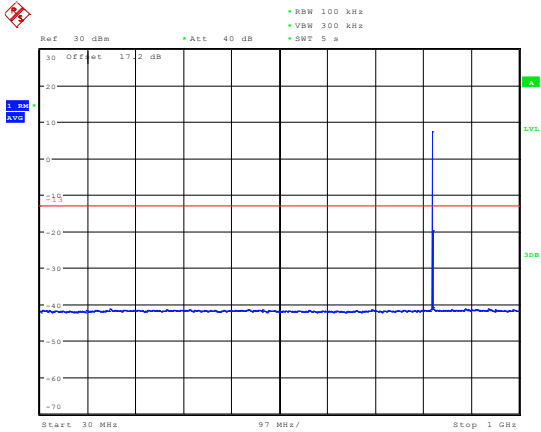

Date: 18.MAY.2020 10:46:04

### LTE Band 5 3MHz CH-Low 1GHz ~9GHz

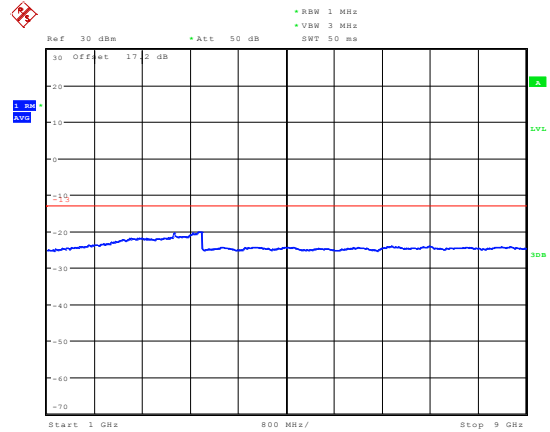

Date: 7.MAY.2020 15:53:24

### LTE Band 5 3MHz CH-Middle 30MHz~1GHz

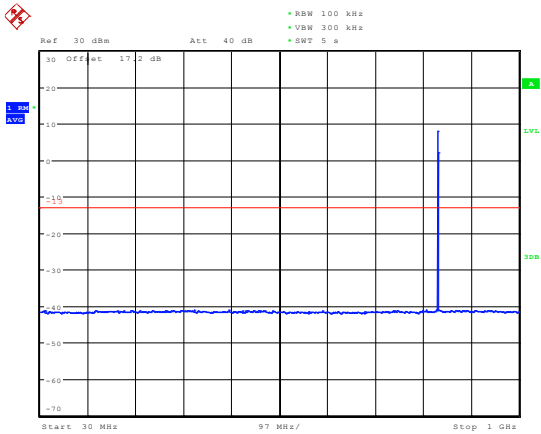

Date: 7.MAY.2020 15:31:20

### LTE Band 5 3MHz CH-Middle 1GHz ~9GHz

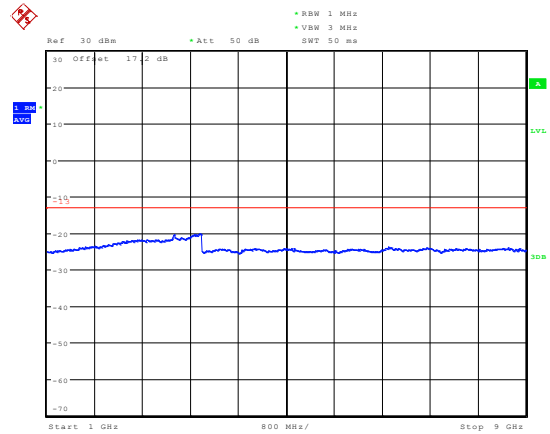

Date: 7.MAY.2020 15:53:32

### LTE Band 5 3MHz CH-High 30MHz~1GHz

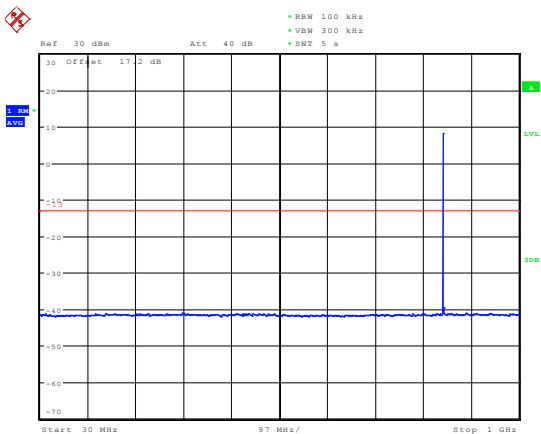

Date: 7.MAY.2020 15:32:34

### LTE Band 5 3MHz CH-High 1GHz ~9GHz

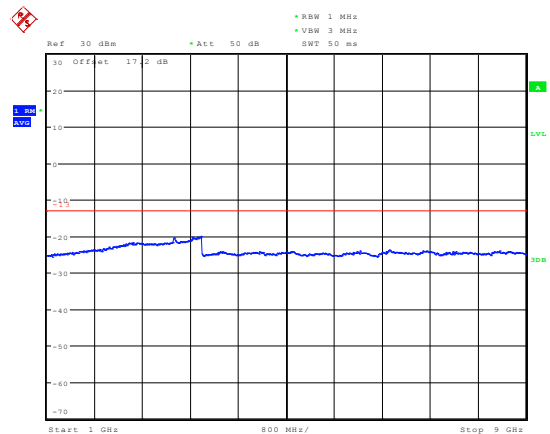

Date: 7.MAY.2020 15:53:41



### LTE Band 5 5MHz CH-Low 30MHz~1GHz

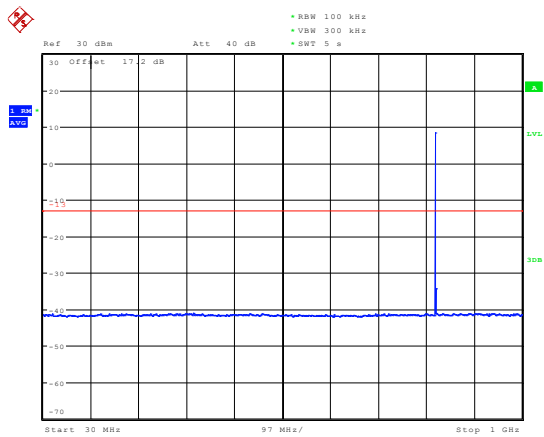

Date: 7.MAY.2020 15:44:27

### LTE Band 5 5MHz CH-Low 1GHz ~9GHz

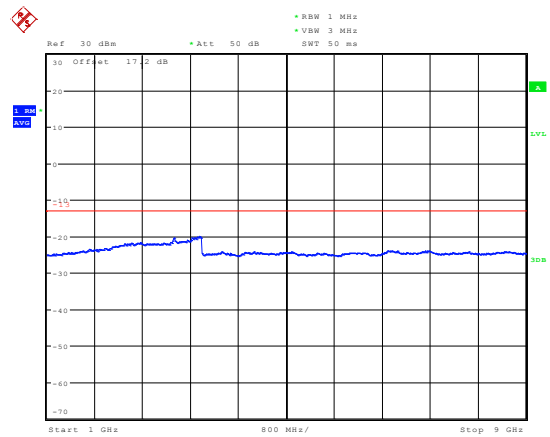

Date: 7.MAY.2020 15:54:15

### LTE Band 5 5MHz CH-Middle 30MHz~1GHz

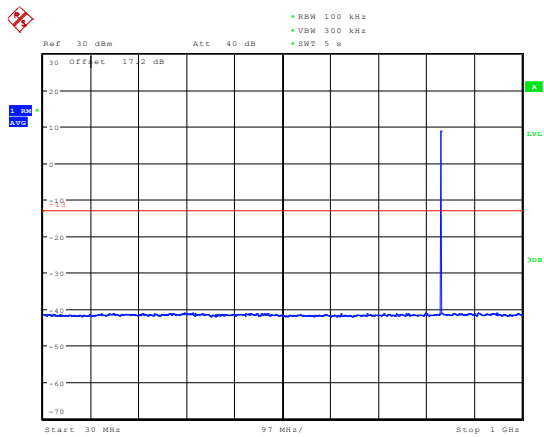

Date: 7.MAY.2020 15:45:55

### LTE Band 5 5MHz CH-Middle 1GHz ~9GHz

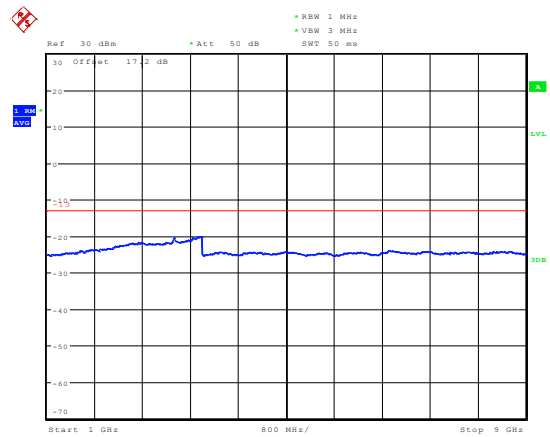

Date: 7.MAY.2020 15:54:24

### LTE Band 5 5MHz CH-High 30MHz~1GHz

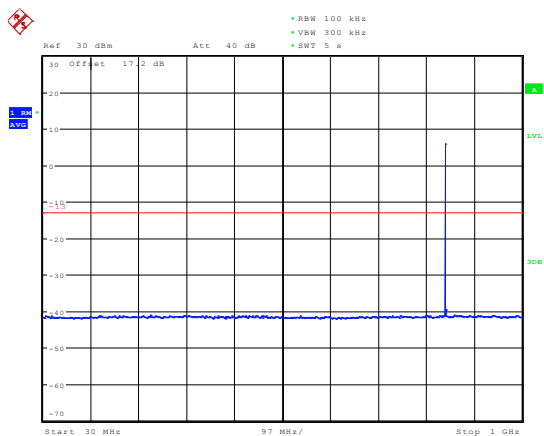

Date: 7.MAY.2020 15:46:38

### LTE Band 5 5MHz CH-High 1GHz ~9GHz

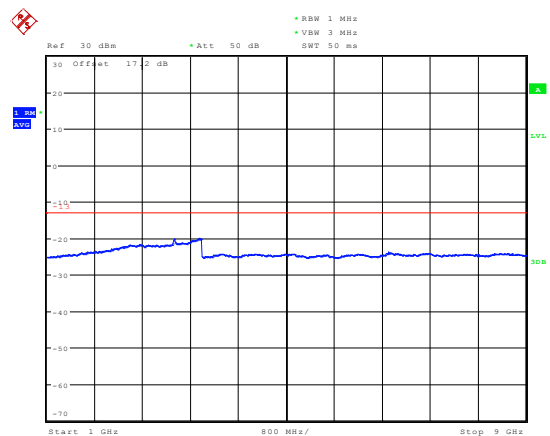

Date: 7.MAY.2020 15:54:33



### LTE Band 5 10MHz CH-Low 30MHz~1GHz

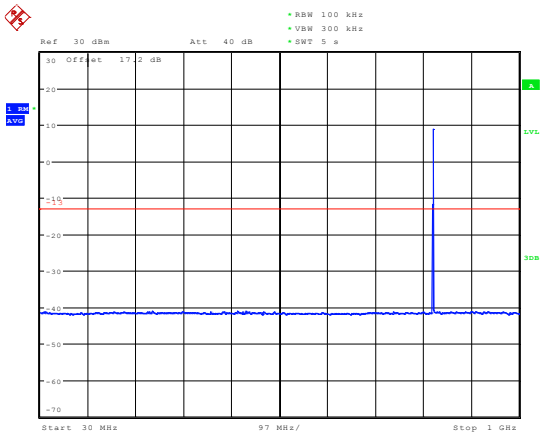

Date: 7.MAY.2020 15:47:08

### LTE Band 5 10MHz CH-Low 1GHz ~9GHz

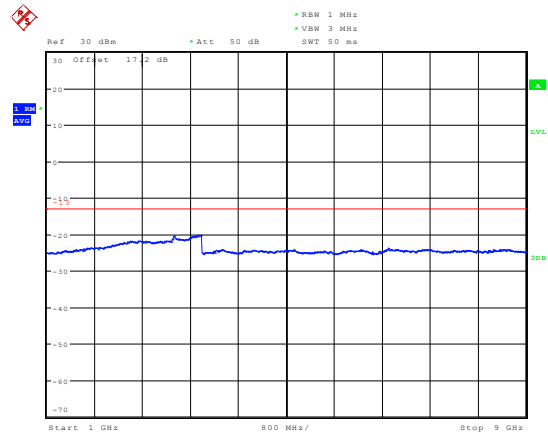

Date: 7.MAY.2020 15:54:55

### LTE Band 5 10MHz CH-Middle 30MHz~1GHz

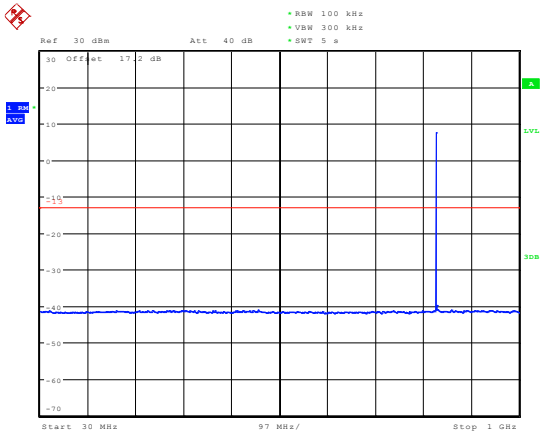

Date: 7.MAY.2020 15:48:03

### LTE Band 5 10MHz CH-Middle 1GHz ~9GHz

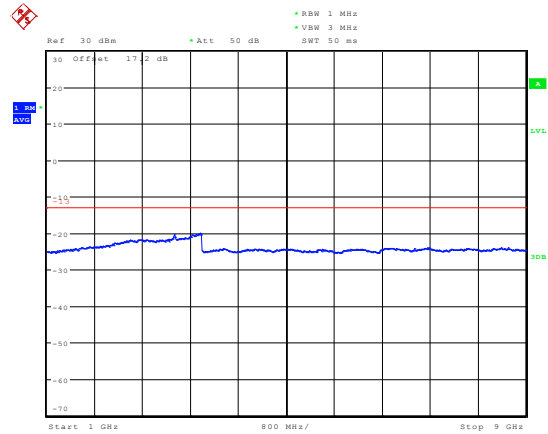

Date: 7.MAY.2020 15:55:05

### LTE Band 5 10MHz CH-High 30MHz~1GHz

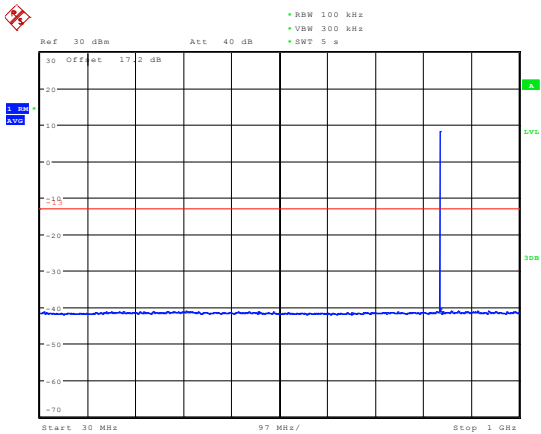

Date: 7.MAY.2020 15:48:52

### LTE Band 5 10MHz CH-High 1GHz ~9GHz

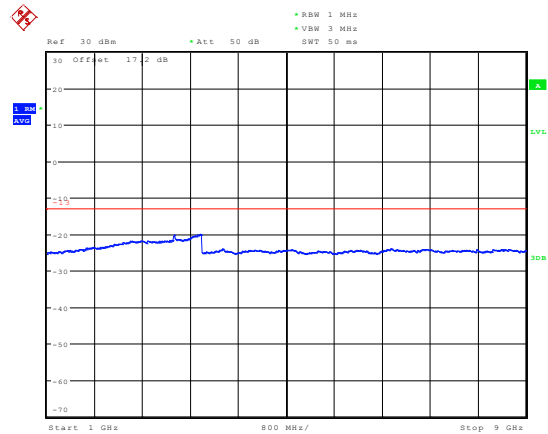

Date: 7.MAY.2020 15:55:12



## 5.7. Radiates Spurious Emission

### Ambient condition

Temperature	Relative humidity	Pressure
23°C ~25°C	45%~50%	101.5kPa

### Method of Measurement

1. The testing follows FCC KDB 971168 v03r01 Section 5.8 and ANSI C63.26 (2015).
2. Below 1GHz: The EUT is placed on a turntable 0.8 meters above the ground in the chamber, 3 meter away from the antenna. The maximal emission value is acquired by adjusting the antenna height, polarisation and turntable azimuth. Normally, the height range of antenna is 1 m to 4 m, the azimuth range of turntable is 0° to 360°, and the receive antenna has two polarizations Vertical (V) and Horizontal (H). Above 1GHz: (Note: the FCC's permission to use 1.5m as an alternative per TCBC Conf call of Dec. 2, 2014.) The EUT is placed on a turntable 1.5 meters above the ground in the chamber, 3 meter away from the antenna. The maximal emission value is acquired by adjusting the antenna height, polarisation and turntable azimuth. Normally, the height range of antenna is 1 m to 4 m, the azimuth range of turntable is 0° to 360°, and the receive antenna has two polarizations Vertical (V) and Horizontal (H).
3. A loop antenna, A log-periodic antenna or horn antenna shall be substituted in place of the EUT. The log-periodic antenna will be driven by a signal generator and the level will be adjusted till the same power value on the spectrum analyzer or receiver. The level of the spurious emissions can be calculated through the level of the signal generator, cable loss, the gain of the substitution antenna and the reading of the spectrum analyzer or receiver.
4. The EUT is then put into continuously transmitting mode at its maximum power level during the test. Set Test Receiver or Spectrum RBW=200Hz,VBW=600Hz for 9kHz150kHz , RBW=10kHz, VBW=30kHz 150kHz-30MHz , RBW=100kHz,VBW=300kHz for 30MHz to 1GHz and RBW=1MHz, VBW=3MHz for above 1GHz, And the maximum value of the receiver should be recorded as (Pr).
5. The EUT shall be replaced by a substitution antenna. In the chamber, an substitution antenna for the frequency band of interest is placed at the reference point of the chamber. An RF Signal source for the frequency band of interest is connected to the substitution antenna with a cable that has been constructed to not interfere with the radiation pattern of the antenna. A power (PMea) is applied to the input of the substitution antenna, and adjust the level of the signal generator output until the value of the receiver reach the previously recorded (Pr). The power of signal source (PMea) is recorded. The test should be performed by rotating the test item and adjusting the receiving antenna polarization.
6. A amplifier should be connected to the Signal Source output port. And the cable should be connect between the Amplifier and the Substitution Antenna. The cable loss (Pcl) ,the Substitution Antenna Gain (Ga) and the Amplifier Gain (PAg) should be recorded after test.
7. The measurement results are obtained as described below:  
Power(EIRP)=PMea- PAg - Pcl + Ga  
The measurement results are amend as described below:  
Power(EIRP)=PMea- Pcl + Ga
8. This value is EIRP since the measurement is calibrated using an antenna of known gain (2.15 dBi)

and known input power. ERP can be calculated from EIRP by subtracting the gain of the dipole,  $ERP = EIRP - 2.15\text{dBi}$ .

The modulation mode and RB allocation refer to section 5.1, using the maximum output power configuration.

**Test setup**

**9KHz ~ 30MHz**

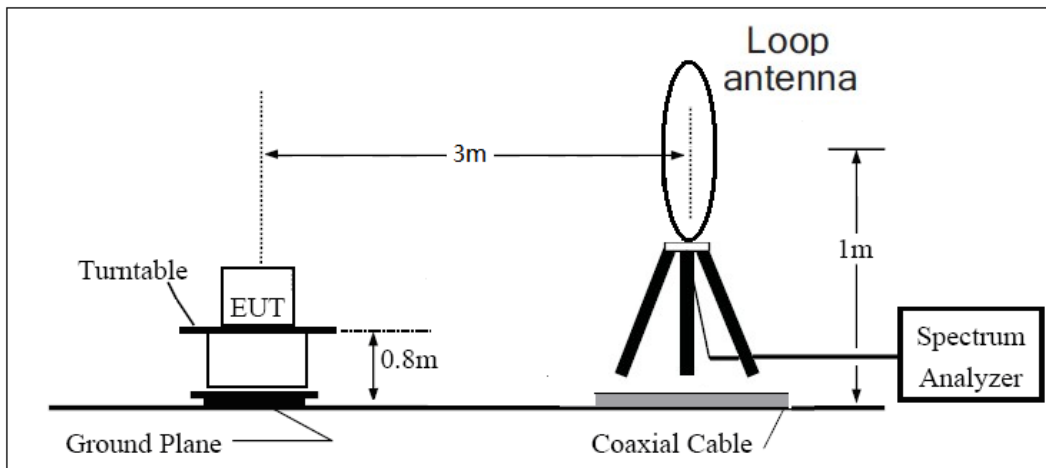

**30MHz ~ 1GHz**

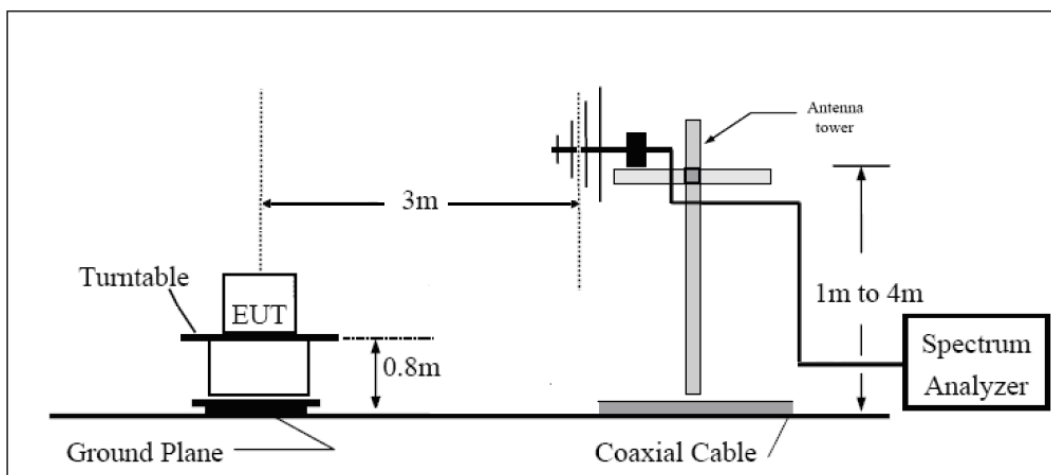

**Above 1GHz**

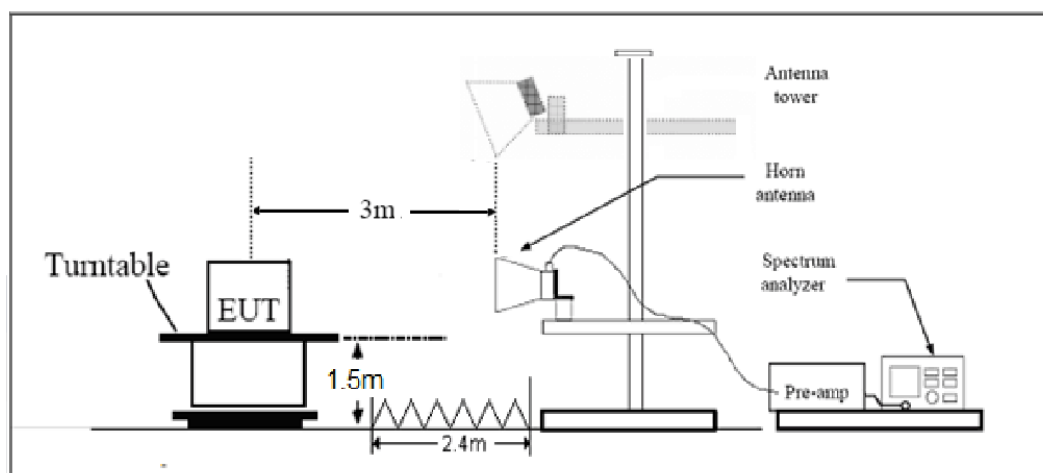



Note: Area side:2.4mX3.6m

### Limits

Rule Part 22.917(a) specifies that “The power of any emission outside of the authorized operating frequency ranges must be attenuated below the transmitting power (P) by a factor of at least  $43 + 10 \log (P)$  dB.”

Limit	-13 dBm
-------	---------

### Measurement Uncertainty

The assessed measurement uncertainty to ensure 95% confidence level for the normal distribution is with the coverage factor  $k = 1.96$ ,  $U = 3.55$  dB.

**Test Result**

Sweep the whole frequency band through the range from 9kHz to the 10th harmonic of the carrier, the emissions below the noise floor will not be recorded in the report.

## LTE Band 5 1.4MHz CH-Middle

Harmonic	Frequency (MHz)	SG (dBm)	Cable Loss (dB)	Gain (dBi)	Antenna Polarization	ERP Level (dBm)	Limit (dBm)	Margin (dB)	Azimuth (deg)
2	1673.0	-52.70	2.00	10.75	Horizontal	-46.10	-13.00	33.10	315
3	2509.5	-43.09	2.51	11.05	Horizontal	-36.70	-13.00	23.70	225
4	3346.0	-61.65	4.20	11.15	Horizontal	-56.85	-13.00	43.85	270
5	4182.5	-59.75	5.20	11.15	Horizontal	-55.95	-13.00	42.95	135
6	5019.0	-59.79	5.50	11.95	Horizontal	-55.49	-13.00	42.49	90
7	5855.5	-61.35	5.70	13.55	Horizontal	-55.65	-13.00	42.65	225
8	6692.0	-57.86	6.30	13.75	Horizontal	-52.56	-13.00	39.56	315
9	7528.5	-55.67	6.80	13.85	Horizontal	-50.77	-13.00	37.77	45
10	8365.0	-55.76	6.90	14.25	Horizontal	-50.56	-13.00	37.56	180

Note: 1.The other Spurious RF Radiated emissions level is no more than noise floor.

2.The worst emission was found in the antenna is Horizontal position.

## LTE Band 5 5MHz CH-Middle

Harmonic	Frequency (MHz)	SG (dBm)	Cable Loss (dB)	Gain (dBi)	Antenna Polarization	ERP Level (dBm)	Limit (dBm)	Margin (dB)	Azimuth (deg)
2	1673.0	-53.50	2.00	10.75	Horizontal	-46.90	-13.00	33.90	315
3	2509.5	-41.79	2.51	11.05	Horizontal	-35.40	-13.00	22.40	45
4	3337.5	-60.95	4.20	11.15	Horizontal	-56.15	-13.00	43.15	315
5	4171.9	-60.32	5.20	11.15	Horizontal	-56.52	-13.00	43.52	45
6	5006.3	-59.97	5.50	11.95	Horizontal	-55.67	-13.00	42.67	225
7	5840.6	-60.17	5.70	13.55	Horizontal	-54.47	-13.00	41.47	90
8	6675.0	-57.64	6.30	13.75	Horizontal	-52.34	-13.00	39.34	225
9	7509.4	-57.13	6.80	13.85	Horizontal	-52.23	-13.00	39.23	180
10	8343.8	-55.48	6.90	14.25	Horizontal	-50.28	-13.00	37.28	270

Note: 1.The other Spurious RF Radiated emissions level is no more than noise floor.

2.The worst emission was found in the antenna is Horizontal position.



## LTE Band 5 10MHz CH-Middle

Harmonic	Frequency (MHz)	SG (dBm)	Cable Loss (dB)	Gain (dBi)	Antenna Polarization	ERP Level (dBm)	Limit (dBm)	Margin (dB)	Azimuth (deg)
2	1673.0	-53.34	2.00	10.75	Horizontal	-46.74	-13.00	33.74	90
3	2509.5	-39.84	2.51	11.05	Horizontal	-33.45	-13.00	20.45	225
4	3346.0	-59.19	4.20	11.15	Horizontal	-54.39	-13.00	41.39	270
5	4182.5	-57.56	5.20	11.15	Horizontal	-53.76	-13.00	40.76	90
6	5019.0	-58.70	5.50	11.95	Horizontal	-54.40	-13.00	41.40	0
7	5855.5	-59.30	5.70	13.55	Horizontal	-53.60	-13.00	40.60	0
8	6692.0	-57.20	6.30	13.75	Horizontal	-51.90	-13.00	38.90	45
9	7528.5	-54.40	6.80	13.85	Horizontal	-49.50	-13.00	36.50	225
10	8365.0	-55.50	6.90	14.25	Horizontal	-50.30	-13.00	37.30	315

Note: 1.The other Spurious RF Radiated emissions level is no more than noise floor.

2.The worst emission was found in the antenna is Horizontal position.



## 6. Main Test Instruments

Name	Manufacturer	Type	Serial Number	Calibration Date	Expiration Date
Base Station Simulator	R&S	CMW500	113824	2019-05-19	2020-05-18
Base Station Simulator	R&S	CMW500	113824	2020-05-18	2021-05-17
Power Splitter	Hua Xiang	SHX-GF2-2-13	10120101	/	/
Spectrum Analyzer	Key sight	N9010A	MY50210259	2019-05-19	2020-05-18
Spectrum Analyzer	Key sight	N9010A	MY50210259	2020-05-18	2021-05-17
Universal Radio Communication Tester	Key sight	E5515C	MY48367192	2019-05-19	2020-05-18
Universal Radio Communication Tester	Key sight	E5515C	MY48367192	2020-05-18	2021-05-17
Signal Analyzer	R&S	FSV30	100815	2019-12-15	2020-12-14
Loop Antenna	SCHWARZBECK	FMZB1519	1519-047	2017-09-26	2020-09-25
Trilog Antenna	SCHWARZBECK	VUBL 9163	9163-201	2017-11-18	2020-11-17
Horn Antenna	R&S	HF907	100126	2018-07-07	2020-07-06
Horn Antenna	ETS-Lindgren	3160-09	00102643	2018-06-20	2020-06-19
Signal generator	R&S	SMB 100A	102594	2019-05-19	2020-05-18
Signal generator	R&S	SMB 100A	102594	2020-05-18	2021-05-17
Climatic Chamber	ESPEC	SU-242	93000506	2017-12-17	2020-12-16
Preamplifier	R&S	SCU18	102327	2019-05-19	2020-05-18
Preamplifier	R&S	SCU18	102327	2020-05-18	2021-05-17
MOB COMMS DC SUPPLY	Keysight	66319D	MY43004105	2019-05-20	2020-05-19
MOB COMMS DC SUPPLY	Keysight	66319D	MY43004105	2020-05-18	2021-05-17
RF Cable	Agilent	SMA 15cm	0001	2019-12-13	2020-06-12
Software	R&S	EMC32	9.26.0	/	/

\*\*\*\*\*END OF REPORT \*\*\*\*\*