



# RF TEST REPORT

**Applicant**      Quectel Wireless Solutions Co., Ltd  
**FCC ID**          XMR2019SC650TNA  
**Product**        Smart Module  
**Brand**            Quectel  
**Model**            SC650T-NA  
**Report No.**      R2210A0926-R8V2  
**Issue Date**      November 8, 2022

TA Technology (Shanghai) Co., Ltd. tested the above equipment in accordance with the requirements in **FCC CFR47 Part 2 (2021)/FCC CFR 47 Part 90R (2021)**. The test results show that the equipment tested is capable of demonstrating compliance with the requirements as documented in this report.

*Prepared by: Xu Ying*

*Approved by: Xu Kai*

---

**TA Technology (Shanghai) Co., Ltd.**

*Building 3, No.145, Jintang Rd, Pudong Shanghai, P.R.China*

*TEL: +86-021-50791141/2/3*

*FAX: +86-021-50791141/2/3-8000*



## TABLE OF CONTENT

1. Test Laboratory .....	5
1.1. Notes of the Test Report .....	5
1.2. Test facility .....	5
1.3. Testing Location .....	5
2. General Description of Equipment under Test.....	6
2.1. Applicant and Manufacturer Information .....	6
2.2. General Information.....	6
3. Applied Standards.....	7
4. Test Configuration.....	8
5. Test Case.....	9
5.1. RF Power Output and Effective Radiated Power .....	9
5.2. Band Edge Compliance.....	10
5.3. Spurious Emissions at Antenna Terminals .....	12
5.4. Radiated Spurious Emission .....	14
6. Test Result .....	17
6.1. RF Power Output and Effective Radiated Power .....	17
6.2. Band Edge Compliance.....	19
6.3. Spurious Emissions at Antenna Terminals .....	21
6.4. Radiated Spurious Emission .....	22
7. Main Test Instruments .....	23
ANNEX A: The EUT Appearance .....	24
ANNEX B: Test Setup Photos .....	25



Version	Revision description	Issue Date
Rev.0	Initial issue of report.	October 26, 2022
Rev.1	Update FCC ID.	November 7, 2022
Rev.2	Update Model.	November 8, 2022

Note: This revised report (Report No. R2210A0926-R8V2) supersedes and replaces the previously issued report (Report No. R2210A0926-R8V1). Please discard or destroy the previously issued report and dispose of it accordingly.



## Summary of measurement results

No.	Test Case	Clause in FCC rules	Verdict
1	RF power output and Effective Radiated Power	2.1046/90.635 (b)/ 90.542	PASS
2	Occupied Bandwidth	2.1049/ 90.209	NA
3	Emission Masks	2.1051 / 90.543	PASS
4	Peak-to-Average Power Ratio	KDB 971168 D01(5.7)	NA
5	Frequency Stability	90.539 (c)	NA
6	Spurious Emissions at Antenna Terminals	90.543 (e)	PASS
7	Radiated Spurious Emission	90.543 (e)	PASS

Date of Testing: October 12, 2022 ~ October 18, 2022  
Date of Sample Received: October 12, 2022

Note: PASS: The EUT complies with the essential requirements in the standard.  
FAIL: The EUT does not comply with the essential requirements in the standard.  
All indications of Pass/Fail in this report are opinions expressed by TA Technology (Shanghai) Co., Ltd. based on interpretations and/or observations of test results. Measurement Uncertainties were not taken into account and are published for informational purposes only.



## 1. Test Laboratory

### 1.1. Notes of the Test Report

This report shall not be reproduced in full or partial, without the written approval of **TA technology (shanghai) co., Ltd.** The results documented in this report apply only to the tested sample, under the conditions and modes of operation as described herein .Measurement Uncertainties were not taken into account and are published for informational purposes only. This report is written to support regulatory compliance of the applicable standards stated above.

### 1.2. Test facility

#### **FCC (Designation number: CN1179, Test Firm Registration Number: 446626)**

TA Technology (Shanghai) Co., Ltd. has been listed on the US Federal Communications Commission list of test facilities recognized to perform electromagnetic emissions measurements.

#### **A2LA (Certificate Number: 3857.01)**

TA Technology (Shanghai) Co., Ltd. has been listed by American Association for Laboratory Accreditation to perform electromagnetic emission measurement.

### 1.3. Testing Location

Company: TA Technology (Shanghai) Co., Ltd.  
Address: Building 3, No.145, Jintang Rd, Pudong Shanghai, P.R.China  
City: Shanghai  
Post code: 201201  
Country: P. R. China  
Contact: Xu Kai  
Telephone: +86-021-50791141/2/3  
Fax: +86-021-50791141/2/3-8000  
Website: <http://www.ta-shanghai.com>  
E-mail: [xukai@ta-shanghai.com](mailto:xukai@ta-shanghai.com)

## 2. General Description of Equipment under Test

### 2.1. Applicant and Manufacturer Information

Applicant	Quectel Wireless Solutions Co., Ltd
Applicant address	Building 5, Shanghai Business Park Phase III (Area B), No.1016 Tianlin Road, Minhang District, Shanghai, China 200233
Manufacturer	Quectel Wireless Solutions Co., Ltd
Manufacturer address	Building 5, Shanghai Business Park Phase III (Area B), No.1016 Tianlin Road, Minhang District, Shanghai, China 200233

### 2.2. General Information

EUT Description			
Model	SC650T-NA		
IMEI	IMEI1:865920060000042 IMEI2:865920060000059		
Hardware Version	R1.0		
Software Version	SC650TNALPAR05A01		
Power Supply	External power supply		
Antenna Type	The EUT don't have standard Antenna, The Antenna used for testing in this report is the after-market accessory (Dipole Antenna)		
Antenna Gain	4.45 dBi		
Test Mode(s)	LTE Band 14		
Test Modulation	QPSK, 16QAM;		
Maximum E.R.P.	26.44 dBm		
Rated Power Supply Voltage	DC 3.8V		
Operating Voltage	Minimum: 3.55V    Maximum: 4.40V		
Operating Temperature	Lowest: -35°C    Highest: +75°C		
Operating Frequency Range(s)	Band	Tx (MHz)	Rx (MHz)
	LTE Band 14	788 ~ 798	758 ~ 768
Note: 1. The EUT is sent from the applicant to TA and the information of the EUT is declared by the applicant.			



### 3. Applied Standards

According to the specifications of the manufacturer, it must comply with the requirements of the following standards:

**Test standards:**

**FCC CFR 47 Part 90R (2021)**

**ANSI C63.26-2015**

**Reference standard:**

**FCC 47 CFR Part 2 (2021)**

**KDB 971168 D01 Power Meas License Digital Systems v03r01**

## 4. Test Configuration

There is more than one SIM card slot, each one should be applied throughout the compliance test respectively, and however, only the worst case (SIM 1) will be recorded in this report.

Radiated measurements are performed by rotating the EUT in three different orthogonal test planes. EUT stand-up position (Z axis), lie-down position (X, Y axis). Receiver antenna polarization (horizontal and vertical), the worst emission was found in position (Z axis, vertical polarization for LTE Band) and the worst case was recorded.

All mode and data rates and positions were investigated.

The following testing in LTE is set based on the maximum RF Output Power.

Test modes are chosen as the worst case configuration below for LTE Band 14

Test items	Bandwidth (MHz)		Modulation		RB			Test Channel		
	5	10	QPSK	16QAM	1	50%	100%	L	M	H
RF Power Output and Effective Radiated Power	○	-	○	○	○	○	○	○	○	○
Band Edge Compliance	○	-	○	○	○	-	○	○	-	○
Spurious Emissions at Antenna Terminals	○	-	○	-	○	-	-	○	○	○
Radiated Spurious Emission	○	-	○	-	○	-	-	-	○	-
Note	1. The mark "○" means that this configuration is chosen for testing. 2. The mark "-" means that this configuration is not testing.									



## 5. Test Case

### 5.1. RF Power Output and Effective Radiated Power

#### Ambient condition

Temperature	Relative humidity	Pressure
23°C ~25°C	45%~50%	101.5kPa

#### Methods of Measurement

During the process of the testing, The EUT was connected to the Base Station Simulator with a known loss. The EUT is controlled by the Base Station Simulator test set to ensure max power transmission with proper modulation.

ERP can then be calculated as follows:

$$\text{EIRP (dBm)} = \text{Output Power (dBm)} + \text{Antenna Gain (dBi)}$$

where:dBd refers to gain relative to an ideal dipole.

$$\text{EIRP (dBm)} = \text{ERP (dBm)} + 2.15 \text{ (dB.)}$$

#### Test Setup

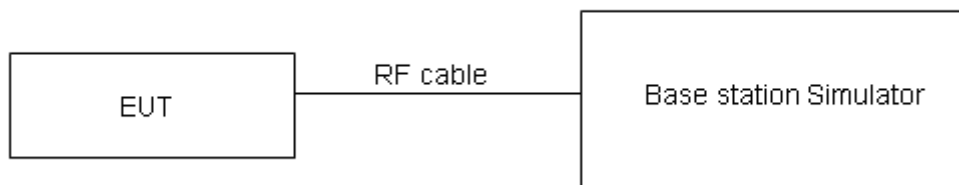

#### Limits

Part 90.635 (b) the maximum output power of the transmitter for mobile stations is 100 watts.

90.542(7) Portable stations (hand-held devices) transmitting in the 758-768 MHz band and the 788-798 MHz band are limited to 3 watts ERP.

#### Measurement Uncertainty

The assessed measurement uncertainty to ensure 95% confidence level for the normal distribution is with the coverage factor  $k = 2$ ,  $U = 0.4 \text{ dB}$  for RF power output,  $k = 2$ ,  $U = 1.19 \text{ dB}$  for ERP.

#### Test Results

Refer to the section 6.1 of this report for test data.

## 5.2. Band Edge Compliance

### Ambient condition

Temperature	Relative humidity	Pressure
23°C ~25°C	45%~50%	101.5kPa

### Method of Measurement

The EUT was connected to Spectrum Analyzer and Base Station Simulator via power Splitter. The band edge of the lowest and highest channels were measured.

The testing follows KDB 971168 v03r01 Section 6.0

1. The EUT was connected to spectrum analyzer and system simulator via a power divider.
2. The band edges of low and high channels for the highest RF powers were measured. RBW is set to  $\geq 1\%$ EBW, VBW is set to 3x RBW.
3. Set spectrum analyzer with RMS detector.
4. The RF fundamental frequency should be excluded against the limit line in the operating frequency band.
5. Checked that all the results comply with the emission limit line.

### Test Setup

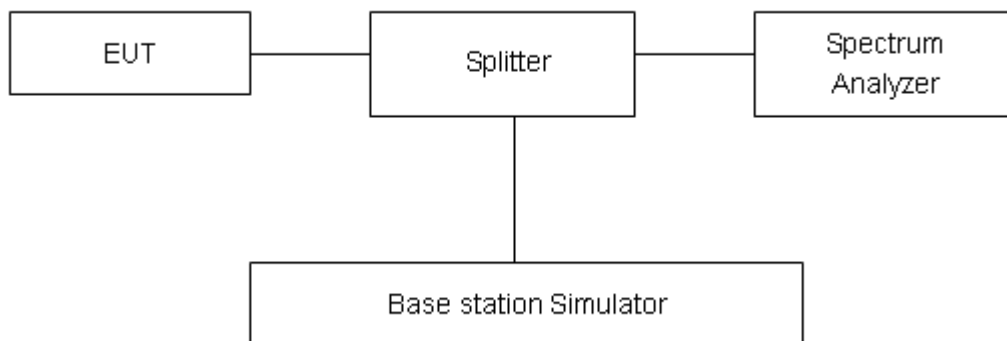

### Limits

90.543 Emission limitations (e) For operations in the 758-768 MHz and the 788-798 MHz bands, the power of any emission outside the licensee's frequency band(s) of operation shall be attenuated below the transmitter power (P) within the licensed band(s) of operation, measured in watts, in accordance with the following:

- (1) On all frequencies between 769-775 MHz and 799-805 MHz, by a factor not less than  $76 + 10 \log (P)$  dB in a 6.25 kHz band segment, for base and fixed stations.



(2) On all frequencies between 769-775 MHz and 799-805 MHz, by a factor not less than  $65 + 10 \log(P)$  dB in a 6.25 kHz band segment, for mobile and portable stations.

(3) On any frequency between 775-788 MHz, above 805 MHz, and below 758 MHz, by at least  $43 + 10 \log(P)$  dB.

(4) Compliance with the provisions of paragraphs (e)(1) and (2) of this section is based on the use of measurement instrumentation such that the reading taken with any resolution bandwidth setting should be adjusted to indicate spectral energy in a 6.25 kHz segment.

(5) Compliance with the provisions of paragraph (e)(3) of this section is based on the use of measurement instrumentation employing a resolution bandwidth of 100 kHz or greater. However, in the 100 kHz bands immediately outside and adjacent to the frequency block, a resolution bandwidth of 30 kHz may be employed.

(f) For operations in the 758-775 MHz and 788-805 MHz bands, all emissions including harmonics in the band 1559-1610 MHz shall be limited to  $-70$  dBW/MHz equivalent isotropically radiated power (EIRP) for wideband signals, and  $-80$  dBW EIRP for discrete emissions of less than 700 Hz bandwidth. For the purpose of equipment authorization, a transmitter shall be tested with an antenna that is representative of the type that will be used with the equipment in normal operation.

### Measurement Uncertainty

The assessed measurement uncertainty to ensure 95% confidence level for the normal distribution is with the coverage factor  $k = 1.96$ ,  $U=0.684$ dB.

### Test Results

Refer to the section 6.2 of this report for test data.

### 5.3. Spurious Emissions at Antenna Terminals

#### Ambient condition

Temperature	Relative humidity	Pressure
23°C ~25°C	45%~50%	101.5kPa

#### Method of Measurement

The EUT was connected to Spectrum Analyzer and Base Station Simulator via power Splitter. The measurement is carried out using a spectrum analyzer. The spectrum analyzer scans from 30MHz to the 10th harmonic of the carrier. The peak detector is used. Set RBW 1MHz and VBW 3MHz, Sweep is set to ATUO.

Of those disturbances below (limit – 20 dB), the mark is not required for the EUT.

#### Test setup

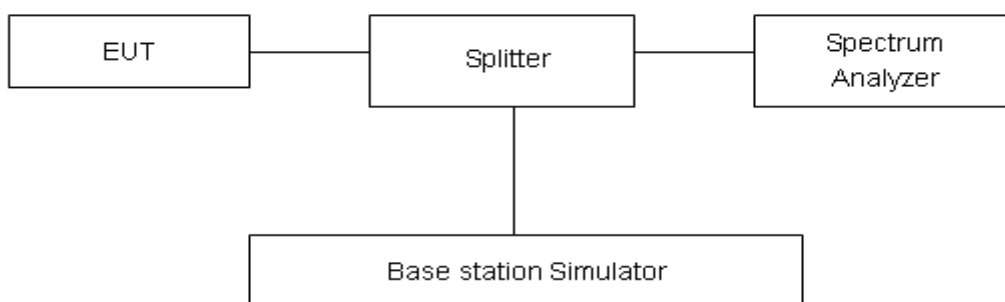

#### Limits

90.543 Emission limitations (e) For operations in the 758-768 MHz and the 788-798 MHz bands, the power of any emission outside the licensee's frequency band(s) of operation shall be attenuated below the transmitter power (P) within the licensed band(s) of operation, measured in watts, in accordance with the following:

- (1) On all frequencies between 769-775 MHz and 799-805 MHz, by a factor not less than  $76 + 10 \log (P)$  dB in a 6.25 kHz band segment, for base and fixed stations.
- (2) On all frequencies between 769-775 MHz and 799-805 MHz, by a factor not less than  $65 + 10 \log (P)$  dB in a 6.25 kHz band segment, for mobile and portable stations.
- (3) On any frequency between 775-788 MHz, above 805 MHz, and below 758 MHz, by at least  $43 + 10 \log (P)$  dB.



(4) Compliance with the provisions of paragraphs (e)(1) and (2) of this section is based on the use of measurement instrumentation such that the reading taken with any resolution bandwidth setting should be adjusted to indicate spectral energy in a 6.25 kHz segment.

(5) Compliance with the provisions of paragraph (e)(3) of this section is based on the use of measurement instrumentation employing a resolution bandwidth of 100 kHz or greater. However, in the 100 kHz bands immediately outside and adjacent to the frequency block, a resolution bandwidth of 30 kHz may be employed.

(f) For operations in the 758-775 MHz and 788-805 MHz bands, all emissions including harmonics in the band 1559-1610 MHz shall be limited to  $-70$  dBW/MHz equivalent isotropically radiated power (EIRP) for wideband signals, and  $-80$  dBW EIRP for discrete emissions of less than 700 Hz bandwidth. For the purpose of equipment authorization, a transmitter shall be tested with an antenna that is representative of the type that will be used with the equipment in normal operation.

### Measurement Uncertainty

The assessed measurement uncertainty to ensure 99.75% confidence level for the normal distribution is with the coverage factor  $k = 1.96$ .

Frequency	Uncertainty
100kHz-1GHz	0.684 dB
1GHz-12.75GHz	1.407 dB

### Test Results

Refer to the section 6.3 of this report for test data.

## 5.4. Radiated Spurious Emission

### Ambient condition

Temperature	Relative humidity	Pressure
23°C ~25°C	45%~50%	101.5kPa

### Method of Measurement

1. The testing follows FCC KDB 971168 D01 v03r01 Section 5.8 and ANSI C63.26.
2. Above 30MHz: The EUT is placed on a turntable 0.8 meters above the ground in the chamber, 3 meter away from the antenna. The maximal emission value is acquired by adjusting the antenna height, polarisation and turntable azimuth. Normally, the height range of antenna is 1 m to 4 m, the azimuth range of turntable is 0° to 360° , and the receive antenna has two polarizations Vertical (V) and Horizontal (H). Above 1GHz: (Note: the FCC' s permission to use 1.5m as an alternative per TCBC Conf call of Dec. 2, 2014.) The EUT is placed on a turntable 1.5 meters above the ground in the chamber, 3 meter away from the antenna. The maximal emission value is acquired by adjusting the antenna height, polarisation and turntable azimuth. Normally, the height range of antenna is 1 m to 4 m, the azimuth range of turntable is 0° to 360° , and the receive antenna has two polarizations Vertical (V) and Horizontal (H).
3. A loop antenna, A log-periodic antenna or horn antenna shall be substituted in place of the EUT. The log-periodic antenna will be driven by a signal generator and the level will be adjusted till the same power value on the spectrum analyzer or receiver. The level of the spurious emissions can be calculated through the level of the signal generator, cable loss, the gain of the substitution antenna and the reading of the spectrum analyzer or receiver.
4. The EUT is then put into continuously transmitting mode at its maximum power level during the test. Set Test Receiver or Spectrum RBW=100KHz, VBW=300KHz for all frequency, and the maximum value of the receiver should be recorded as (Pr).
5. The EUT shall be replaced by a substitution antenna. In the chamber, an substitution antenna for the frequency band of interest is placed at the reference point of the chamber. An RF Signal source for the frequency band of interest is connected to the substitution antenna with a cable that has been constructed to not interfere with the radiation pattern of the antenna. A power (PMea) is applied to the input of the substitution antenna, and adjust the level of the signal generator output until the value of the receiver reach the previously recorded (Pr). The power of signal source (PMea) is recorded. The test should be performed by rotating the test item and adjusting the receiving antenna polarization.
6. A amplifier should be connected to the Signal Source output port. And the cable should be connect between the Amplifier and the Substitution Antenna. The cable loss (Pcl) ,the Substitution Antenna Gain (Ga) and the Amplifier Gain (PAg) should be recorded after test.
7. The measurement results are obtained as described below:  
Power(EIRP)=PMea- PAg - Pcl + Ga  
The measurement results are amend as described below:  
Power(EIRP)=PMea- Pcl + Ga
8. This value is EIRP since the measurement is calibrated using an antenna of known gain (2.15 dBi) and known input power. ERP can be calculated from EIRP by subtracting the gain of the dipole, ERP

= EIRP-2.15dBi.

The modulation mode and RB allocation refer to section 5.1, using the maximum output power configuration.

**Test setup**

**9KHz ~ 30MHz**

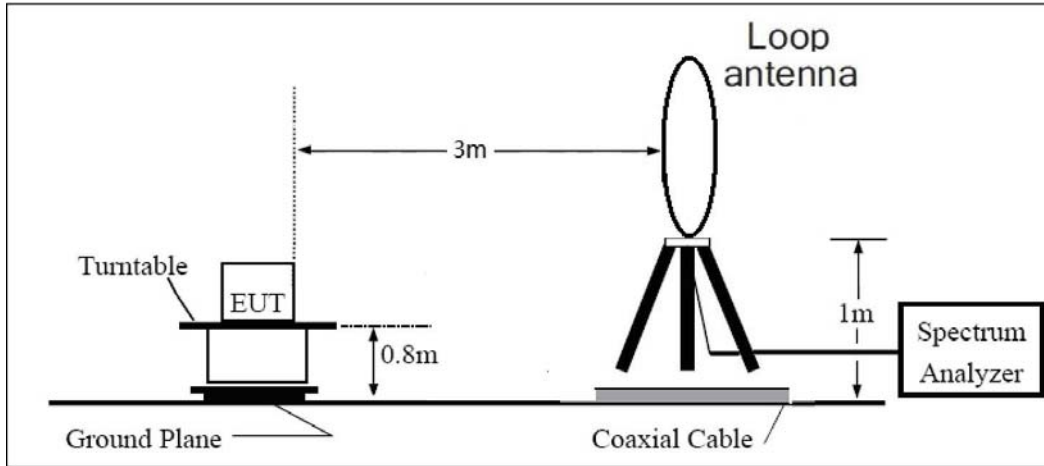

**30MHz ~ 1GHz**

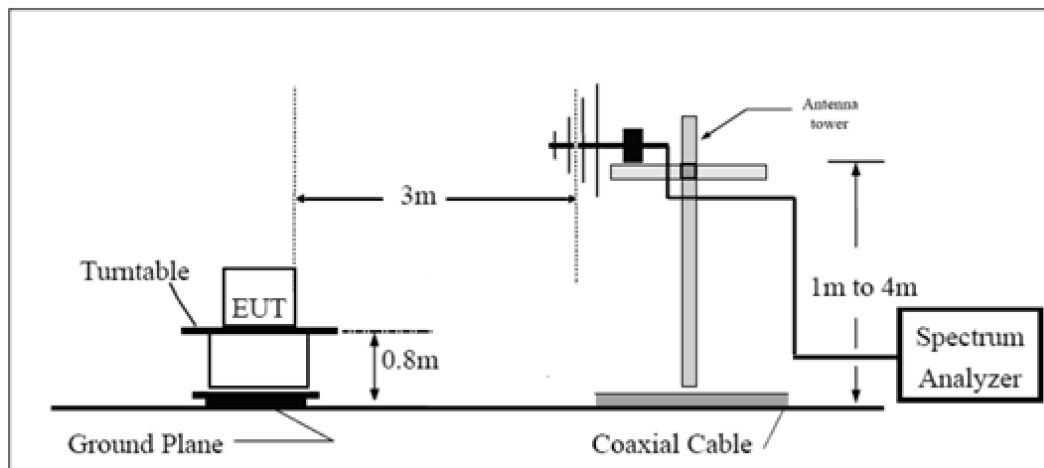

**Above 1GHz**

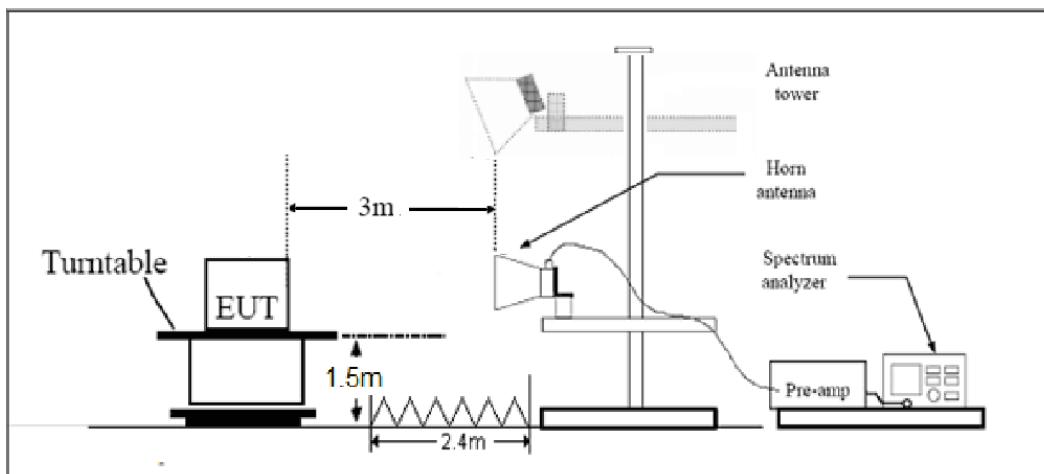

Note: Area side:2.4mX3.6m

## Limits

90.543 Emission limitations (e) For operations in the 758-768 MHz and the 788-798 MHz bands, the power of any emission outside the licensee's frequency band(s) of operation shall be attenuated below the transmitter power (P) within the licensed band(s) of operation, measured in watts, in accordance with the following:

(1) On all frequencies between 769-775 MHz and 799-805 MHz, by a factor not less than  $76 + 10 \log(P)$  dB in a 6.25 kHz band segment, for base and fixed stations.

(2) On all frequencies between 769-775 MHz and 799-805 MHz, by a factor not less than  $65 + 10 \log(P)$  dB in a 6.25 kHz band segment, for mobile and portable stations.

(3) On any frequency between 775-788 MHz, above 805 MHz, and below 758 MHz, by at least  $43 + 10 \log(P)$  dB.

(4) Compliance with the provisions of paragraphs (e)(1) and (2) of this section is based on the use of measurement instrumentation such that the reading taken with any resolution bandwidth setting should be adjusted to indicate spectral energy in a 6.25 kHz segment.

(5) Compliance with the provisions of paragraph (e)(3) of this section is based on the use of measurement instrumentation employing a resolution bandwidth of 100 kHz or greater. However, in the 100 kHz bands immediately outside and adjacent to the frequency block, a resolution bandwidth of 30 kHz may be employed.

(f) For operations in the 758-775 MHz and 788-805 MHz bands, all emissions including harmonics in the band 1559-1610 MHz shall be limited to  $-70$  dBW/MHz equivalent isotropically radiated power (EIRP) for wideband signals, and  $-80$  dBW EIRP for discrete emissions of less than 700 Hz bandwidth. For the purpose of equipment authorization, a transmitter shall be tested with an antenna that is representative of the type that will be used with the equipment in normal operation.

## Measurement Uncertainty

The assessed measurement uncertainty to ensure 95% confidence level for the normal distribution is with the coverage factor  $k = 1.96$ ,  $U = 3.55$  dB.

## Test Results

Refer to the section 6.4 of this report for test data.



## 6. Test Result

### 6.1. RF Power Output and Effective Radiated Power

LTE Band 14						
Bandwidth (MHz)	UL Channel	RB Size	RB Position	Modulation	Maximum Output Power (dBm)	ERP (dBm)
5	23305	1	#0	QPSK	24.14	26.44
5	23305	1	#Mid	QPSK	24.05	26.35
5	23305	1	#Max	QPSK	24.05	26.35
5	23305	12	#0	QPSK	23.12	25.42
5	23305	12	#Mid	QPSK	23.12	25.42
5	23305	12	#Max	QPSK	23.16	25.46
5	23305	25	#0	QPSK	23.22	25.52
5	23305	1	#0	QAM16	23.02	25.32
5	23305	1	#Mid	QAM16	23.03	25.33
5	23305	1	#Max	QAM16	22.69	24.99
5	23305	12	#0	QAM16	22.04	24.34
5	23305	12	#Mid	QAM16	22.04	24.34
5	23305	12	#Max	QAM16	22.05	24.35
5	23305	25	#0	QAM16	22.30	24.60
5	23330	1	#0	QPSK	24.02	26.32
5	23330	1	#Mid	QPSK	24.08	26.38
5	23330	1	#Max	QPSK	23.99	26.29
5	23330	12	#0	QPSK	23.17	25.47
5	23330	12	#Mid	QPSK	23.18	25.48
5	23330	12	#Max	QPSK	23.20	25.50
5	23330	25	#0	QPSK	23.15	25.45
5	23330	1	#0	QAM16	23.29	25.59
5	23330	1	#Mid	QAM16	23.49	25.79
5	23330	1	#Max	QAM16	23.32	25.62
5	23330	12	#0	QAM16	22.00	24.30
5	23330	12	#Mid	QAM16	21.96	24.26
5	23330	12	#Max	QAM16	22.00	24.30
5	23330	25	#0	QAM16	21.98	24.28
5	23355	1	#0	QPSK	24.04	26.34
5	23355	1	#Mid	QPSK	24.00	26.30
5	23355	1	#Max	QPSK	23.99	26.29
5	23355	12	#0	QPSK	23.15	25.45
5	23355	12	#Mid	QPSK	23.10	25.40



5	23355	12	#Max	QPSK	23.17	25.47
5	23355	25	#0	QPSK	23.12	25.42
5	23355	1	#0	QAM16	23.02	25.32
5	23355	1	#Mid	QAM16	23.02	25.32
5	23355	1	#Max	QAM16	22.92	25.22
5	23355	12	#0	QAM16	22.13	24.43
5	23355	12	#Mid	QAM16	22.14	24.44
5	23355	12	#Max	QAM16	22.09	24.39
5	23355	25	#0	QAM16	22.15	24.45

## 6.2. Band Edge Compliance

LTE Band 14 QPSK 5MHz CH-Low 1RB

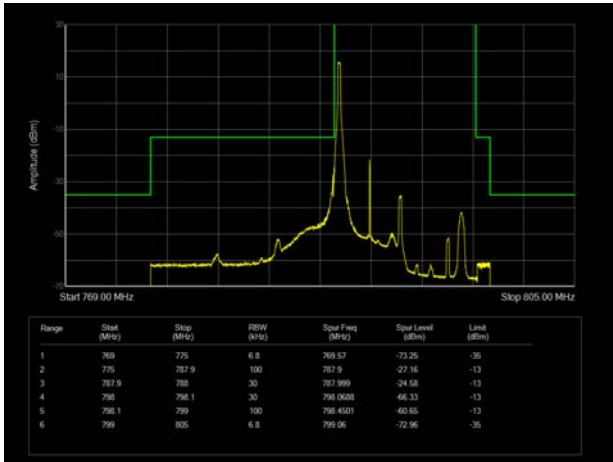

LTE Band 14 QPSK 5MHz CH-High 1RB

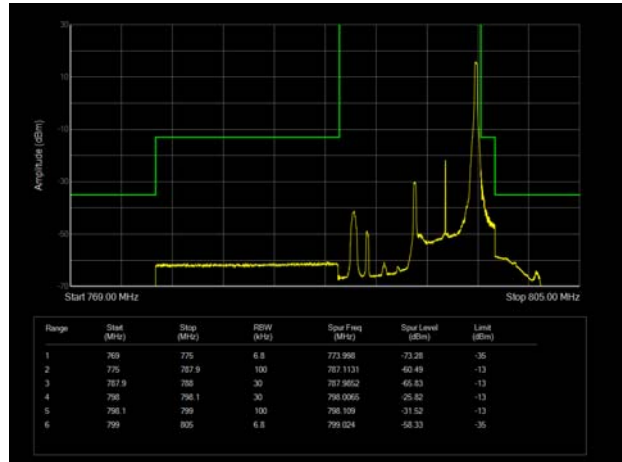

LTE Band 14 QPSK 5MHz CH-Low 100%RB

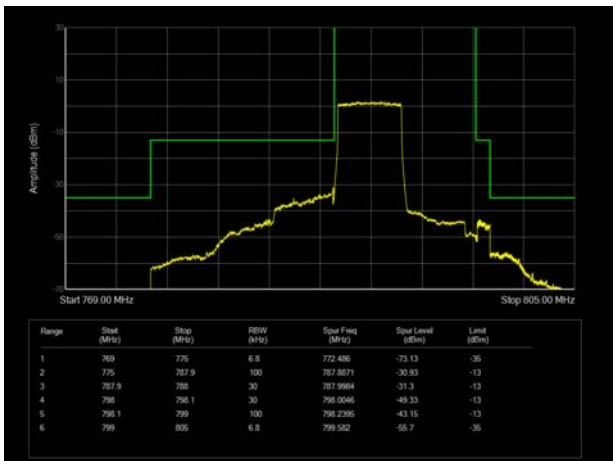

LTE Band 14 QPSK 5MHz CH-High 100%RB

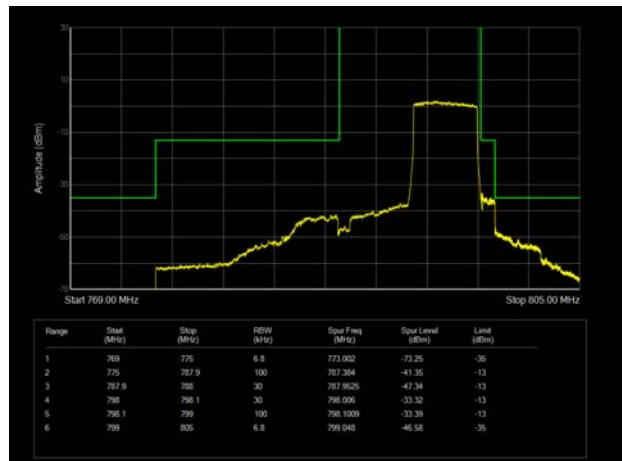

LTE Band 14 16QAM 5MHz CH-Low 1RB

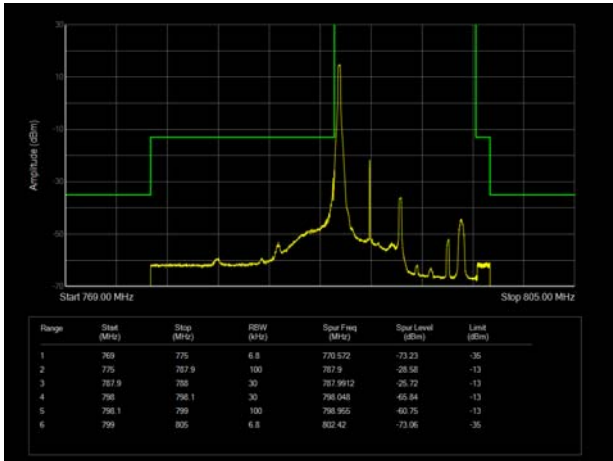

LTE Band 14 16QAM 5MHz CH-High 1RB

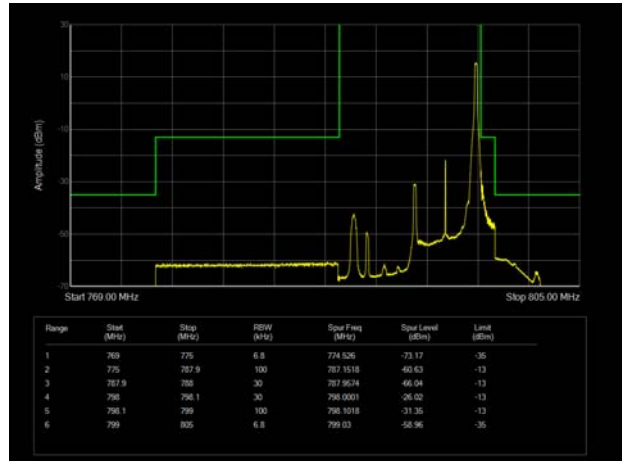

LTE Band 14 16QAM 5MHz CH-Low 100%RB

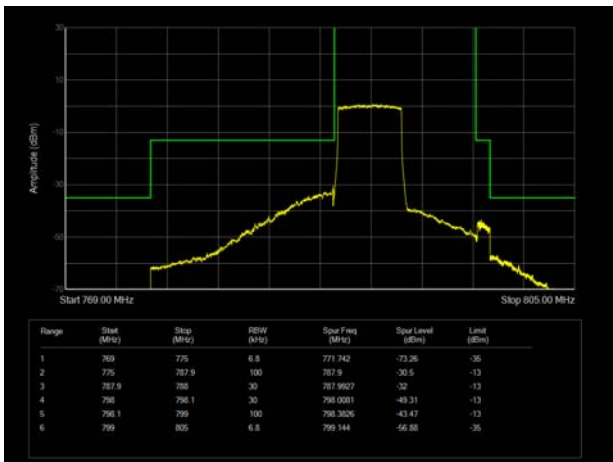

LTE Band 14 16QAM 5MHz CH-High 100%RB

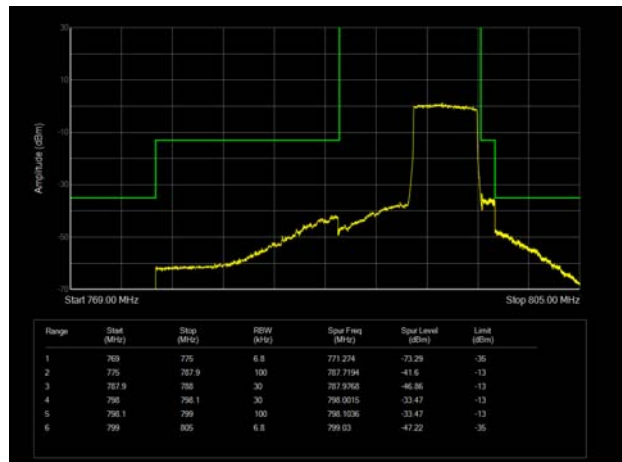

### 6.3. Spurious Emissions at Antenna Terminals

If disturbances were found more than 20dB below limit line, the mark is not required for the EUT. The signal beyond the limit is carrier.

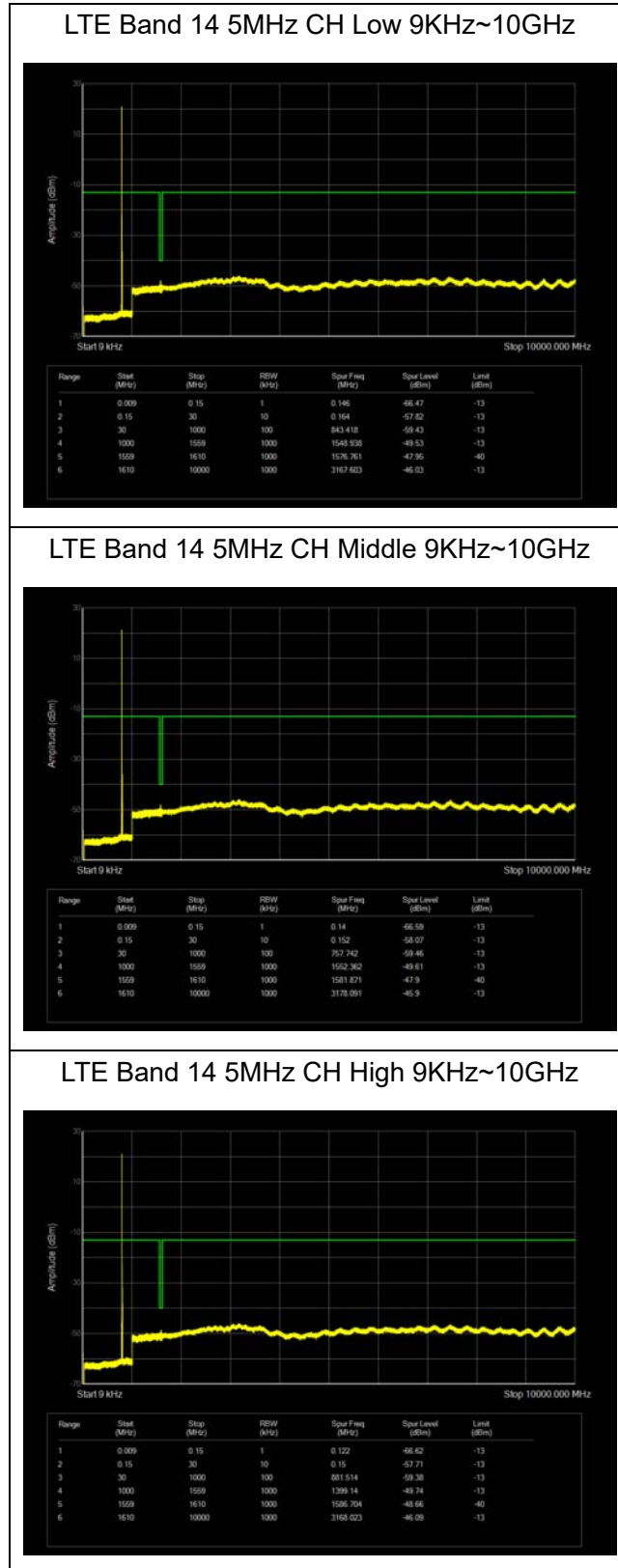



## 6.4. Radiated Spurious Emission

Sweep the whole frequency band through the range from 9kHz to the 10th harmonic of the carrier, the emissions below the noise floor will not be recorded in the report.

LTE Band 14 5MHz CH Middle

Harmonic	Frequency (MHz)	SG (dBm)	Cable Loss (dB)	Gain (dBi)	Antenna Polarization	ERP Level (dBm)	Limit (dBm)	Margin (dB)	Azimuth (deg)
2	1581.00	-51.91	1.70	8.70	Vertical	-47.06	-40.00	7.06	225
3	2371.00	-59.00	2.30	12.00	Vertical	-51.45	-13.00	38.45	90
4	3118.00	-62.87	2.30	13.10	Vertical	-54.22	-13.00	41.22	135
5	3897.50	-60.35	2.90	12.50	Vertical	-52.90	-13.00	39.90	270
6	4677.00	-58.78	3.10	12.50	Vertical	-51.53	-13.00	38.53	45
7	5456.50	-59.22	3.30	12.50	Vertical	-52.17	-13.00	39.17	90
8	6236.00	-56.91	3.80	11.50	Vertical	-51.36	-13.00	38.36	0
9	7015.50	-53.99	4.20	11.80	Vertical	-48.54	-13.00	35.54	225
10	7795.00	-57.20	4.40	12.30	Vertical	-51.45	-13.00	38.45	90

Note: 1.The other Spurious RF Radiated emissions level is no more than noise floor.  
2. The worst emission was found in the antenna is Vertical position.



## 7. Main Test Instruments

Name	Manufacturer	Type	Serial Number	Calibration Date	Expiration Date
Base Station Simulator	R&S	CMW500	150415	2022-05-14	2023-05-13
Spectrum Analyzer	Keysight	N9020A	MY50510203	2021-12-12	2022-12-11
Signal Analyzer	R&S	FSV3030	101411	2021-12-12	2022-12-11
Climatic Chamber	ESPEC	SU-242	93000506	2021-12-12	2022-12-11
Universal Radio Communication Tester	Agilent	E5515C	GB444400275	2021-12-12	2022-12-11
<b>Radiated Spurious Emissions</b>					
Signal Analyzer	R&S	FSV30	100815	2021-12-12	2022-12-11
Loop Antenna	SCHWARZBECK	FMZB1519	1519-047	2020-04-02	2023-04-01
TRILOG Broadband Antenna	Schwarzbeck	VULB 9163	01439	2021-06-30	2024-06-29
Horn Antenna	Schwarzbeck	BBHA 9120D	01799	2022-09-01	2025-08-31
Software	R&S	EMC32	10.35.10	/	/

\*\*\*\*\*END OF REPORT \*\*\*\*\*



## **ANNEX A: The EUT Appearance**

The EUT Appearance are submitted separately.





## ANNEX B: Test Setup Photos

The Test Setup Photos are submitted separately.