



RF TEST REPORT

Applicant Quectel Wireless Solutions Co., Ltd
FCC ID XMR2019SC650TNA
Product Smart Module
Brand Quectel
Model SC650T-NA
Report No. R2210A0926-R2V2
Issue Date November 8, 2022

TA Technology (Shanghai) Co., Ltd. tested the above equipment in accordance with the requirements in **FCC CFR47 Part 2 (2021)/ FCC CFR 47 Part 24E (2021)**. The test results show that the equipment tested is capable of demonstrating compliance with the requirements as documented in this report.

Prepared by: Xu Ying

Approved by: Xu Kai

TA Technology (Shanghai) Co., Ltd.

Building 3, No.145, Jintang Rd, Pudong Shanghai, P.R.China

TEL: +86-021-50791141/2/3

FAX: +86-021-50791141/2/3-8000

TABLE OF CONTENT

1. Test Laboratory	5
1.1. Notes of the test report.....	5
1.2. Test facility.....	5
1.3. Testing Location	5
2. General Description of Equipment under Test.....	6
2.1. Applicant and Manufacturer Information	6
2.2. General information	6
3. Applied Standards.....	8
4. Test Configuration.....	9
5. Test Case	11
5.1. RF Power Output and Effective Isotropic Radiated Power	11
5.2. Occupied Bandwidth	12
5.3. Band Edge Compliance.....	13
5.4. Peak-to-Average Power Ratio (PAPR)	14
5.5. Frequency Stability.....	15
5.6. Spurious Emissions at Antenna Terminals	17
5.7. Radiated Spurious Emission	18
6. Test Results	21
6.1. RF Power Output and Effective Isotropic Radiated Power	21
6.2. Occupied Bandwidth	25
6.3. Band Edge Compliance.....	27
6.4. Peak-to-Average Power Ratio (PAPR)	31
6.5. Frequency Stability.....	32
6.6. Spurious Emissions at Antenna Terminals	33
6.7. Radiated Spurious Emission	35
7. Main Test Instruments	37
ANNEX A: The EUT Appearance.....	38
ANNEX B: Test Setup Photos	39



Version	Revision description	Issue Date
Rev.0	Initial issue of report.	October 26, 2022
Rev.1	Update FCC ID.	November 7, 2022
Rev.2	Update Model.	November 8, 2022
Note: This revised report (Report No. R2210A0926-R2V2) supersedes and replaces the previously issued report (Report No. R2210A0926-R2V1). Please discard or destroy the previously issued report and dispose of it accordingly.		

Summary of measurement results

No.	Test Case	Clause in FCC rules	Verdict
1	RF Power Output and Effective Isotropic Radiated Power	2.1046 24.232(c)	PASS
2	Occupied Bandwidth	2.1049	PASS
3	Band Edge Compliance	2.1051 /24.238(a)	PASS
4	Peak-to-Average Power Ratio	24.232/KDB 971168 D01(5.7)	PASS
5	Frequency Stability	2.1055 / 24.235	PASS
6	Spurious Emissions at Antenna Terminals	2.1051 / 24.238(a)	PASS
7	Radiated Spurious Emission	2.1053 / 24.238(a)	PASS
Date of Testing: October 12, 2022 ~ October 18, 2022			
Date of Sample Received: October 12, 2022			
<p>Note: PASS: The EUT complies with the essential requirements in the standard.</p> <p>FAIL: The EUT does not comply with the essential requirements in the standard.</p> <p>All indications of Pass/Fail in this report are opinions expressed by TA Technology (Shanghai) Co., Ltd. based on interpretations and/or observations of test results. Measurement Uncertainties were not taken into account and are published for informational purposes only.</p>			

1. Test Laboratory

1.1. Notes of the test report

This report shall not be reproduced in full or partial, without the written approval of **TA technology (shanghai) co., Ltd.** The results documented in this report apply only to the tested sample, under the conditions and modes of operation as described herein .Measurement Uncertainties were not taken into account and are published for informational purposes only. This report is written to support regulatory compliance of the applicable standards stated above.

1.2. Test facility

FCC (Designation number: CN1179, Test Firm Registration Number: 446626)

TA Technology (Shanghai) Co., Ltd. has been listed on the US Federal Communications Commission list of test facilities recognized to perform measurements.

A2LA (Certificate Number: 3857.01)

TA Technology (Shanghai) Co., Ltd. has been listed by American Association for Laboratory Accreditation to perform measurement.

1.3. Testing Location

Company: TA Technology (Shanghai) Co., Ltd.
Address: Building 3, No.145, Jintang Rd, Pudong Shanghai, P.R.China
City: Shanghai
Post code: 201201
Country: P. R. China
Contact: Xu Kai
Telephone: +86-021-50791141/2/3
Fax: +86-021-50791141/2/3-8000
Website: <http://www.ta-shanghai.com>
E-mail: xukai@ta-shanghai.com

2. General Description of Equipment under Test

2.1. Applicant and Manufacturer Information

Applicant	Quectel Wireless Solutions Co., Ltd
Applicant address	Building 5, Shanghai Business Park Phase III (Area B), No.1016 Tianlin Road, Minhang District, Shanghai, China 200233
Manufacturer	Quectel Wireless Solutions Co., Ltd
Manufacturer address	Building 5, Shanghai Business Park Phase III (Area B), No.1016 Tianlin Road, Minhang District, Shanghai, China 200233

2.2. General information

EUT Description			
Model	SC650T-NA		
IMEI	IMEI1:865920060000042 IMEI2:865920060000059		
Hardware Version	R1.0		
Software Version	SC650TNALPAR05A01		
Power Supply	External power supply		
Antenna Type	The EUT don't have standard Antenna, The Antenna used for testing in this report is the after-market accessory (Dipole Antenna)		
Antenna Gain	Band	Gain (dBi)	
	WCDMA Band II:	1.59	
	LTE Band 2:	1.59	
	LTE Band 25:	1.59	
Test Mode(s)	WCDMA Band II; LTE Band 2/25;		
Test Modulation	(WCDMA) BPSK, QPSK; (LTE) QPSK, 16QAM;		
HSDPA UE Category	24		
HSUPA UE Category	6		
Maximum E.I.R.P	WCDMA Band II:	25.47 dBm	
	LTE Band 2:	25.60 dBm	
	LTE Band 25:	26.02 dBm	
Rated Power Supply Voltage	DC 3.8V		
Operating Voltage	Minimum: 3.55V Maximum: 4.40V		
Operating Temperature	Lowest: -35°C Highest: +75°C		
Testing Temperature	Lowest: -30°C Highest: +50°C		
Operating Frequency Range(s)	Band	Tx (MHz)	Rx (MHz)
	WCDMA Band II	1850 ~ 1910	1930 ~ 1990



	LTE Band 2	1850 ~ 1910	1930 ~ 1990
	LTE Band 25	1850 ~ 1915	1930 ~ 1995
<p>Note:</p> <p>1. The EUT is sent from the applicant to TA and the information of the EUT is declared by the applicant.</p>			

3. Applied Standards

According to the specifications of the manufacturer, it must comply with the requirements of the following standards:

Test standards:

FCC CFR 47 Part 24E (2021)

FCC CFR47 Part 2 (2021)

Reference standard:

ANSI C63.26-2015

KDB 971168 D01 Power Meas License Digital Systems v03r01

4. Test Configuration

There is more than one SIM card slot, each one should be applied throughout the compliance test respectively, and however, only the worst case (SIM 1) will be recorded in this report.

Radiated measurements are performed by rotating the EUT in three different orthogonal test planes. EUT stand-up position (Z axis), lie-down position (X, Y axis). Receiver antenna polarization (horizontal and vertical), the worst emission was found in position (X axis, horizontal polarization for WCDMA Band and Z axis, vertical polarization for LTE Band) and the worst case was recorded.

All mode and data rates and positions and RB size and modulations were investigated.

Subsequently, only the worst case emissions are reported.

The following testing in WCDMA/LTE is set based on the maximum RF Output Power.

Test modes are chosen to be reported as the worst case configuration below:

Test items	Modes/Modulation
	WCDMA Band II
RF Power Output and Effective Isotropic Radiated Power	RMC HSDPA/HSUPA DC-HSDPA
Occupied Bandwidth	RMC
Band Edge Compliance	RMC
Peak-to-Average Power Ratio	RMC
Frequency Stability	RMC
Spurious Emissions at Antenna Terminals	RMC
Radiated Spurious Emission	RMC

Test modes are chosen to be reported as the worst case configuration below for LTE Band 2/25:

Test items	Modes	Bandwidth (MHz)						Modulation		RB			Test Channel			
		1.4	3	5	10	15	20	QPSK	16QAM	1	50%	100%	L	M	H	
RF Power Output and Effective Isotropic Radiated Power	LTE Band 2	-	-	0	-	-	-	0	0	0	0	0	0	0	0	0
	LTE Band 25	0	-	-	-	-	-	0	0	0	0	0	0	0	0	0
Band Edge Compliance	LTE Band 2	-	-	0	-	-	-	0	0	0	-	0	0	-	0	



	LTE Band 25	O	-	-	-	-	-	O	O	O	-	O	O	-	O
Spurious Emissions at Antenna Terminals	LTE Band 2	-	-	O	-	-	-	O	-	O	-	-	O	O	O
	LTE Band 25	O	-	-	-	-	-	O	-	O	-	-	O	O	O
Radiated Spurious Emission	LTE Band 2	-	-	O	-	-	-	O	-	O	-	-	-	O	-
	LTE Band 25	O	-	-	-	-	-	O	-	O	-	-	-	O	-
Note	<p>1. The mark "O" means that this configuration is chosen for testing.</p> <p>2. The mark "-" means that this configuration is not testing.</p>														

5. Test Case

5.1.RF Power Output and Effective Isotropic Radiated Power

Ambient condition

Temperature	Relative humidity	Pressure
23°C ~25°C	45%~50%	101.5kPa

Methods of Measurement

During the process of the testing, The EUT was connected to the Base Station Simulator with a known loss. The EUT is controlled by the Base Station Simulator test set to ensure max power transmission with proper modulation.

ERP can then be calculated as follows:

$$\text{EIRP (dBm)} = \text{Output Power (dBm)} + \text{Antenna Gain (dBi)}$$

where:dBd refers to gain relative to an ideal dipole.

$$\text{EIRP (dBm)} = \text{ERP (dBm)} + 2.15 \text{ (dB.)}$$

Test Setup

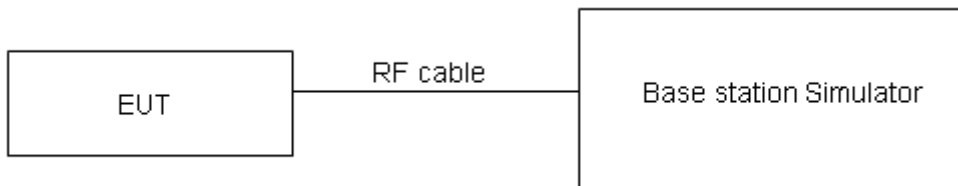

Limits

No specific RF power output requirements in part 2.1046.

Rule Part 24.232(c) Mobile and portable stations are limited to 2 watts EIRP.

Rule Part 24.232(e) Peak transmit power must be measured over any interval of continuous transmission using instrumentation calibrated in terms of an rms-equivalent voltage.

Limit	$\leq 2 \text{ W}$ (33 dBm)
-------	-----------------------------

Measurement Uncertainty

The assessed measurement uncertainty to ensure 95% confidence level for the normal distribution is with the coverage factor $k = 2$, $U = 0.4 \text{ dB}$ for RF power output, $k = 2$, $U = 1.19 \text{ dB}$ for EIRP.

Test Results

Refer to the section 6.1 of this report for test data.

5.2.Occupied Bandwidth

Ambient condition

Temperature	Relative humidity	Pressure
23°C ~25°C	45%~50%	101.5kPa

Method of Measurement

The EUT was connected to Spectrum Analyzer and Base Station Simulator via power Splitter. The occupied bandwidth is measured using spectrum analyzer.

RBW is set to $\geq 1\%EBW$, VBW is set to 3x RBW.

99% power and -26dBc occupied bandwidths are recorded. Spectrum analyzer plots are included on the following pages.

Test Setup

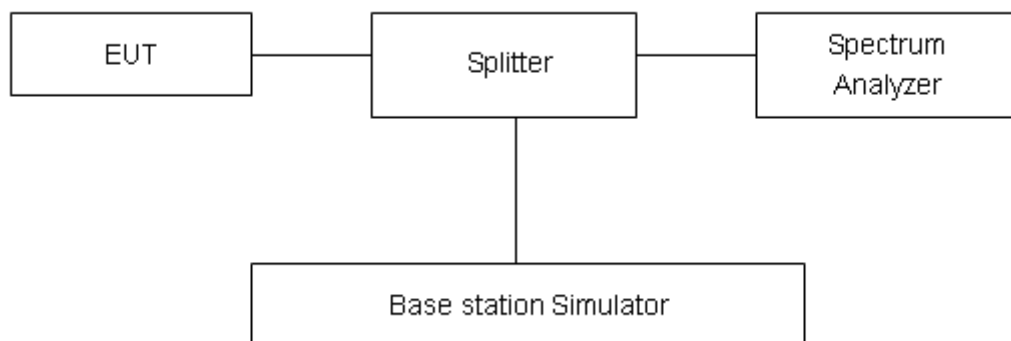

Limits

No specific occupied bandwidth requirements in part 2.1049.

Measurement Uncertainty

The assessed measurement uncertainty to ensure 95% confidence level for the normal distribution is with the coverage factor $k = 2$, $U = 624\text{Hz}$.

Test Results

Refer to the section 6.2 of this report for test data.

5.3. Band Edge Compliance

Ambient condition

Temperature	Relative humidity	Pressure
23°C ~25°C	45%~50%	101.5kPa

Method of Measurement

The EUT was connected to Spectrum Analyzer and Base Station Simulator via power Splitter. The band edge of the lowest and highest channels were measured. The Average detector is used and RBW is set to $\geq 1\%EBW$, VBW is set to 3x RBW.

Spectrum analyzer plots are included on the following pages.

Test Setup

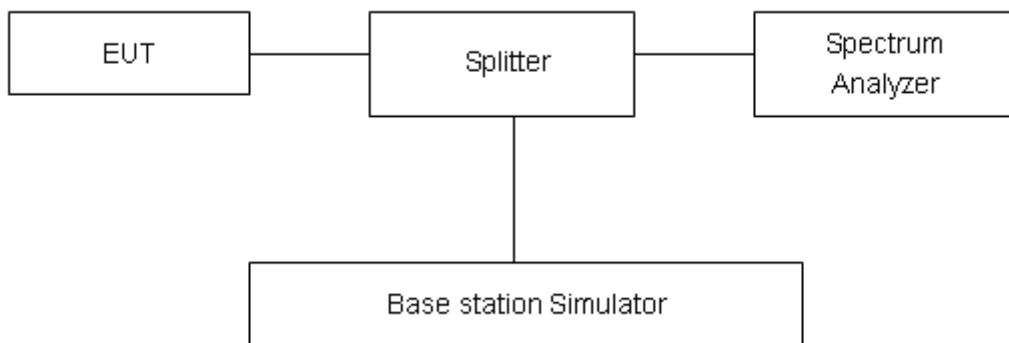

Limits

Rule Part 24.238(a) specifies that “on any frequency outside a licensee’s frequency block, the power of any emission shall be attenuated below the transmitter power (P) by at least $43 + 10 \log_{10} (P)$ dB.”

Limit	-13 dBm
-------	---------

Measurement Uncertainty

The assessed measurement uncertainty to ensure 95% confidence level for the normal distribution is with the coverage factor $k = 1.96$, $U=0.684dB$.

Test Results

Refer to the section 6.3 of this report for test data.

5.4. Peak-to-Average Power Ratio (PAPR)

Ambient condition

Temperature	Relative humidity	Pressure
23°C ~25°C	45%~50%	101.5kPa

Methods of Measurement

Measure the total peak power and record as PPK. And measure the total average power and record as PAvg. Both the peak and average power levels must be expressed in the same logarithmic units (e.g., dBm). Determine the PAPR from:

$$PAPR (dB) = PPK (dBm) - PAvg (dBm).$$

Test Setup

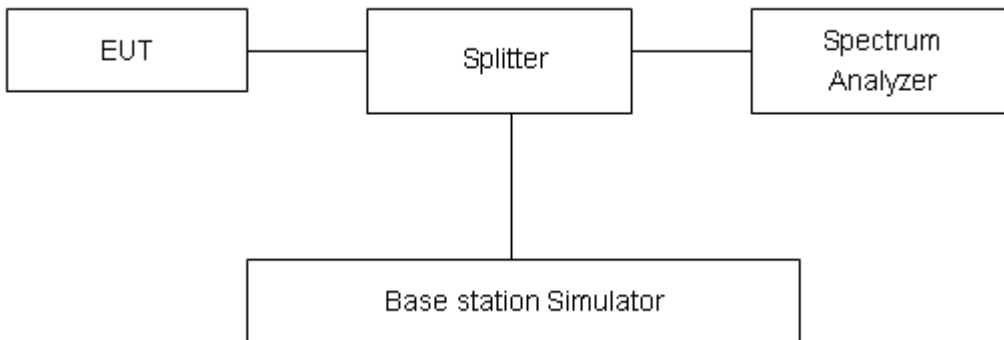

Limits

In measuring transmissions in this band using an average power technique, the peak-to-average ratio (PAR) of the transmission may not exceed 13 dB in 24.232(d).

Measurement Uncertainty

The assessed measurement uncertainty to ensure 95% confidence level for the normal distribution is with the coverage factor k = 2, U= 0.4 dB.

Test Results

Refer to the section 6.4 of this report for test data.

5.5. Frequency Stability

Ambient condition

Temperature	Relative humidity	Pressure
23°C ~25°C	45%~50%	101.5kPa

Method of Measurement

Frequency Stability (Temperature Variation)

The temperature inside the climate chamber is varied from -30°C to +50°C in 10°C step size,

(1) With all power removed, the temperature was decreased to 0°C and permitted to stabilize for three hours.

(2) Measure the carrier frequency with the test equipment in a “call mode”. These measurements should be made within 1 minute of powering up the mobile station, to prevent significant self warming.

(3) Repeat the above measurements at 10°C increments from -30°C to +50°C. Allow at least 1.5 hours at each temperature, un-powered, before making measurements.

Frequency Stability (Voltage Variation)

The frequency stability shall be measured with variation of primary supply voltage as follows:

Primary Supply Voltage: The primary supply voltage is varied from 85% to 115% of the nominal value for non hand-carried battery and AC powered equipment. For hand-carried, battery-powered equipment, primary supply voltage is reduced to the battery operating end point which shall be specified by the manufacturer.

This transceiver is specified to operate with an input voltage of between 3.55 V and 4.40 V, with a nominal voltage of 3.8V.

Test setup

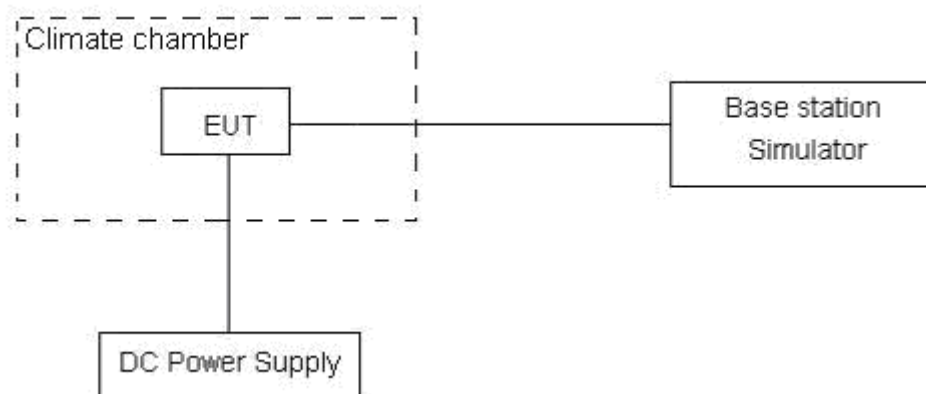

Limits

The frequency stability shall be sufficient to ensure that the fundamental emission stays within the authorized frequency block

Measurement Uncertainty

The assessed measurement uncertainty to ensure 99.75% confidence level for the normal distribution is with the coverage factor $k = 3$, $U = 0.01\text{ppm}$.

Test Results

Refer to the section 6.5 of this report for test data.

5.6. Spurious Emissions at Antenna Terminals

Ambient condition

Temperature	Relative humidity	Pressure
23°C ~25°C	45%~50%	101.5kPa

Method of Measurement

The EUT was connected to Spectrum Analyzer and Base Station Simulator via power Splitter. The measurement is carried out using a spectrum analyzer. The spectrum analyzer scans from 9kHz to the 10th harmonic of the carrier. The peak detector is used.

RBW is set to 1 kHz (0.009MHz~ 0.15 MHz),

RBW is set to 10 kHz (0.15 MHz~ 30 MHz)

RBW is set to 100 kHz (30MHz~1000 MHz)

RBW is set to 1000 kHz (above 1000MHz)

Sweep is set to ATUO.

The modulation mode and RB allocation refer to section 5.1, using the maximum output power configuration.

Test setup

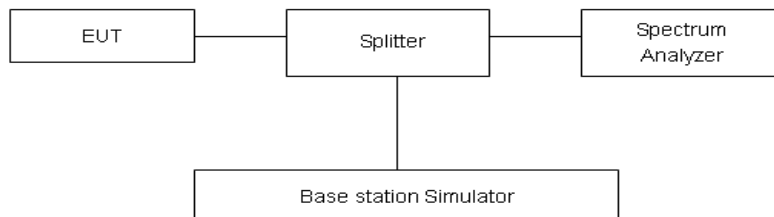

Limits

Rule Part 24.238(a) specifies that “on any frequency outside a licensee’s frequency block, the power of any emission shall be attenuated below the transmitter power (P) by at least $43 + 10 \log_{10} (P)$ dB.”

Limit	-13 dBm

Measurement Uncertainty

The assessed measurement uncertainty to ensure 99.75% confidence level for the normal distribution is with the coverage factor $k = 1.96$.

Frequency	Uncertainty
9kHz-1GHz	0.684 dB
1GHz-20GHz	1.407 dB

Test Results

Refer to the section 6.6 of this report for test data.

5.7. Radiated Spurious Emission

Ambient condition

Temperature	Relative humidity	Pressure
23°C ~25°C	45%~50%	101.5kPa

Method of Measurement

- The testing follows FCC KDB 971168 v03r01 Section 5.8 and ANSI C63.26-2015.
- Below 1GHz: The EUT is placed on a turntable 0.8 meters above the ground in the chamber, 3 meter away from the antenna. The maximal emission value is acquired by adjusting the antenna height, polarisation and turntable azimuth. Normally, the height range of antenna is 1 m to 4 m, the azimuth range of turntable is 0° to 360°, and the receive antenna has two polarizations Vertical (V) and Horizontal (H). Above 1GHz: (Note: the FCC's permission to use 1.5m as an alternative per TCBC Conf call of Dec. 2, 2014.) The EUT is placed on a turntable 1.5 meters above the ground in the chamber, 3 meter away from the antenna. The maximal emission value is acquired by adjusting the antenna height, polarisation and turntable azimuth. Normally, the height range of antenna is 1 m to 4 m, the azimuth range of turntable is 0° to 360°, and the receive antenna has two polarizations Vertical (V) and Horizontal (H).
- A loop antenna, A log-periodic antenna or horn antenna shall be substituted in place of the EUT. The log-periodic antenna will be driven by a signal generator and the level will be adjusted till the same power value on the spectrum analyzer or receiver. The level of the spurious emissions can be calculated through the level of the signal generator, cable loss, the gain of the substitution antenna and the reading of the spectrum analyzer or receiver.
- The EUT is then put into continuously transmitting mode at its maximum power level during the test. Set Test Receiver or Spectrum RBW=1MHz, VBW=3MHz, and the maximum value of the receiver should be recorded as (Pr).
- The EUT shall be replaced by a substitution antenna. In the chamber, an substitution antenna for the frequency band of interest is placed at the reference point of the chamber. An RF Signal source for the frequency band of interest is connected to the substitution antenna with a cable that has been constructed to not interfere with the radiation pattern of the antenna. A power (PMea) is applied to the input of the substitution antenna, and adjust the level of the signal generator output until the value of the receiver reach the previously recorded (Pr). The power of signal source (PMea) is recorded. The test should be performed by rotating the test item and adjusting the receiving antenna polarization.
- A amplifier should be connected to the Signal Source output port. And the cable should be connect between the Amplifier and the Substitution Antenna. The cable loss (Pcl) ,the Substitution Antenna Gain (Ga) and the Amplifier Gain (PAg) should be recorded after test.
- The measurement results are obtained as described below:
 $Power(EIRP)=PMea- PAg - Pcl + Ga$
 The measurement results are amend as described below:
 $Power(EIRP)=PMea- Pcl + Ga$
- This value is EIRP since the measurement is calibrated using an antenna of known gain (2.15 dB) and known input power. ERP can be calculated from EIRP by subtracting the gain of the dipole, ERP

= EIRP-2.15dB.

The modulation mode and RB allocation refer to section 5.1, using the maximum output power configuration.

Test setup

9KHz~ 30MHz

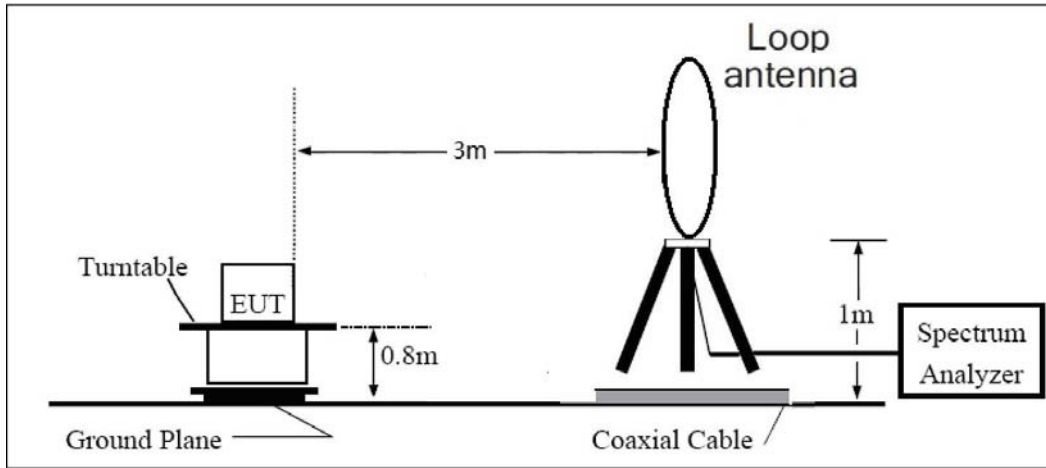

30MHz~ 1GHz

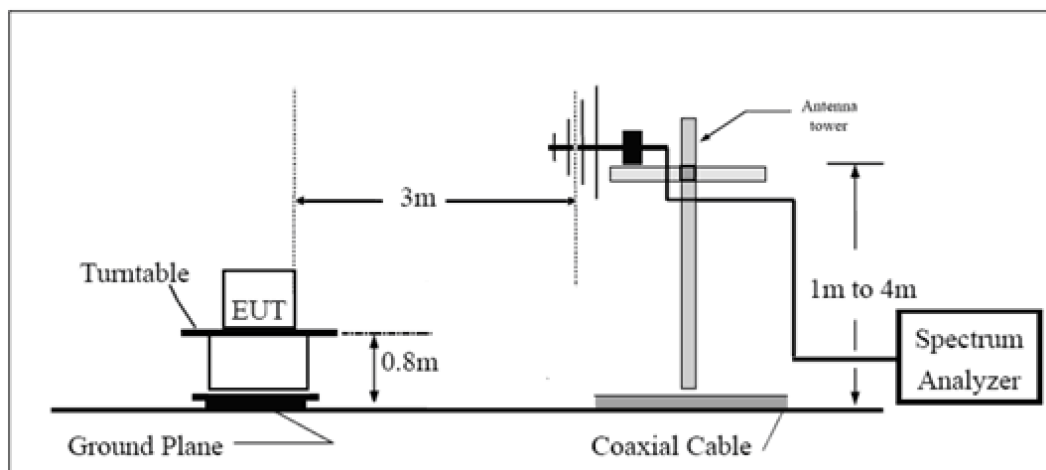

Above 1GHz

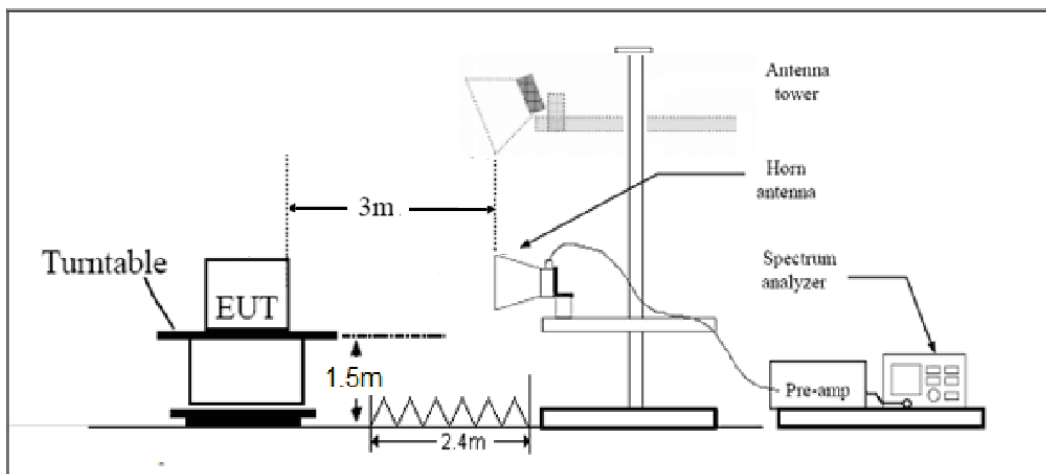

Note: Area side: 2.4mX3.6m

**Limits**

Rule Part 24.238(a) specifies that “on any frequency outside a licensee's frequency block, the power of any emission shall be attenuated below the transmitter power (P) by at least $43 + 10 \log_{10} (P)$ dB.”

Limit	-13 dBm
-------	---------

Measurement Uncertainty

The assessed measurement uncertainty to ensure 95% confidence level for the normal distribution is with the coverage factor $k = 1.96$, $U = 3.55$ dB.

Test Results

Refer to the section 6.7 of this report for test data.

6. Test Results

6.1.RF Power Output and Effective Isotropic Radiated Power

WCDMA Band II		Maximum Output Power (dBm)			EIRP (dBm)		
		Channel 9262	Channel 9400	Channel 9538	Channel 9262	Channel 9400	Channel 9538
		1852.4 (MHz)	1880 (MHz)	1907.6 (MHz)	1852.4 (MHz)	1880 (MHz)	1907.6 (MHz)
RMC		23.80	23.12	23.04	25.39	24.71	24.63
HSDPA	Sub - Test 1	23.46	22.56	22.52	25.05	24.15	24.11
	Sub - Test 2	23.18	22.68	22.62	24.77	24.27	24.21
	Sub - Test 3	22.96	22.10	21.98	24.55	23.69	23.57
	Sub - Test 4	22.68	22.00	22.10	24.27	23.59	23.69
HSUPA	Sub - Test 1	22.16	21.54	21.52	23.75	23.13	23.11
	Sub - Test 2	20.36	19.60	19.52	21.95	21.19	21.11
	Sub - Test 3	21.32	20.76	20.58	22.91	22.35	22.17
	Sub - Test 4	20.34	19.76	19.54	21.93	21.35	21.13
	Sub - Test 5	23.88	23.26	22.92	25.47	24.85	24.51
DC-HSDPA	Sub - Test 1	23.30	22.72	22.52	24.89	24.31	24.11
	Sub - Test 2	23.44	22.54	22.70	25.03	24.13	24.29
	Sub - Test 3	22.72	22.26	22.00	24.31	23.85	23.59
	Sub - Test 4	22.84	22.16	21.90	24.43	23.75	23.49



LTE Band2						
Bandwidth (MHz)	UL Channel	RB Size	RB Position	Modulation	Maximum Output Power (dBm)	EIRP (dBm)
5	18625	1	#0	QPSK	23.93	25.52
5	18625	1	#Mid	QPSK	23.94	25.53
5	18625	1	#Max	QPSK	23.91	25.50
5	18625	12	#0	QPSK	23.00	24.59
5	18625	12	#Mid	QPSK	23.00	24.59
5	18625	12	#Max	QPSK	23.01	24.60
5	18625	25	#0	QPSK	23.07	24.66
5	18625	1	#0	QAM16	22.94	24.53
5	18625	1	#Mid	QAM16	22.94	24.53
5	18625	1	#Max	QAM16	22.91	24.50
5	18625	12	#0	QAM16	21.87	23.46
5	18625	12	#Mid	QAM16	21.87	23.46
5	18625	12	#Max	QAM16	21.98	23.57
5	18625	25	#0	QAM16	21.96	23.55
5	18900	1	#0	QPSK	23.82	25.41
5	18900	1	#Mid	QPSK	24.01	25.60
5	18900	1	#Max	QPSK	23.63	25.22
5	18900	12	#0	QPSK	22.91	24.50
5	18900	12	#Mid	QPSK	22.91	24.50
5	18900	12	#Max	QPSK	22.86	24.45
5	18900	25	#0	QPSK	22.98	24.57
5	18900	1	#0	QAM16	22.99	24.58
5	18900	1	#Mid	QAM16	23.00	24.59
5	18900	1	#Max	QAM16	23.05	24.64
5	18900	12	#0	QAM16	21.67	23.26
5	18900	12	#Mid	QAM16	21.68	23.27
5	18900	12	#Max	QAM16	21.61	23.20
5	18900	25	#0	QAM16	21.68	23.27
5	19175	1	#0	QPSK	23.89	25.48
5	19175	1	#Mid	QPSK	24.00	25.59
5	19175	1	#Max	QPSK	23.94	25.53
5	19175	12	#0	QPSK	23.03	24.62
5	19175	12	#Mid	QPSK	23.03	24.62
5	19175	12	#Max	QPSK	23.10	24.69
5	19175	25	#0	QPSK	23.03	24.62
5	19175	1	#0	QAM16	22.84	24.43
5	19175	1	#Mid	QAM16	23.09	24.68



5	19175	1	#Max	QAM16	22.78	24.37
5	19175	12	#0	QAM16	21.94	23.53
5	19175	12	#Mid	QAM16	21.93	23.52
5	19175	12	#Max	QAM16	21.88	23.47
5	19175	25	#0	QAM16	21.99	23.58

LTE Band 25						
Bandwidth (MHz)	UL Channel	RB Size	RB Position	Modulation	Maximum Output Power (dBm)	EIRP (dBm)
1.4	26047	1	#0	QPSK	24.30	25.89
1.4	26047	1	#Mid	QPSK	24.43	26.02
1.4	26047	1	#Max	QPSK	24.34	25.93
1.4	26047	3	#0	QPSK	24.01	25.60
1.4	26047	3	#Mid	QPSK	24.14	25.73
1.4	26047	3	#Max	QPSK	24.02	25.61
1.4	26047	6	#0	QPSK	23.15	24.74
1.4	26047	1	#0	QAM16	23.41	25.00
1.4	26047	1	#Mid	QAM16	23.54	25.13
1.4	26047	1	#Max	QAM16	23.22	24.81
1.4	26047	3	#0	QAM16	23.32	24.91
1.4	26047	3	#Mid	QAM16	23.21	24.80
1.4	26047	3	#Max	QAM16	23.37	24.96
1.4	26047	6	#0	QAM16	22.01	23.60
1.4	26365	1	#0	QPSK	23.88	25.47
1.4	26365	1	#Mid	QPSK	23.90	25.49
1.4	26365	1	#Max	QPSK	23.90	25.49
1.4	26365	3	#0	QPSK	23.98	25.57
1.4	26365	3	#Mid	QPSK	23.98	25.57
1.4	26365	3	#Max	QPSK	24.09	25.68
1.4	26365	6	#0	QPSK	22.98	24.57
1.4	26365	1	#0	QAM16	23.26	24.85
1.4	26365	1	#Mid	QAM16	23.39	24.98
1.4	26365	1	#Max	QAM16	23.32	24.91
1.4	26365	3	#0	QAM16	23.04	24.63
1.4	26365	3	#Mid	QAM16	23.04	24.63
1.4	26365	3	#Max	QAM16	23.08	24.67
1.4	26365	6	#0	QAM16	22.05	23.64
1.4	26683	1	#0	QPSK	24.07	25.66
1.4	26683	1	#Mid	QPSK	24.21	25.80
1.4	26683	1	#Max	QPSK	24.04	25.63
1.4	26683	3	#0	QPSK	24.05	25.64



1.4	26683	3	#Mid	QPSK	24.05	25.64
1.4	26683	3	#Max	QPSK	24.01	25.60
1.4	26683	6	#0	QPSK	23.13	24.72
1.4	26683	1	#0	QAM16	22.73	24.32
1.4	26683	1	#Mid	QAM16	22.92	24.51
1.4	26683	1	#Max	QAM16	22.71	24.30
1.4	26683	3	#0	QAM16	23.09	24.68
1.4	26683	3	#Mid	QAM16	23.09	24.68
1.4	26683	3	#Max	QAM16	23.11	24.70
1.4	26683	6	#0	QAM16	22.27	23.86

6.2.Occupied Bandwidth

Mode	Channel	Frequency (MHz)	99% Power Bandwidth (MHz)	-26dBc Bandwidth(MHz)
WCDMA Band II (RMC)	9262	1852.4	4.118	4.683
	9400	1880	4.117	4.694
	9538	1907.6	4.122	4.705

WCDMA Band II RMC CH-LOW



WCDMA Band II RMC CH-Middle



WCDMA Band II RMC CH-High



6.3. Band Edge Compliance

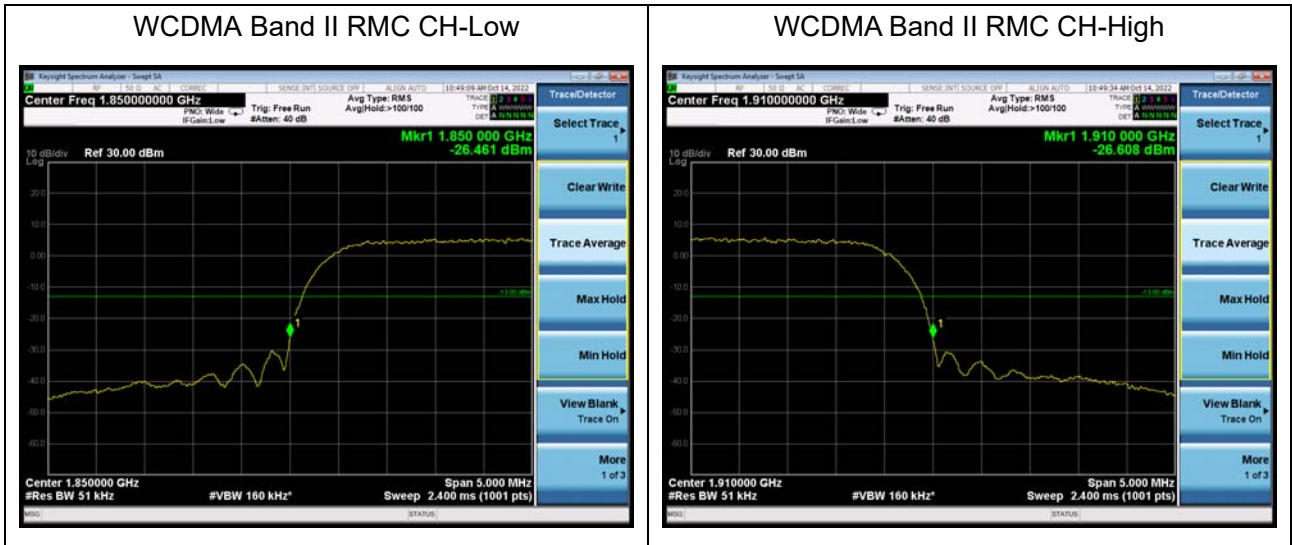

LTE Band 2 5MHz QPSK 1RB CH-Low

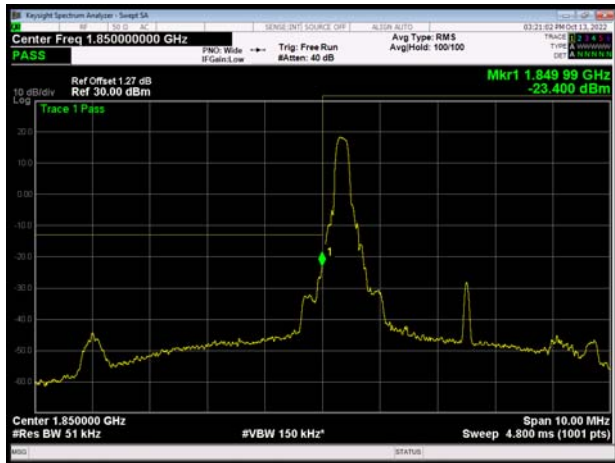

LTE Band 2 5MHz QPSK 1RB CH-High

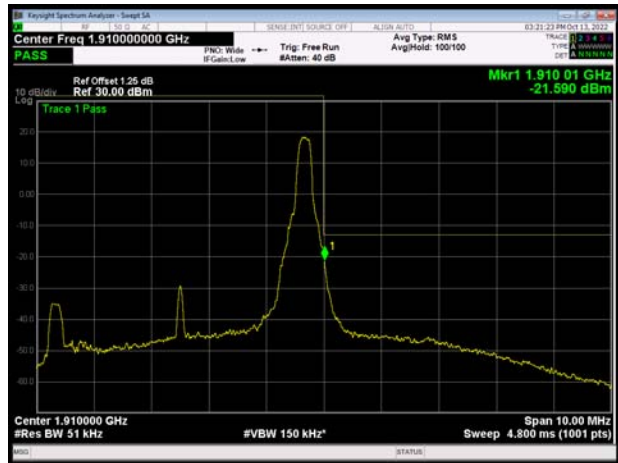

LTE Band 2 5MHz QPSK 100%RB CH-Low

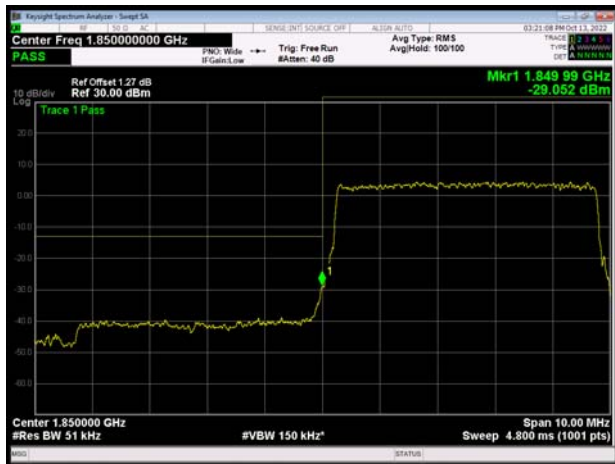

LTE Band 2 5MHz QPSK 100%RB CH-High

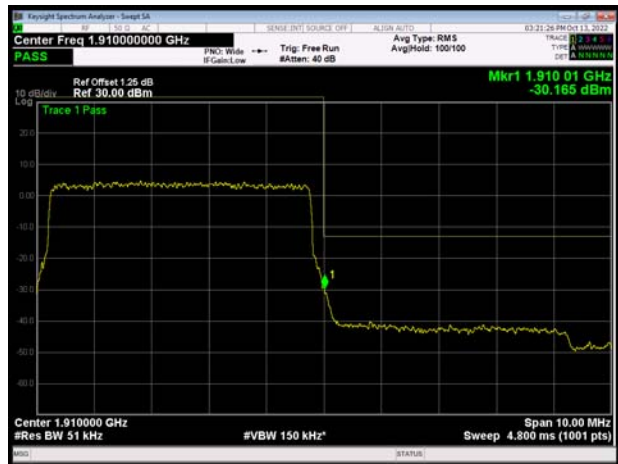

LTE Band 2 5MHz 16QAM 1RB CH-Low

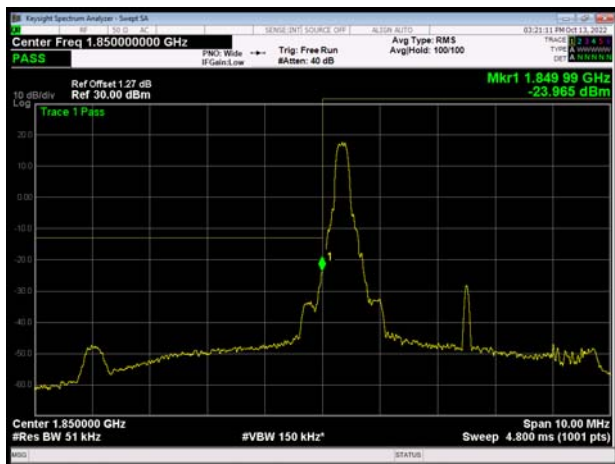

LTE Band 2 5MHz 16QAM 1RB CH-High

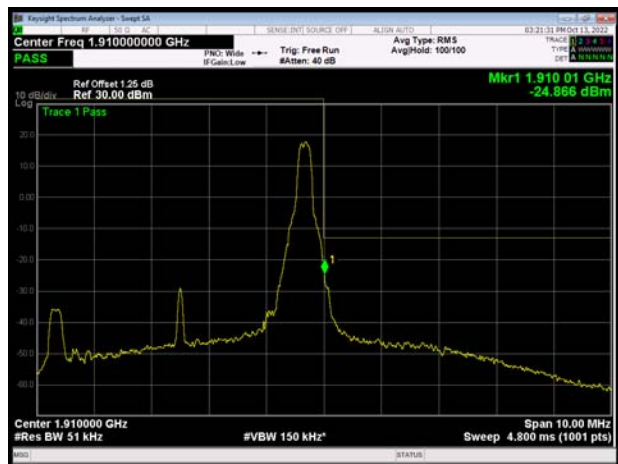

LTE Band 2 5MHz 16QAM 100%RB CH-Low

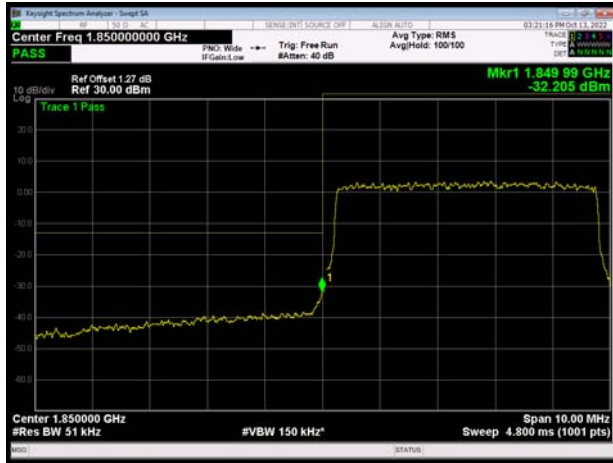

LTE Band 2 5MHz 16QAM 100%RB CH-High



LTE Band 25 1.4MHz QPSK 1RB CH-Low

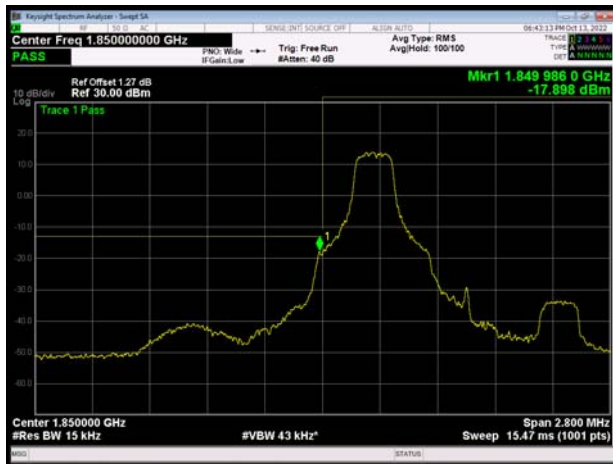

LTE Band 25 1.4MHz QPSK 1RB CH-High

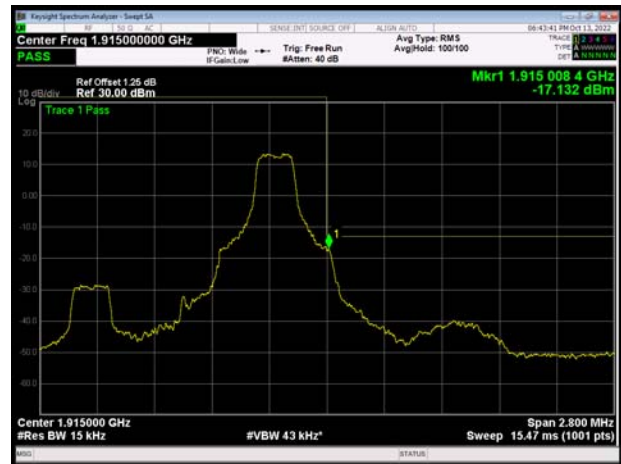

LTE Band 25 1.4MHz QPSK 100%RB CH-Low



LTE Band 25 1.4MHz QPSK 100%RB CH-High



LTE Band 25 1.4MHz 16QAM 1RB CH-Low

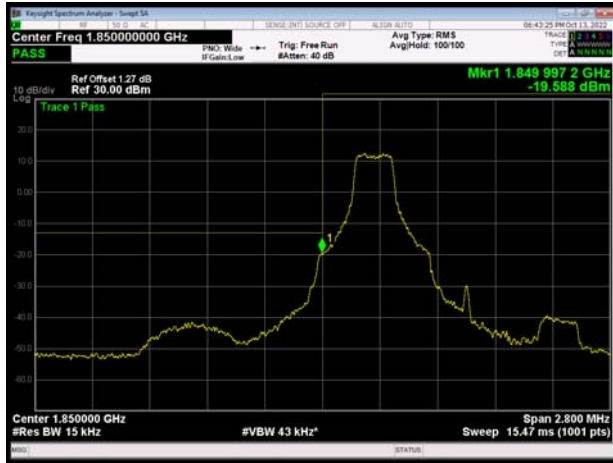

LTE Band 25 1.4MHz 16QAM 1RB CH-High



LTE Band 25 1.4MHz 16QAM 100%RB CH-Low

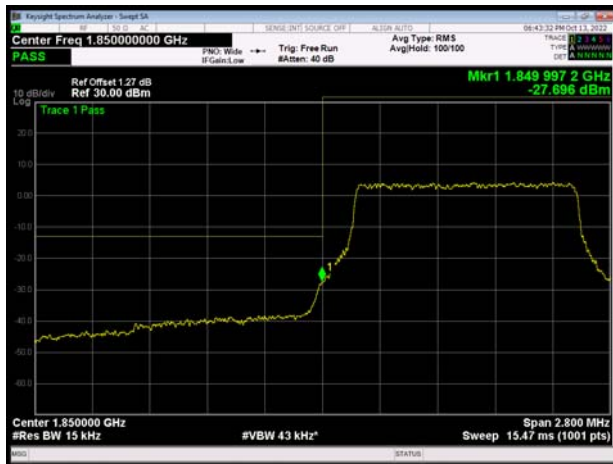

LTE Band 25 1.4MHz 16QAM 100%RB CH-High



6.4. Peak-to-Average Power Ratio (PAPR)

Mode	Channel	Frequency (MHz)	Peak(dBm)	Avg(dBm)	PAPR(dB)	Limit(dB)	Conclusion
WCDMA Band II (RMC)	9262	1852.4	25.96	23.00	2.96	≤13	PASS
	9400	1880	26.05	23.03	3.02	≤13	PASS
	9538	1907.6	26.14	23.20	2.94	≤13	PASS

6.5. Frequency Stability

WCDMA Band II						
Condition		Freq.Error (Hz)	Freq.Error (Hz)	Frequency Stability (ppm)	Frequency Stability (ppm)	Verdict
Temperature	Voltage	QPSK	BPSK	QPSK	BPSK	
Normal (25°C)	Normal	9.52	16.91	0.00506	0.00899	PASS
Extreme (50°C)		16.32	6.84	0.00868	0.00364	PASS
Extreme (40°C)		13.71	6.79	0.00729	0.00361	PASS
Extreme (30°C)		4.19	2.56	0.00223	0.00136	PASS
Extreme (20°C)		8.06	7.66	0.00429	0.00407	PASS
Extreme (10°C)		15.90	17.11	0.00846	0.00910	PASS
Extreme (0°C)		6.52	2.51	0.00347	0.00134	PASS
Extreme (-10°C)		8.93	1.02	0.00475	0.00054	PASS
Extreme (-20°C)		11.95	11.97	0.00635	0.00637	PASS
Extreme (-30°C)		9.64	14.82	0.00513	0.00788	PASS
25°C	LV	15.02	7.94	0.00799	0.00422	PASS
	HV	17.45	9.92	0.00928	0.00527	PASS

6.6. Spurious Emissions at Antenna Terminals

Sweep the whole frequency band through the range from 9kHz to the 10th harmonic of the carrier, the emissions more than 20 dB below the limit are not reported. The signal beyond the limit is carrier.

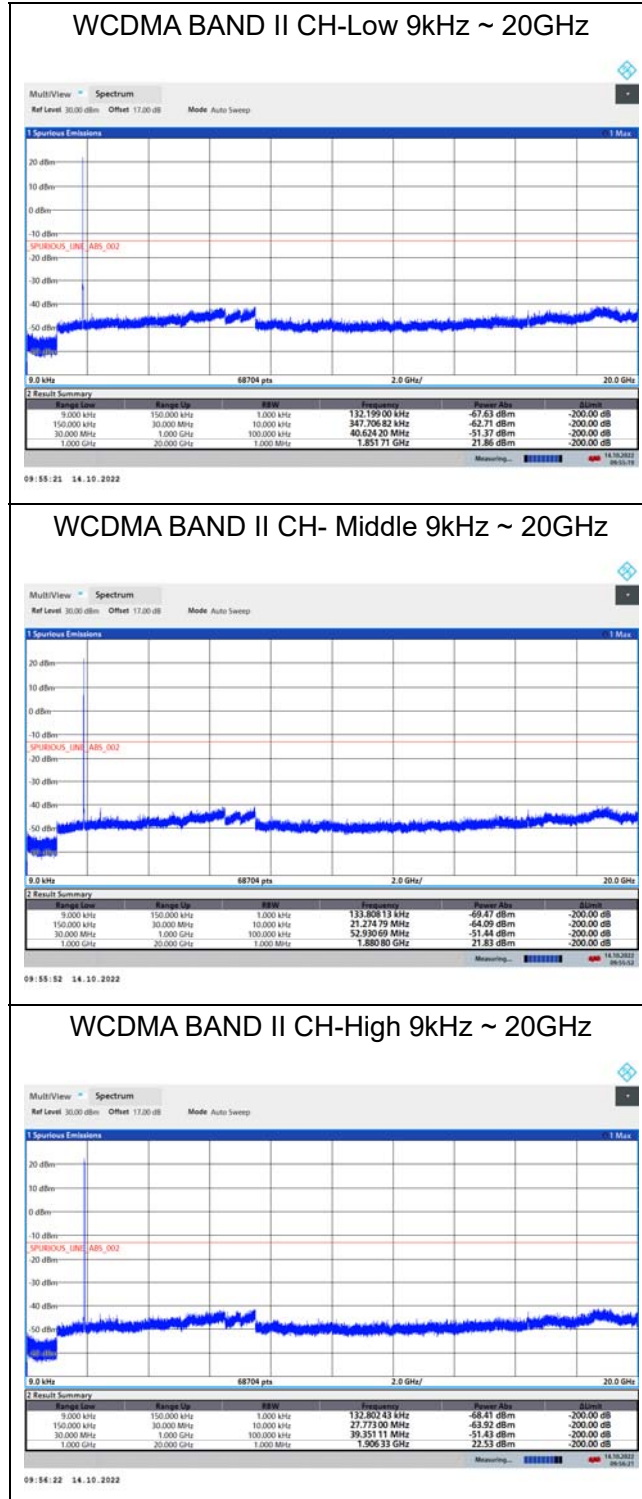

LTE Band 2 5MHz CH-Low 9kHz~20GHz

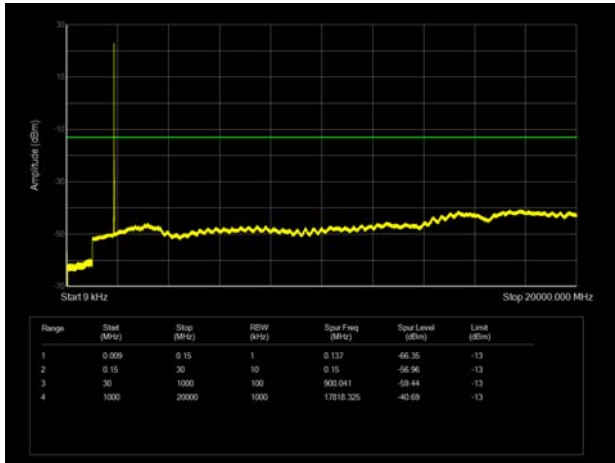

LTE Band 25 1.4MHz CH-Low 9kHz~20GHz

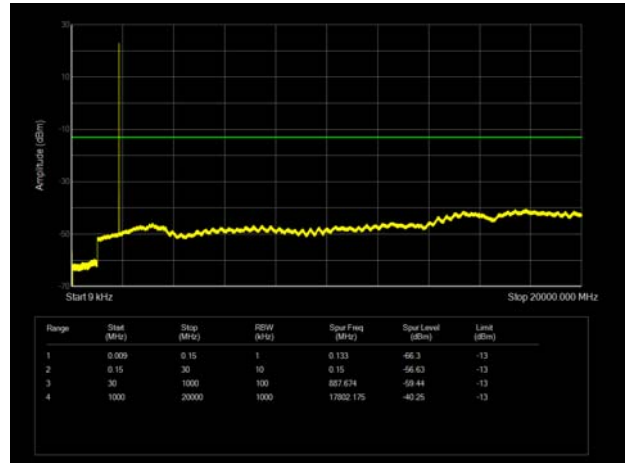

LTE Band 2 5MHz CH-Middle 9kHz~20GHz

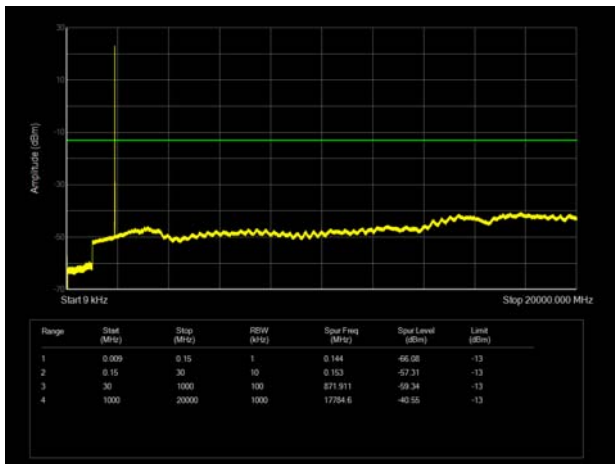

LTE Band 25 1.4MHz CH-Middle 9kHz~20GHz

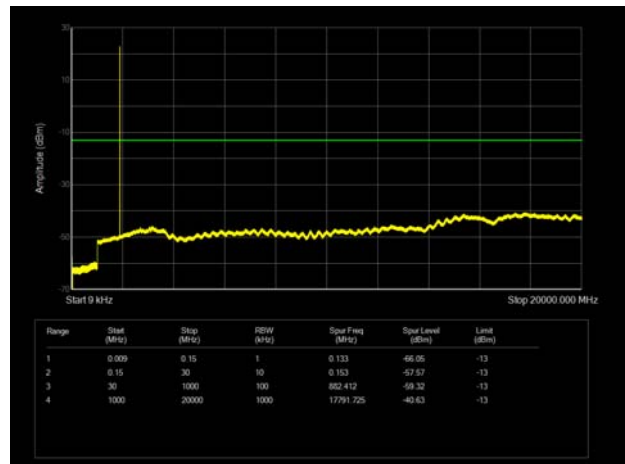

LTE Band 2 5MHz CH-High 9kHz~20GHz

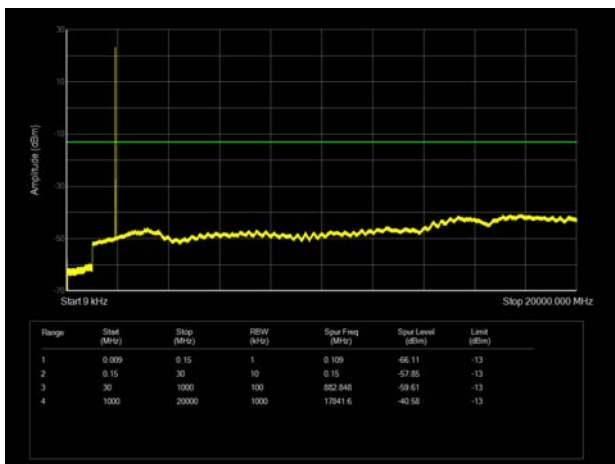

LTE Band 25 1.4MHz CH-High 9kHz~20GHz

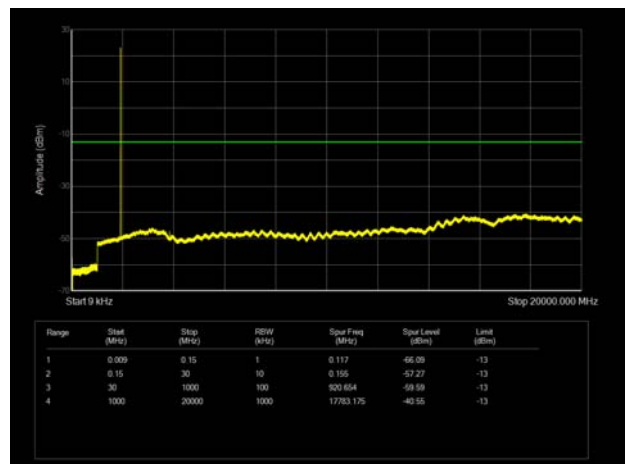

6.7. Radiated Spurious Emission

Sweep the whole frequency band through the range from 9kHz to the 10th harmonic of the carrier, the emissions below the noise floor will not be recorded in the report.

WCDMA Band II CH-Middle

Harmonic	Frequency (MHz)	SG (dBm)	Cable Loss (dB)	Gain (dBi)	Antenna Polarization	EIRP Level (dBm)	Limit (dBm)	Margin (dB)	Azimuth (deg)
2	3760.00	-57.45	2.60	12.50	Horizontal	-47.55	-13.00	34.55	225
3	5640.00	-61.45	3.30	12.50	Horizontal	-52.25	-13.00	39.25	45
4	7520.00	-59.47	4.20	12.20	Horizontal	-51.47	-13.00	38.47	0
5	9400.00	-53.27	4.30	11.10	Horizontal	-46.47	-13.00	33.47	180
6	11280.00	-50.79	5.90	11.90	Horizontal	-44.79	-13.00	31.79	135
7	13160.00	-52.35	5.70	14.00	Horizontal	-44.05	-13.00	31.05	225
8	15040.00	-48.51	5.80	13.10	Horizontal	-41.21	-13.00	28.21	180
9	16920.00	-49.71	6.10	14.60	Horizontal	-41.21	-13.00	28.21	135
10	18800.00	-	6.00	10.10	-	-	-	-	-

Note: 1. The other Spurious RF Radiated emissions level is no more than noise floor.
2. The worst emission was found in the antenna is Horizontal position.

LTE Band 2 5MHz CH-Middle

Harmonic	Frequency (MHz)	SG (dBm)	Cable Loss (dB)	Gain (dBi)	Antenna Polarization	EIRP Level (dBm)	Limit (dBm)	Margin (dB)	Azimuth (deg)
2	3755.63	-54.27	2.60	12.50	Vertical	-44.37	-13.00	31.37	225
3	5633.63	-60.43	3.30	12.50	Vertical	-51.23	-13.00	38.23	45
4	7520.00	-59.31	4.20	12.20	Vertical	-51.31	-13.00	38.31	0
5	9400.00	-51.92	4.30	11.10	Vertical	-45.12	-13.00	32.12	225
6	11280.00	-51.08	5.90	11.90	Vertical	-45.08	-13.00	32.08	0
7	13160.00	-51.72	5.70	14.00	Vertical	-43.42	-13.00	30.42	315
8	15040.00	-46.05	5.80	13.10	Vertical	-38.75	-13.00	25.75	135
9	16920.00	-48.75	6.10	14.60	Vertical	-40.25	-13.00	27.25	0
10	18800.00	--	--	--	--	--	--	--	--

Note: 1. The other Spurious RF Radiated emissions level is no more than noise floor.
2. The worst emission was found in the antenna is Vertical position.

LTE Band 25 1.4MHz CH-Middle

Harmonic	Frequency (MHz)	SG (dBm)	Cable Loss (dB)	Gain (dBi)	Antenna Polarization	EIRP Level (dBm)	Limit (dBm)	Margin (dB)	Azimuth (deg)
2	3765.00	-59.67	2.60	12.50	Vertical	-49.77	-13.00	36.77	45
3	5647.50	-60.77	3.30	12.50	Vertical	-51.57	-13.00	38.57	90
4	7530.00	-58.57	4.20	12.20	Vertical	-50.57	-13.00	37.57	180
5	9412.50	-53.78	4.30	11.10	Vertical	-46.98	-13.00	33.98	45
6	11295.00	-50.70	5.90	11.90	Vertical	-44.70	-13.00	31.70	225
7	13177.50	-52.80	5.70	14.00	Vertical	-44.50	-13.00	31.50	9
8	15060.00	-47.43	5.80	13.10	Vertical	-40.13	-13.00	27.13	0
9	16942.50	-49.75	6.10	14.60	Vertical	-41.25	-13.00	28.25	45
10	18825.00	--	--	--	--	--	--	--	--

Note: 1.The other Spurious RF Radiated emissions level is no more than noise floor.

2. The worst emission was found in the antenna is Vertical position.

7. Main Test Instruments

Name	Manufacturer	Type	Serial Number	Calibration Date	Expiration Date
Base Station Simulator	R&S	CMW500	150415	2022-05-14	2023-05-13
Spectrum Analyzer	Keysight	N9020A	MY50510203	2021-12-12	2022-12-11
Signal Analyzer	R&S	FSV3030	101411	2021-12-12	2022-12-11
Climatic Chamber	ESPEC	SU-242	93000506	2021-12-12	2022-12-11
Universal Radio Communication Tester	Agilent	E5515C	GB44400275	2021-12-12	2022-12-11
Radiated Spurious Emissions					
Signal Analyzer	R&S	FSV30	100815	2021-12-12	2022-12-11
Loop Antenna	SCHWARZBECK	FMZB1519	1519-047	2020-04-02	2023-04-01
TRILOG Broadband Antenna	Schwarzbeck	VULB 9163	01439	2021-06-30	2024-06-29
Horn Antenna	Schwarzbeck	BBHA 9120D	01799	2022-09-01	2025-08-31
Horn Antenna	ETS-Lindgren	3160-09	00102643	2021-10-10	2024-10-09
Software	R&S	EMC32	10.35.10	/	/

*****END OF REPORT *****

ANNEX A: The EUT Appearance

The EUT Appearance is submitted separately.

ANNEX B: Test Setup Photos

The Test Setup Photos is submitted separately.