

FCC Radio Test Report

FCC ID: XMR2019SC650TNA

This report concerns: Original Grant

Project No. : 2001H013
Equipment : Smart Module
Brand Name : QUECTEL
Test Model : SC650T-NA
Series Model : N/A
Applicant : Quectel Wireless Solutions Co., Ltd.
Address : Building 5, Shanghai Business Park Phase III (Area B), No.1016 Tianlin Road, Minhang District, Shanghai, China 200233.
Manufacturer : Quectel Wireless Solutions Co., Ltd.
Address : Building 5, Shanghai Business Park Phase III (Area B), No.1016 Tianlin Road, Minhang District, Shanghai, China 200233.
Date of Receipt : Jan. 15, 2020
Date of Test : Jan. 15, 2020~Feb. 27, 2020
Issued Date : Mar. 16, 2020
Report Version : R00
Test Sample : Engineering Sample No.: SH2020011452
Standard(s) : 47 CFR FCC Part 22 Subpart H
47 CFR FCC Part 2
ANSI/TIA/EIA-603-E-2016
FCC KDB 971168 D01 Power Meas License Digital Systems v03r01

The above equipment has been tested and found compliance with the requirement of the relative standards by BTL Inc.

Iscaa Min

Prepared by : Iscaa Min

Krain Wu

Approved by : Krain Wu



Certificate # 5123.03

Add: No. 29, Jintang Road, Tangzhen Industry Park, Pudong New Area, Shanghai 201210, China

TEL: +86-021-61765666

Web: www.newbtl.com

Declaration

BTL represents to the client that testing is done in accordance with standard procedures as applicable and that test instruments used has been calibrated with standards traceable to international standard(s) and/or national standard(s).

BTL's reports apply only to the specific samples tested under conditions. It is manufacture's responsibility to ensure that additional production units of this model are manufactured with the identical electrical and mechanical components. **BTL** shall have no liability for any declarations, inferences or generalizations drawn by the client or others from **BTL** issued reports.

The report must not be used by the client to claim product certification, approval, or endorsement by NIST, A2LA, or any agency of the U.S. Government.

This report is the confidential property of the client. As a mutual protection to the clients, the public and ourselves, the test report shall not be reproduced, except in full, without our written approval.

BTL's laboratory quality assurance procedures are in compliance with the **ISO/IEC 17025** requirements, and accredited by the conformity assessment authorities listed in this test report.

BTL is not responsible for the sampling stage, so the results only apply to the sample as received.

The information, data and test plan are provided by manufacturer which may affect the validity of results, so it is manufacturer's responsibility to ensure that the apparatus meets the essential requirements of applied standards and in all the possible configurations as representative of its intended use.

Limitation

For the use of the authority's logo is limited unless the Test Standard(s)/Scope(s)/Item(s) mentioned in this test report is (are) included in the conformity assessment authorities acceptance respective.

Please note that the measurement uncertainty is provided for informational purpose only and is not use in determining the Pass/Fail results.

Table of Contents	Page
REPORT ISSUED HISTORY	5
1 . SUMMARY OF TEST RESULTS	6
1.1 TEST FACILITY	7
1.2 MEASUREMENT UNCERTAINTY	7
1.3 TEST ENVIRONMENT CONDITIONS	7
2 . GENERAL INFORMATION	8
2.1 GENERAL DESCRIPTION OF EUT	8
2.2 DESCRIPTION OF TEST MODES AND TEST CONDITION	10
2.3 BLOCK DIGRAM SHOWING THE CONFIGURATIONOFSYSTEMTESTED	13
3.4 DESCRIPTION OF SUPPORT UNITS	13
3 . TEST RESULT	14
3.1 OUTPUT POWER MEASUREMENT	14
3.1.1 LIMIT	14
3.1.2 TEST PROCEDURE	14
3.1.3 TEST SETUP LAYOUT	14
3.1.4 TEST DEVIATION	14
3.1.5 TEST RESULTS	14
3.2 OCCUPIED BANDWIDTH MEASUREMENT	15
3.2.1 TEST PROCEDURE	15
3.2.2 TEST SETUP LAYOUT	15
3.2.3 TEST DEVIATION	15
3.2.4 TEST RESULTS	15
3.3 CONDUCTED EMISSIONS MEASUREMENT	16
3.3.1 LIMIT	16
3.3.2 TEST PROCEDURES	16
3.3.3 TEST SETUP LAYOUT	16
3.3.4 TEST DEVIATION	16
3.3.5 TEST RESULTS	16
3.4 RADIATED EMISSIONS MEASUREMENT	17
3.4.1 LIMIT	17
3.4.2 TEST PROCEDURES	17
3.4.3 TEST SETUP LAYOUT	18
3.4.4 TEST DEVIATION	19
3.4.5 TEST RESULTS (30MHZ TO 1000MHZ)	19
3.4.6 TEST RESULTS (ABOVE 1000MHZ)	19
3.5 BAND EDGE MEASUREMENT	20
3.5.1 LIMIT	20
3.5.2 TEST PROCEDURES	20

Table of Contents	Page
3.5.3 TEST SETUP LAYOUT	20
3.5.4 TEST DEVIATION	20
3.5.5 TEST RESULTS	20
3.6 PEAK TO AVERAGE RATIO MEASUREMENT	21
3.6.1 LIMIT	21
3.6.2 TEST PROCEDURES	21
3.6.3 TEST SETUP LAYOUT	21
3.6.4 TEST DEVIATION	21
3.6.5 TEST RESULTS	21
3.7 FREQUENCY STABILITY MEASUREMENT	22
3.7.1 LIMIT	22
3.7.2 TEST PROCEDURES	22
3.7.3 TEST SETUP LAYOUT	22
3.7.4 TEST DEVIATION	22
3.7.5 TEST RESULTS	22
4. LIST OF MEASUREMENT EQUIPMENTS	23
APPENDIX A - OUTPUT POWER	25
APPENDIX B - OCCUPIED BANDWIDTH	36
APPENDIX C - CONDUCTED EMISSIONS	55
APPENDIX D - RADIATED EMISSION (30MHZ TO 1GHZ)	62
APPENDIX E - RADIATED EMISSION (ABOVE 1GHZ)	67
APPENDIX F - BAND EDGE	80
APPENDIX G - PEAK TO AVERAGE RATIO	90
APPENDIX H - FREQUENCY STABILITY	100

REPORT ISSUED HISTORY

Report Version	Description	Issued Date
R00	Original Issue.	Mar. 16, 2020

1. SUMMARY OF TEST RESULTS

Test procedures according to the technical standard(s):

FCC Part 22 Subpart H & Part 2			
Standard(s) Section	Test Item	Judgment	Remark
2.1046 22.913(a)	Radiated power	PASS	-----
2.1046 22.913(a)	Conducted Output Power	PASS	-----
2.1049(h) 22.917(a)	Occupied Bandwidth	PASS	-----
2.1051 22.917(a)	Conducted Spurious Emissions	PASS	-----
2.1053 22.917(a)	Radiated Spurious Emissions	PASS	-----
22.917(a)	Band Edge Measurements	PASS	-----
-	Peak To Average Ratio	PASS	-----
2.1055 22.355	Frequency Stability	PASS	-----

Note:

For the verdict, the "N/A" denotes "not applicable", the "N/T" denotes "not tested".

1.1 TEST FACILITY

The test facilities used to collect the test data in this report is at the location of No. 29, Jintang Road, Tangzhen Industry Park, Pudong New Area, Shanghai 201210, China.

BTL's Test Firm Registration Number for FCC: 476765

BTL's Designation Number for FCC: CN1241

1.2 MEASUREMENT UNCERTAINTY

ISO/IEC 17025 requires that an estimate of the measurement uncertainties associated with the emissions test results be included in the report. The measurement uncertainties given below are based on a 95% confidence level (based on a coverage factor (k=2)).

The BTL measurement uncertainty as below table:

A. Radiated Measurement :

Test Site	Method	Measurement Frequency Range	Ant. H / V	U,(dB)
SH-CB01	CISPR	9KHz ~ 30MHz	V	3.79
		9KHz ~ 30MHz	H	3.57
		30MHz ~ 200MHz	V	4.12
		30MHz ~ 200MHz	H	3.20
		200MHz ~ 1,000MHz	V	3.12
		200MHz ~ 1,000MHz	H	3.18

Test Site	Method	Measurement Frequency Range	U,(dB)
SH-CB01 (3m)	CISPR	1GHz ~ 6GHz	4.40
		6GHz ~ 18GHz	4.86

Test Site	Method	Measurement Frequency Range	U,(dB)
SH-CB01 (3m)	CISPR	18 ~ 26.5 GHz	3.64
		26.5 ~ 40 GHz	3.78

Note: Unless specifically mentioned, the uncertainty of measurement has not been taken into account to declare the compliance or non-compliance to the specification.

1.3 TEST ENVIRONMENT CONDITIONS

Test Item	Environmental Conditions	Test Voltage
ERP	23°C, 59%RH	DC 3.8V
Conducted Output Power	23°C, 59%RH	DC 3.8V
Occupied Bandwidth	23°C, 59%RH	DC 3.8V
Conducted Emission	23°C, 59%RH	DC 3.8V
Radiated Emission	18°C, 40%RH	DC 3.8V
Band Edge	23°C, 59%RH	DC 3.8V
Peak to Average Ratio	23°C, 59%RH	DC 3.8V
Frequency Stability	Normal and Extreme	Normal and Extreme

2. GENERAL INFORMATION

2.1 GENERAL DESCRIPTION OF EUT

Equipment	Smart Module	
Brand Name	QUECTEL	
Test Model	SC650T-NA	
Series Model	N/A	
Model Difference(s)	N/A	
Software Version	SC650TNAPAR05A03	
Hardware Version	R1.0	
Power Source	DC power supply.	
Power Rating	DC 3.8V	
IMEI No.1	861394040018223	
IMEI No.2	861394040018231	
Antenna Type	Dipole	
Antenna Gain	LTE Band 5	2.53 dBi
	LTE Band 26	3.19 dBi
Modulation Type	LTE	UL: QPSK,16QAM DL: QPSK,16QAM
Operation Frequency	LTE Band 5 (Channel Bandwidth: 1.4MHz)	824.7 MHz ~ 848.3 MHz
	LTE Band 5 (Channel Bandwidth: 3MHz)	825.5 MHz ~ 847.5 MHz
	LTE Band 5 (Channel Bandwidth: 5MHz)	826.5 MHz ~ 846.5 MHz
	LTE Band 5 (Channel Bandwidth: 10MHz)	829.0 MHz ~ 844.0 MHz
	LTE Band 26 (Channel Bandwidth: 1.4MHz)	824.7 MHz ~ 848.3 MHz
	LTE Band 26 (Channel Bandwidth: 3MHz)	825.5 MHz ~ 847.5 MHz
	LTE Band 26 (Channel Bandwidth: 5MHz)	826.5 MHz ~ 846.5 MHz
	LTE Band 26 (Channel Bandwidth: 10MHz)	829 MHz ~ 844 MHz
	LTE Band 26 (Channel Bandwidth: 15MHz)	831.5 MHz ~ 841.5 MHz

Max. ERP Power	LTE Band 5 (Channel Bandwidth: 1.4MHz)	QPSK	23.70	dBm
		16QAM	22.68	dBm
	LTE Band 5 (Channel Bandwidth: 3MHz)	QPSK	23.62	dBm
		16QAM	22.89	dBm
	LTE Band 5 (Channel Bandwidth: 5MHz)	QPSK	23.73	dBm
		16QAM	22.39	dBm
	LTE Band 5 (Channel Bandwidth: 10MHz)	QPSK	23.91	dBm
		16QAM	22.81	dBm
	LTE Band 26 (Channel Bandwidth: 1.4MHz)	QPSK	24.67	dBm
		16QAM	23.78	dBm
	LTE Band 26 (Channel Bandwidth: 3MHz)	QPSK	24.64	dBm
		16QAM	23.53	dBm
	LTE Band 26 (Channel Bandwidth: 5MHz)	QPSK	24.91	dBm
		16QAM	23.34	dBm
	LTE Band 26 (Channel Bandwidth: 10MHz)	QPSK	25.00	dBm
		16QAM	23.75	dBm
	LTE Band 26 (Channel Bandwidth: 15MHz)	QPSK	24.55	dBm
		16QAM	23.46	dBm

Note:

1. For a more detailed features description, please refer to the manufacturer's specifications or the user's manual.

2.2 DESCRIPTION OF TEST MODES AND TEST CONDITION

Pre-Scan has been conducted to determine the worst-case mode from all possible combinations between available modulations, data rates, XYZ axis and antenna ports

The worst case was found when positioned on X-plane for EIRP and X-axis for radiated emission.

Following channel(s) was (were) selected for the final test as listed below:

LTE BAND 5					
Test Item	Available Channel	Tested Channel	Channel Bandwidth	Modulation	Mode
Output Power & ERP	20407 to 20643	20407, 20525, 20643	1.4MHz	QPSK, 16QAM	1RB/3RB/6RB
	20415 to 20635	20415, 20525, 20635	3MHz	QPSK, 16QAM	1RB/8RB/15RB
	20425 to 20625	20425, 20525, 20625	5MHz	QPSK, 16QAM	1RB/12RB/25RB
	20450 to 20600	20450, 20525, 20600	10MHz	QPSK, 16QAM	1RB/25RB/50RB
Occupied Bandwidth	20407 to 20643	20407, 20525, 20643	1.4MHz	QPSK, 16QAM	6 RB
	20415 to 20635	20415, 20525, 20635	3MHz	QPSK, 16QAM	15 RB
	20425 to 20625	20425, 20525, 20625	5MHz	QPSK, 16QAM	25 RB
	20450 to 20600	20450, 20525, 20600	10MHz	QPSK, 16QAM	50 RB
Conducted Emission	20407 to 20643	20525	1.4MHz	QPSK	1 RB
	20425 to 20625	20525	5MHz	QPSK	1 RB
	20450 to 20600	20525	10MHz	QPSK	1 RB
Radiated Emission	20407 to 20643	20525	1.4MHz	QPSK	1 RB
	20425 to 20625	20525	5MHz	QPSK	1 RB
	20450 to 20600	20525	10MHz	QPSK	1 RB
Band Edge	20407 to 20643	20407	1.4MHz	QPSK	1 RB
		20643	1.4MHz	QPSK	6 RB
	20415 to 20635	20415	3MHz	QPSK	1 RB
		20635	3MHz	QPSK	15 RB
	20425 to 20625	20425	5MHz	QPSK	1 RB
		20625	5MHz	QPSK	25 RB
	20450 to 20600	20450	10MHz	QPSK	1 RB
		20600	10MHz	QPSK	50 RB

Peak To Average Ratio	20407 to 20643	20407, 20525, 20643	1.4MHz	QPSK, 16QAM	6 RB
	20415 to 20635	20415, 20525, 20635	3MHz	QPSK, 16QAM	15 RB
	20425 to 20625	20425, 20525, 20625	5MHz	QPSK, 16QAM	25 RB
	20450 to 20600	20450, 20525, 20600	10MHz	QPSK, 16QAM	50 RB
Frequency Stability	20407 to 20643	20525	1.4MHz	QPSK	1 RB
	20415 to 20635	20525	3MHz	QPSK	1 RB
	20425 to 20625	20525	5MHz	QPSK	1 RB
	20450 to 20600	20525	10MHz	QPSK	1 RB

LTE BAND 26					
Test Item	Available Channel	Tested Channel	Channel Bandwidth	Modulation	Mode
Output Power & ERP	26697 to 27033	26697, 26865, 27033	1.4MHz	QPSK, 16QAM	1RB/3RB/6RB
	26705 to 27025	26705, 26865, 27025	3MHz	QPSK, 16QAM	1RB/8RB/15RB
	26715 to 27015	26715, 26865, 27015	5MHz	QPSK, 16QAM	1RB/12RB/25RB
	26740 to 26990	26740, 26865, 26990	10MHz	QPSK, 16QAM	1RB/25RB/50RB
	26765 to 26965	26765, 26865, 26965	15MHz	QPSK, 16QAM	1RB/36RB/75RB
Occupied Bandwidth	26697 to 27033	26697, 26865, 27033	1.4MHz	QPSK, 16QAM	6RB
	26705 to 27025	26705, 26865, 27025	3MHz	QPSK, 16QAM	15 RB
	26715 to 27015	26715, 26865, 27015	5MHz	QPSK, 16QAM	25 RB
	26740 to 26990	26740, 26865, 26990	10MHz	QPSK, 16QAM	50 RB
	26765 to 26965	26765, 26865, 26965	15MHz	QPSK, 16QAM	75 RB
Conducted Emission	26697 to 27033	26865	1.4MHz	QPSK	1 RB
	26705 to 27025	26865	3MHz	QPSK	1 RB
	26715 to 27015	26865	5MHz	QPSK	1 RB
	26740 to 26990	26865	10MHz	QPSK	1 RB
	26765 to 26965	26865	15MHz	QPSK	1 RB
Radiated Emission	26697 to 27033	27033	1.4MHz	QPSK	1 RB
	26765 to 26965	26865	15MHz	QPSK	1 RB

Band Edge	26697 to 27033	26697	1.4MHz	QPSK	1 RB	
		27033	1.4MHz	QPSK	6 RB	
	26705 to 27025	26705	3MHz	QPSK	1 RB	
		27025	3MHz	QPSK	15 RB	
	26715 to 27015	26715	5MHz	QPSK	1 RB	
		27015	5MHz	QPSK	25 RB	
	26740 to 26990	26740	10MHz	QPSK	1 RB	
		26990	10MHz	QPSK	50 RB	
	26765 to 26965	26765	15MHz	QPSK	1 RB	
		26965	15MHz	QPSK	75 RB	
	Peak to Average Ratio	26697 to 27033	26697, 26865, 27033	1.4MHz	QPSK, 16QAM	6 RB
		26705 to 27025	26705, 26865, 27025	3MHz	QPSK, 16QAM	15 RB
26715 to 27015		26715, 26865, 27015	5MHz	QPSK, 16QAM	25 RB	
26740 to 26990		26740, 26865, 26990	10MHz	QPSK, 16QAM	50 RB	
26765 to 26965		26765, 26865, 26965	15MHz	QPSK, 16QAM	75 RB	
Frequency Stability	26797 to 27033	26865	1.4MHz	QPSK	1 RB	
	26805 to 27025	26865	3MHz	QPSK	1 RB	
	26815 to 27015	26865	5MHz	QPSK	1 RB	
	26840 to 26990	26865	10MHz	QPSK	1 RB	
	26915 to 26965	26865	15MHz	QPSK	1 RB	

Note: The low frequency, which started from 9 kHz to 30MHz, was pre-scanned and the result which was 20dB lower than the limit line was not reported.

2.3 BLOCK DIGRAM SHOWING THE CONFIGURATION OF SYSTEM TESTED

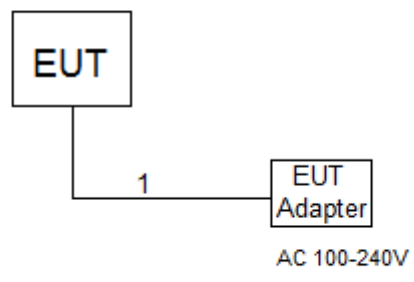

3.4 DESCRIPTION OF SUPPORT UNITS

The EUT has been tested as an independent unit together with other necessary accessories or support units. The following support units or accessories were used to form a representative test configuration during the tests.

Item	Equipment	Mfr/Brand	Model/Type No.	Series No.
1	Adapter	-	YHSW-050100U/T	-

Item	Cable Type	Shielded Type	Ferrite Core	Length
1	DC Cable	N/A	N/A	1m

3. TEST RESULT

3.1 OUTPUT POWER MEASUREMENT

3.1.1 LIMIT

Mobile / Portable station are limited to 7 watts e.r.p.

3.1.2 TEST PROCEDURE

EIRP/ ERP:

1. EIRP= Output Power +Antenan gain
ERP power= EIPR power-2.15dBi.

Output Power:

The EUT was set up for the maximum power with LTE link data modulation and link up with simulator.
Set the EUT to transmit under low, middle and high channel and record the power level shown on simulator.

3.1.3 TEST SETUP LAYOUT

Output Power Measurement

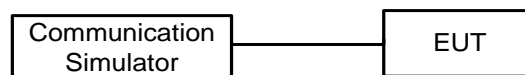

3.1.4 TEST DEVIATION

No deviation

3.1.5 TEST RESULTS

Please refer to the Appendix A.

3.2 OCCUPIED BANDWIDTH MEASUREMENT

3.2.1 TEST PROCEDURE

The EUT makes a call to the communication simulator. All measurements were done at low, middle and high operational frequency range. The communication simulator station system controlled a EUT to export maximum output power under transmission mode and specific channel frequency. Use OBW measurement function of Spectrum analyzer to measure 99 % occupied bandwidth and 26dB bandwidth.

3.2.2 TEST SETUP LAYOUT

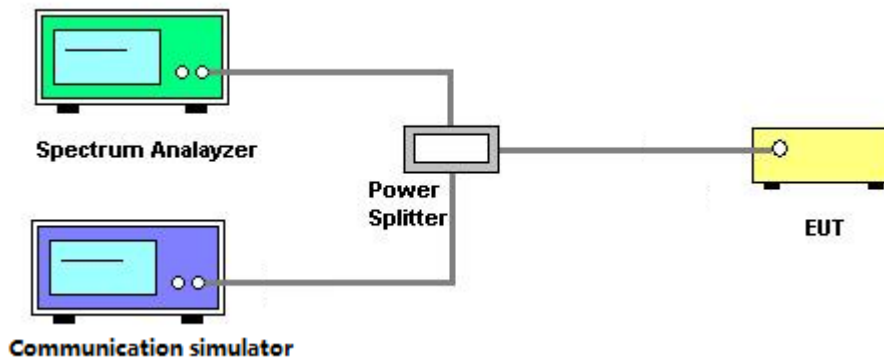

3.2.3 TEST DEVIATION

No deviation

3.2.4 TEST RESULTS

Please refer to the Appendix B.

3.3 CONDUCTED EMISSIONS MEASUREMENT

3.3.1 LIMIT

The power of any emission outside of the authorized operating frequency ranges must be attenuated below the transmitting power (P) by a factor of at least $43 + 10 \log(P)$ dB. The emission limit equal to -13dBm.

3.3.2 TEST PROCEDURES

1. The testing follows FCC KDB 971168 v03r01 Section 6.0.
2. The EUT was connected to spectrum analyzer and system simulator via a power divider.
3. The band edges of low and high channels for the highest RF powers were measured. Set $RBW \geq 1\%$ EBW in the 1MHz band immediately outside and adjacent to the band edge.
4. Set spectrum analyzer with RMS detector.
5. The RF fundamental frequency should be excluded against the limit line in the operating frequency band.
6. The limit line is derived from $43+10\log(P)$ dB below the transmitter power P(Watts)

$$= P(W) - [43 + 10 \log(P)](dB)$$

$$= [30 + 10 \log(P)](dBm) - [43 + 10 \log(P)](dB)$$

$$= -13dBm$$

3.3.3 TEST SETUP LAYOUT

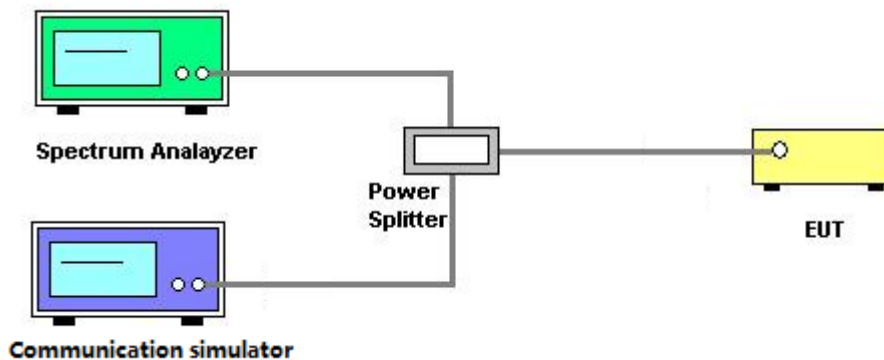

3.3.4 TEST DEVIATION

No deviation

3.3.5 TEST RESULTS

Please refer to the Appendix C.

3.4 RADIATED EMISSIONS MEASUREMENT

3.4.1 LIMIT

The power of any emission outside of the authorized operating frequency ranges must be attenuated below the transmitting power (P) by a factor of at least $43 + 10 \log(P)$ dB. The emission limit equal to -13dBm.

3.4.2 TEST PROCEDURES

1. Substitution method is used for E.I.R.P measurement. In the semi-anechoic chamber, EUT placed on the 0.8m height of Turn Table, rotated the table around 360 degrees to search the maximum radiation power and receiver antenna shall be rotated vertical and horizontal polarization and moved height from 1m to 4m to find the maximum polar radiated power. The "Read Value" is the spectrum reading the maximum power value.
2. The substitution horn antenna is substituted for EUT at the same position and signals generator export the CW signal to the substitution antenna via a TX cable. Rotated the Turn Table and moved receiving antenna to find the maximum radiation power. Adjust output power level of S.G to get a Value of spectrum reading equal to "Read Value " of step a. Record the power level of S.G
3. $EIRP = \text{Output power level of S.G} - \text{TX cable loss} + \text{Antenna gain of substitution horn.}$
4. E.R.P power can be calculated form E.I.R.P power by subtracting the gain of dipole, $E.R.P \text{ power} = E.I.P.R \text{ power} - 2.15\text{dBi.}$
5. The resolution bandwidth and video bandwidth of test receiver/spectrum analyzer is 1MHz/3MHz.

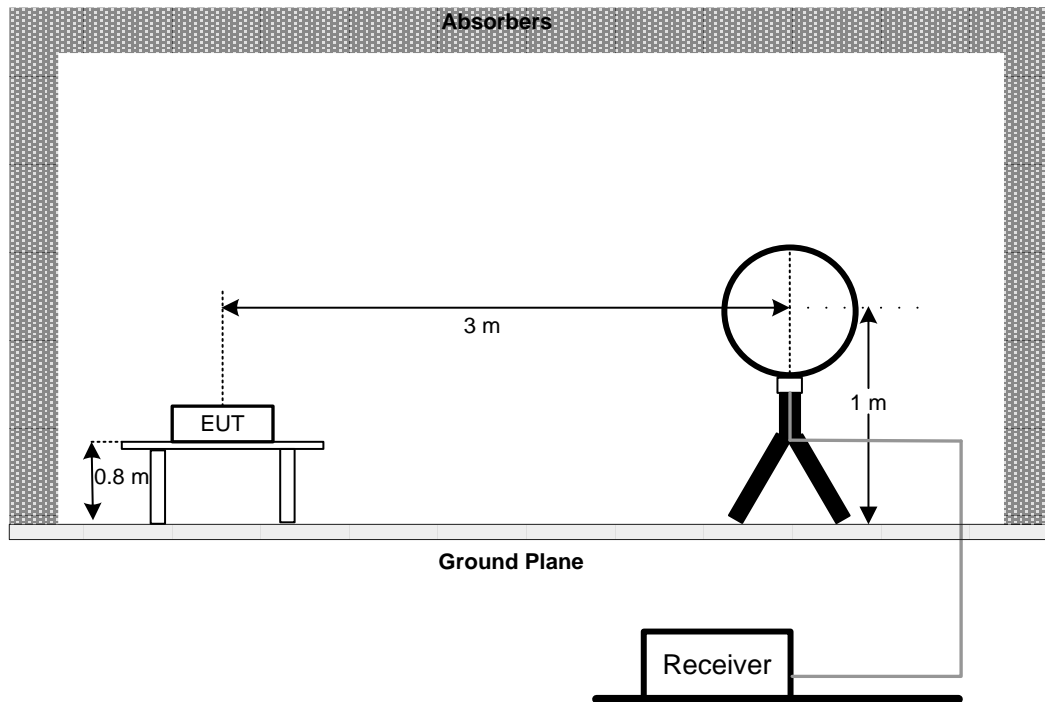
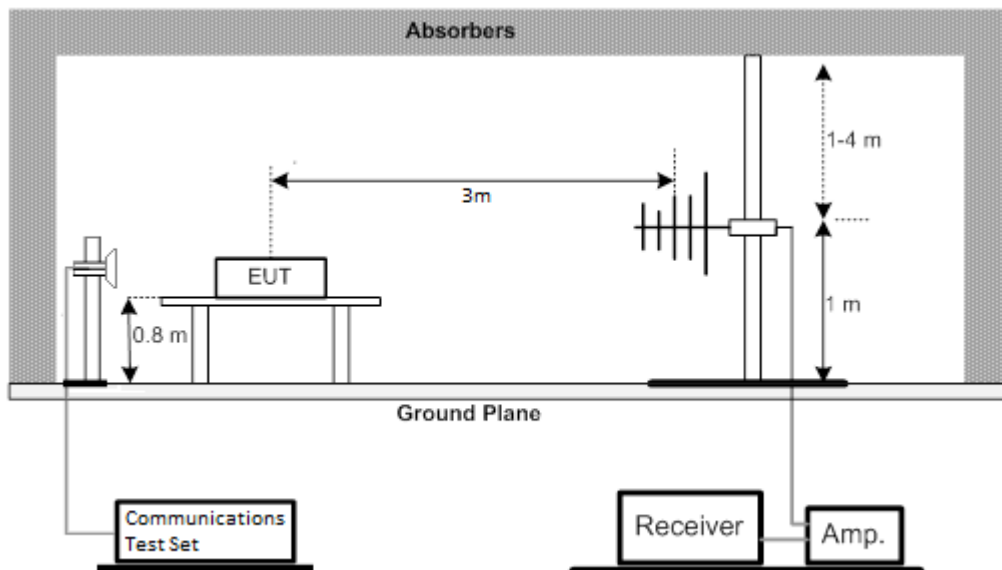
3.4.3 TEST SETUP LAYOUT**Below 30MHz****30MHz to 1GHz**

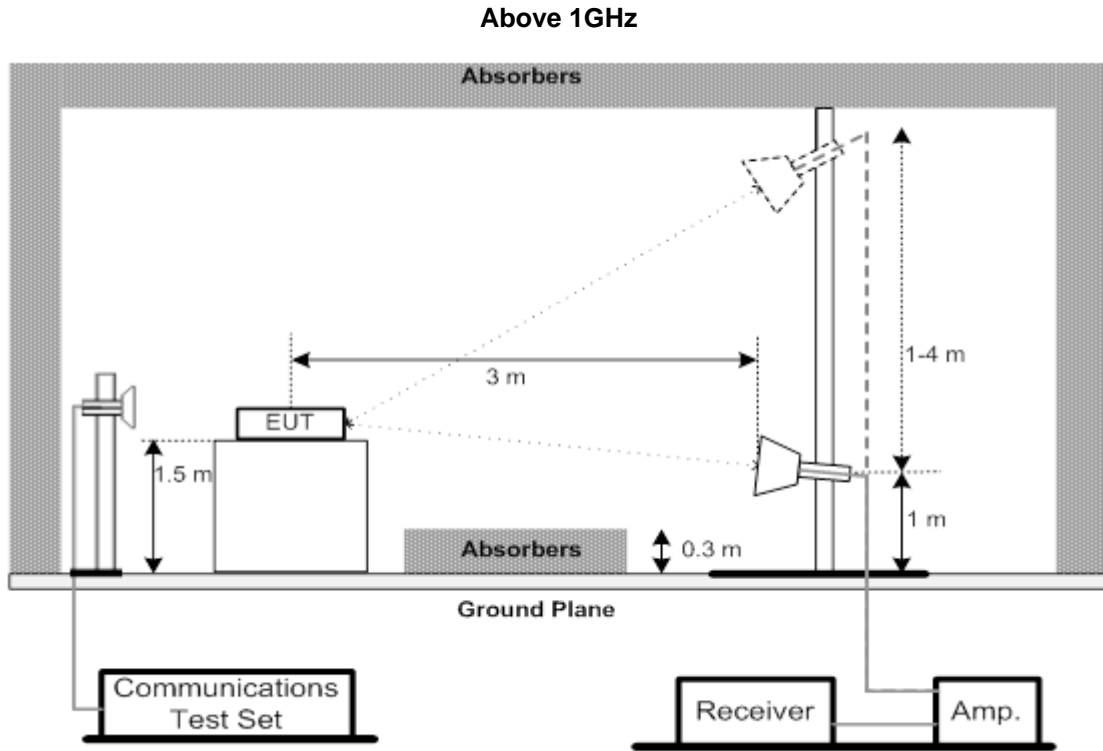

3.4.4 TEST DEVIATION

No deviation

3.4.5 TEST RESULTS (30MHZ TO 1000MHZ)

Please refer to the Appendix D.

3.4.6 TEST RESULTS (ABOVE 1000MHZ)

Please refer to the Appendix E.

3.5 BAND EDGE MEASUREMENT

3.5.1 LIMIT

A Power of any emission outside of the authorized operating frequency ranges must be attenuated below the transmitting power (P) by a factor of at least $43 + 10 \log(P)$ dB. In the 1 MHz bands immediately outside and adjacent to the frequency block a resolution bandwidth of at least one percent of the emission bandwidth of the fundamental emission of the transmitter may be employed.

3.5.2 TEST PROCEDURES

1. All measurements were done at low and high operational frequency range.
2. The center frequency of spectrum is the band edge frequency and span is 2MHz. RB of the spectrum is 15kHz and VB of the spectrum is 43kHz (LTE Bandwidth 1.4MHz).
3. The center frequency of spectrum is the band edge frequency and span is 2MHz. RB of the spectrum is 30kHz and VB of the spectrum is 91kHz (LTE Bandwidth 3MHz).
4. The center frequency of spectrum is the band edge frequency and span is 2MHz. RB of the spectrum is 51kHz and VB of the spectrum is 150kHz (LTE Bandwidth 5MHz).
5. The center frequency of spectrum is the band edge frequency and span is 2MHz. RB of the spectrum is 100kHz and VB of the spectrum is 300kHz (LTE Bandwidth 10MHz).
6. The center frequency of spectrum is the band edge frequency and span is 2MHz. RB of the spectrum is 150kHz and VB of the spectrum is 470kHz (LTE Bandwidth 15MHz).
7. The center frequency of spectrum is the band edge frequency and span is 2MHz. RB of the spectrum is 200kHz and VB of the spectrum is 620kHz (LTE Bandwidth 20MHz).

3.5.3 TEST SETUP LAYOUT

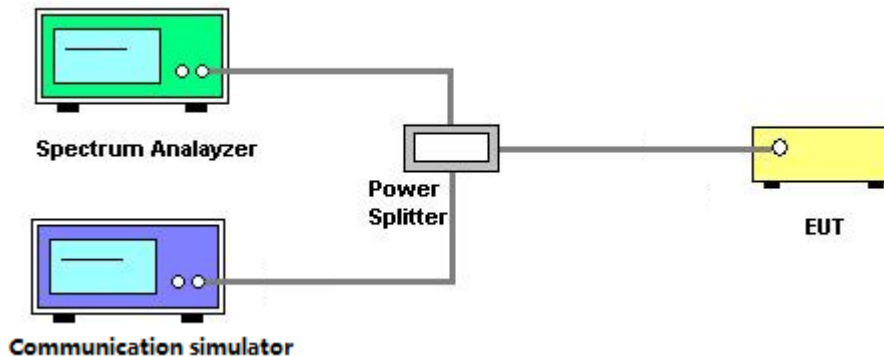

3.5.4 TEST DEVIATION

No deviation

3.5.5 TEST RESULTS

Please refer to the Appendix F.

3.6 PEAK TO AVERAGE RATIO MEASUREMENT

3.6.1 LIMIT

In measuring transmissions in this band using an average power technique, the peak to-average ratio (PAR) of the transmission may not exceed 13 dB.

3.6.2 TEST PROCEDURES

1. Set resolution/measurement bandwidth \geq signal's occupied bandwidth;
2. Set the number of counts to a value that stabilizes the measured CCDF curve;
3. Record the maximum PAPR level associated with a probability of 0.1%.

3.6.3 TEST SETUP LAYOUT

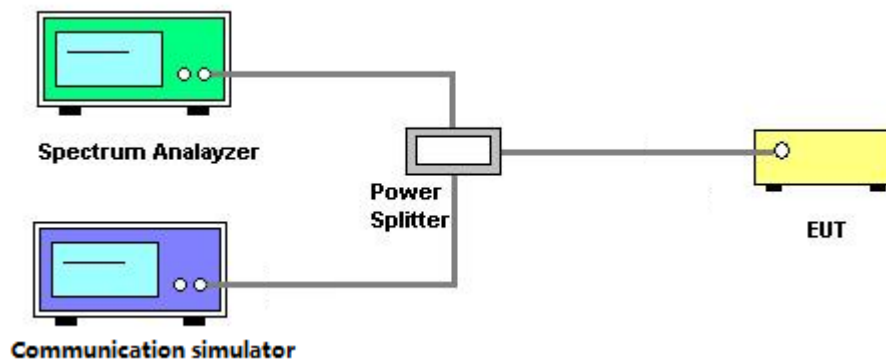

3.6.4 TEST DEVIATION

No deviation

3.6.5 TEST RESULTS

Please refer to the Appendix G.

3.7 FREQUENCY STABILITY MEASUREMENT

3.7.1 LIMIT

±1.5 ppm is for base and fixed station. ±2.5 ppm is for mobile station.

3.7.2 TEST PROCEDURES

1. Device is placed at the oven room. The oven room could control the temperatures and humidity. Power warm up is at least 15 min and power applied should perform before recording frequency error.
2. EUT is connected the external power supply to control the DC input power. The test voltage range is from minimum to maximum working voltage. Each step shall be record the frequency error rate.
3. The temperature range step is 10 degrees in this test items. All temperature levels shall be hold the ±0.5°C during the measurement testing. The each temperature step shall be at least 0.5 hours, consider the EUT could be test under the stability condition.
4. The frequency error was recorded frequency error from the communication simulator.

3.7.3 TEST SETUP LAYOUT

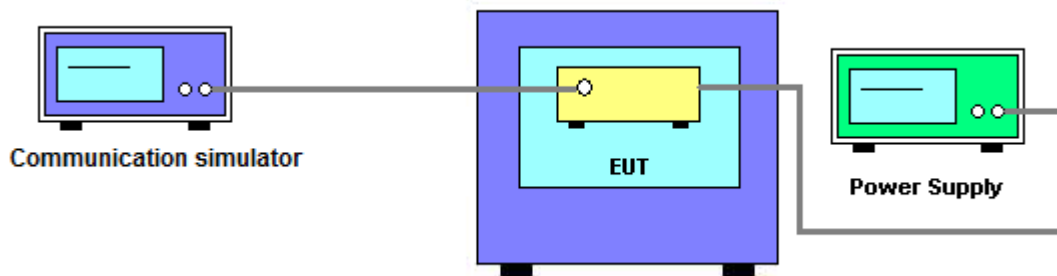

3.7.4 TEST DEVIATION

No deviation

3.7.5 TEST RESULTS

Please refer to the Appendix H.

4. LIST OF MEASUREMENT EQUIPMENTS

Radiated Emission Measurement(9K-30M)					
Item	Kind of Equipment	Manufacturer	Type No.	Serial No.	Calibrated until
1	Loop Antenna	EMCI	EMCI LPA600	275	Mar. 29, 2020
2	EMI Test Receiver	R&S	ESCI	100082	Mar. 29, 2020
3	Measurement Software	Farad	EZ-EMC Ver.NB-03A1-01	N/A	N/A

Radiated Emission Measurement(30M-1G)					
Item	Kind of Equipment	Manufacturer	Type No.	Serial No.	Calibrated until
1	TRILOG Broadband Antenna	Schwarzbeck	VULB 9168	719	Mar. 29, 2020
2	Pre-Amplifier	emci	EMC9135	980400	Mar. 29, 2020
3	MXE EMI Receiver	Keysight	N9038A	MY57150106	Mar. 29, 2020
4	Test Cable	emci	EMC104-SM-SM-7000	170330	Apr. 17, 2020
5	Test Cable	emci	EMC104-SM-SM-1000	170331	Apr. 17, 2020
6	Test Cable	emci	EMC104-SM-NM-3500	170621	Apr. 17, 2020
7	Measurement Software	Farad	EZ-EMC Ver.NB-03A1-01	N/A	N/A
8	Wideband Radio Communication Test	R&S	CMW500	131463	Sep. 01, 2020

Radiated Emission Measurement(1G-18G)					
Item	Kind of Equipment	Manufacturer	Type No.	Serial No.	Calibrated until
1	Pre-Amplifier	emci	EMC184045SE	980409	Mar. 29, 2020
2	Pre-Amplifier	emci	EMC012645SE	980421	Mar. 29, 2020
3	Pre-Amplifier	emci	EMC9135	980400	Mar. 29, 2020
4	Double Ridged Broadband Horn Antenna	Schwarzbeck	BBHA 9120D	9120D-1787	Mar. 29, 2020
5	Double-Ridged Waveguide Horn Antenna	ETS-Lindgren	3116C	00203919	Mar. 29, 2020
6	TRILOG Broadband Antenna	Schwarzbeck	VULB 9168	719	Mar. 29, 2020
7	Cable	N/A	EMC102-SM-SM-6000	170336	Apr. 17, 2020
8	Wideband Radio Communication Test	R&S	CMW500	131463	Sep. 01, 2020

Conducted Emission & Band Edge & Occupied Bandwidth Measurement

	Kind of Equipment	Manufacturer	Type No.	Serial No.	Calibrated until
1	EXA Spectrum Analyzer	Keysight	N9010A	MY56480579	Mar. 29, 2020
2	Power Divider	JUK	PD-4SF-2060	N/A	N/A
3	Wideband Radio Communication Test	R&S	CMW500	131463	Sep. 01, 2020
4	Spectrum Analyzer	R&S	FSP40	100626	Mar. 29, 2020

Frequency Stability Measurement

	Kind of Equipment	Manufacturer	Type No.	Serial No.	Calibrated until
1	EXA Spectrum Analyzer	Keysight	N9010A	MY56480579	Mar. 29, 2020
2*	Power Divider	JUK	PD-4SF-2060	N/A	N/A
3	Wideband Radio Communication Test	R&S	CMW500	131463	Sep. 01, 2020
4	Spectrum Analyzer	R&S	FSP40	100626	Mar. 29, 2020
5	Temperature And Humidity Box	Blue pand	BPHS-120B	170616454	Sep. 01, 2020

Remark: "N/A" denotes no model name, serial no. or calibration specified.

All calibration period of equipment list is one year.

APPENDIX A - OUTPUT POWER

Output Power (dBm):

LTE Band / BW	Modulation	RB Size	RB Offset	Low CH	Mid CH	High CH
				20407CH	20525CH	20643CH
				824.7MHz	836.5MHz	848.3MHz
5 / 1.4M	QPSK	1	0	23.02	23.11	22.87
		1	2	23.32	22.91	22.80
		1	5	23.10	22.97	22.82
		3	0	23.15	22.92	22.98
		3	1	23.04	22.83	22.96
		3	2	23.06	23.12	22.70
	16QAM	6	0	22.03	22.13	22.01
		1	0	21.87	21.94	22.05
		1	2	21.97	21.67	22.30
		1	5	21.83	21.83	21.98
		3	0	22.02	21.91	22.00
		3	1	22.08	22.11	22.12
		3	2	21.86	22.09	22.04
		6	0	21.21	21.26	21.43

LTE Band / BW	Modulation	RB Size	RB Offset	Low CH	Mid CH	High CH
				20415CH	20525CH	20635CH
				825.5MHz	836.5MHz	847.5MHz
5 / 3M	QPSK	1	0	22.89	23.03	22.91
		1	7	23.14	22.82	22.64
		1	14	22.65	22.82	22.94
		8	0	22.99	23.13	23.16
		8	4	23.01	23.24	22.91
		8	7	22.77	23.20	22.89
		15	0	22.15	22.32	22.23
	16QAM	1	0	22.21	22.33	22.18
		1	7	22.15	22.51	21.98
		1	14	22.16	22.03	22.37
		8	0	22.03	22.41	22.35
		8	4	22.39	22.41	21.98
		8	7	22.30	22.09	22.20
		15	0	21.13	21.22	21.34

LTE Band / BW	Modulation	RB Size	RB Offset	Low CH	Mid CH	High CH
				20425CH	20525CH	20625CH
				826.5MHz	836.5MHz	846.5MHz
5 / 5M	QPSK	1	0	22.89	23.08	22.96
		1	13	22.99	22.79	23.18
		1	24	22.69	23.35	22.98
		12	0	22.81	23.22	23.10
		12	6	23.12	22.85	22.92
		12	11	23.19	22.91	22.70
	16QAM	25	0	22.01	22.18	22.11
		1	0	21.57	21.72	21.64
		1	13	21.76	22.01	21.37
		1	24	21.68	21.78	21.82
		12	0	21.65	21.72	21.46
		12	6	21.34	21.93	21.92
		12	11	21.29	21.72	21.40
		25	0	21.12	21.31	21.15

LTE Band / BW	Modulation	RB Size	RB Offset	Low CH	Mid CH	High CH
				20450CH	20525CH	20600CH
				829.0MHz	836.5MHz	844.0MHz
5 / 10M	QPSK	1	0	23.22	23.35	23.41
		1	25	23.11	23.52	23.31
		1	49	23.23	23.37	23.19
		25	0	23.35	23.32	23.49
		25	13	23.47	23.45	23.53
		25	25	23.51	23.14	23.22
		50	0	22.15	22.32	22.26
	16QAM	1	0	22.02	22.20	22.14
		1	25	22.09	22.43	22.43
		1	49	21.75	22.35	22.31
		25	0	22.03	22.03	22.24
		25	13	22.31	22.19	21.95
		25	25	21.74	22.19	22.10
		50	0	21.15	21.28	21.23

LTE Band / BW	Modulation	RB Siset	RB Offset	Low CH	Mid CH	High CH
				26697 CH	26865 CH	27033 CH
				814.7 MHz	831 MHz	848.3 MHz
26 / 1.4M	QPSK	1	0	23.11	23.50	23.35
		1	2	23.37	23.42	23.31
		1	5	23.30	23.39	23.28
		3	0	22.93	23.44	23.35
		3	1	23.04	23.63	23.08
		3	3	22.83	23.57	23.18
	16QAM	6	0	22.36	22.60	22.51
		1	0	22.08	22.44	22.27
		1	2	22.03	22.68	22.45
		1	5	22.06	22.64	22.02
		3	0	22.20	22.74	22.48
		3	1	22.26	22.48	22.04
		3	3	21.98	22.21	22.07
		6	0	21.26	21.52	21.37

LTE Band / BW	Modulation	RB Siset	RB Offset	Low CH	Mid CH	High CH
				26705 CH	26865 CH	27025 CH
				815.5 MHz	831 MHz	847.5 MHz
26 / 3M	QPSK	1	0	23.03	23.33	23.21
		1	7	23.18	23.06	23.24
		1	14	23.10	23.33	23.39
		8	0	22.97	23.14	23.25
		8	3	22.80	23.41	23.45
		8	7	23.18	23.60	23.06
	16QAM	15	0	22.17	22.57	22.43
		1	0	22.09	22.31	22.16
		1	7	22.23	22.05	21.88
		1	14	21.94	22.20	22.27
		8	0	22.12	22.20	21.99
		8	3	22.36	22.16	22.02
		8	7	22.22	22.49	22.25
		15	0	21.49	21.73	21.58

LTE Band / BW	Modulation	RB Siset	RB Offset	Low CH	Mid CH	High CH
				26715 CH	26865 CH	27015 CH
				816.5 MHz	831 MHz	846.5 MHz
26 / 5M	QPSK	1	0	23.21	23.60	23.43
		1	12	23.36	23.85	23.49
		1	24	22.99	23.78	23.35
		12	0	22.95	23.67	23.21
		12	6	23.40	23.87	23.37
		12	13	23.29	23.41	23.56
		25	0	22.31	22.53	22.39
	16QAM	1	0	21.87	22.09	21.97
		1	12	22.04	22.26	21.89
		1	24	22.05	22.01	22.21
		12	0	21.92	21.97	21.82
		12	6	22.10	22.30	22.03
		12	13	21.89	22.11	22.00
		25	0	21.24	21.60	21.43

LTE Band / BW	Modulation	RB Siset	RB Offset	Low CH	Mid CH	High CH
				26740 CH	26865 CH	26990 CH
				819.0 MHz	831 MHz	844.0 MHz
26 / 10M	QPSK	1	0	23.31	23.67	23.49
		1	24	23.34	23.54	23.47
		1	49	23.46	23.96	23.64
		25	0	23.42	23.56	23.61
		25	12	23.59	23.96	23.41
		25	25	23.61	23.87	23.34
		50	0	22.11	22.53	22.38
	16QAM	1	0	22.21	22.42	22.34
		1	24	22.03	22.71	22.15
		1	49	21.97	22.22	22.12
		25	0	22.24	22.68	22.04
		25	12	21.96	22.46	22.07
		25	25	22.23	22.38	22.18
		50	0	21.37	21.61	21.54

LTE Band / BW	Modulation	RB Siset	RB Offset	Low CH	Mid CH	High CH
				26765 CH	26865 CH	26965 CH
				821.5 MHz	831 MHz	841.5 MHz
26 / 15M	QPSK	1	0	23.03	23.25	23.16
		1	37	23.08	23.36	23.23
		1	74	23.27	23.06	23.16
		36	0	23.22	23.02	22.93
		36	19	23.10	23.51	23.22
		36	39	23.05	23.14	23.00
		75	0	22.17	22.46	22.33
	16QAM	1	0	22.14	22.38	22.25
		1	37	21.87	22.11	22.15
		1	74	22.40	22.42	22.41
		36	0	22.05	22.28	22.32
		36	19	22.16	22.38	22.05
		36	39	22.22	22.41	22.40
		75	0	21.18	21.54	21.36

ERP Power (dBm):

LTE Band / BW	Modulation	RB Size	RB Offset	Low CH	Mid CH	High CH
				20407CH	20525CH	20643CH
				824.7MHz	836.5MHz	848.3MHz
5 / 1.4M	QPSK	1	0	23.40	23.49	23.25
		1	2	23.70	23.29	23.18
		1	5	23.48	23.35	23.20
		3	0	23.53	23.30	23.36
		3	1	23.42	23.21	23.34
		3	2	23.44	23.50	23.08
	16QAM	6	0	22.41	22.51	22.39
		1	0	22.25	22.32	22.43
		1	2	22.35	22.05	22.68
		1	5	22.21	22.21	22.36
		3	0	22.40	22.29	22.38
		3	1	22.46	22.49	22.50
		3	2	22.24	22.47	22.42
		6	0	21.59	21.64	21.81

LTE Band / BW	Modulation	RB Size	RB Offset	Low CH	Mid CH	High CH
				20415CH	20525CH	20635CH
				825.5MHz	836.5MHz	847.5MHz
5 / 3M	QPSK	1	0	23.27	23.41	23.29
		1	7	23.52	23.20	23.02
		1	14	23.03	23.20	23.32
		8	0	23.37	23.51	23.54
		8	4	23.39	23.62	23.29
		8	7	23.15	23.58	23.27
		15	0	22.53	22.70	22.61
	16QAM	1	0	22.59	22.71	22.56
		1	7	22.53	22.89	22.36
		1	14	22.54	22.41	22.75
		8	0	22.41	22.79	22.73
		8	4	22.77	22.79	22.36
		8	7	22.68	22.47	22.58
		15	0	21.51	21.60	21.72

LTE Band / BW	Modulation	RB Size	RB Offset	Low CH	Mid CH	High CH
				20425CH	20525CH	20625CH
				826.5MHz	836.5MHz	846.5MHz
5 / 5M	QPSK	1	0	23.27	23.46	23.34
		1	13	23.37	23.17	23.56
		1	24	23.07	23.73	23.36
		12	0	23.19	23.60	23.48
		12	6	23.50	23.23	23.30
		12	11	23.57	23.29	23.08
	16QAM	25	0	22.39	22.56	22.49
		1	0	21.95	22.10	22.02
		1	13	22.14	22.39	21.75
		1	24	22.06	22.16	22.20
		12	0	22.03	22.10	21.84
		12	6	21.72	22.31	22.30
		12	11	21.67	22.10	21.78
		25	0	21.50	21.69	21.53

LTE Band / BW	Modulation	RB Size	RB Offset	Low CH	Mid CH	High CH
				20450CH	20525CH	20600CH
				829.0MHz	836.5MHz	844.0MHz
5 / 10M	QPSK	1	0	23.60	23.73	23.79
		1	25	23.49	23.90	23.69
		1	49	23.61	23.75	23.57
		25	0	23.73	23.70	23.87
		25	13	23.85	23.83	23.91
		25	25	23.89	23.52	23.60
	16QAM	50	0	22.53	22.70	22.64
		1	0	22.40	22.58	22.52
		1	25	22.47	22.81	22.81
		1	49	22.13	22.73	22.69
		25	0	22.41	22.41	22.62
		25	13	22.69	22.57	22.33
		25	25	22.12	22.57	22.48
		50	0	21.53	21.66	21.61

LTE Band / BW	Modulation	RB Sizing	RB Offset	Low CH	Mid CH	High CH
				26697 CH	26865 CH	27033 CH
				814.7 MHz	831 MHz	848.3 MHz
26 / 1.4M	QPSK	1	0	24.15	24.54	24.39
		1	2	24.41	24.46	24.35
		1	5	24.34	24.43	24.32
		3	0	23.97	24.48	24.39
		3	1	24.08	24.67	24.12
		3	3	23.87	24.61	24.22
	16QAM	6	0	23.40	23.64	23.55
		1	0	23.12	23.48	23.31
		1	2	23.07	23.72	23.49
		1	5	23.10	23.68	23.06
		3	0	23.24	23.78	23.52
		3	1	23.30	23.52	23.08
		3	3	23.02	23.25	23.11
		6	0	22.30	22.56	22.41

LTE Band / BW	Modulation	RB Sizing	RB Offset	Low CH	Mid CH	High CH
				26705 CH	26865 CH	27025 CH
				815.5 MHz	831 MHz	847.5 MHz
26 / 3M	QPSK	1	0	24.07	24.37	24.25
		1	7	24.22	24.10	24.28
		1	14	24.14	24.37	24.43
		8	0	24.01	24.18	24.29
		8	3	23.84	24.45	24.49
		8	7	24.22	24.64	24.10
		15	0	23.21	23.61	23.47
	16QAM	1	0	23.13	23.35	23.20
		1	7	23.27	23.09	22.92
		1	14	22.98	23.24	23.31
		8	0	23.16	23.24	23.03
		8	3	23.40	23.20	23.06
		8	7	23.26	23.53	23.29
		15	0	22.53	22.77	22.62

LTE Band / BW	Modulation	RB Siset	RB Offset	Low CH	Mid CH	High CH
				26715 CH	26865 CH	27015 CH
				816.5 MHz	831MHz	846.5 MHz
26 / 5M	QPSK	1	0	24.25	24.64	24.47
		1	12	24.40	24.89	24.53
		1	24	24.03	24.82	24.39
		12	0	23.99	24.71	24.25
		12	6	24.44	24.91	24.41
		12	13	24.33	24.45	24.60
		25	0	23.35	23.57	23.43
	16QAM	1	0	22.91	23.13	23.01
		1	12	23.08	23.30	22.93
		1	24	23.09	23.05	23.25
		12	0	22.96	23.01	22.86
		12	6	23.14	23.34	23.07
		12	13	22.93	23.15	23.04
		25	0	22.28	22.64	22.47

LTE Band / BW	Modulation	RB Siset	RB Offset	Low CH	Mid CH	High CH
				26740 CH	26865 CH	26990 CH
				819.0 MHz	831 MHz	844.0 MHz
26 / 10M	QPSK	1	0	24.35	24.71	24.53
		1	24	24.38	24.58	24.51
		1	49	24.50	25.00	24.68
		25	0	24.46	24.60	24.65
		25	12	24.63	25.00	24.45
		25	25	24.65	24.91	24.38
		50	0	23.15	23.57	23.42
	16QAM	1	0	23.25	23.46	23.38
		1	24	23.07	23.75	23.19
		1	49	23.01	23.26	23.16
		25	0	23.28	23.72	23.08
		25	12	23.00	23.50	23.11
		25	25	23.27	23.42	23.22
		50	0	22.41	22.65	22.58

LTE Band / BW	Modulation	RB Siset	RB Offset	Low CH	Mid CH	High CH
				26765 CH	26865 CH	26965 CH
				821.5 MHz	831 MHz	841.5 MHz
26 / 15M	QPSK	1	0	24.09	24.29	24.20
		1	37	24.12	24.40	24.27
		1	74	24.31	24.10	24.20
		36	0	24.26	24.06	23.97
		36	19	24.14	24.55	24.26
		36	39	24.09	24.18	24.04
		75	0	23.21	23.50	23.37
	16QAM	1	0	23.18	23.42	23.29
		1	37	22.91	23.15	23.19
		1	74	23.44	23.46	23.45
		36	0	23.09	23.32	23.36
		36	19	23.20	23.42	23.09
		36	39	23.26	23.45	23.44
		75	0	22.22	22.58	22.40

APPENDIX B - OCCUPIED BANDWIDTH

LTE Band 5_1.4M					
QPSK			16QAM		
Channel	Frequency (MHz)	99% Occupied Bandwidth (MHz)	Channel	Frequency (MHz)	99% Occupied Bandwidth (MHz)
20407	824.7	1.0877	20407	824.7	1.0916
20525	836.5	1.0910	20525	836.5	1.0938
20643	848.3	1.1019	20643	848.3	1.0861
Channel	Frequency (MHz)	26dB Bandwidth (MHz)	Channel	Frequency (MHz)	26dB Bandwidth (MHz)
20407	824.7	1.2750	20407	824.7	1.2970
20525	836.5	1.3140	20525	836.5	1.2890
20643	848.3	1.3140	20643	848.3	1.2830

Spectrum Plot

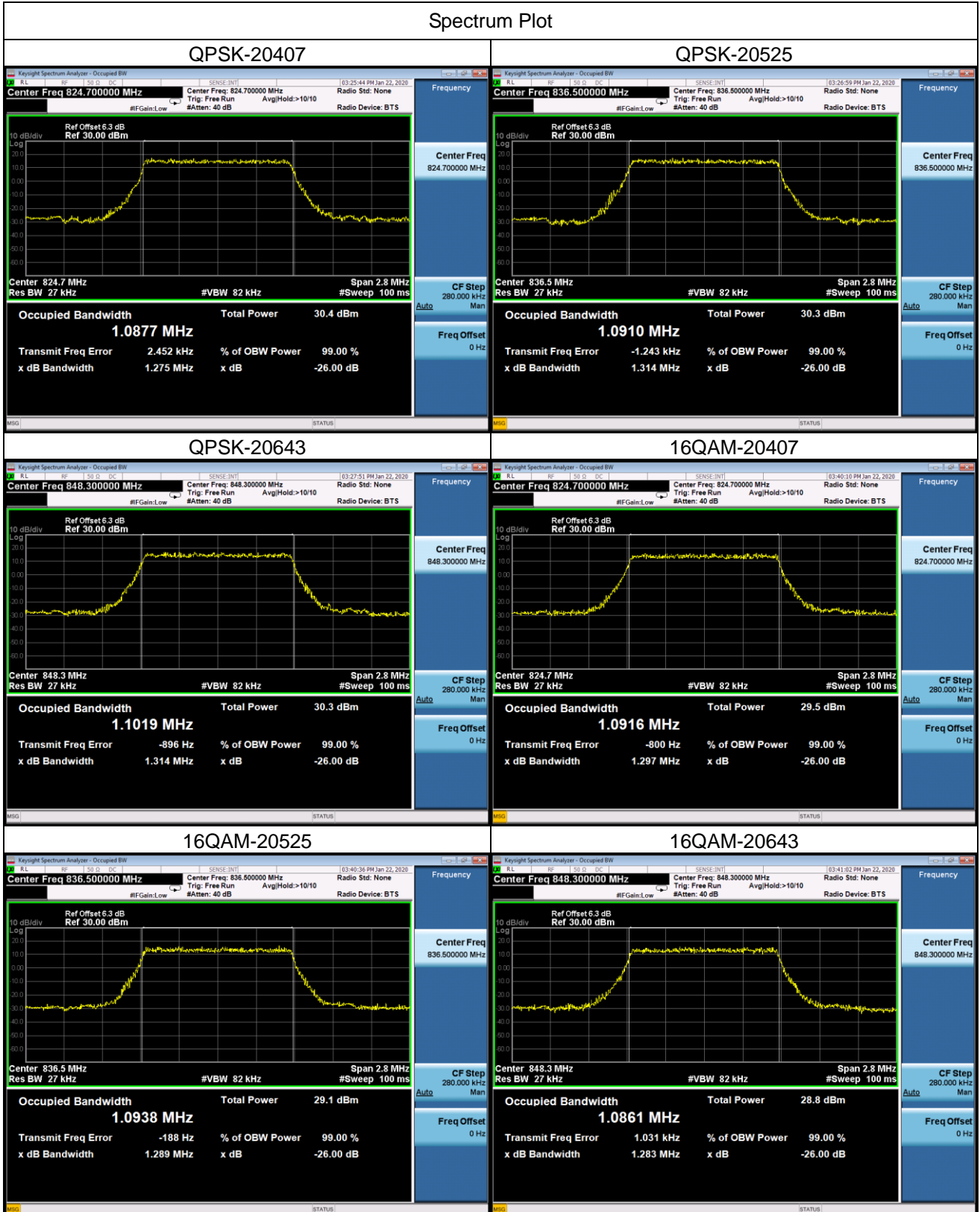

LTE Band 5_3M					
QPSK			16QAM		
Channel	Frequency (MHz)	99% Occupied Bandwidth (MHz)	Channel	Frequency (MHz)	99% Occupied Bandwidth (MHz)
20415	825.5	2.6979	20415	825.5	2.6993
20525	836.5	2.6986	20525	836.5	2.6964
20635	847.5	2.6940	20635	847.5	2.6971
Channel	Frequency (MHz)	26dB Bandwidth (MHz)	Channel	Frequency (MHz)	26dB Bandwidth (MHz)
20415	825.5	3.0080	20415	825.5	2.9480
20525	836.5	2.9700	20525	836.5	2.9930
20635	847.5	2.9670	20635	847.5	2.9860

Spectrum Plot

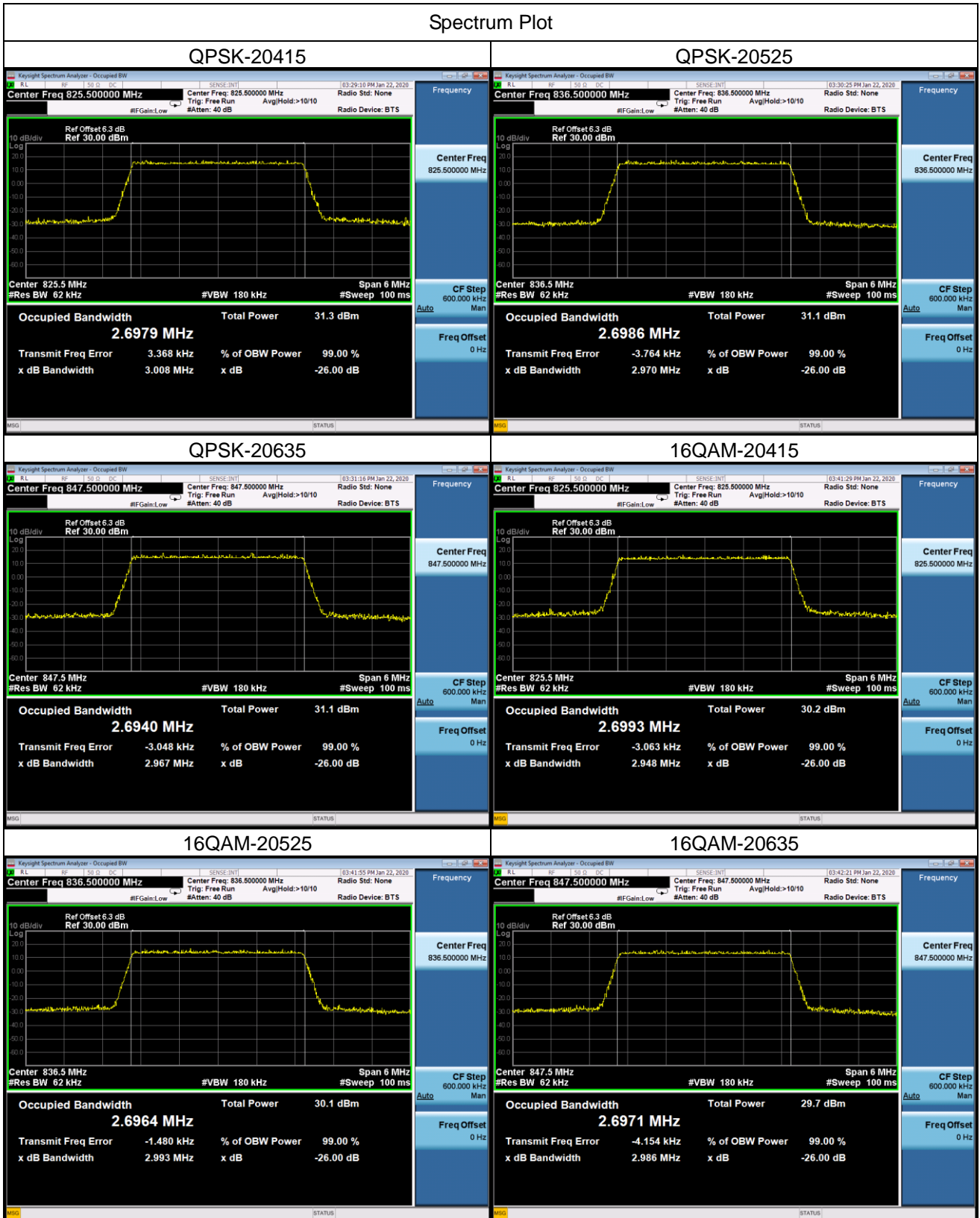

LTE Band 5_5M					
QPSK			16QAM		
Channel	Frequency (MHz)	99% Occupied Bandwidth (MHz)	Channel	Frequency (MHz)	99% Occupied Bandwidth (MHz)
20425	826.5	4.5211	20425	826.5	4.5024
20525	836.5	4.4994	20525	836.5	4.4943
20625	846.5	4.5008	20625	846.5	4.4948
Channel	Frequency (MHz)	26dB Bandwidth (MHz)	Channel	Frequency (MHz)	26dB Bandwidth (MHz)
20425	826.5	4.9380	20425	826.5	5.0170
20525	836.5	4.9710	20525	836.5	4.9720
20625	846.5	4.9810	20625	846.5	4.9560

Spectrum Plot

QPSK-20425

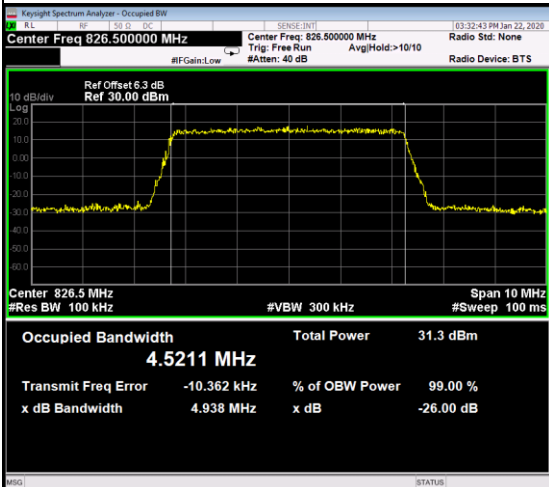

QPSK-20525

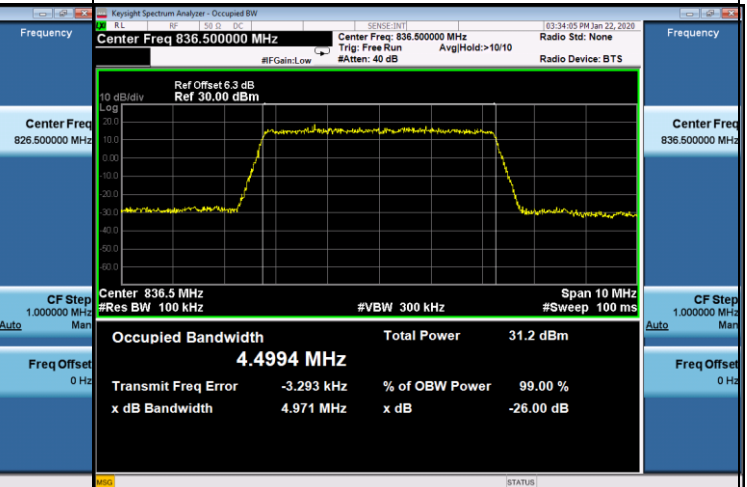

QPSK-20625

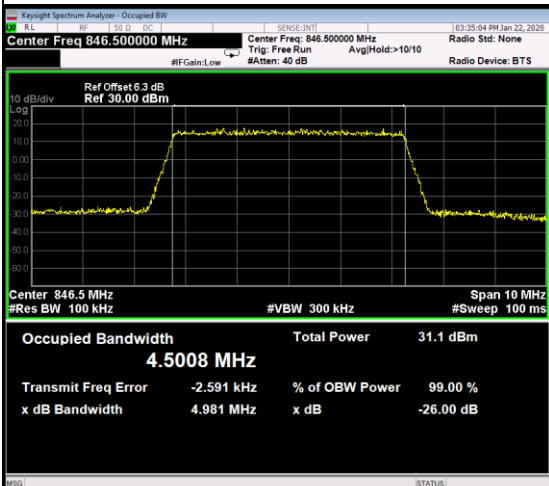

16QAM-20425

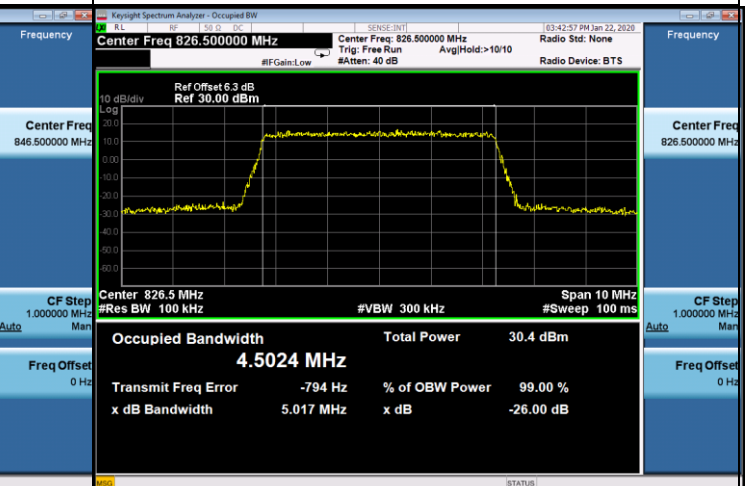

16QAM-20525

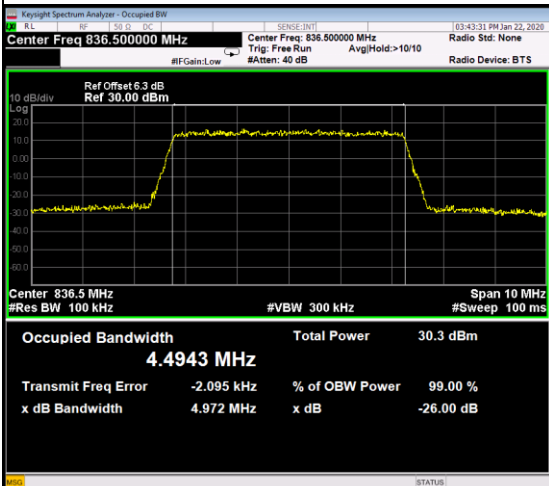

16QAM-20625

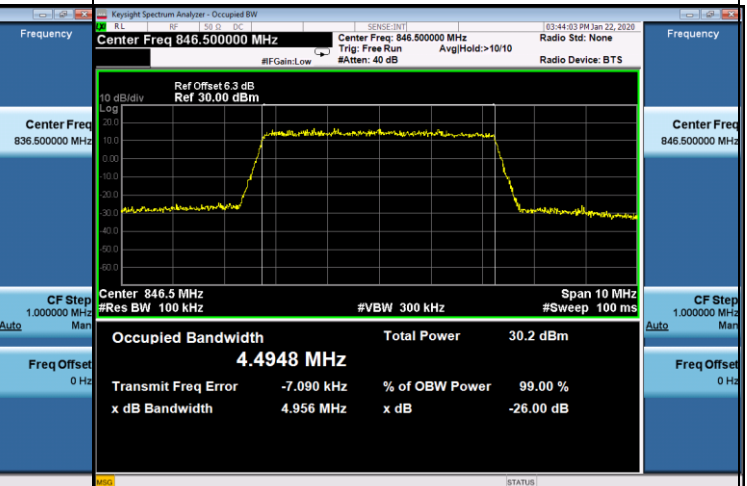

LTE Band 5_10M					
QPSK			16QAM		
Channel	Frequency (MHz)	99% Occupied Bandwidth (MHz)	Channel	Frequency (MHz)	99% Occupied Bandwidth (MHz)
20450	829.0	8.9656	20450	829.0	8.9483
20525	836.5	8.9498	20525	836.5	8.9633
20600	844.0	8.9744	20600	844.0	8.9743
Channel	Frequency (MHz)	26dB Bandwidth (MHz)	Channel	Frequency (MHz)	26dB Bandwidth (MHz)
20450	829.0	9.9000	20450	829.0	9.8510
20525	836.5	9.9230	20525	836.5	9.8860
20600	844.0	9.7840	20600	844.0	9.7740

Spectrum Plot

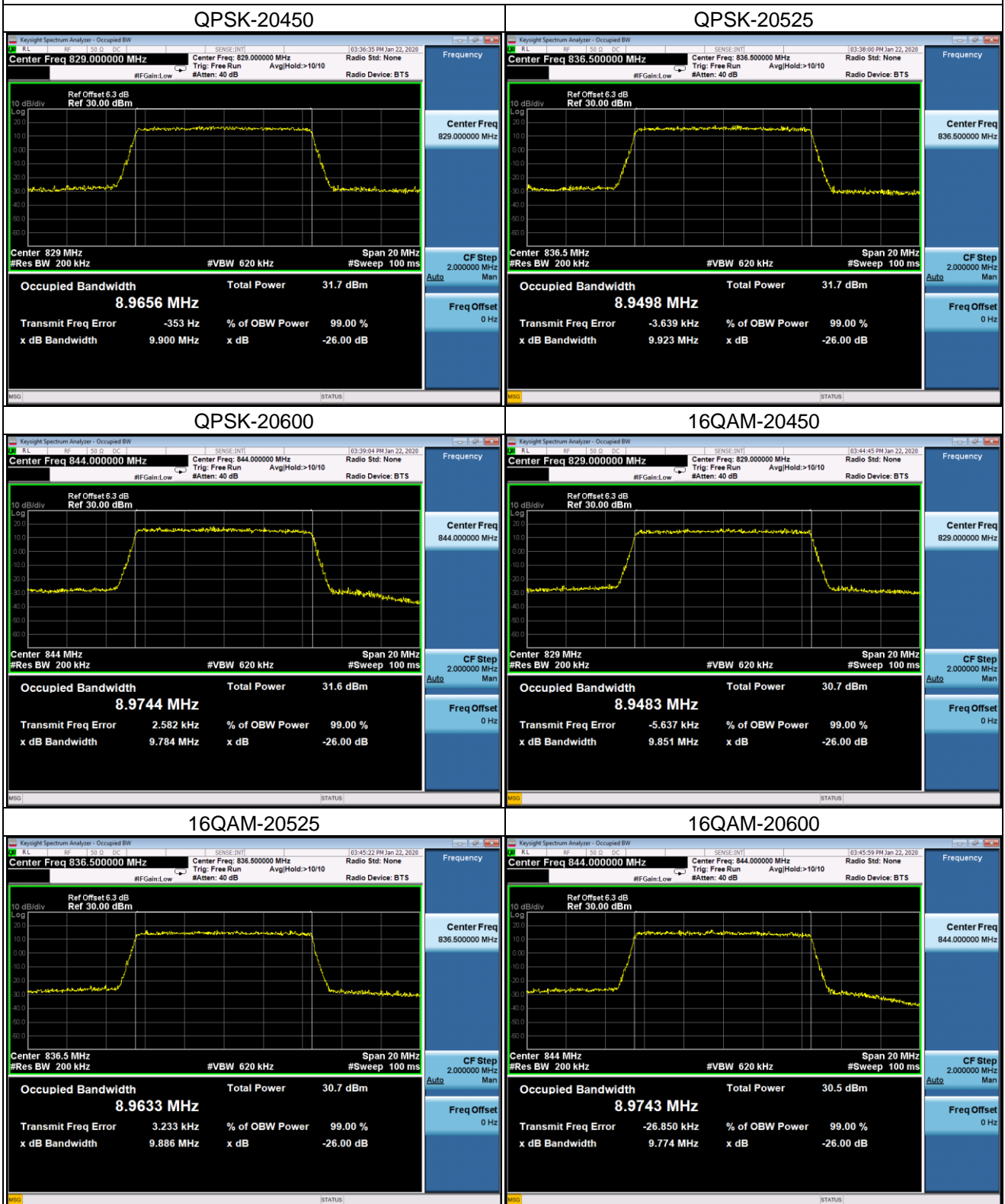

LTE Band 26_1.4M					
QPSK			16QAM		
Channel	Frequency (MHz)	99% Occupied Bandwidth (MHz)	Channel	Frequency (MHz)	99% Occupied Bandwidth (MHz)
26697	814.7	1.0873	26697	814.7	1.0820
26865	831	1.0828	26865	831	1.0809
27033	848.3	1.1022	27033	848.3	1.0813
Channel	Frequency (MHz)	26dB Bandwidth (MHz)	Channel	Frequency (MHz)	26dB Bandwidth (MHz)
26697	814.7	1.2840	26697	814.7	1.2340
26865	831	1.2400	26865	831	1.2410
27033	848.3	1.3120	27033	848.3	1.2560

Spectrum Plot

QPSK-26697

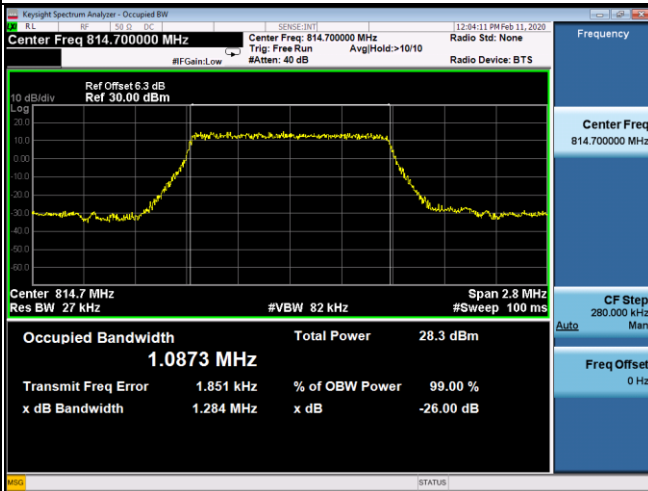

QPSK-26865

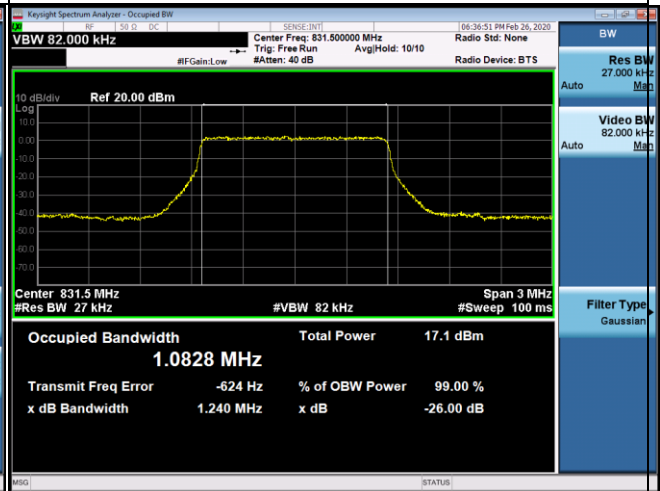

QPSK-27033

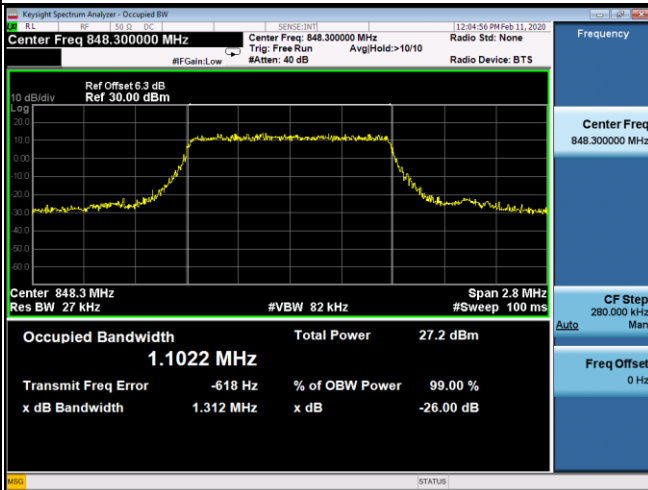

16QAM-26697

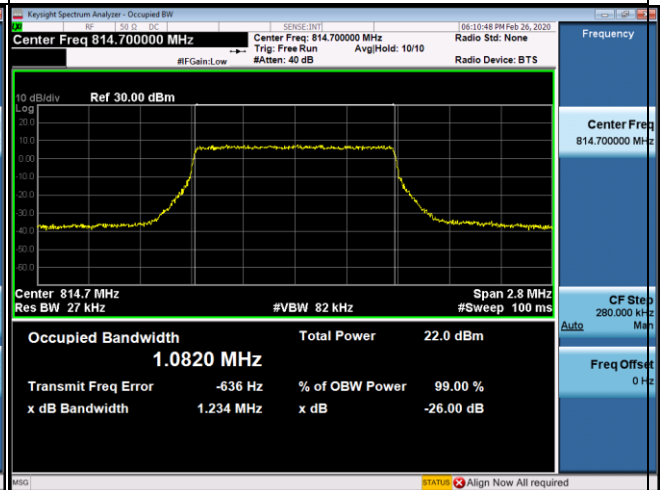

16QAM-26865

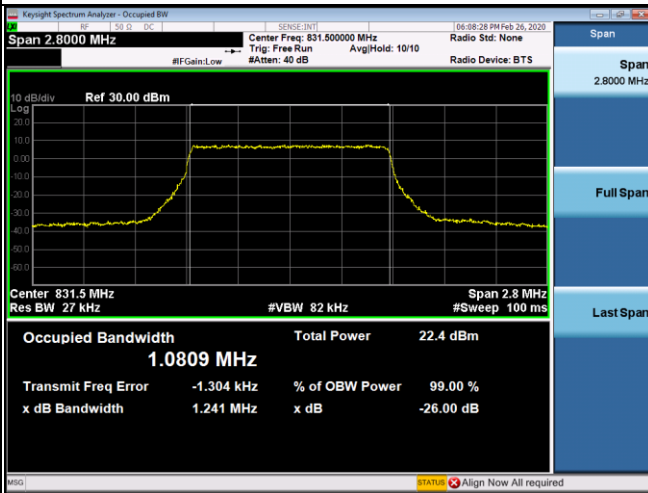

16QAM-27033

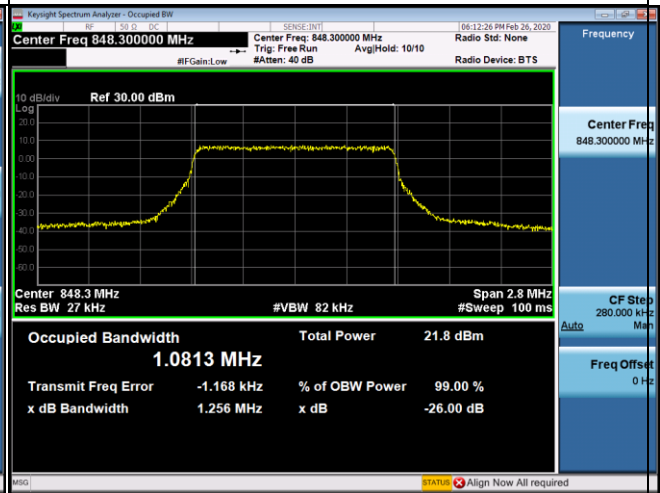

LTE Band 26_3M					
QPSK			16QAM		
Channel	Frequency (MHz)	99% Occupied Bandwidth (MHz)	Channel	Frequency (MHz)	99% Occupied Bandwidth (MHz)
26705	815.5	2.6957	26705	815.5	2.6907
26865	831	2.6885	26865	831	2.6879
27025	847.5	2.7004	27025	847.5	2.6896
Channel	Frequency (MHz)	26dB Bandwidth (MHz)	Channel	Frequency (MHz)	26dB Bandwidth (MHz)
26705	815.5	2.9950	26705	815.5	2.9030
26865	831	2.9120	26865	831	2.8830
27025	847.5	2.9820	27025	847.5	2.9040

Spectrum Plot

QPSK-26705

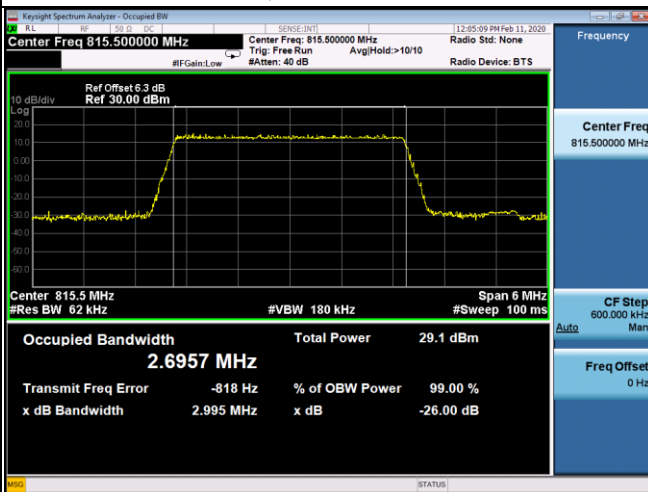

QPSK-26865



QPSK-27025

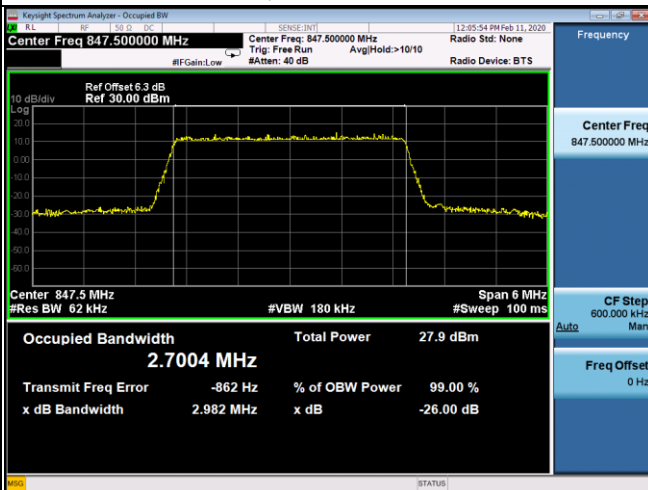

16QAM-26705

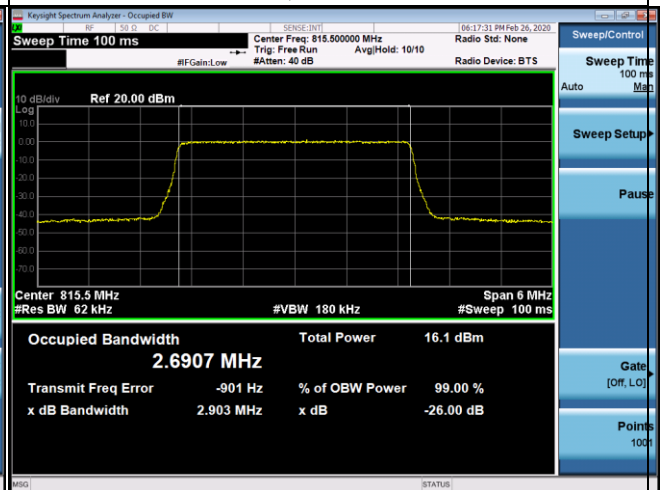

16QAM-26865

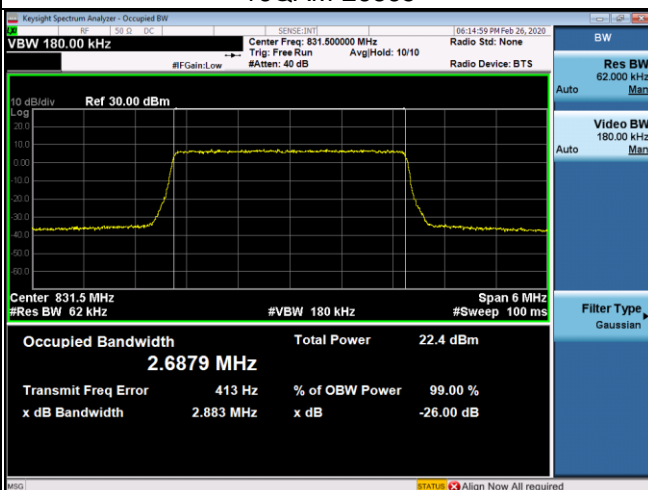

16QAM-27025



LTE Band 26_5M					
QPSK			16QAM		
Channel	Frequency (MHz)	99% Occupied Bandwidth (MHz)	Channel	Frequency (MHz)	99% Occupied Bandwidth (MHz)
26715	816.5	4.5234	26715	816.5	4.4765
26865	831	4.4772	26865	831	4.4760
27015	846.5	4.5064	27015	846.5	4.4749
Channel	Frequency (MHz)	26dB Bandwidth (MHz)	Channel	Frequency (MHz)	26dB Bandwidth (MHz)
26715	816.5	5.0000	26715	816.5	4.7860
26865	831	4.7860	26865	831	4.7760
27015	846.5	4.9520	27015	846.5	4.7860

Spectrum Plot

QPSK-26715

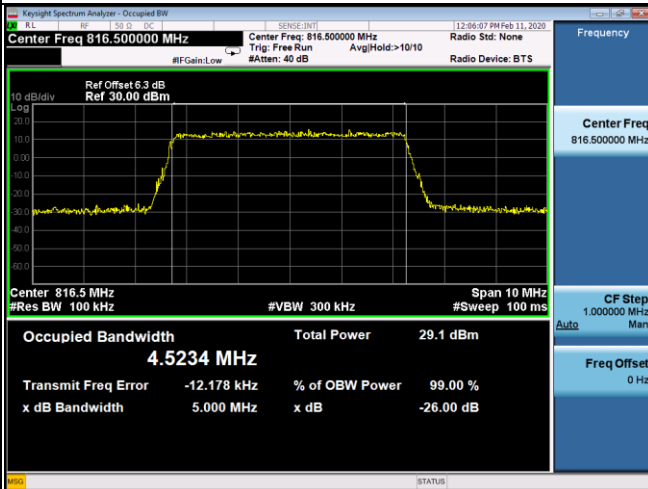

QPSK-26865

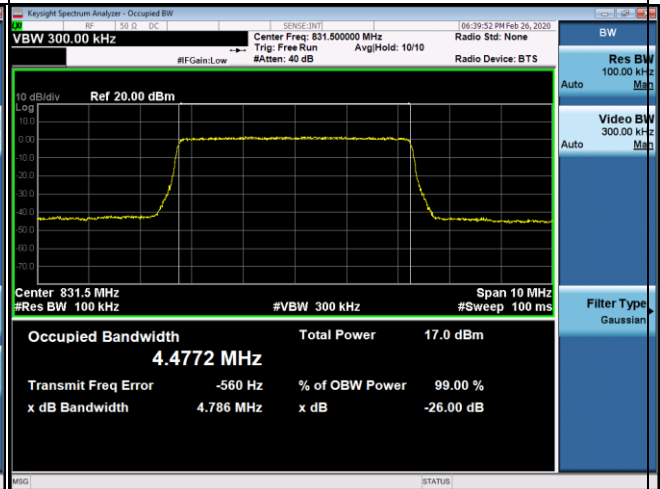

QPSK-20715



16QAM-26715

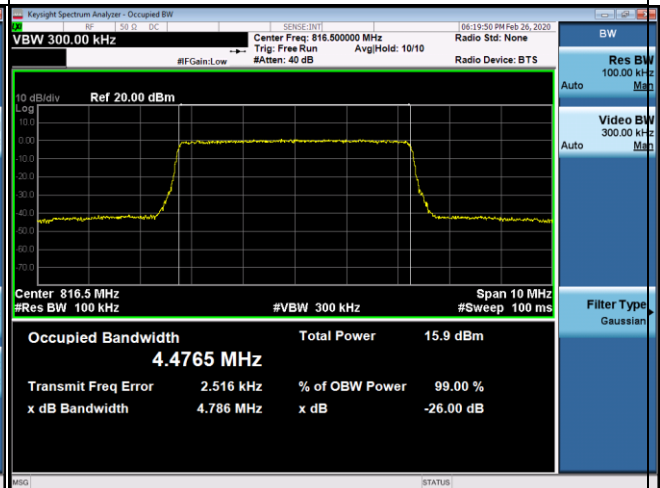

16QAM-26865

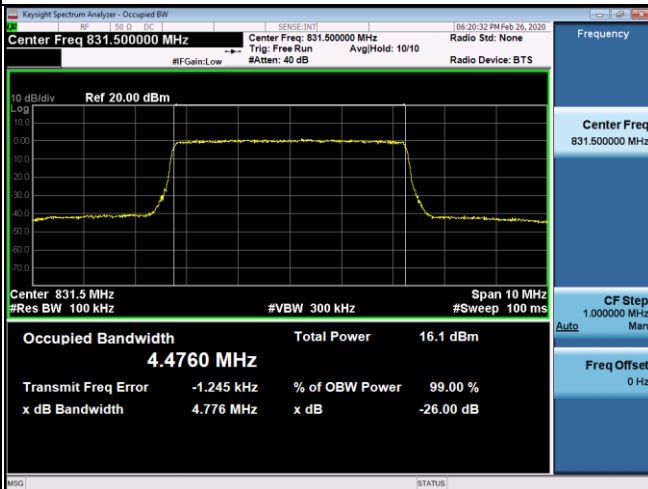

16QAM-20715

