



RF TEST REPORT

Applicant Quectel Wireless Solutions Co., Ltd
FCC ID XMR201912BG77
Product LTE Cat M1 & Cat NB2 Module
Brand Quectel
Model BG77
Marketing Quectel BG77
Report No. R1909A0576-R6
Issue Date March 13, 2020

TA Technology (Shanghai) Co., Ltd. tested the above equipment in accordance with the requirements in **FCC CFR47 Part 2 (2019)/ FCC CFR 47 Part 24E (2019)**. The test results show that the equipment tested is capable of demonstrating compliance with the requirements as documented in this report.

Performed by: Peng Tao

Approved by: Kai Xu

TA Technology (Shanghai) Co., Ltd.

No.145, Jintang Rd, Tangzhen Industry Park, Pudong Shanghai, China

TEL: +86-021-50791141/2/3

FAX: +86-021-50791141/2/3-8000



TABLE OF CONTENT

1. Test Laboratory	4
1.1. Notes of the test report.....	4
1.2. Testing Location	4
2. General Description of Equipment under Test.....	5
2.1. Applicant and Manufacturer Information	5
2.2. General information	5
3. Applied Standards.....	6
4. Test Configuration.....	7
5. Test Case Results.....	8
5.1. RF Power Output and Effective Radiated Power	8
5.2. Occupied Bandwidth	13
5.3. Band Edge Compliance.....	19
5.4. Peak-to-Average Power Ratio (PAPR)	36
5.5. Frequency Stability	38
5.6. Spurious Emissions at Antenna Terminals	42
5.7. Radiates Spurious Emission	55
6. Main Test Instruments	61



Summary of measurement results

No.	Test Case	Clause in FCC rules	Verdict
1	RF power output and Effective Radiated Power	2.1046 24.232(c)	PASS
2	Occupied Bandwidth	2.1049	PASS
3	Band Edge Compliance	2.1051 /24.238(a)	PASS
4	Peak-to-Average Power Ratio	24.232/KDB 971168 D01(5.7)	PASS
5	Frequency Stability	2.1055 / 24.235	PASS
6	Spurious Emissions at Antenna Terminals	2.1051 / 24.238(a)	PASS
7	Radiates Spurious Emission	2.1053 / 24.238(a)	PASS

Date of Testing: December 13, 2019 ~January 14, 2020

Note: PASS: The EUT complies with the essential requirements in the standard.

FAIL: The EUT does not comply with the essential requirements in the standard.

All indications of Pass/Fail in this report are opinions expressed by TA Technology (Shanghai) Co., Ltd. based on interpretations and/or observations of test results. Measurement Uncertainties were not taken into account and are published for informational purposes only.

1. Test Laboratory

1.1. Notes of the test report

This report shall not be reproduced in full or partial, without the written approval of **TA technology (shanghai) co., Ltd.** The results documented in this report apply only to the tested sample, under the conditions and modes of operation as described herein. Measurement Uncertainties were not taken into account and are published for informational purposes only. This report is written to support regulatory compliance of the applicable standards stated above.

1.2. Test facility

FCC (Designation number: CN1179, Test Firm Registration Number: 446626)

TA Technology (Shanghai) Co., Ltd. has been listed on the US Federal Communications Commission list of test facilities recognized to perform electromagnetic emissions measurements.

A2LA (Certificate Number: 3857.01)

TA Technology (Shanghai) Co., Ltd. has been listed by American Association for Laboratory Accreditation to perform electromagnetic emission measurement.

1.3. Testing Location

Company: TA Technology (Shanghai) Co., Ltd.
Address: No.145, Jintang Rd, Tangzhen Industry Park, Pudong
City: Shanghai
Post code: 201201
Country: P. R. China
Contact: Xu Kai
Telephone: +86-021-50791141/2/3
Fax: +86-021-50791141/2/3-8000
Website: <http://www.ta-shanghai.com>
E-mail: xukai@ta-shanghai.com

2. General Description of Equipment under Test

2.3. Applicant and Manufacturer Information

Applicant	Quectel Wireless Solutions Co., Ltd
Applicant address	Building 5, Shanghai Business Park Phase III (Area B), No.1016 Tianlin Road, Minhang District, Shanghai, China 200233
Manufacturer	Quectel Wireless Solutions Co., Ltd
Manufacturer address	Building 5, Shanghai Business Park Phase III (Area B), No.1016 Tianlin Road, Minhang District, Shanghai, China 200233

2.4. General information

EUT Description			
Model	BG77		
IMEI	866349040016200		
Hardware Version	R1.2		
Software Version	BG77LAR02A02		
Power Supply	External Power Supply		
Antenna Type	The EUT don't have standard Antenna, The Antenna used for testing in this report is the after-market accessory (Dipole Antenna)		
Antenna Gain	1.59dBi		
Test Mode(s)	LTE Band 2/25		
Test Modulation	(LTE)QPSK,16QAM		
LTE Category	M1		
Maximum E.I.R.P	LTE Band 2:	22.89dBm	
	LTE Band 25:	23.01dBm	
Rated Power Supply Voltage	3.3V		
Extreme Voltage	Minimum: 2.6V Maximum: 4.8V		
Extreme Temperature	Lowest: -40°C Highest: +85°C		
Operating Frequency Range(s)	Band	Tx (MHz)	Rx (MHz)
	LTE Band 2	1850 ~ 1910	1930 ~ 1990
	LTE Band 25	1850 ~ 1915	1930 ~ 1995
Note: 1. The EUT is sent from the applicant to TA and the information of the EUT is declared by the applicant.			

3. Applied Standards

According to the specifications of the manufacturer, it must comply with the requirements of the following standards:

Test standards:

FCC CFR 47 Part 24E (2019)

ANSI C63.26 (2015)

Reference standard:

FCC CFR47 Part 2 (2019)

KDB 971168 D01 Power Meas License Digital Systems v03r01

4. Test Configuration

Radiated measurements are performed by rotating the EUT in three different orthogonal test planes. EUT stand-up position (Z axis), lie-down position (X, Y axis). Receiver antenna polarization (horizontal and vertical), the worst emission was found in position (X axis, horizontal polarization) and the worst case was recorded.

All mode and data rates and positions and RB size and modulations were investigated.

Subsequently, only the worst case emissions are reported.

The following testing in LTE is set based on the maximum RF Output Power.

Test modes are chosen to be reported as the worst case configuration below for LTE Band 2/25:

Test items	Bandwidth (MHz)						Modulation		RB			Test Channel		
	1.4	3	5	10	15	20	QPSK	16QAM	1	50%	100%	L	M	H
RF power output	O	O	O	O	O	O	O	O	O	O	O	O	O	O
Effective Isotropic Radiated power	O	O	O	O	O	O	O	O	O	O	O	O	O	O
Occupied Bandwidth	O	O	O	O	O	O	O	O	-	-	O	O	O	O
Band Edge Compliance	O	O	O	O	O	O	O	O	O	-	O	O	-	O
Peak-to-Average Power Ratio	O	O	O	O	O	O	O	O	-	-	O	O	O	O
Frequency Stability	O	O	O	O	O	O	O	O	O	O	O	O	O	O
Conducted Spurious Emissions	O	O	O	O	O	O	O	-	O	-	-	O	O	O
Radiates Spurious Emission	O	-	O	-	-	O	O	-	O	-	-	-	O	-
Note	1. The mark "O" means that this configuration is chosen for testing. 2. The mark "-" means that this configuration is not testing.													

5. Test Case Results

5.3.RF Power Output and Effective Radiated Power

Ambient condition

Temperature	Relative humidity	Pressure
23°C ~25°C	45%~50%	101.5kPa

Methods of Measurement

During the process of the testing, The EUT is controlled by the Base Station Simulator to ensure max power transmission and proper modulation.

The testing follows FCC KDB 971168 v03r01 Section 5.8 and ANSI C63.26 (2015).

- a) Connect the equipment as illustrated. Mount the equipment with the manufacturer specified antenna in a vertical orientation on a manufacturer specified mounting surface located on a non-conducting rotating platform of a RF anechoic chamber (preferred) or a standard radiation site.
- b) Key the transmitter, then rotate the EUT 360° azimuthally and record spectrum analyzer power level (LVL) measurements at angular increments that are sufficiently small to permit resolution of all peaks. If a standard radiation test site is used, raise and lower the test antenna to obtain a maximum reading at each angular increment. (Note: several batteries may be needed to offset the effect of battery voltage droop, which should not exceed 5% of the manufactured specified battery voltage during transmission).
- c) Replace the transmitter under test with a vertically polarized half-wave dipole (or an antenna whose gain is known relative to an ideal half-wave dipole). The center of the antenna should be at the same location as the center of the antenna under test.
- d) Connect the antenna to a signal generator with a known output power and record the path loss (in dB) as LOSS. If a standard radiation test site is used, raise and lower the test antenna to obtain a maximum reading. $LOSS = \text{Generator Output Power (dBm)} - \text{Analyzer reading (dBm)}$
- e) Determine the effective radiated output power at each angular position from the readings in steps b) and d) using the following equation: $ERP \text{ (dBm)} = \text{LVL (dBm)} + \text{LOSS (dB)}$
- f) The maximum ERP is the maximum value determined in the preceding step.
- g) When calculating ERP, in addition to knowing the antenna radiation and matching characteristics, it is necessary to know the loss values of all elements (e.g.transmission line attenuation, mismatches, filters, combiners) interposed between the point where transmitter output power is measured, and the point where power is applied to the antenna. ERP can then be calculated as follows:
 $EIRP \text{ (dBm)} = \text{Output Power (dBm)} - \text{Losses (dB)} + \text{Antenna Gain (dBi)}$
where:dBd refers to gain relative to an ideal dipole.
 $EIRP \text{ (dBm)} = ERP \text{ (dBm)} + 2.15 \text{ (dB.)}$

The RB allocation refers to section 5.1, using the maximum output power configuration.

Test Setup

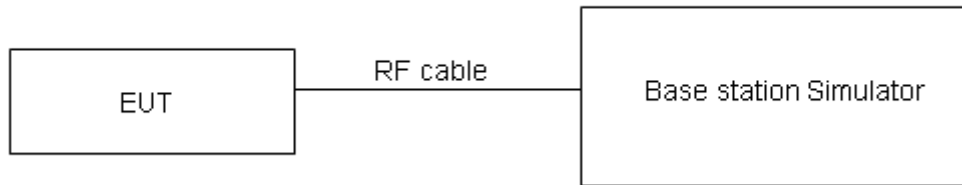

The loss between RF output port of the EUT and the input port of the tester has been taken into consideration.

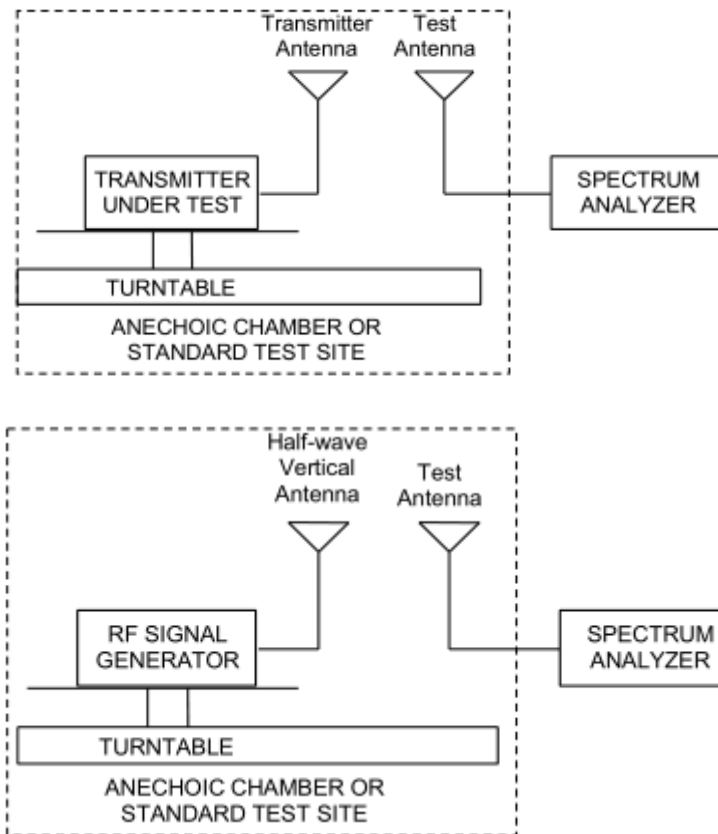

Limits

No specific RF power output requirements in part 2.1046.

Rule Part 24.232(c) Mobile and portable stations are limited to 2 watts EIRP.

Rule Part 24.232(e) Peak transmit power must be measured over any interval of continuous transmission using instrumentation calibrated in terms of an rms-equivalent voltage.

Limit	$\leq 2\text{ W}$ (33 dBm)
-------	----------------------------

**Measurement Uncertainty**

The assessed measurement uncertainty to ensure 95% confidence level for the normal distribution is with the coverage factor $k = 2$, $U = 0.4$ dB for RF power output, $k = 2$, $U = 1.19$ dB for EIRP.

**Test Results**

LTE Band2	Channel/ Frequency(MHz)	Index	RB# RBstart	Conducted Power (dBm)		EIRP (dBm)	
				QPSK	16QAM	QPSK	16QAM
1.4MHz	18607/1850.7	0	1#0	21.49	20.79	22.87	22.17
		0	6#0	19.39	19.38	20.77	20.76
	18900/1880	0	1#0	21.13	20.40	22.51	21.78
		0	6#0	19.26	19.20	20.64	20.58
	19193/1909.3	0	1#5	21.33	20.60	22.71	21.98
		0	6#0	19.50	19.42	20.88	20.80
3MHz	18615/1851.5	0	1#0	21.51	20.70	22.89	22.08
		0	6#0	19.43	19.45	20.81	20.83
	18900/1880	0	1#0	21.33	20.46	22.71	21.84
		0	6#0	19.16	19.20	20.54	20.58
	19185/1908.5	1	1#5	21.29	20.75	22.67	22.13
		1	6#0	19.20	19.19	20.58	20.57
5MHz	18625/1852.5	0	1#0	21.51	21.50	22.89	22.88
		0	6#0	20.40	20.50	21.78	21.88
	18900/1880	0	1#0	21.22	20.85	22.60	22.23
		0	6#0	20.25	20.17	21.63	21.55
	19175/1907.5	0	1#5	21.32	21.48	22.70	22.86
		3	6#0	20.42	20.70	21.80	22.08
10MHz	18650/1855	3	1#0	21.33	21.50	22.71	22.88
		0	4#0	20.44	20.43	21.82	21.81
	18900/1880	0	1#0	21.28	21.40	22.66	22.78
		0	4#0	21.35	21.17	22.73	22.55
	19150/1905	4	1#5	21.34	21.48	22.72	22.86
		7	4#2	21.37	21.33	22.75	22.71
15MHz	18675/1857.5	3	1#0	21.36	21.25	22.74	22.63
		0	6#0	21.49	21.47	22.87	22.85
	18900/1880	0	1#0	21.33	21.44	22.71	22.82
		0	6#0	21.30	21.26	22.68	22.64
	19125/1902.5	8	1#5	21.34	21.49	22.72	22.87
		11	6#0	21.42	21.23	22.80	22.61
20MHz	18700/1860	3	1#0	21.39	21.47	22.77	22.85
		0	6#0	21.48	21.25	22.86	22.63
	18900/1880	0	1#0	21.25	21.31	22.63	22.69
		0	6#0	21.29	21.41	22.67	22.79
	19100/1900	12	1#5	21.31	21.39	22.69	22.77
		15	6#0	21.43	21.20	22.81	22.58



LTE Band25	Channel/ Frequency(MHz)	Index	RB# RBstart	Conducted Power (dBm)		EIRP (dBm)	
				QPSK	16QAM	QPSK	16QAM
1.4MHz	26047/1850.7	0	1#0	21.63	20.04	23.01	21.42
		0	6#0	19.05	19.45	20.43	20.83
	26365/1882.5	0	1#0	21.32	19.80	22.70	21.18
		0	6#0	18.85	19.20	20.23	20.58
	26683/1914.3	0	1#5	20.94	19.49	22.32	20.87
		0	6#0	18.77	19.79	20.15	21.17
3MHz	26055/1851.5	0	1#0	21.25	19.92	22.63	21.30
		0	6#0	19.06	19.34	20.44	20.72
	26365/1882.5	0	1#0	21.01	19.85	22.39	21.23
		0	6#0	18.89	19.14	20.27	20.52
	26675/1913.5	1	1#5	20.91	19.66	22.29	21.04
		1	6#0	18.64	18.99	20.02	20.37
5MHz	26065/1852.5	0	1#0	21.02	20.75	22.40	22.13
		0	6#0	19.97	20.13	21.35	21.51
	26365/1882.5	0	1#0	20.80	21.03	22.18	22.41
		0	6#0	19.82	19.92	21.20	21.30
	26665/1912.5	0	1#5	20.81	20.47	22.19	21.85
		3	6#0	19.72	19.84	21.10	21.22
10MHz	26090/1855	3	1#0	21.03	20.76	22.41	22.14
		0	4#0	20.95	21.24	22.33	22.62
	26365/1882.5	0	1#0	20.80	21.07	22.18	22.45
		0	4#0	20.64	20.91	22.02	22.29
	26640/1910	4	1#5	20.61	20.30	21.99	21.68
		7	4#2	20.62	20.81	22.00	22.19
15MHz	26115/1857.5	3	1#0	21.03	20.76	22.41	22.14
		0	6#0	20.85	20.96	22.23	22.34
	26365/1882.5	0	1#0	20.77	21.07	22.15	22.45
		0	6#0	20.74	20.79	22.12	22.17
	26615/1907.5	8	1#5	20.59	20.31	21.97	21.69
		11	6#0	20.60	20.75	21.98	22.13
20MHz	26140/1860	3	1#0	21.01	20.71	22.39	22.09
		0	6#0	20.82	20.95	22.20	22.33
	26365/1882.5	0	1#0	20.89	20.06	22.27	21.44
		0	6#0	20.74	20.87	22.12	22.25
	26590/1905	12	1#5	20.51	20.29	21.89	21.67
		15	6#0	20.56	20.92	21.94	22.30

5.4.Occupied Bandwidth

Ambient condition

Temperature	Relative humidity	Pressure
23°C ~25°C	45%~50%	101.5kPa

Method of Measurement

The EUT was connected to Spectrum Analyzer and Base Station Simulator via power Splitter. The occupied bandwidth is measured using spectrum analyzer.

RBW is set to 51kHz, VBW is set to 160kHz for LTE Band 2/25

99% power and -26dBc occupied bandwidths are recorded. Spectrum analyzer plots are included on the following pages.

Test Setup

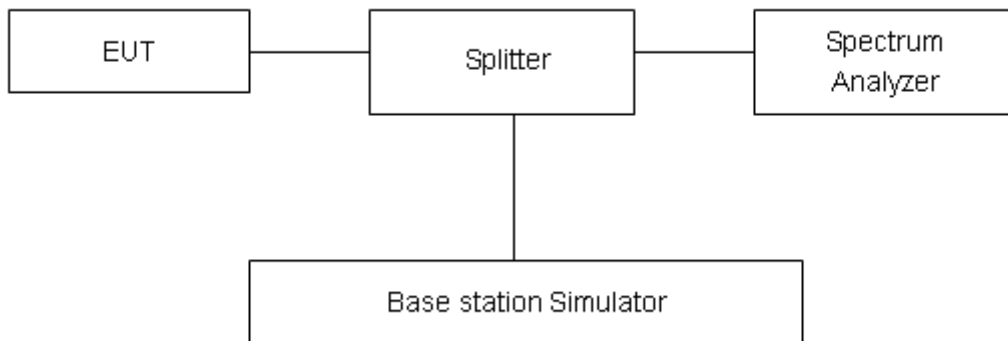

Limits

No specific occupied bandwidth requirements in part 2.1049.

Measurement Uncertainty

The assessed measurement uncertainty to ensure 95% confidence level for the normal distribution is with the coverage factor $k = 2$, $U = 624\text{Hz}$.

Test Result

Mode	Bandwidth	Modulation	Channel/ Frequency(MHz)	RB	Index	Bandwidth(MHz)	
						99% Power	-26dBc
Band2	1.4MHz	QPSK	18900/1880	6#0	0	1.1076	1.353
		16QAM	18900/1880	6#0	0	0.9452	1.159
	3MHz	QPSK	18900/1880	6#0	0	1.1095	1.363
		16QAM	18900/1880	6#0	0	0.9436	1.200
	5MHz	QPSK	18900/1880	6#0	0	1.1058	1.327
		16QAM	18900/1880	6#0	0	0.9496	1.213
	10MHz	QPSK	18900/1880	6#0	0	1.1114	1.340
		16QAM	18900/1880	6#0	0	0.9606	1.260
	15MHz	QPSK	18900/1880	6#0	0	1.1211	1.384
		16QAM	18900/1880	6#0	0	0.9581	1.310
	20MHz	QPSK	18900/1880	6#0	0	1.1251	1.379
		16QAM	18900/1880	6#0	0	0.9572	1.171

Mode	Bandwidth	Modulation	Channel/ Frequency(MHz)	RB	Index	Bandwidth(MHz)	
						99% Power	-26dBc
Band25	1.4MHz	QPSK	26365/1882.5	6#0	0	1.1003	1.360
		16QAM	26365/1882.5	6#0	0	0.9397	1.141
	3MHz	QPSK	26365/1882.5	6#0	0	1.1121	1.328
		16QAM	26365/1882.5	6#0	0	0.9459	1.156
	5MHz	QPSK	26365/1882.5	6#0	0	1.1120	1.328
		16QAM	26365/1882.5	6#0	0	0.9464	1.183
	10MHz	QPSK	26365/1882.5	6#0	0	1.1177	1.375
		16QAM	26365/1882.5	6#0	0	0.9639	1.225
	15MHz	QPSK	26365/1882.5	6#0	0	1.1195	1.365
		16QAM	26365/1882.5	6#0	0	0.9597	1.275
	20MHz	QPSK	26365/1882.5	6#0	0	1.1260	1.346
		16QAM	26365/1882.5	6#0	0	0.9562	1.196

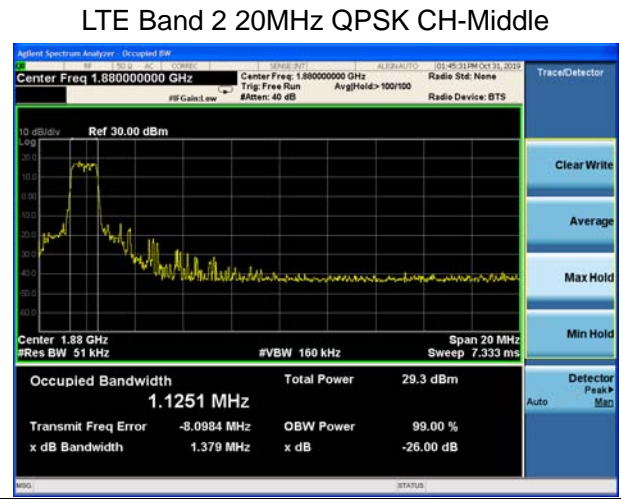
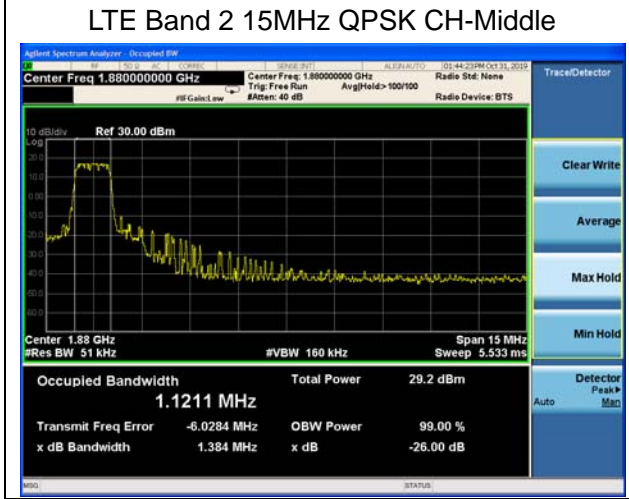
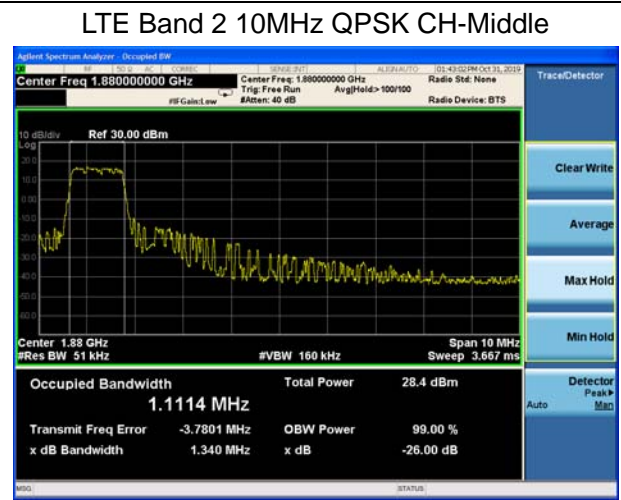
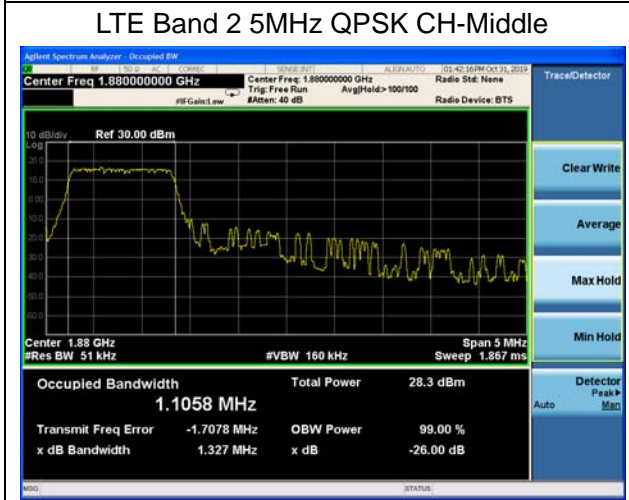
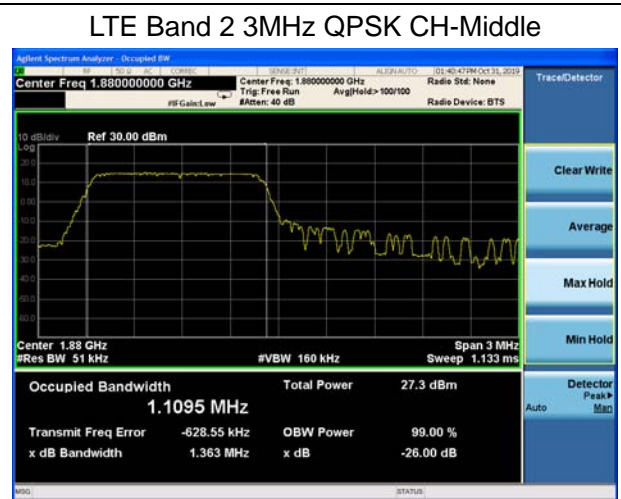
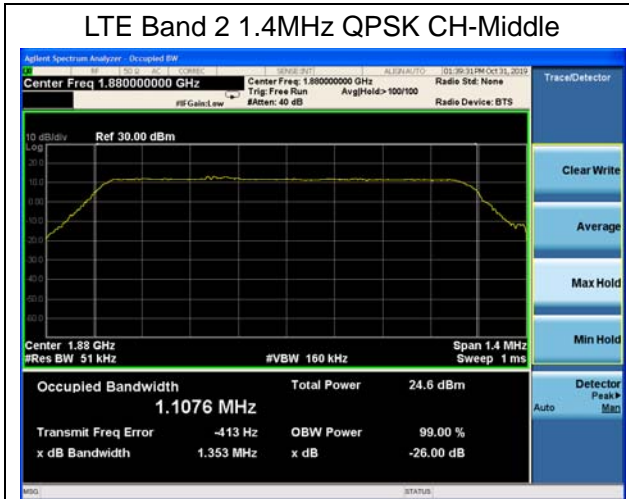

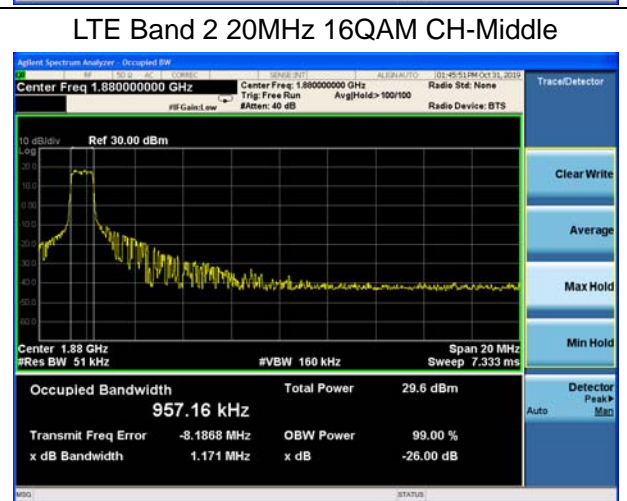
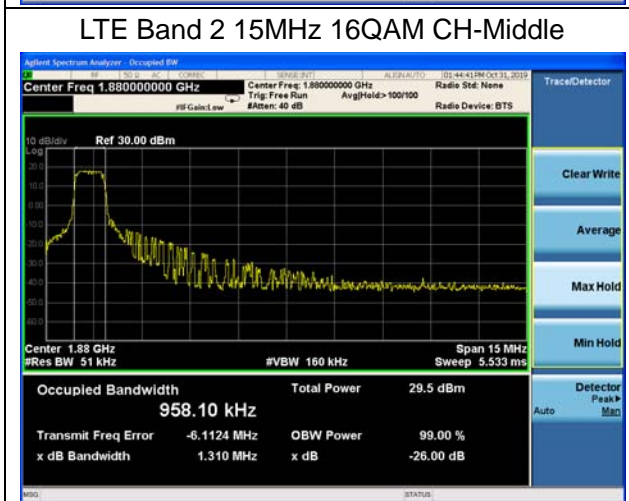
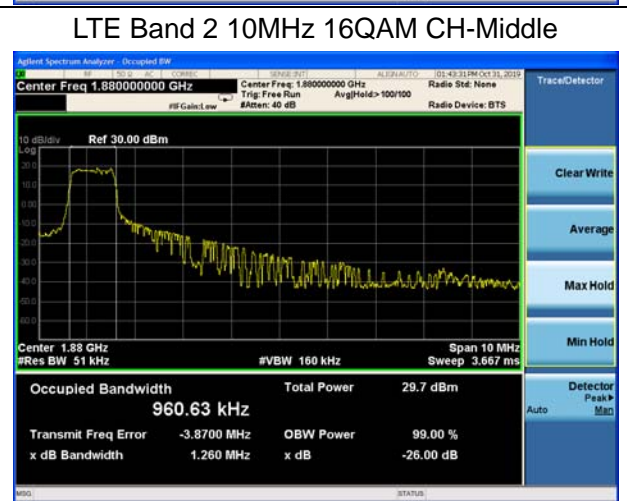
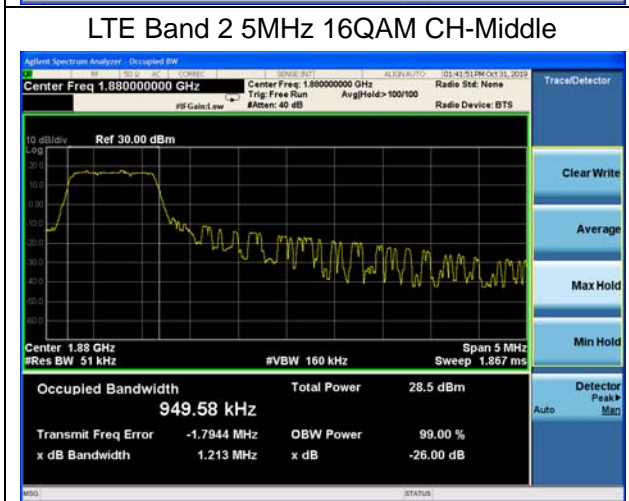
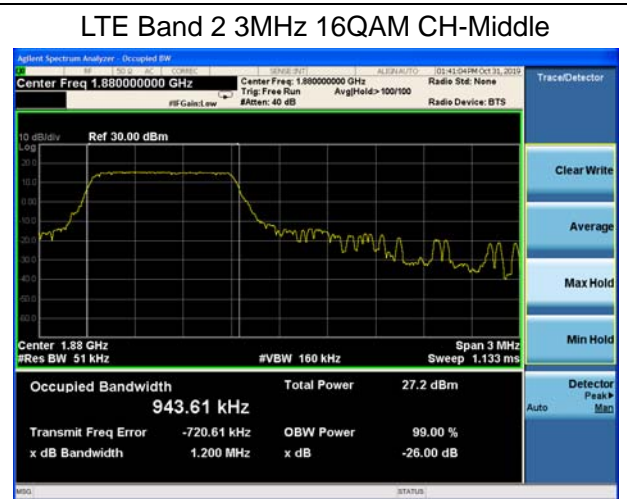
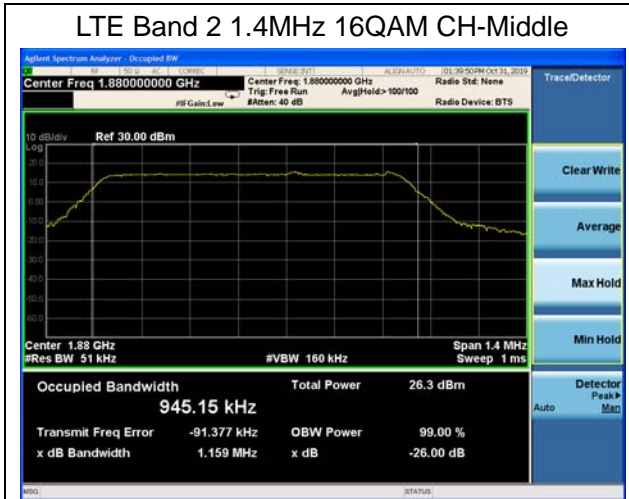

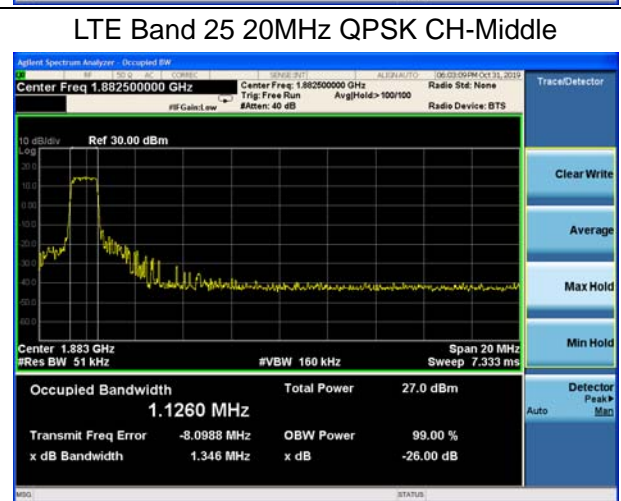
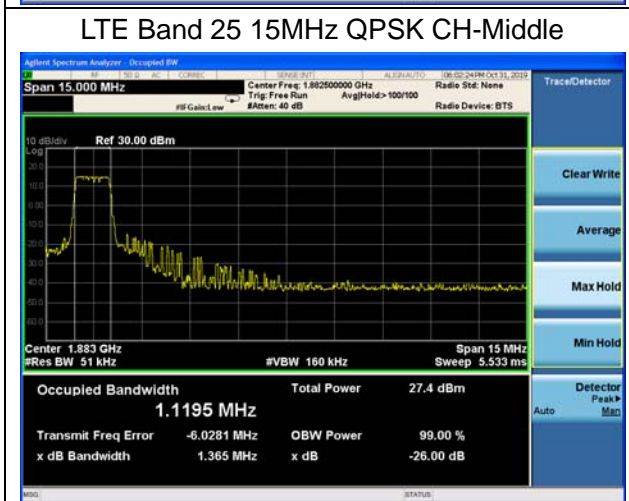
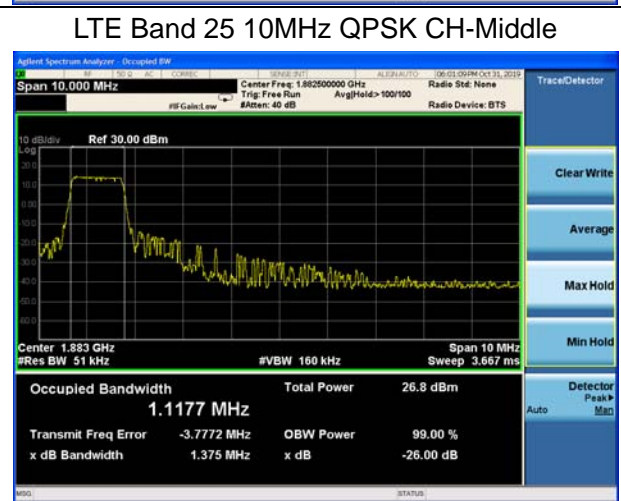
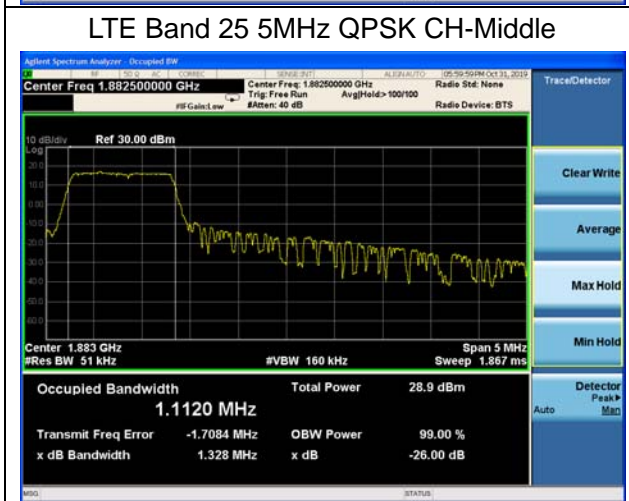
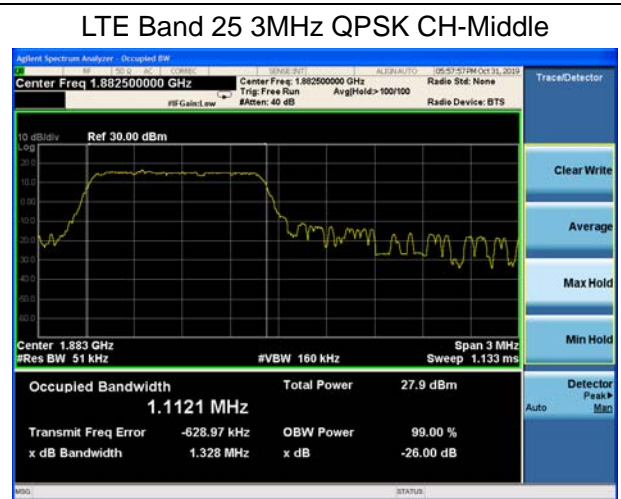
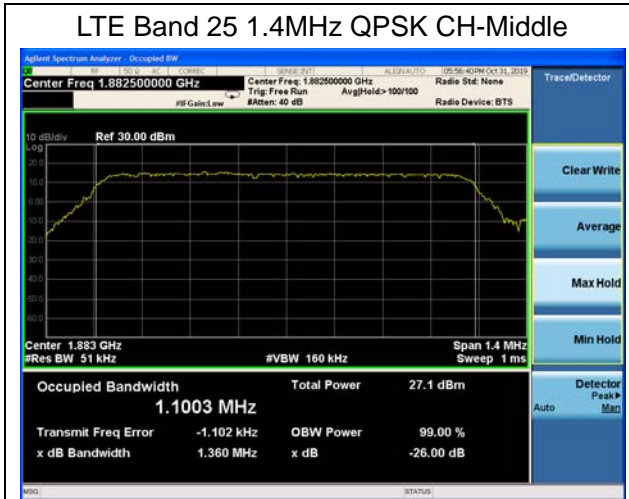

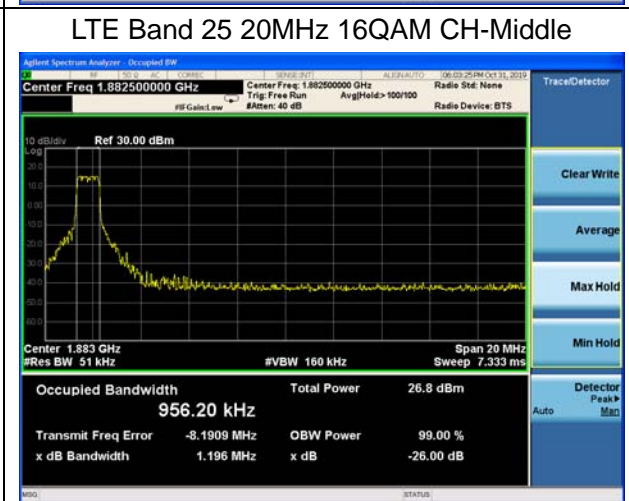
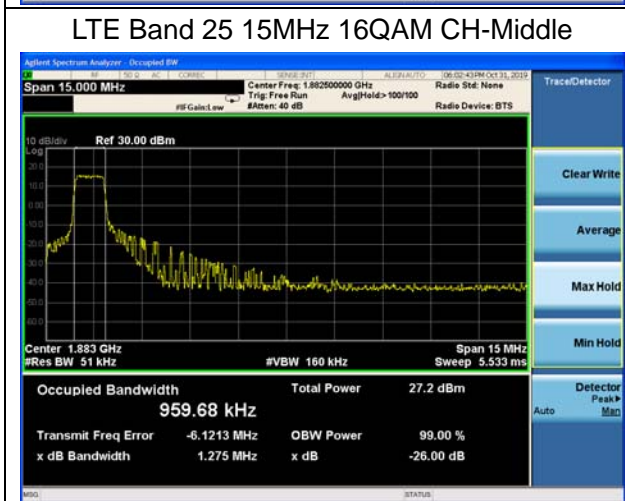
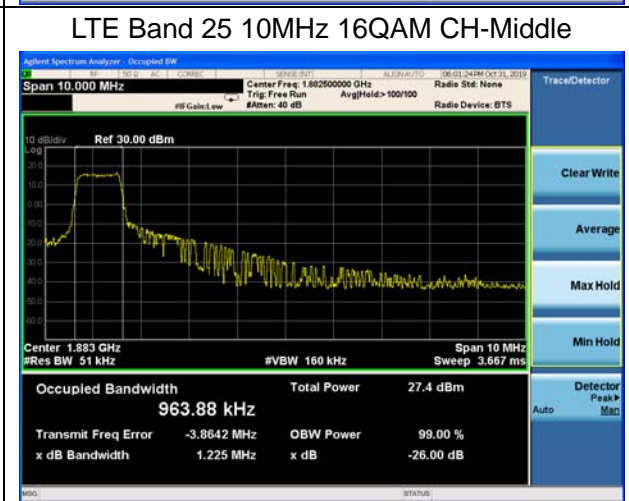
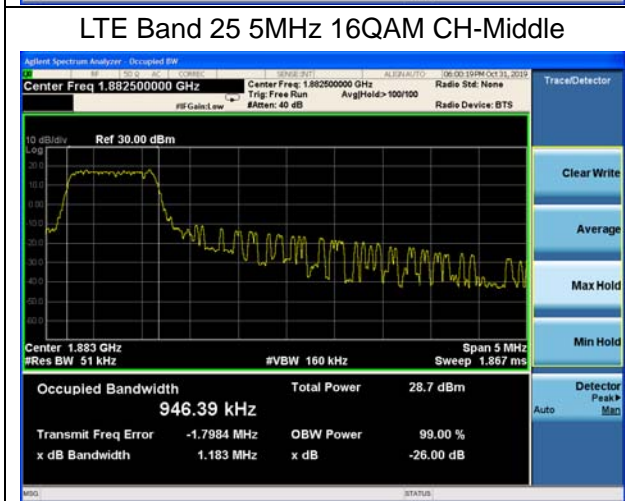
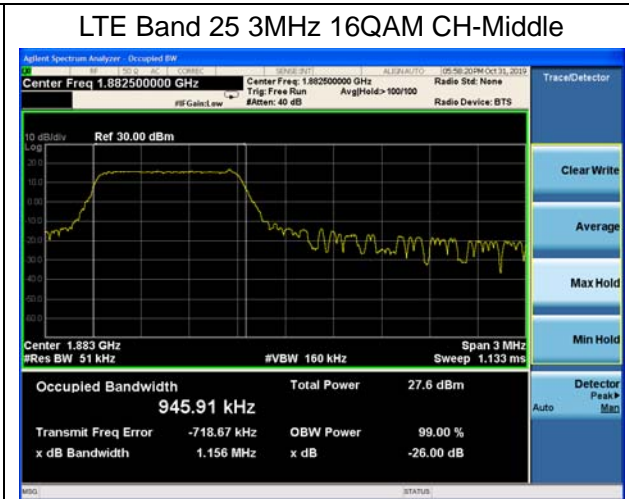
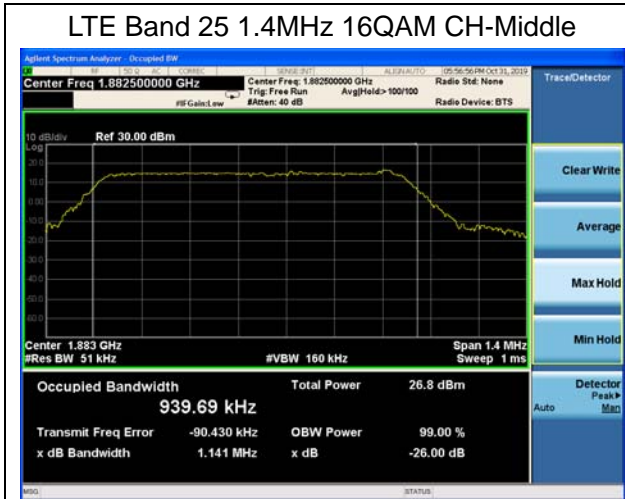

5.5. Band Edge Compliance

Ambient condition

Temperature	Relative humidity	Pressure
23°C ~25°C	45%~50%	101.5kPa

Method of Measurement

The EUT was connected to Spectrum Analyzer and Base Station Simulator via power Splitter. The band edge of the lowest and highest channels were measured. The Average detector is used and RBW is set to 51kHz, VBW is set to 160kHz for LTE Band 2/5 (1.4/3/5/10/15/20MHz), Spectrum analyzer plots are included on the following pages.

Test Setup

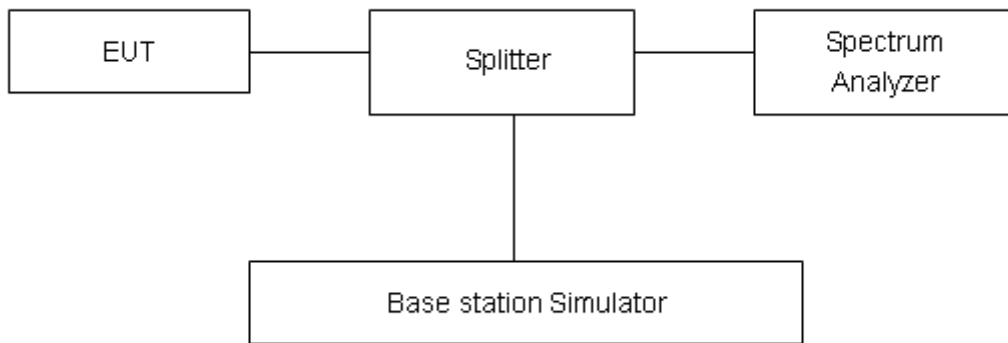

Limits

Rule Part 24.238(a) specifies that “on any frequency outside a licensee’s frequency block, the power of any emission shall be attenuated below the transmitter power (P) by at least $43 + 10 \log_{10} (P)$ dB.”

Limit	-13 dBm
-------	---------

Measurement Uncertainty

The assessed measurement uncertainty to ensure 95% confidence level for the normal distribution is with the coverage factor $k = 1.96$, $U=0.684$ dB.



Test Result:

LTE Band 2 1.4MHz QPSK 1RB CH-Low

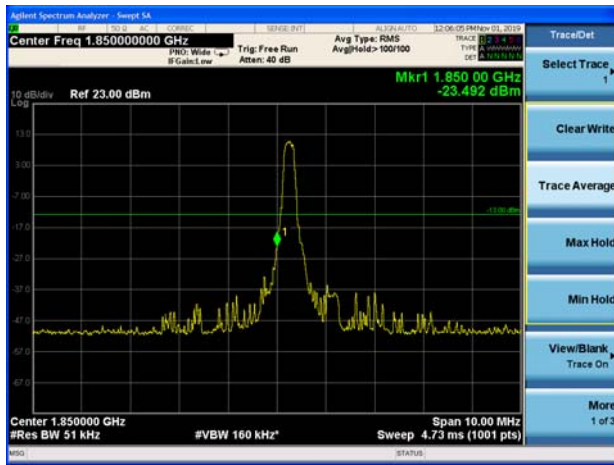

LTE Band 2 1.4MHz QPSK 1RB CH-High



LTE Band 2 1.4MHz QPSK 100%RB CH-Low



LTE Band 2 1.4MHz QPSK 100%RB CH-High



LTE Band 2 3MHz QPSK 1RB CH-Low

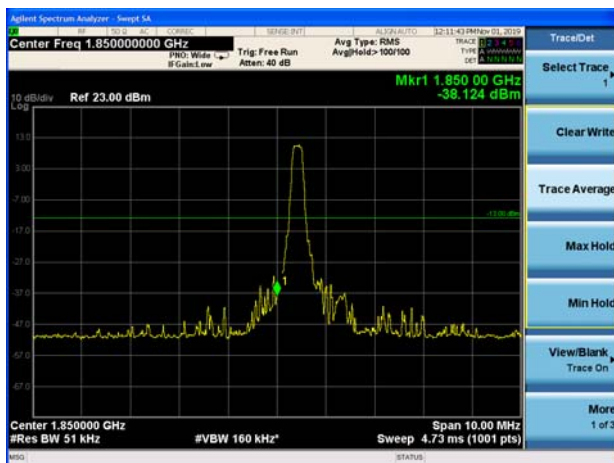

LTE Band 2 3MHz QPSK 1RB CH-High

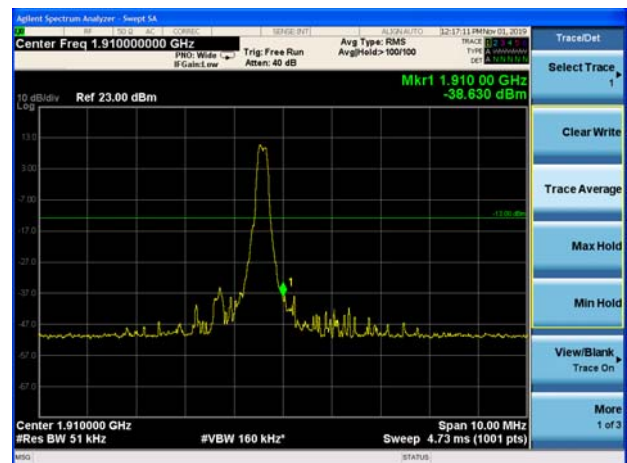



LTE Band 2 3MHz QPSK 100%RB CH-Low

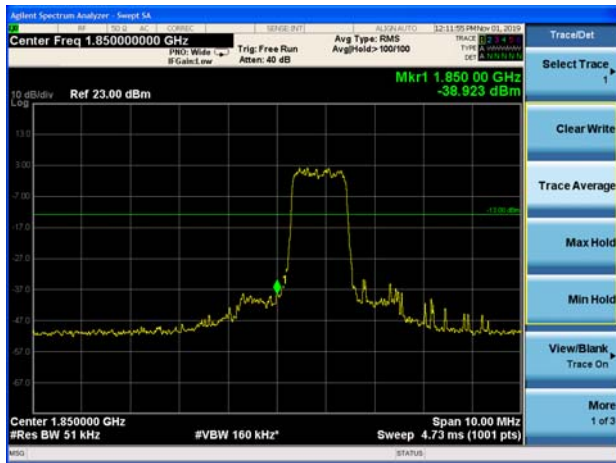

LTE Band 2 3MHz QPSK 100%RB CH-High



LTE Band 2 5MHz QPSK 1RB CH-Low

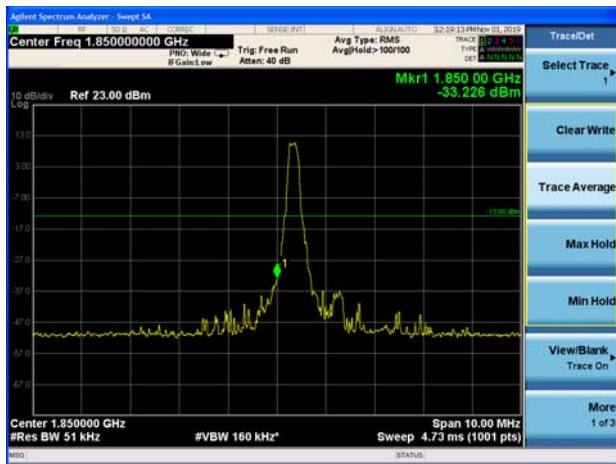

LTE Band 2 5MHz QPSK 1RB CH-High

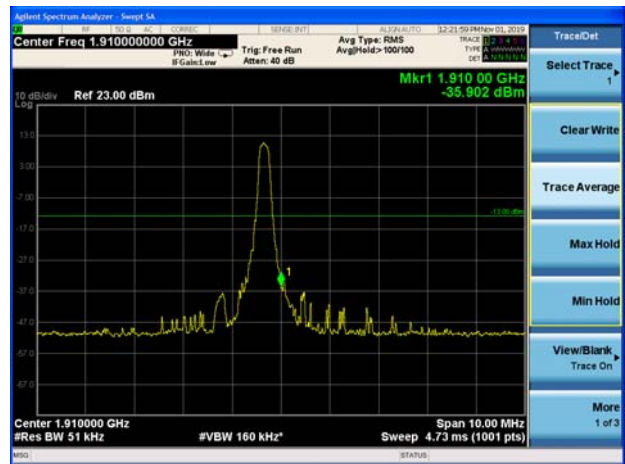

LTE Band 2 5MHz QPSK 100%RB CH-Low

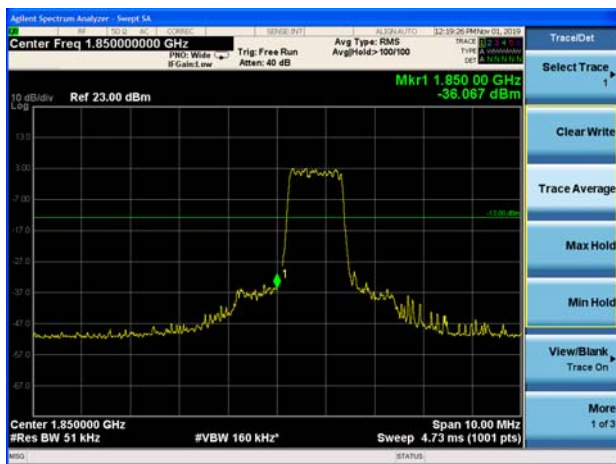

LTE Band 2 5MHz QPSK 100%RB CH-High

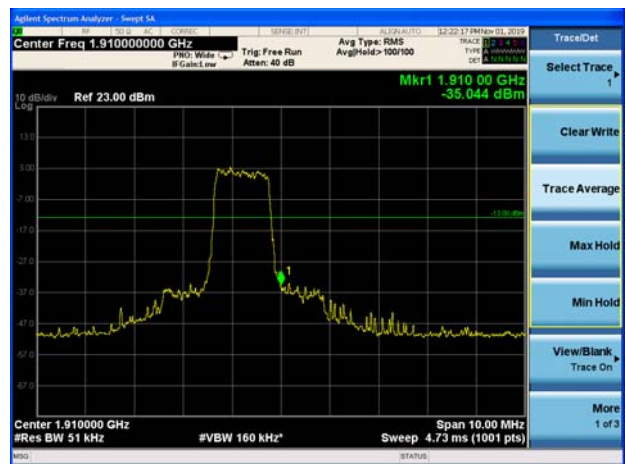



LTE Band 2 10MHz QPSK 1RB CH-Low

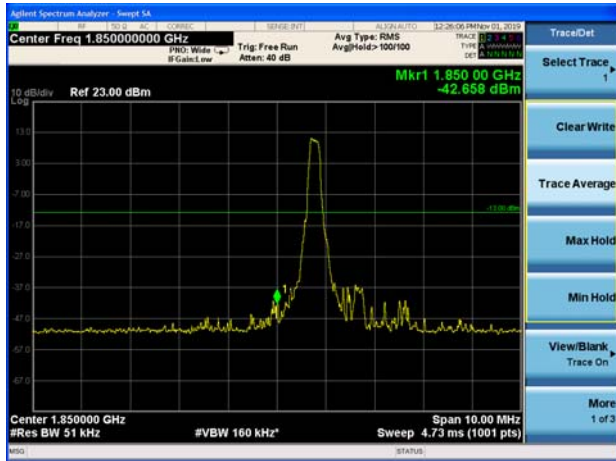

LTE Band 2 10MHz QPSK 1RB CH-High

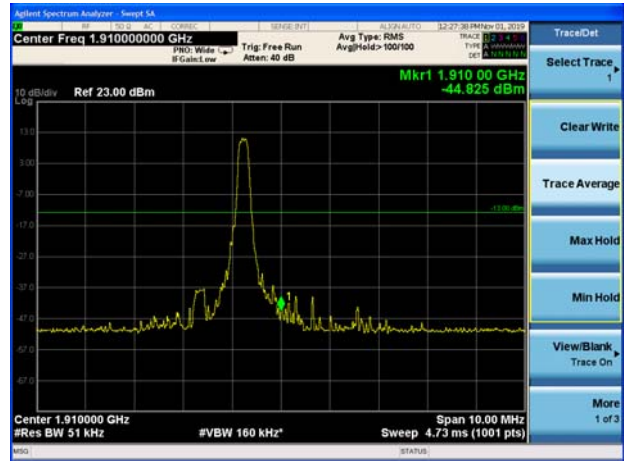

LTE Band 2 10MHz QPSK 100%RB CH-Low

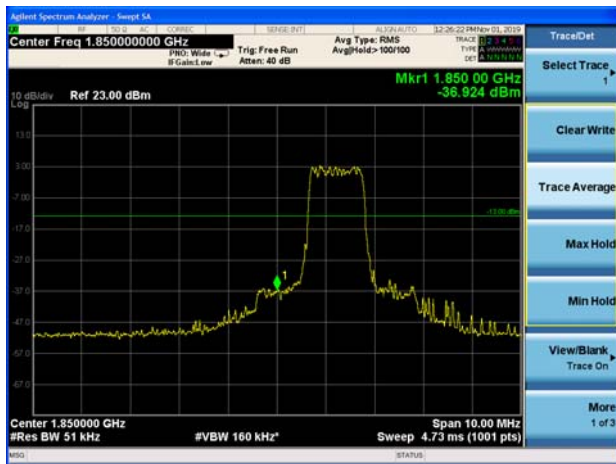

LTE Band 2 10MHz QPSK 100%RB CH-High



LTE Band 2 15MHz QPSK 1RB CH-Low

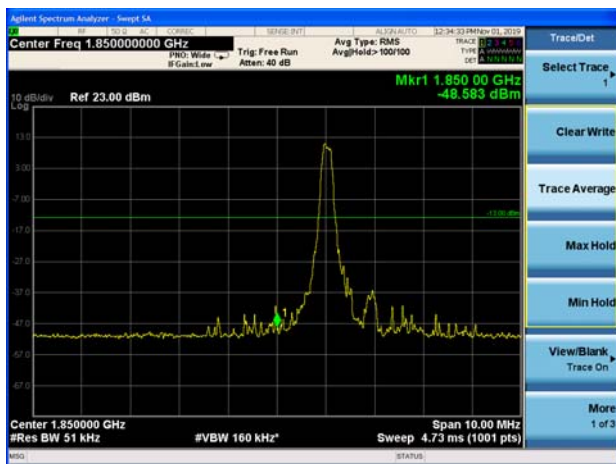

LTE Band 2 15MHz QPSK 1RB CH-High

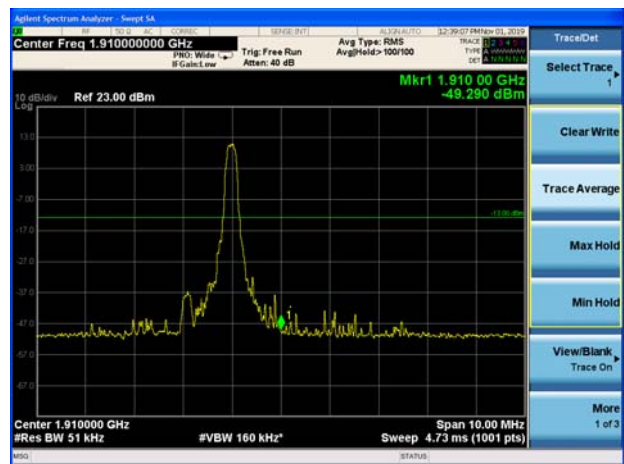



LTE Band 2 15MHz QPSK 100%RB CH-Low



LTE Band 2 15MHz QPSK 100%RB CH-High



LTE Band 2 20MHz QPSK 1RB CH-Low

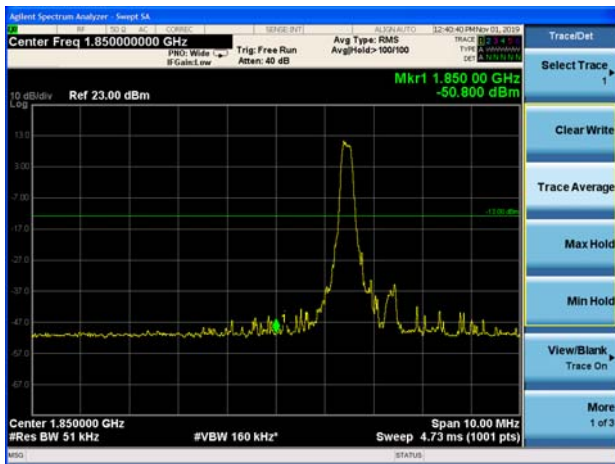

LTE Band 2 20MHz QPSK 1RB CH-High

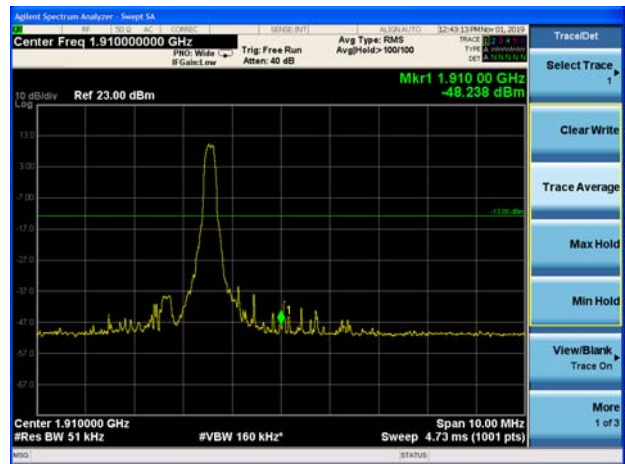

LTE Band 2 20MHz QPSK 100%RB CH-Low

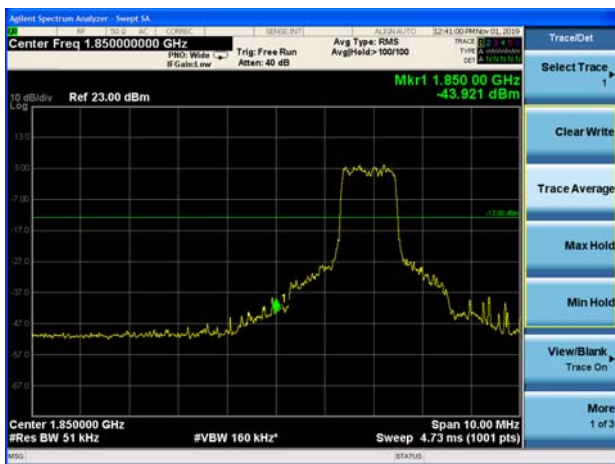

LTE Band 2 20MHz QPSK 100%RB CH-High

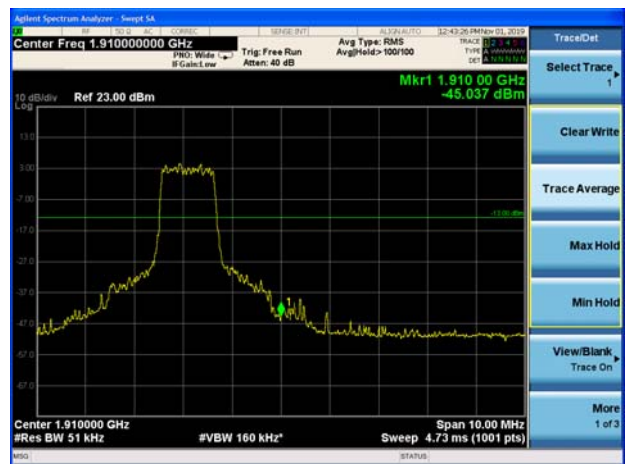



LTE Band 2 1.4MHz 16QAM 1RB CH-Low

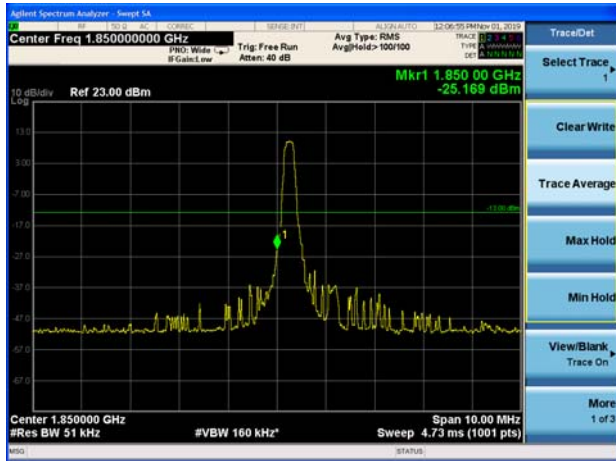

LTE Band 2 1.4MHz 16QAM 1RB CH-High

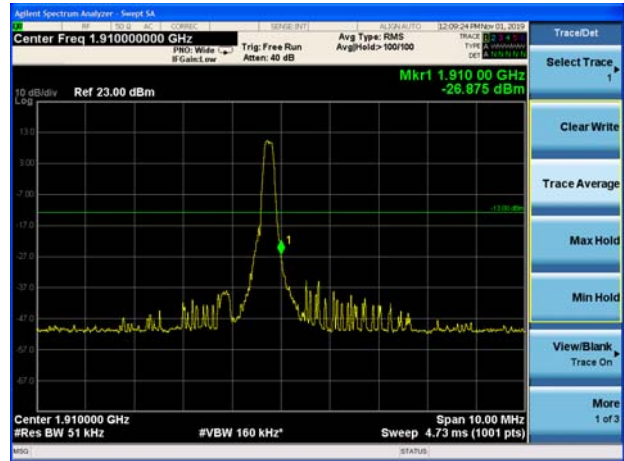

LTE Band 2 1.4MHz 16QAM 100%RB CH-Low

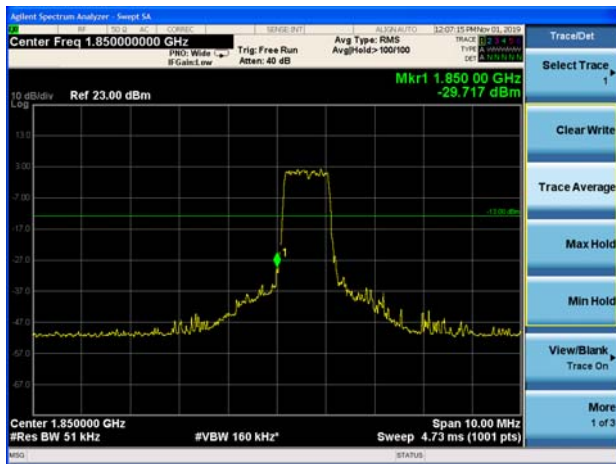

LTE Band 2 1.4MHz 16QAM 100%RB CH-High



LTE Band 2 3MHz 16QAM 1RB CH-Low

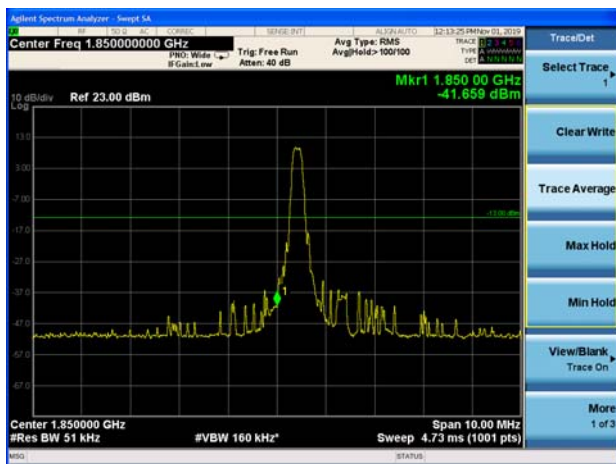

LTE Band 2 3MHz 16QAM 1RB CH-High

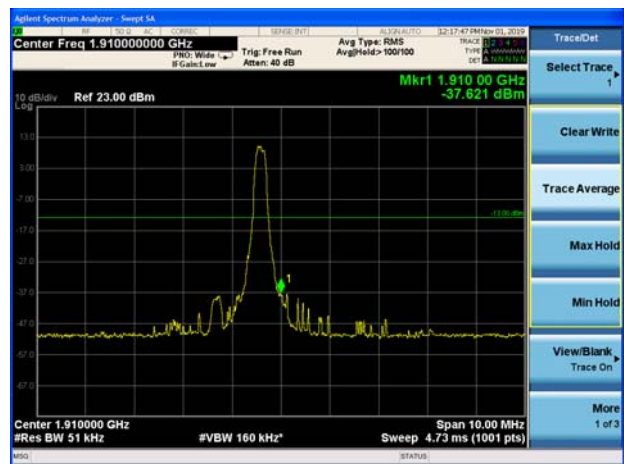



LTE Band 2 3MHz 16QAM 100%RB CH-Low

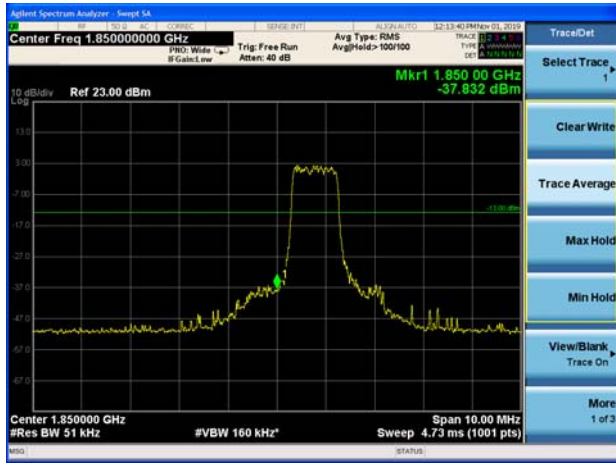

LTE Band 2 3MHz 16QAM 100%RB CH-High

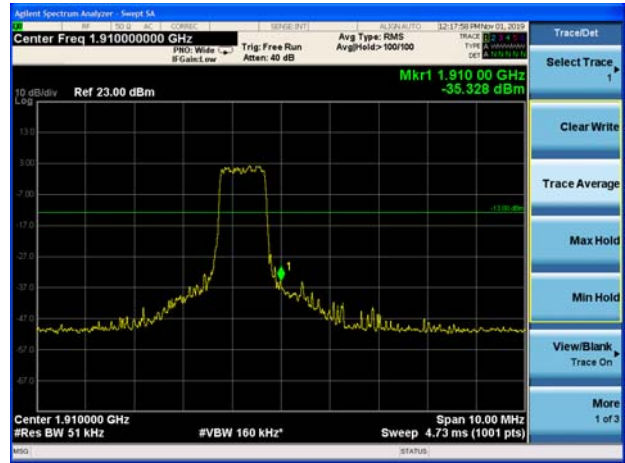

LTE Band 2 5MHz 16QAM 1RB CH-Low

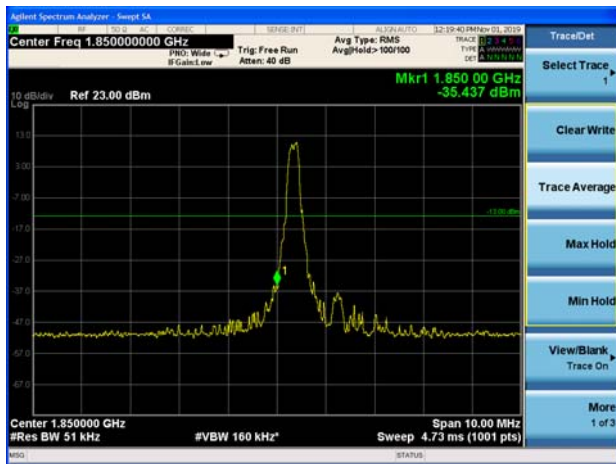

LTE Band 2 5MHz 16QAM 1RB CH-High

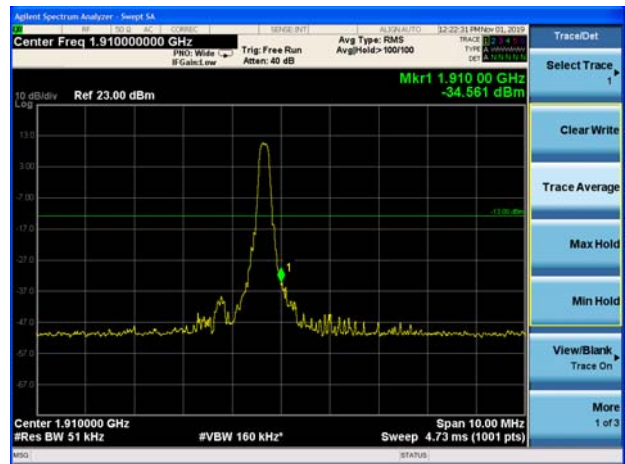

LTE Band 2 5MHz 16QAM 100%RB CH-Low

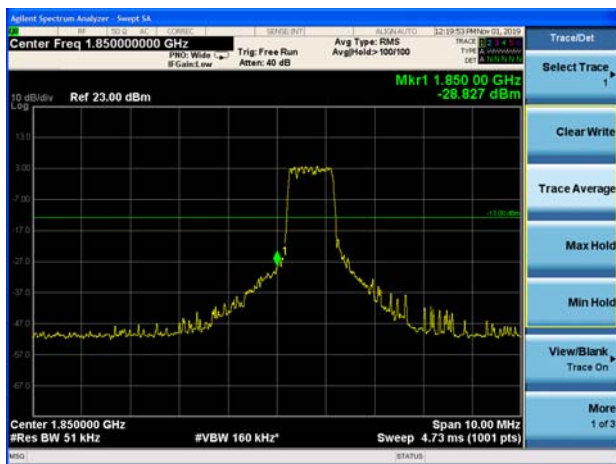

LTE Band 2 5MHz 16QAM 100%RB CH-High

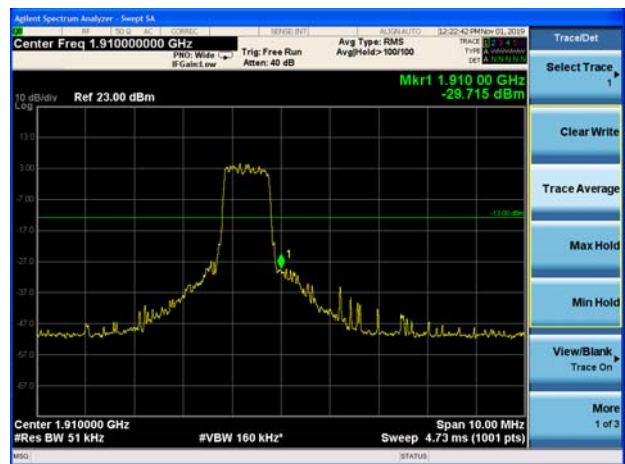



LTE Band 2 10MHz 16QAM 1RB CH-Low

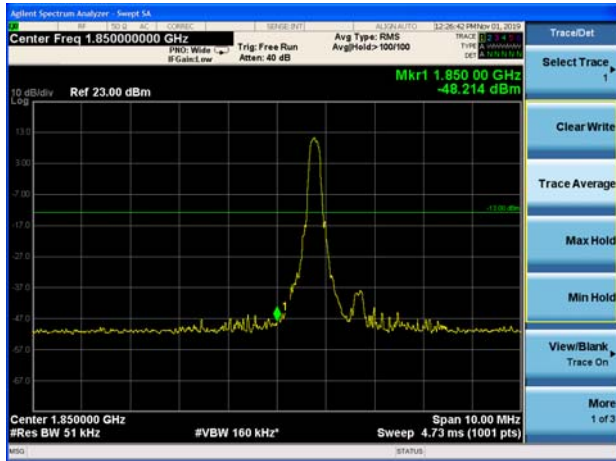

LTE Band 2 10MHz 16QAM 1RB CH-High

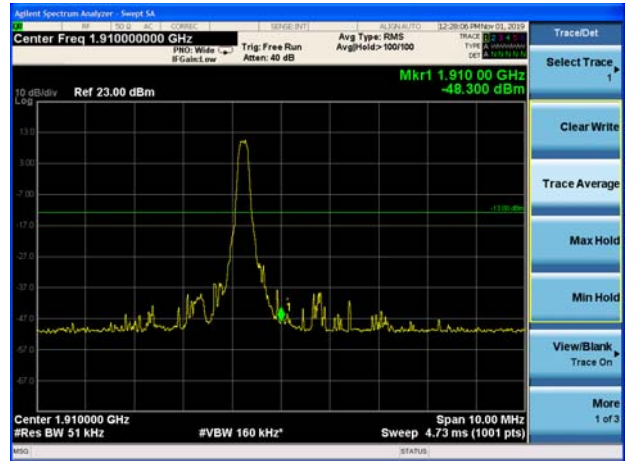

LTE Band 2 10MHz 16QAM 100%RB CH-Low



LTE Band 2 10MHz 16QAM 100%RB CH-High

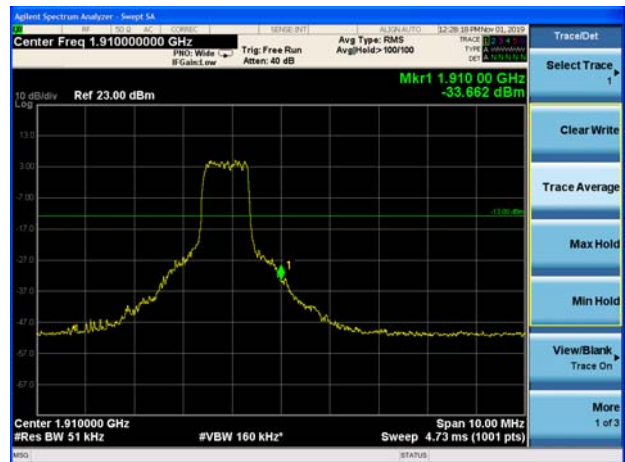

LTE Band 2 15MHz 16QAM 1RB CH-Low

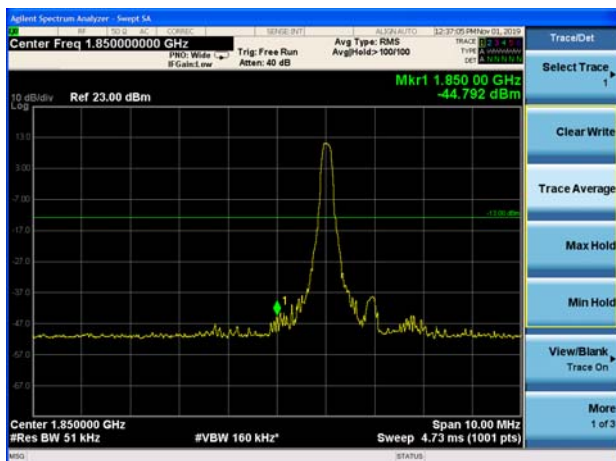

LTE Band 2 15MHz 16QAM 1RB CH-High

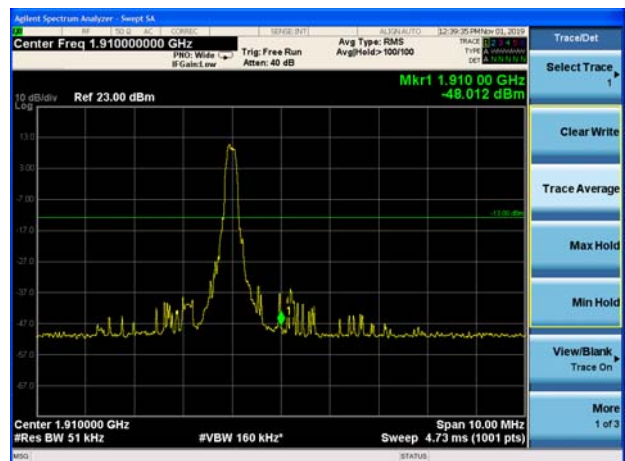



LTE Band 2 15MHz 16QAM 100%RB CH-Low

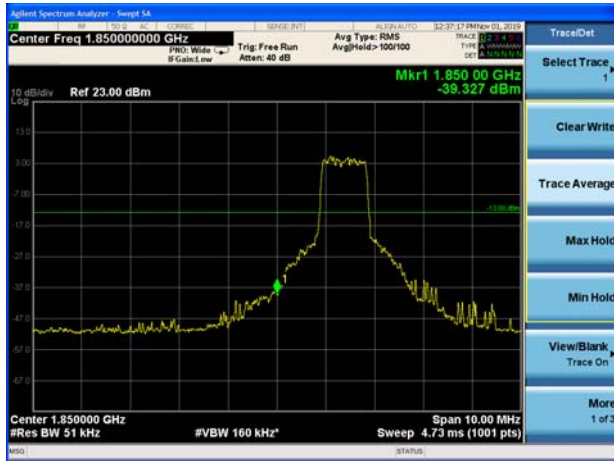

LTE Band 2 15MHz 16QAM 100%RB CH-High



LTE Band 2 20MHz 16QAM 1RB CH-Low

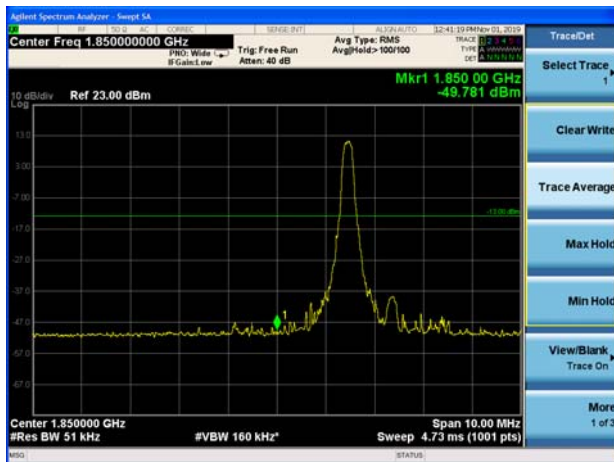

LTE Band 2 20MHz 16QAM 1RB CH-High

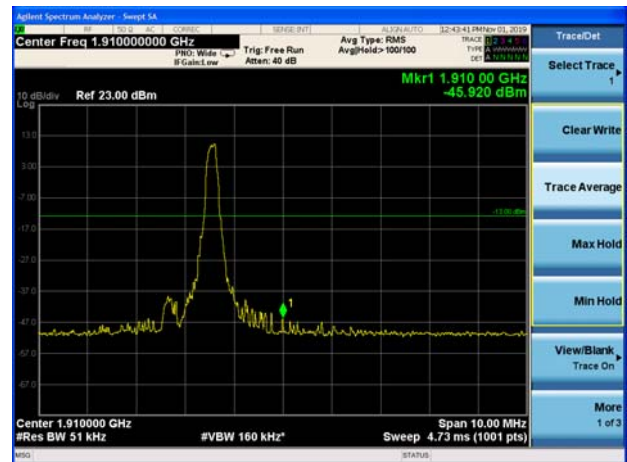

LTE Band 2 20MHz 16QAM 100%RB CH-Low

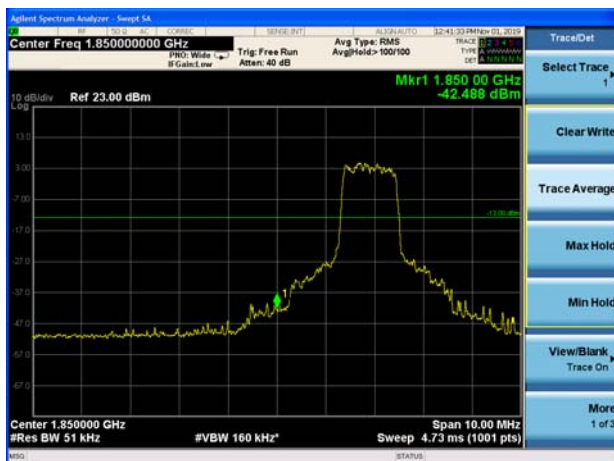

LTE Band 2 20MHz 16QAM 100%RB CH-High

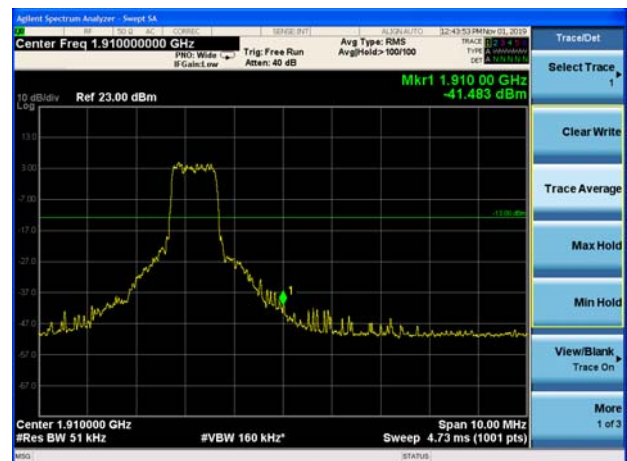

LTE Band 25 1.4MHz QPSK 1RB CH-Low

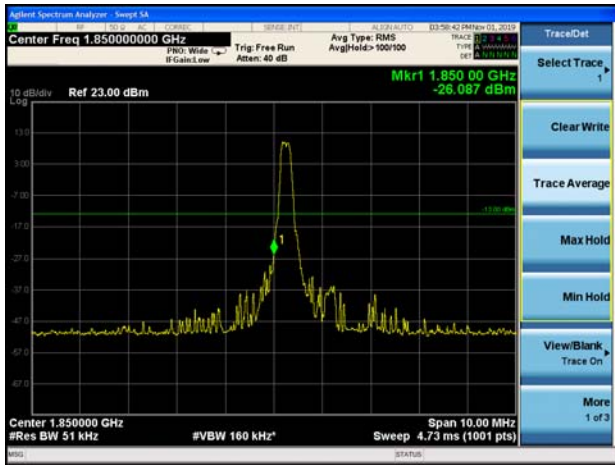

LTE Band 25 1.4MHz QPSK 1RB CH-High

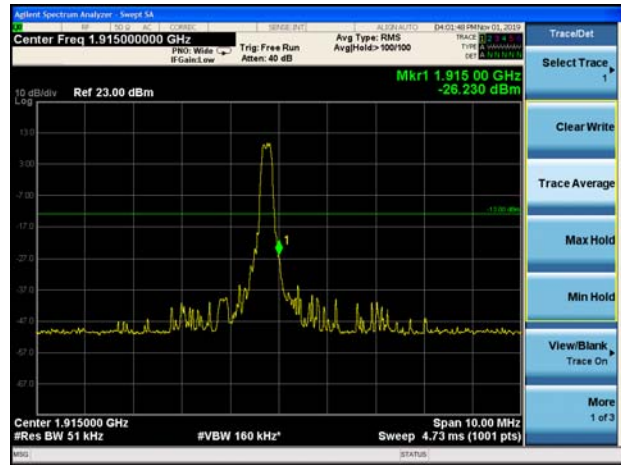

LTE Band 25 1.4MHz QPSK 100%RB CH-Low



LTE Band 25 1.4MHz QPSK 100%RB CH-High

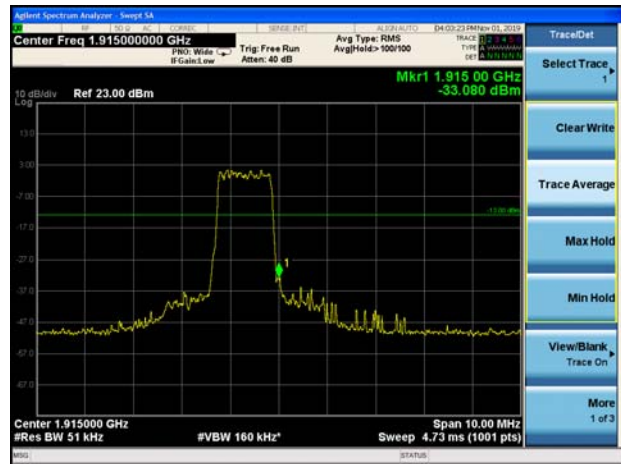

LTE Band 25 3MHz QPSK 1RB CH-Low

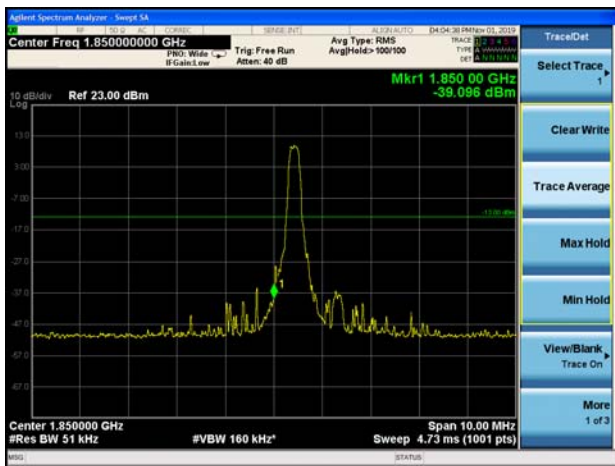

LTE Band 25 3MHz QPSK 1RB CH-High

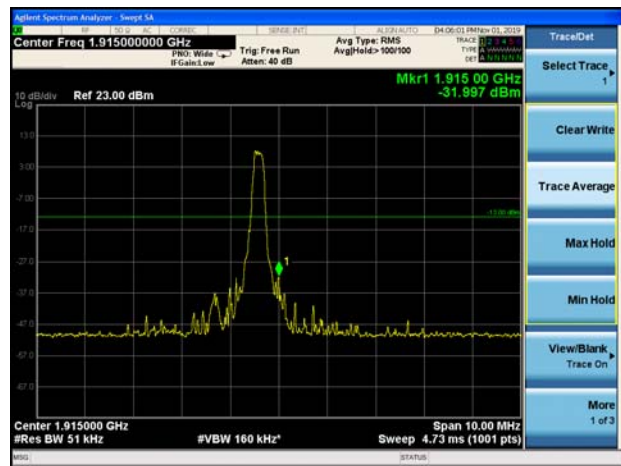



LTE Band 25 3MHz QPSK 100%RB CH-Low

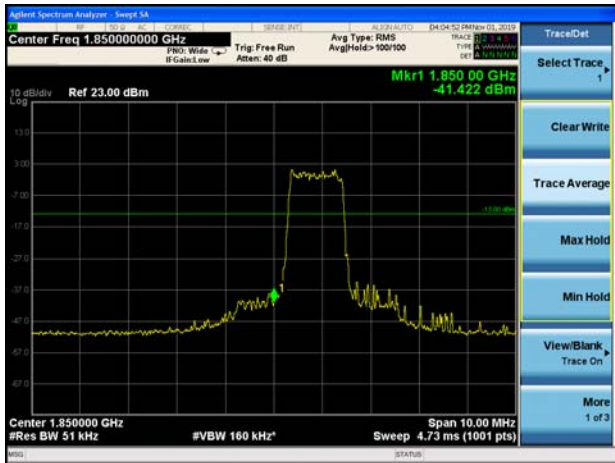

LTE Band 25 3MHz QPSK 100%RB CH-High

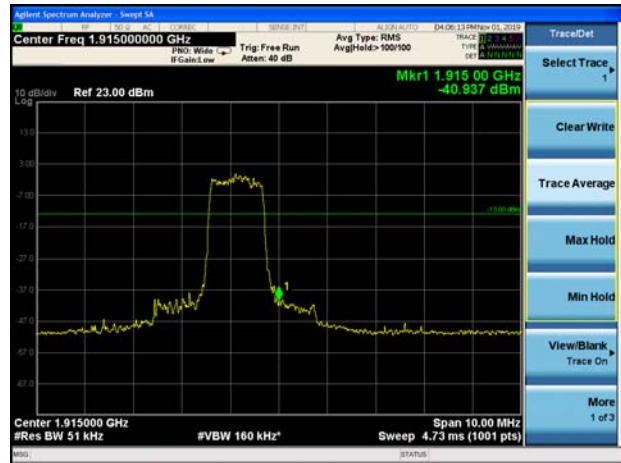

LTE Band 25 5MHz QPSK 1RB CH-Low

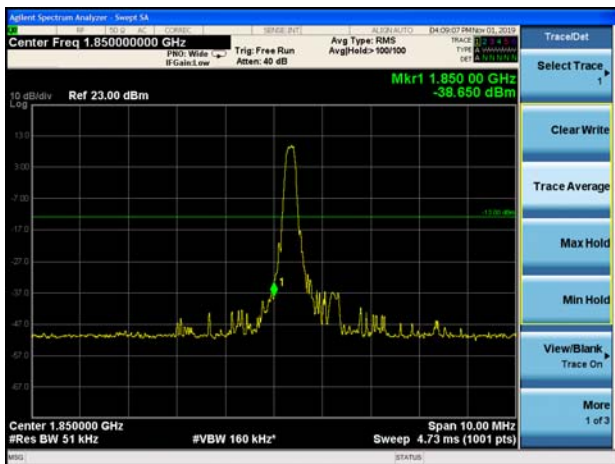

LTE Band 25 5MHz QPSK 1RB CH-High

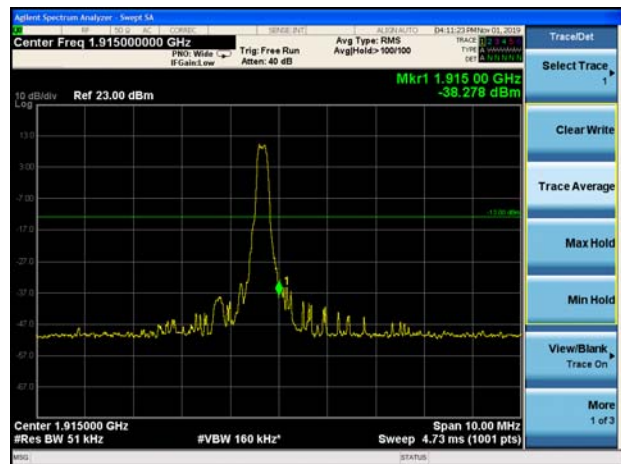

LTE Band 25 5MHz QPSK 100%RB CH-Low

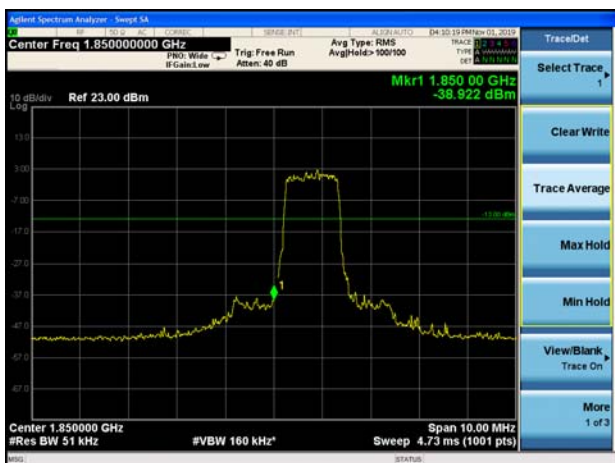

LTE Band 25 5MHz QPSK 100%RB CH-High





LTE Band 25 10MHz QPSK 1RB CH-Low

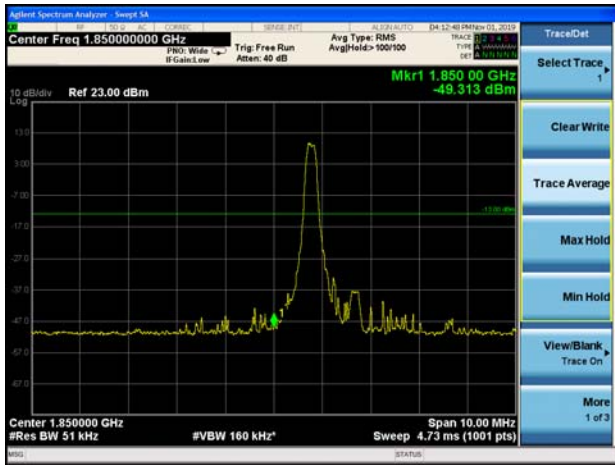

LTE Band 25 10MHz QPSK 1RB CH-High

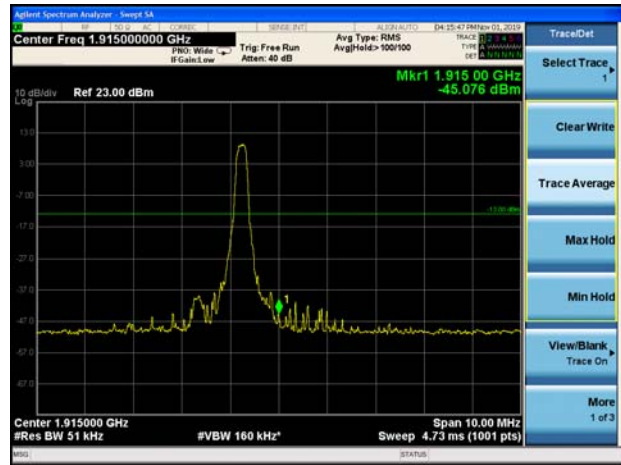

LTE Band 25 10MHz QPSK 100%RB CH-Low

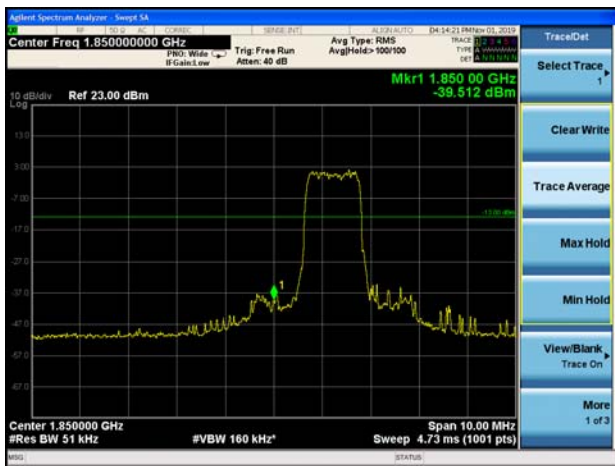

LTE Band 25 10MHz QPSK 100%RB CH-High



LTE Band 25 15MHz QPSK 1RB CH-Low

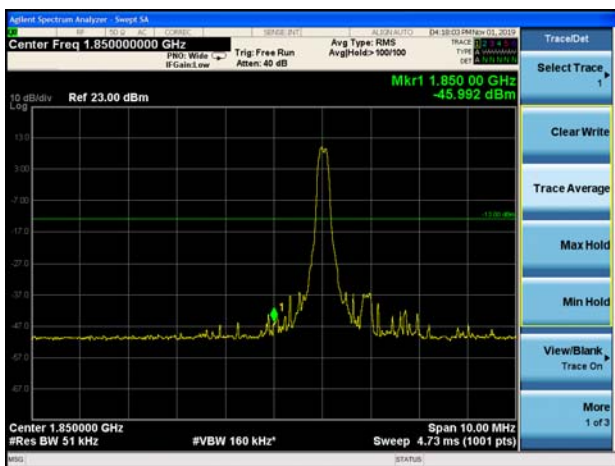

LTE Band 25 15MHz QPSK 1RB CH-High

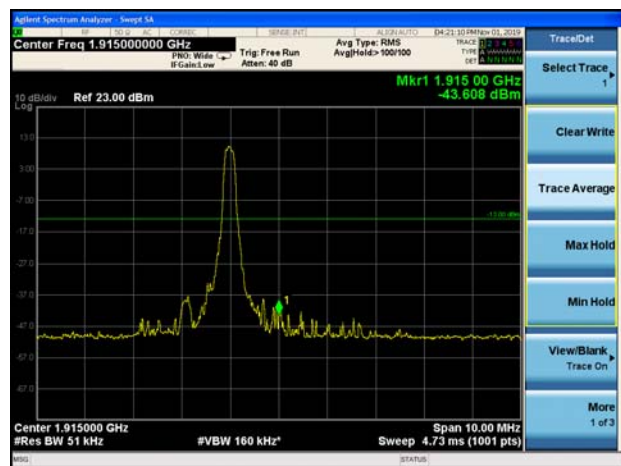



LTE Band 25 15MHz QPSK 100%RB CH-Low

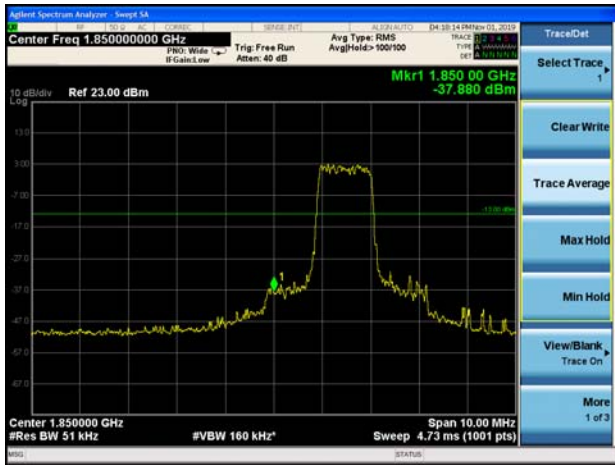

LTE Band 25 15MHz QPSK 100%RB CH-High

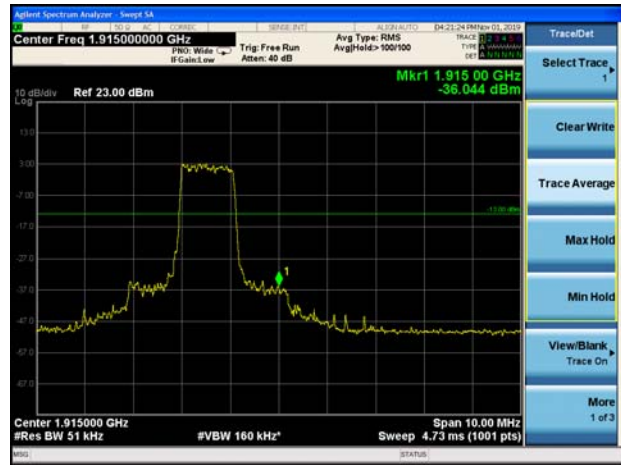

LTE Band 25 20MHz QPSK 1RB CH-Low

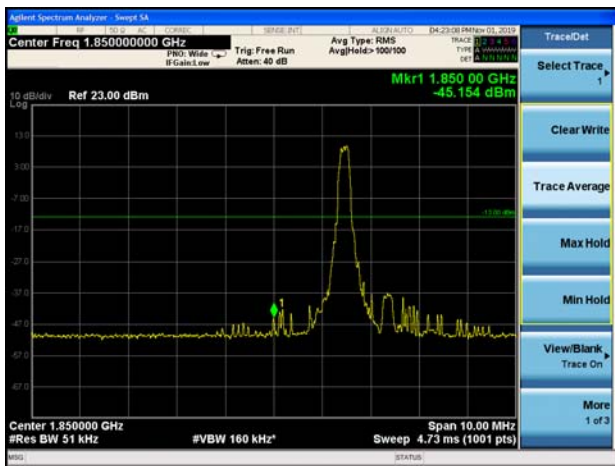

LTE Band 25 20MHz QPSK 1RB CH-High

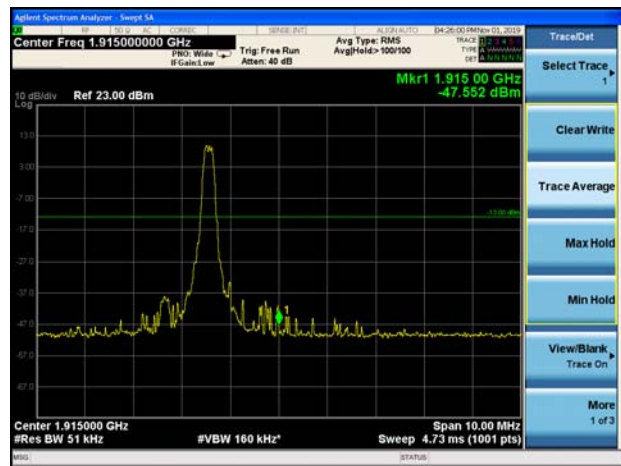

LTE Band 25 20MHz QPSK 100%RB CH-Low



LTE Band 25 20MHz QPSK 100%RB CH-High



LTE Band 25 1.4MHz 16QAM 1RB CH-Low

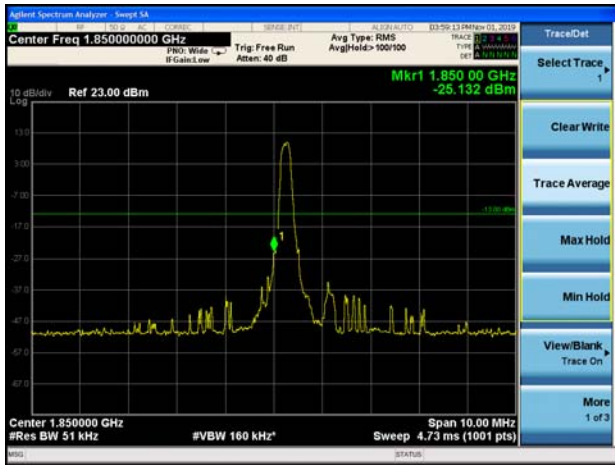

LTE Band 25 1.4MHz 16QAM 1RB CH-High

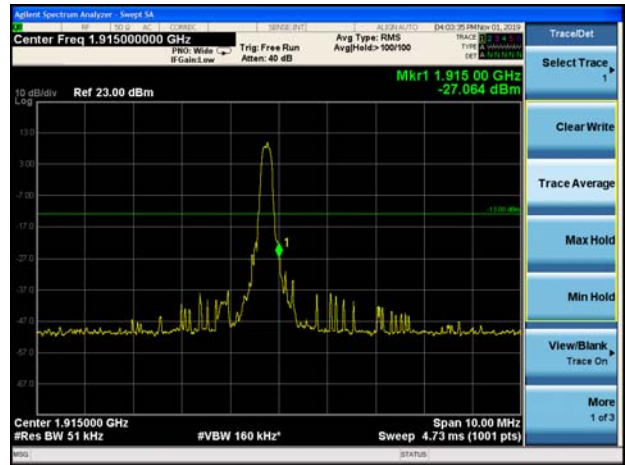

LTE Band 25 1.4MHz 16QAM 100%RB CH-Low

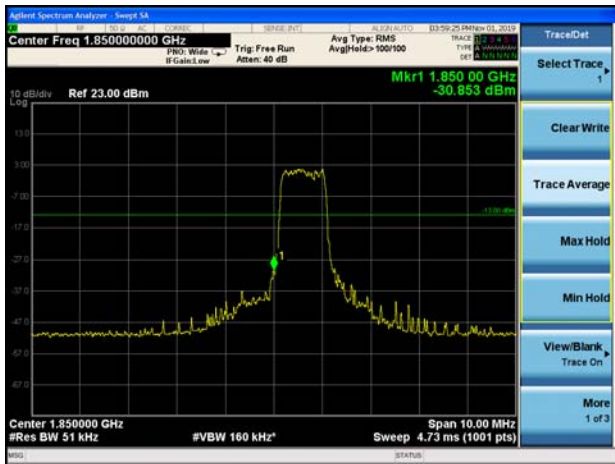

LTE Band 25 1.4MHz 16QAM 100%RB CH-High

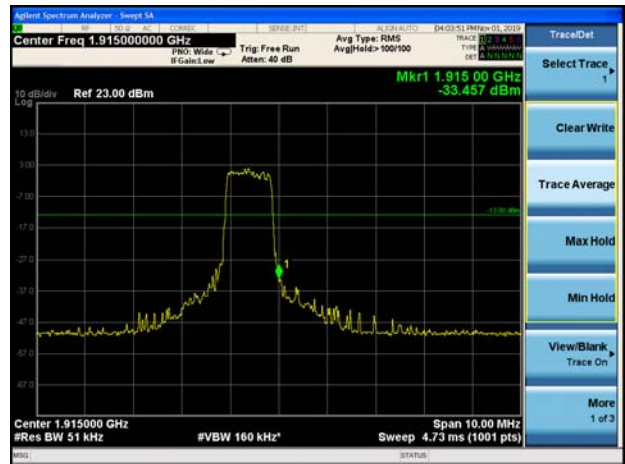

LTE Band 25 3MHz 16QAM 1RB CH-Low

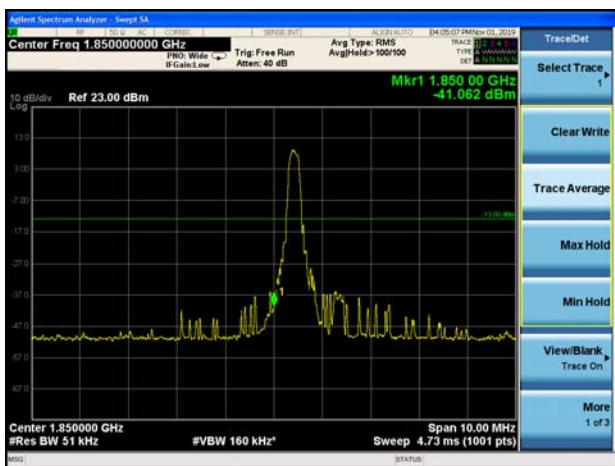

LTE Band 25 3MHz 16QAM 1RB CH-High

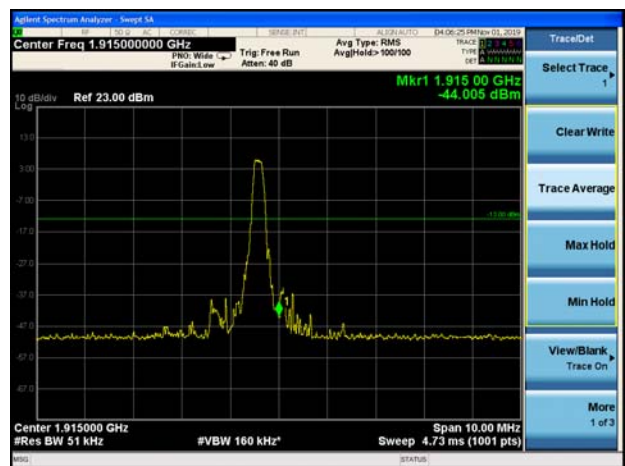



LTE Band 25 3MHz 16QAM 100%RB CH-Low

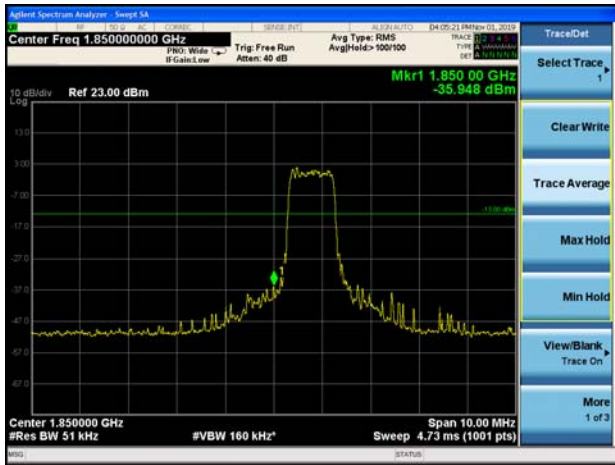

LTE Band 25 3MHz 16QAM 100%RB CH-High



LTE Band 25 5MHz 16QAM 1RB CH-Low

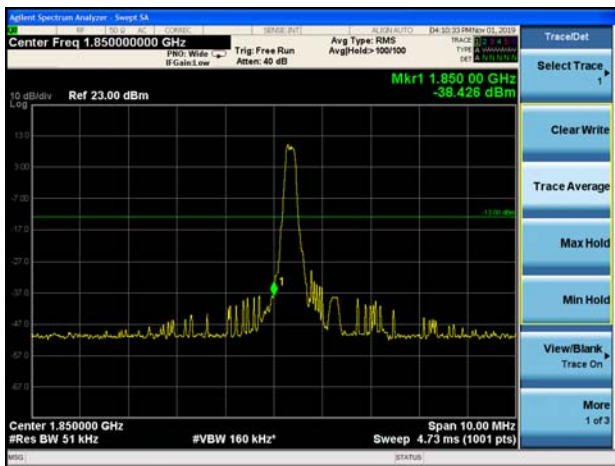

LTE Band 25 5MHz 16QAM 1RB CH-High

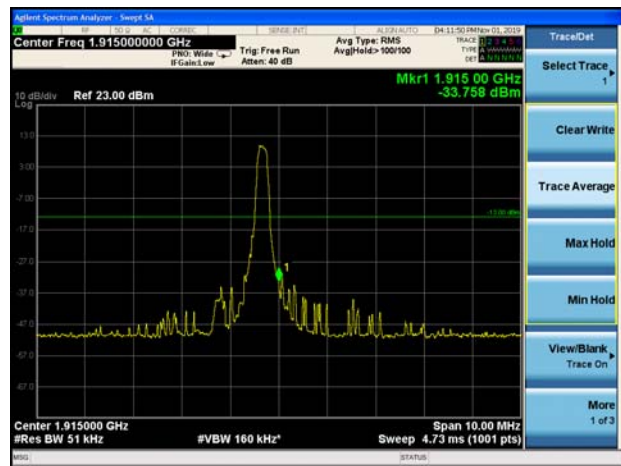

LTE Band 25 5MHz 16QAM 100%RB CH-Low

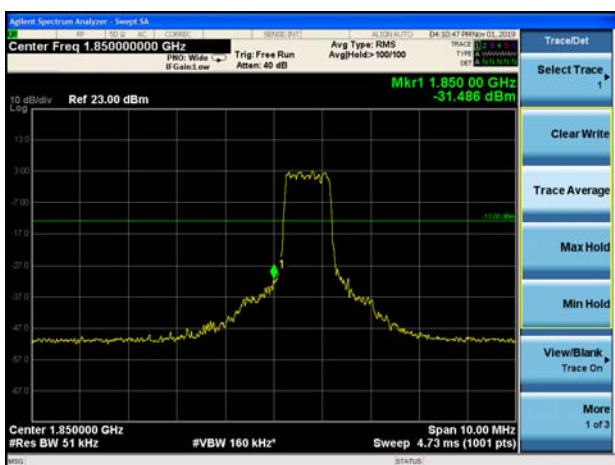

LTE Band 25 5MHz 16QAM 100%RB CH-High

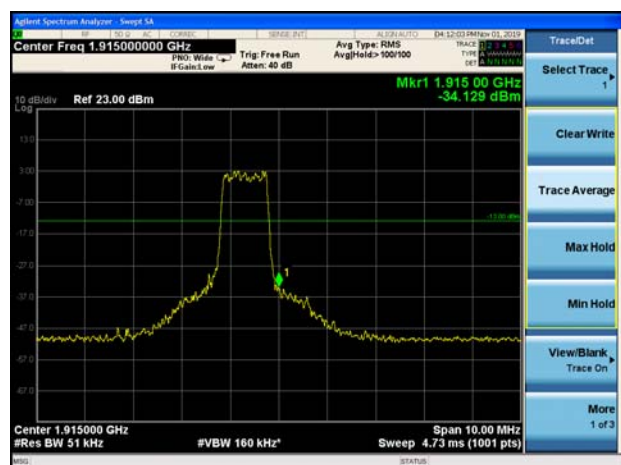

LTE Band 25 10MHz 16QAM 1RB CH-Low

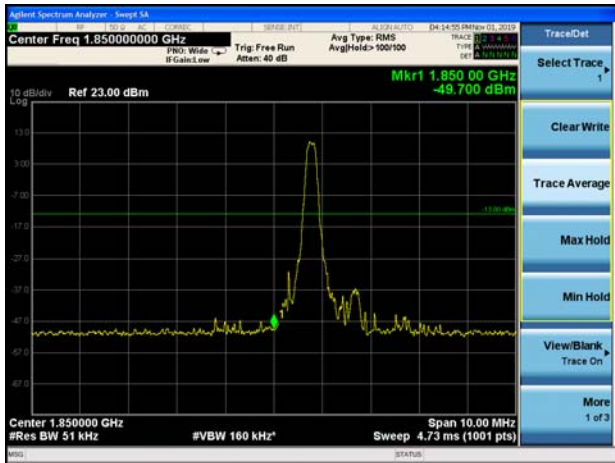

LTE Band 25 10MHz 16QAM 1RB CH-High

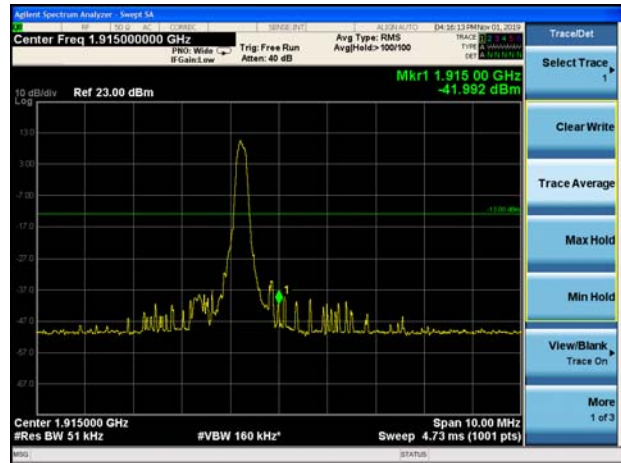

LTE Band 25 10MHz 16QAM 100%RB CH-Low

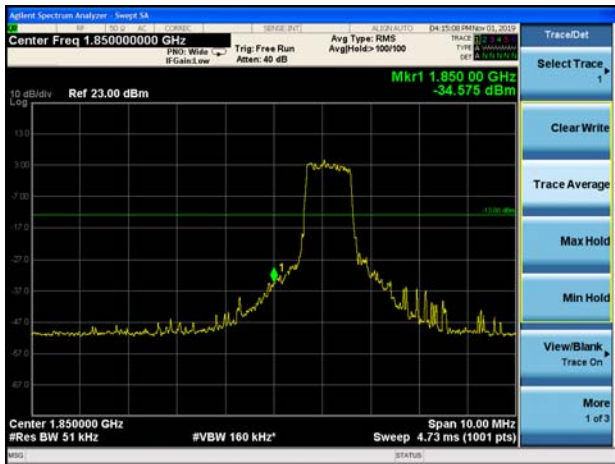

LTE Band 25 10MHz 16QAM 100%RB CH-High

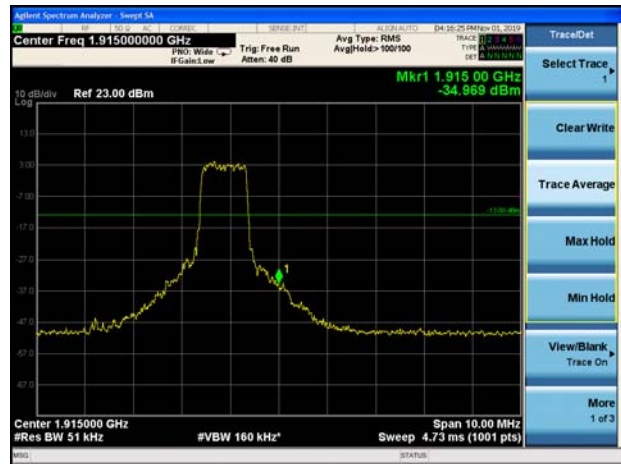

LTE Band 25 15MHz 16QAM 1RB CH-Low

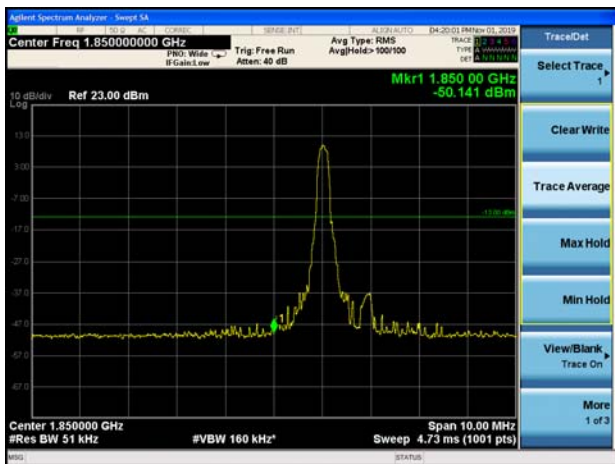

LTE Band 25 15MHz 16QAM 1RB CH-High

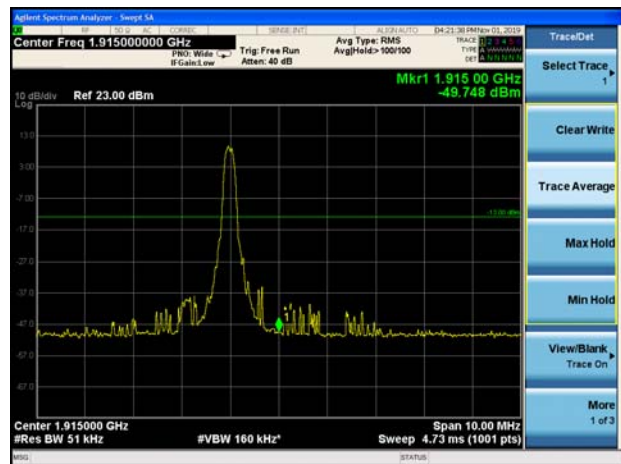



LTE Band 25 15MHz 16QAM 100%RB CH-Low

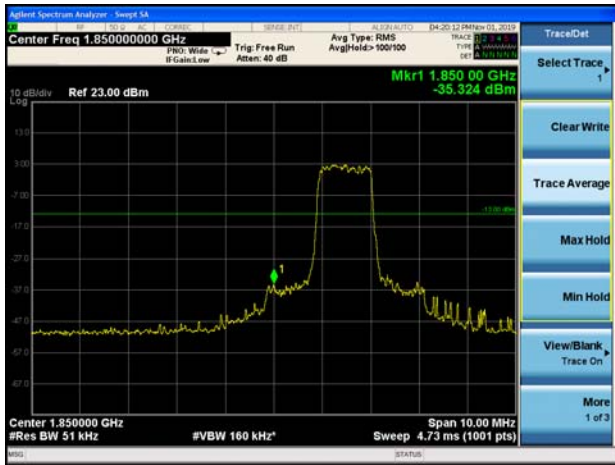

LTE Band 25 15MHz 16QAM 100%RB CH-High



LTE Band 25 20MHz 16QAM 1RB CH-Low

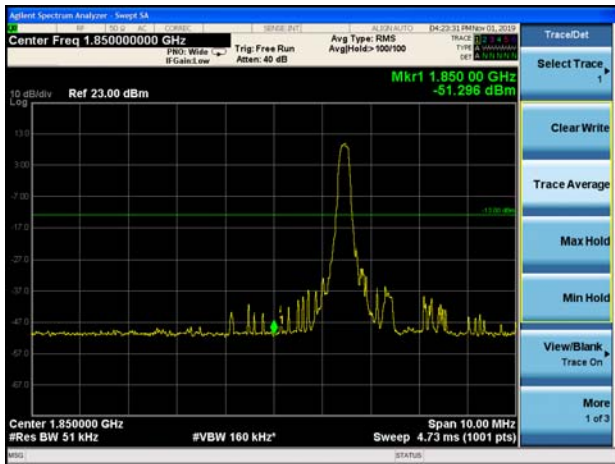

LTE Band 25 20MHz 16QAM 1RB CH-High



LTE Band 25 20MHz 16QAM 100%RB CH-Low

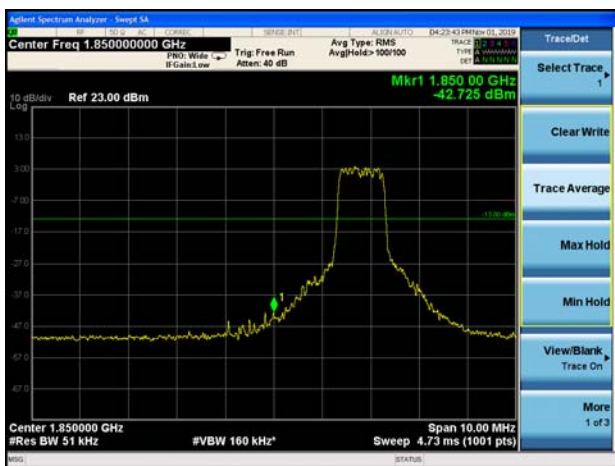

LTE Band 25 20MHz 16QAM 100%RB CH-High

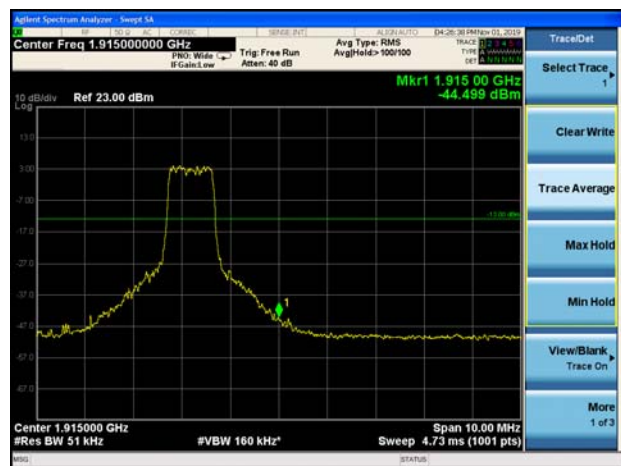

5.6. Peak-to-Average Power Ratio (PAPR)

Ambient condition

Temperature	Relative humidity	Pressure
23°C ~25°C	45%~50%	101.5kPa

Methods of Measurement

Measure the total peak power and record as PPk. And measure the total average power and record as PAvg. Both the peak and average power levels must be expressed in the same logarithmic units (e.g., dBm). Determine the PAPR from:

$$PAPR (dB) = PPk (dBm) - PAvg (dBm).$$

Test Setup

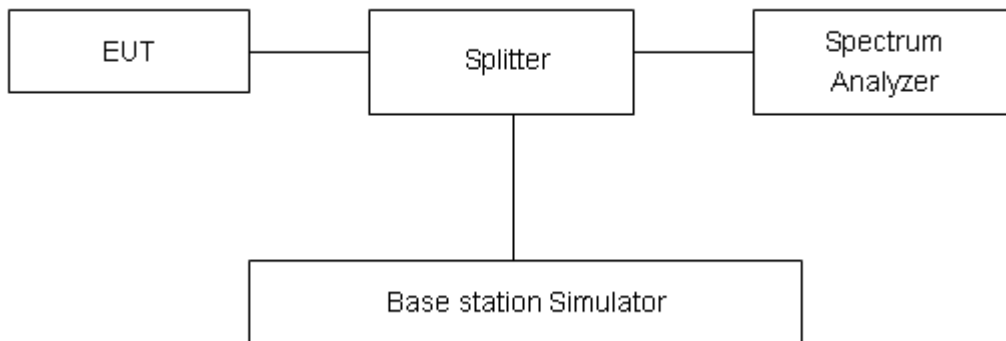

Limits

In measuring transmissions in this band using an average power technique, the peak-to-average ratio (PAR) of the transmission may not exceed 13 dB in 24.232(d).

Measurement Uncertainty

The assessed measurement uncertainty to ensure 95% confidence level for the normal distribution is with the coverage factor $k = 2$, $U = 0.4$ dB.

Test Results

Mode	Bandwidth	Modulation	Channel/ Frequency(MHz)	Peak-to-Average Power Ratio (PAPR)		
				Peak(dBm)	Avg(dBm)	PAPR(dB)
Band2	1.4MHz	QPSK	18900/1880	24.10	14.18	9.92
		16QAM	18900/1880	24.74	14.41	10.33
	3MHz	QPSK	18900/1880	24.00	13.96	10.04
		16QAM	18900/1880	24.69	14.10	10.59
	5MHz	QPSK	18900/1880	24.76	15.02	9.74
		16QAM	18900/1880	25.35	14.76	10.59
	10MHz	QPSK	18900/1880	24.74	15.50	9.24
		16QAM	18900/1880	25.86	16.62	9.24
	15MHz	QPSK	18900/1880	25.28	15.10	10.18
		16QAM	18900/1880	25.83	16.40	9.43
	20MHz	QPSK	18900/1880	25.30	15.83	9.47
		16QAM	18900/1880	25.82	16.35	9.47

Mode	Bandwidth	Modulation	Channel/ Frequency(MHz)	Peak-to-Average Power Ratio (PAPR)		
				Peak(dBm)	Avg(dBm)	PAPR(dB)
Ban25	1.4MHz	QPSK	26365/1882.5	24.00	12.91	11.09
		16QAM	26365/1882.5	24.91	13.21	11.70
	3MHz	QPSK	26365/1882.5	23.96	12.68	11.28
		16QAM	26365/1882.5	24.77	13.35	11.42
	5MHz	QPSK	26365/1882.5	24.90	15.89	9.01
		16QAM	26365/1882.5	25.43	15.43	10.00
	10MHz	QPSK	26365/1882.5	24.80	15.29	9.51
		16QAM	26365/1882.5	25.82	16.31	9.51
	15MHz	QPSK	26365/1882.5	25.35	16.04	9.31
		16QAM	26365/1882.5	25.78	14.98	10.80
	20MHz	QPSK	26365/1882.5	25.26	15.14	10.12
		16QAM	26365/1882.5	25.76	15.16	10.60

5.7. Frequency Stability

Ambient condition

Temperature	Relative humidity	Pressure
23°C ~25°C	45%~50%	101.5kPa

Method of Measurement

Frequency Stability (Temperature Variation)

The temperature inside the climate chamber is varied from -40°C to +85°C in 10°C step size,

(1) With all power removed, the temperature was decreased to 0°C and permitted to stabilize for three hours.

(2) Measure the carrier frequency with the test equipment in a “call mode”. These measurements should be made within 1 minute of powering up the mobile station, to prevent significant self warming.

(3) Repeat the above measurements at 10°C increments from -40°C to +85°C. Allow at least 1.5 hours at each temperature, un-powered, before making measurements.

Frequency Stability (Voltage Variation)

The frequency stability shall be measured with variation of primary supply voltage as follows:

(1) Vary primary supply voltage from 85 to 115 percent of the nominal value for other than hand carried battery equipment.

(2) For hand carried, battery powered equipment, reduce primary supply voltage to the battery-operating end point which shall be specified by the manufacturer.

This transceiver is specified to operate with an input voltage of between 2.6 V and 4.8V, with a nominal voltage of 3.3V.

Test setup

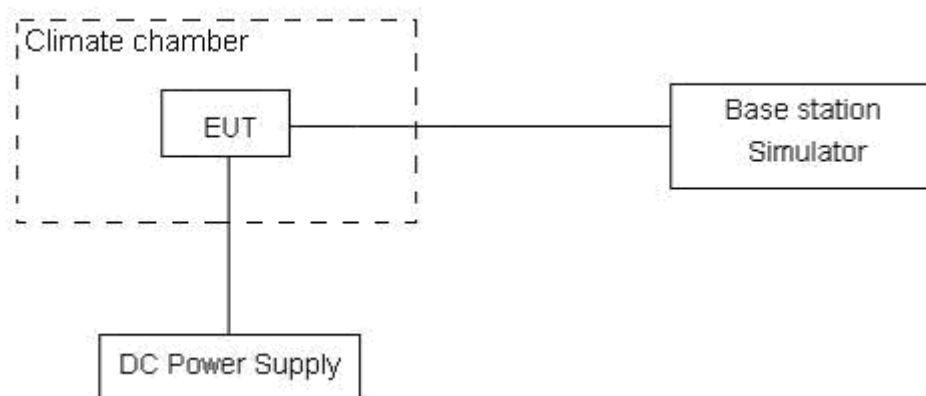

**Limits**

The frequency stability shall be sufficient to ensure that the fundamental emission stays within the authorized frequency block

Measurement Uncertainty

The assessed measurement uncertainty to ensure 99.75% confidence level for the normal distribution is with the coverage factor $k = 3$, $U = 0.01\text{ppm}$.

Test Result

LTE Band 2						
Condition		Freq.Error (Hz)	Freq.Error (Hz)	Frequency Stability (ppm)	Frequency Stability (ppm)	Verdict
BANDWIDTH	20MHz	16QAM	QPSK	16QAM	QPSK	
Temperature	Voltage	16QAM	QPSK	16QAM	QPSK	
Normal (25°C)	Normal	3.80	16.47	0.00202	0.00876	PASS
Extreme (85°C)		4.81	8.98	0.00256	0.00478	PASS
Extreme (80°C)		2.26	2.83	0.00120	0.00150	PASS
Extreme (70°C)		10.31	12.05	0.00549	0.00641	PASS
Extreme (60°C)		13.01	12.99	0.00692	0.00691	PASS
Extreme (50°C)		17.11	13.82	0.00910	0.00735	PASS
Extreme (40°C)		9.35	7.06	0.00497	0.00376	PASS
Extreme (30°C)		7.63	13.50	0.00406	0.00718	PASS
Extreme (20°C)		1.53	3.88	0.00081	0.00206	PASS
Extreme (10°C)		2.60	13.29	0.00138	0.00707	PASS
Extreme (0°C)		17.51	15.96	0.00931	0.00849	PASS
Extreme (-10°C)		1.02	17.40	0.00054	0.00925	PASS
Extreme (-20°C)		3.88	5.48	0.00206	0.00291	PASS
Extreme (-30°C)		14.75	13.92	0.00785	0.00740	PASS
Extreme (-40°C)		1.23	7.50	0.00065	0.00399	PASS
25°C	LV	9.50	11.44	0.00505	0.00609	PASS
	HV	9.55	2.58	0.00508	0.00137	PASS

LTE Band 25						
Condition		Freq.Error (Hz)	Freq.Error (Hz)	Frequency Stability (ppm)	Frequency Stability (ppm)	Verdict
BANDWIDTH	20MHz	16QAM	QPSK	16QAM	QPSK	
Temperature	Voltage	16QAM	QPSK	16QAM	QPSK	
Normal (25°C)	Normal	4.80	9.39	0.00255	0.00499	PASS
Extreme (85°C)		4.47	4.39	0.00238	0.00233	PASS
Extreme (80°C)		15.15	12.65	0.00806	0.00673	PASS
Extreme (70°C)		3.16	7.96	0.00168	0.00424	PASS
Extreme (60°C)		8.05	1.67	0.00428	0.00089	PASS
Extreme (50°C)		5.50	1.86	0.00293	0.00099	PASS
Extreme (40°C)		15.34	4.92	0.00816	0.00261	PASS
Extreme (30°C)		16.78	4.86	0.00893	0.00259	PASS
Extreme (20°C)		12.70	3.98	0.00676	0.00212	PASS
Extreme (10°C)		7.73	7.21	0.00411	0.00384	PASS
Extreme (0°C)		16.92	12.52	0.00900	0.00666	PASS
Extreme (-10°C)		12.31	10.24	0.00655	0.00545	PASS
Extreme (-20°C)		10.62	4.66	0.00565	0.00248	PASS
Extreme (-30°C)		3.04	17.39	0.00162	0.00925	PASS
Extreme (-40°C)		12.29	13.40	0.00654	0.00713	PASS
25°C	LV	7.24	9.20	0.00385	0.00489	PASS
	HV	13.29	12.31	0.00707	0.00655	PASS

5.8. Spurious Emissions at Antenna Terminals

Ambient condition

Temperature	Relative humidity	Pressure
23°C ~25°C	45%~50%	101.5kPa

Method of Measurement

The EUT was connected to Spectrum Analyzer and Base Station Simulator via power Splitter. The measurement is carried out using a spectrum analyzer. The spectrum analyzer scans from 9kHz to the 10th harmonic of the carrier. The peak detector is used.

RBW is set to 100kHz, VBW is set to 300kHz for 30MHz~1GHz

RBW is set to 1MHz, VBW is set to 3MHz for above 1GHz, Sweep is set to ATUO.

The modulation mode and RB allocation refer to section 5.1, using the maximum output power configuration.

Test setup

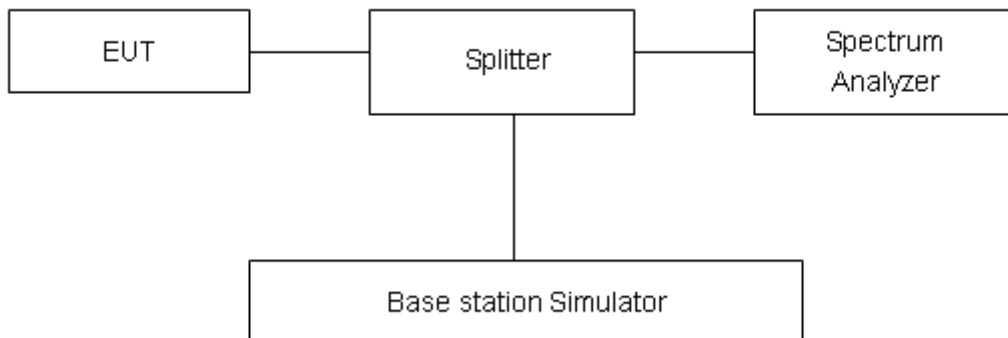

Limits

Rule Part 24.238(a) specifies that “on any frequency outside a licensee's frequency block, the power of any emission shall be attenuated below the transmitter power (P) by at least 43 + 10 log₁₀ (P) dB.”

Limit	-13 dBm
-------	---------

Measurement Uncertainty

The assessed measurement uncertainty to ensure 99.75% confidence level for the normal distribution is with the coverage factor $k = 1.96$.

Frequency	Uncertainty
9kHz-1GHz	0.684 dB
1GHz-20GHz	1.407 dB

Test Result

Sweep the whole frequency band through the range from 9kHz to the 10th harmonic of the carrier, the emissions more than 20 dB below the limit are not reported.

The signal beyond the limit is carrier.

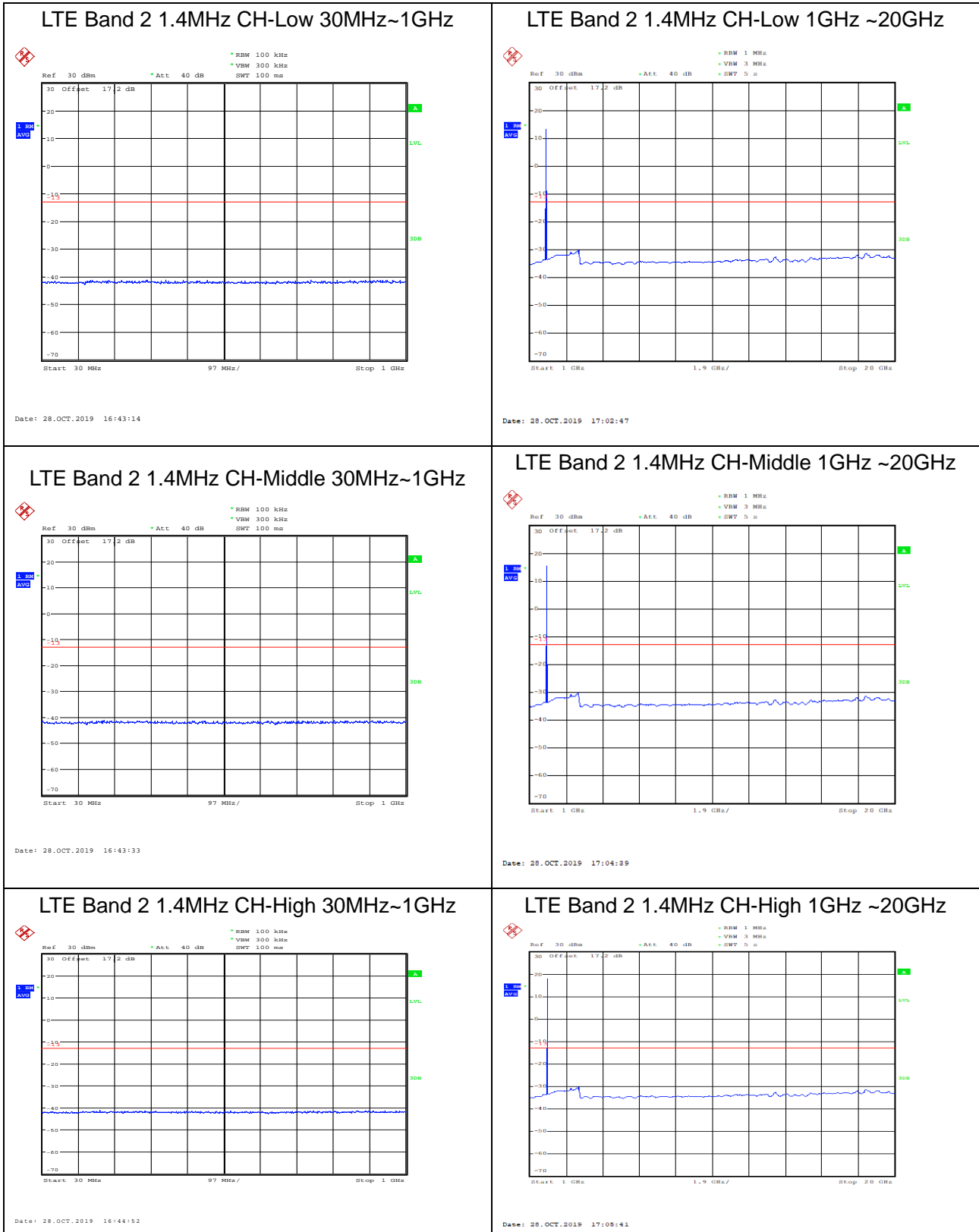



LTE Band 2 3MHz CH-Low 30MHz~1GHz

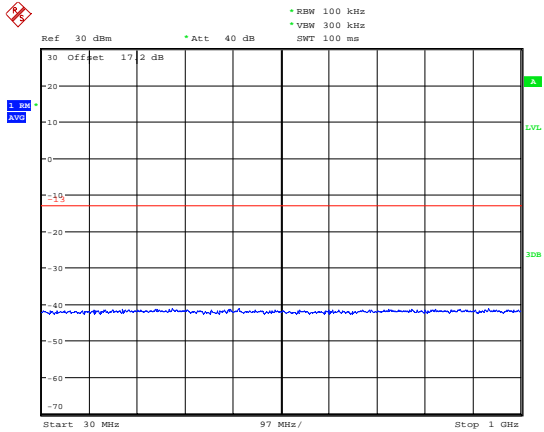

Date: 28.OCT.2019 16:45:57

LTE Band 2 3MHz CH-Low 1GHz ~20GHz

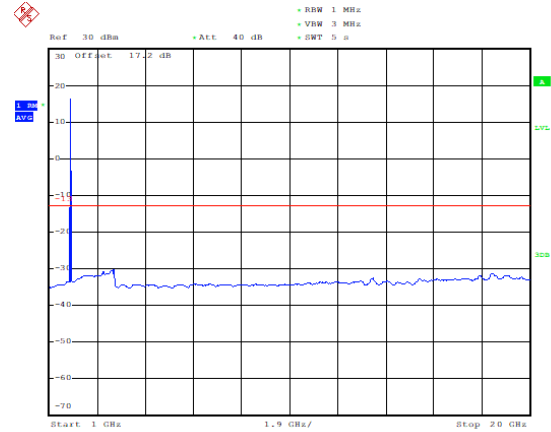

Date: 28.OCT.2019 17:06:59

LTE Band 2 3MHz CH-Middle 30MHz~1GHz

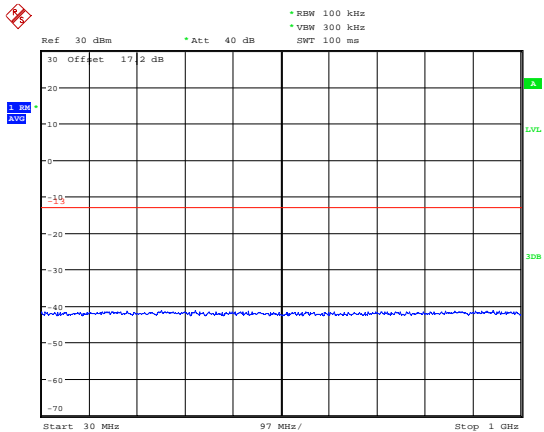

Date: 28.OCT.2019 16:46:17

LTE Band 2 3MHz CH-Middle 1GHz ~20GHz

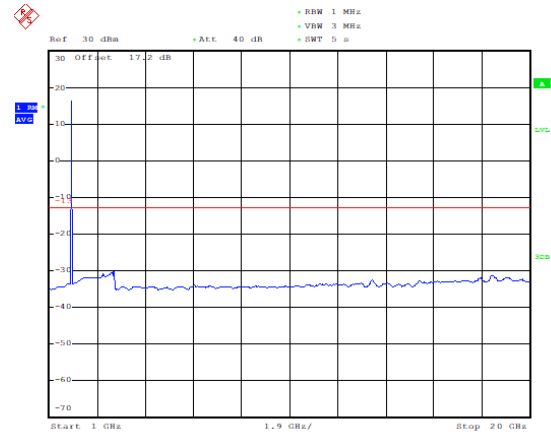

Date: 28.OCT.2019 17:08:28

LTE Band 2 3MHz CH-High 30MHz~1GHz

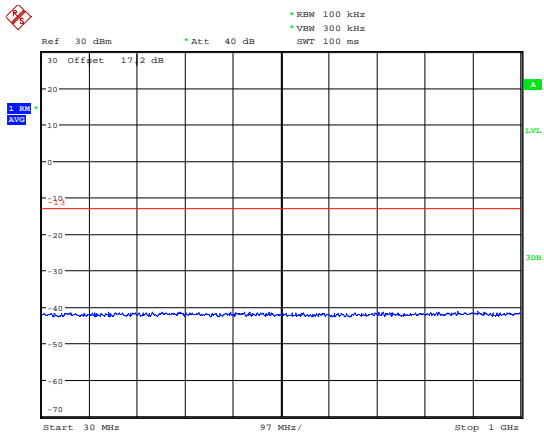

Date: 28.OCT.2019 16:47:14

LTE Band 2 3MHz CH-High 1GHz ~20GHz

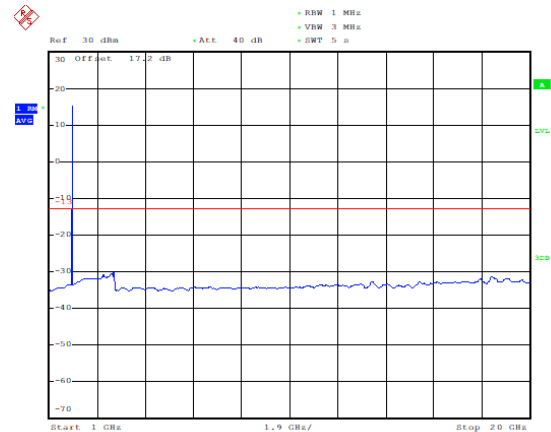

Date: 28.OCT.2019 17:09:14



LTE Band 2 5MHz CH-Low 30MHz~1GHz

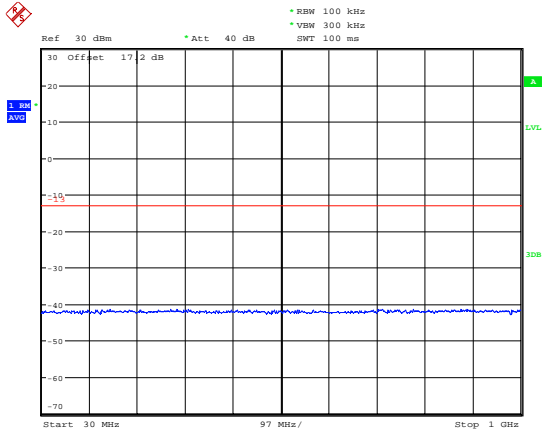

Date: 28.OCT.2019 16:48:04

LTE Band 2 5MHz CH-Low 1GHz ~20GHz

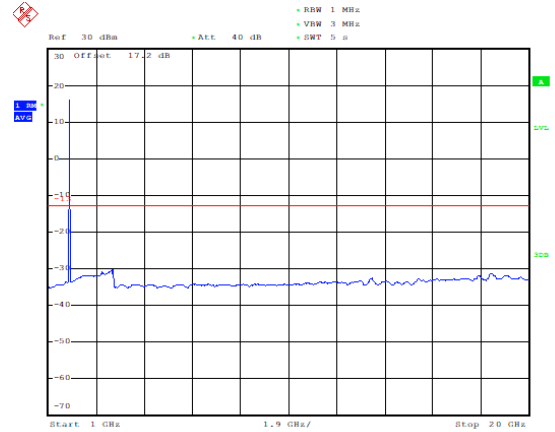

Date: 28.OCT.2019 17:10:19

LTE Band 2 5MHz CH-Middle 30MHz~1GHz

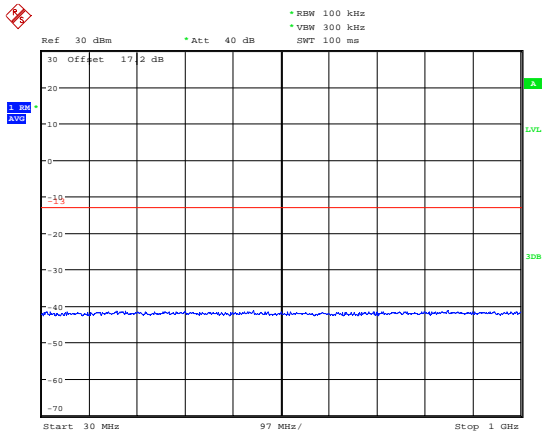

Date: 28.OCT.2019 16:48:22

LTE Band 2 5MHz CH-Middle 1GHz ~20GHz

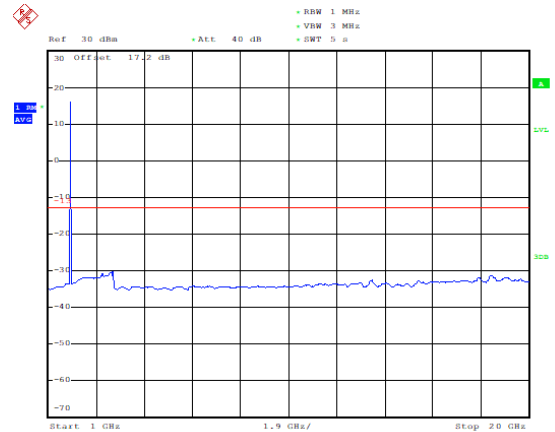

Date: 28.OCT.2019 17:10:46

LTE Band 2 5MHz CH-High 30MHz~1GHz

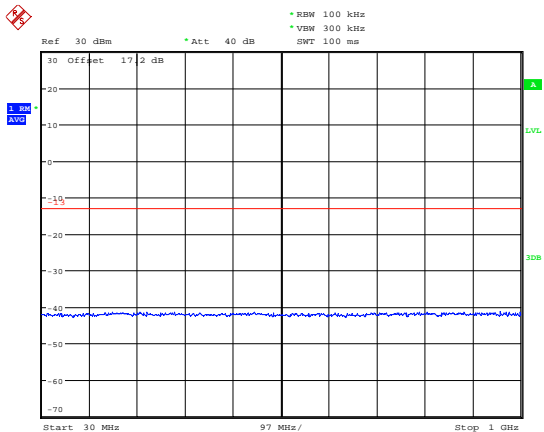

Date: 28.OCT.2019 16:49:37

LTE Band 2 5MHz CH-High 1GHz ~20GHz

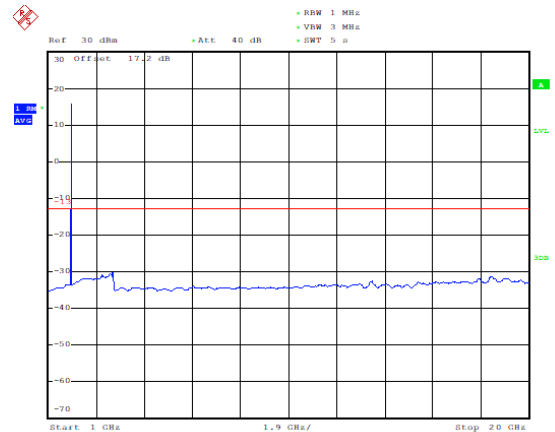

Date: 28.OCT.2019 17:12:09



LTE Band 2 10MHz CH-Low 30MHz~1GHz

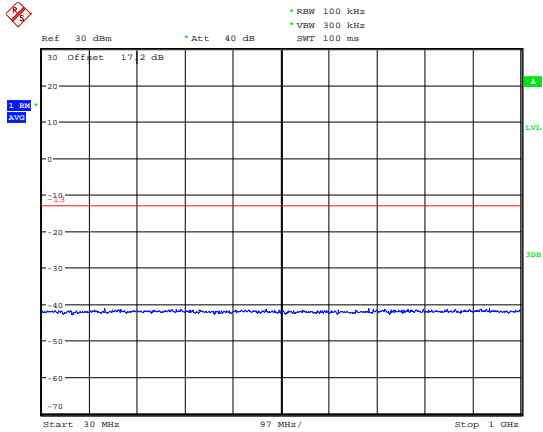

Date: 28.OCT.2019 16:50:17

LTE Band 2 10MHz CH-Low 1GHz ~20GHz

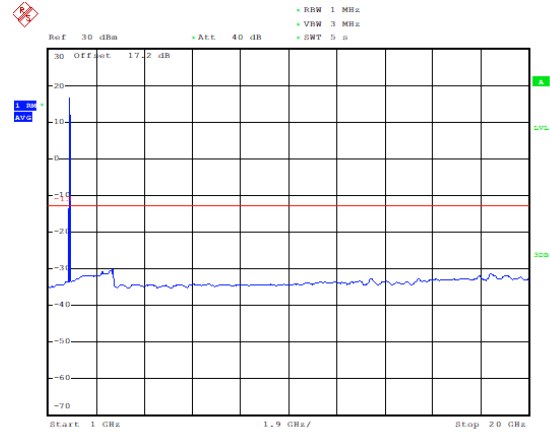

Date: 28.OCT.2019 17:12:25

LTE Band 2 10MHz CH-Middle 30MHz~1GHz

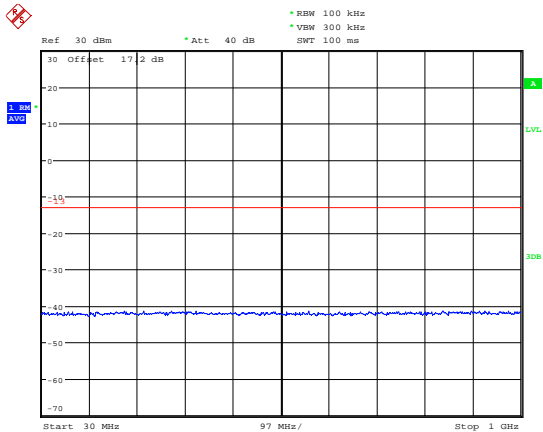

Date: 28.OCT.2019 16:50:43

LTE Band 2 10MHz CH-Middle 1GHz ~20GHz

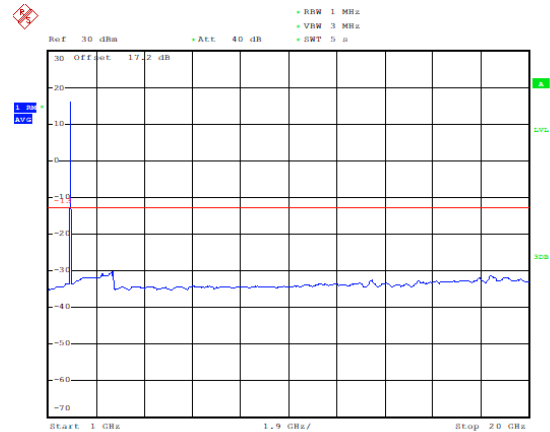

Date: 28.OCT.2019 17:14:07

LTE Band 2 10MHz CH-High 30MHz~1GHz

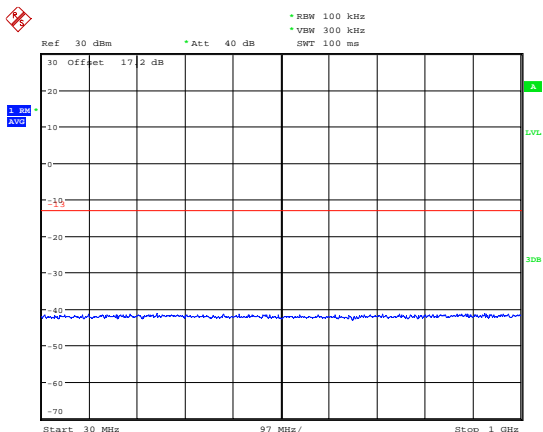

Date: 28.OCT.2019 16:52:31

LTE Band 2 10MHz CH-High 1GHz ~20GHz

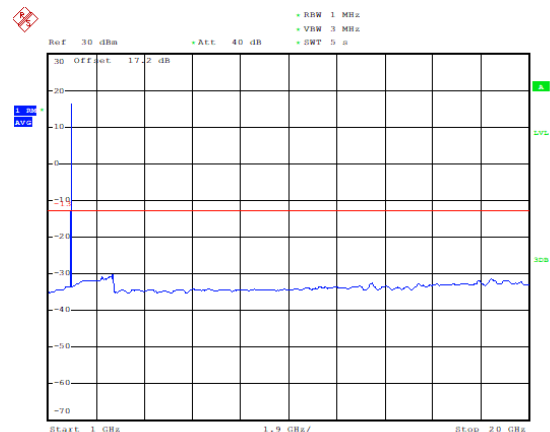

Date: 28.OCT.2019 17:15:52



LTE Band 2 15MHz CH-Low 30MHz~1GHz

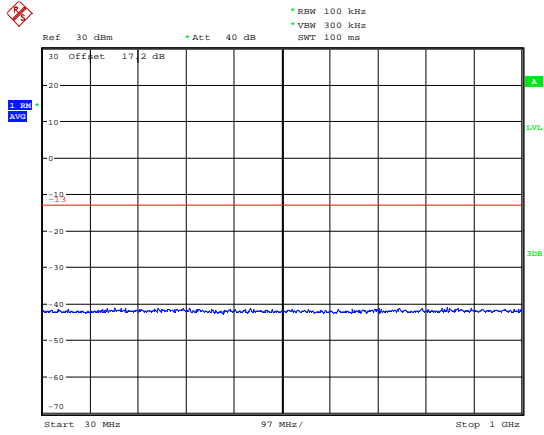

Date: 28.OCT.2019 16:53:08

LTE Band 2 15MHz CH-Low 1GHz ~20GHz

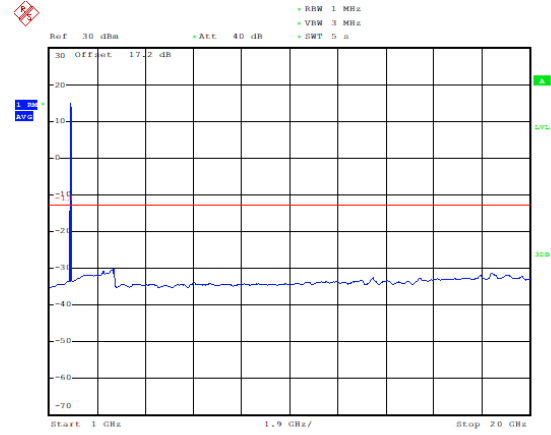

Date: 28.OCT.2019 17:16:33

LTE Band 2 15MHz CH-Middle 30MHz~1GHz

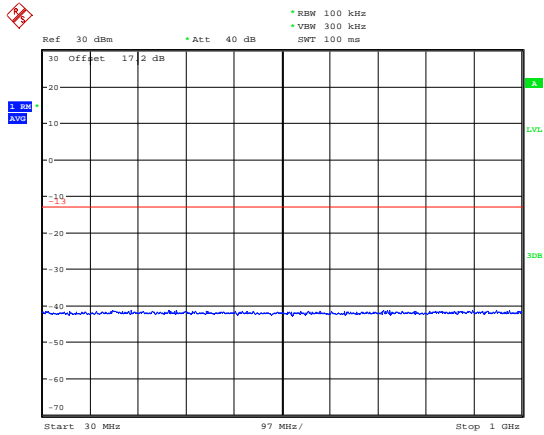

Date: 28.OCT.2019 16:53:29

LTE Band 2 15MHz CH-Middle 1GHz ~20GHz

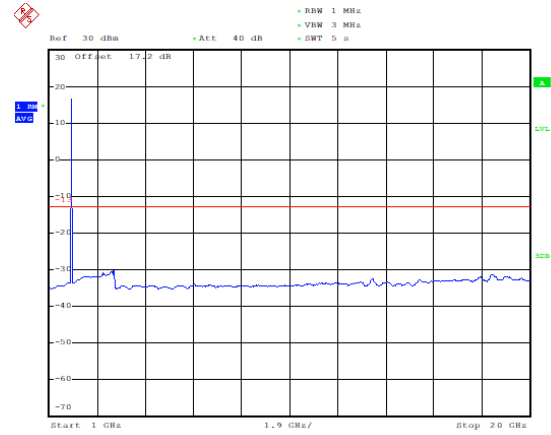

Date: 28.OCT.2019 17:17:05

LTE Band 2 15MHz CH-High 30MHz~1GHz

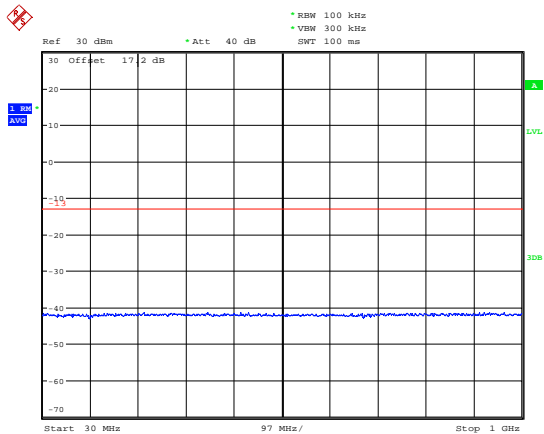

Date: 28.OCT.2019 16:54:59

LTE Band 2 15MHz CH-High 1GHz ~20GHz

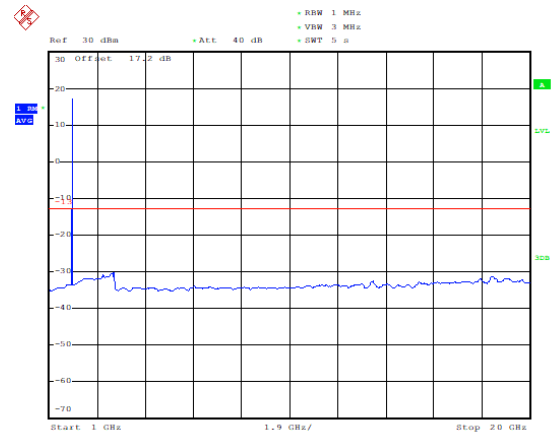

Date: 28.OCT.2019 17:17:38



LTE Band 2 20MHz CH-Low 30MHz~1GHz

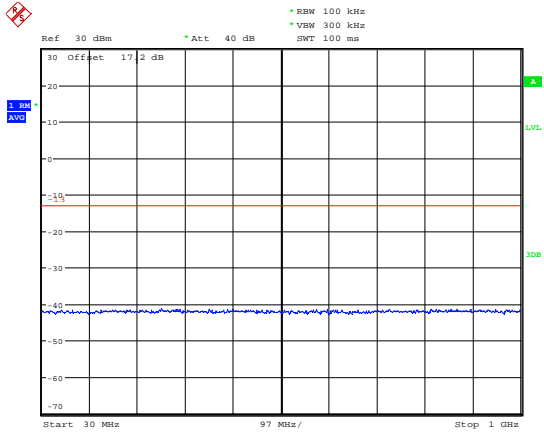

Date: 28.OCT.2019 16:55:26

LTE Band 2 20MHz CH-Low 1GHz ~20GHz

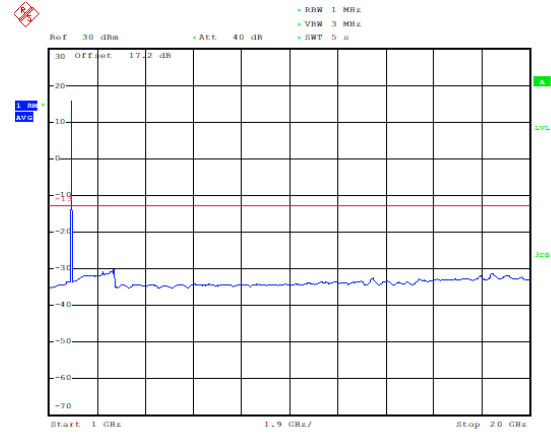

Date: 28.OCT.2019 17:19:10

LTE Band 2 20MHz CH-Middle 30MHz~1GHz

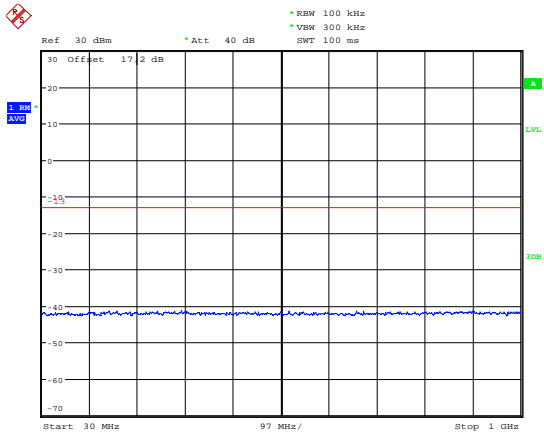

Date: 28.OCT.2019 16:57:05

LTE Band 2 20MHz z CH-Middle 1GHz ~20GHz

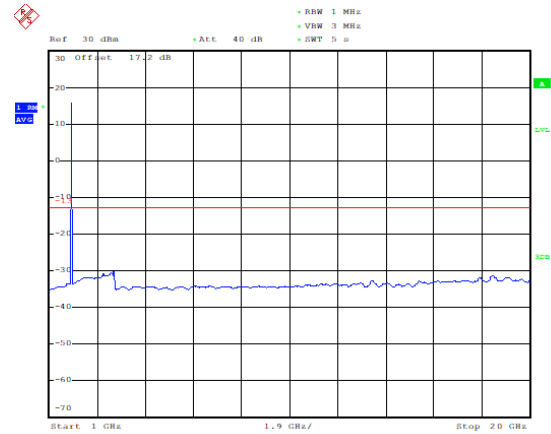

Date: 28.OCT.2019 17:20:24

LTE Band 2 20MHz CH-High 30MHz~1GHz

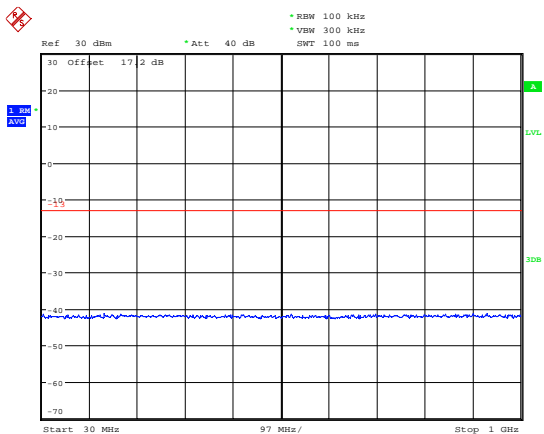

Date: 28.OCT.2019 16:57:24

LTE Band 2 20MHz CH-High 1GHz ~20GHz

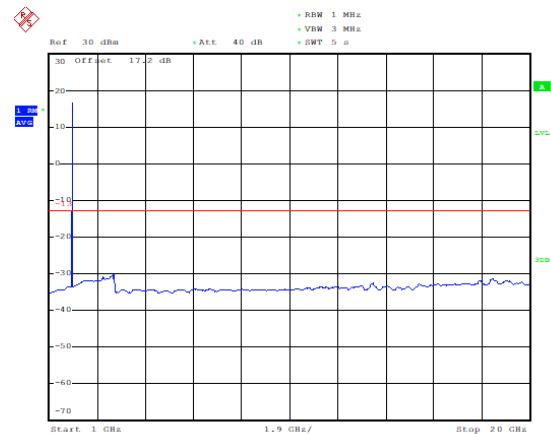

Date: 28.OCT.2019 17:20:50



LTE Band 25 1.4MHz CH-Low 30MHz~1GHz

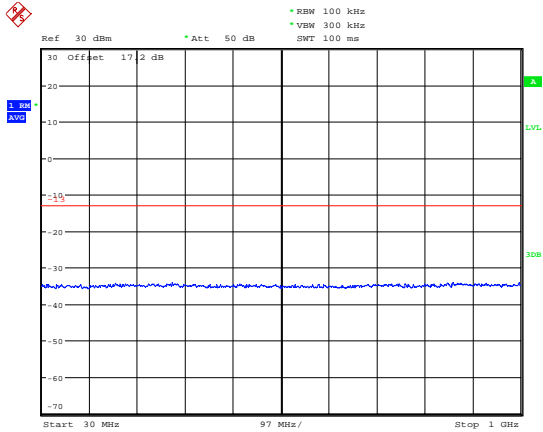

Date: 29.OCT.2019 13:55:22

LTE Band 25 1.4MHz CH-Low 1GHz ~20GHz

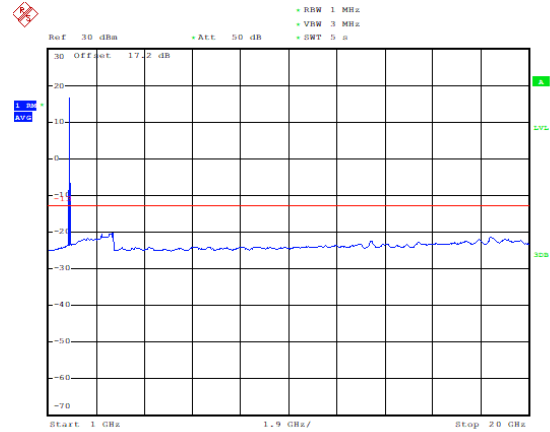

Date: 29.OCT.2019 14:37:51

LTE Band 25 1.4MHz CH-Middle 30MHz~1GHz

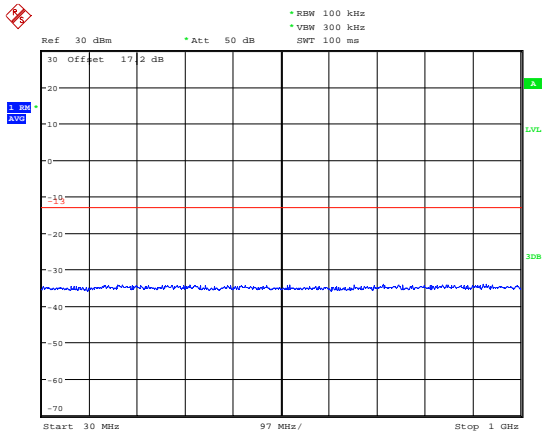

Date: 29.OCT.2019 13:57:25

LTE Band 25 1.4MHz CH-Middle 1GHz ~20GHz

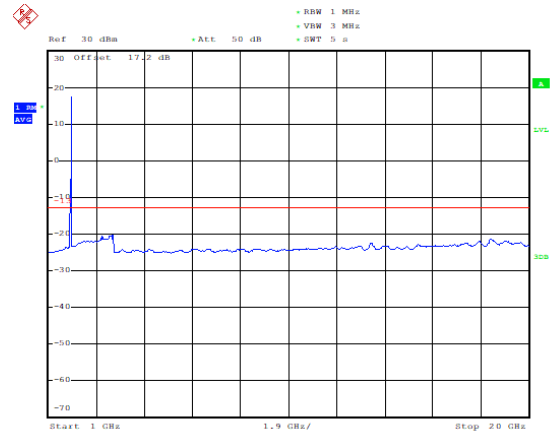

Date: 29.OCT.2019 14:39:40

LTE Band 25 1.4MHz CH-High 30MHz~1GHz

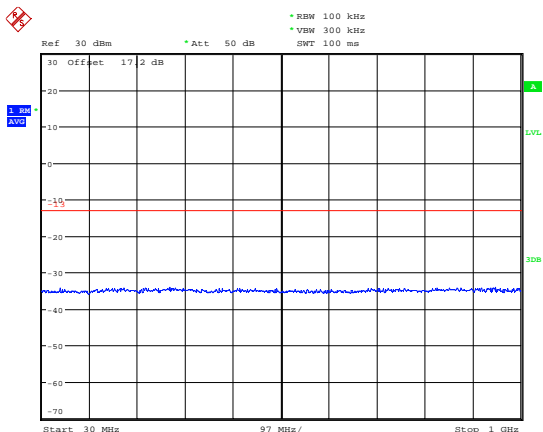

Date: 29.OCT.2019 14:01:38

LTE Band 25 1.4MHz CH-High 1GHz ~20GHz

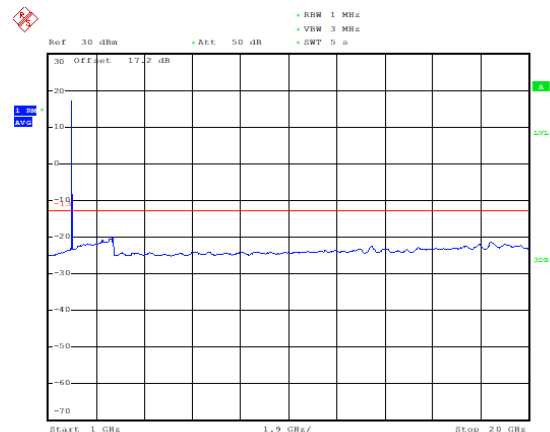

Date: 29.OCT.2019 14:41:27



LTE Band 25 3MHz CH-Low 30MHz~1GHz

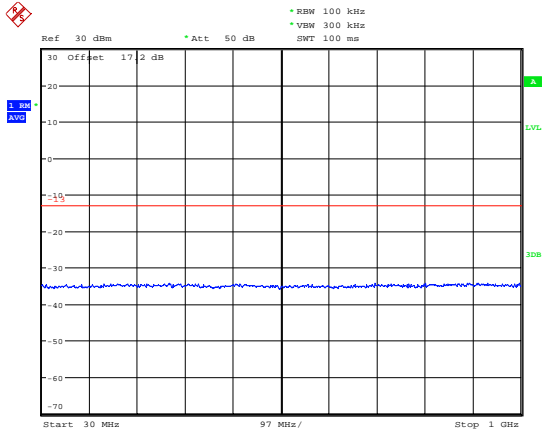

Date: 29.OCT.2019 14:02:03

LTE Band 25 3MHz CH-Low 1GHz ~20GHz

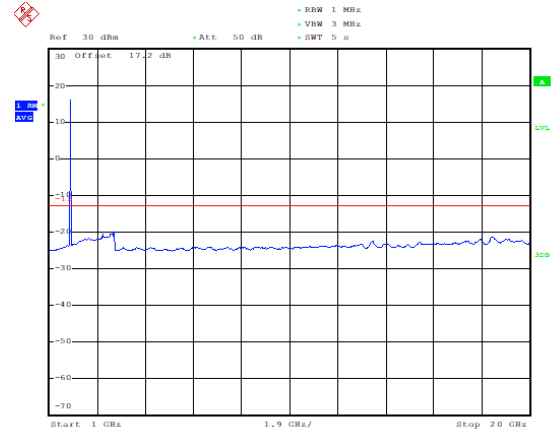

Date: 29.OCT.2019 14:41:57

LTE Band 25 3MHz CH-Middle 30MHz~1GHz

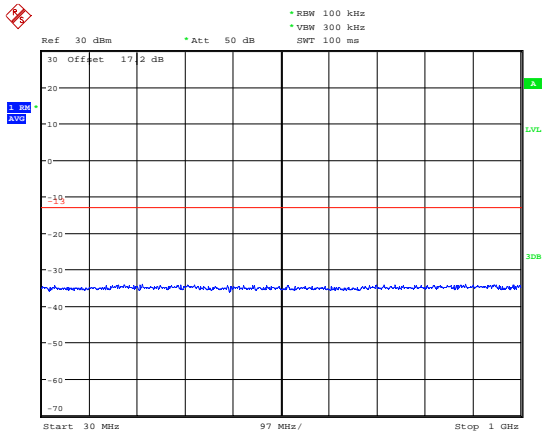

Date: 29.OCT.2019 14:02:22

LTE Band 25 3MHz CH-Middle 1GHz ~20GHz

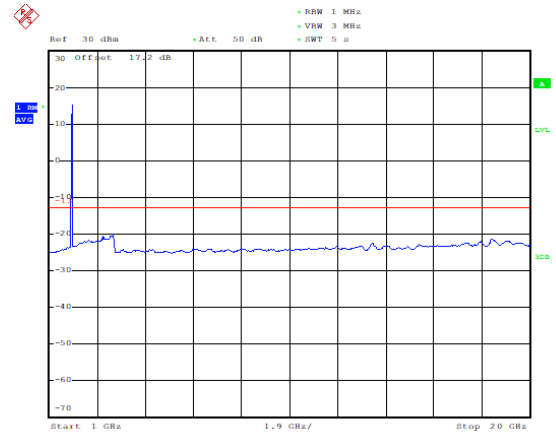

Date: 29.OCT.2019 14:42:19

LTE Band 25 3MHz CH-High 30MHz~1GHz

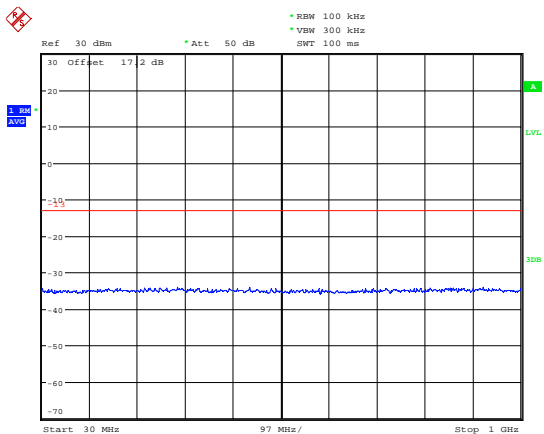

Date: 29.OCT.2019 14:04:26

LTE Band 25 3MHz CH-High 1GHz ~20GHz

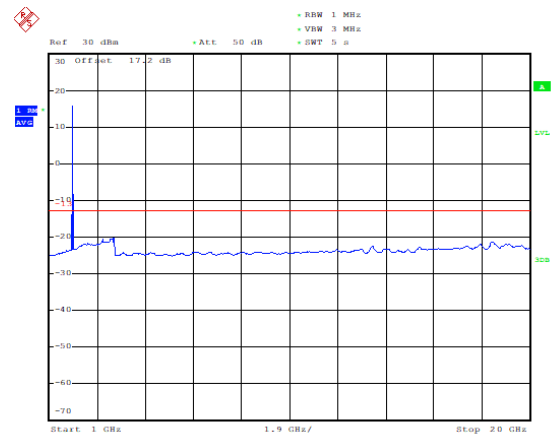

Date: 29.OCT.2019 14:42:49



LTE Band 25 5MHz CH-Low 30MHz~1GHz

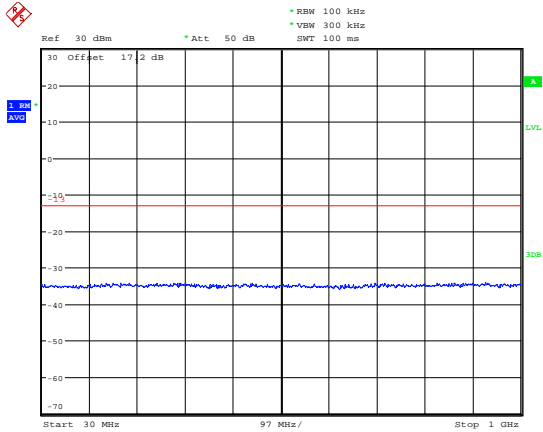

Date: 29.OCT.2019 14:05:26

LTE Band 25 5MHz CH-Low 1GHz ~20GHz

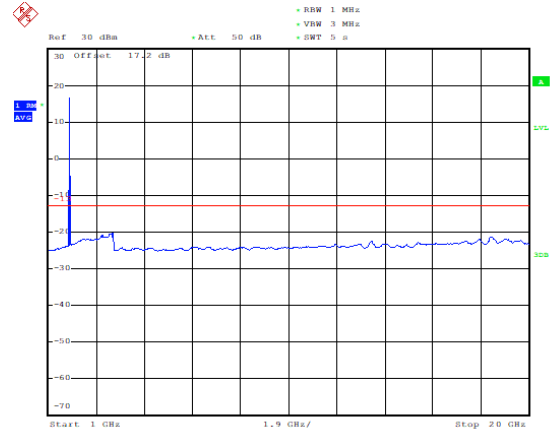

Date: 29.OCT.2019 14:42:38

LTE Band 2 5MHz CH-Middle 30MHz~1GHz

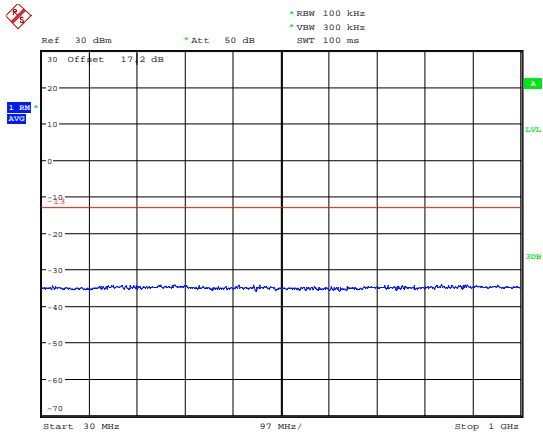

Date: 29.OCT.2019 14:06:34

LTE Band 25 5MHz CH-Middle 1GHz ~20GHz

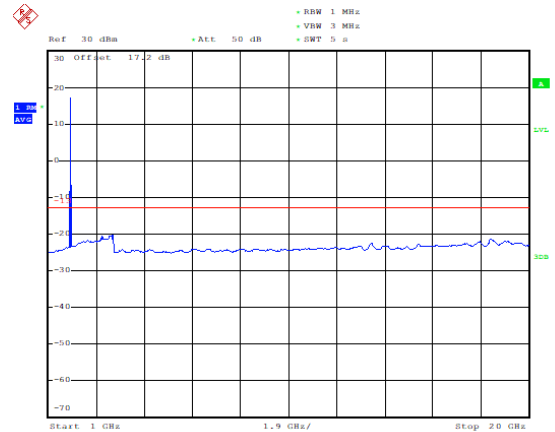

Date: 29.OCT.2019 14:44:10

LTE Band 25 5MHz CH-High 30MHz~1GHz

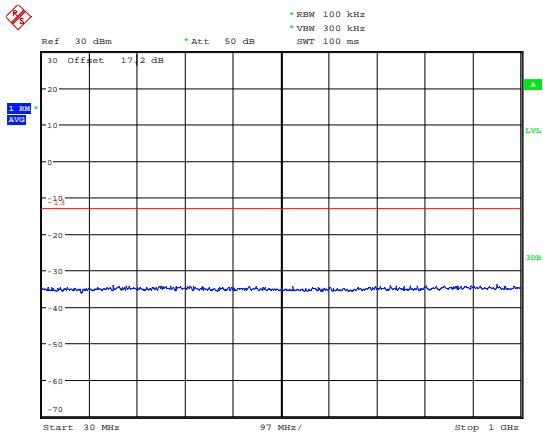

Date: 29.OCT.2019 14:07:50

LTE Band 25 5MHz CH-High 1GHz ~20GHz

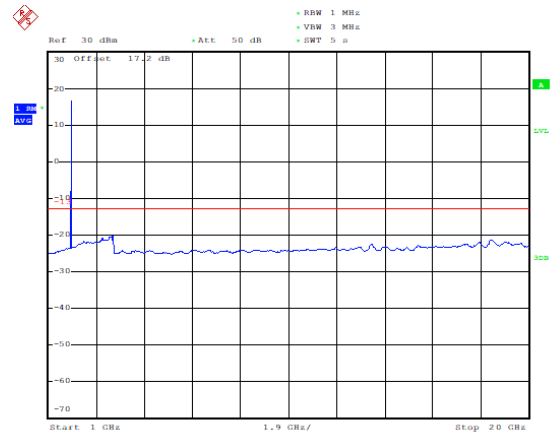

Date: 29.OCT.2019 14:44:33



LTE Band 25 10MHz CH-Low 30MHz~1GHz

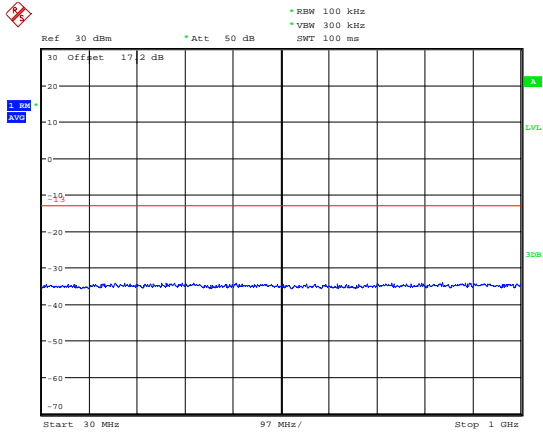

Date: 29.OCT.2019 14:08:48

LTE Band 25 10MHz CH-Low 1GHz ~20GHz

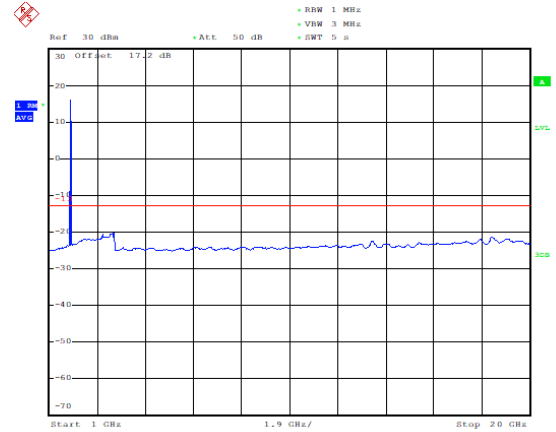

Date: 29.OCT.2019 14:44:59

LTE Band 2 10MHz CH-Middle 30MHz~1GHz

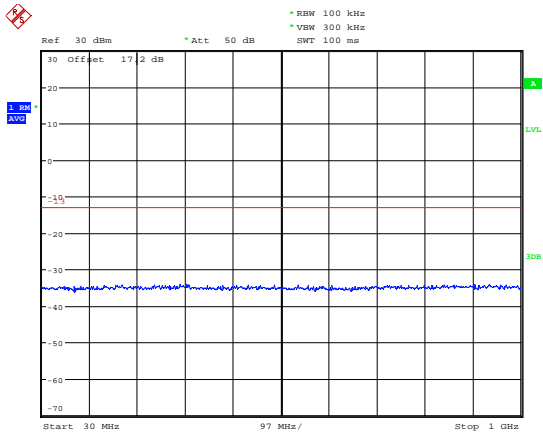

Date: 29.OCT.2019 14:09:06

LTE Band 25 10MHz CH-Middle 1GHz ~20GHz

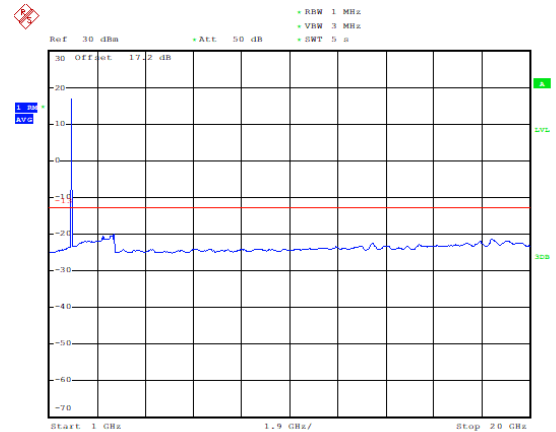

Date: 29.OCT.2019 14:45:22

LTE Band 25 10MHz CH-High 30MHz~1GHz

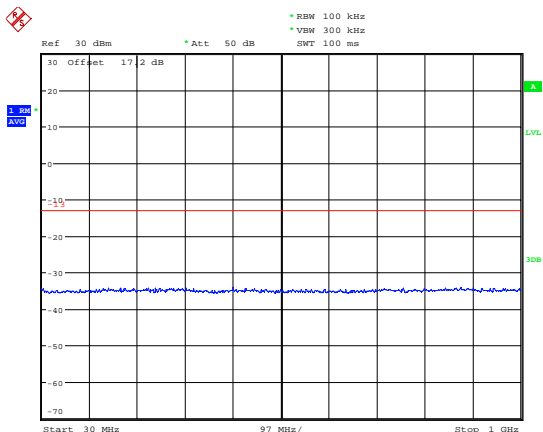

Date: 29.OCT.2019 14:15:44

LTE Band 25 10MHz CH-High 1GHz ~20GHz

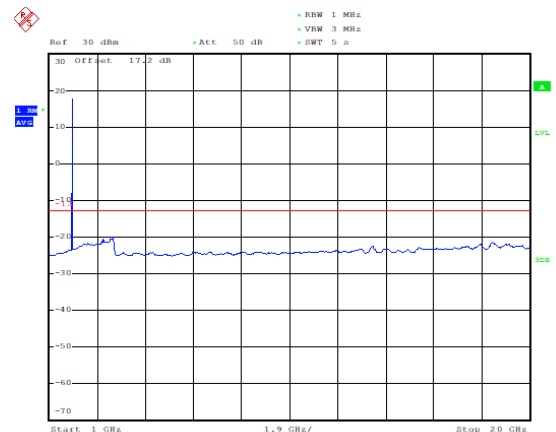

Date: 29.OCT.2019 14:45:51



LTE Band 25 15MHz CH-Low 30MHz~1GHz

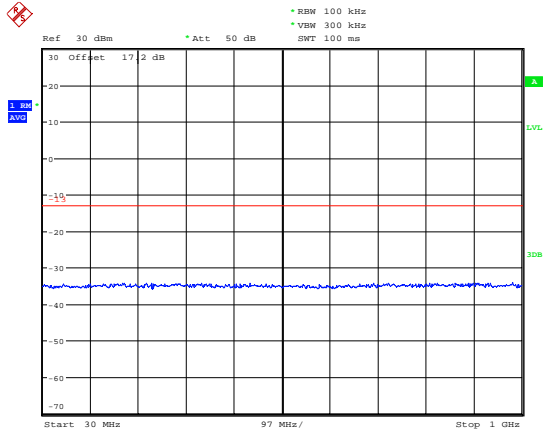

Date: 29.OCT.2019 14:17:09

LTE Band 25 15MHz CH-Low 1GHz ~20GHz

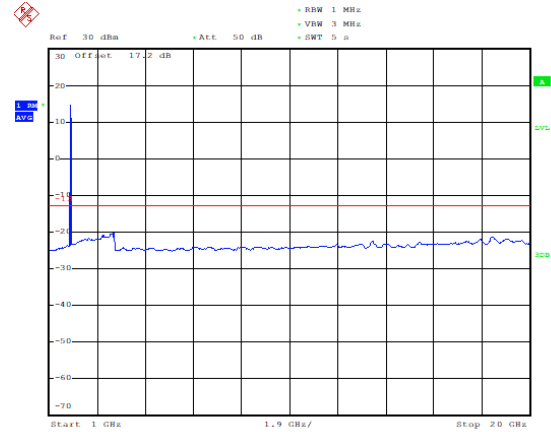

Date: 29.OCT.2019 14:46:15

LTE Band 2 15MHz CH-Middle 30MHz~1GHz

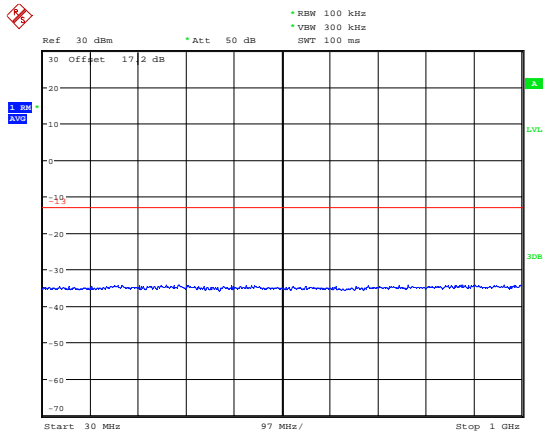

Date: 29.OCT.2019 14:17:46

LTE Band 25 15MHz CH-Middle 1GHz ~20GHz

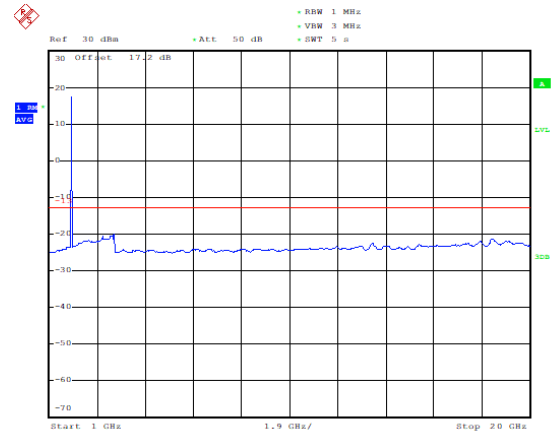

Date: 29.OCT.2019 14:46:35

LTE Band 25 15MHz CH-High 30MHz~1GHz

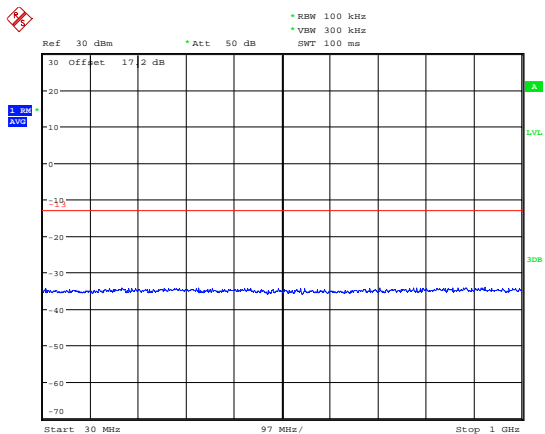

Date: 29.OCT.2019 14:18:18

LTE Band 25 15MHz CH-High 1GHz ~20GHz

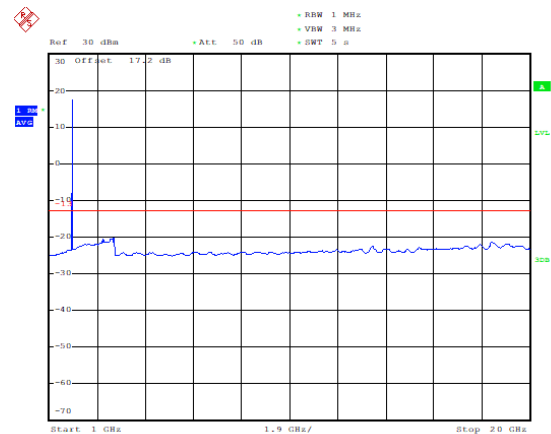

Date: 29.OCT.2019 14:47:02



LTE Band 25 20MHz CH-Low 30MHz~1GHz

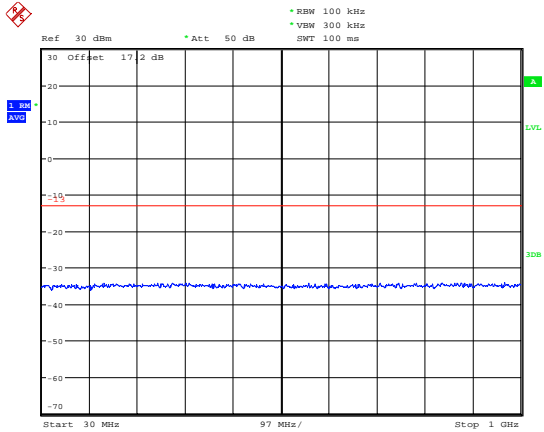

Date: 29.OCT.2019 14:19:04

LTE Band 25 20MHz CH-Low 1GHz ~20GHz

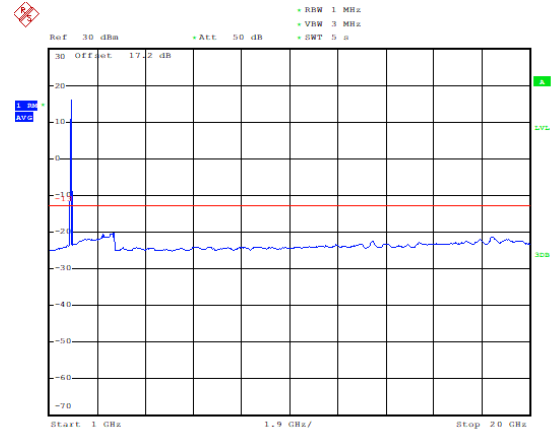

Date: 29.OCT.2019 14:48:02

LTE Band 25 20MHz CH-Middle 30MHz~1GHz

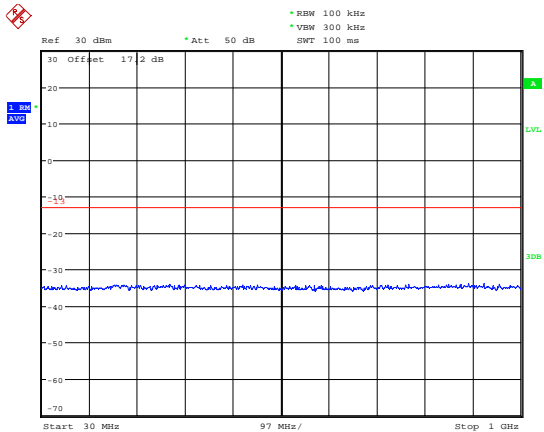

Date: 29.OCT.2019 14:19:22

LTE Band 25 20MHz z CH-Middle 1GHz ~20GHz

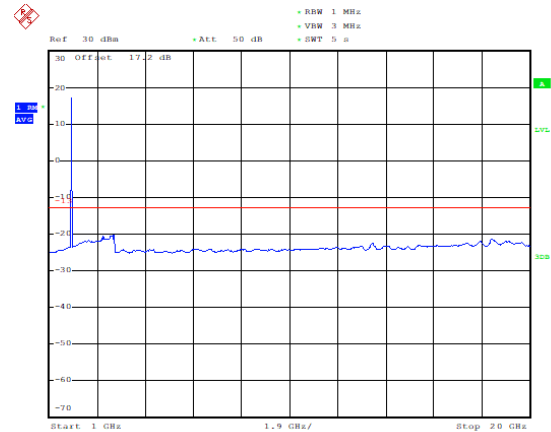

Date: 29.OCT.2019 14:49:38

LTE Band 25 20MHz CH-High 30MHz~1GHz

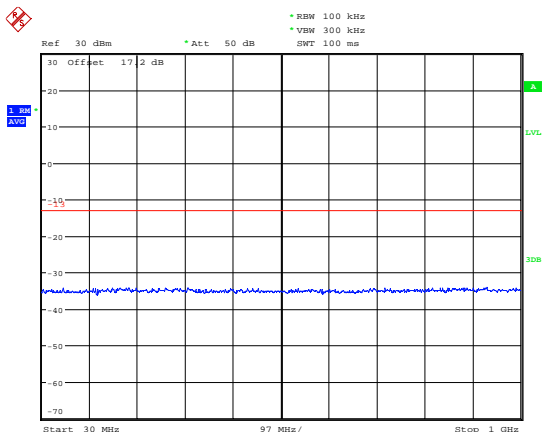

Date: 29.OCT.2019 14:32:33

LTE Band 25 20MHz CH-High 1GHz ~20GHz

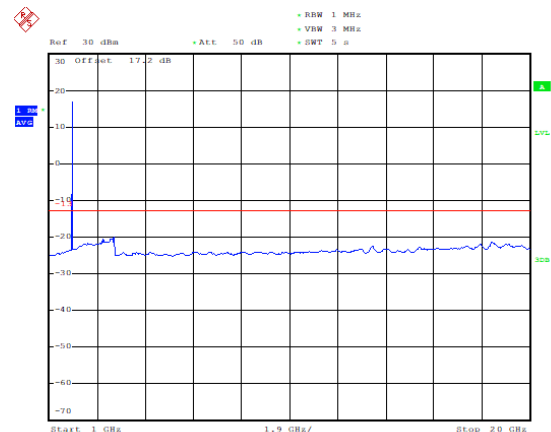

Date: 29.OCT.2019 14:50:41

5.9. Radiates Spurious Emission

Ambient condition

Temperature	Relative humidity	Pressure
23°C ~25°C	45%~50%	101.5kPa

Method of Measurement

1. The testing follows FCC KDB 971168 v03r01 Section 5.8 and ANSI C63.26 (2015).
2. Below 1GHz: The EUT is placed on a turntable 0.8 meters above the ground in the chamber, 3 meter away from the antenna. The maximal emission value is acquired by adjusting the antenna height, polarisation and turntable azimuth. Normally, the height range of antenna is 1 m to 4 m, the azimuth range of turntable is 0° to 360°, and the receive antenna has two polarizations Vertical (V) and Horizontal (H). Above 1GHz: (Note: the FCC's permission to use 1.5m as an alternative per TCBC Conf call of Dec. 2, 2014.) The EUT is placed on a turntable 1.5 meters above the ground in the chamber, 3 meter away from the antenna. The maximal emission value is acquired by adjusting the antenna height, polarisation and turntable azimuth. Normally, the height range of antenna is 1 m to 4 m, the azimuth range of turntable is 0° to 360°, and the receive antenna has two polarizations Vertical (V) and Horizontal (H).
3. A loop antenna, A log-periodic antenna or horn antenna shall be substituted in place of the EUT. The log-periodic antenna will be driven by a signal generator and the level will be adjusted till the same power value on the spectrum analyzer or receiver. The level of the spurious emissions can be calculated through the level of the signal generator, cable loss, the gain of the substitution antenna and the reading of the spectrum analyzer or receiver.
4. The EUT is then put into continuously transmitting mode at its maximum power level during the test. Set Test Receiver or Spectrum RBW=200Hz,VBW=600Hz for 9kHz150kHz , RBW=10kHz, VBW=30kHz 150kHz-30MHz , RBW=100kHz,VBW=300kHz for 30MHz to 1GHz and RBW=1MHz, VBW=3MHz for above 1GHz, And the maximum value of the receiver should be recorded as (Pr).
5. The EUT shall be replaced by a substitution antenna. In the chamber, an substitution antenna for the frequency band of interest is placed at the reference point of the chamber. An RF Signal source for the frequency band of interest is connected to the substitution antenna with a cable that has been constructed to not interfere with the radiation pattern of the antenna. A power (PMea) is applied to the input of the substitution antenna, and adjust the level of the signal generator output until the value of the receiver reach the previously recorded (Pr). The power of signal source (PMea) is recorded. The test should be performed by rotating the test item and adjusting the receiving antenna polarization.
6. A amplifier should be connected to the Signal Source output port. And the cable should be connect between the Amplifier and the Substitution Antenna. The cable loss (Pcl) ,the Substitution Antenna Gain (Ga) and the Amplifier Gain (PAg) should be recorded after test.
7. The measurement results are obtained as described below:
Power(EIRP)=PMea- PAg - Pcl + Ga
The measurement results are amend as described below:
Power(EIRP)=PMea- Pcl + Ga
8. This value is EIRP since the measurement is calibrated using an antenna of known gain (2.15 dBi)

and known input power. ERP can be calculated from EIRP by subtracting the gain of the dipole, $ERP = EIRP - 2.15\text{dBi}$.

The modulation mode and RB allocation refer to section 5.1, using the maximum output power configuration.

Test setup

9KHz ~ 30MHz

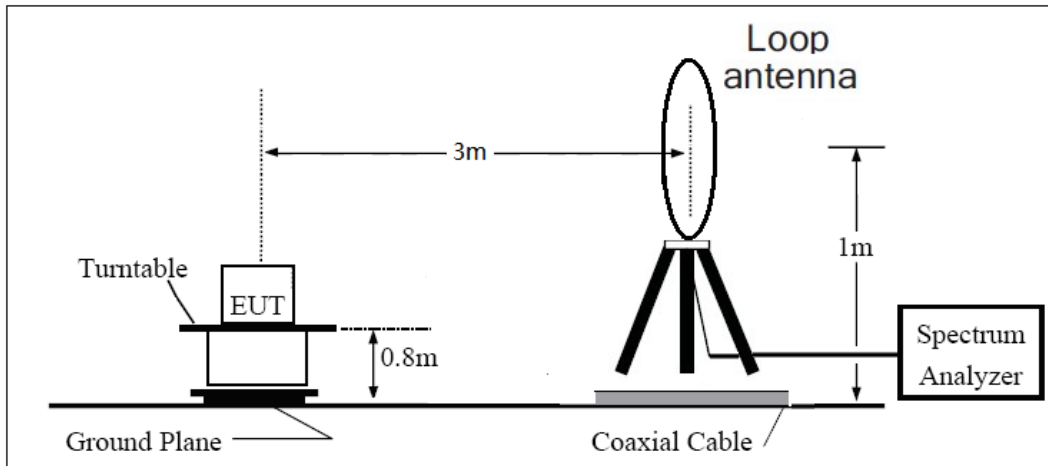

30MHz ~ 1GHz

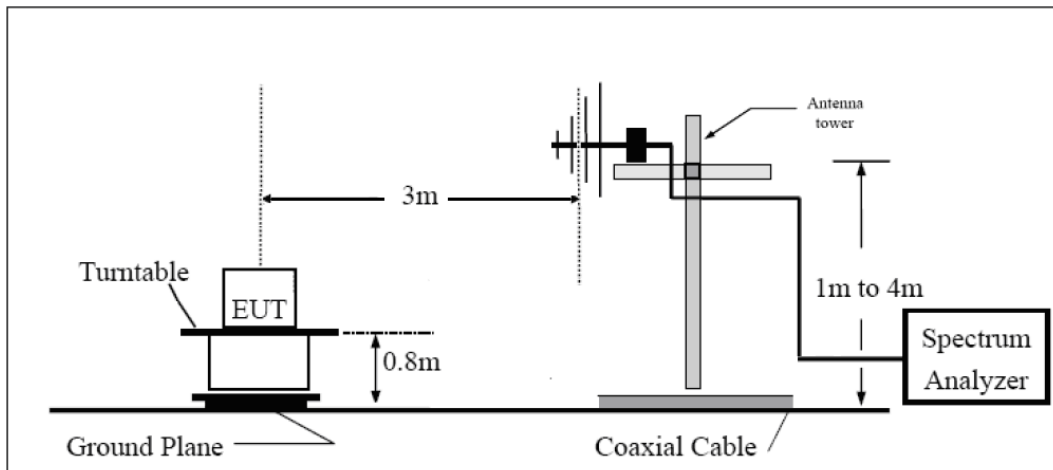

Above 1GHz

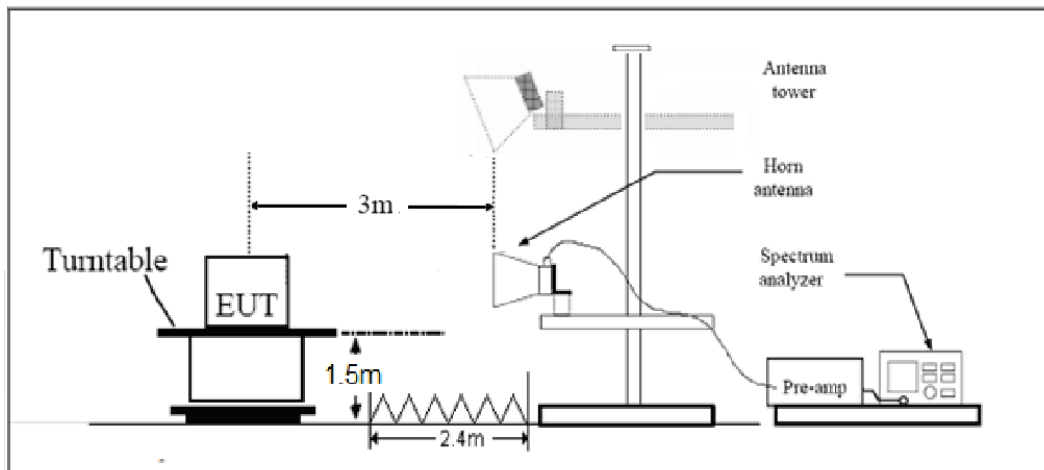



Note: Area side: 2.4mX3.6m

Limits

Rule Part 24.238(a) specifies that “on any frequency outside a licensee's frequency block, the power of any emission shall be attenuated below the transmitter power (P) by at least $43 + 10 \log_{10}(P)$ dB.”

Limit	-13 dBm
-------	---------

Measurement Uncertainty

The assessed measurement uncertainty to ensure 95% confidence level for the normal distribution is with the coverage factor $k = 1.96$, $U = 3.55$ dB.

Test Result

Sweep the whole frequency band through the range from 9kHz to the 10th harmonic of the carrier, the emissions below the noise floor will not be recorded in the report.

LTE Band 2 1.4MHz CH-Middle

Harmonic	Frequency (MHz)	SG (dBm)	Cable Loss (dB)	Gain (dBi)	Antenna Polarization	EIRP Level (dBm)	Limit (dBm)	Margin (dB)	Azimuth (deg)
2	3759.0	-58.68	5.10	11.05	Horizontal	-52.73	-13.00	39.73	90
3	5638.9	-63.32	5.42	12.65	Horizontal	-56.09	-13.00	43.09	45
4	7520.0	-60.35	6.70	13.85	Horizontal	-53.20	-13.00	40.20	135
5	9400.0	-57.44	7.01	14.75	Horizontal	-49.70	-13.00	36.70	225
6	11280.0	-55.37	7.48	15.95	Horizontal	-46.90	-13.00	33.90	135
7	13160.0	-55.57	7.51	16.55	Horizontal	-46.53	-13.00	33.53	225
8	15040.0	-52.89	8.24	15.35	Horizontal	-45.78	-13.00	32.78	45
9	16920.0	-50.42	8.41	14.95	Horizontal	-43.88	-13.00	30.88	90
10	18800.0	--	--	--	--	--	--	--	--

Note: 1.The other Spurious RF Radiated emissions level is no more than noise floor.
 2. The worst emission was found in the antenna is Horizontal position.

LTE Band 2 5MHz CH-Middle

Harmonic	Frequency (MHz)	SG (dBm)	Cable Loss (dB)	Gain (dBi)	Antenna Polarization	EIRP Level (dBm)	Limit (dBm)	Margin (dB)	Azimuth (deg)
2	3760.0	-60.53	5.10	11.05	Horizontal	-54.58	-13.00	41.58	0
3	5640.0	-62.90	5.42	12.65	Horizontal	-55.67	-13.00	42.67	135
4	7520.0	-58.94	6.70	13.85	Horizontal	-51.79	-13.00	38.79	45
5	9400.0	-55.45	7.01	14.75	Horizontal	-47.71	-13.00	34.71	225
6	11280.0	-55.03	7.48	15.95	Horizontal	-46.56	-13.00	33.56	270
7	13160.0	-55.30	7.51	16.55	Horizontal	-46.26	-13.00	33.26	180
8	15040.0	-53.19	8.24	15.35	Horizontal	-46.08	-13.00	33.08	45
9	16920.0	-50.46	8.41	14.95	Horizontal	-43.92	-13.00	30.92	225
10	18800.0	--	--	--	--	--	--	--	--

Note: 1.The other Spurious RF Radiated emissions level is no more than noise floor.
 2. The worst emission was found in the antenna is Horizontal position.



LTE Band 2 20MHz CH-Middle

Harmonic	Frequency (MHz)	SG (dBm)	Cable Loss (dB)	Gain (dBi)	Antenna Polarization	EIRP Level (dBm)	Limit (dBm)	Margin (dB)	Azimuth (deg)
2	3760.0	-59.69	5.10	11.05	Horizontal	-53.74	-13.00	40.74	45
3	5640.0	-63.23	5.42	12.65	Horizontal	-56.00	-13.00	43.00	45
4	7520.0	-58.45	6.70	13.85	Horizontal	-51.30	-13.00	38.30	135
5	9400.0	-56.22	7.01	14.75	Horizontal	-48.48	-13.00	35.48	225
6	11280.0	-55.38	7.48	15.95	Horizontal	-46.91	-13.00	33.91	45
7	13160.0	-55.72	7.51	16.55	Horizontal	-46.68	-13.00	33.68	135
8	15040.0	-53.05	8.24	15.35	Horizontal	-45.94	-13.00	32.94	270
9	16920.0	-49.30	8.41	14.95	Horizontal	-42.76	-13.00	29.76	315
10	18800.0	--	--	--	--	--	--	--	--

Note: 1.The other Spurious RF Radiated emissions level is no more than noise floor.

2. The worst emission was found in the antenna is Horizontal position.

LTE Band 25 1.4MHz CH-Middle

Harmonic	Frequency (MHz)	SG (dBm)	Cable Loss (dB)	Gain (dBi)	Antenna Polarization	EIRP Level (dBm)	Limit (dBm)	Margin (dB)	Azimuth (deg)
2	3765.0	-62.50	5.10	11.05	Horizontal	-56.55	-13.00	43.55	225
3	5647.5	-62.29	5.42	12.65	Horizontal	-55.06	-13.00	42.06	180
4	7530.0	-57.69	6.70	13.85	Horizontal	-50.54	-13.00	37.54	315
5	9412.5	-55.92	7.01	14.75	Horizontal	-48.18	-13.00	35.18	90
6	11295.0	-55.53	7.48	15.95	Horizontal	-47.06	-13.00	34.06	45
7	13177.5	-54.89	7.51	16.55	Horizontal	-45.85	-13.00	32.85	0
8	15060.0	-53.05	8.24	15.35	Horizontal	-45.94	-13.00	32.94	225
9	16942.5	-50.06	8.41	14.95	Horizontal	-43.52	-13.00	30.52	135
10	18825.0	--	--	--	--	--	--	--	--

Note: 1.The other Spurious RF Radiated emissions level is no more than noise floor.

2. The worst emission was found in the antenna is Horizontal position.



LTE Band 25 5MHz CH-Middle

Harmonic	Frequency (MHz)	SG (dBm)	Cable Loss (dB)	Gain (dBi)	Antenna Polarization	EIRP Level (dBm)	Limit (dBm)	Margin (dB)	Azimuth (deg)
2	3765.0	-62.25	5.10	11.05	Horizontal	-56.30	-13.00	37.30	225
3	5647.5	-61.53	5.42	12.65	Horizontal	-54.30	-13.00	35.60	180
4	7530.0	-57.45	6.70	13.85	Horizontal	-50.30	-13.00	32.70	315
5	9412.5	-56.34	7.01	14.75	Horizontal	-48.60	-13.00	31.80	90
6	11295.0	-54.17	7.48	15.95	Horizontal	-45.70	-13.00	32.90	45
7	13177.5	-53.84	7.51	16.55	Horizontal	-44.80	-13.00	30.90	0
8	15060.0	-53.01	8.24	15.35	Horizontal	-45.90	-13.00	32.90	225
9	16942.5	-50.44	8.41	14.95	Horizontal	-43.90	-13.00	30.90	135
10	18825.0	--	--	--	--	--	--	--	--

Note: 1.The other Spurious RF Radiated emissions level is no more than noise floor.

2. The worst emission was found in the antenna is Horizontal position.

LTE Band 25 10MHz CH-Middle

Harmonic	Frequency (MHz)	SG (dBm)	Cable Loss (dB)	Gain (dBi)	Antenna Polarization	EIRP Level (dBm)	Limit (dBm)	Margin (dB)	Azimuth (deg)
2	3765.0	-60.75	5.10	11.05	Horizontal	-54.8	-13.00	37.50	90
3	5647.5	-62.13	5.42	12.65	Horizontal	-54.9	-13.00	35.50	225
4	7530.0	-57.65	6.70	13.85	Horizontal	-50.5	-13.00	33.70	315
5	9412.5	-56.24	7.01	14.75	Horizontal	-48.5	-13.00	31.80	45
6	11295.0	-55.17	7.48	15.95	Horizontal	-46.7	-13.00	31.80	0
7	13177.5	-53.84	7.51	16.55	Horizontal	-44.8	-13.00	30.70	180
8	15060.0	-51.91	8.24	15.35	Horizontal	-44.8	-13.00	31.80	90
9	16942.5	-50.24	8.41	14.95	Horizontal	-43.7	-13.00	30.70	315
10	18825.0	--	--	--	--	--	--	--	--

Note: 1.The other Spurious RF Radiated emissions level is no more than noise floor.

2. The worst emission was found in the antenna is Horizontal position.

6. Main Test Instruments

Name	Manufacturer	Type	Serial Number	Calibration Date	Expiration Date
Base Station Simulator	R&S	CMU200	118133	2019-05-19	2020-05-18
Base Station Simulator	R&S	CMW500	113824	2019-05-19	2020-05-18
Power Splitter	Hua Xiang	SHX-GF2-2-13	10120101	/	/
Spectrum Analyzer	Key sight	N9010A	MY50210259	2019-05-19	2020-05-18
Universal Radio Communication Tester	Key sight	E5515C	MY48367192	2019-05-19	2020-05-18
Signal Analyzer	R&S	FSV40	15195-01-00	2019-05-19	2020-05-18
Loop Antenna	SCHWARZBECK	FMZB1519	1519-047	2017-09-26	2020-09-25
Trilog Antenna	SCHWARZBECK	VUBL 9163	9163-201	2017-11-18	2020-11-17
Horn Antenna	R&S	HF907	100126	2018-07-07	2020-07-06
Horn Antenna	ETS-Lindgren	3160-09	00102643	2018-06-20	2020-06-19
Signal generator	R&S	SMB 100A	102594	2019-05-19	2020-05-18
Climatic Chamber	ESPEC	SU-242	93000506	2017-12-17	2020-12-16
Preamplifier	R&S	SCU18	102327	2019-05-19	2020-05-18
MOB COMMS DC SUPPLY	Keysight	66319D	MY43004105	2019-05-19	2020-05-18
RF Cable	Agilent	SMA 15cm	0001	2019-12-13	2020-6-12
Software	R&S	EMC32	9.26.0	/	/

*****END OF REPORT *****