



# RF TEST REPORT

**Applicant**      Quectel Wireless Solutions Co., Ltd  
**FCC ID**          XMR201907EC25MX  
**Product**        LTE Module  
**Brand**            Quectel  
**Model**            EC25-MX, EC25-MX MINIPCIE  
**Report No.**      R1906A0272-R2  
**Issue Date**     July 31, 2019

TA Technology (Shanghai) Co., Ltd. tested the above equipment in accordance with the requirements in **FCC CFR47 Part 2 (2018)/ FCC CFR 47 Part 24E (2018)**. The test results show that the equipment tested is capable of demonstrating compliance with the requirements as documented in this report.

*Performed by: Peng Tao*

*Approved by: Kai Xu*

---

## TA Technology (Shanghai) Co., Ltd.

*No.145, Jintang Rd, Tangzhen Industry Park, Pudong Shanghai, China*

*TEL: +86-021-50791141/2/3*

*FAX: +86-021-50791141/2/3-8000*



## TABLE OF CONTENT

1. Test Laboratory .....	4
1.1. Notes of the test report.....	4
1.2. Test facility.....	4
1.3. Testing Location .....	5
2. General Description of Equipment under Test.....	6
3. Applied Standards.....	7
4. Test Configuration.....	8
5. Test Case Results.....	10
5.1. RF Power Output.....	10
5.2. Effective Isotropic Radiated Power .....	15
5.3. Occupied Bandwidth .....	19
5.4. Band Edge Compliance.....	28
5.5. Peak-to-Average Power Ratio (PAPR) .....	38
5.6. Frequency Stability.....	41
5.7. Spurious Emissions at Antenna Terminals .....	47
5.8. Radiates Spurious Emission .....	59
6. Main Test Instruments .....	65
ANNEX A: EUT Appearance and Test Setup.....	66
A.1 EUT Appearance .....	66
A.2 Test Setup.....	68

### Summary of measurement results

No.	Test Case	Clause in FCC rules	Verdict
1	RF power output	2.1046	PASS
2	Effective Isotropic Radiated power	24.232(c)	PASS
3	Occupied Bandwidth	2.1049	PASS
4	Band Edge Compliance	2.1051 /24.238(a)	PASS
5	Peak-to-Average Power Ratio	24.232/KDB 971168 D01(5.7)	PASS
6	Frequency Stability	2.1055 / 24.235	PASS
7	Spurious Emissions at Antenna Terminals	2.1051 / 24.238(a)	PASS
8	Radiates Spurious Emission	2.1053 / 24.238(a)	PASS
Note: PASS: The EUT complies with the essential requirements in the standard. FAIL: The EUT does not comply with the essential requirements in the standard.			
Date of Testing: June 18, 2019~ July 12, 2019			



## 1. Test Laboratory

### 1.1. Notes of the test report

This report shall not be reproduced in full or partial, without the written approval of **TA technology (shanghai) co., Ltd.** The results documented in this report apply only to the tested sample, under the conditions and modes of operation as described herein. Measurement Uncertainties were not taken into account and are published for informational purposes only. This report is written to support regulatory compliance of the applicable standards stated above.

### 1.2. Test facility

#### **FCC (Designation number: CN1179, Test Firm Registration Number: 446626)**

TA Technology (Shanghai) Co., Ltd. has been listed on the US Federal Communications Commission list of test facilities recognized to perform electromagnetic emissions measurements.

#### **IC (recognition number is 8510A)**

TA Technology (Shanghai) Co., Ltd. has been listed by industry Canada to perform electromagnetic emission measurement.

#### **VCCI (recognition number is C-4595, T-2154, R-4113, G-10766)**

TA Technology (Shanghai) Co., Ltd. has been listed by industry Japan to perform electromagnetic emission measurement.

#### **A2LA (Certificate Number: 3857.01)**

TA Technology (Shanghai) Co., Ltd. has been listed by American Association for Laboratory Accreditation to perform electromagnetic emission measurement.



### 1.3. Testing Location

Company: TA Technology (Shanghai) Co., Ltd.  
Address: No.145, Jintang Rd, Tangzhen Industry Park, Pudong  
City: Shanghai  
Post code: 201201  
Country: P. R. China  
Contact: Xu Kai  
Telephone: +86-021-50791141/2/3  
Fax: +86-021-50791141/2/3-8000  
Website: <http://www.ta-shanghai.com>  
E-mail: [xukai@ta-shanghai.com](mailto:xukai@ta-shanghai.com)

## 2. General Description of Equipment under Test

### Client Information

Applicant	Quectel Wireless Solutions Co., Ltd
Applicant address	Building 5, Shanghai Business Park Phase III (Area B), No.1016 Tianlin Road, Minhang District, Shanghai, China 200233
Manufacturer	Quectel Wireless Solutions Co., Ltd
Manufacturer address	Building 5, Shanghai Business Park Phase III (Area B), No.1016 Tianlin Road, Minhang District, Shanghai, China 200233

### General information

EUT Description			
Model	EC25-MX, EC25-MX MINIPCIE		
IMEI	864744040000620		
Hardware Version	R1.0		
Software Version	EC25MXGAR10A02M1G		
Power Supply	External power supply		
Antenna Type	The EUT don't have standard Antenna, The Antenna used for testing in this report is the after-market accessory (Dipole Antenna)		
Antenna Gain	4 dBi		
Test Mode(s)	WCDMA Band II; LTE Band 2;		
Test Modulation	(WCDMA) BPSK, QPSK, 16QAM; (LTE) QPSK, 16QAM		
HSDPA UE Category	14		
HSUPA UE Category	6		
DC-HSDPA UE Category	24		
HSPA+ UE Category	24		
LTE Category	4		
Maximum E.I.R.P	WCDMA Band II:	23.81dBm	
	LTE Band 2:	24.00dBm	
Rated Power Supply Voltage	3.8V		
Extreme Voltage	Minimum: 3.3V Maximum: 4.3V		
Extreme Temperature	Lowest: -40°C Highest: +85°C		
Operating Frequency Range(s)	Band	Tx (MHz)	Rx (MHz)
	WCDMA Band II	1850 ~ 1910	1930 ~ 1990
	LTE Band 2	1850 ~ 1910	1930 ~ 1990
Note: 1. The information of the EUT is declared by the manufacturer.			



### **3. Applied Standards**

According to the specifications of the manufacturer, it must comply with the requirements of the following standards:

**FCC CFR47 Part 2 (2018)**

**FCC CFR 47 Part 24E (2018)**

**ANSI C63.26 (2015)**

**KDB 971168 D01 Power Meas License Digital Systems v03r01**

## 4. Test Configuration

Radiated measurements are performed by rotating the EUT in three different orthogonal test planes. EUT stand-up position (Z axis), lie-down position (X, Y axis). Receiver antenna polarization (horizontal and vertical), the worst emission was found in position (Z axis, horizontal polarization) and the worst case was recorded.

All mode and data rates and positions and RB size and modulations were investigated.

Subsequently, only the worst case emissions are reported.

The following testing in WCDMA/LTE is set based on the maximum RF Output Power.

Test modes are chosen to be reported as the worst case configuration below:

Test items	Modes/Modulation
	WCDMA Band II
RF power output	RMC HSDPA/HSUPA DC-HSDPA/HSPA+
Effective Isotropic Radiated power	RMC
Occupied Bandwidth	RMC
Band Edge Compliance	RMC
Peak-to-Average Power Ratio	RMC
Frequency Stability	RMC
Spurious Emissions at Antenna Terminals	RMC
Radiates Spurious Emission	RMC



Test modes are chosen to be reported as the worst case configuration below for LTE Band 2:

Test items	Bandwidth (MHz)						Modulation		RB			Test Channel		
	1.4	3	5	10	15	20	QPSK	16QAM	1	50%	100%	L	M	H
RF power output	O	O	O	O	O	O	O	O	O	O	O	O	O	O
Effective Isotropic Radiated power	O	O	O	O	O	O	O	O	-	-	O	O	O	O
Occupied Bandwidth	O	O	O	O	O	O	O	O	-	-	O	O	O	O
Band Edge Compliance	O	O	O	O	O	O	O	O	O	-	O	O	-	O
Peak-to-Average Power Ratio	O	O	O	O	O	O	O	O	-	-	O	O	O	O
Frequency Stability	O	O	O	O	O	O	O	O	-	-	O	-	O	-
Conducted Spurious Emissions	O	O	O	O	O	O	O	-	O	-	-	O	O	O
Radiates Spurious Emission	-	-	-	-	-	O	O	-	O	-	-	O	O	O
Note	1. The mark "O" means that this configuration is chosen for testing. 2. The mark "-" means that this configuration is not testing.													

## 5. Test Case Results

### 5.1.RF Power Output

#### Ambient condition

Temperature	Relative humidity	Pressure
23°C ~25°C	45%~50%	101.5kPa

#### Methods of Measurement

During the process of the testing, The EUT is controlled by the Base Station Simulator to ensure max power transmission and proper modulation.

#### Test Setup



The loss between RF output port of the EUT and the input port of the tester has been taken into consideration.

#### Limits

No specific RF power output requirements in part 2.1046.

#### Measurement Uncertainty

The assessed measurement uncertainty to ensure 95% confidence level for the normal distribution is with the coverage factor  $k = 2$ ,  $U = 0.4$  dB.



## Test Results

WCDMA Band II		Conducted Power(dBm)		
		Channel 9262	Channel 9400	Channel 9538
		1852.4(MHz)	1880(MHz)	1907.6(MHz)
<b>RMC</b>		22.42	22.45	22.35
<b>HSDPA</b>	Sub - Test 1	21.88	21.87	21.79
	Sub - Test 2	21.87	21.89	21.76
	Sub - Test 3	21.34	21.39	21.28
	Sub - Test 4	21.35	21.40	21.26
<b>HSUPA</b>	Sub - Test 1	21.84	21.86	21.74
	Sub - Test 2	20.83	20.84	20.73
	Sub - Test 3	21.30	21.32	21.22
	Sub - Test 4	20.76	20.81	20.70
	Sub - Test 5	21.77	21.79	21.68
<b>DC-HSDPA</b>	Sub - Test 1	21.76	21.81	21.69
	Sub - Test 2	21.75	21.80	21.68
	Sub - Test 3	21.33	21.29	21.19
	Sub - Test 4	21.32	21.28	21.18
<b>HSPA+</b>	16QAM	21.31	21.36	21.25



LTE Band 2				Conducted Power(dBm)		
Bandwidth	Modulation	RB size	RB offset	Channel/Frequency (MHz)		
				18607/1850.7	18900/1880	19193/1909.3
1.4MHz	QPSK	1	0	22.48	22.42	22.39
		1	2	22.61	22.64	22.56
		1	5	22.37	22.53	22.39
		3	0	21.37	21.35	21.33
		3	2	21.35	21.46	21.23
		3	3	21.40	21.48	21.20
		6	0	21.35	21.53	21.29
	16QAM	1	0	21.93	21.53	22.01
		1	2	22.02	21.45	22.18
		1	5	21.74	21.46	22.17
		3	0	20.42	20.26	20.31
		3	2	20.39	20.34	20.31
		3	3	20.34	20.39	20.27
		6	0	20.45	20.52	20.32
Bandwidth	Modulation	RB size	RB offset	Channel/Frequency (MHz)		
				18615/1851.5	18900/1880	19185/1908.5
3MHz	QPSK	1	0	22.50	22.46	22.42
		1	7	22.64	22.69	22.60
		1	14	22.40	22.58	22.43
		8	0	21.45	21.45	21.44
		8	4	21.45	21.54	21.33
		8	7	21.48	21.57	21.28
		15	0	21.38	21.57	21.32
	16QAM	1	0	21.96	21.55	22.04
		1	7	22.05	21.50	22.22
		1	14	21.76	21.50	22.20
		8	0	20.51	20.37	20.41
		8	4	20.48	20.45	20.41
		8	7	20.42	20.49	20.38
		15	0	20.48	20.56	20.35
Bandwidth	Modulation	RB size	RB offset	Channel/Frequency (MHz)		
				18625/1852.5	18900/1880	19175/1907.5
5MHz	QPSK	1	0	22.47	22.44	22.38
		1	13	22.62	22.65	22.57
		1	24	22.37	22.53	22.39
		12	0	21.42	21.40	21.40



	16QAM	12	6	21.43	21.50	21.28
		12	13	21.46	21.55	21.24
		25	0	21.36	21.56	21.30
		1	0	21.93	21.51	22.01
		1	13	22.02	21.48	22.19
		1	24	21.73	21.48	22.16
		12	0	20.49	20.33	20.38
		12	6	20.45	20.40	20.37
		12	13	20.39	20.44	20.34
		25	0	20.46	20.52	20.30
Bandwidth	Modulation	RB size	RB offset	Channel/Frequency (MHz)		
				18650/1855	18900/1880	19150/1905
10MHz	QPSK	1	0	22.49	22.45	22.41
		1	25	22.65	22.70	22.61
		1	49	22.39	22.57	22.42
		25	0	21.45	21.45	21.44
		25	13	21.46	21.55	21.32
		25	25	21.48	21.59	21.29
		50	0	21.44	21.58	21.34
	16QAM	1	0	21.95	21.54	22.03
		1	25	22.05	21.52	22.22
		1	49	21.76	21.50	22.19
		25	0	20.52	20.38	20.42
		25	13	20.47	20.44	20.40
		25	25	20.42	20.49	20.38
		50	0	20.49	20.57	20.34
Bandwidth	Modulation	RB size	RB offset	Channel/Frequency (MHz)		
				18675/1857.5	18900/1880	19125/1902.5
15MHz	QPSK	1	0	22.48	22.41	22.39
		1	38	22.63	22.69	22.58
		1	74	22.36	22.52	22.38
		36	0	21.43	21.41	21.41
		36	18	21.43	21.50	21.28
		36	39	21.45	21.56	21.25
		75	0	21.42	21.54	21.29
	16QAM	1	0	21.90	21.52	22.01
		1	38	22.03	21.49	22.20
		1	74	21.73	21.46	22.16
		36	0	20.49	20.36	20.39
		36	18	20.44	20.39	20.36



		36	39	20.40	20.45	20.35
		75	0	20.46	20.52	20.30
Bandwidth	Modulation	RB size	RB offset	Channel/Frequency (MHz)		
				18700/1860	18900/1880	19100/1900
20MHz	QPSK	1	0	22.45	22.37	22.36
		1	50	22.62	22.65	22.56
		1	99	22.34	22.51	22.35
		50	0	21.40	21.36	21.37
		50	25	21.41	21.46	21.25
		50	50	21.42	21.51	21.21
	16QAM	100	0	21.39	21.49	21.25
		1	0	21.88	21.48	21.96
		1	50	21.99	21.47	22.16
		1	99	21.71	21.43	22.14
		50	0	20.46	20.32	20.36
		50	25	20.41	20.37	20.33
		50	50	20.37	20.40	20.31
		100	0	20.44	20.48	20.27

## 5.2. Effective Isotropic Radiated Power

### Ambient condition

Temperature	Relative humidity	Pressure
23°C ~25°C	45%~50%	101.5kPa

### Methods of Measurement

The testing follows FCC KDB 971168 v03r01 Section 5.8 and ANSI C63.26 (2015).

- Connect the equipment as illustrated. Mount the equipment with the manufacturer specified antenna in a vertical orientation on a manufacturer specified mounting surface located on a non-conducting rotating platform of a RF anechoic chamber (preferred) or a standard radiation site.
- Key the transmitter, then rotate the EUT 360° azimuthally and record spectrum analyzer power level (LVL) measurements at angular increments that are sufficiently small to permit resolution of all peaks. If a standard radiation test site is used, raise and lower the test antenna to obtain a maximum reading at each angular increment. (Note: several batteries may be needed to offset the effect of battery voltage droop, which should not exceed 5% of the manufactured specified battery voltage during transmission).
- Replace the transmitter under test with a vertically polarized half-wave dipole (or an antenna whose gain is known relative to an ideal half-wave dipole). The center of the antenna should be at the same location as the center of the antenna under test.
- Connect the antenna to a signal generator with a known output power and record the path loss (in dB) as LOSS. If a standard radiation test site is used, raise and lower the test antenna to obtain a maximum reading.  $LOSS = \text{Generator Output Power (dBm)} - \text{Analyzer reading (dBm)}$
- Determine the effective radiated output power at each angular position from the readings in steps b) and d) using the following equation:  $ERP \text{ (dBm)} = \text{LVL (dBm)} + \text{LOSS (dB)}$
- The maximum ERP is the maximum value determined in the preceding step.
- When calculating ERP, in addition to knowing the antenna radiation and matching characteristics, it is necessary to know the loss values of all elements (e.g. transmission line attenuation, mismatches, filters, combiners) interposed between the point where transmitter output power is measured, and the point where power is applied to the antenna. ERP can then be calculated as follows:  
 $EIRP \text{ (dBm)} = \text{Output Power (dBm)} - \text{Losses (dB)} + \text{Antenna Gain (dBi)}$   
where: dBd refers to gain relative to an ideal dipole.  
 $EIRP \text{ (dBm)} = \text{ERP (dBm)} + 2.15 \text{ (dB.)}$

The RB allocation refers to section 5.1, using the maximum output power configuration.

**Test setup**

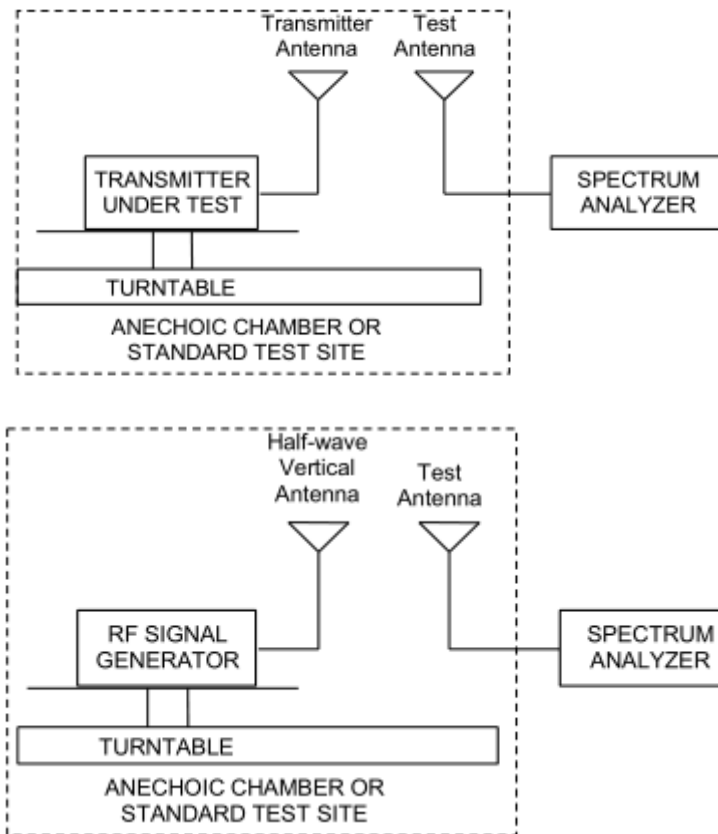

**Limits**

Rule Part 24.232(c) Mobile and portable stations are limited to 2 watts EIRP.

Rule Part 24.232(e) Peak transmit power must be measured over any interval of continuous transmission using instrumentation calibrated in terms of an rms-equivalent voltage.

Limit	$\leq 2\text{ W}$ (33 dBm)
-------	----------------------------

**Measurement Uncertainty**

The assessed measurement uncertainty to ensure 95% confidence level for the normal distribution is with the coverage factor  $k = 2$ ,  $U = 1.19\text{ dB}$



**Test Results:**

The measurement is performed for both of horizontal and vertical antenna Polarization, and only the data of worst mode is recorded in this report.

Mode	Channel	Frequency (MHz)	Polarization	EIRP (dBm)	Limit (dBm)	Conclusion
WCDMA Band II	Low	1852.4	Horizontal	23.44	33	Pass
	Mid	1880	Horizontal	23.39	33	Pass
	High	1907.6	Horizontal	23.81	33	Pass

LTE Band 2						
bandwidth	Channel	Frequency (MHz)	Polarization	EIRP (dBm)	Limit (dBm)	Conclusion
1.4 MHz (QPSK)	Low	1850.7	Horizontal	22.86	33	Pass
	Mid	1880	Horizontal	23.15	33	Pass
	High	1909.3	Horizontal	23.52	33	Pass
3 MHz (QPSK)	Low	1851.5	Horizontal	22.73	33	Pass
	Mid	1880	Horizontal	22.95	33	Pass
	High	1908.5	Horizontal	23.43	33	Pass
5 MHz (QPSK)	Low	1852.5	Horizontal	23.05	33	Pass
	Mid	1880	Horizontal	23.28	33	Pass
	High	1907.5	Horizontal	23.84	33	Pass
10 MHz (QPSK)	Low	1855	Horizontal	23.22	33	Pass
	Mid	1880	Horizontal	23.34	33	Pass
	High	1905	Horizontal	24.00	33	Pass
15 MHz (QPSK)	Low	1857.5	Horizontal	23.15	33	Pass
	Mid	1880	Horizontal	23.34	33	Pass
	High	1902.5	Horizontal	23.89	33	Pass
20 MHz (QPSK)	Low	1860	Horizontal	23.16	33	Pass
	Mid	1880	Horizontal	23.46	33	Pass
	High	1900	Horizontal	23.51	33	Pass
1.4 MHz (16QAM)	Low	1850.7	Horizontal	22.33	33	Pass
	Mid	1880	Horizontal	22.64	33	Pass
	High	1909.3	Horizontal	23.05	33	Pass
3 MHz (16QAM)	Low	1851.5	Horizontal	22.28	33	Pass
	Mid	1880	Horizontal	22.47	33	Pass
	High	1908.5	Horizontal	23.04	33	Pass
5 MHz (16QAM)	Low	1852.5	Horizontal	22.61	33	Pass
	Mid	1880	Horizontal	22.79	33	Pass
	High	1907.5	Horizontal	23.42	33	Pass
10 MHz (16QAM)	Low	1855	Horizontal	22.85	33	Pass
	Mid	1880	Horizontal	22.91	33	Pass



<b>15 MHz (16QAM)</b>	High	1905	Horizontal	23.48	33	Pass
	Low	1857.5	Horizontal	22.67	33	Pass
	Mid	1880	Horizontal	22.84	33	Pass
	High	1902.5	Horizontal	23.31	33	Pass
<b>20 MHz (16QAM)</b>	Low	1860	Horizontal	22.56	33	Pass
	Mid	1880	Horizontal	22.97	33	Pass
	High	1900	Horizontal	23.01	33	Pass

### 5.3.Occupied Bandwidth

#### Ambient condition

Temperature	Relative humidity	Pressure
23°C ~25°C	45%~50%	101.5kPa

#### Method of Measurement

The EUT was connected to Spectrum Analyzer and Base Station Simulator via power Splitter. The occupied bandwidth is measured using spectrum analyzer.

RBW is set to 51kHz, VBW is set to 160kHz for WCDMA Band II,

RBW is set to 51kHz, VBW is set to 160kHz for LTE Band 2 (1.4MHz),

RBW is set to 100kHz,VBW is set to 300kHz for LTE Band 2 (3MHz/5MHz),

RBW is set to 300kHz,VBW is set to 1MHz for LTE Band 2 (10MHz/15MHz/20MHz).

99% power and -26dBc occupied bandwidths are recorded. Spectrum analyzer plots are included on the following pages.

#### Test Setup

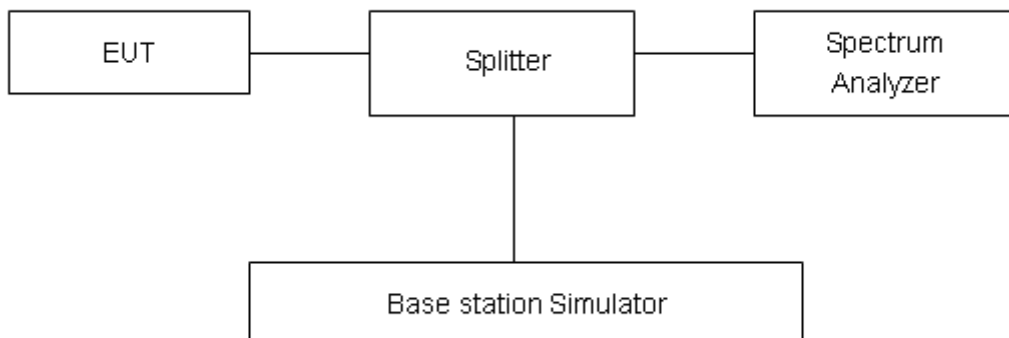

#### Limits

No specific occupied bandwidth requirements in part 2.1049.

#### Measurement Uncertainty

The assessed measurement uncertainty to ensure 95% confidence level for the normal distribution is with the coverage factor  $k = 2$ ,  $U = 624\text{Hz}$ .

**Test Result**

Mode	Channel	Frequency (MHz)	99% Power Bandwidth (MHz)	-26dBc Bandwidth(MHz)
WCDMA Band II (RMC)	9262	1852.4	4.1203	4.673
	9400	1880	4.1284	4.698
	9538	1907.6	4.1241	4.668

LTE Band 2					
Modulation	Bandwidth (MHz)	Channel	Frequency (MHz)	99% Power Bandwidth(MHz)	-26dBc Bandwidth(MHz)
QPSK	1.4	18607	1850.7	1.1113	1.344
		18900	1880.0	1.1158	1.358
		19193	1909.3	1.1324	1.326
	3	18615	1851.5	2.7427	3.072
		18900	1880	2.7528	3.056
		19185	1908.5	2.7472	3.069
	5	18625	1852.5	4.5385	5.021
		18900	1880	4.5143	5.009
		19175	1907.5	4.5113	5.011
	10	18650	1855	9.0406	10.050
		18900	1880	9.0152	10.040
		19150	1905	9.0450	10.040
	15	18675	1857.5	13.4680	14.710
		18900	1880	13.4040	14.580
		19125	1902.5	13.4480	14.720
20	18700	1860	17.8900	19.400	
	18900	1880	17.8550	19.210	
	19100	1900	17.8520	19.200	
16QAM	1.4	18607	1850.7	1.1202	1.330
		18900	1880.0	1.1189	1.339
		19193	1909.3	1.1187	1.338
	3	18615	1851.5	2.7367	3.049
		18900	1880	2.7328	3.056



		19185	1908.5	2.7330	3.063
5		18625	1852.5	4.5038	5.009
		18900	1880	4.5166	4.996
		19175	1907.5	4.5376	5.065
10		18650	1855	9.0332	10.030
		18900	1880	9.0240	9.999
		19150	1905	9.0357	10.070
15		18675	1857.5	13.4770	14.740
		18900	1880	13.4460	14.670
		19125	1902.5	13.4530	14.710
20		18700	1860	17.8770	19.270
		18900	1880	17.8980	19.320
		19100	1900	17.8410	19.290

WCDMA Band II RMC CH-LOW

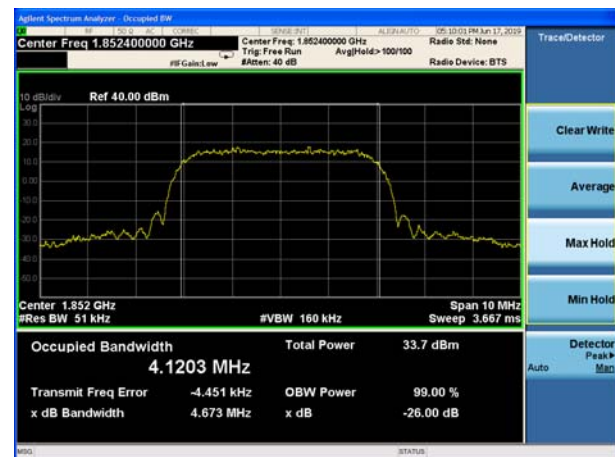

WCDMA Band II RMC CH-Middle

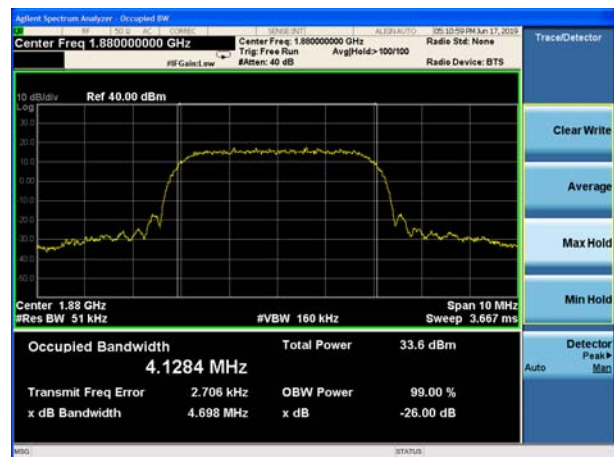

WCDMA Band II RMC CH-High

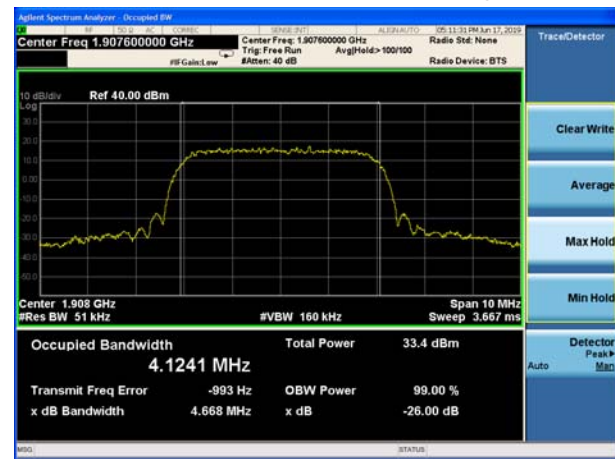

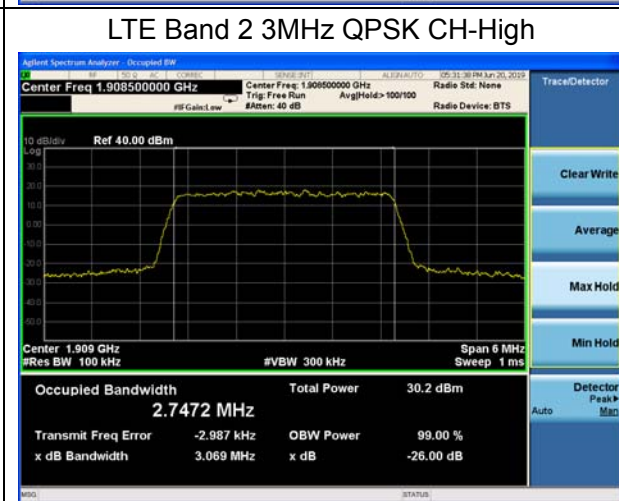
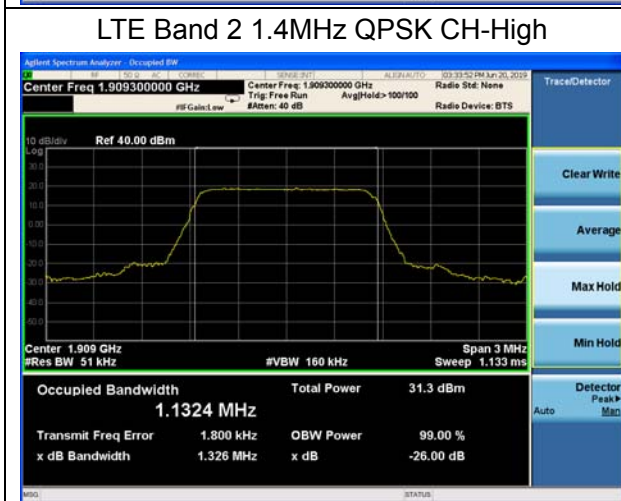
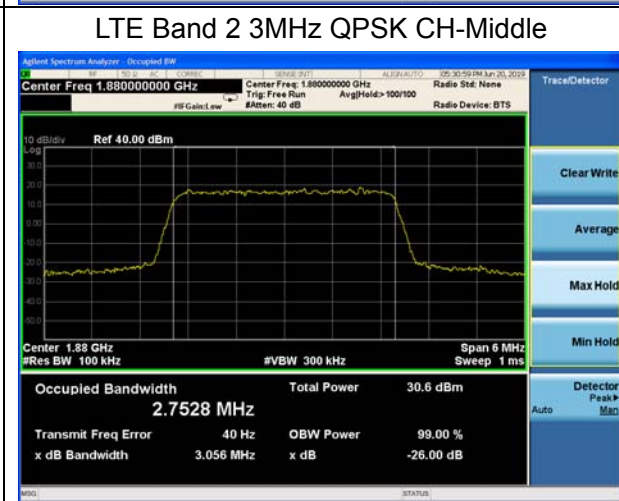
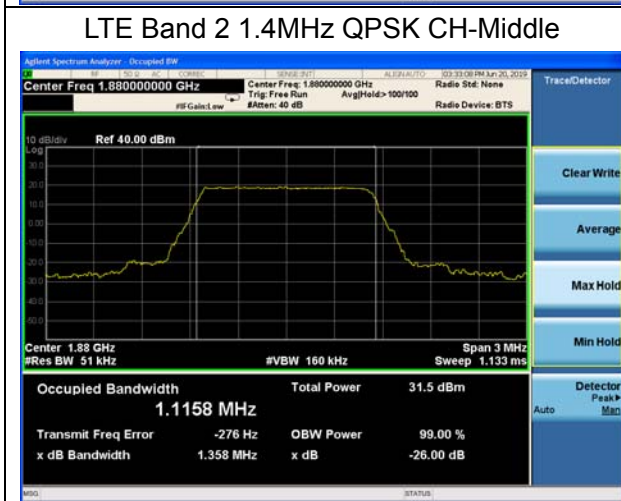
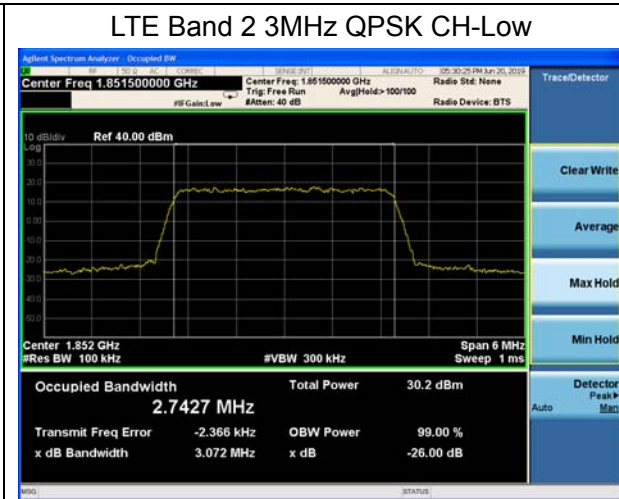
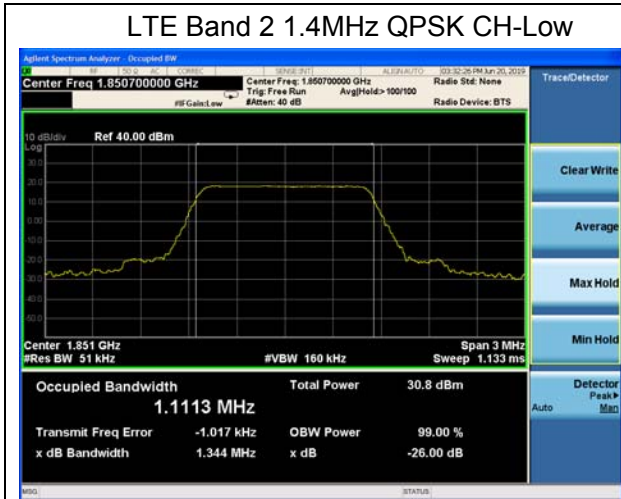

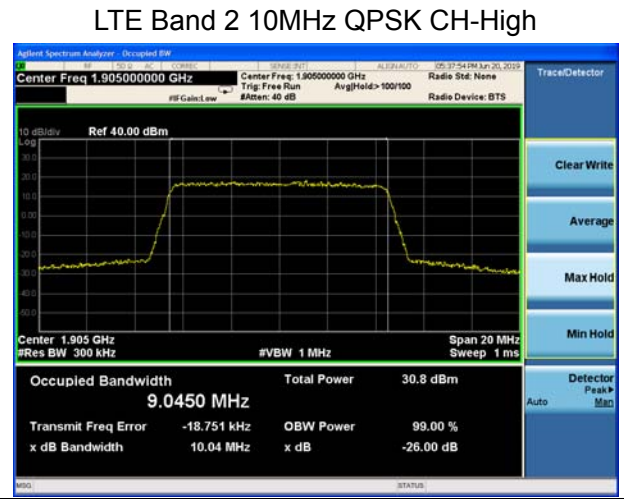
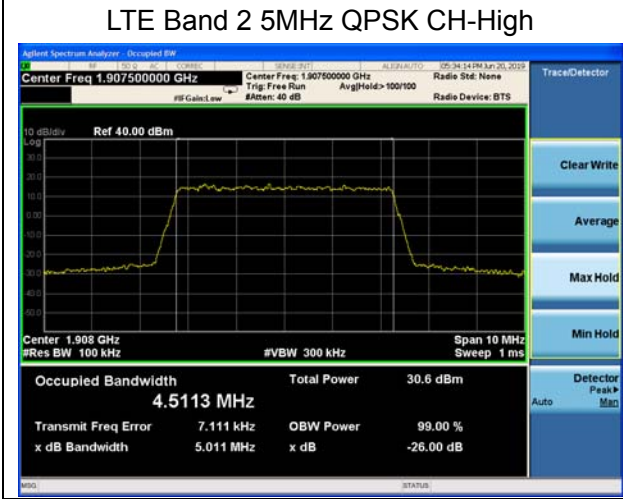
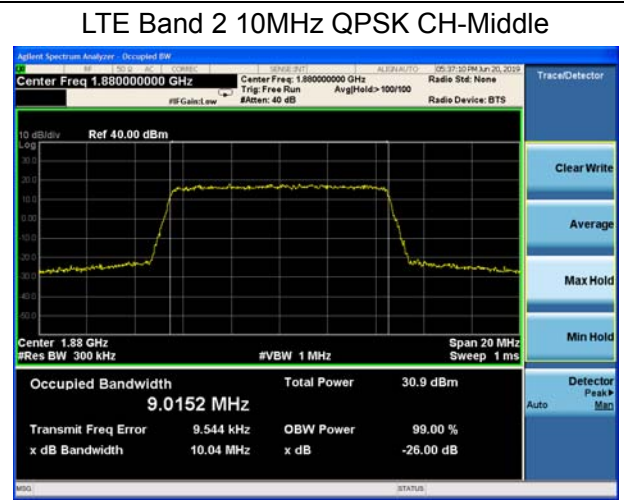
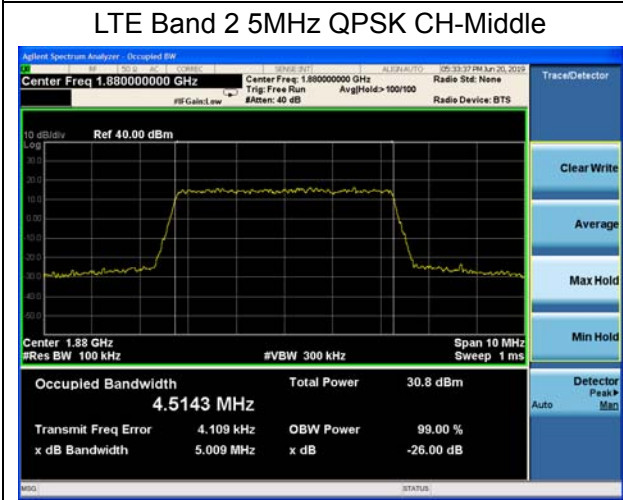
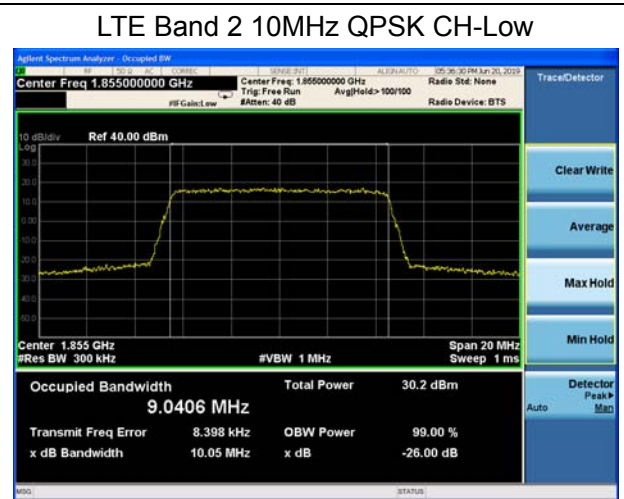
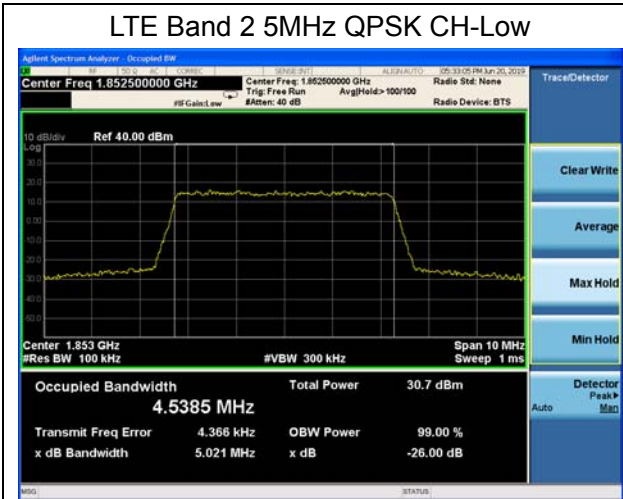



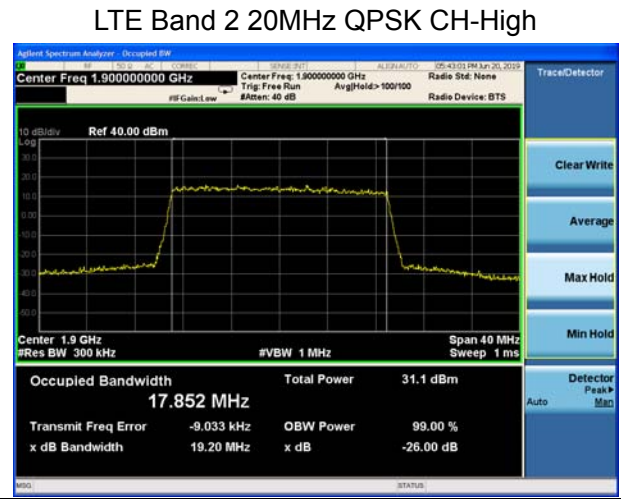
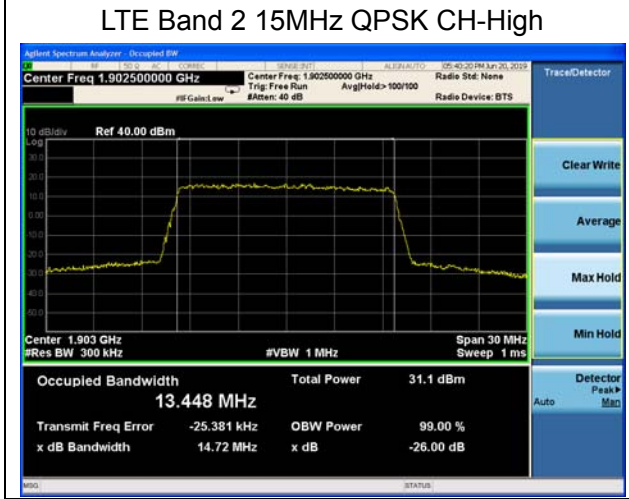
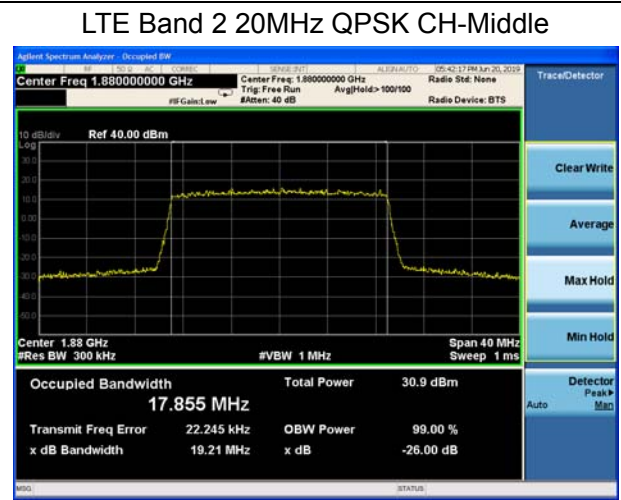
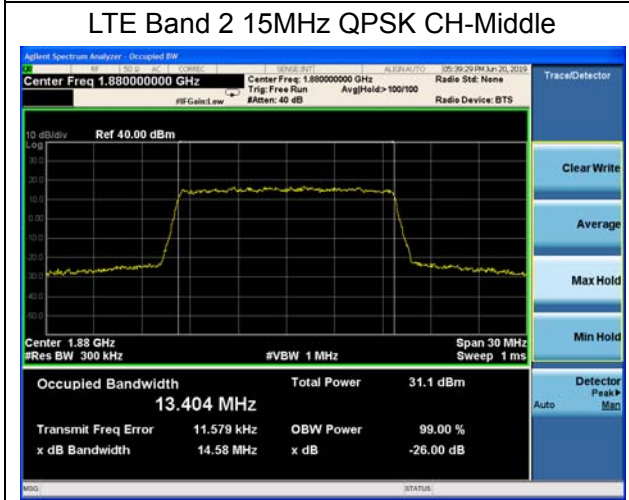
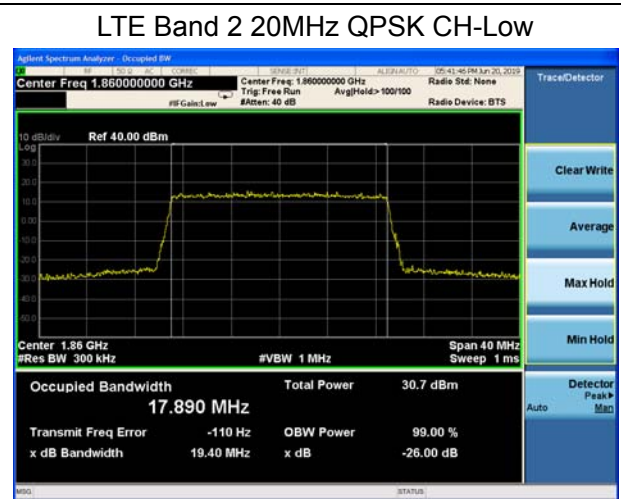
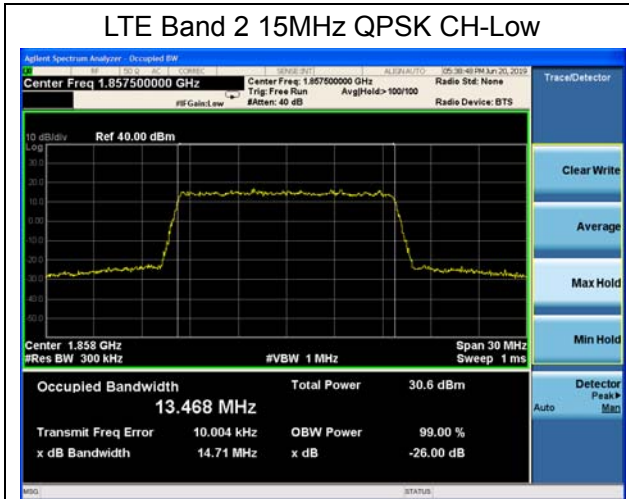



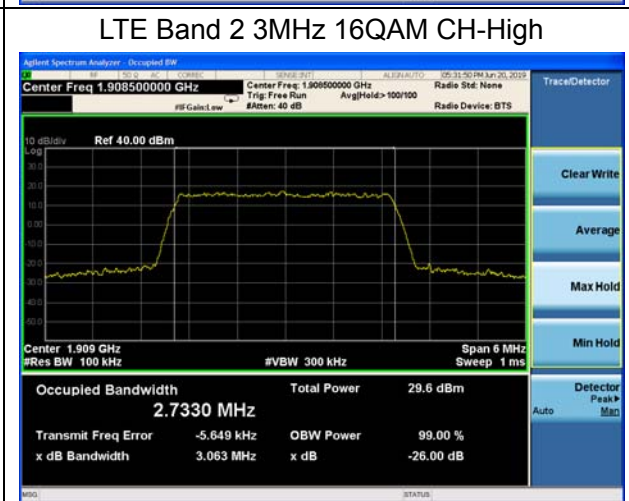
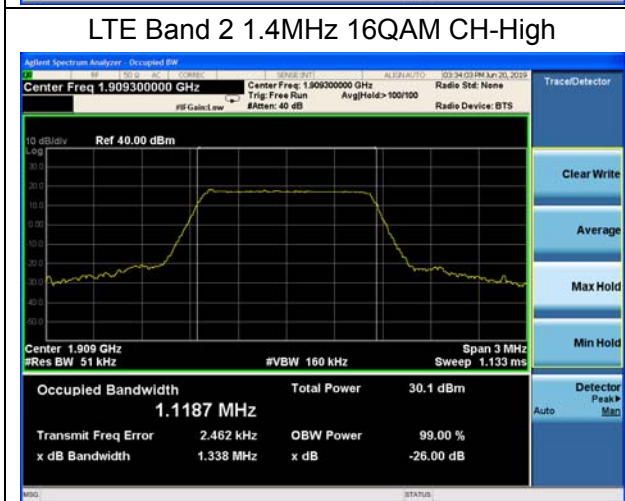
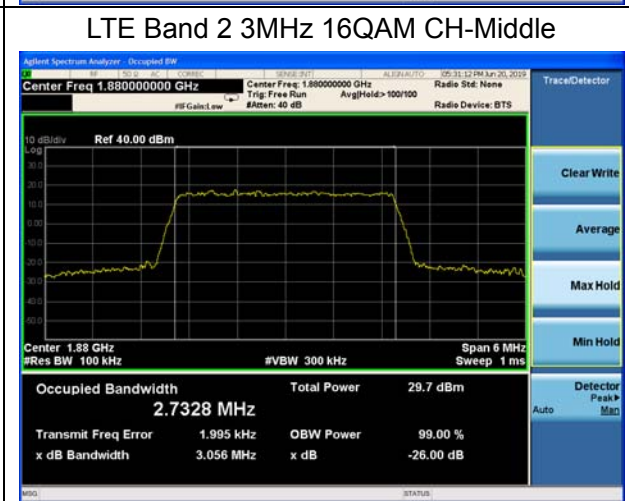
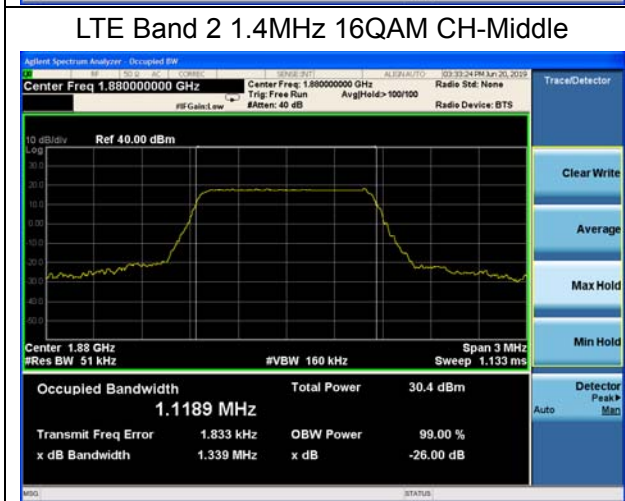
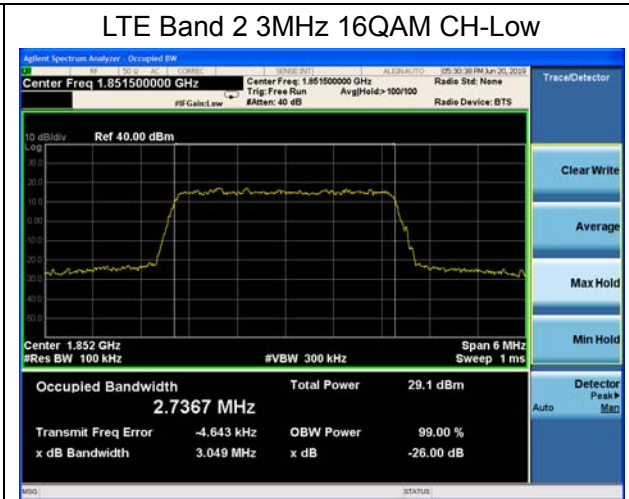
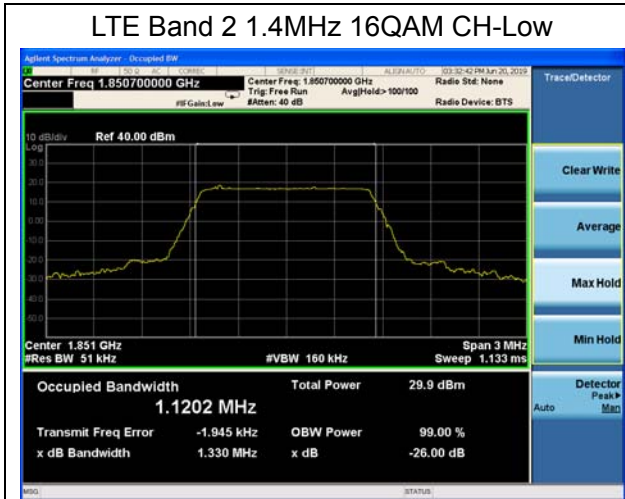

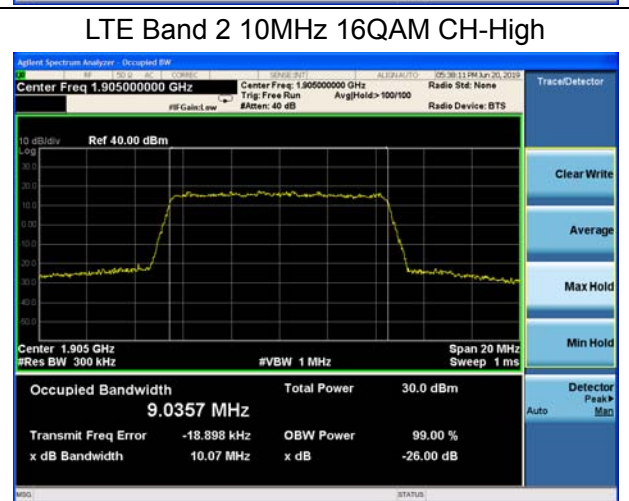
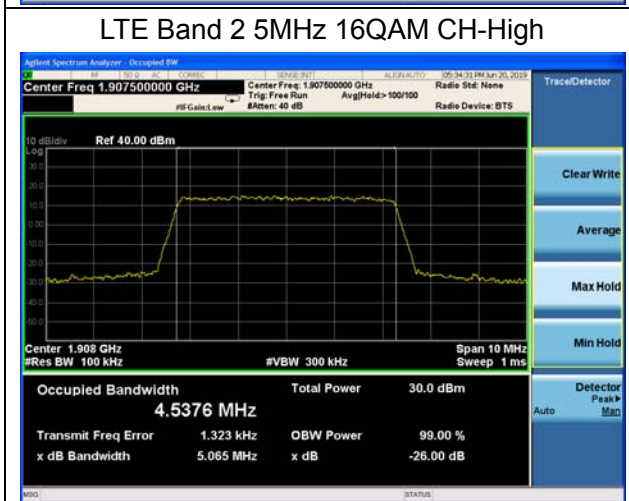
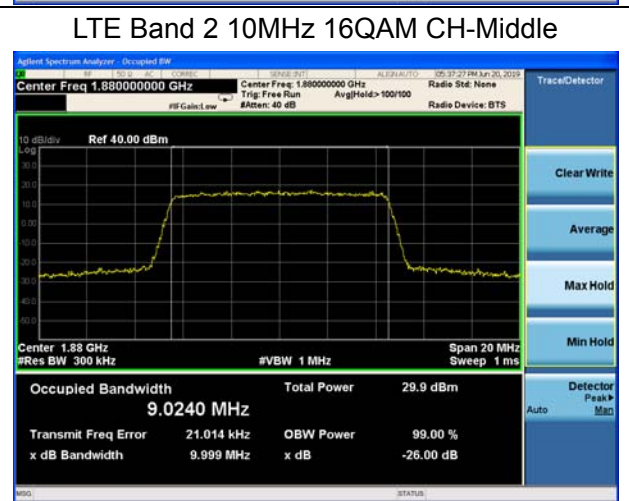
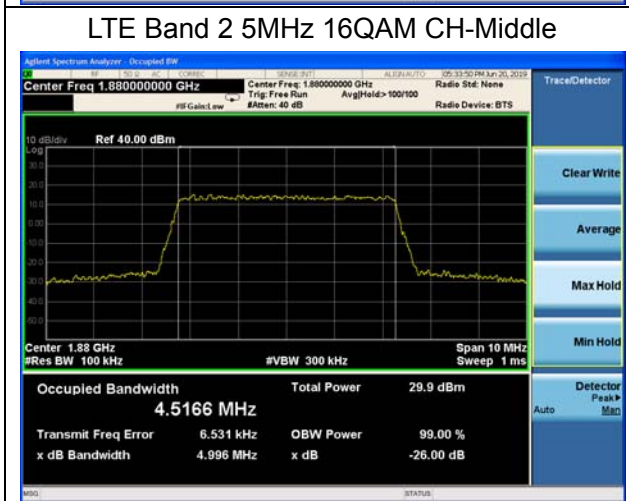
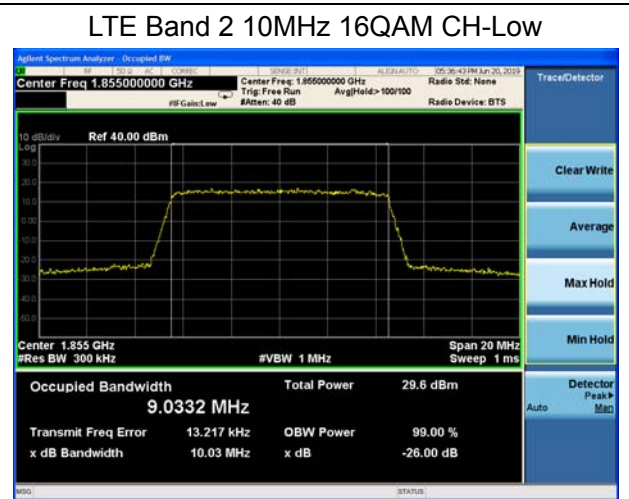
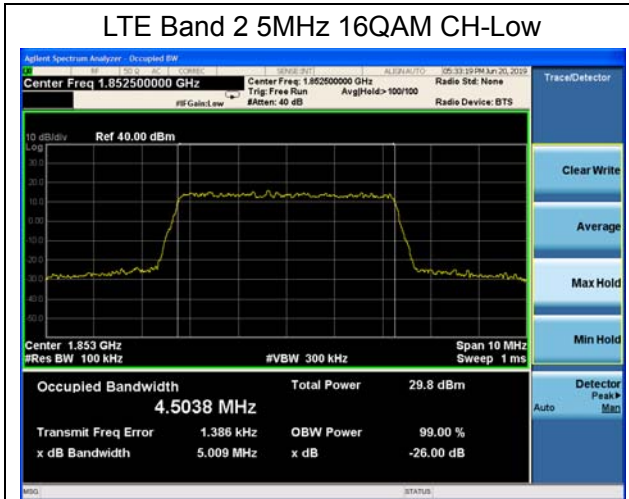

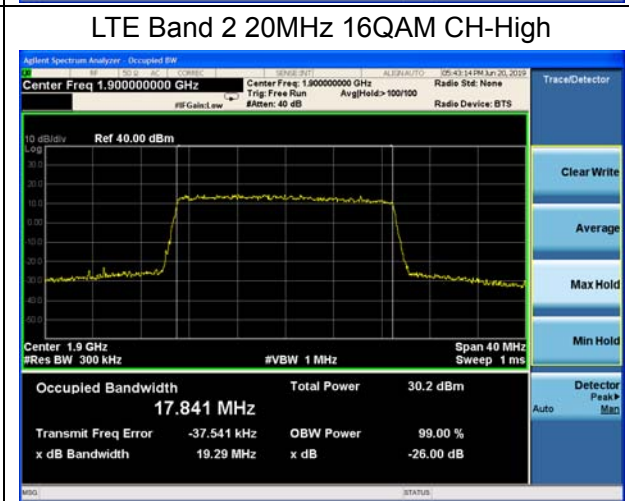
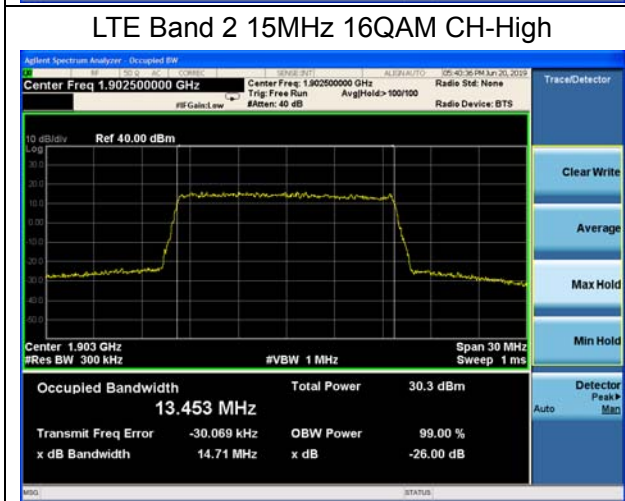
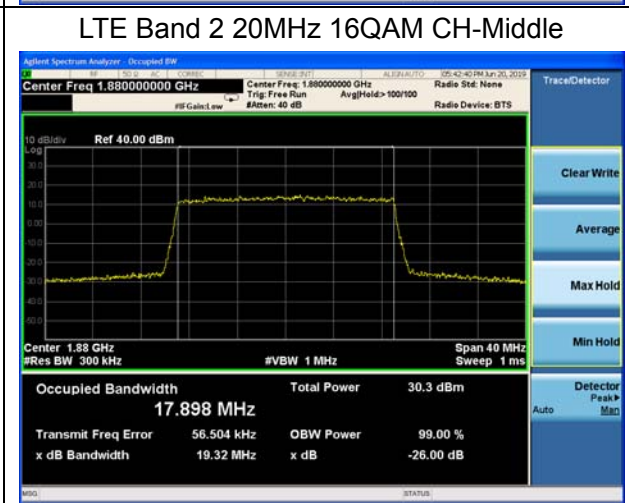
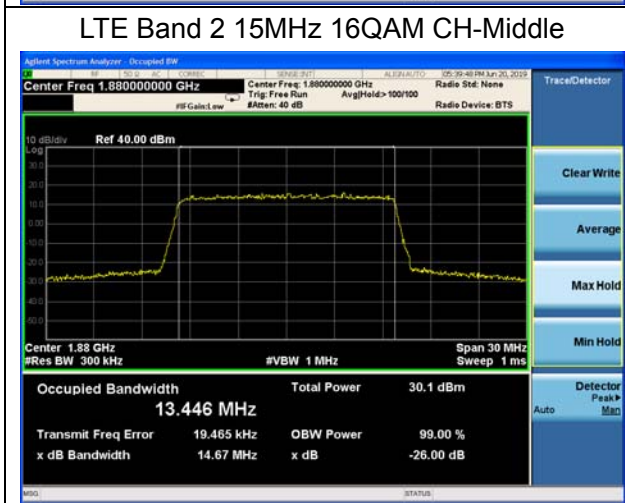
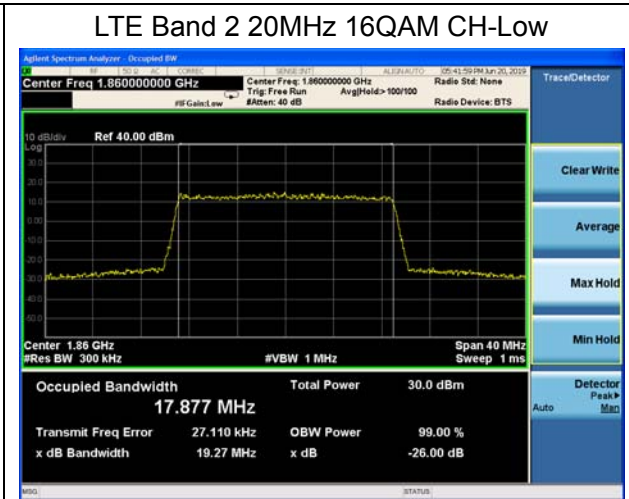
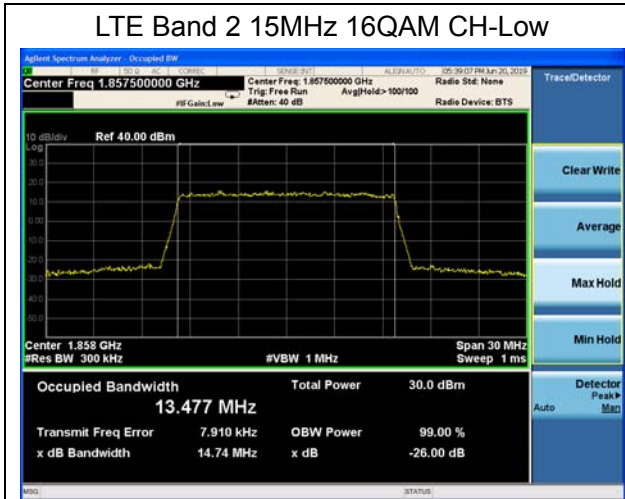

### 5.4. Band Edge Compliance

**Ambient condition**

Temperature	Relative humidity	Pressure
23°C ~25°C	45%~50%	101.5kPa

**Method of Measurement**

The EUT was connected to Spectrum Analyzer and Base Station Simulator via power Splitter. The band edge of the lowest and highest channels were measured. The Average detector is used and RBW is set to 51kHz, VBW is set to 160kHz for WCDMA Band II, RBW is set to 15kHz, VBW is set to 51kHz for LTE Band 2 (1.4MHz), RBW is set to 30kHz, VBW is set to 100kHz for LTE Band 2 (3MHz), RBW is set to 51kHz, VBW is set to 160kHz for LTE Band 2 (5MHz), RBW is set to 100kHz, VBW is set to 300kHz for LTE Band 2 (10MHz), RBW is set to 150kHz, VBW is set to 510kHz for LTE Band 2 (15MHz), RBW is set to 200kHz, VBW is set to 620kHz for LTE Band 2 (20MHz). Spectrum analyzer plots are included on the following pages.

**Test Setup**

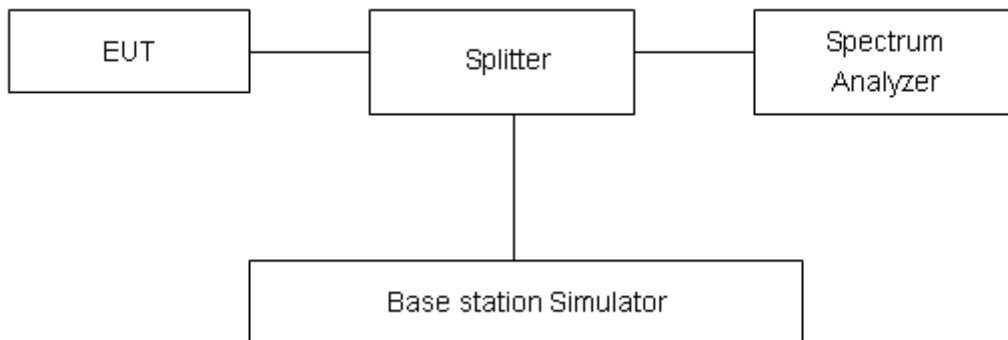

**Limits**

Rule Part 24.238(a) specifies that “on any frequency outside a licensee’s frequency block, the power of any emission shall be attenuated below the transmitter power (P) by at least 43 + 10 log10 (P) dB.”

Limit	-13 dBm
-------	---------

**Measurement Uncertainty**

The assessed measurement uncertainty to ensure 95% confidence level for the normal distribution is with the coverage factor  $k = 1.96$ ,  $U=0.684$ dB.



Test Result:

WCDMA Band II RMC CH-Low



WCDMA Band II RMC CH-High



LTE Band 2 1.4MHz QPSK 1RB CH-Low



LTE Band 2 1.4MHz QPSK 1RB CH-High

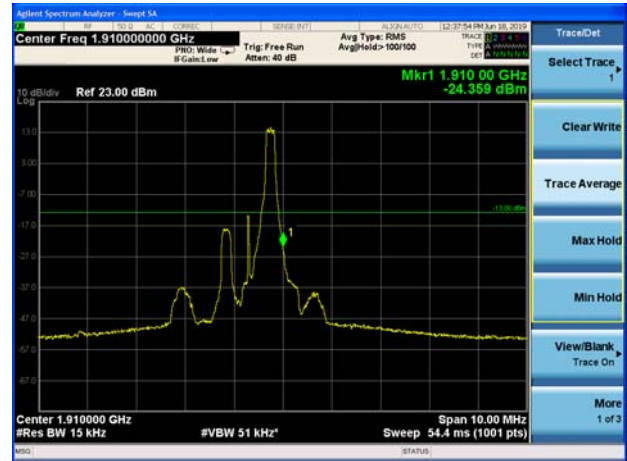

LTE Band 2 1.4MHz QPSK 100%RB CH-Low

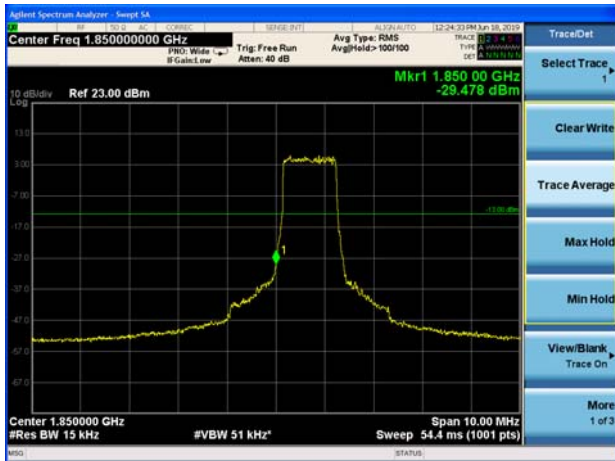

LTE Band 2 1.4MHz QPSK 100%RB CH-High

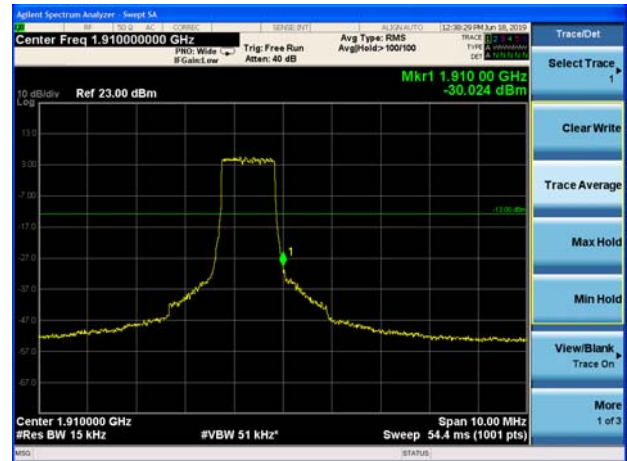





LTE Band 2 3MHz QPSK 1RB CH-Low

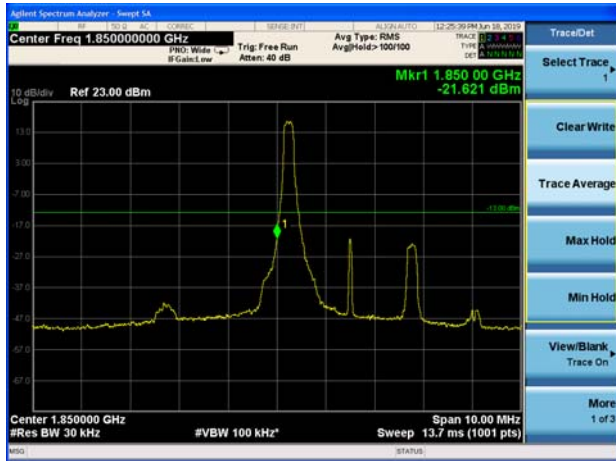

LTE Band 2 3MHz QPSK 1RB CH-High

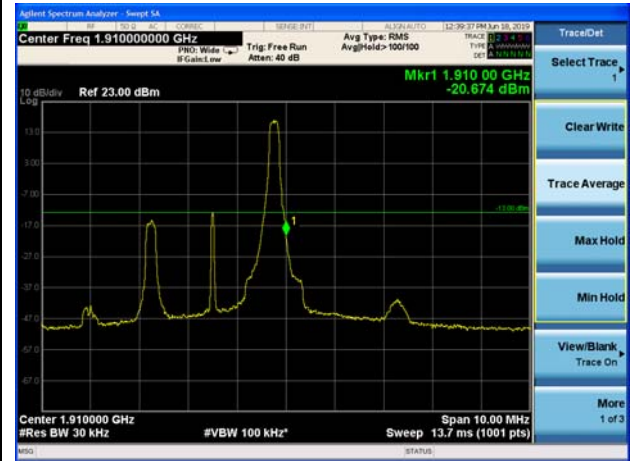

LTE Band 2 3MHz QPSK 100%RB CH-Low

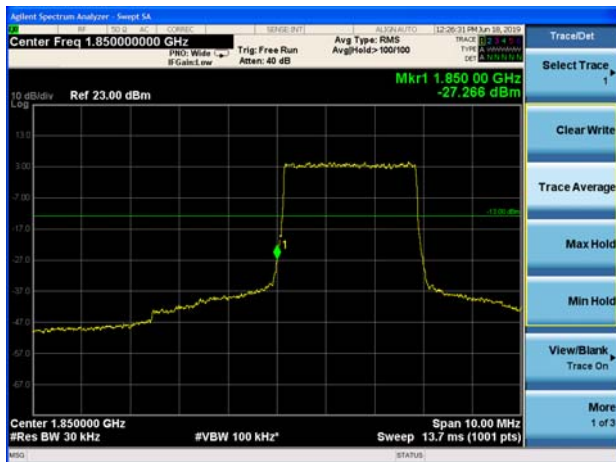

LTE Band 2 3MHz QPSK 100%RB CH-High



LTE Band 2 5MHz QPSK 1RB CH-Low

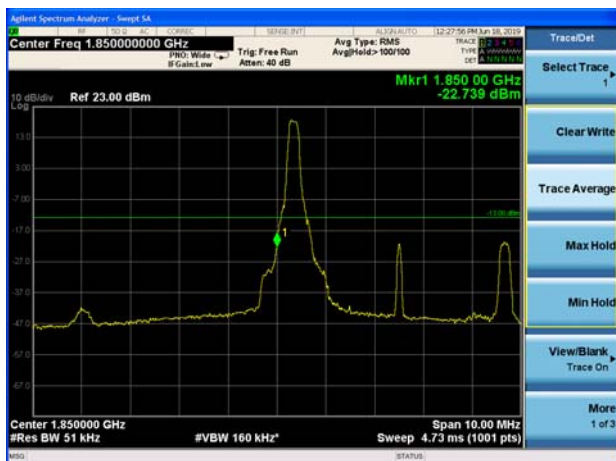

LTE Band 2 5MHz QPSK 1RB CH-High

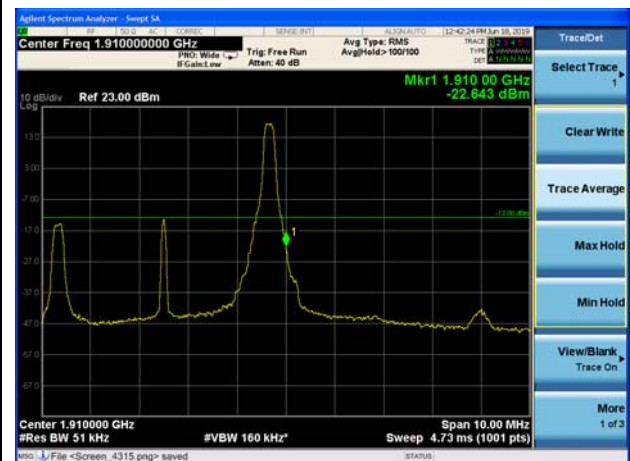



LTE Band 2 5MHz QPSK 100%RB CH-Low

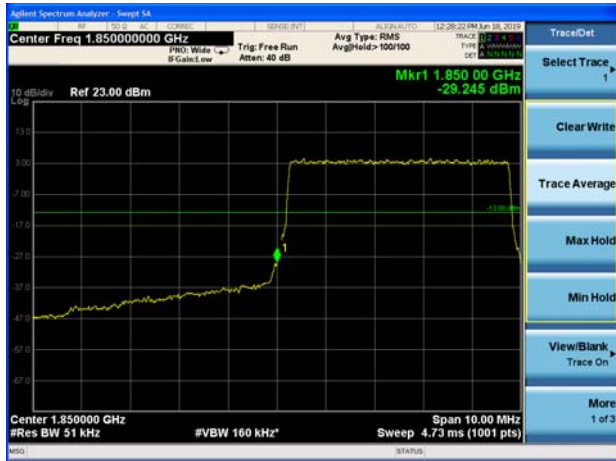

LTE Band 2 5MHz QPSK 100%RB CH-High



LTE Band 2 10MHz QPSK 1RB CH-Low

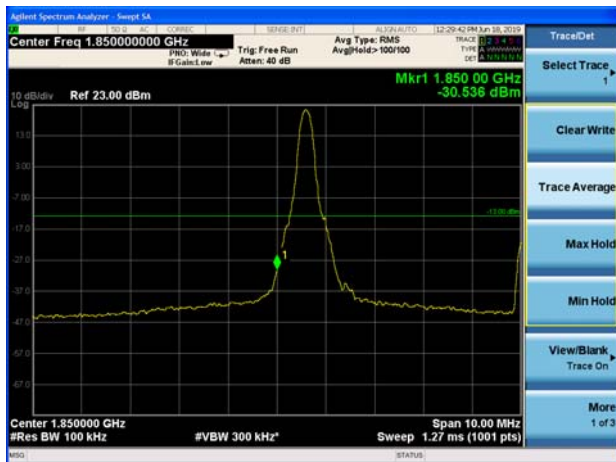

LTE Band 2 10MHz QPSK 1RB CH-High

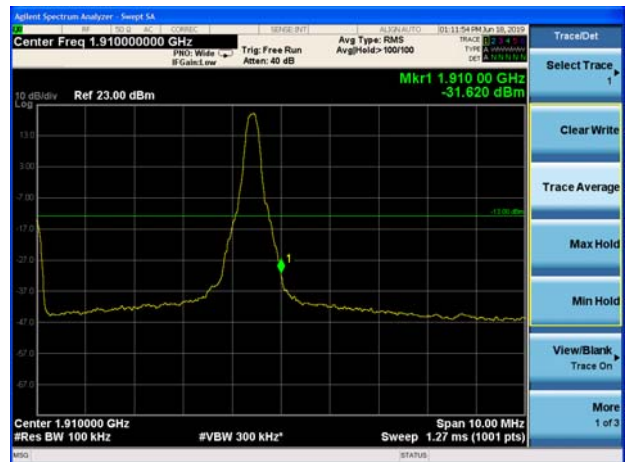

LTE Band 2 10MHz QPSK 100%RB CH-Low

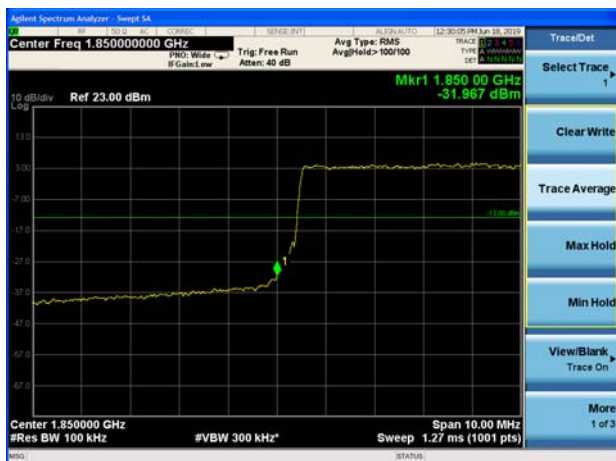

LTE Band 2 10MHz QPSK 100%RB CH-High





LTE Band 2 15MHz QPSK 1RB CH-Low

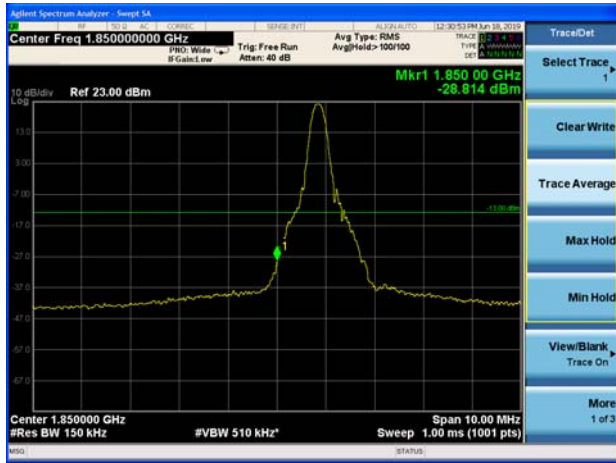

LTE Band 2 15MHz QPSK 1RB CH-High

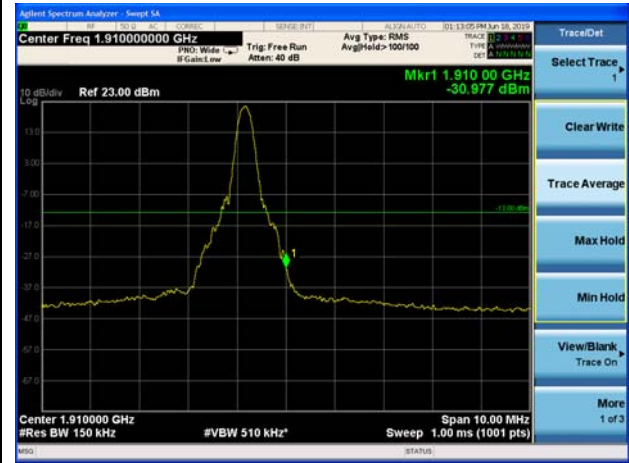

LTE Band 2 15MHz QPSK 100%RB CH-Low



LTE Band 2 15MHz QPSK 100%RB CH-High



LTE Band 2 20MHz QPSK 1RB CH-Low

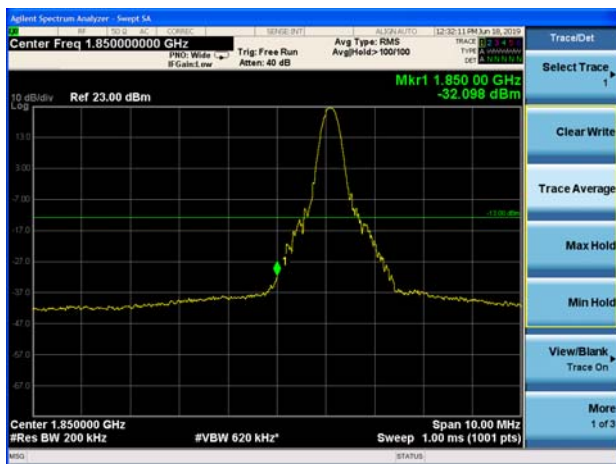

LTE Band 2 20MHz QPSK 1RB CH-High

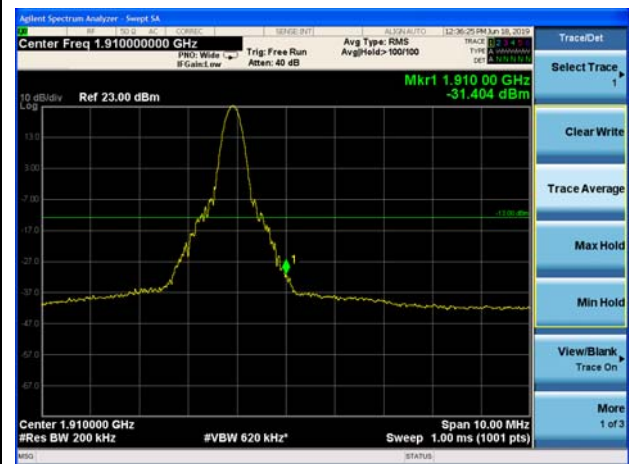





LTE Band 2 20MHz QPSK 100%RB CH-Low



LTE Band 2 20MHz QPSK 100%RB CH-High

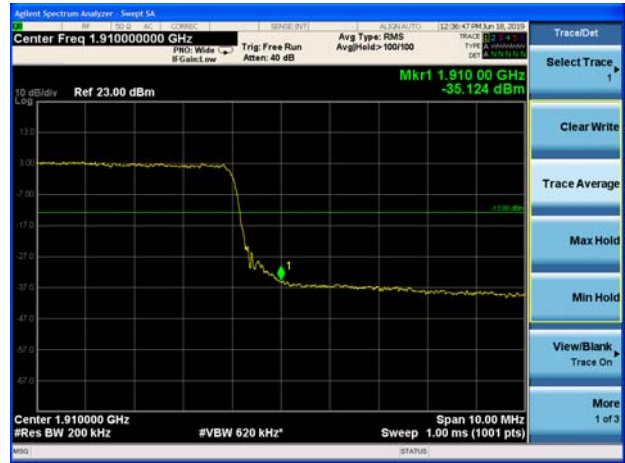

LTE Band 2 1.4MHz 16QAM 1RB CH-Low

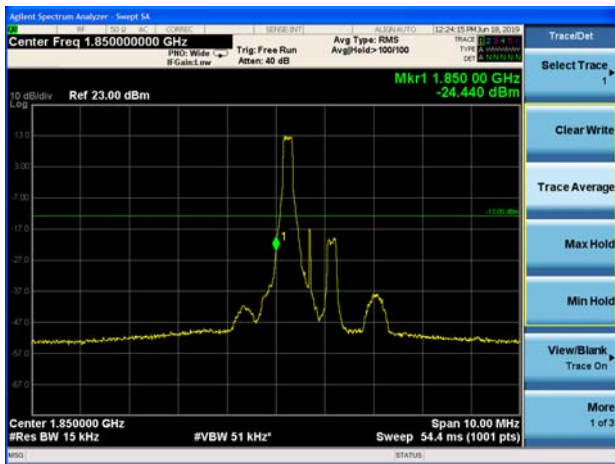

LTE Band 2 1.4MHz 16QAM 1RB CH-High

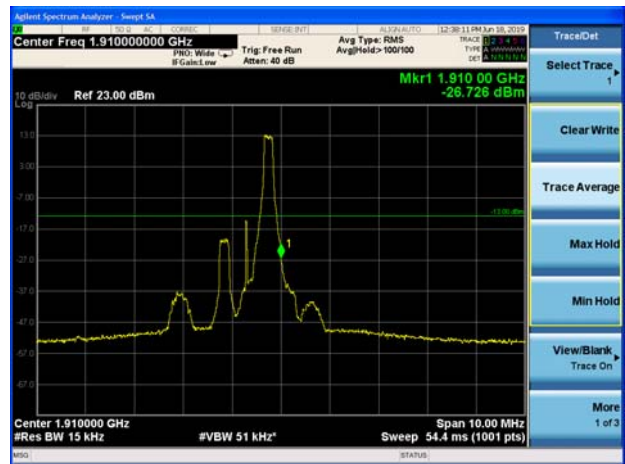

LTE Band 2 1.4MHz 16QAM 100%RB CH-Low

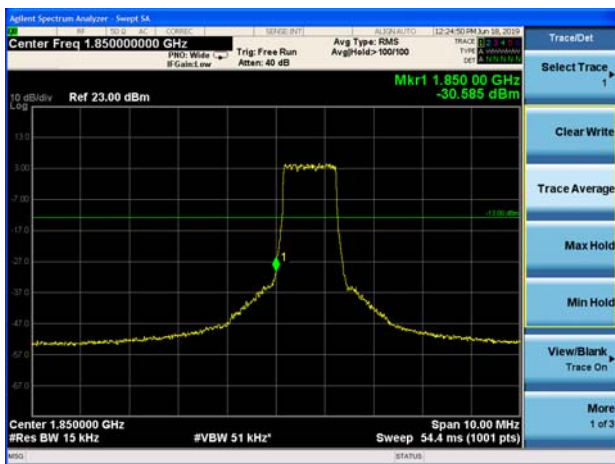

LTE Band 2 1.4MHz 16QAM 100%RB CH-High

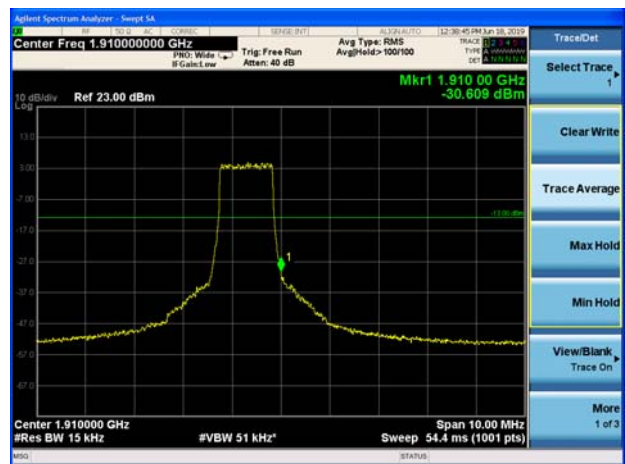



LTE Band 2 3MHz 16QAM 1RB CH-Low

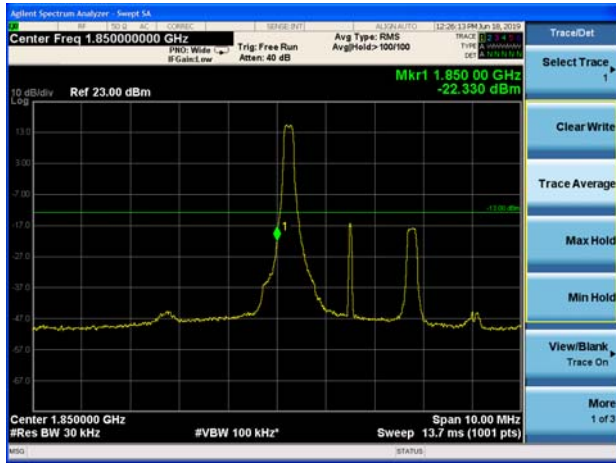

LTE Band 2 3MHz 16QAM 1RB CH-High

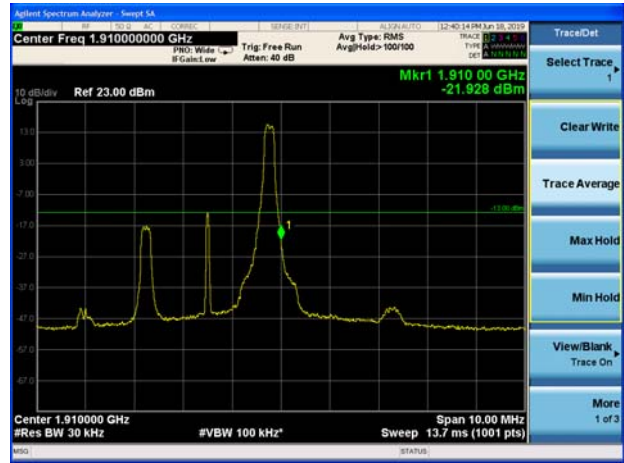

LTE Band 2 3MHz 16QAM 100%RB CH-Low



LTE Band 2 3MHz 16QAM 100%RB CH-High



LTE Band 2 5MHz 16QAM 1RB CH-Low

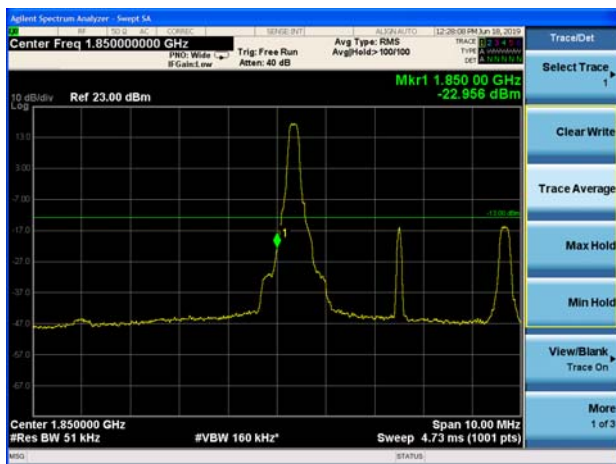

LTE Band 2 5MHz 16QAM 1RB CH-High

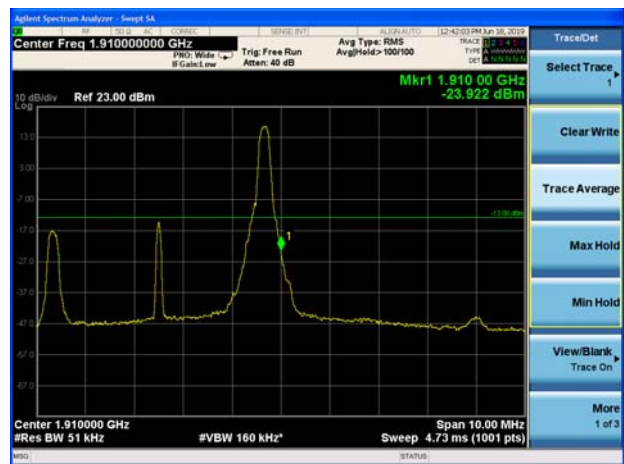



LTE Band 2 5MHz 16QAM 100%RB CH-Low

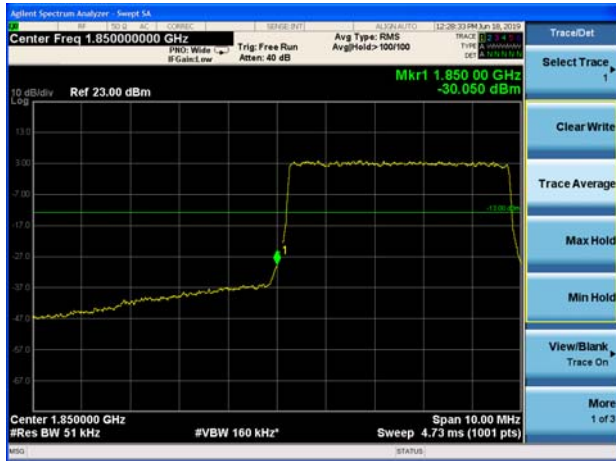

LTE Band 2 5MHz 16QAM 100%RB CH-High



LTE Band 2 10MHz 16QAM 1RB CH-Low

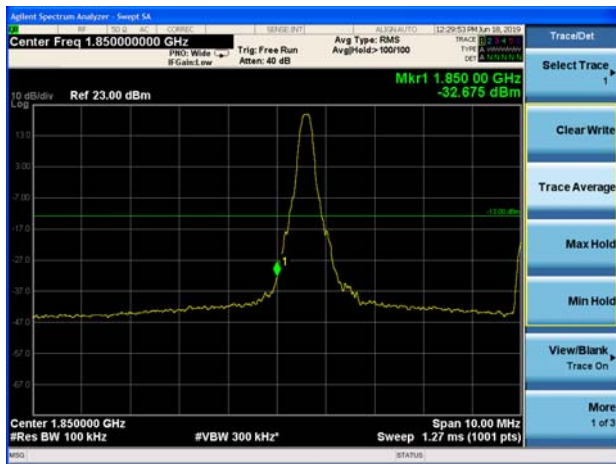

LTE Band 2 10MHz 16QAM 1RB CH-High

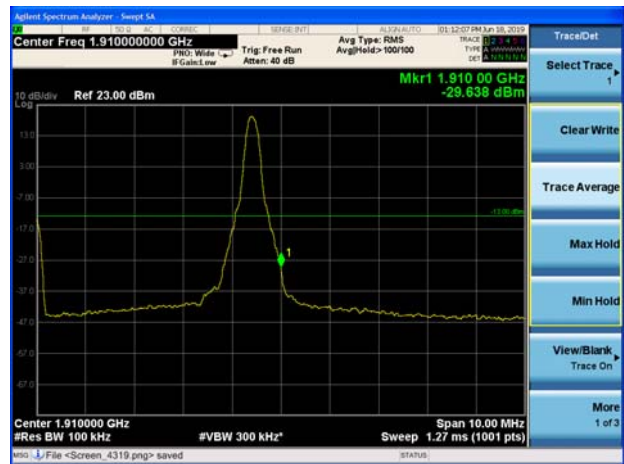

LTE Band 2 10MHz 16QAM 100%RB CH-Low

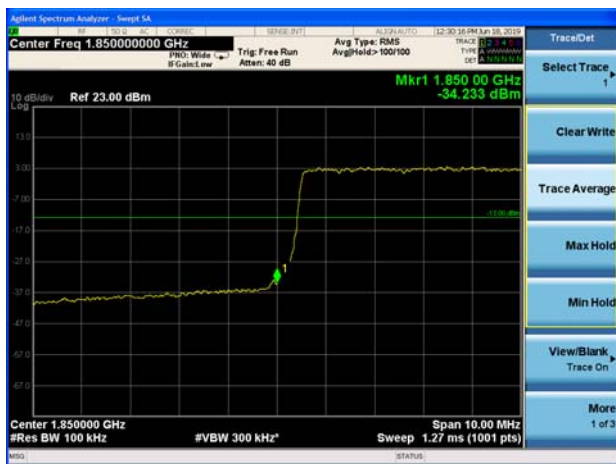

LTE Band 2 10MHz 16QAM 100%RB CH-High

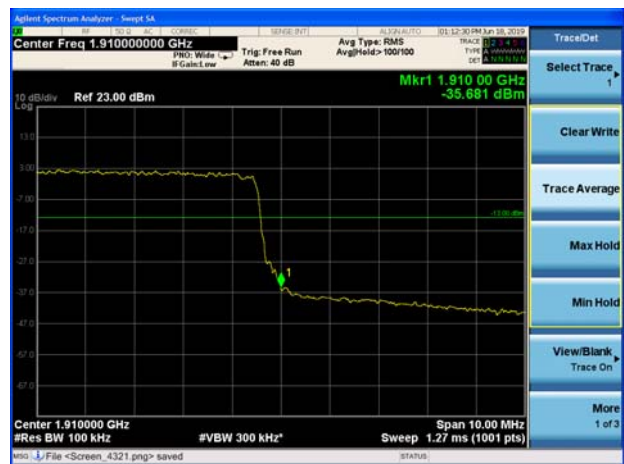



LTE Band 2 15MHz 16QAM 1RB CH-Low

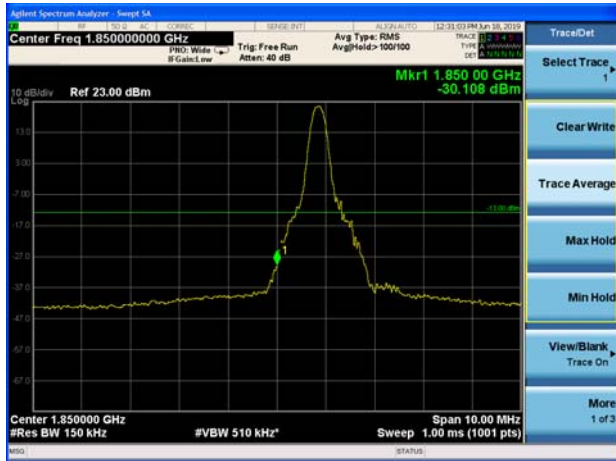

LTE Band 2 15MHz 16QAM 1RB CH-High

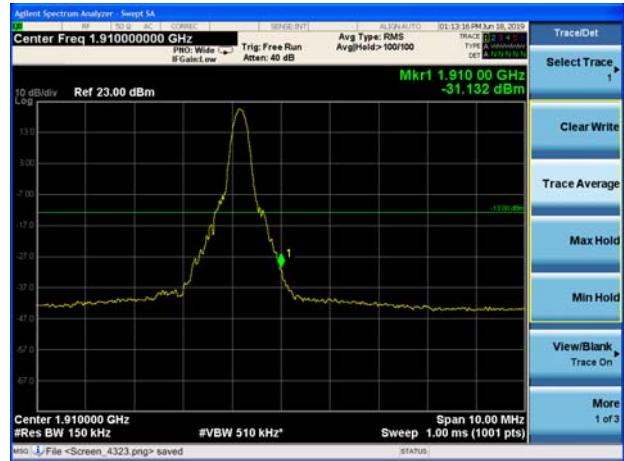

LTE Band 2 15MHz 16QAM 100%RB CH-Low

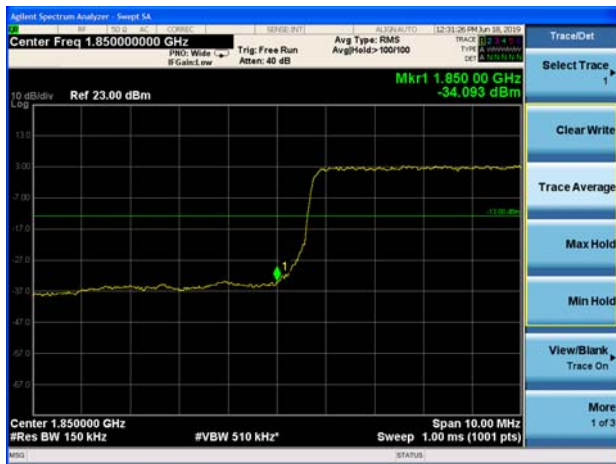

LTE Band 2 15MHz 16QAM 100%RB CH-High

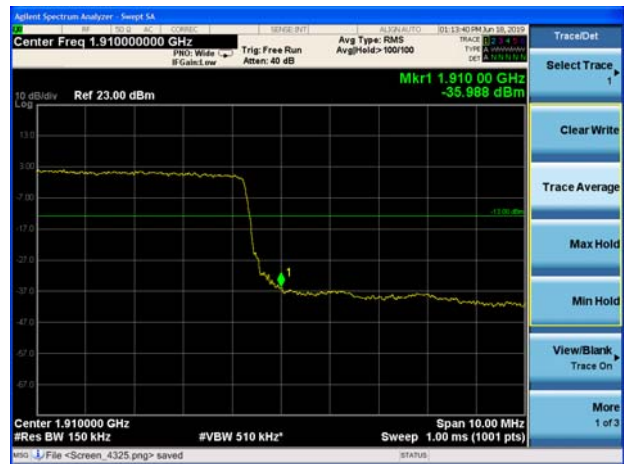

LTE Band 2 20MHz 16QAM 1RB CH-Low

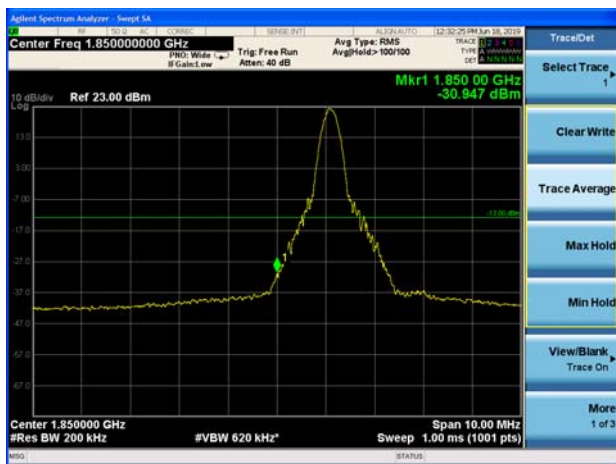

LTE Band 2 20MHz 16QAM 1RB CH-High

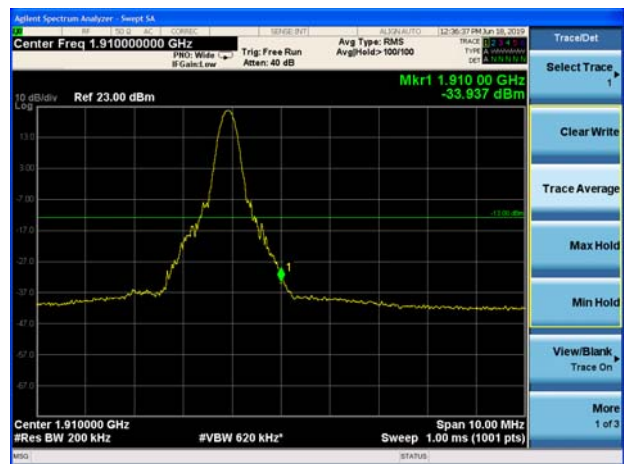



LTE Band 2 20MHz 16QAM 100%RB CH-Low



LTE Band 2 20MHz 16QAM 100%RB CH-High



### 5.5. Peak-to-Average Power Ratio (PAPR)

#### Ambient condition

Temperature	Relative humidity	Pressure
23°C ~25°C	45%~50%	101.5kPa

#### Methods of Measurement

Measure the total peak power and record as PPk. And measure the total average power and record as PAvg. Both the peak and average power levels must be expressed in the same logarithmic units (e.g., dBm). Determine the PAPR from:

$$PAPR (dB) = PPk (dBm) - PAvg (dBm).$$

#### Test Setup

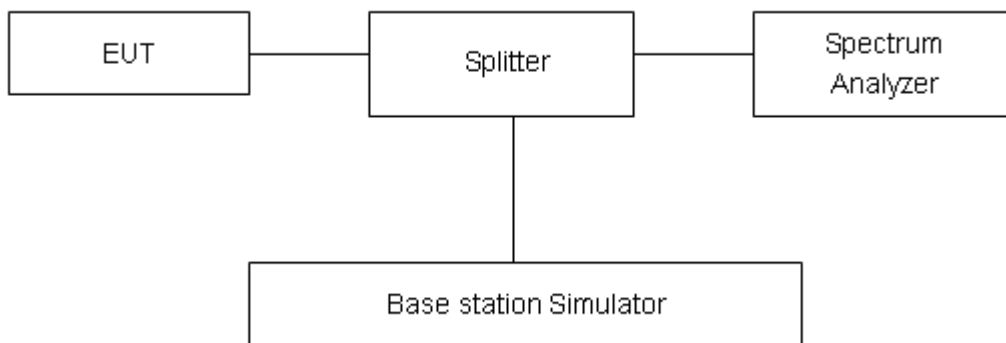

#### Limits

In measuring transmissions in this band using an average power technique, the peak-to-average ratio (PAR) of the transmission may not exceed 13 dB in 24.232(d).

#### Measurement Uncertainty

The assessed measurement uncertainty to ensure 95% confidence level for the normal distribution is with the coverage factor  $k = 2$ ,  $U = 0.4$  dB.





## Test Results

Mode	Channel	Frequency (MHz)	Peak(dBm)	Avg(dBm)	PAPR(dB)	Limit(dB)	Conclusion
WCDMA Band II (RMC)	9262	1852.4	27.52	24.34	3.18	≤13	PASS
	9400	1880	27.49	24.36	3.13	≤13	PASS
	9538	1907.6	27.11	23.94	3.17	≤13	PASS

LTE Band 2									
Modulation	Bandwidth (MHz)	Channel	Frequency (MHz)	Peak (dBm)	Avg (dBm)	PAPR (dB)	Limit (dB)	Conclusion	
QPSK	1.4	18607	1850.7	26.90	21.63	5.27	≤13	PASS	
		18900	1880.0	27.27	21.99	5.28	≤13	PASS	
		19193	1909.3	27.17	21.90	5.27	≤13	PASS	
	3	18615	1851.5	27.04	21.70	5.34	≤13	PASS	
		18900	1880	27.34	22.04	5.30	≤13	PASS	
		19185	1908.5	27.36	22.04	5.32	≤13	PASS	
	5	18625	1852.5	27.01	21.64	5.37	≤13	PASS	
		18900	1880	27.37	22.03	5.34	≤13	PASS	
		19175	1907.5	27.17	21.83	5.34	≤13	PASS	
	10	18650	1855	26.99	21.66	5.33	≤13	PASS	
		18900	1880	27.30	22.02	5.28	≤13	PASS	
		19150	1905	27.24	21.95	5.29	≤13	PASS	
	15	18675	1857.5	27.32	21.75	5.57	≤13	PASS	
		18900	1880	27.39	21.95	5.44	≤13	PASS	
		19125	1902.5	27.54	22.06	5.48	≤13	PASS	
	20	18700	1860	27.19	21.85	5.34	≤13	PASS	
		18900	1880	27.23	22.02	5.21	≤13	PASS	
		19100	1900	27.39	22.08	5.31	≤13	PASS	
	16QAM	1.4	18607	1850.7	26.89	20.80	6.09	≤13	PASS
			18900	1880.0	27.26	21.16	6.10	≤13	PASS
			19193	1909.3	27.29	21.15	6.14	≤13	PASS
		3	18615	1851.5	26.76	20.56	6.20	≤13	PASS
			18900	1880	27.26	21.09	6.17	≤13	PASS
			19185	1908.5	27.20	21.03	6.17	≤13	PASS
5		18625	1852.5	26.82	20.63	6.19	≤13	PASS	
		18900	1880	27.34	21.20	6.14	≤13	PASS	
		19175	1907.5	27.14	20.99	6.15	≤13	PASS	
10		18650	1855	26.88	20.71	6.17	≤13	PASS	
		18900	1880	26.99	20.88	6.11	≤13	PASS	
		19150	1905	27.02	20.88	6.14	≤13	PASS	
15		18675	1857.5	26.99	20.70	6.29	≤13	PASS	



		18900	1880	27.18	21.01	6.17	≤13	PASS
		19125	1902.5	27.33	21.12	6.21	≤13	PASS
	20	18700	1860	26.98	20.78	6.20	≤13	PASS
		18900	1880	27.15	21.08	6.07	≤13	PASS
		19100	1900	27.43	21.32	6.11	≤13	PASS



## 5.6. Frequency Stability

### Ambient condition

Temperature	Relative humidity	Pressure
23°C ~25°C	45%~50%	101.5kPa

### Method of Measurement

#### Frequency Stability (Temperature Variation)

The temperature inside the climate chamber is varied from -40°C to +85°C in 10°C step size,

(1) With all power removed, the temperature was decreased to 0°C and permitted to stabilize for three hours.

(2) Measure the carrier frequency with the test equipment in a “call mode”. These measurements should be made within 1 minute of powering up the mobile station, to prevent significant self warming.

(3) Repeat the above measurements at 10°C increments from -40°C to +85°C. Allow at least 1.5 hours at each temperature, un-powered, before making measurements.

#### Frequency Stability (Voltage Variation)

The frequency stability shall be measured with variation of primary supply voltage as follows:

(1) Vary primary supply voltage from 85 to 115 percent of the nominal value for other than hand carried battery equipment.

(2) For hand carried, battery powered equipment, reduce primary supply voltage to the battery-operating end point which shall be specified by the manufacturer.

This transceiver is specified to operate with an input voltage of between 3.3 V and 4.3 V, with a nominal voltage of 3.8V.

### Test setup

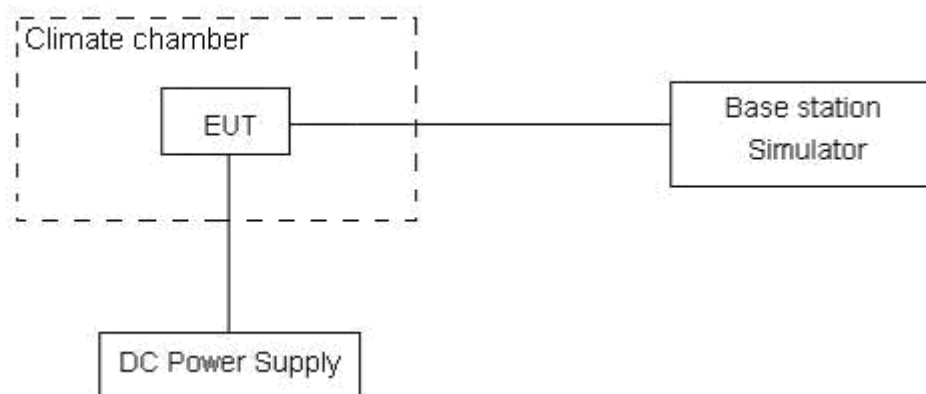

**Limits**

The frequency stability shall be sufficient to ensure that the fundamental emission stays within the authorized frequency block

**Measurement Uncertainty**

The assessed measurement uncertainty to ensure 99.75% confidence level for the normal distribution is with the coverage factor  $k = 3$ ,  $U = 0.01\text{ppm}$ .

**Test Result**

WCDMA Band 2						
Condition		Freq.Error (Hz)	Freq.Error (Hz)	Frequency Stability (ppm)	Frequency Stability (ppm)	Verdict
Temperature	Voltage	QPSK	BPSK	QPSK	BPSK	
Normal (25°C)	Normal	17.95	4.94	0.00955	0.00263	PASS
Normal (85°C)		12.70	17.74	0.00675	0.00944	PASS
Normal (80°C)		10.39	4.97	0.00552	0.00265	PASS
Normal (70°C)		1.75	3.98	0.00093	0.00211	PASS
Extreme (60°C)		11.48	12.54	0.00611	0.00667	PASS
Extreme (50°C)		3.57	14.84	0.00190	0.00789	PASS
Extreme (40°C)		3.82	1.08	0.00203	0.00058	PASS
Extreme (30°C)		14.82	1.17	0.00788	0.00062	PASS
Extreme (20°C)		10.43	5.07	0.00555	0.00270	PASS
Extreme (10°C)		13.81	17.72	0.00735	0.00943	PASS
Extreme (0°C)		13.57	7.71	0.00722	0.00410	PASS
Extreme (-10°C)		7.85	14.55	0.00417	0.00774	PASS
Extreme (-20°C)		15.47	14.76	0.00823	0.00785	PASS
Extreme (-30°C)		16.23	12.10	0.00863	0.00644	PASS
Extreme (-40°C)		3.93	8.06	0.00209	0.00429	PASS
25°C	LV	3.95	5.51	0.00210	0.00293	PASS
	HV	10.63	16.29	0.00565	0.00867	PASS

LTE Band 2						
Condition		Freq.Error (Hz)	Freq.Error (Hz)	Frequency Stability (ppm)	Frequency Stability (ppm)	Verdict
BANDWIDTH	1.4MHz	16QAM	QPSK	16QAM	QPSK	
Temperature	Normal	11.59	6.37	0.00617	0.00339	PASS
Normal (25°C)		3.44	8.91	0.00183	0.00474	PASS
Extreme (85°C)		17.56	16.59	0.00934	0.00883	PASS
Extreme (80°C)		6.37	13.26	0.00339	0.00705	PASS
Extreme (70°C)		11.13	16.93	0.00592	0.00901	PASS
Extreme (60°C)		2.23	6.95	0.00119	0.00370	PASS
Extreme (50°C)		9.08	1.50	0.00483	0.00080	PASS
Extreme (40°C)		4.48	11.95	0.00238	0.00636	PASS
Extreme (30°C)		6.86	13.88	0.00365	0.00738	PASS
Extreme (20°C)						



Extreme (10°C)		13.41	1.82	0.00713	0.00097	PASS
Extreme (0°C)		12.27	16.71	0.00653	0.00889	PASS
Extreme (-10°C)		9.46	15.57	0.00503	0.00828	PASS
Extreme (-20°C)		5.29	11.93	0.00281	0.00635	PASS
Extreme (-30°C)		13.00	13.00	0.00691	0.00691	PASS
Extreme (-40°C)		5.07	13.58	0.00270	0.00722	PASS
25°C	LV	15.18	9.49	0.00808	0.00505	PASS
	HV	14.73	6.27	0.00783	0.00333	PASS
Condition		Freq.Error (Hz)	Freq.Error (Hz)	Frequency Stability (ppm)	Frequency Stability (ppm)	Verdict
BANDWIDTH	3MHz					
Temperature	Voltage	16QAM	QPSK	16QAM	QPSK	
Normal (25°C)		7.28	16.06	0.00387	0.00854	PASS
Extreme (85°C)		12.54	11.85	0.00667	0.00630	PASS
Extreme (80°C)		13.07	4.24	0.00695	0.00226	PASS
Extreme (70°C)		1.98	3.95	0.00106	0.00210	PASS
Extreme (60°C)		14.73	10.96	0.00784	0.00583	PASS
Extreme (50°C)		3.04	7.01	0.00161	0.00373	PASS
Extreme (40°C)		7.46	17.99	0.00397	0.00957	PASS
Extreme (30°C)		2.39	8.79	0.00127	0.00468	PASS
Extreme (20°C)		15.28	10.39	0.00813	0.00553	PASS
Extreme (10°C)		9.92	3.98	0.00528	0.00212	PASS
Extreme (0°C)		6.32	10.68	0.00336	0.00568	PASS
Extreme (-10°C)		11.96	11.64	0.00636	0.00619	PASS
Extreme (-20°C)		2.04	1.82	0.00109	0.00097	PASS
Extreme (-30°C)		3.93	17.53	0.00209	0.00932	PASS
Extreme (-40°C)		10.68	6.69	0.00568	0.00356	PASS
25°C	LV	11.69	12.91	0.00622	0.00687	PASS
	HV	11.37	14.45	0.00605	0.00769	PASS
Condition		Freq.Error (Hz)	Freq.Error (Hz)	Frequency Stability (ppm)	Frequency Stability (ppm)	Verdict
BANDWIDTH	5MHz					
Temperature	Voltage	16QAM	QPSK	16QAM	QPSK	
Normal (25°C)		8.37	3.87	0.00445	0.00206	PASS
Extreme (85°C)		15.48	5.83	0.00823	0.00310	PASS
Extreme (80°C)		16.46	4.85	0.00876	0.00258	PASS
Extreme (70°C)		10.84	7.78	0.00577	0.00414	PASS
Extreme (60°C)		6.77	5.52	0.00360	0.00294	PASS
Extreme (50°C)		15.98	5.24	0.00850	0.00278	PASS
Extreme (40°C)		15.87	14.13	0.00844	0.00751	PASS
Extreme (30°C)		7.84	4.19	0.00417	0.00223	PASS
Extreme (20°C)		8.48	15.19	0.00451	0.00808	PASS



Extreme (10°C)		7.19	13.66	0.00383	0.00727	PASS
Extreme (0°C)		2.70	17.69	0.00143	0.00941	PASS
Extreme (-10°C)		3.28	9.26	0.00175	0.00493	PASS
Extreme (-20°C)		7.58	6.12	0.00403	0.00325	PASS
Extreme (-30°C)		14.44	12.74	0.00768	0.00678	PASS
Extreme (-40°C)		17.96	2.97	0.00956	0.00158	PASS
25°C	LV	15.05	11.95	0.00801	0.00636	PASS
	HV	16.65	12.02	0.00886	0.00639	PASS
Condition		Freq.Error (Hz)	Freq.Error (Hz)	Frequency Stability (ppm)	Frequency Stability (ppm)	Verdict
BANDWIDTH	10MHz					
Temperature	Voltage	16QAM	QPSK	16QAM	QPSK	
Normal (25°C)	Normal	1.99	3.67	0.00106	0.00195	PASS
Extreme (85°C)		13.02	16.76	0.00692	0.00892	PASS
Extreme (80°C)		13.79	3.45	0.00734	0.00184	PASS
Extreme (70°C)		16.98	7.97	0.00903	0.00424	PASS
Extreme (60°C)		10.74	5.04	0.00571	0.00268	PASS
Extreme (50°C)		12.11	9.28	0.00644	0.00494	PASS
Extreme (40°C)		10.01	10.82	0.00532	0.00576	PASS
Extreme (30°C)		7.68	6.54	0.00409	0.00348	PASS
Extreme (20°C)		9.45	4.71	0.00503	0.00251	PASS
Extreme (10°C)		16.82	6.18	0.00895	0.00329	PASS
Extreme (0°C)		13.61	8.20	0.00724	0.00436	PASS
Extreme (-10°C)		11.72	15.59	0.00624	0.00829	PASS
Extreme (-20°C)		12.10	5.16	0.00644	0.00275	PASS
Extreme (-30°C)		4.13	2.19	0.00220	0.00116	PASS
Extreme (-40°C)	10.77	7.86	0.00573	0.00418	PASS	
25°C	LV	11.46	2.68	0.00610	0.00143	PASS
	HV	3.66	6.95	0.00195	0.00370	PASS
Condition		Freq.Error (Hz)	Freq.Error (Hz)	Frequency Stability (ppm)	Frequency Stability (ppm)	Verdict
BANDWIDTH	15MHz					
Temperature	Voltage	16QAM	QPSK	16QAM	QPSK	
Normal (25°C)	Normal	2.32	17.47	0.00124	0.00929	PASS
Extreme (85°C)		7.05	8.32	0.00375	0.00442	PASS
Extreme (80°C)		7.36	16.36	0.00391	0.00870	PASS
Extreme (70°C)		6.27	13.81	0.00333	0.00734	PASS
Extreme (60°C)		7.62	16.34	0.00406	0.00869	PASS
Extreme (50°C)		2.48	8.03	0.00132	0.00427	PASS
Extreme (40°C)		16.19	13.94	0.00861	0.00741	PASS
Extreme (30°C)		4.28	3.35	0.00228	0.00178	PASS
Extreme (20°C)		5.33	2.81	0.00283	0.00149	PASS



Extreme (10°C)		5.98	16.25	0.00318	0.00864	PASS
Extreme (0°C)		11.40	10.37	0.00606	0.00552	PASS
Extreme (-10°C)		13.12	17.82	0.00698	0.00948	PASS
Extreme (-20°C)		11.89	6.69	0.00633	0.00356	PASS
Extreme (-30°C)		12.72	5.40	0.00676	0.00287	PASS
Extreme (-40°C)		12.56	15.84	0.00668	0.00843	PASS
25°C	LV	2.94	9.40	0.00156	0.00500	PASS
	HV	4.90	15.94	0.00261	0.00848	PASS
Condition		Freq.Error (Hz)	Freq.Error (Hz)	Frequency Stability (ppm)	Frequency Stability (ppm)	Verdict
BANDWIDTH	20MHz					
Temperature	Voltage	16QAM	QPSK	16QAM	QPSK	
Normal (25°C)	Normal	8.71	16.96	0.00463	0.00902	PASS
Extreme (85°C)		14.53	8.16	0.00773	0.00434	PASS
Extreme (80°C)		9.40	3.31	0.00500	0.00176	PASS
Extreme (70°C)		10.79	3.30	0.00574	0.00175	PASS
Extreme (60°C)		7.89	2.36	0.00420	0.00126	PASS
Extreme (50°C)		7.95	10.05	0.00423	0.00535	PASS
Extreme (40°C)		5.43	3.14	0.00289	0.00167	PASS
Extreme (30°C)		6.95	9.42	0.00370	0.00501	PASS
Extreme (20°C)		2.98	9.43	0.00158	0.00501	PASS
Extreme (10°C)		11.10	6.34	0.00591	0.00337	PASS
Extreme (0°C)		8.04	8.92	0.00428	0.00474	PASS
Extreme (-10°C)		10.82	9.63	0.00576	0.00512	PASS
Extreme (-20°C)		15.79	17.15	0.00840	0.00912	PASS
Extreme (-30°C)		6.30	12.90	0.00335	0.00686	PASS
Extreme (-40°C)	14.11	8.08	0.00750	0.00430	PASS	
25°C	LV	11.68	14.27	0.00621	0.00759	PASS
	HV	2.83	13.69	0.00150	0.00728	PASS

### 5.7. Spurious Emissions at Antenna Terminals

#### Ambient condition

Temperature	Relative humidity	Pressure
23°C ~25°C	45%~50%	101.5kPa

#### Method of Measurement

The EUT was connected to Spectrum Analyzer and Base Station Simulator via power Splitter. The measurement is carried out using a spectrum analyzer. The spectrum analyzer scans from 9kHz to the 10th harmonic of the carrier. The peak detector is used.

RBW is set to 100kHz, VBW is set to 300kHz for 30MHz~1GHz

RBW is set to 1MHz, VBW is set to 3MHz for above 1GHz, Sweep is set to ATUO.

The modulation mode and RB allocation refer to section 5.1, using the maximum output power configuration.

#### Test setup

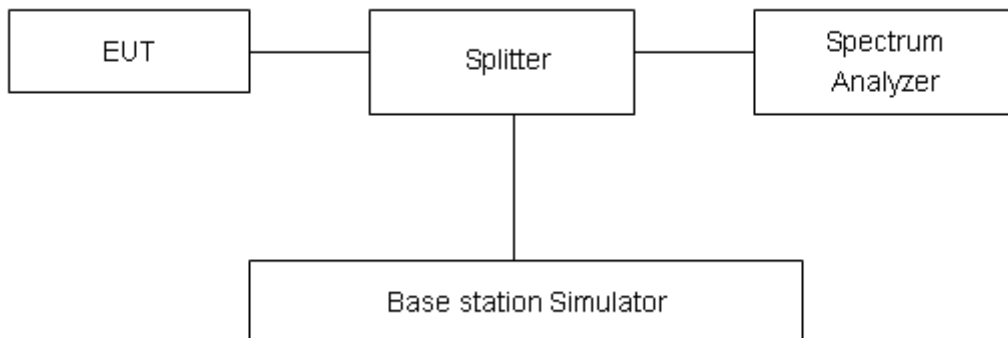

#### Limits

Rule Part 24.238(a) specifies that “on any frequency outside a licensee's frequency block, the power of any emission shall be attenuated below the transmitter power (P) by at least 43 + 10 log<sub>10</sub> (P) dB.”

Limit	-13 dBm
-------	---------

#### Measurement Uncertainty

The assessed measurement uncertainty to ensure 99.75% confidence level for the normal distribution is with the coverage factor  $k = 1.96$ .

Frequency	Uncertainty
9kHz-1GHz	0.684 dB
1GHz-20GHz	1.407 dB

**Test Result**

Sweep the whole frequency band through the range from 9kHz to the 10th harmonic of the carrier, the emissions more than 20 dB below the limit are not reported.

The signal beyond the limit is carrier.

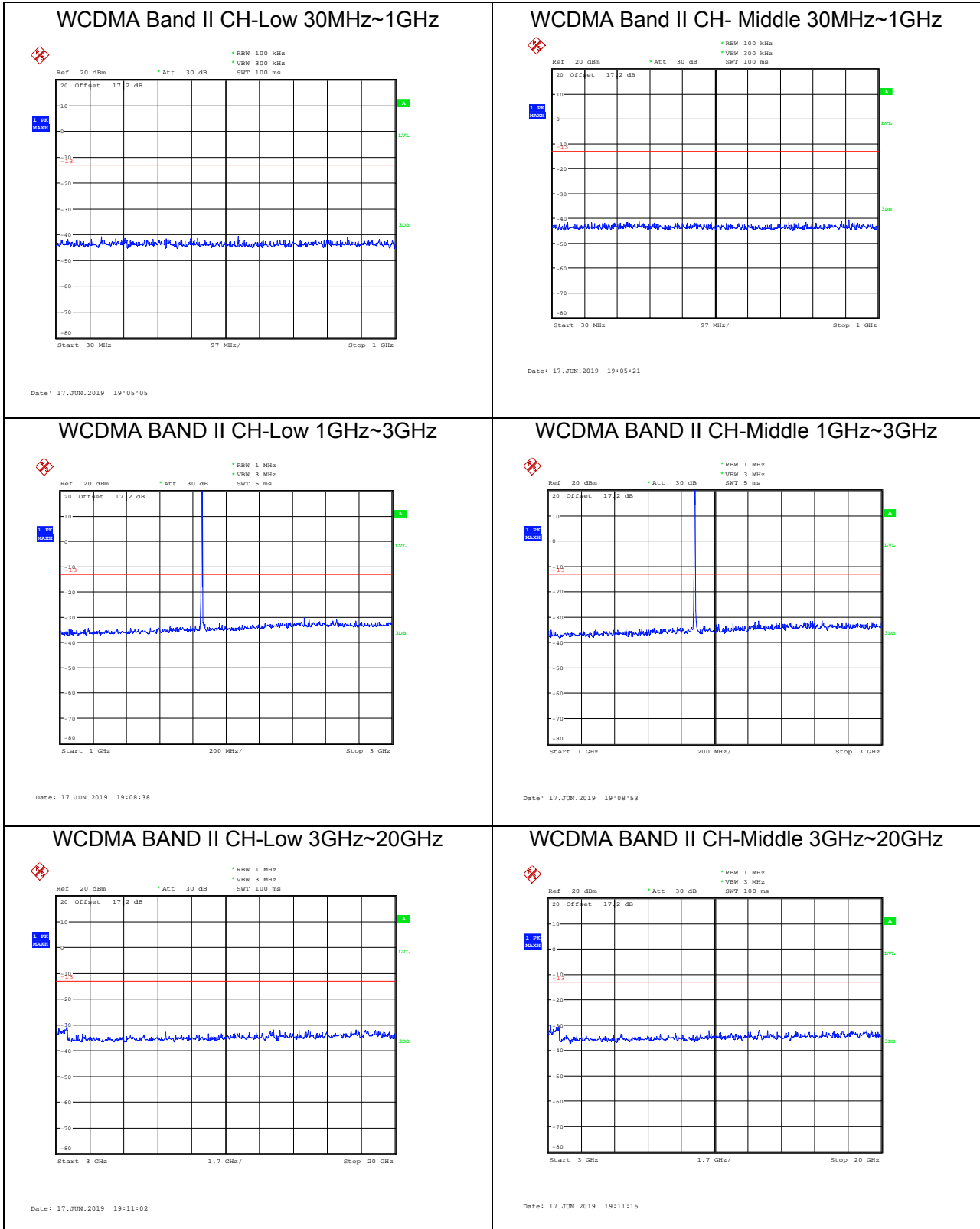





### WCDMA Band II CH- High 30MHz~1GHz

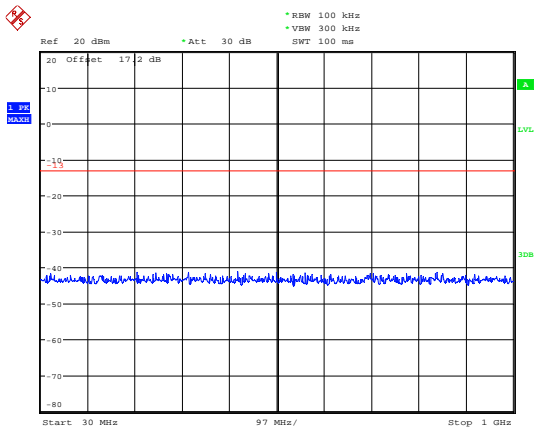

Date: 17.JUN.2019 19:05:42

### WCDMA BAND II CH-High 1GHz~3GHz

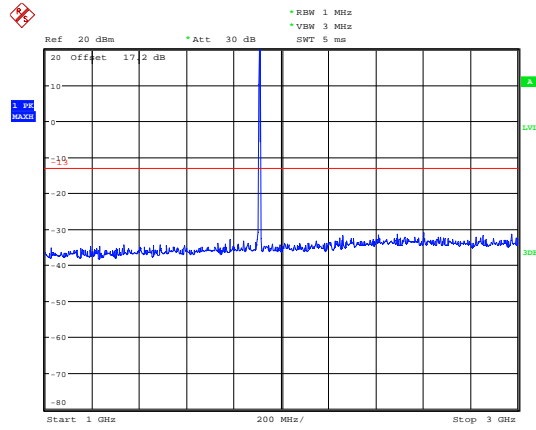

Date: 17.JUN.2019 19:09:09

### WCDMA BAND II CH-High 3GHz~20GHz

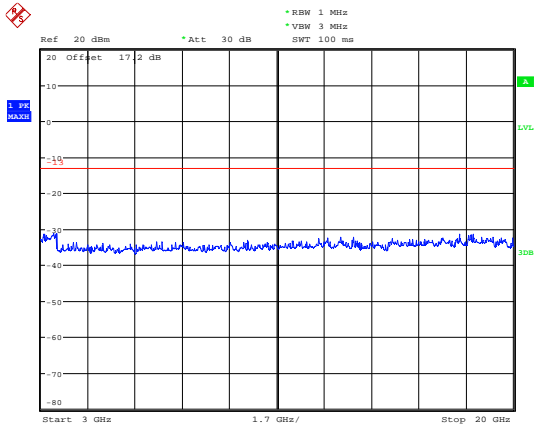

Date: 17.JUN.2019 19:11:31



### LTE Band 2 1.4MHz CH-Low 30MHz~1GHz

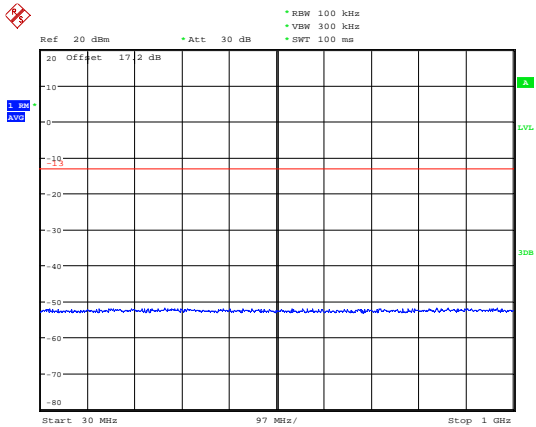

Date: 3.JUL.2019 11:01:29

### LTE Band 2 1.4MHz CH-Middle 30MHz~1GHz

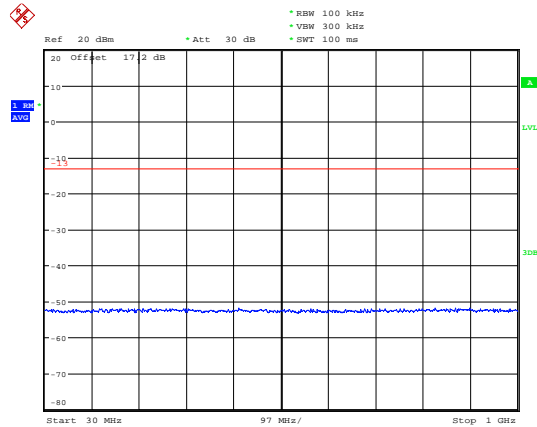

Date: 3.JUL.2019 11:01:47

### LTE Band 2 1.4MHz CH-Low 1GHz~3GHz

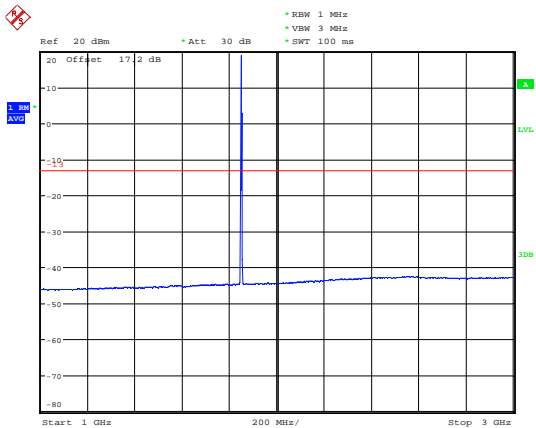

Date: 3.JUL.2019 11:12:38

### LTE Band 2 1.4MHz CH-Middle 1GHz~3GHz

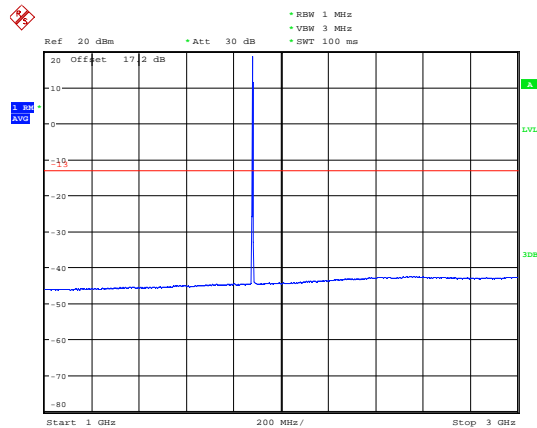

Date: 3.JUL.2019 11:12:50

### LTE Band 2 1.4MHz CH-Low 3GHz~20GHz

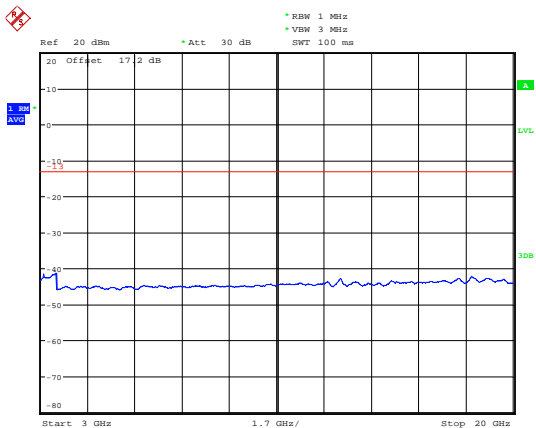

Date: 3.JUL.2019 11:42:39

### LTE Band 2 1.4MHz CH-Middle 3GHz~20GHz

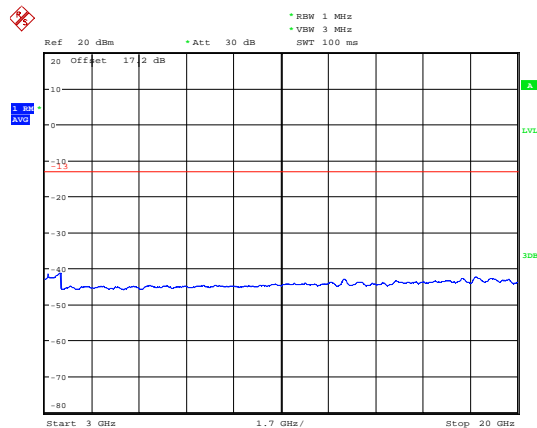

Date: 3.JUL.2019 11:42:54



### LTE Band 2 1.4MHz CH-High 30MHz~1GHz

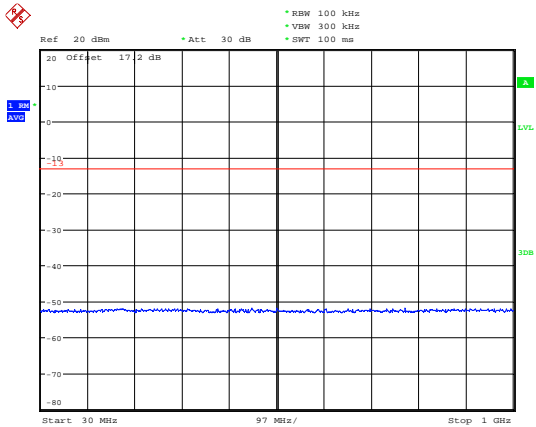

Date: 3.JUL.2019 11:02:06

### LTE Band 2 3MHz CH-Low 30MHz~1GHz

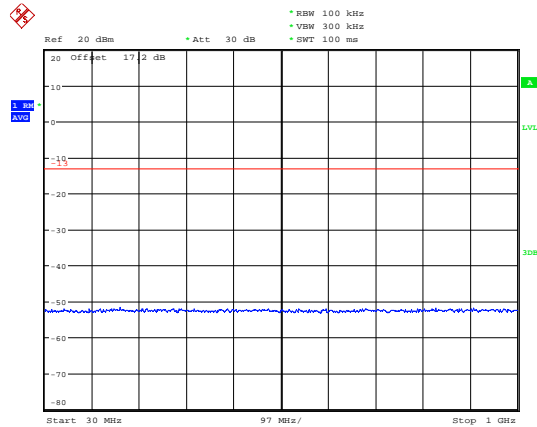

Date: 3.JUL.2019 11:02:51

### LTE Band 2 1.4MHz CH-High 1GHz~3GHz

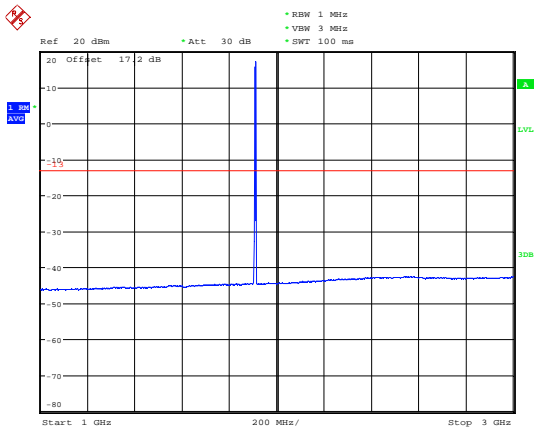

Date: 3.JUL.2019 11:13:05

### LTE Band 2 3MHz CH-Low 1GHz~3GHz

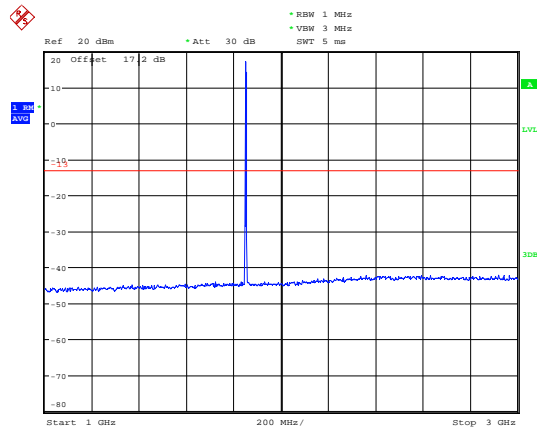

Date: 3.JUL.2019 11:14:19

### LTE Band 2 1.4MHz CH-High 3GHz~20GHz

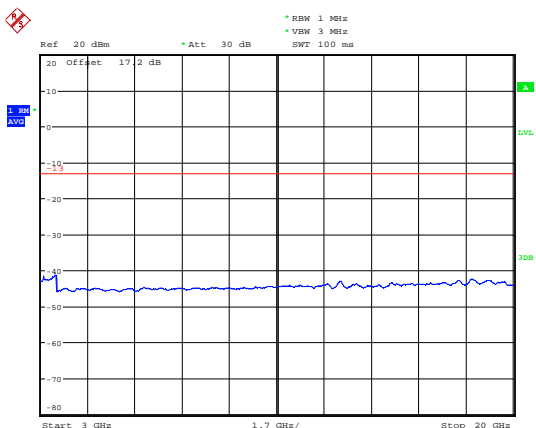

Date: 3.JUL.2019 11:43:08

### LTE Band 2 3MHz CH-Low 3GHz~20GHz

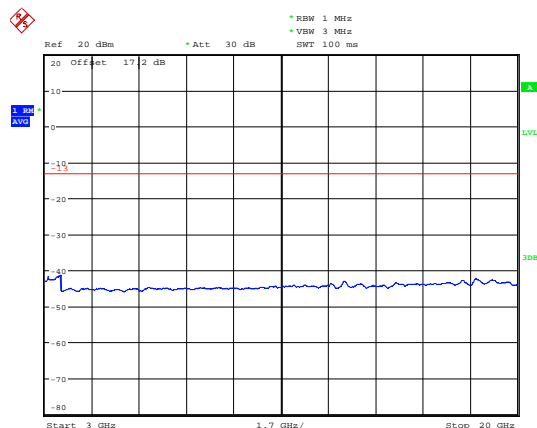

Date: 3.JUL.2019 11:59:01



### LTE Band 2 3MHz CH-Middle 30MHz~1GHz

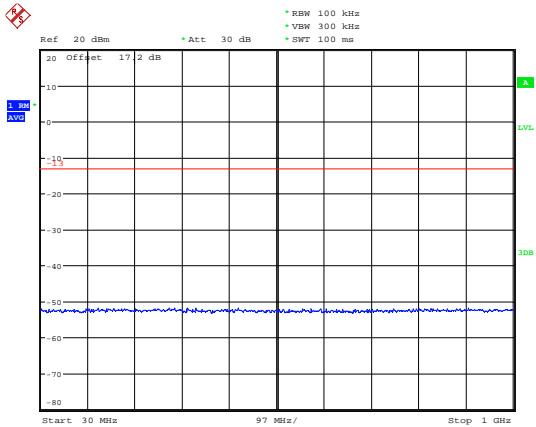

Date: 3.JUL.2019 11:03:02

### LTE Band 2 3MHz CH-High 30MHz~1GHz

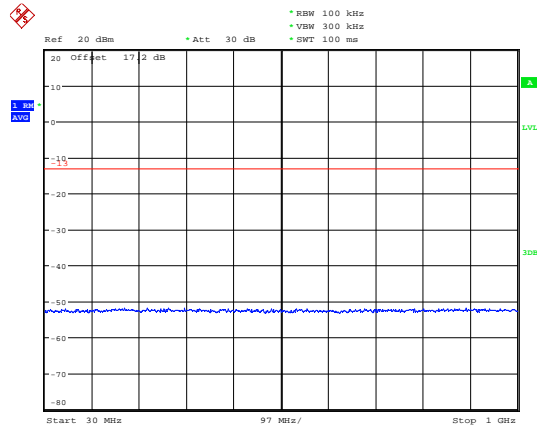

Date: 3.JUL.2019 11:03:14

### LTE Band 2 3MHz CH-Middle 1GHz~3GHz

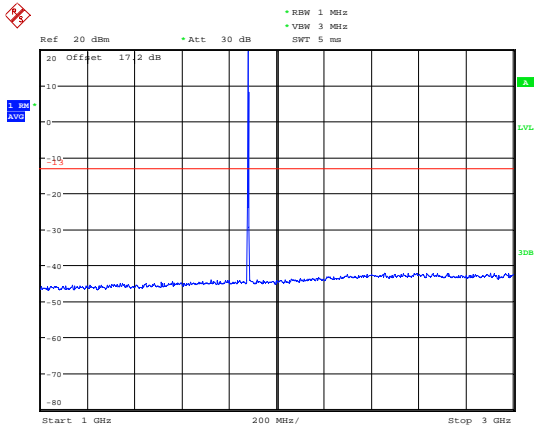

Date: 3.JUL.2019 11:14:34

### LTE Band 2 3MHz CH-High 1GHz~3GHz

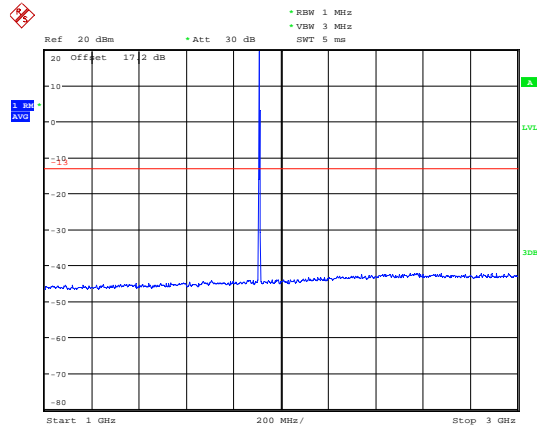

Date: 3.JUL.2019 11:14:52

### LTE Band 2 3MHz CH-Middle 3GHz~20GHz

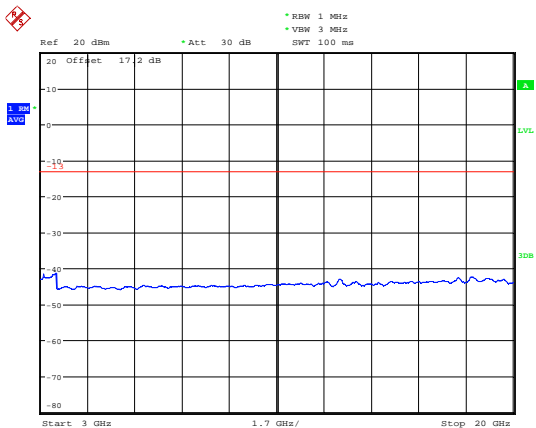

Date: 3.JUL.2019 11:59:13

### LTE Band 2 3MHz CH-High 3GHz~20GHz

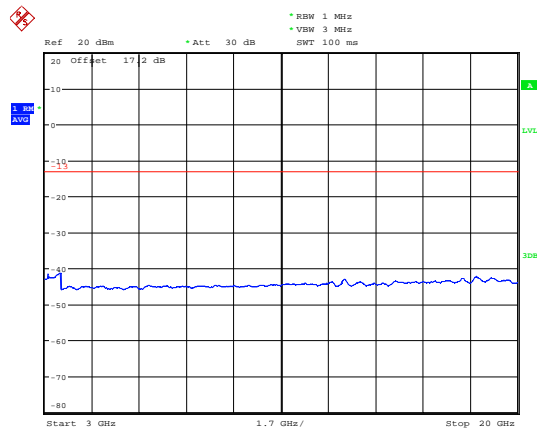

Date: 3.JUL.2019 11:59:25



### LTE Band 2 5MHz CH-Low 30MHz~1GHz

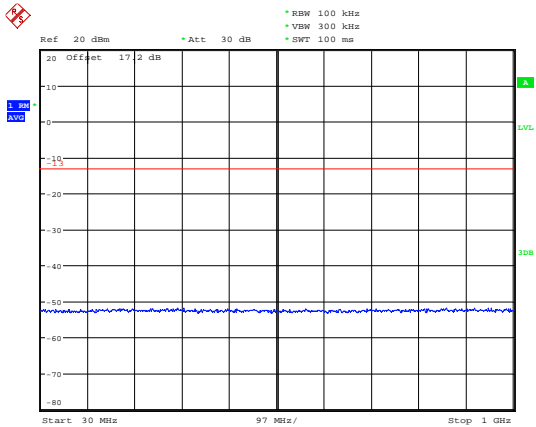

Date: 3.JUL.2019 11:03:35

### LTE Band 2 5MHz CH-Middle 30MHz~1GHz

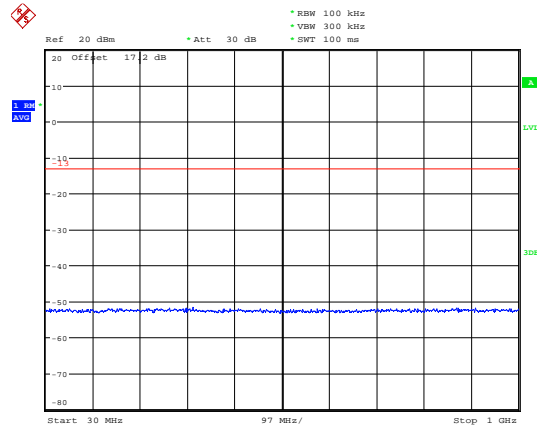

Date: 3.JUL.2019 11:03:45

### LTE Band 2 5MHz CH-Low 1GHz~3GHz

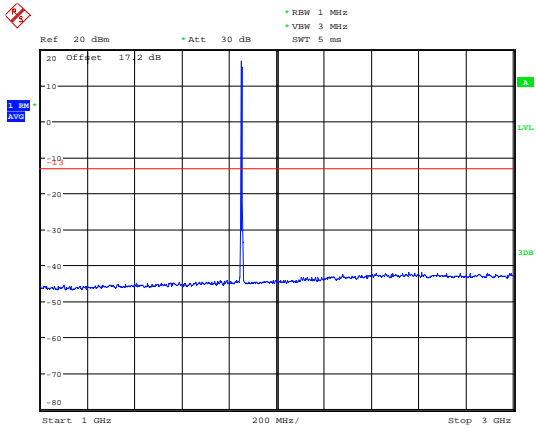

Date: 3.JUL.2019 11:15:18

### LTE Band 2 5MHz CH-Middle 1GHz~3GHz

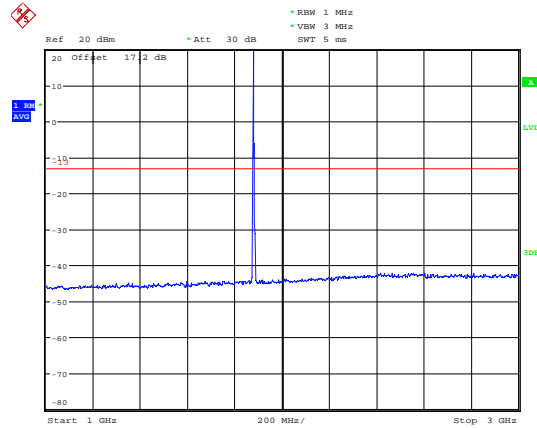

Date: 3.JUL.2019 11:15:32

### LTE Band 2 5MHz CH-Low 3GHz~20GHz

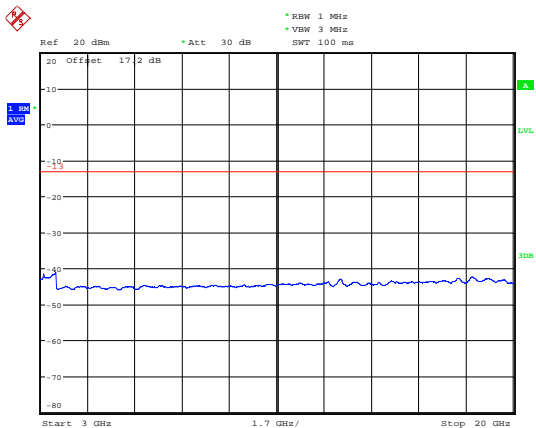

Date: 3.JUL.2019 11:59:47

### LTE Band 2 5MHz CH-Middle 3GHz~20GHz

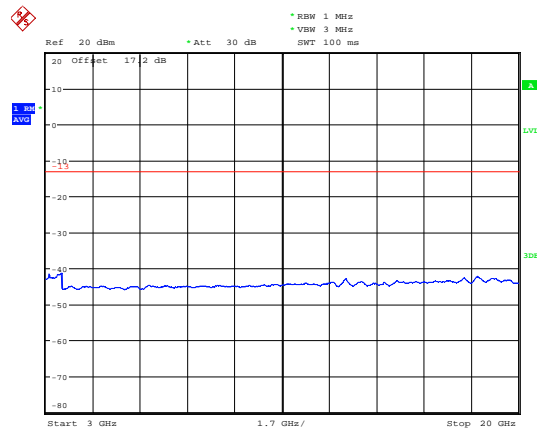

Date: 3.JUL.2019 12:00:01



### LTE Band 2 5MHz CH-High 30MHz~1GHz

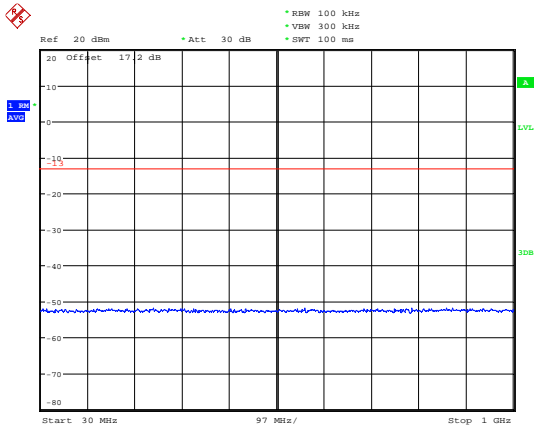

Date: 3.JUL.2019 11:04:01

### LTE Band 2 10MHz CH-Low 30MHz~1GHz

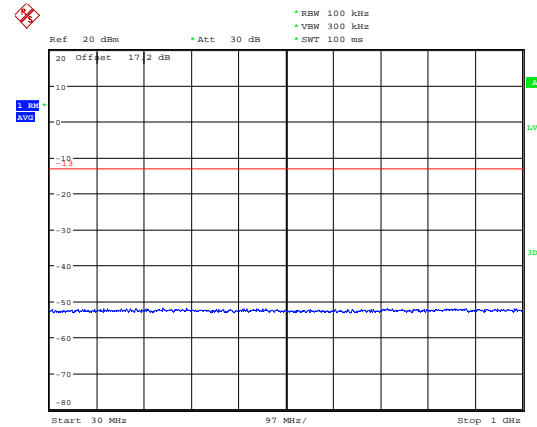

Date: 3.JUL.2019 11:04:54

### LTE Band 2 5MHz CH-High 1GHz~3GHz

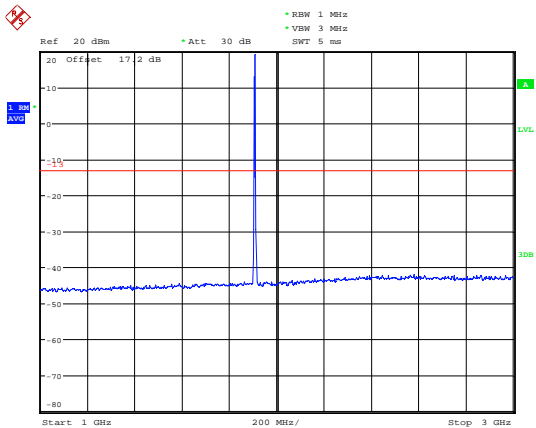

Date: 3.JUL.2019 11:15:54

### LTE Band 2 10MHz CH-Low 1GHz~3GHz

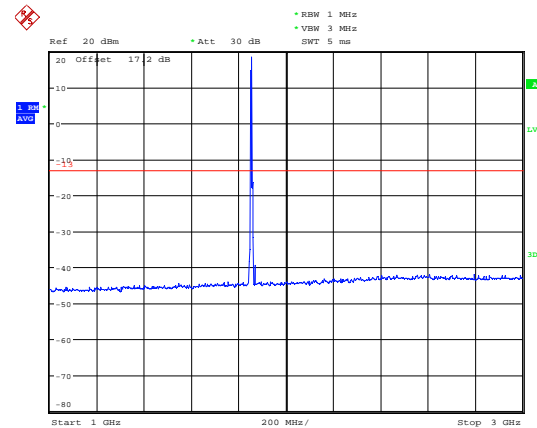

Date: 3.JUL.2019 11:16:29

### LTE Band 2 5MHz CH-High 3GHz~20GHz

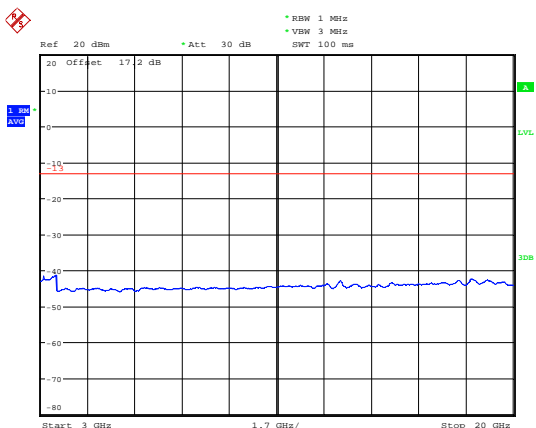

Date: 3.JUL.2019 12:00:15

### LTE Band 2 10MHz CH-Low 3GHz~20GHz

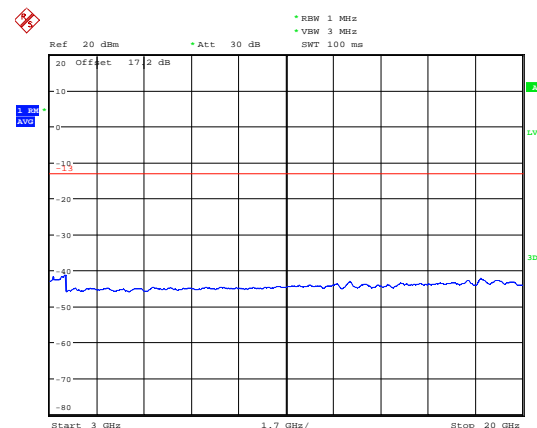

Date: 3.JUL.2019 12:00:33



### LTE Band 2 10MHz CH-Middle 30MHz~1GHz

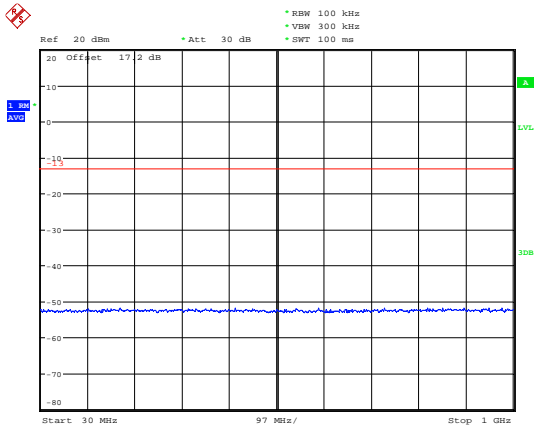

Date: 3.JUL.2019 11:05:10

### LTE Band 2 10MHz CH-High 30MHz~1GHz

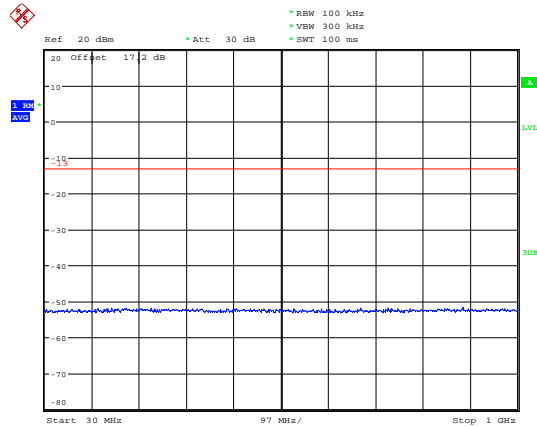

Date: 3.JUL.2019 11:05:23

### LTE Band 2 10MHz CH-Middle 1GHz~3GHz

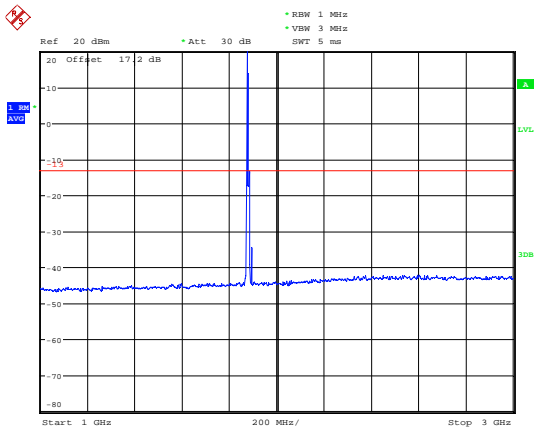

Date: 3.JUL.2019 11:16:43

### LTE Band 2 10MHz CH-High 1GHz~3GHz

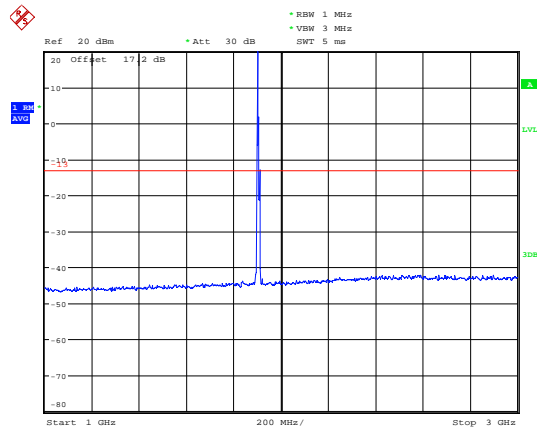

Date: 3.JUL.2019 11:17:01

### LTE Band 2 10MHz CH-Middle 3GHz~20GHz

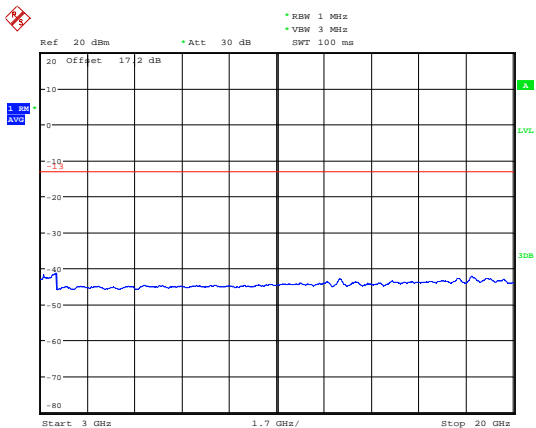

Date: 3.JUL.2019 12:00:47

### LTE Band 2 10MHz CH-High 3GHz~20GHz

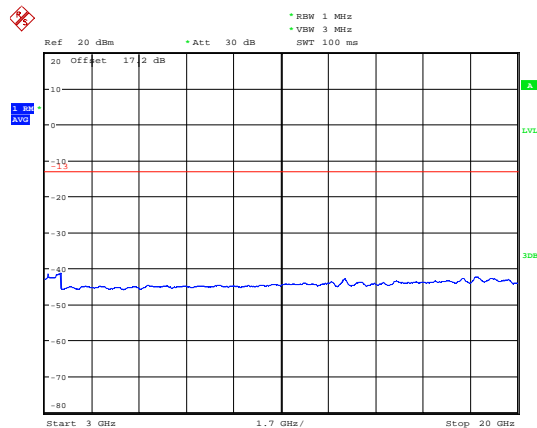

Date: 3.JUL.2019 12:01:06



### LTE Band 2 15MHz CH-Low 30MHz~1GHz

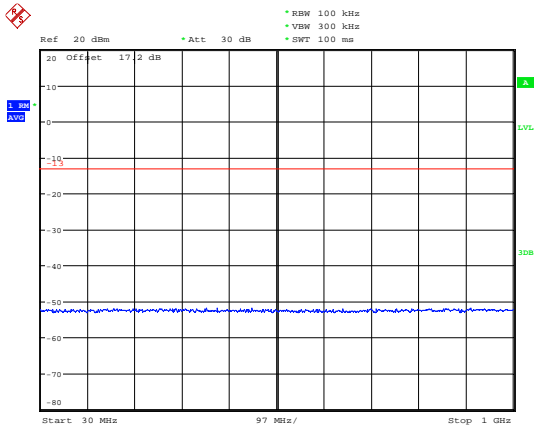

Date: 3.JUL.2019 11:05:49

### LTE Band 2 15MHz CH-Middle 30MHz~1GHz

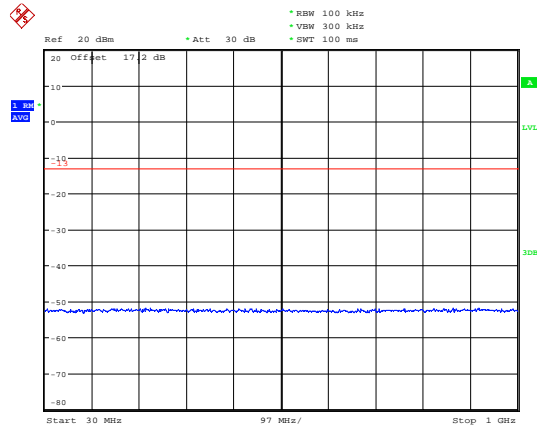

Date: 3.JUL.2019 11:06:00

### LTE Band 2 15MHz CH-Low 1GHz~3GHz

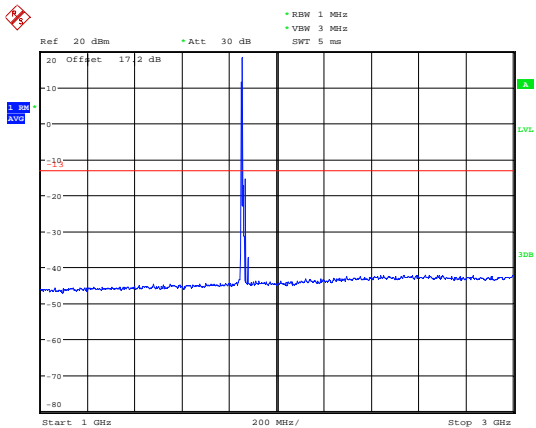

Date: 3.JUL.2019 11:17:34

### LTE Band 2 15MHz CH-Middle 1GHz~3GHz

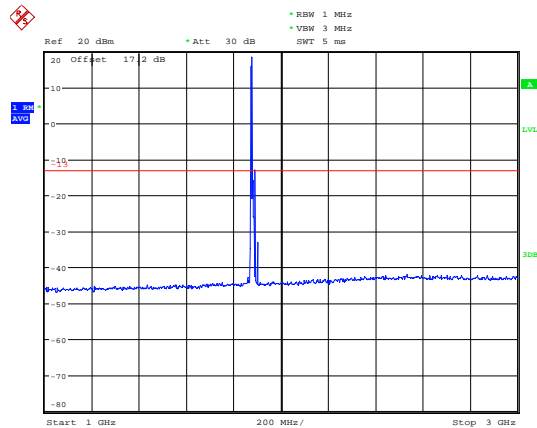

Date: 3.JUL.2019 11:17:52

### LTE Band 2 15MHz CH-Low 3GHz~20GHz

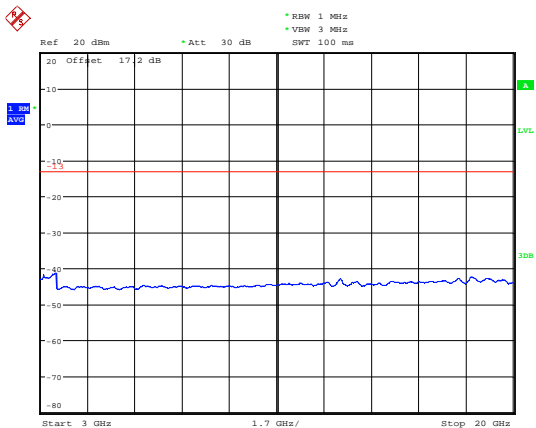

Date: 3.JUL.2019 11:41:28

### LTE Band 2 15MHz CH-Middle 3GHz~20GHz

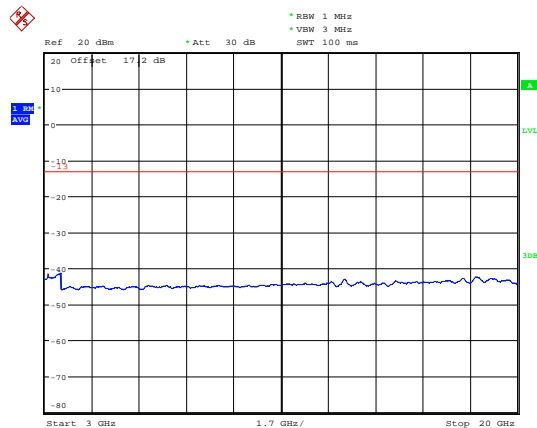

Date: 3.JUL.2019 11:41:14





### LTE Band 2 15MHz CH-High 30MHz~1GHz

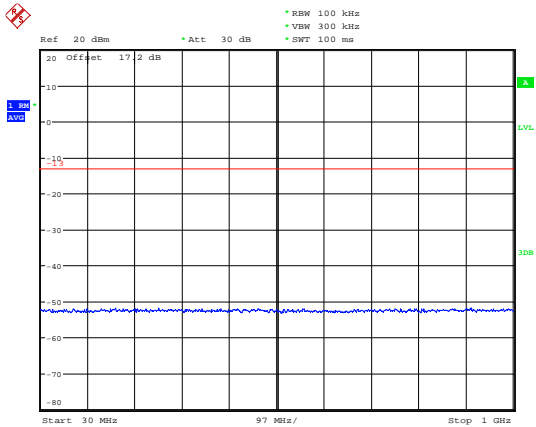

Date: 3.JUL.2019 11:06:11

### LTE Band 2 20MHz CH-Low 30MHz~1GHz

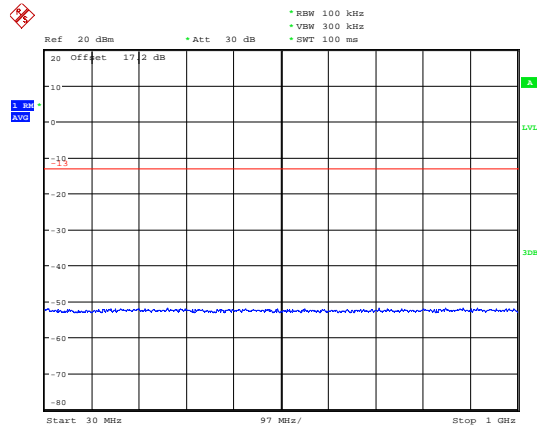

Date: 3.JUL.2019 11:06:45

### LTE Band 2 15MHz CH-High 1GHz~3GHz

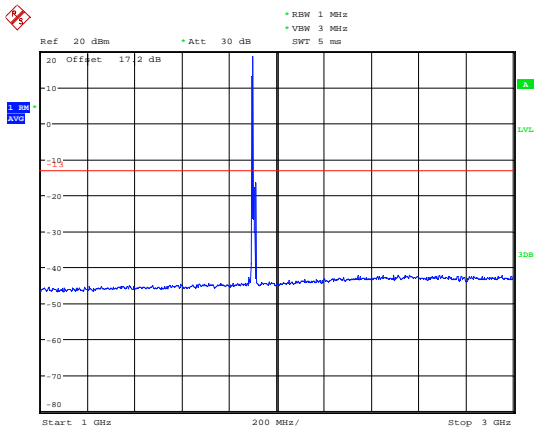

Date: 3.JUL.2019 11:18:10

### LTE Band 2 20MHz CH-Low 1GHz~3GHz

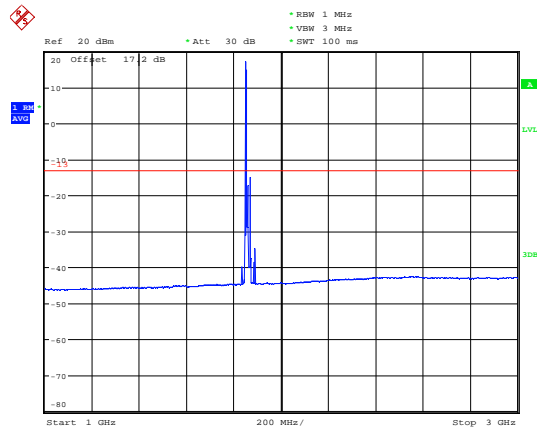

Date: 3.JUL.2019 11:12:11

### LTE Band 2 15MHz CH-High 3GHz~20GHz

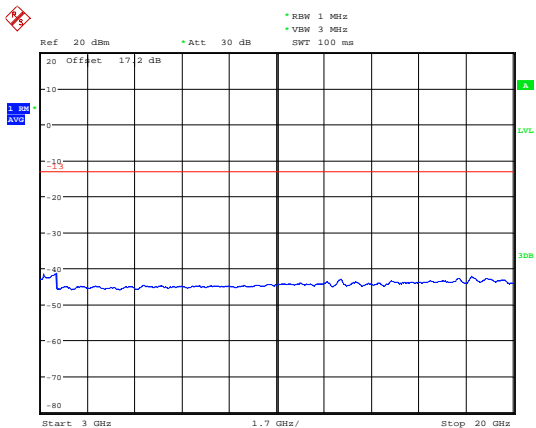

Date: 3.JUL.2019 11:40:59

### LTE Band 2 20MHz CH-Low 3GHz~20GHz

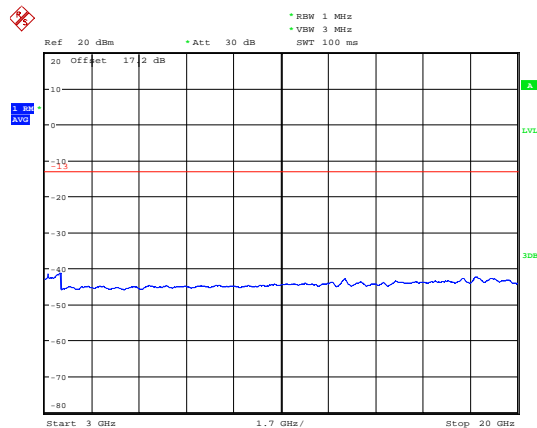

Date: 3.JUL.2019 11:41:57



### LTE Band 2 20MHz CH-Middle 30MHz~1GHz

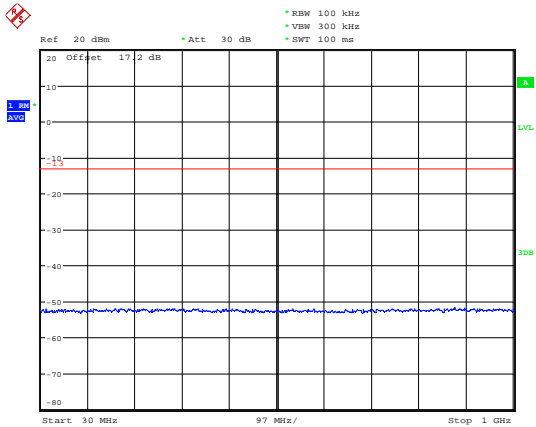

Date: 3.JUL.2019 11:06:56

### LTE Band 2 20MHz CH-High 30MHz~1GHz

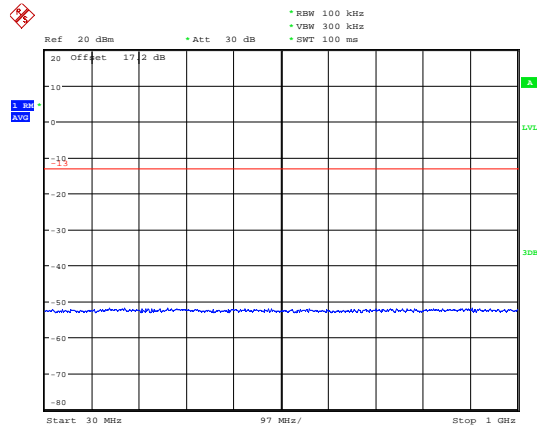

Date: 3.JUL.2019 11:07:08

### LTE Band 2 20MHz CH-Middle 1GHz~3GHz

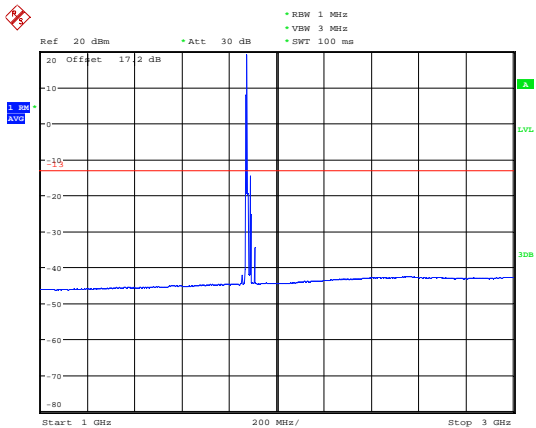

Date: 3.JUL.2019 11:11:53

### LTE Band 2 20MHz CH-High 1GHz~3GHz

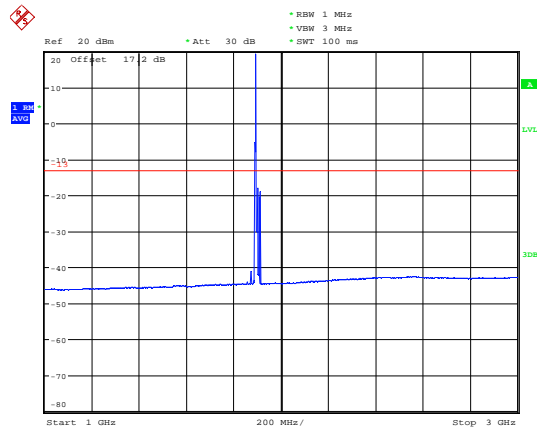

Date: 3.JUL.2019 11:11:10

### LTE Band 2 20MHz CH-Middle 3GHz~20GHz

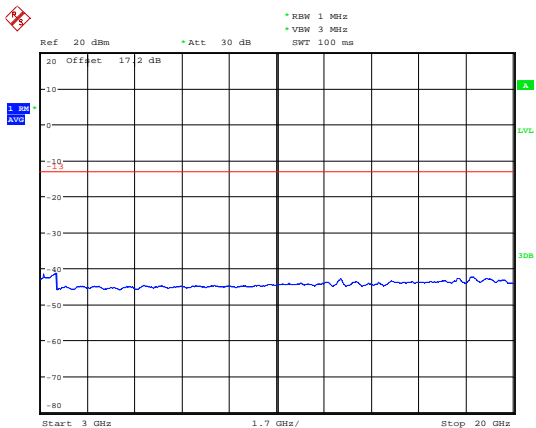

Date: 3.JUL.2019 11:42:08

### LTE Band 2 20MHz CH-High 3GHz~20GHz

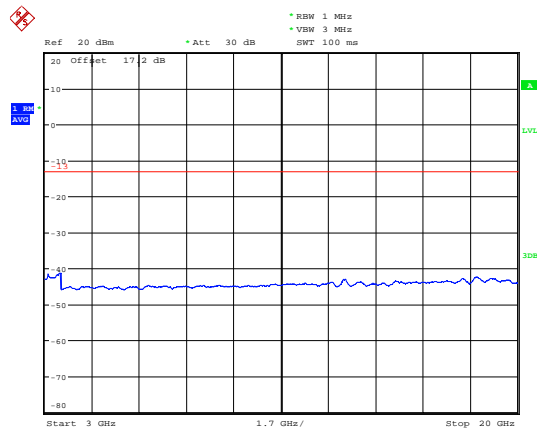

Date: 3.JUL.2019 11:42:21

## 5.8. Radiates Spurious Emission

### Ambient condition

Temperature	Relative humidity	Pressure
23°C ~25°C	45%~50%	101.5kPa

### Method of Measurement

1. The testing follows FCC KDB 971168 v03r01 Section 5.8 and ANSI C63.26 (2015).
2. Below 1GHz: The EUT is placed on a turntable 0.8 meters above the ground in the chamber, 3 meter away from the antenna. The maximal emission value is acquired by adjusting the antenna height, polarisation and turntable azimuth. Normally, the height range of antenna is 1 m to 4 m, the azimuth range of turntable is 0° to 360°, and the receive antenna has two polarizations Vertical (V) and Horizontal (H). Above 1GHz: (Note: the FCC's permission to use 1.5m as an alternative per TCBC Conf call of Dec. 2, 2014.) The EUT is placed on a turntable 1.5 meters above the ground in the chamber, 3 meter away from the antenna. The maximal emission value is acquired by adjusting the antenna height, polarisation and turntable azimuth. Normally, the height range of antenna is 1 m to 4 m, the azimuth range of turntable is 0° to 360°, and the receive antenna has two polarizations Vertical (V) and Horizontal (H).
3. A loop antenna, A log-periodic antenna or horn antenna shall be substituted in place of the EUT. The log-periodic antenna will be driven by a signal generator and the level will be adjusted till the same power value on the spectrum analyzer or receiver. The level of the spurious emissions can be calculated through the level of the signal generator, cable loss, the gain of the substitution antenna and the reading of the spectrum analyzer or receiver.
4. The EUT is then put into continuously transmitting mode at its maximum power level during the test. Set Test Receiver or Spectrum RBW=200Hz,VBW=600Hz for 9kHz150kHz , RBW=10kHz, VBW=30kHz 150kHz-30MHz , RBW=100kHz,VBW=300kHz for 30MHz to 1GHz and RBW=1MHz, VBW=3MHz for above 1GHz, And the maximum value of the receiver should be recorded as (Pr).
5. The EUT shall be replaced by a substitution antenna. In the chamber, an substitution antenna for the frequency band of interest is placed at the reference point of the chamber. An RF Signal source for the frequency band of interest is connected to the substitution antenna with a cable that has been constructed to not interfere with the radiation pattern of the antenna. A power (PMea) is applied to the input of the substitution antenna, and adjust the level of the signal generator output until the value of the receiver reach the previously recorded (Pr). The power of signal source (PMea) is recorded. The test should be performed by rotating the test item and adjusting the receiving antenna polarization.
6. A amplifier should be connected to the Signal Source output port. And the cable should be connect between the Amplifier and the Substitution Antenna. The cable loss (Pcl) ,the Substitution Antenna Gain (Ga) and the Amplifier Gain (PAg) should be recorded after test.
7. The measurement results are obtained as described below:  
$$\text{Power(EIRP)} = \text{PMea} - \text{PAg} - \text{Pcl} + \text{Ga}$$
  
The measurement results are amend as described below:  
$$\text{Power(EIRP)} = \text{PMea} - \text{Pcl} + \text{Ga}$$
8. This value is EIRP since the measurement is calibrated using an antenna of known gain (2.15 dBi)

and known input power. ERP can be calculated from EIRP by subtracting the gain of the dipole,  $ERP = EIRP - 2.15\text{dBi}$ .

The modulation mode and RB allocation refer to section 5.1, using the maximum output power configuration.

**Test setup**

**9KHz ~ 30MHz**

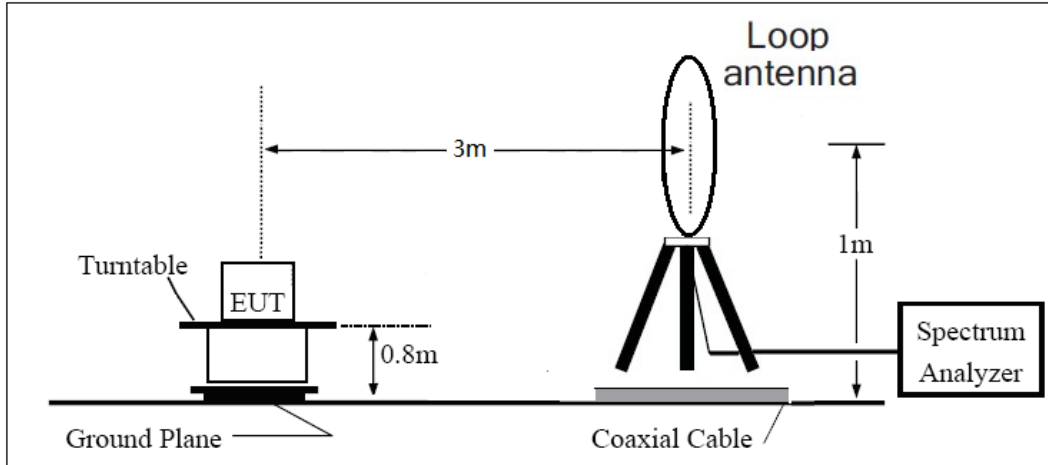

**30MHz ~ 1GHz**

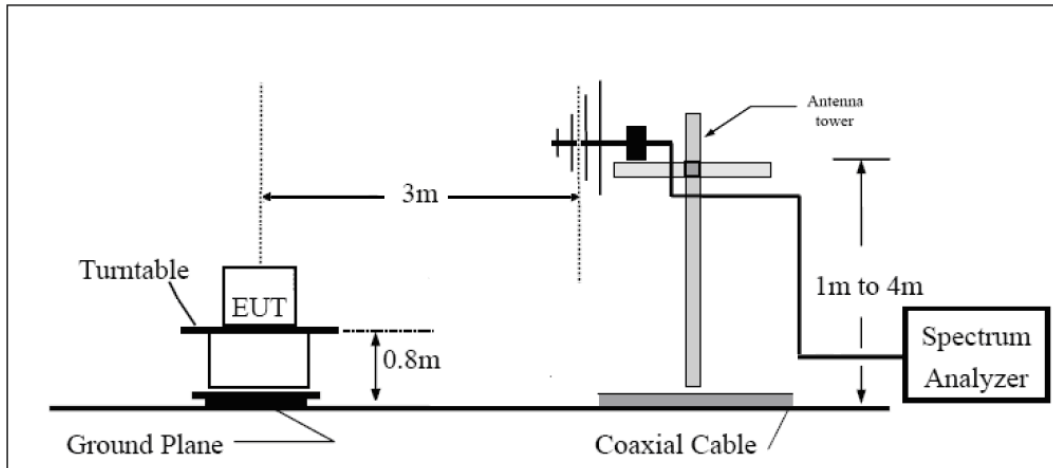

**Above 1GHz**

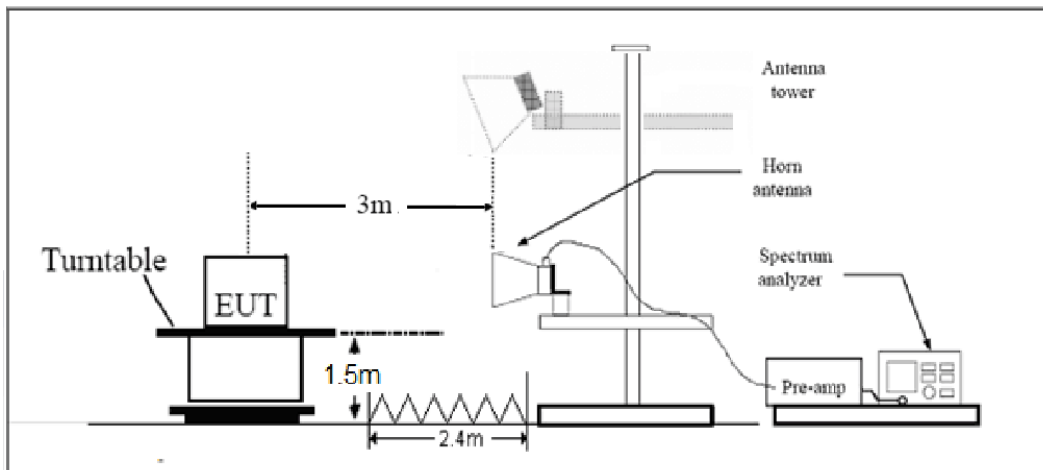



Note: Area side: 2.4mX3.6m

### Limits

Rule Part 24.238(a) specifies that “on any frequency outside a licensee's frequency block, the power of any emission shall be attenuated below the transmitter power (P) by at least  $43 + 10 \log_{10}(P)$  dB.”

Limit	-13 dBm
-------	---------

### Measurement Uncertainty

The assessed measurement uncertainty to ensure 95% confidence level for the normal distribution is with the coverage factor  $k = 1.96$ ,  $U = 3.55$  dB.

**Test Result**

Sweep the whole frequency band through the range from 9kHz to the 10th harmonic of the carrier, the emissions below the noise floor will not be recorded in the report.

WCDMA Band II CH-Low

Harmonic	Frequency (MHz)	SG (dBm)	Cable Loss (dB)	Gain (dBi)	Antenna Polarization	EIRP Level (dBm)	Limit (dBm)	Margin (dB)	Azimuth (deg)
2	3704.8	-54.66	5.10	11.05	Horizontal	-48.71	-13.00	35.71	315
3	5557.2	-59.94	5.42	12.65	Horizontal	-52.71	-13.00	39.71	135
4	7409.6	-56.94	6.70	13.85	Horizontal	-49.79	-13.00	36.79	270
5	9262.0	-55.72	7.01	14.75	Horizontal	-47.98	-13.00	34.98	90
6	11114.4	-53.62	7.48	15.95	Horizontal	-45.15	-13.00	32.15	45
7	12966.8	-54.19	7.51	16.55	Horizontal	-45.15	-13.00	32.15	315
8	14819.2	-50.75	8.24	15.35	Horizontal	-43.64	-13.00	30.64	315
9	16671.6	-49.74	8.41	14.95	Horizontal	-43.20	-13.00	30.20	135
10	18524.0	-	-	-	-	-	-	-	-

Note: 1.The other Spurious RF Radiated emissions level is no more than noise floor.  
 2. The worst emission was found in the antenna is Horizontal position.

WCDMA Band II CH-Middle

Harmonic	Frequency (MHz)	SG (dBm)	Cable Loss (dB)	Gain (dBi)	Antenna Polarization	EIRP Level (dBm)	Limit (dBm)	Margin (dB)	Azimuth (deg)
2	3760.0	-55.14	5.10	11.05	Horizontal	-49.19	-13.00	36.19	0
3	5640.0	-56.22	5.42	12.65	Horizontal	-48.99	-13.00	35.99	45
4	7520.0	-57.54	6.70	13.85	Horizontal	-50.39	-13.00	37.39	135
5	9400.0	-54.08	7.01	14.75	Horizontal	-46.34	-13.00	33.34	270
6	11280.0	-54.35	7.48	15.95	Horizontal	-45.88	-13.00	32.88	45
7	13160.0	-53.65	7.51	16.55	Horizontal	-44.61	-13.00	31.61	135
8	15040.0	-51.43	8.24	15.35	Horizontal	-44.32	-13.00	31.32	270
9	16920.0	-48.46	8.41	14.95	Horizontal	-41.92	-13.00	28.92	315
10	18800.0	-	-	-	-	-	-	-	-

Note: 1.The other Spurious RF Radiated emissions level is no more than noise floor.  
 2. The worst emission was found in the antenna is Horizontal position.

WCDMA Band II CH-High

Harmonic	Frequency (MHz)	SG (dBm)	Cable Loss (dB)	Gain (dBi)	Antenna Polarization	EIRP Level (dBm)	Limit (dBm)	Margin (dB)	Azimuth (deg)
2	3813.8	-54.02	5.10	11.05	Horizontal	-48.07	-13.00	35.07	270
3	5722.8	-50.97	5.42	12.65	Horizontal	-43.74	-13.00	30.74	0
4	7630.4	-57.35	6.70	13.85	Horizontal	-50.20	-13.00	37.20	90
5	9538.0	-56.88	7.01	14.75	Horizontal	-49.14	-13.00	36.14	45
6	11445.6	-54.20	7.48	15.95	Horizontal	-45.73	-13.00	32.73	225
7	13353.2	-54.01	7.51	16.55	Horizontal	-44.97	-13.00	31.97	315
8	15260.8	-53.23	8.24	15.35	Horizontal	-46.12	-13.00	33.12	135
9	17168.4	-49.30	8.41	14.95	Horizontal	-42.76	-13.00	29.76	270
10	19076.0	-	-	-	-	-	-	-	-

Note: 1. The other Spurious RF Radiated emissions level is no more than noise floor.  
 2. The worst emission was found in the antenna is Horizontal position.

LTE Band 2 20MHz CH-Low

Harmonic	Frequency (MHz)	SG (dBm)	Cable Loss (dB)	Gain (dBi)	Antenna Polarization	EIRP Level (dBm)	Limit (dBm)	Margin (dB)	Azimuth (deg)
2	3702.0	-50.23	5.10	11.05	Horizontal	-44.28	-13.00	31.28	180
3	5553.4	-49.12	5.42	12.65	Horizontal	-41.89	-13.00	28.89	90
4	7440.0	-55.39	6.70	13.85	Horizontal	-48.24	-13.00	35.24	315
5	9300.0	-55.38	7.01	14.75	Horizontal	-47.64	-13.00	34.64	135
6	11160.0	-53.88	7.48	15.95	Horizontal	-45.41	-13.00	32.41	270
7	13020.0	-53.89	7.51	16.55	Horizontal	-44.85	-13.00	31.85	0
8	14880.0	-51.07	8.24	15.35	Horizontal	-43.96	-13.00	30.96	45
9	16740.0	-49.70	8.41	14.95	Horizontal	-43.16	-13.00	30.16	225
10	18600.0	-	-	-	-	-	-	-	-

Note: 1. The other Spurious RF Radiated emissions level is no more than noise floor.  
 2. The worst emission was found in the antenna is Horizontal position.

LTE Band 2 20MHz CH-Middle

Harmonic	Frequency (MHz)	SG (dBm)	Cable Loss (dB)	Gain (dBi)	Antenna Polarization	EIRP Level (dBm)	Limit (dBm)	Margin (dB)	Azimuth (deg)
2	3742.1	-49.18	5.10	11.05	Horizontal	-43.23	-13.00	30.23	270
3	5613.4	-41.90	5.42	12.65	Horizontal	-34.67	-13.00	21.67	0
4	7484.6	-57.86	6.70	13.85	Horizontal	-50.71	-13.00	37.71	45
5	9400.0	-54.36	7.01	14.75	Horizontal	-46.62	-13.00	33.62	225
6	11280.0	-54.72	7.48	15.95	Horizontal	-46.25	-13.00	33.25	315
7	13160.0	-55.13	7.51	16.55	Horizontal	-46.09	-13.00	33.09	135
8	15040.0	-52.45	8.24	15.35	Horizontal	-45.34	-13.00	32.34	270
9	16920.0	-49.53	8.41	14.95	Horizontal	-42.99	-13.00	29.99	90
10	18800.0	-	-	-	-	-	-	-	-

Note: 1.The other Spurious RF Radiated emissions level is no more than noise floor.  
2. The worst emission was found in the antenna is Horizontal position.

LTE Band 2 20MHz CH-High

Harmonic	Frequency (MHz)	SG (dBm)	Cable Loss (dB)	Gain (dBi)	Antenna Polarization	EIRP Level (dBm)	Limit (dBm)	Margin (dB)	Azimuth (deg)
2	3781.9	-49.66	5.10	11.05	Horizontal	-43.71	-13.00	30.71	315
3	5673.8	-46.46	5.42	12.65	Horizontal	-39.23	-13.00	26.23	135
4	7564.1	-58.44	6.70	13.85	Horizontal	-51.29	-13.00	38.29	270
5	9500.0	-57.31	7.01	14.75	Horizontal	-49.57	-13.00	36.57	90
6	11400.0	-53.49	7.48	15.95	Horizontal	-45.02	-13.00	32.02	45
7	13300.0	-54.36	7.51	16.55	Horizontal	-45.32	-13.00	32.32	315
8	15200.0	-52.39	8.24	15.35	Horizontal	-45.28	-13.00	32.28	270
9	17100.0	-49.52	8.41	14.95	Horizontal	-42.98	-13.00	29.98	45
10	19000.0	-	-	-	-	-	-	-	-

Note: 1.The other Spurious RF Radiated emissions level is no more than noise floor.  
2. The worst emission was found in the antenna is Horizontal position.



## 6. Main Test Instruments

Name	Manufacturer	Type	Serial Number	Calibration Date	Expiration Date
Base Station Simulator	R&S	CMU200	118133	2019-05-19	2020-05-18
Base Station Simulator	R&S	CMW500	113824	2019-05-19	2020-05-18
Power Splitter	Hua Xiang	SHX-GF2-2-13	10120101	/	/
Spectrum Analyzer	Key sight	N9010A	MY50210259	2019-05-19	2020-05-18
Universal Radio Communication Tester	Key sight	E5515C	MY48367192	2019-05-19	2020-05-18
Signal Analyzer	R&S	FSV30	100815	2018-12-16	2019-12-15
Loop Antenna	SCHWARZBECK	FMZB1519	1519-047	2017-09-26	2019-09-25
Trilog Antenna	SCHWARZBECK	VUBL 9163	9163-201	2017-11-18	2019-11-17
Horn Antenna	R&S	HF907	100126	2018-07-07	2020-07-06
Horn Antenna	ETS-Lindgren	3160-09	00102643	2018-06-20	2020-06-19
Signal generator	R&S	SMB 100A	102594	2019-05-19	2020-05-18
Climatic Chamber	ESPEC	SU-242	93000506	2017-12-17	2020-12-16
Preamplifier	R&S	SCU18	102327	2019-05-19	2020-05-18
MOB COMMS DC SUPPLY	Keysight	66319D	MY43004105	2019-05-19	2020-05-18
RF Cable	Agilent	SMA 15cm	0001	2019-06-14	2019-09-13
Software	R&S	EMC32	9.26.0	/	/

\*\*\*\*\*END OF REPORT \*\*\*\*\*

## ANNEX A: EUT Appearance and Test Setup

### A.1 EUT Appearance

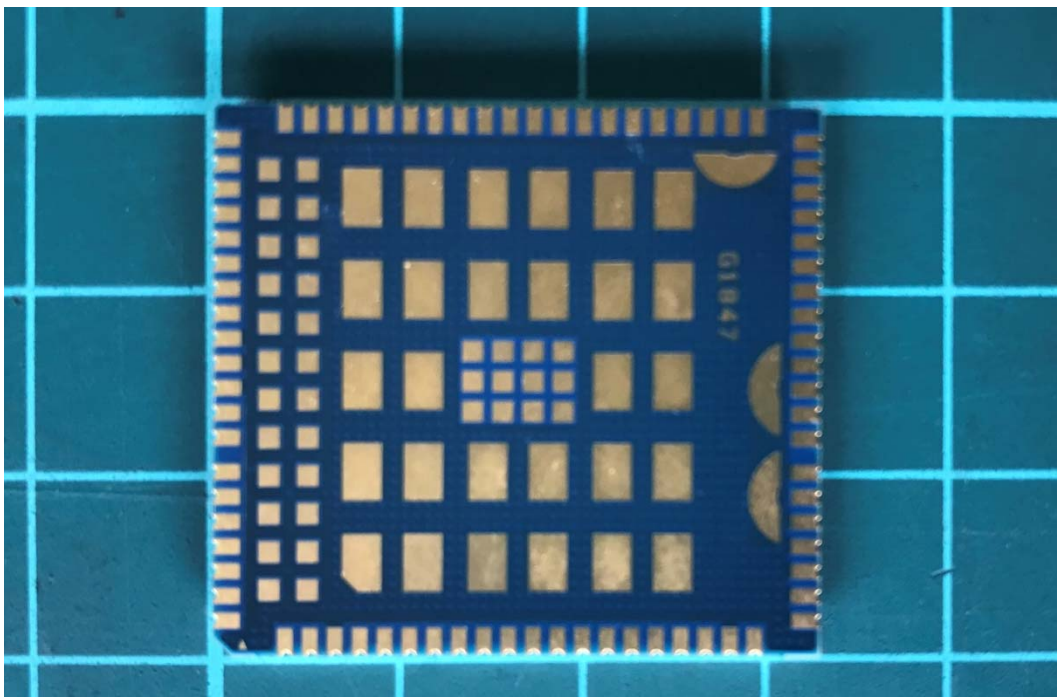

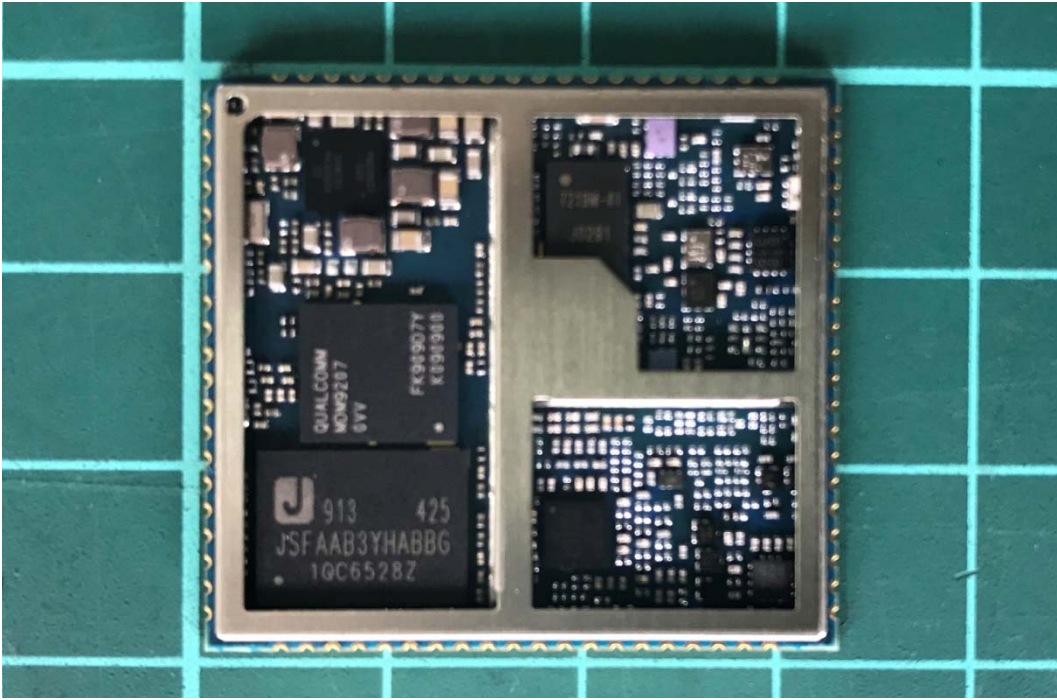

a: EUT

Picture 1 EUT and Accessory

## A.2 Test Setup



30MHz ~ 1GHz



Above 1GHz

Picture 2 Radiated Spurious Emissions Test setup