



## RF TEST REPORT

**Applicant**      Quectel Wireless Solutions Co., Ltd  
**FCC ID**            XMR201907EC25MX  
**Product**          LTE Module  
**Brand**             Quectel  
**Model**             EC25-MX, EC25-MX MINIPCIE  
**Report No.**      R1906A0272-R1  
**Issue Date**      July 31, 2019

TA Technology (Shanghai) Co., Ltd. tested the above equipment in accordance with the requirements in **FCC CFR47 Part 2 (2018)/ FCC CFR 47 Part 22H (2018)**. The test results show that the equipment tested is capable of demonstrating compliance with the requirements as documented in this report.

*Performed by: Peng Tao*

*Approved by: Kai Xu*

---

### TA Technology (Shanghai) Co., Ltd.

*No.145, Jintang Rd, Tangzhen Industry Park, Pudong Shanghai, China*

*TEL: +86-021-50791141/2/3*

*FAX: +86-021-50791141/2/3-8000*



## TABLE OF CONTENT

1. Test Laboratory .....	4
1.1. Notes of the Test Report .....	4
1.2. Test facility .....	4
1.3. Testing Location .....	5
2. General Description of Equipment under Test.....	6
3. Applied Standards.....	7
4. Test Configuration.....	8
5. Test Case Results.....	10
5.1. RF Power Output.....	10
5.2. Effective Radiated Power .....	14
5.3. Occupied Bandwidth .....	17
5.4. Band Edge Compliance.....	24
5.5. Peak-to-Average Power Ratio (PAPR) .....	31
5.6. Frequency Stability .....	33
5.7. Spurious Emissions at Antenna Terminals .....	38
5.8. Radiates Spurious Emission .....	44
6. Main Test Instruments .....	50
ANNEX A: EUT Appearance and Test Setup.....	51
A.1 EUT Appearance .....	51
A.2 Test Setup.....	53



### Summary of measurement results

No.	Test Case	Clause in FCC rules	Verdict
1	RF power output	2.1046	PASS
2	Effective Radiated Power	22.913(a)(5)	PASS
3	Occupied Bandwidth	2.1049	PASS
4	Band Edge Compliance	2.1051 / 22.917(a)	PASS
5	Peak-to-Average Power Ratio	22.913(d)/ KDB 971168 D01(5.7)	PASS
6	Frequency Stability	2.1055 / 22.355	PASS
7	Spurious Emissions at Antenna Terminals	2.1051 / 22.917(a)	PASS
8	Radiates Spurious Emission	2.1053 / 22.917 (a)	PASS
Note: PASS: The EUT complies with the essential requirements in the standard. FAIL: The EUT does not comply with the essential requirements in the standard.			
Date of Testing: June 18, 2019~ July 12, 2019			



## 1. Test Laboratory

### 1.1. Notes of the Test Report

This report shall not be reproduced in full or partial, without the written approval of **TA technology (shanghai) co., Ltd.** The results documented in this report apply only to the tested sample, under the conditions and modes of operation as described herein .Measurement Uncertainties were not taken into account and are published for informational purposes only. This report is written to support regulatory compliance of the applicable standards stated above.

### 1.2. Test facility

#### **FCC (Designation number: CN1179, Test Firm Registration Number: 446626)**

TA Technology (Shanghai) Co., Ltd. has been listed on the US Federal Communications Commission list of test facilities recognized to perform electromagnetic emissions measurements.

#### **IC (recognition number is 8510A)**

TA Technology (Shanghai) Co., Ltd. has been listed by industry Canada to perform electromagnetic emission measurement.

#### **VCCI (recognition number is C-4595, T-2154, R-4113, G-10766)**

TA Technology (Shanghai) Co., Ltd. has been listed by industry Japan to perform electromagnetic emission measurement.

#### **A2LA (Certificate Number: 3857.01)**

TA Technology (Shanghai) Co., Ltd. has been listed by American Association for Laboratory Accreditation to perform electromagnetic emission measurement.



### 1.3. Testing Location

Company: TA Technology (Shanghai) Co., Ltd.  
Address: No.145, Jintang Rd, Tangzhen Industry Park, Pudong  
City: Shanghai  
Post code: 201201  
Country: P. R. China  
Contact: Xu Kai  
Telephone: +86-021-50791141/2/3  
Fax: +86-021-50791141/2/3-8000  
Website: <http://www.ta-shanghai.com>  
E-mail: [xukai@ta-shanghai.com](mailto:xukai@ta-shanghai.com)

## 2. General Description of Equipment under Test

### Client Information

Applicant	Quectel Wireless Solutions Co., Ltd
Applicant address	Building 5, Shanghai Business Park Phase III (Area B), No.1016 Tianlin Road, Minhang District, Shanghai, China 200233
Manufacturer	Quectel Wireless Solutions Co., Ltd
Manufacturer address	Building 5, Shanghai Business Park Phase III (Area B), No.1016 Tianlin Road, Minhang District, Shanghai, China 200233

### General Information

EUT Description			
Model	EC25-MX, EC25-MX MINIPCIE		
IMEI	864744040000620		
Hardware Version	R1.0		
Software Version	EC25MXGAR10A02M1G		
Power Supply	External power supply		
Antenna Type	The EUT don't have standard Antenna, The Antenna used for testing in this report is the after-market accessory (Dipole Antenna)		
Antenna Gain	4 dBi		
Test Mode(s)	WCDMA Band V;LTE Band 5;		
Test Modulation	(WCDMA) BPSK, QPSK, 16QAM; (LTE)QPSK 16QAM;		
HSDPA UE Category	14		
HSUPA UE Category	6		
DC-HSDPA UE Category	24		
HSPA+ UE Category	24		
LTE Category	4		
Maximum E.R.P.	WCDMA Band V:	22.94 dBm	
	LTE Band 5:	22.37dBm	
Rated Power Supply Voltage	3.8V		
Extreme Voltage	Minimum: 3.3V    Maximum: 4.3V		
Extreme Temperature	Lowest:-40°C    Highest: +85°C		
Operating Frequency Range(s)	Band	Tx (MHz)	Rx (MHz)
	WCDMA Band V	824 ~ 849	869 ~ 894
	LTE Band 5	824 ~ 849	869 ~ 894
Note: The information of the EUT is declared by the manufacturer.			



### 3. Applied Standards

According to the specifications of the manufacturer, it must comply with the requirements of the following standards:

**FCC CFR47 Part 2 (2018)**

**FCC CFR 47 Part 22H (2018)**

**ANSI C63.26 (2015)**

**KDB 971168 D01 Power Meas License Digital Systems v03r01**

## 4. Test Configuration

Radiated measurements are performed by rotating the EUT in three different orthogonal test planes. EUT stand-up position (Z axis), lie-down position (X, Y axis). Receiver antenna polarization (horizontal and vertical), the worst emission was found in position (Z axis, horizontal polarization) and the worst case was recorded.

All mode and data rates and positions were investigated. Subsequently, only the worst case emissions are reported.

The following testing in WCDMA/LTE is set based on the maximum RF Output Power.

Test modes are chosen to be reported as the worst case configuration below:

Test items	Modes/Modulation
	WCDMA Band V
RF power output	RMC HSDPA/HSUPA DC-HSDPA/HSPA+
Effective Radiated Power	RMC
Occupied Bandwidth	RMC
Band Edge Compliance	RMC
Peak-to-Average Power Ratio	RMC
Frequency Stability	RMC
Spurious Emissions at Antenna Terminals	RMC
Radiates Spurious Emission	RMC





Test modes are chosen as the worst case configuration below for LTE Band 5.

Test items	Bandwidth (MHz)				Modulation		RB			Test Channel		
	1.4	3	5	10	QPSK	16QAM	1	50%	100%	L	M	H
RF power output	O	O	O	O	O	O	O	O	O	O	O	O
Effective Isotropic Radiated power	O	O	O	O	O	O	-	-	O	O	O	O
Occupied Bandwidth	O	O	O	O	O	O	-	-	O	O	O	O
Band Edge Compliance	O	O	O	O	O	O	O	-	O	O	-	O
Peak-to-Average Power Ratio	O	O	O	O	O	O	-	-	O	O	O	O
Frequency Stability	O	O	O	O	O	O	-	-	O	-	O	-
Spurious Emissions at Antenna Terminals	O	O	O	O	O	-	O	-	-	O	O	O
Radiates Spurious Emission	-	-	-	O	O	-	O	-	-	O	O	O
Note	1. The mark "O" means that this configuration is chosen for testing. 2. The mark "-" means that this configuration is not testing.											

## 5. Test Case Results

### 5.1. RF Power Output

#### Ambient condition

Temperature	Relative humidity	Pressure
23°C ~25°C	45%~50%	101.5kPa

#### Methods of Measurement

During the process of the testing, The EUT is controlled by the Base Station Simulator to ensure max power transmission and proper modulation.

#### Test Setup

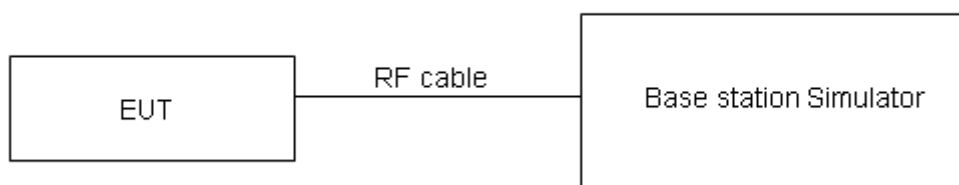

The loss between RF output port of the EUT and the input port of the tester has been taken into consideration.

#### Limits

No specific RF power output requirements in part 2.1046.

#### Measurement Uncertainty

The assessed measurement uncertainty to ensure 95% confidence level for the normal distribution is with the coverage factor  $k = 2$ ,  $U = 0.4$  dB.

**Test Results**

WCDMA Band V		Conducted Power(dBm)		
		Channel 4132	Channel 4183	Channel 4233
		826.4(MHz)	836.6(MHz)	846.6(MHz)
<b>RMC</b>		23.08	23.10	23.15
<b>HSDPA</b>	Sub - Test 1	22.54	22.52	22.59
	Sub - Test 2	22.53	22.54	22.56
	Sub - Test 3	22.00	22.04	22.08
	Sub - Test 4	22.01	22.05	22.06
<b>HSUPA</b>	Sub - Test 1	22.50	22.51	22.54
	Sub - Test 2	21.49	21.49	21.53
	Sub - Test 3	21.96	21.97	22.02
	Sub - Test 4	21.42	21.46	21.50
	Sub - Test 5	22.43	22.44	22.48
<b>DC-HSDPA</b>	Sub - Test 1	22.42	22.46	22.49
	Sub - Test 2	22.41	22.45	22.48
	Sub - Test 3	21.99	21.94	21.99
	Sub - Test 4	21.98	21.93	21.98
<b>HSPA+</b>	16QAM	21.97	22.01	22.05

LTE Band 5				Conducted Power(dBm)		
BW	Modulation	RB size	RB offset	Channel/Frequency(MHz)		
				20407/824.7	20525/836.5	20643/848.3
1.4MHz	QPSK	1	0	22.88	23.02	22.32
		1	2	23.24	22.91	22.38
		1	5	23.35	22.61	22.08
		3	0	21.97	21.22	20.98
		3	2	21.93	21.20	20.99
		3	3	21.86	21.25	20.95
		6	0	21.74	21.27	20.94
	16QAM	1	0	21.83	21.01	21.42
		1	2	21.39	20.87	21.58
		1	5	21.19	20.94	21.27
		3	0	20.68	20.46	20.06
		3	2	20.78	20.46	20.10
		3	3	20.84	20.46	20.08
		6	0	20.65	20.51	20.11
BW	Modulation	RB size	RB offset	Channel/Frequency(MHz)		
				20415/825.5	20525/836.5	20635/847.5
3MHz	QPSK	1	0	22.90	23.03	22.35
		1	7	23.27	22.96	22.42
		1	14	23.37	22.65	22.11
		8	0	22.00	21.27	21.02
		8	4	21.96	21.25	21.03
		8	7	21.88	21.29	21.00
		15	0	21.82	21.29	20.98
	16QAM	1	0	21.85	21.04	21.44
		1	7	21.42	20.91	21.61
		1	14	21.22	20.96	21.30
		8	0	20.71	20.51	20.10
		8	4	20.80	20.50	20.13
		8	7	20.87	20.51	20.12
		15	0	20.68	20.56	20.15
BW	Modulation	RB size	RB offset	Channel/Frequency(MHz)		
				20425/826.5	20525/836.5	20625/846.5
5MHz	QPSK	1	0	22.89	22.99	22.33



		1	13	23.25	22.95	22.39
		1	24	23.34	22.60	22.07
		12	0	21.98	21.23	20.99
		12	6	21.93	21.20	20.99
		12	13	21.85	21.26	20.96
		25	0	21.80	21.25	20.93
	16QAM	1	0	21.80	21.02	21.42
		1	13	21.40	20.88	21.59
		1	24	21.19	20.92	21.27
		12	0	20.68	20.49	20.07
		12	6	20.77	20.45	20.09
		12	13	20.85	20.47	20.09
		25	0	20.65	20.51	20.11
BW	Modulation	RB size	RB offset	Channel/Frequency(MHz)		
				20450/829	20525/836.5	20600/844
10MHz	QPSK	1	0	22.86	22.95	22.30
		1	25	23.24	22.91	22.37
		1	49	23.32	22.59	22.04
		25	0	21.95	21.18	20.95
		25	13	21.91	21.16	20.96
		25	25	21.82	21.21	20.92
		50	0	21.77	21.20	20.89
	16QAM	1	0	21.78	20.98	21.37
		1	25	21.36	20.86	21.55
		1	49	21.17	20.89	21.25
		25	0	20.65	20.45	20.04
		25	13	20.74	20.43	20.06
		25	25	20.82	20.42	20.05
		50	0	20.63	20.47	20.08

## 5.2. Effective Radiated Power

### Ambient condition

Temperature	Relative humidity	Pressure
23°C ~25°C	45%~50%	101.5kPa

### Methods of Measurement

The testing follows FCC KDB 971168 v03r01 Section 5.8 and ANSI C63.26 (2015).

- Connect the equipment as illustrated. Mount the equipment with the manufacturer specified antenna in a vertical orientation on a manufacturer specified mounting surface located on a non-conducting rotating platform of a RF anechoic chamber (preferred) or a standard radiation site.
- Key the transmitter, then rotate the EUT 360° azimuthally and record spectrum analyzer power level (LVL) measurements at angular increments that are sufficiently small to permit resolution of all peaks. If a standard radiation test site is used, raise and lower the test antenna to obtain a maximum reading at each angular increment. (Note: several batteries may be needed to offset the effect of battery voltage droop, which should not exceed 5% of the manufactured specified battery voltage during transmission).
- Replace the transmitter under test with a vertically polarized half-wave dipole (or an antenna whose gain is known relative to an ideal half-wave dipole). The center of the antenna should be at the same location as the center of the antenna under test.
- Connect the antenna to a signal generator with a known output power and record the path loss (in dB) as LOSS. If a standard radiation test site is used, raise and lower the test antenna to obtain a maximum reading.  $LOSS = \text{Generator Output Power (dBm)} - \text{Analyzer reading (dBm)}$
- Determine the effective radiated output power at each angular position from the readings in steps b) and d) using the following equation:  $ERP \text{ (dBm)} = LVL \text{ (dBm)} + LOSS \text{ (dB)}$
- The maximum ERP is the maximum value determined in the preceding step.
- When calculating ERP, in addition to knowing the antenna radiation and matching characteristics, it is necessary to know the loss values of all elements (e.g. transmission line attenuation, mismatches, filters, combiners) interposed between the point where transmitter output power is measured, and the point where power is applied to the antenna. ERP can then be calculated as follows:  
 $EIRP \text{ (dBm)} = \text{Output Power (dBm)} - \text{Losses (dB)} + \text{Antenna Gain (dBi)}$   
where: dBd refers to gain relative to an ideal dipole.  
 $EIRP \text{ (dBm)} = ERP \text{ (dBm)} + 2.15 \text{ (dB.)}$

The RB allocation refers to section 5.1, using the maximum output power configuration.

**Test setup**

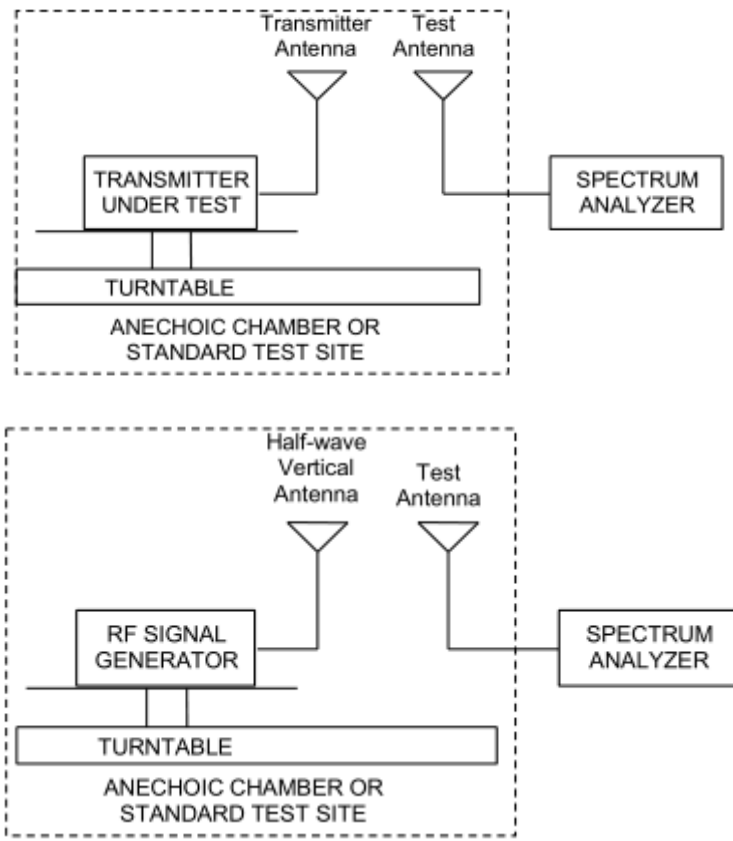

**Limits**

Rule Part 22.913(a)(5) specifies that "Mobile/portable stations are limited to 7 watts ERP".

Limit	$\leq 7 \text{ W}$ (38.45 dBm)
-------	--------------------------------

**Measurement Uncertainty**

The assessed measurement uncertainty to ensure 95% confidence level for the normal distribution is with the coverage factor  $k = 2$ ,  $U = 1.19 \text{ dB}$

**Test Results:**

The measurement is performed for both of horizontal and vertical antenna Polarization, and only the data of worst mode is recorded in this report.

Mode	Channel	Frequency (MHz)	Polarization	ERP (dBm)	Limit (dBm)	Conclusion
WCDMA Band V	Low	826.4	Horizontal	22.41	38.45	Pass
	Mid	836.6	Horizontal	22.82	38.45	Pass
	High	846.6	Horizontal	22.94	38.45	Pass

LTE Band 5						
bandwidth	Channel	Frequency (MHz)	Polarization	ERP (dBm)	Limit (dBm)	Conclusion
1.4 MHz (QPSK)	Low	824.7	Horizontal	22.21	38.45	Pass
	Mid	836.5	Horizontal	21.92	38.45	Pass
	High	848.3	Horizontal	21.88	38.45	Pass
3 MHz (QPSK)	Low	825.5	Horizontal	22.28	38.45	Pass
	Mid	836.5	Horizontal	22.00	38.45	Pass
	High	847.5	Horizontal	21.93	38.45	Pass
5 MHz (QPSK)	Low	826.5	Horizontal	22.33	38.45	Pass
	Mid	836.5	Horizontal	22.01	38.45	Pass
	High	846.5	Horizontal	21.97	38.45	Pass
10 MHz (QPSK)	Low	829	Horizontal	22.37	38.45	Pass
	Mid	836.5	Horizontal	22.06	38.45	Pass
	High	844	Horizontal	22.05	38.45	Pass
1.4 MHz (16QAM)	Low	824.7	Horizontal	21.78	38.45	Pass
	Mid	836.5	Horizontal	21.50	38.45	Pass
	High	848.3	Horizontal	21.45	38.45	Pass
3 MHz (16QAM)	Low	825.5	Horizontal	21.87	38.45	Pass
	Mid	836.5	Horizontal	21.59	38.45	Pass
	High	847.5	Horizontal	21.53	38.45	Pass
5 MHz (16QAM)	Low	826.5	Horizontal	21.96	38.45	Pass
	Mid	836.5	Horizontal	21.64	38.45	Pass
	High	846.5	Horizontal	21.60	38.45	Pass
10 MHz (16QAM)	Low	829	Horizontal	22.04	38.45	Pass
	Mid	836.5	Horizontal	21.69	38.45	Pass
	High	844	Horizontal	21.62	38.45	Pass



### 5.3. Occupied Bandwidth

#### Ambient condition

Temperature	Relative humidity	Pressure
23°C ~25°C	45%~50%	101.5kPa

#### Method of Measurement

The EUT was connected to Spectrum Analyzer and Base Station Simulator via power Splitter. The occupied bandwidth is measured using spectrum analyzer.

RBW is set to 51kHz, VBW is set to 160kHz for WCDMA Band V,

RBW is set to 51 kHz, VBW is set to 160 kHz for LTE Band 5 (1.4MHz),

RBW is set to 100 kHz, VBW is set to 300 kHz for LTE Band 5 (3MHz/5MHz),

RBW is set to 300 kHz, VBW is set to 1 MHz for LTE Band 5 (10MHz),

99% power and -26dBc occupied bandwidths are recorded. Spectrum analyzer plots are included on the following pages.

#### Test Setup

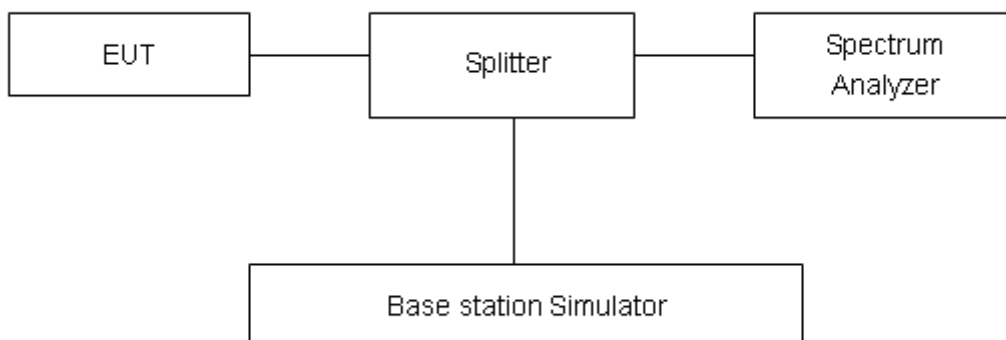

#### Limits

No specific occupied bandwidth requirements in part 2.1049.

#### Measurement Uncertainty

The assessed measurement uncertainty to ensure 95% confidence level for the normal distribution is with the coverage factor  $k = 2$ ,  $U = 624\text{Hz}$ .



## Test Result

Mode	Channel	Frequency (MHz)	99% Power Bandwidth (MHz)	-26dBc Bandwidth(MHz)
WCDMA Band V (RMC)	4132	826.4	4.1380	4.694
	4183	836.6	4.1291	4.711
	4233	846.6	4.1321	4.702

LTE Band 5						
RB	Modulation	Bandwidth (MHz)	Channel	Frequency (MHz)	99% Power Bandwidth(MHz)	-26dBc Bandwidth(MHz)
100%	QPSK	1.4	20407	824.7	1.1136	1.333
			20525	836.5	1.1280	1.352
			20643	848.3	1.1242	1.322
		3	20415	825.5	2.7437	3.067
			20525	836.5	2.7481	3.058
			20635	847.5	2.7344	3.038
		5	20425	826.5	4.5364	4.968
			20525	836.5	4.5201	5.039
			20625	846.5	4.5083	4.928
		10	20450	829	9.0415	10.020
			20525	836.5	8.9920	10.050
			20600	844	9.0362	10.030
	16QAM	1.4	20407	824.7	1.1277	1.350
			20525	836.5	1.1193	1.328
			20643	848.3	1.1160	1.326
		3	20415	825.5	2.7486	3.064
			20525	836.5	2.7351	3.059
			20635	847.5	2.7336	3.066
		5	20425	826.5	4.5161	5.014
			20525	836.5	4.5335	5.026
			20625	846.5	4.5341	5.020
		10	20450	829	9.0347	9.982
			20525	836.5	9.0178	9.991
			20600	844	9.0134	10.030

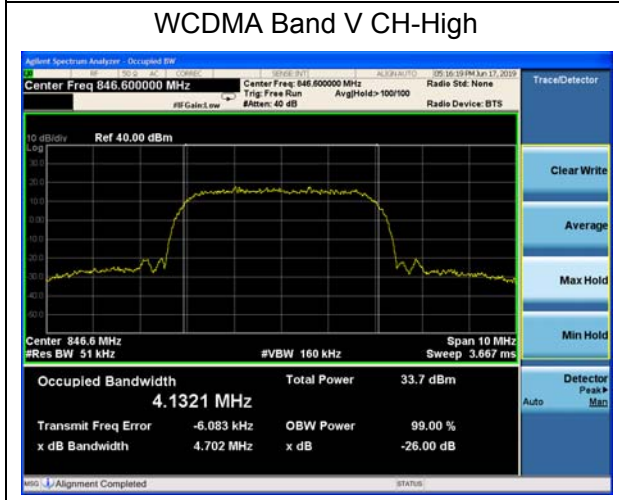
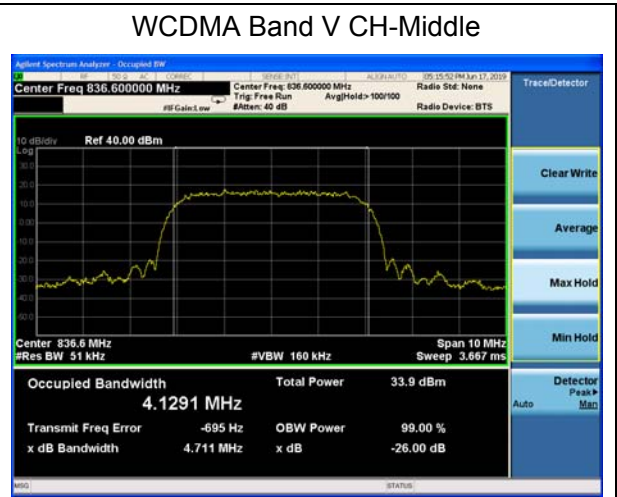
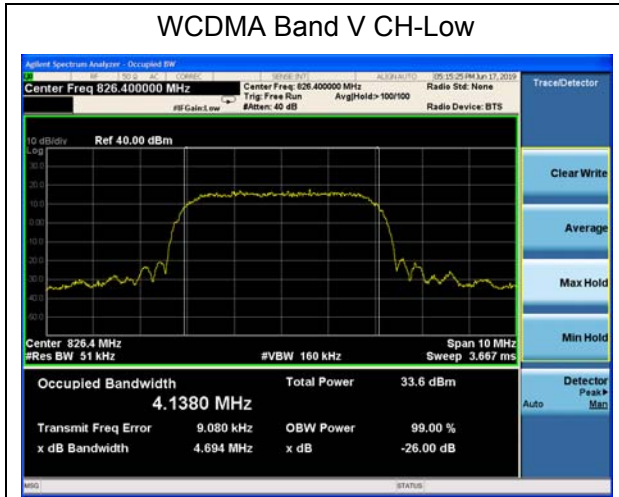

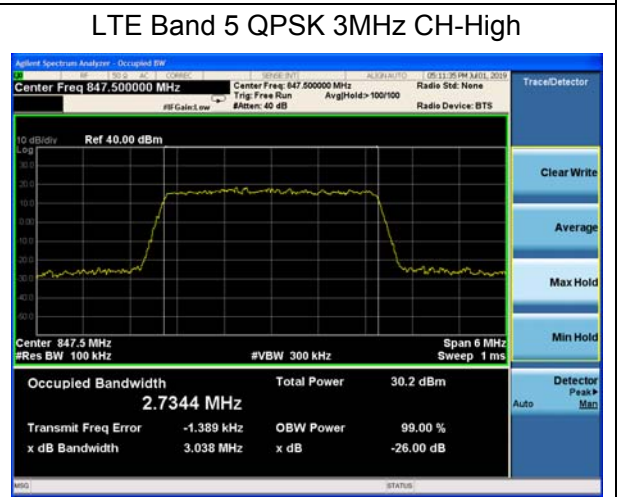
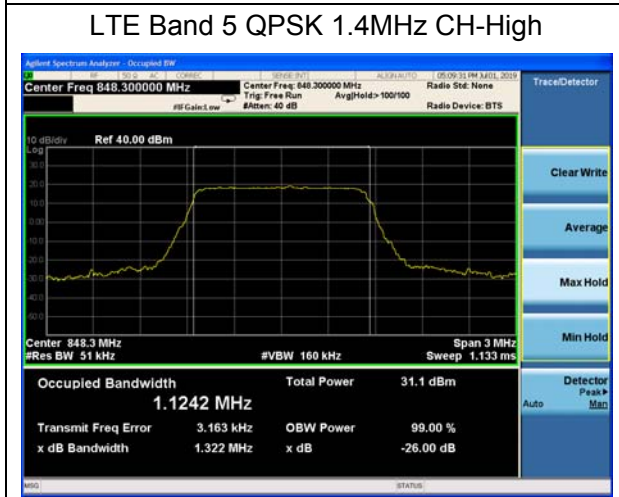
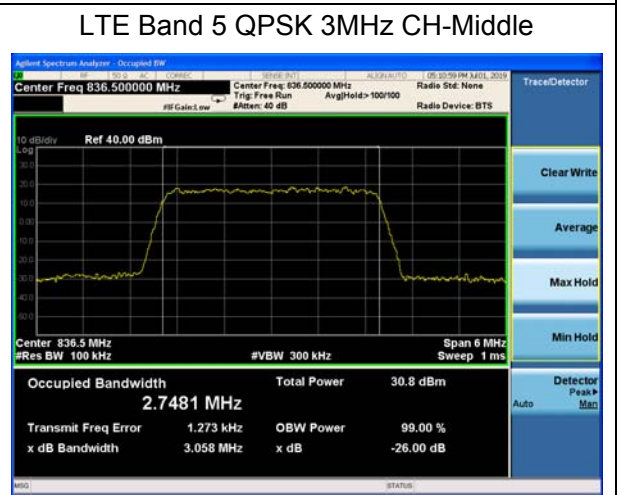
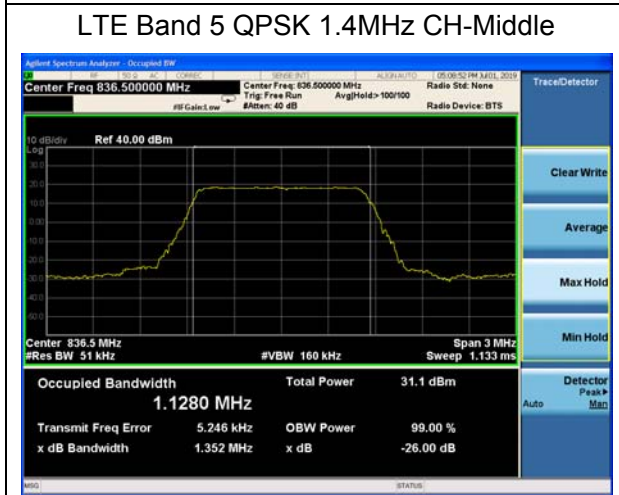
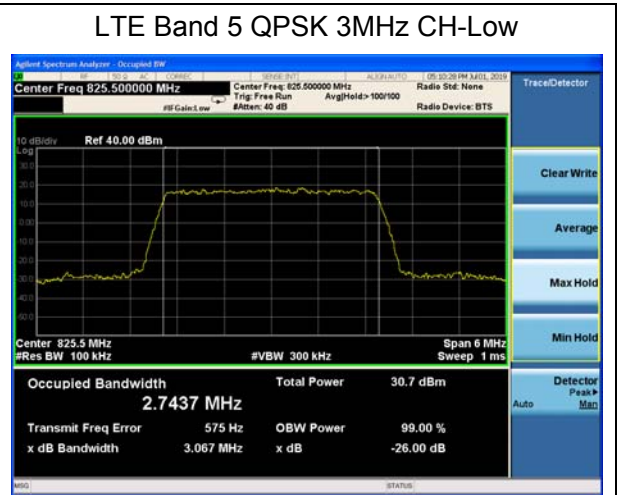
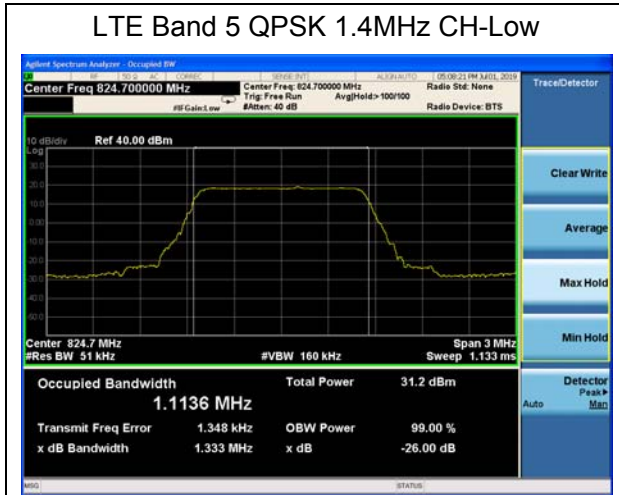

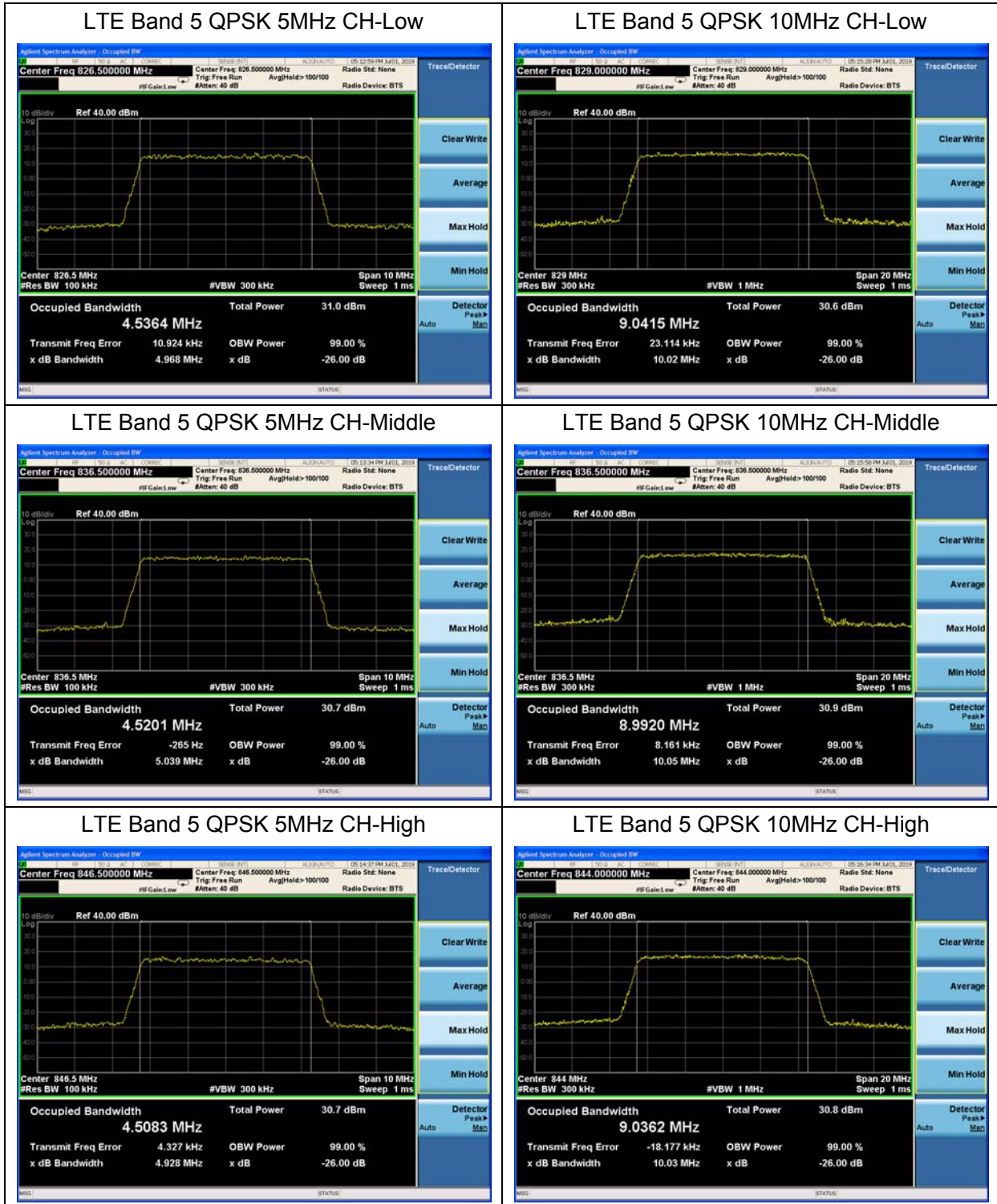

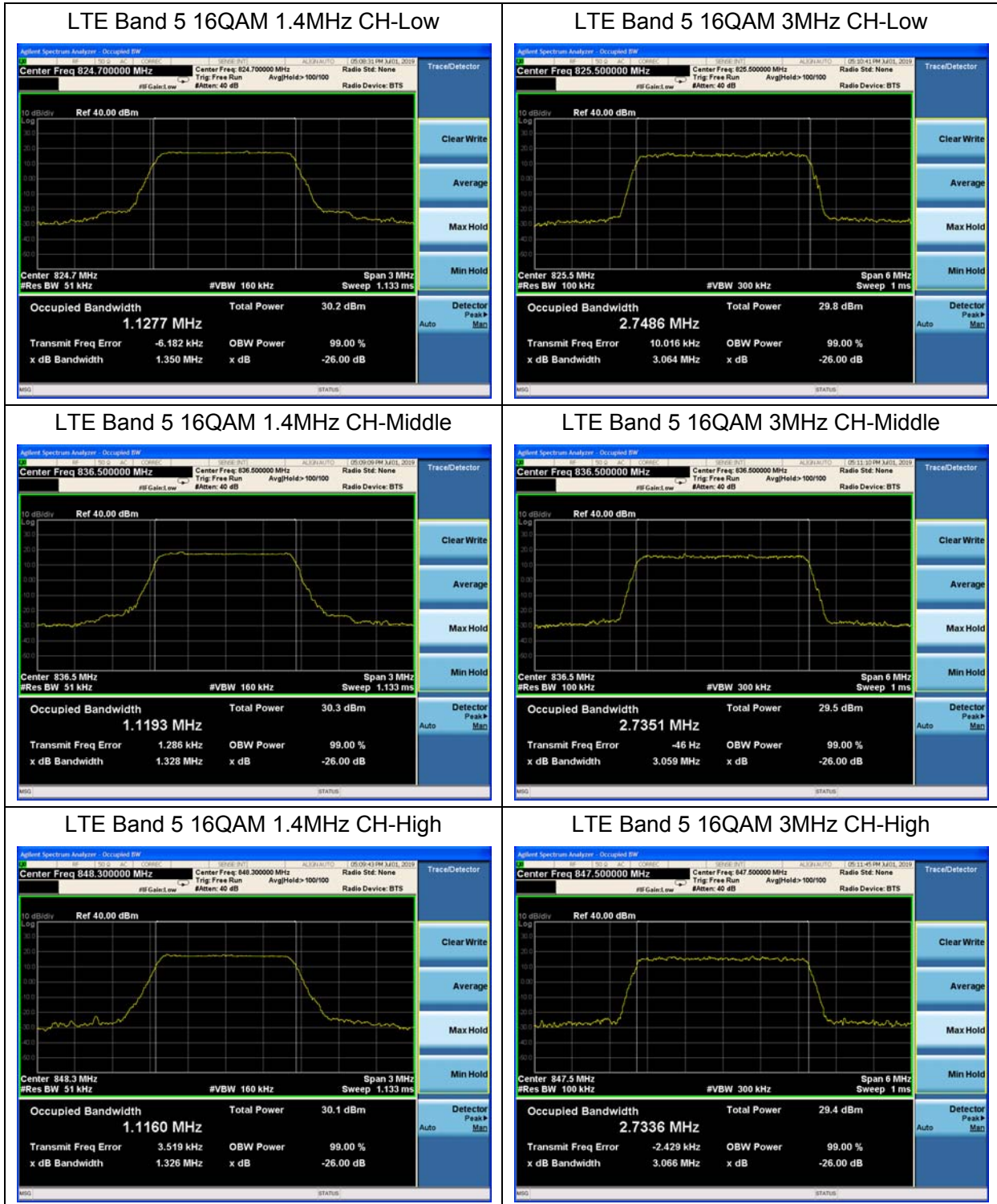

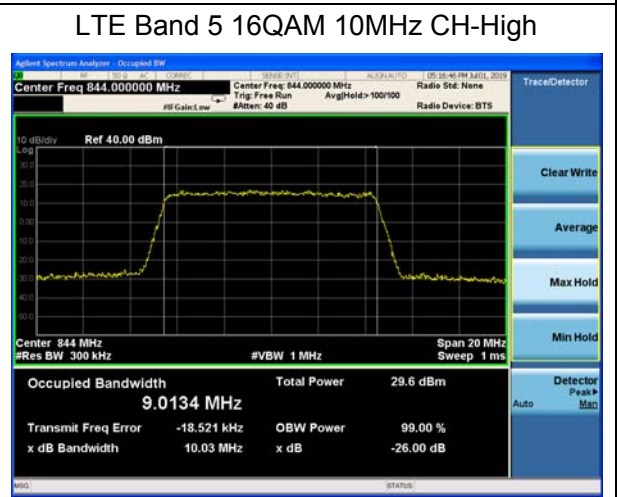
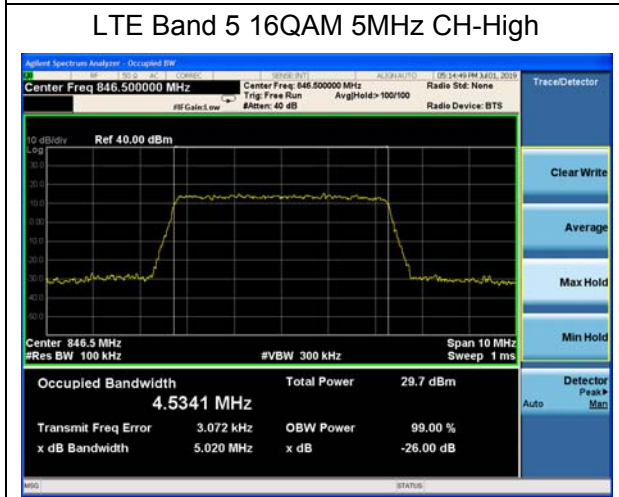
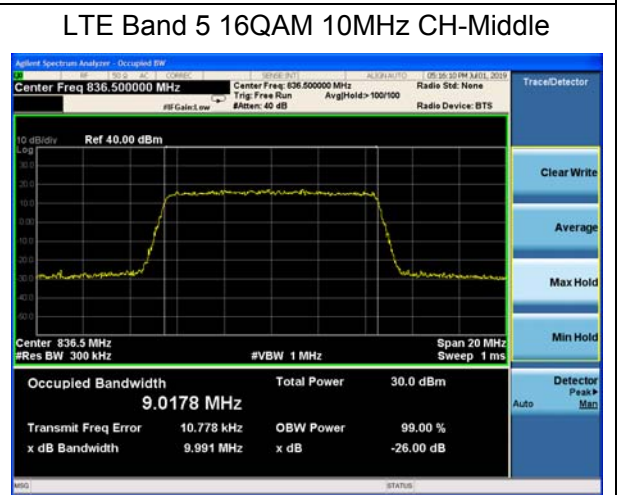
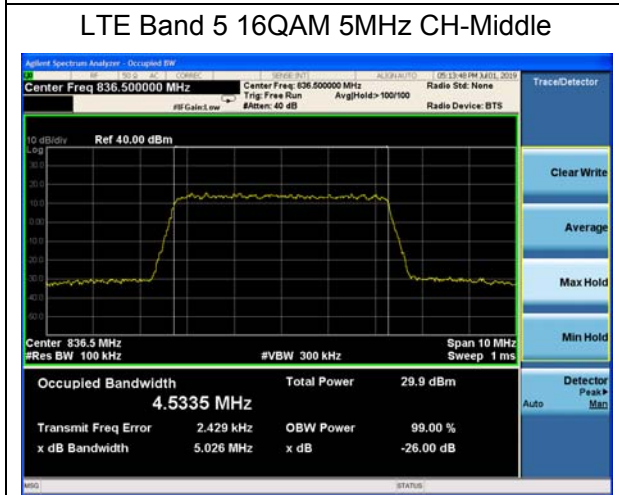
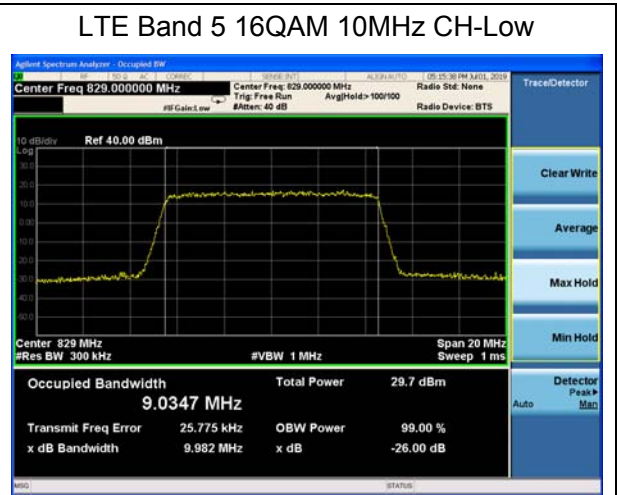
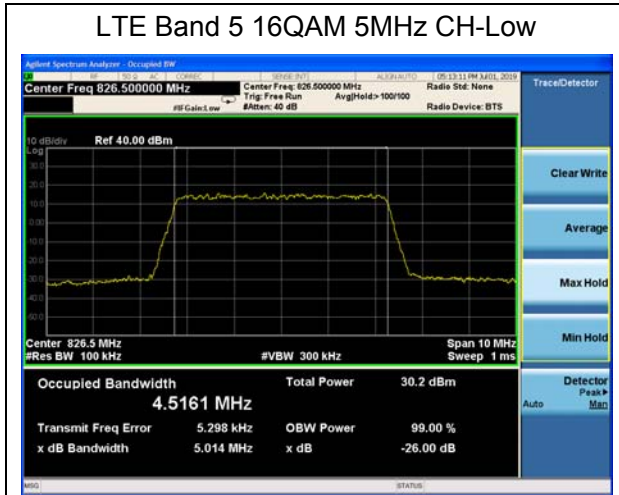

### 5.4. Band Edge Compliance

#### Ambient condition

Temperature	Relative humidity	Pressure
23°C ~25°C	45%~50%	101.5kPa

#### Method of Measurement

The EUT was connected to Spectrum Analyzer and Base Station Simulator via power Splitter. The band edge of the lowest and highest channels were measured. The average detector is used.

RBW is set to 51kHz,VBW is set to 160kHz for WCDMA Band V,  
 RBW is set to 15 kHz, VBW is set to 51 kHz for LTE Band 5 (1.4MHz),  
 RBW is set to 30 kHz, VBW is set to 100 kHz for LTE Band 5 (3MHz),  
 RBW is set to 51 kHz, VBW is set to 160 kHz for LTE Band 5 (5MHz),  
 RBW is set to 100 kHz, VBW is set to 300 kHz for LTE Band 5 (10MHz),  
 Spectrum analyzer plots are included on the following pages.

#### Test Setup

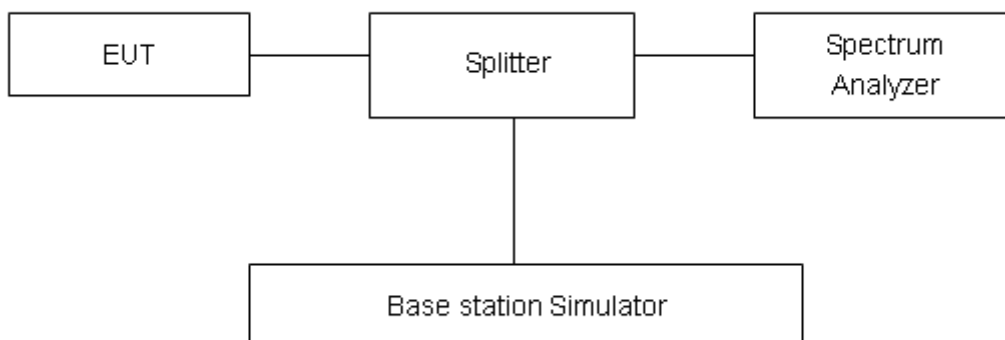

#### Limits

Rule Part 22.917(a) specifies that “The power of any emission outside of the authorized operating frequency ranges must be attenuated below the transmitting power (P) by a factor of at least 43 + 10 log(P) dB.”

Limit	-13 dBm
-------	---------

#### Measurement Uncertainty

The assessed measurement uncertainty to ensure 95% confidence level for the normal distribution is with the coverage factor  $k = 1.96$ ,  $U=0.684$ dB.



Test Result:

WCDMA Band V CH-Low



WCDMA Band V CH-High



LTE Band 5 QPSK 1.4MHz CH-Low 1RB

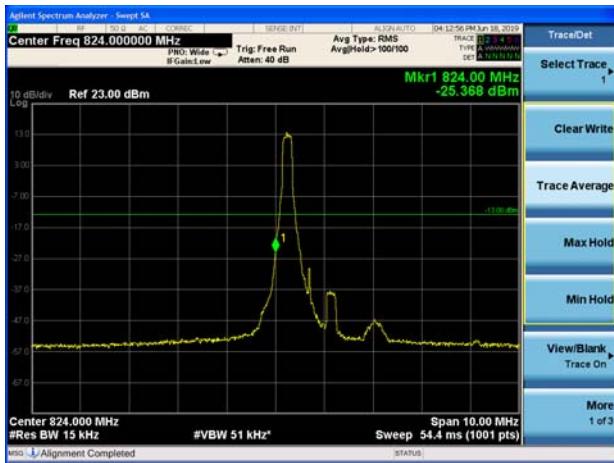

LTE Band 5 QPSK 1.4MHz CH-High 1RB

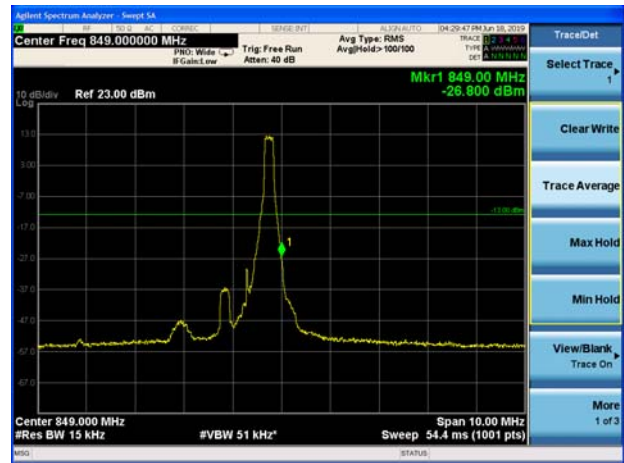

LTE Band 5 QPSK 1.4MHz CH-Low 100%RB

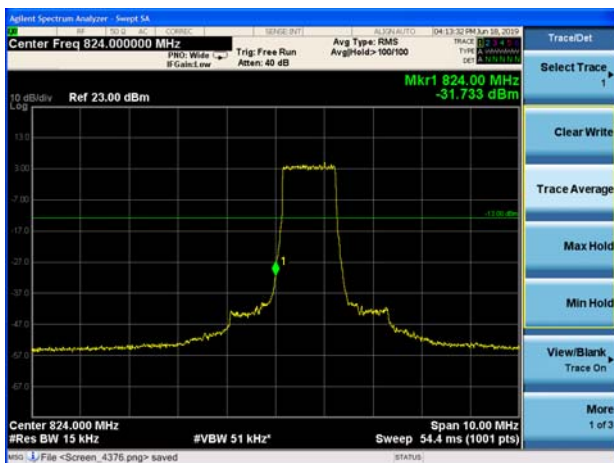

LTE Band 5 QPSK 1.4MHz CH-High 100%RB

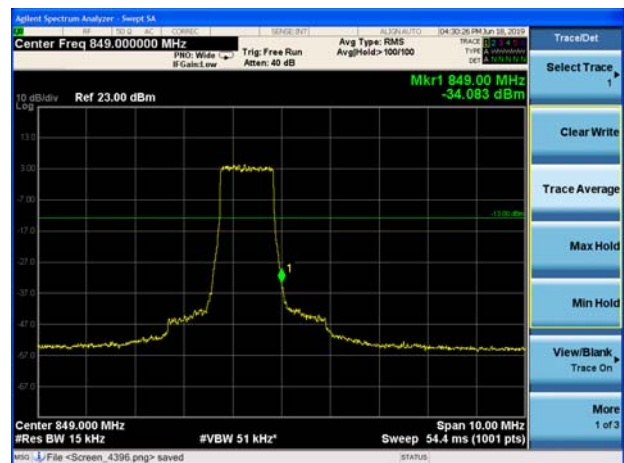



LTE Band 5 QPSK 3MHz CH-Low 1RB

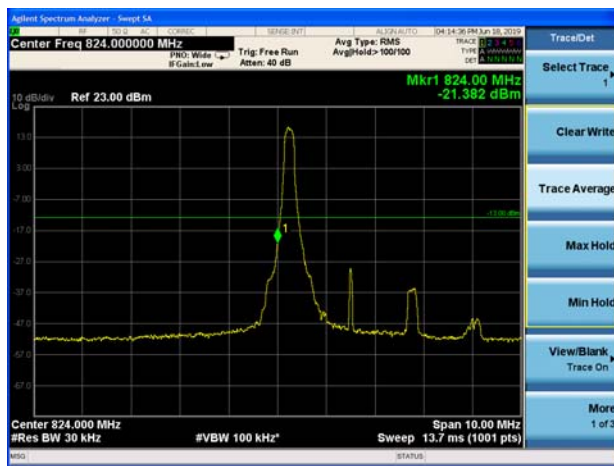

LTE Band 5 QPSK 3MHz CH-High 1RB

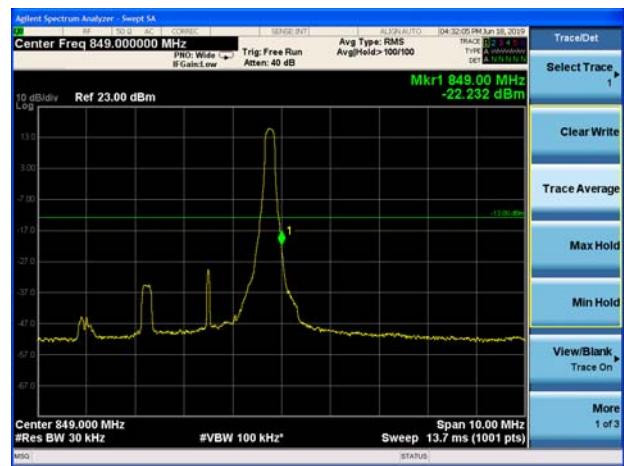

LTE Band 5 QPSK 3MHz CH-Low 100%RB

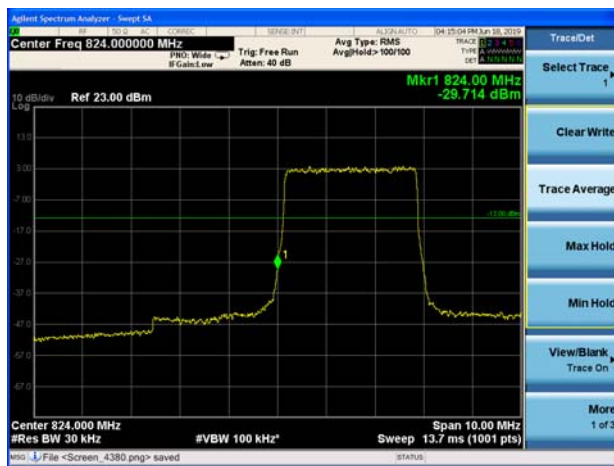

LTE Band 5 QPSK 3MHz CH-High 100%RB

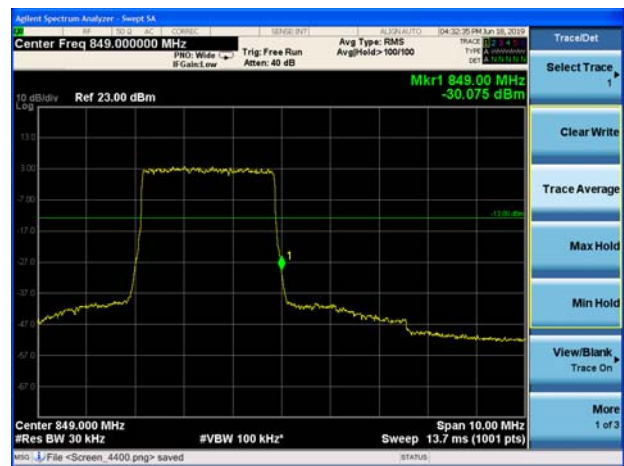

LTE Band 5 QPSK 5MHz CH-Low 1RB

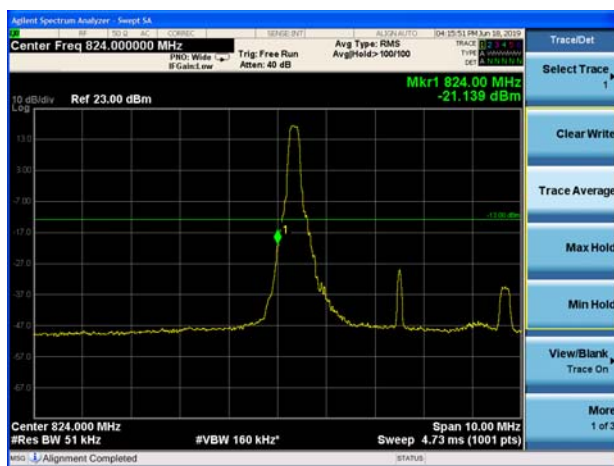

LTE Band 5 QPSK 5MHz CH-High 1RB

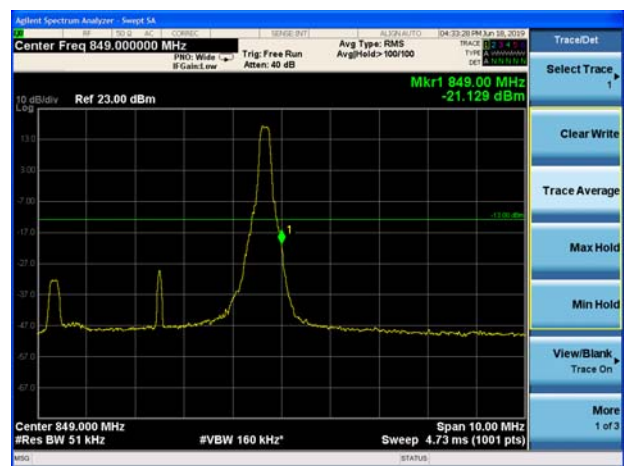

LTE Band 5 QPSK 5MHz CH-Low 100%RB

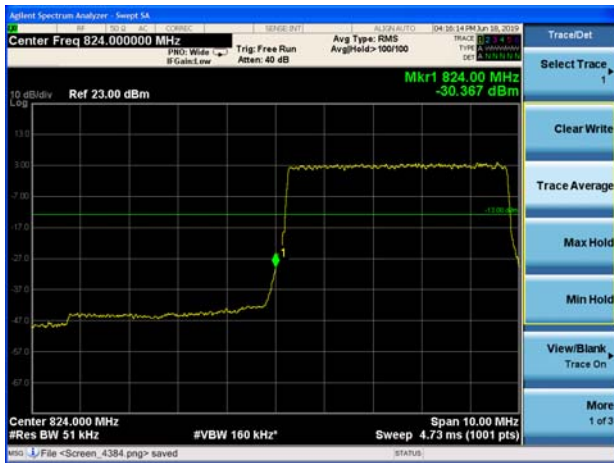

LTE Band 5 QPSK 5MHz CH-High 100%RB



LTE Band 5 QPSK 10MHz CH-Low 1RB

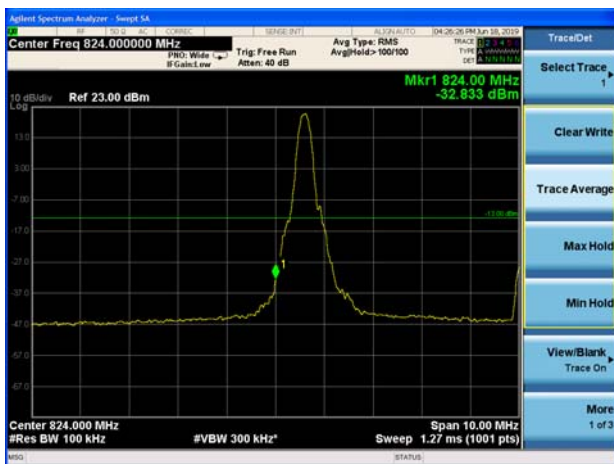

LTE Band 5 QPSK 10MHz CH-High 1RB

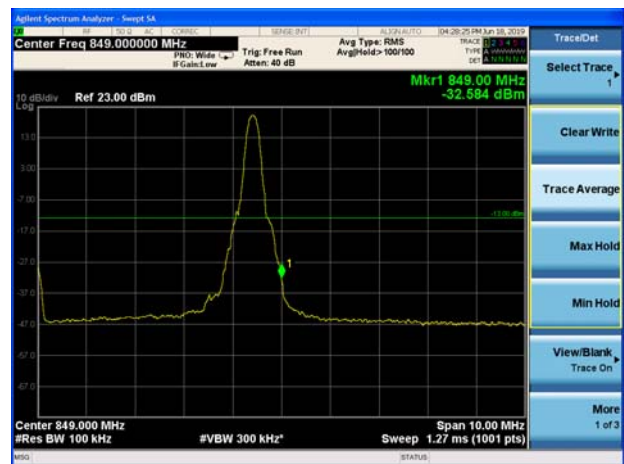

LTE Band 5 QPSK 10MHz CH-Low 100%RB

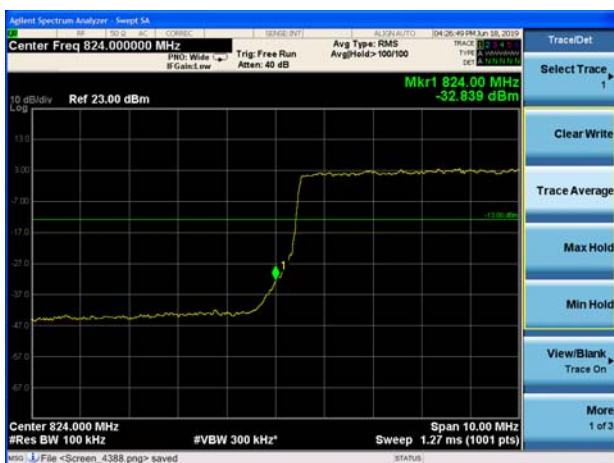

LTE Band 5 QPSK 10MHz CH-High 100%RB

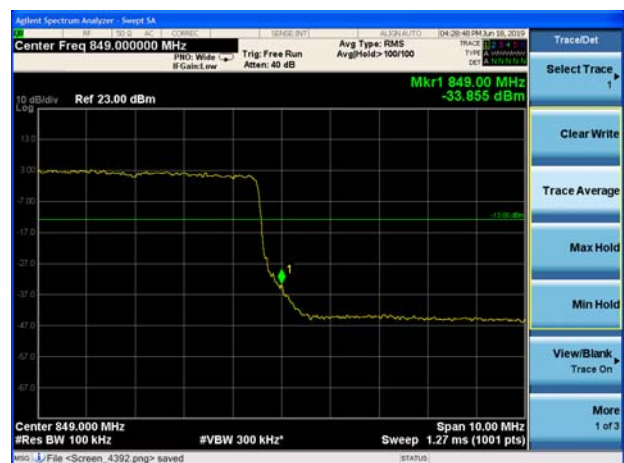



LTE Band 5 16QAM 1.4MHz CH-Low 1RB

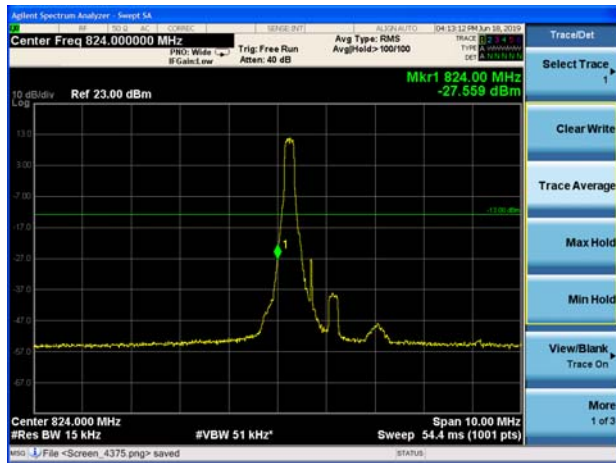

LTE Band 5 16QAM 1.4MHz CH-High 1RB

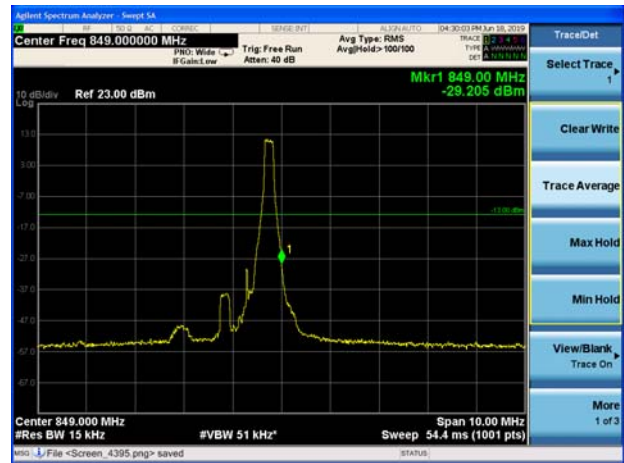

LTE Band 5 16QAM 1.4MHz CH-Low 100%RB

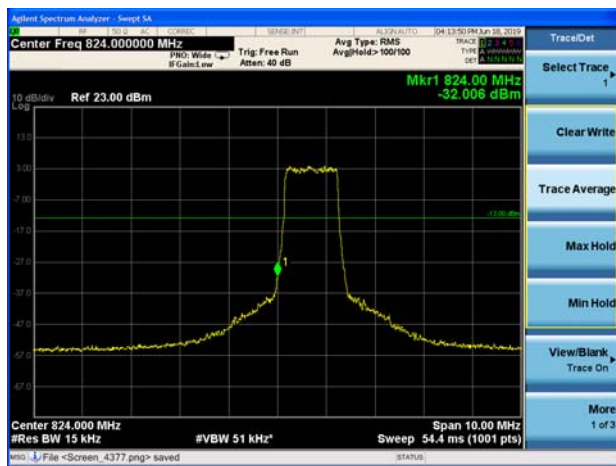

LTE Band 5 16QAM 1.4MHz CH-High 100%RB

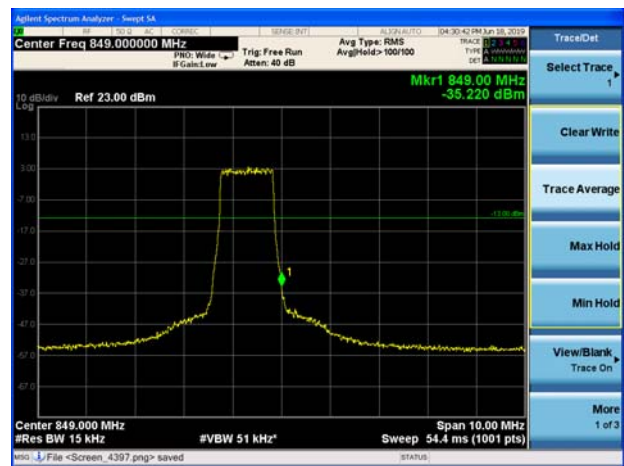

LTE Band 5 16QAM 3MHz CH-Low 1RB

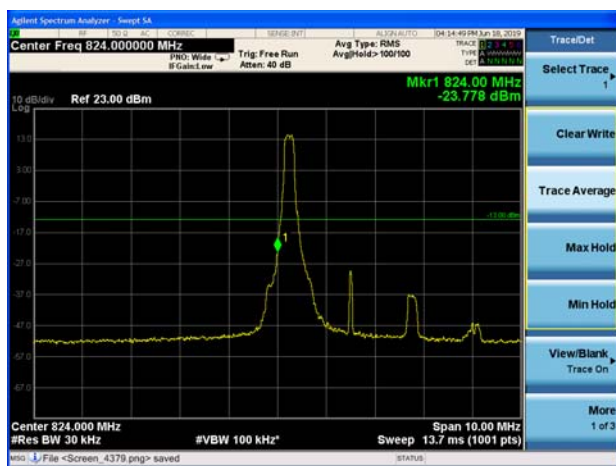

LTE Band 5 16QAM 3MHz CH-High 1RB

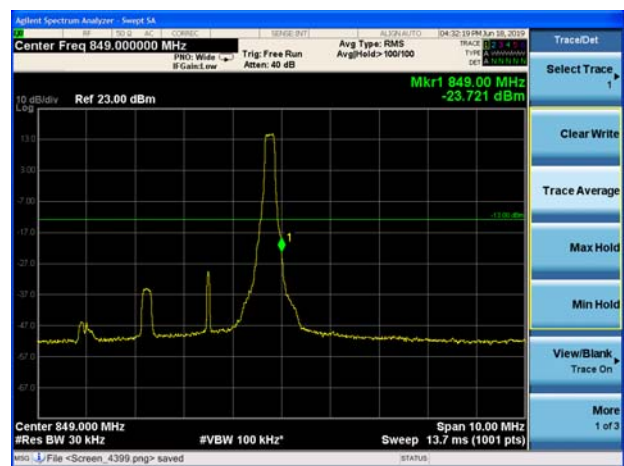

LTE Band 5 16QAM 3MHz CH-Low 100%RB



LTE Band 5 16QAM 3MHz CH-High 100%RB

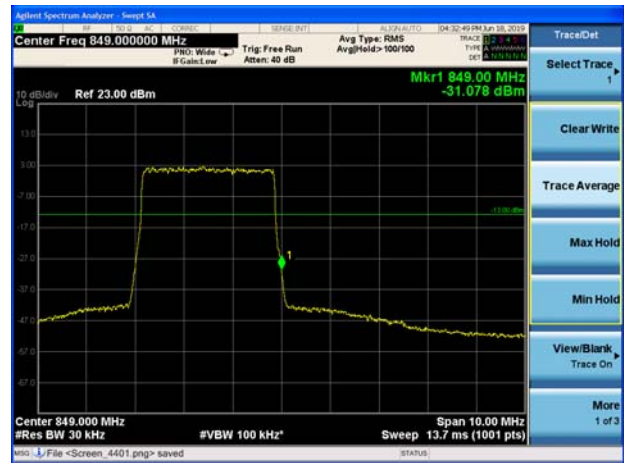

LTE Band 5 16QAM 5MHz CH-Low 1RB

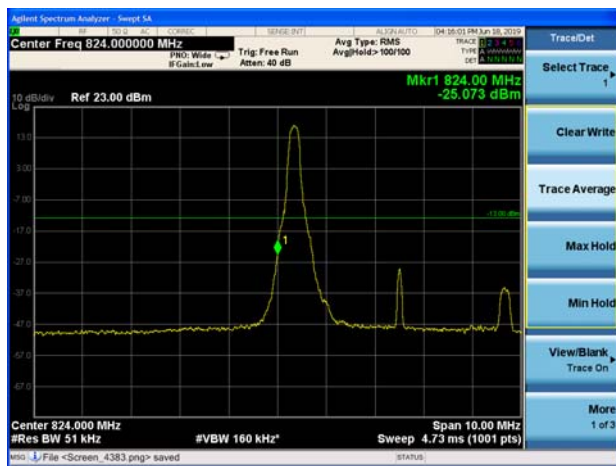

LTE Band 5 16QAM 5MHz CH-High 1RB

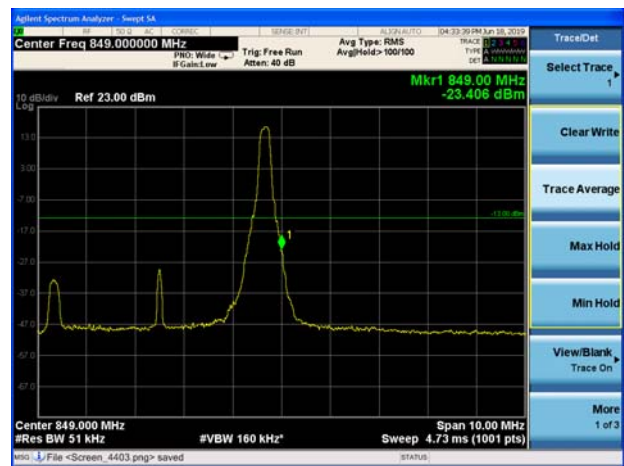

LTE Band 5 16QAM 5MHz CH-Low 100%RB

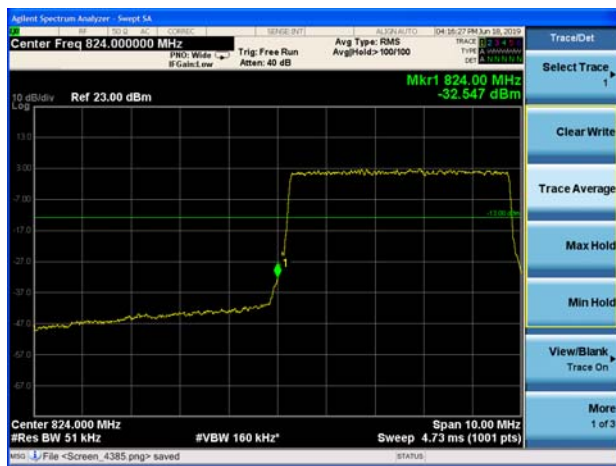

LTE Band 5 16QAM 5MHz CH-High 100%RB





LTE Band 5 16QAM 10MHz CH-Low 1RB

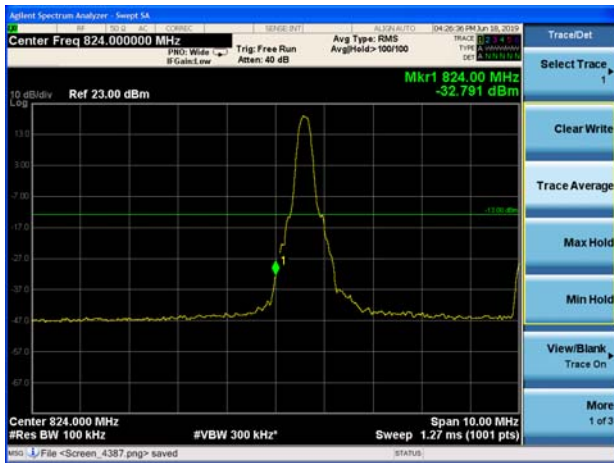

LTE Band 5 16QAM 10MHz CH-High 1RB

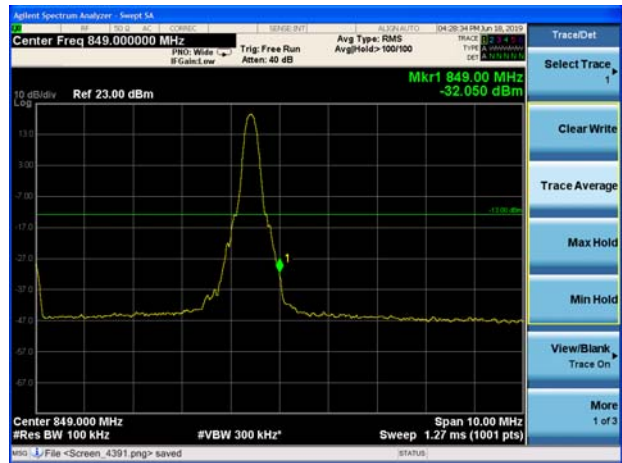

LTE Band 5 16QAM 10MHz CH-Low 100%RB

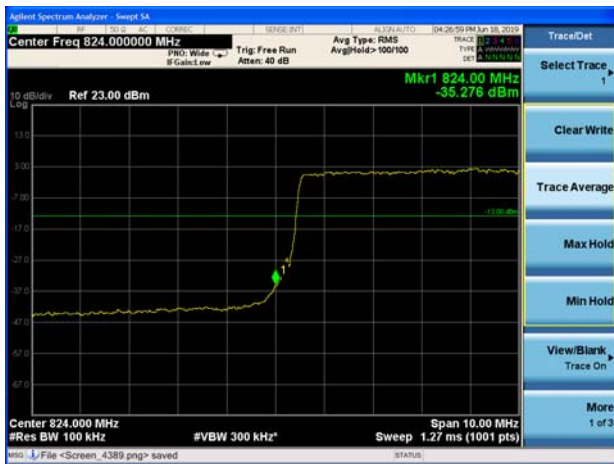

LTE Band 5 16QAM 10MHz CH-High 100%RB

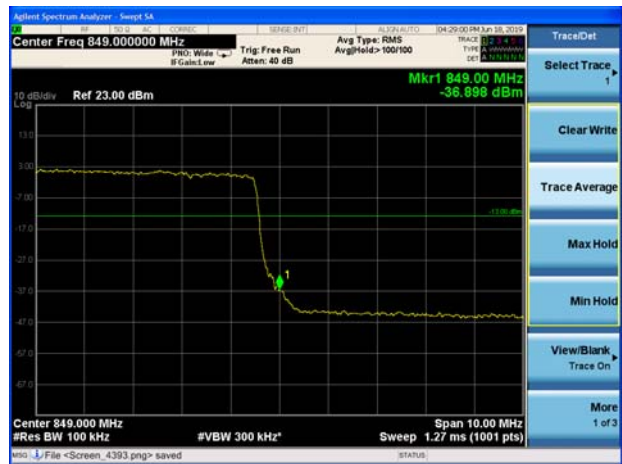

### 5.5. Peak-to-Average Power Ratio (PAPR)

#### Ambient condition

Temperature	Relative humidity	Pressure
23°C ~25°C	45%~50%	101.5kPa

#### Methods of Measurement

Measure the total peak power and record as  $P_{Pk}$ . And measure the total average power and record as  $P_{Avg}$ . Both the peak and average power levels must be expressed in the same logarithmic units (e.g., dBm). Determine the PAPR from:

$$PAPR (dB) = P_{Pk} (dBm) - P_{Avg} (dBm).$$

#### Test Setup

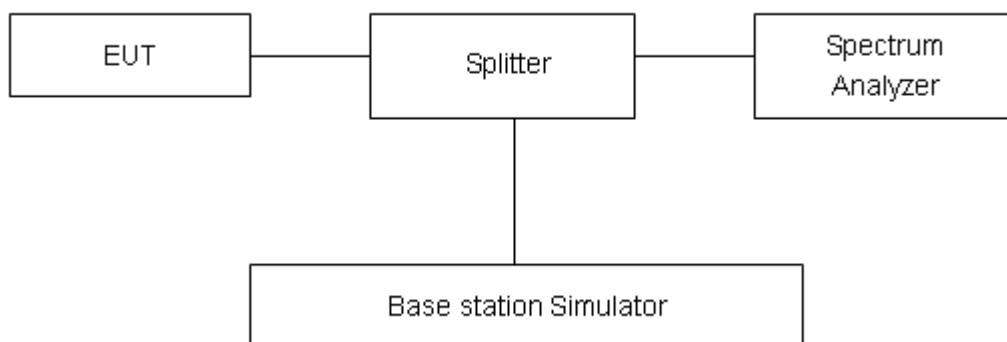

#### Limits

According to the Sec. 22.913(d), The peak-to-average ratio (PAR) of the transmission must not exceed 13 dB.

#### Measurement Uncertainty

The assessed measurement uncertainty to ensure 95% confidence level for the normal distribution is with the coverage factor  $k = 2$ ,  $U = 0.4$  dB.

**Test Results**

Mode	Channel	Frequency (MHz)	Peak (dBm)	Avg (dBm)	PAPR (dB)	Limit (dB)	Conclusion
WCDMA Band V (RMC)	4132	826.4	27.37	24.46	2.91	≤13	PASS
	4183	836.6	27.39	24.49	2.90	≤13	PASS
	4233	846.6	27.23	24.42	2.81	≤13	PASS

LTE Band 5								
Modulation	Bandwidth (MHz)	Channel	Frequency (MHz)	Peak (dBm)	Avg (dBm)	PAPR (dB)	Limit (dB)	Conclusion
QPSK	1.4	20407	824.7	27.55	22.46	5.09	≤13	PASS
		20525	836.5	27.46	22.39	5.07	≤13	PASS
		20643	848.3	27.28	22.34	4.94	≤13	PASS
	3	20415	825.5	27.72	22.60	5.12	≤13	PASS
		20525	836.5	27.52	22.43	5.09	≤13	PASS
		20635	847.5	27.32	22.32	5.00	≤13	PASS
	5	20425	826.5	27.02	21.85	5.17	≤13	PASS
		20525	836.5	26.92	21.77	5.15	≤13	PASS
		20625	846.5	26.75	21.72	5.03	≤13	PASS
	10	20450	829	27.00	21.92	5.08	≤13	PASS
		20525	836.5	26.86	21.78	5.08	≤13	PASS
		20600	844	26.77	21.78	4.99	≤13	PASS
16QAM	1.4	20407	824.7	27.41	21.47	5.94	≤13	PASS
		20525	836.5	27.21	21.23	5.98	≤13	PASS
		20643	848.3	27.19	21.39	5.80	≤13	PASS
	3	20415	825.5	27.68	21.70	5.98	≤13	PASS
		20525	836.5	27.35	21.36	5.99	≤13	PASS
		20635	847.5	27.19	21.37	5.82	≤13	PASS
	5	20425	826.5	26.85	20.87	5.98	≤13	PASS
		20525	836.5	26.78	20.81	5.97	≤13	PASS
		20625	846.5	26.59	20.76	5.83	≤13	PASS
	10	20450	829	26.83	20.92	5.91	≤13	PASS
		20525	836.5	26.64	20.70	5.94	≤13	PASS
		20600	844	26.60	20.75	5.85	≤13	PASS



## 5.6. Frequency Stability

### Ambient condition

Temperature	Relative humidity	Pressure
23°C ~25°C	45%~50%	101.5kPa

### Method of Measurement

#### Frequency Stability (Temperature Variation)

The temperature inside the climate chamber is varied from -40°C to +85°C in 10°C step size,

(1) With all power removed, the temperature was decreased to 0°C and permitted to stabilize for three hours.

(2) Measure the carrier frequency with the test equipment in a “call mode”. These measurements should be made within 1 minute of powering up the mobile station, to prevent significant self warming.

(3) Repeat the above measurements at 10°C increments from -40°C to +85°C. Allow at least 1.5 hours at each temperature, un-powered, before making measurements.

#### Frequency Stability (Voltage Variation)

The frequency stability shall be measured with variation of primary supply voltage as follows:

(1) Vary primary supply voltage from 85 to 115 percent of the nominal value for other than hand carried battery equipment.

(2) For hand carried, battery powered equipment, reduce primary supply voltage to the battery-operating end point which shall be specified by the manufacturer.

This transceiver is specified to operate with an input voltage of between 3.3 V and 4.3 V, with a nominal voltage of 3.8V.

### Test setup

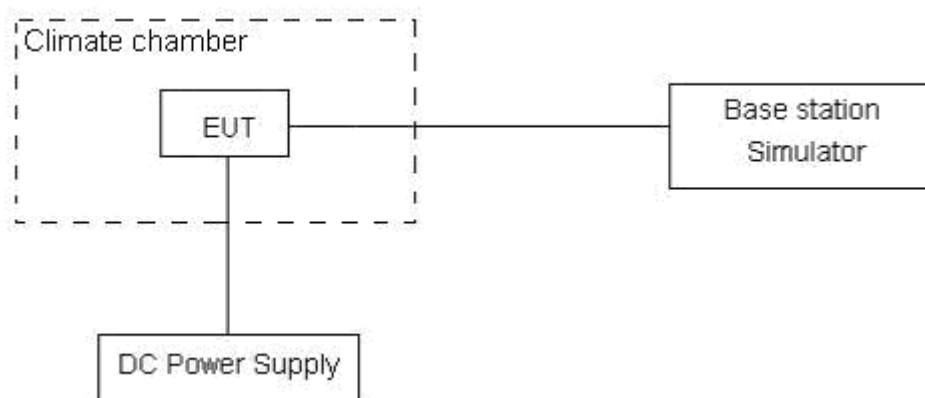

**Limits**

According to the Sec. 22.355, the frequency stability of the carrier shall be accurate to within 2.5 ppm of the received frequency for mobile stations.

Limits	$\leq 2.5$ ppm
--------	----------------

**Measurement Uncertainty**

The assessed measurement uncertainty to ensure 99.75% confidence level for the normal distribution is with the coverage factor  $k = 3$ ,  $U = 0.01$  ppm.

**Test Result**

WCDMA Band 5						
Condition		Freq.Error (Hz)	Freq.Error (Hz)	Frequency Stability (ppm)	Frequency Stability (ppm)	Verdict
Temperature	Voltage	QPSK	BPSK	QPSK	BPSK	
Normal (25°C)	Normal	6.16	4.22	0.00328	0.00225	PASS
Normal (85°C)		3.84	14.86	0.00204	0.00790	PASS
Normal (80°C)		2.92	8.12	0.00155	0.00432	PASS
Normal (70°C)		9.79	13.63	0.00521	0.00725	PASS
Extreme (60°C)		12.89	12.05	0.00686	0.00641	PASS
Extreme (50°C)		3.67	8.90	0.00195	0.00473	PASS
Extreme (40°C)		17.48	6.96	0.00930	0.00370	PASS
Extreme (30°C)		13.28	4.64	0.00706	0.00247	PASS
Extreme (20°C)		2.23	17.89	0.00119	0.00951	PASS
Extreme (10°C)		4.38	14.40	0.00233	0.00766	PASS
Extreme (0°C)		7.63	7.53	0.00406	0.00401	PASS
Extreme (-10°C)		6.28	1.92	0.00334	0.00102	PASS
Extreme (-20°C)		11.83	5.16	0.00629	0.00274	PASS
Extreme (-30°C)		8.65	16.89	0.00460	0.00898	PASS
Extreme (-40°C)		2.74	16.65	0.00146	0.00886	PASS
25°C	LV	11.56	8.73	0.00615	0.00465	PASS
	HV	1.76	13.41	0.00094	0.00713	PASS

LTE Band 5						
Condition		Freq.Error (Hz)	Freq.Error (Hz)	Frequency Stability (ppm)	Frequency Stability (ppm)	Verdict
BANDWIDTH	1.4MHz					
Temperature	Voltage	16QAM	QPSK	16QAM	QPSK	
Normal (25°C)	Normal	9.91	15.74	0.00527	0.00837	PASS
Extreme (85°C)		5.79	2.48	0.00308	0.00132	PASS
Extreme (80°C)		14.86	14.12	0.00790	0.00751	PASS
Extreme (70°C)		11.84	8.37	0.00630	0.00445	PASS
Extreme (60°C)		12.49	17.39	0.00664	0.00925	PASS
Extreme (50°C)		14.85	9.99	0.00790	0.00531	PASS
Extreme (40°C)		15.36	15.48	0.00817	0.00824	PASS
Extreme (30°C)		15.83	7.13	0.00842	0.00379	PASS
Extreme (20°C)		5.22	15.35	0.00277	0.00817	PASS
Extreme (10°C)		1.68	3.47	0.00089	0.00185	PASS
Extreme (0°C)		13.10	4.61	0.00697	0.00245	PASS



Extreme (-10°C)		16.35	8.63	0.00870	0.00459	PASS
Extreme (-20°C)		14.00	10.44	0.00745	0.00555	PASS
Extreme (-30°C)		7.83	8.55	0.00417	0.00455	PASS
Extreme (-40°C)		4.07	15.62	0.00216	0.00831	PASS
25°C	LV	4.70	1.58	0.00250	0.00084	PASS
	HV	16.56	12.57	0.00881	0.00669	PASS
Condition		Freq.Error (Hz)	Freq.Error (Hz)	Frequency Stability (ppm)	Frequency Stability (ppm)	Verdict
BANDWIDTH	3MHz					
Temperature	Voltage	16QAM	QPSK	16QAM	QPSK	
Normal (25°C)	Normal	9.65	11.67	0.00513	0.00621	PASS
Extreme (85°C)		1.37	13.11	0.00073	0.00698	PASS
Extreme (80°C)		10.78	3.91	0.00573	0.00208	PASS
Extreme (70°C)		15.23	9.89	0.00810	0.00526	PASS
Extreme (60°C)		1.27	6.48	0.00068	0.00345	PASS
Extreme (50°C)		10.51	8.67	0.00559	0.00461	PASS
Extreme (40°C)		16.66	14.95	0.00886	0.00795	PASS
Extreme (30°C)		5.73	7.45	0.00305	0.00396	PASS
Extreme (20°C)		9.61	9.80	0.00511	0.00522	PASS
Extreme (10°C)		10.05	12.88	0.00535	0.00685	PASS
Extreme (0°C)		14.47	12.04	0.00770	0.00640	PASS
Extreme (-10°C)		2.48	12.87	0.00132	0.00684	PASS
Extreme (-20°C)		11.47	9.99	0.00610	0.00531	PASS
Extreme (-30°C)		3.75	14.38	0.00200	0.00765	PASS
Extreme (-40°C)		6.55	8.98	0.00349	0.00478	PASS
25°C	LV	12.38	12.69	0.00658	0.00675	PASS
	HV	2.78	3.45	0.00148	0.00183	PASS
Condition		Freq.Error (Hz)	Freq.Error (Hz)	Frequency Stability (ppm)	Frequency Stability (ppm)	Verdict
BANDWIDTH	5MHz					
Temperature	Voltage	16QAM	QPSK	16QAM	QPSK	
Normal (25°C)	Normal	11.19	3.19	0.00595	0.00170	PASS
Extreme (85°C)		10.00	3.78	0.00532	0.00201	PASS
Extreme (80°C)		3.67	11.39	0.00195	0.00606	PASS
Extreme (70°C)		4.76	3.41	0.00253	0.00182	PASS
Extreme (60°C)		15.08	10.10	0.00802	0.00537	PASS
Extreme (50°C)		16.02	9.20	0.00852	0.00489	PASS
Extreme (40°C)		3.65	2.46	0.00194	0.00131	PASS
Extreme (30°C)		14.87	14.48	0.00791	0.00770	PASS
Extreme (20°C)		9.48	7.09	0.00504	0.00377	PASS
Extreme (10°C)		7.82	9.70	0.00416	0.00516	PASS
Extreme (0°C)		13.64	5.02	0.00726	0.00267	PASS



Extreme (-10°C)		16.89	3.85	0.00898	0.00205	PASS
Extreme (-20°C)		2.61	5.28	0.00139	0.00281	PASS
Extreme (-30°C)		9.29	4.40	0.00494	0.00234	PASS
Extreme (-40°C)		7.02	4.40	0.00373	0.00234	PASS
25°C	LV	11.41	5.00	0.00607	0.00266	PASS
	HV	2.81	5.50	0.00149	0.00292	PASS
Condition		Freq.Error (Hz)	Freq.Error (Hz)	Frequency Stability (ppm)	Frequency Stability (ppm)	Verdict
BANDWIDTH	10MHz					
Temperature	Voltage	16QAM	QPSK	16QAM	QPSK	
Normal (25°C)	Normal	11.38	4.37	0.00605	0.00233	PASS
Extreme (85°C)		13.40	8.18	0.00713	0.00435	PASS
Extreme (80°C)		11.89	13.35	0.00633	0.00710	PASS
Extreme (70°C)		8.26	4.41	0.00439	0.00235	PASS
Extreme (60°C)		7.65	5.03	0.00407	0.00268	PASS
Extreme (50°C)		4.31	16.11	0.00229	0.00857	PASS
Extreme (40°C)		12.80	7.88	0.00681	0.00419	PASS
Extreme (30°C)		14.21	13.91	0.00756	0.00740	PASS
Extreme (20°C)		4.68	2.78	0.00249	0.00148	PASS
Extreme (10°C)		5.48	4.94	0.00292	0.00263	PASS
Extreme (0°C)		6.76	4.34	0.00360	0.00231	PASS
Extreme (-10°C)		13.07	17.26	0.00695	0.00918	PASS
Extreme (-20°C)		15.16	15.78	0.00806	0.00840	PASS
Extreme (-30°C)		10.47	8.16	0.00557	0.00434	PASS
Extreme (-40°C)		2.38	9.04	0.00126	0.00481	PASS
25°C	LV	1.95	12.72	0.00104	0.00677	PASS
	HV	15.19	11.10	0.00808	0.00591	PASS

### 5.7. Spurious Emissions at Antenna Terminals

#### Ambient condition

Temperature	Relative humidity	Pressure
23°C ~25°C	45%~50%	101.5kPa

#### Method of Measurement

The EUT was connected to Spectrum Analyzer and Base Station Simulator via power Splitter. The measurement is carried out using a spectrum analyzer. The spectrum analyzer scans from 9kHz to the 10th harmonic of the carrier.

The peak detector is used. RBW are set to 100 kHz and VBW are set to 300 kHz for below 1G, RBW are set to 1MHz and VBW are set to 3MHz for above 1G, Sweep is set to ATUO.

The modulation mode and RB allocation refer to section 5.1, using the maximum output power configuration.

#### Test setup

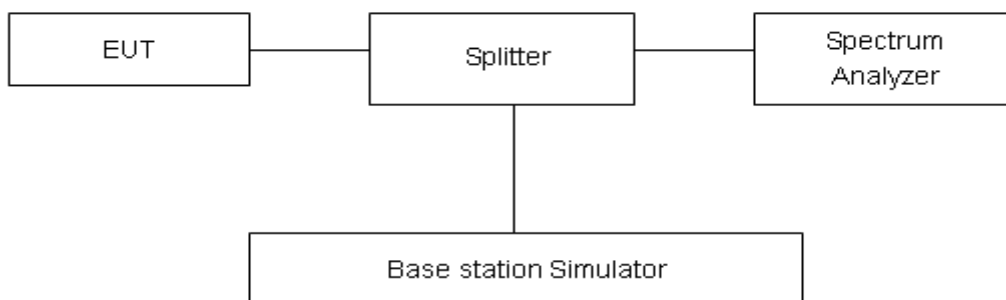

#### Limits

Rule Part 22.917(a) specifies that “The power of any emission outside of the authorized operating frequency ranges must be attenuated below the transmitting power (P) by a factor of at least 43 + 10 log (P) dB.”

Limit	-13 dBm
-------	---------

#### Measurement Uncertainty

The assessed measurement uncertainty to ensure 99.75% confidence level for the normal distribution is with the coverage factor  $k = 1.96$ .

Frequency	Uncertainty
9kHz-1GHz	0.684 dB
1GHz-18GHz	1.407 dB



### Test Result

Sweep the whole frequency band through the range from 9kHz to the 10th harmonic of the carrier, the emissions more than 20 dB below the limit are not reported.

The signal beyond the limit is carrier.

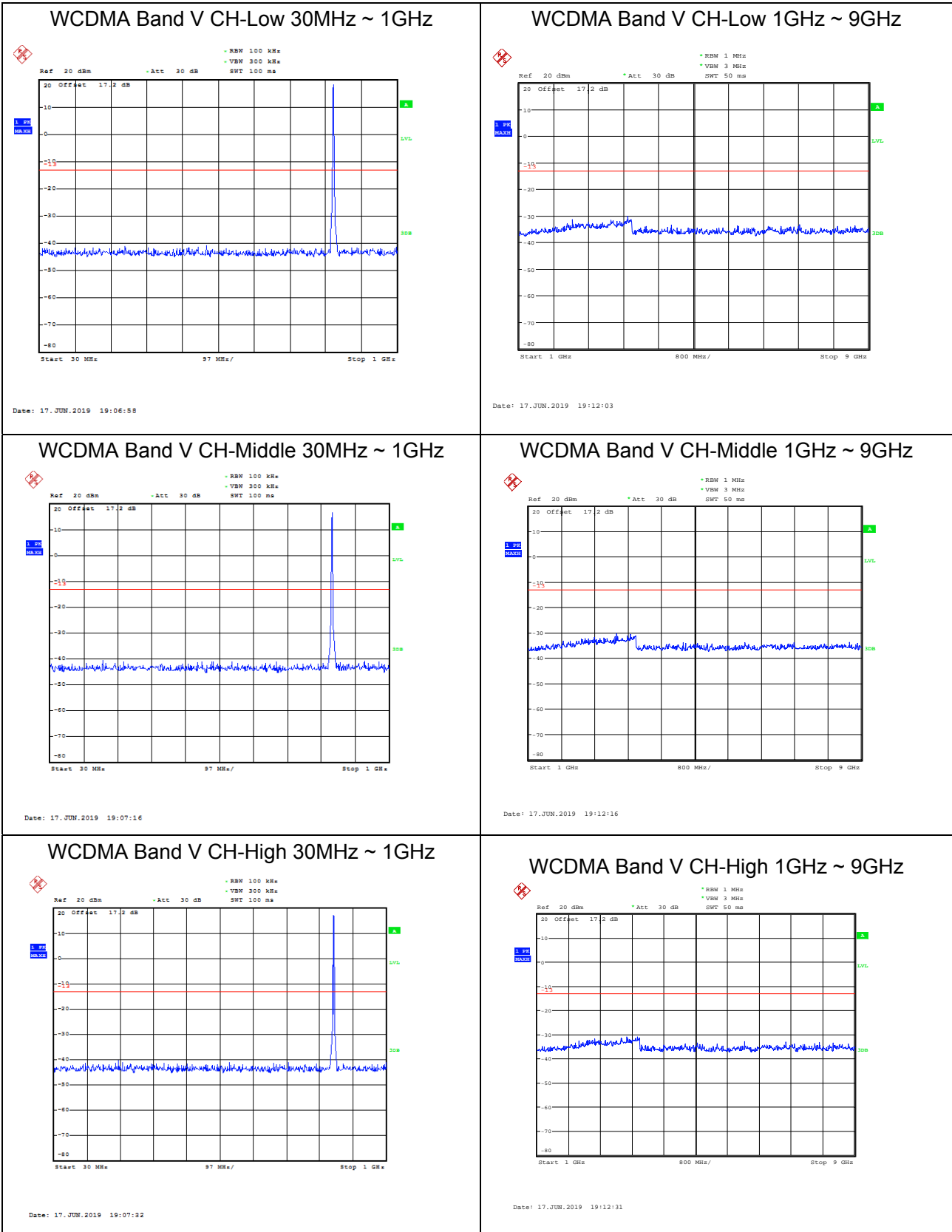



### LTE Band 5 1.4MHz CH-Low 30MHz~1GHz

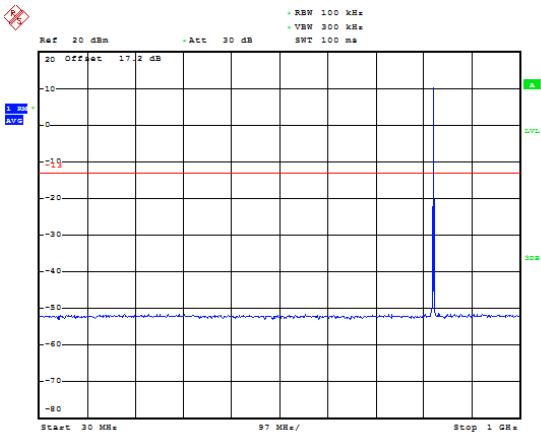

Date: 2.JUL.2019 12:54:47

### LTE Band 5 1.4MHz CH-Low 1GHz~9GHz

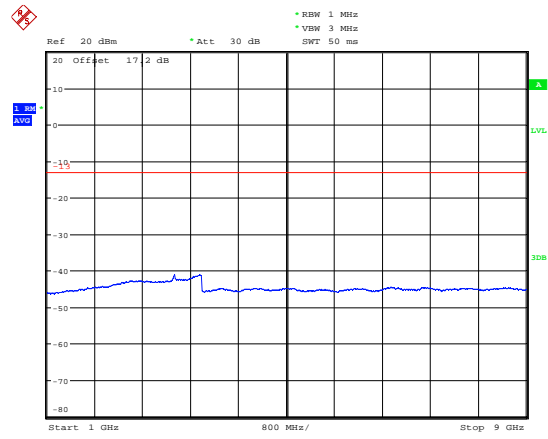

Date: 3.JUL.2019 15:24:38

### LTE Band 5 1.4MHz CH-Middle 30MHz~1GHz

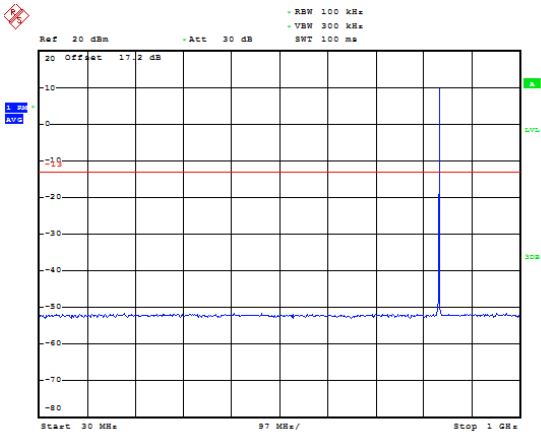

Date: 2.JUL.2019 12:55:18

### LTE Band 5 1.4MHz CH-Middle 1GHz~9GHz

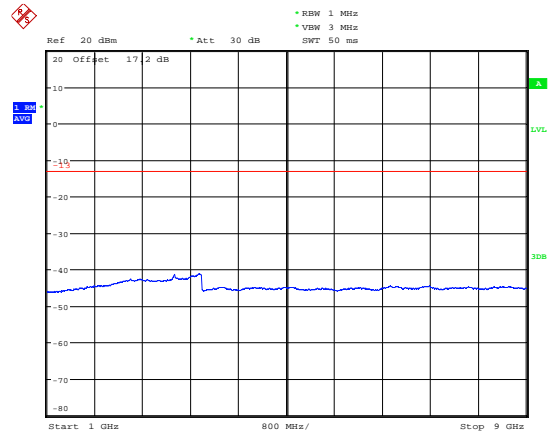

Date: 3.JUL.2019 15:25:07

### LTE Band 5 1.4MHz CH-High 30MHz~1GHz

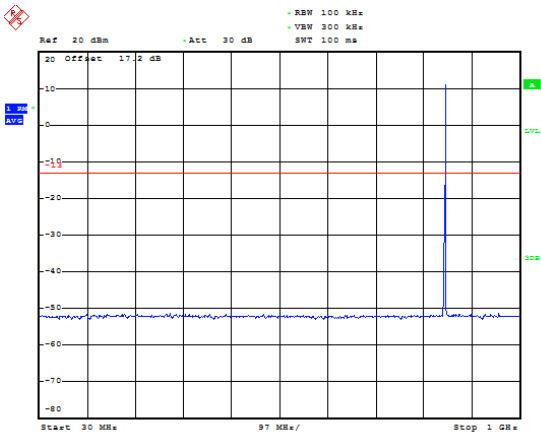

Date: 2.JUL.2019 12:55:58

### LTE Band 5 1.4MHz CH-High 1GHz~9GHz

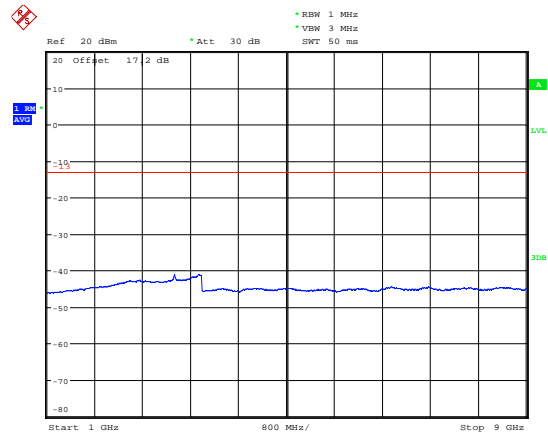

Date: 3.JUL.2019 15:25:39





LTE Band 5 3MHz CH-Low 30MHz~1GHz

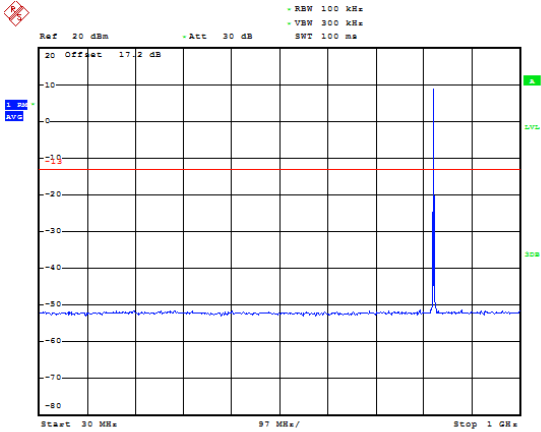

Date: 3.JUL.2019 15:13:25

LTE Band 5 3MHz CH-Low 1GHz~9GHz

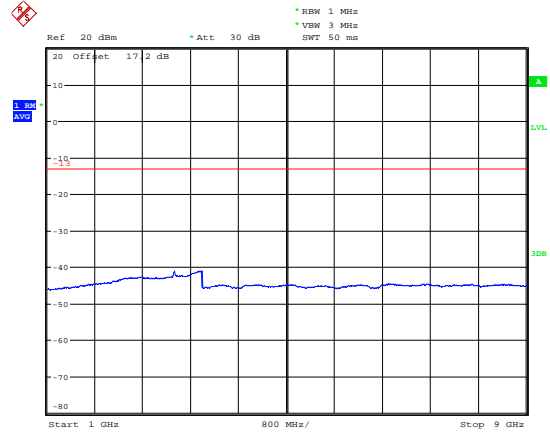

Date: 3.JUL.2019 15:50:51

LTE Band 5 3MHz CH-Middle 30MHz~1GHz

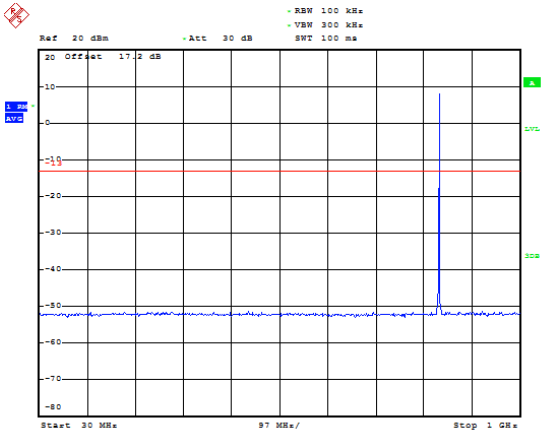

Date: 3.JUL.2019 15:13:42

LTE Band 5 3MHz CH-Middle 1GHz~9GHz

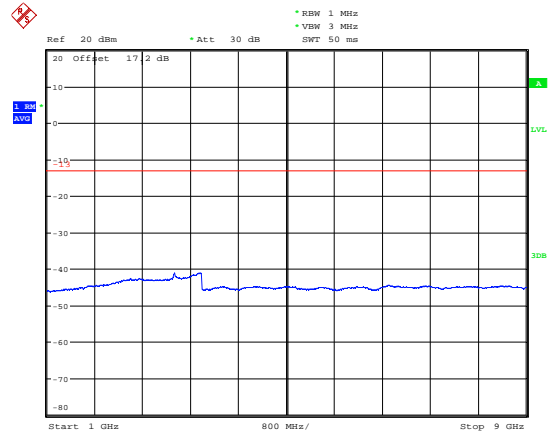

Date: 3.JUL.2019 15:51:09

LTE Band 5 3MHz CH-High 30MHz~1GHz

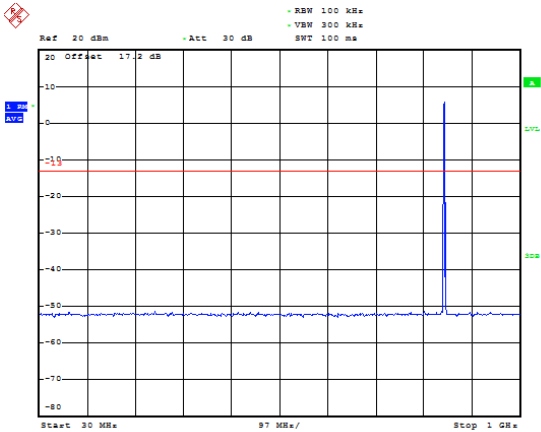

Date: 3.JUL.2019 15:14:06

LTE Band 5 3MHz CH-High 1GHz~9GHz

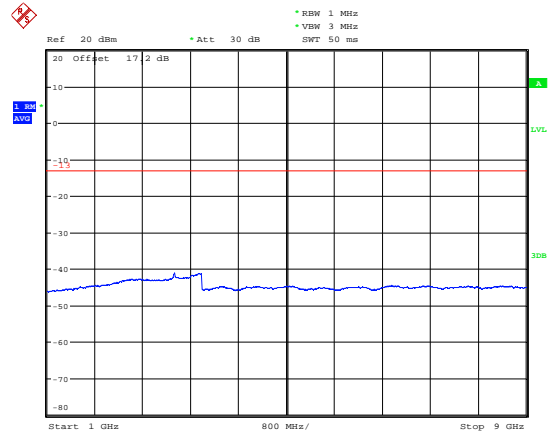

Date: 3.JUL.2019 15:51:34



LTE Band 5 5MHz CH-Low 30MHz~1GHz

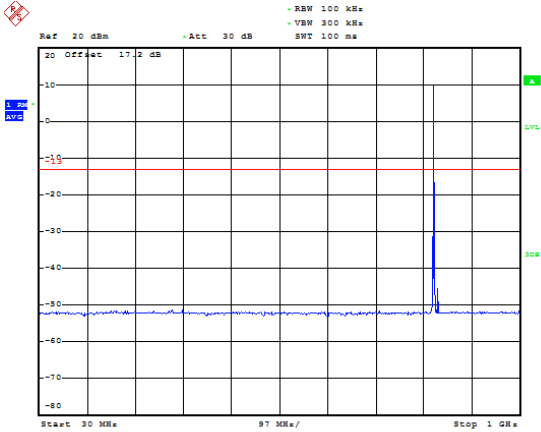

Date: 3.JUL.2019 15:18:04

LTE Band 5 5MHz CH-Low 1GHz~9GHz

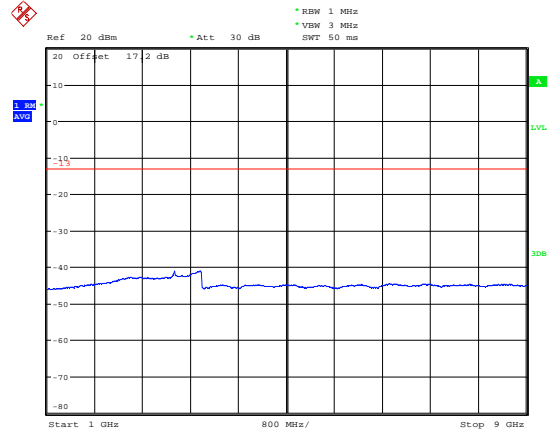

Date: 3.JUL.2019 15:52:06

LTE Band 5 5MHz CH-Middle 30MHz~1GHz

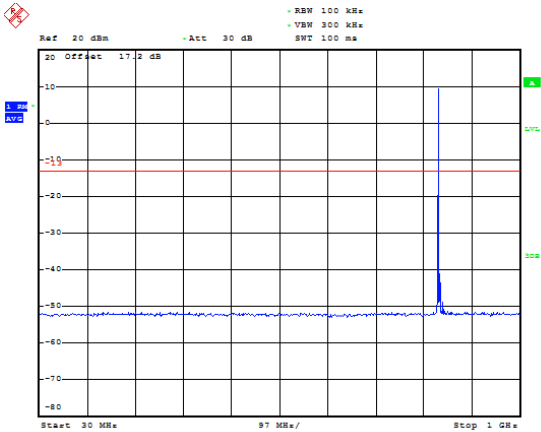

Date: 3.JUL.2019 15:19:25

LTE Band 5 5MHz CH-Middle 1GHz~9GHz

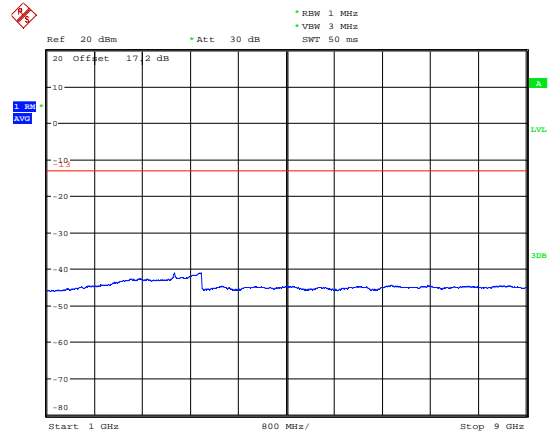

Date: 3.JUL.2019 15:52:39

LTE Band 5 5MHz CH-High 30MHz~1GHz

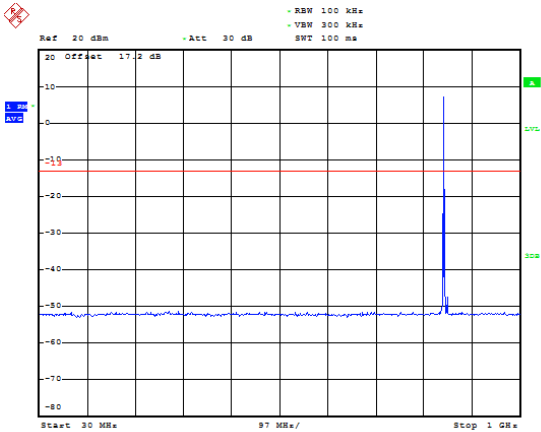

Date: 3.JUL.2019 15:15:59

LTE Band 5 5MHz CH-High 1GHz~9GHz

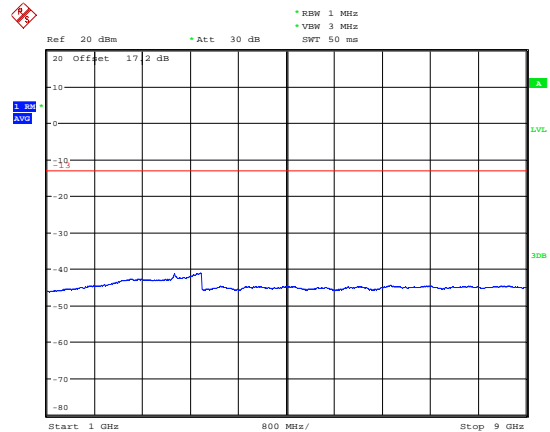

Date: 3.JUL.2019 15:52:56



### LTE Band 5 10MHz CH-Low 30MHz~1GHz

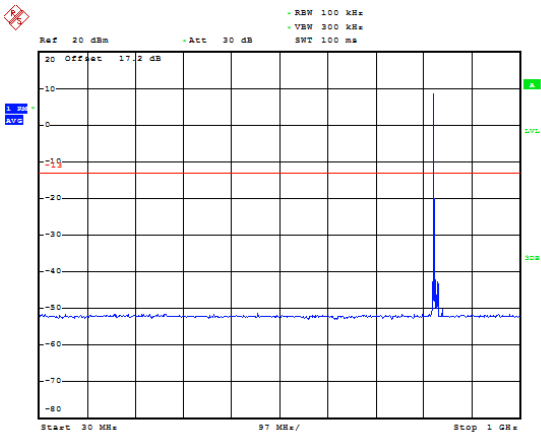

Date: 2.JUL.2019 15:19:19

### LTE Band 5 10MHz CH-Low 1GHz~9GHz

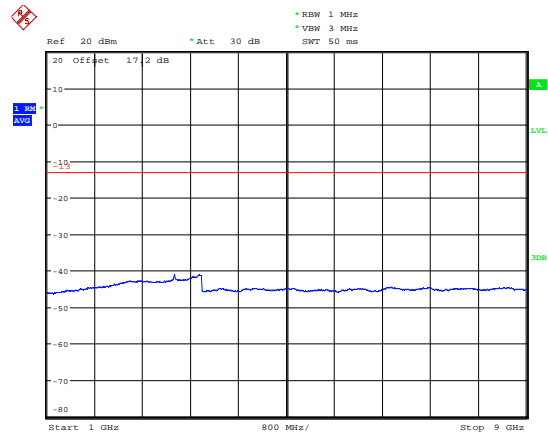

Date: 3.JUL.2019 15:21:53

### LTE Band 5 10MHz CH-Middle 30MHz~1GHz

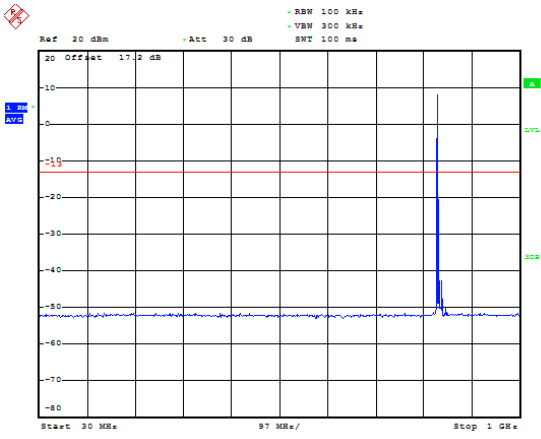

Date: 2.JUL.2019 15:19:38

### LTE Band 5 10MHz CH-Middle 1GHz~9GHz

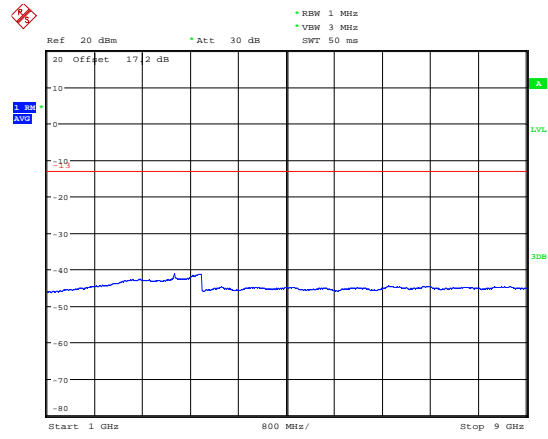

Date: 3.JUL.2019 15:21:15

### LTE Band 5 10MHz CH-High 30MHz~1GHz

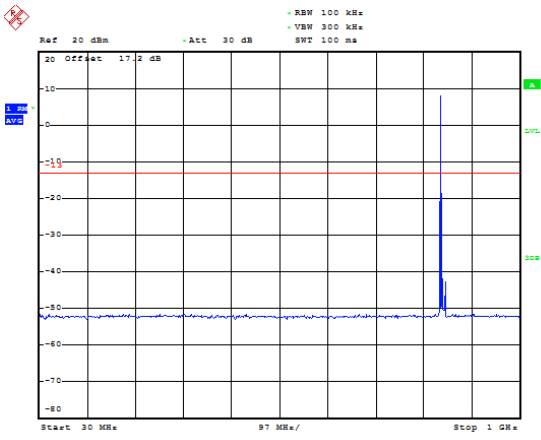

Date: 2.JUL.2019 15:20:08

### LTE Band 5 10MHz CH-High 1GHz~9GHz

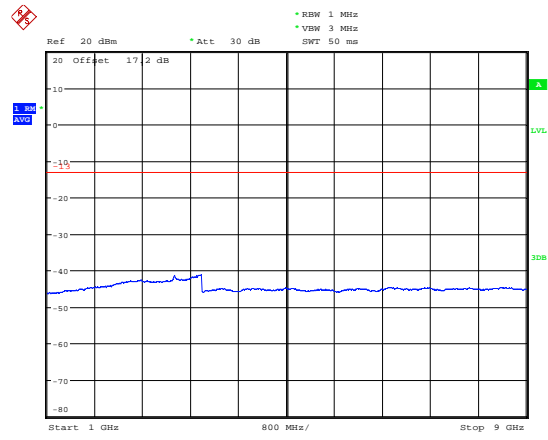

Date: 3.JUL.2019 15:20:56

## 5.8. Radiates Spurious Emission

### Ambient condition

Temperature	Relative humidity	Pressure
23°C ~25°C	45%~50%	101.5kPa

### Method of Measurement

1. The testing follows FCC KDB 971168 v03r01 Section 5.8 and ANSI C63.26 (2015).
2. Below 1GHz: The EUT is placed on a turntable 0.8 meters above the ground in the chamber, 3 meter away from the antenna. The maximal emission value is acquired by adjusting the antenna height, polarisation and turntable azimuth. Normally, the height range of antenna is 1 m to 4 m, the azimuth range of turntable is 0° to 360°, and the receive antenna has two polarizations Vertical (V) and Horizontal (H). Above 1GHz: (Note: the FCC's permission to use 1.5m as an alternative per TCBC Conf call of Dec. 2, 2014.) The EUT is placed on a turntable 1.5 meters above the ground in the chamber, 3 meter away from the antenna. The maximal emission value is acquired by adjusting the antenna height, polarisation and turntable azimuth. Normally, the height range of antenna is 1 m to 4 m, the azimuth range of turntable is 0° to 360°, and the receive antenna has two polarizations Vertical (V) and Horizontal (H).
3. A loop antenna, A log-periodic antenna or horn antenna shall be substituted in place of the EUT. The log-periodic antenna will be driven by a signal generator and the level will be adjusted till the same power value on the spectrum analyzer or receiver. The level of the spurious emissions can be calculated through the level of the signal generator, cable loss, the gain of the substitution antenna and the reading of the spectrum analyzer or receiver.
4. The EUT is then put into continuously transmitting mode at its maximum power level during the test. Set Test Receiver or Spectrum RBW=200Hz,VBW=600Hz for 9kHz150kHz , RBW=10kHz, VBW=30kHz 150kHz-30MHz , RBW=100kHz,VBW=300kHz for 30MHz to 1GHz and RBW=1MHz, VBW=3MHz for above 1GHz, And the maximum value of the receiver should be recorded as (Pr).
5. The EUT shall be replaced by a substitution antenna. In the chamber, an substitution antenna for the frequency band of interest is placed at the reference point of the chamber. An RF Signal source for the frequency band of interest is connected to the substitution antenna with a cable that has been constructed to not interfere with the radiation pattern of the antenna. A power (PMea) is applied to the input of the substitution antenna, and adjust the level of the signal generator output until the value of the receiver reach the previously recorded (Pr). The power of signal source (PMea) is recorded. The test should be performed by rotating the test item and adjusting the receiving antenna polarization.
6. A amplifier should be connected to the Signal Source output port. And the cable should be connect between the Amplifier and the Substitution Antenna. The cable loss (Pcl) ,the Substitution Antenna Gain (Ga) and the Amplifier Gain (PAg) should be recorded after test.
7. The measurement results are obtained as described below:  
Power(EIRP)=PMea- PAg - Pcl + Ga  
The measurement results are amend as described below:  
Power(EIRP)=PMea- Pcl + Ga
8. This value is EIRP since the measurement is calibrated using an antenna of known gain (2.15 dBi)

and known input power. ERP can be calculated from EIRP by subtracting the gain of the dipole,  $ERP = EIRP - 2.15\text{dBi}$ .

The modulation mode and RB allocation refer to section 5.1, using the maximum output power configuration.

**Test setup**

**9KHz ~ 30MHz**

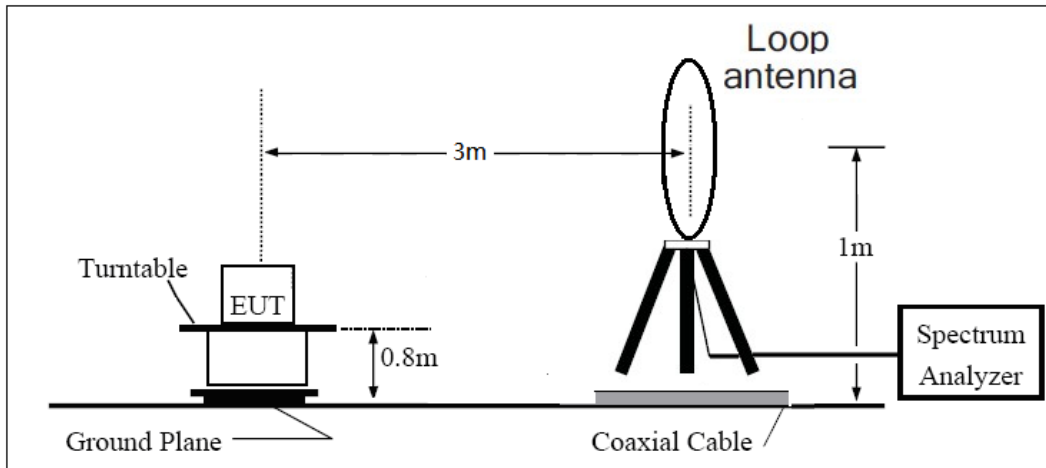

**30MHz ~ 1GHz**

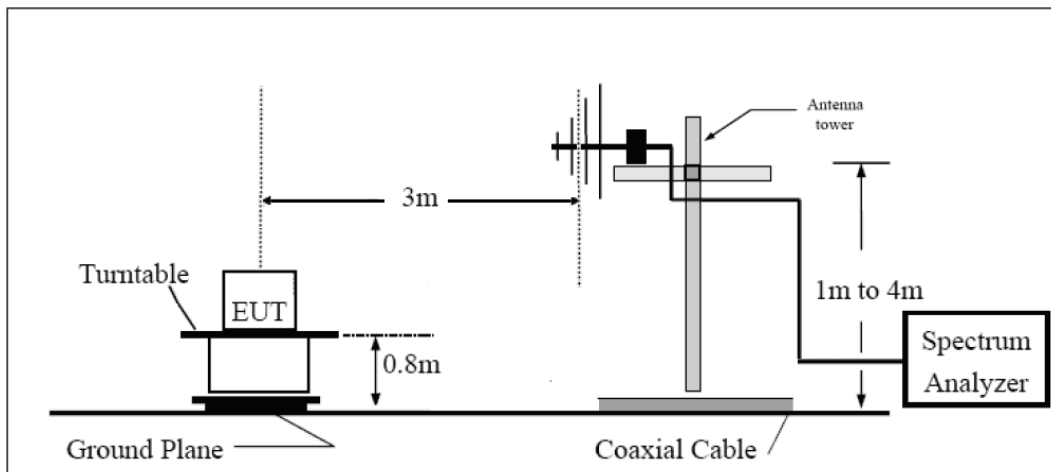

**Above 1GHz**

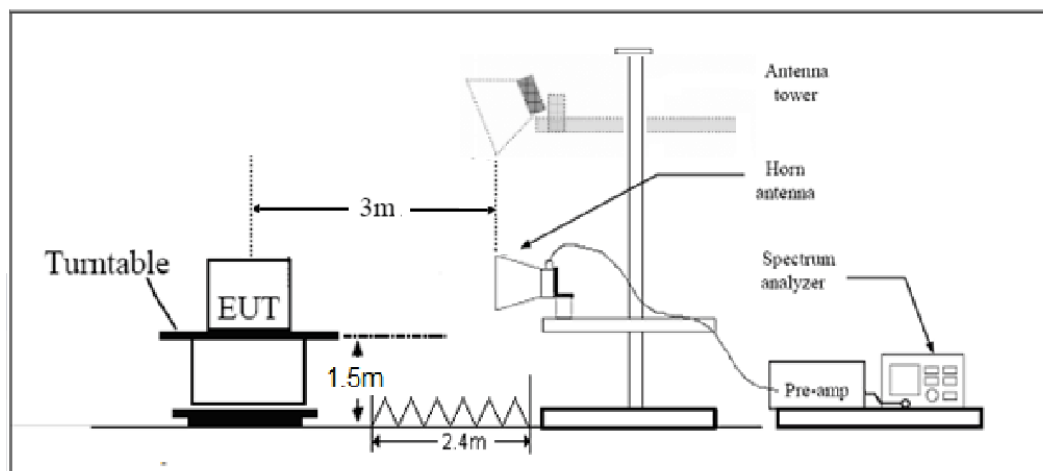



Note: Area side:2.4mX3.6m

**Limits**

Rule Part 22.917(a) specifies that “The power of any emission outside of the authorized operating frequency ranges must be attenuated below the transmitting power (P) by a factor of at least  $43 + 10 \log (P)$  dB.”

Limit	-13 dBm
-------	---------

**Measurement Uncertainty**

The assessed measurement uncertainty to ensure 95% confidence level for the normal distribution is with the coverage factor  $k = 1.96$ ,  $U = 3.55$  dB.

**Test Result**

Sweep the whole frequency band through the range from 9kHz to the 10th harmonic of the carrier, the emissions below the noise floor will not be recorded in the report.

WCDMA Band V CH-Low

Harmonic	Frequency (MHz)	SG (dBm)	Cable Loss (dB)	Gain (dBi)	Antenna Polarization	ERP Level (dBm)	Limit (dBm)	Margin (dB)	Azimuth (deg)
2	1652.8	-69.09	2.00	10.15	Horizontal	-63.09	-13.00	50.09	45
3	2479.2	-64.89	2.51	11.35	Horizontal	-58.20	-13.00	45.20	315
4	3305.6	-64.18	4.20	10.85	Horizontal	-59.68	-13.00	46.68	45
5	4132.0	-62.12	5.20	11.35	Horizontal	-58.12	-13.00	45.12	135
6	4958.4	-59.66	5.50	11.95	Horizontal	-55.36	-13.00	42.36	270
7	5784.8	-58.39	5.70	13.55	Horizontal	-52.69	-13.00	39.69	45
8	6611.2	-59.62	6.30	13.75	Horizontal	-54.32	-13.00	41.32	135
9	7437.6	-55.22	6.80	13.85	Horizontal	-50.32	-13.00	37.32	0
10	8264.0	-55.56	6.90	14.25	Horizontal	-50.36	-13.00	37.36	45

Note: 1.The other Spurious RF Radiated emissions level is no more than noise floor.  
 2.The worst emission was found in the antenna is Horizontal position.

WCDMA Band V CH-Middle

Harmonic	Frequency (MHz)	SG (dBm)	Cable Loss (dB)	Gain (dBi)	Antenna Polarization	ERP Level (dBm)	Limit (dBm)	Margin (dB)	Azimuth (deg)
2	1673.2	-68.73	2.00	10.75	Horizontal	-62.13	-13.00	49.13	315
3	2509.8	-66.26	2.51	11.05	Horizontal	-59.87	-13.00	46.87	135
4	3346.4	-65.49	4.20	11.15	Horizontal	-60.69	-13.00	47.69	135
5	4183.0	-61.62	5.20	11.15	Horizontal	-57.82	-13.00	44.82	270
6	5019.6	-59.46	5.50	11.95	Horizontal	-55.16	-13.00	42.16	45
7	5856.2	-59.21	5.70	13.55	Horizontal	-53.51	-13.00	40.51	135
8	6692.8	-59.08	6.30	13.75	Horizontal	-53.78	-13.00	40.78	270
9	7529.4	-55.56	6.80	13.85	Horizontal	-50.66	-13.00	37.66	315
10	8366.0	-55.66	6.90	14.25	Horizontal	-50.46	-13.00	37.46	135

Note: 1.The other Spurious RF Radiated emissions level is no more than noise floor.  
 2.The worst emission was found in the antenna is Horizontal position.

WCDMA Band V CH-High

Harmonic	Frequency (MHz)	SG (dBm)	Cable Loss (dB)	Gain (dBi)	Antenna Polarization	ERP Level (dBm)	Limit (dBm)	Margin (dB)	Azimuth (deg)
2	1693.2	-68.00	2.00	10.15	Horizontal	-62.00	-13.00	49.00	270
3	2539.8	-64.93	2.51	11.05	Horizontal	-58.54	-13.00	45.54	0
4	3386.4	-64.69	4.20	11.15	Horizontal	-59.89	-13.00	46.89	270
5	4233.0	-58.98	5.20	11.15	Horizontal	-55.18	-13.00	42.18	45
6	5079.6	-58.87	5.50	11.95	Horizontal	-54.57	-13.00	41.57	270
7	5926.2	-60.00	5.70	13.55	Horizontal	-54.30	-13.00	41.30	45
8	6772.8	-55.94	6.30	13.75	Horizontal	-50.64	-13.00	37.64	135
9	7619.4	-54.59	6.80	13.85	Horizontal	-49.69	-13.00	36.69	270
10	8466.0	-55.45	6.90	14.25	Horizontal	-50.25	-13.00	37.25	315

Note: 1.The other Spurious RF Radiated emissions level is no more than noise floor.  
 2.The worst emission was found in the antenna is Horizontal position.

LTE Band 5 10MHz CH-Low

Harmonic	Frequency (MHz)	SG (dBm)	Cable Loss (dB)	Gain (dBi)	Antenna Polarization	ERP Level (dBm)	Limit (dBm)	Margin (dB)	Azimuth (deg)
2	1658.0	-60.84	2.00	10.75	Horizontal	-54.24	-13.00	41.24	315
3	2487.0	-56.91	2.51	11.05	Horizontal	-50.52	-13.00	37.52	135
4	3316.0	-58.00	4.20	11.15	Horizontal	-53.20	-13.00	40.20	0
5	4145.0	-53.73	5.20	11.15	Horizontal	-49.93	-13.00	36.93	45
6	4974.0	-50.66	5.50	11.95	Horizontal	-46.36	-13.00	33.36	135
7	5803.0	-56.97	5.70	13.55	Horizontal	-51.27	-13.00	38.27	270
8	6632.0	-57.24	6.30	13.75	Horizontal	-51.94	-13.00	38.94	315
9	7461.0	-54.74	6.80	13.85	Horizontal	-49.84	-13.00	36.84	135
10	8290.0	-55.06	6.90	14.25	Horizontal	-49.86	-13.00	36.86	270

Note: 1.The other Spurious RF Radiated emissions level is no more than noise floor.  
 2.The worst emission was found in the antenna is Horizontal position.





## LTE Band 5 10MHz CH-Middle

Harmonic	Frequency (MHz)	SG (dBm)	Cable Loss (dB)	Gain (dBi)	Antenna Polarization	ERP Level (dBm)	Limit (dBm)	Margin (dB)	Azimuth (deg)
2	1673.0	-62.88	2.00	10.75	Horizontal	-56.28	-13.00	43.28	270
3	2509.5	-58.01	2.51	11.05	Horizontal	-51.62	-13.00	38.62	0
4	3346.0	-60.81	4.20	11.15	Horizontal	-56.01	-13.00	43.01	0
5	4182.5	-55.95	5.20	11.15	Horizontal	-52.15	-13.00	39.15	90
6	5019.0	-53.44	5.50	11.95	Horizontal	-49.14	-13.00	36.14	45
7	5855.5	-60.21	5.70	13.55	Horizontal	-54.51	-13.00	41.51	225
8	6692.0	-58.20	6.30	13.75	Horizontal	-52.90	-13.00	39.90	315
9	7528.5	-55.14	6.80	13.85	Horizontal	-50.24	-13.00	37.24	135
10	8365.0	-55.81	6.90	14.25	Horizontal	-50.61	-13.00	37.61	270

Note: 1.The other Spurious RF Radiated emissions level is no more than noise floor.

2.The worst emission was found in the antenna is Horizontal position.

## LTE Band 5 10MHz CH-High

Harmonic	Frequency (MHz)	SG (dBm)	Cable Loss (dB)	Gain (dBi)	Antenna Polarization	ERP Level (dBm)	Limit (dBm)	Margin (dB)	Azimuth (deg)
2	1688.0	-60.29	2.00	10.75	Horizontal	-53.69	-13.00	40.69	45
3	2532.0	-59.55	2.51	11.05	Horizontal	-53.16	-13.00	40.16	270
4	3376.0	-56.40	4.20	11.15	Horizontal	-51.60	-13.00	38.60	90
5	4220.0	-50.82	5.20	11.15	Horizontal	-47.02	-13.00	34.02	45
6	5064.0	-49.74	5.50	11.95	Horizontal	-45.44	-13.00	32.44	315
7	5908.0	-60.26	5.70	13.55	Horizontal	-54.56	-13.00	41.56	135
8	6752.0	-57.65	6.30	13.75	Horizontal	-52.35	-13.00	39.35	90
9	7596.0	-55.43	6.80	13.85	Horizontal	-50.53	-13.00	37.53	315
10	8440.0	-55.93	6.90	14.25	Horizontal	-50.73	-13.00	37.73	135

Note: 1.The other Spurious RF Radiated emissions level is no more than noise floor.

2.The worst emission was found in the antenna is Horizontal position.

## 6. Main Test Instruments

Name	Manufacturer	Type	Serial Number	Calibration Date	Expiration Date
Base Station Simulator	R&S	CMW500	113824	2019-05-19	2020-05-18
Power Splitter	Hua Xiang	SHX-GF2-2-13	10120101	/	/
Spectrum Analyzer	Key sight	N9010A	MY50210259	2019-05-19	2020-05-18
Universal Radio Communication Tester	Key sight	E5515C	MY48367192	2019-05-19	2020-05-18
Signal Analyzer	R&S	FSV30	100815	2018-12-16	2019-12-15
Loop Antenna	SCHWARZBECK	FMZB1519	1519-047	2017-09-26	2019-09-25
Trilog Antenna	SCHWARZBECK	VUBL 9163	9163-201	2017-11-18	2019-11-17
Horn Antenna	R&S	HF907	100126	2018-07-07	2020-07-06
Horn Antenna	ETS-Lindgren	3160-09	00102643	2018-06-20	2020-06-19
Signal generator	R&S	SMB 100A	102594	2019-05-19	2020-05-18
Climatic Chamber	ESPEC	SU-242	93000506	2017-12-17	2020-12-16
Preamplifier	R&S	SCU18	102327	2019-05-19	2020-05-18
MOB COMMS DC SUPPLY	Keysight	66319D	MY43004105	2019-05-20	2020-05-21
RF Cable	Agilent	SMA 15cm	0001	2019-06-14	2019-09-13
Software	R&S	EMC32	9.26.0	/	/

\*\*\*\*\*END OF REPORT \*\*\*\*\*

## ANNEX A: EUT Appearance and Test Setup

### A.1 EUT Appearance

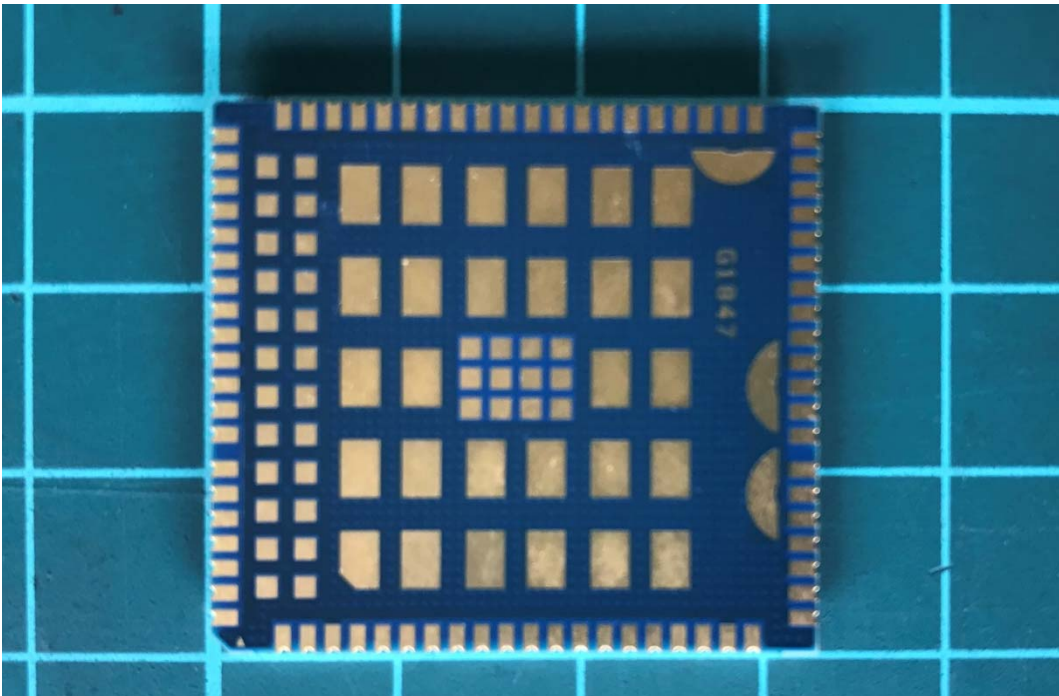

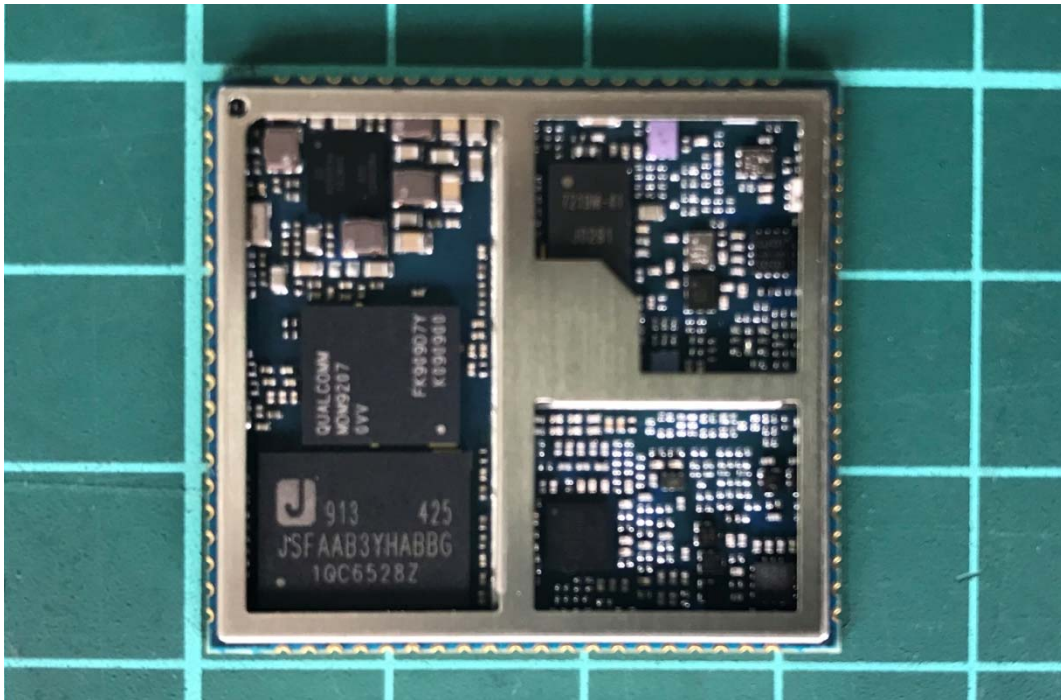

a: EUT

Picture 1 EUT and Accessory

## A.2 Test Setup



30MHz ~ 1GHz



Above 1GHz

Picture 2 Radiated Spurious Emissions Test setup