



# RF TEST REPORT

**Applicant**      Quectel Wireless Solutions Co., Ltd.  
**FCC ID**            XMR201902M66  
**Product**          GSM/GPRS Module  
**Brand**             Quectel  
**Model**             M66  
**Marketing**        Quectel M66  
**Report No.**       R1901A0009-R1  
**Issue Date**      February 15, 2019

TA Technology (Shanghai) Co., Ltd. tested the above equipment in accordance with the requirements in **FCC CFR47 Part 2 (2018)/ FCC CFR 47 Part 22H (2018)**. The test results show that the equipment tested is capable of demonstrating compliance with the requirements as documented in this report.

*Performed by: Peng Tao*

*Approved by: Kai Xu*

---

## TA Technology (Shanghai) Co., Ltd.

*No.145, Jintang Rd, Tangzhen Industry Park, Pudong Shanghai, China*

*TEL: +86-021-50791141/2/3*

*FAX: +86-021-50791141/2/3-8000*



## TABLE OF CONTENT

1. Test Laboratory .....	4
1.1. Notes of the Test Report .....	4
1.2. Test facility .....	4
1.3. Testing Location .....	5
2. General Description of Equipment under Test.....	6
3. Applied Standards .....	7
4. Test Configuration .....	8
5. Test Case Results .....	9
5.1. RF Power Output .....	9
5.2. Effective Radiated Power .....	11
5.3. Occupied Bandwidth .....	14
5.4. Band Edge Compliance .....	17
5.5. Peak-to-Average Power Ratio (PAPR).....	19
5.6. Frequency Stability.....	21
5.7. Spurious Emissions at Antenna Terminals.....	25
5.8. Radiates Spurious Emission .....	28
6. Main Test Instruments.....	33
ANNEX A: EUT Appearance and Test Setup .....	34
A.1 EUT Appearance.....	34
A.2 Test Setup.....	36

### Summary of measurement results

No.	Test Type	Clause in FCC rules	Verdict
1	RF power output	2.1046	PASS
2	Effective Radiated Power	22.913(a)(5)	PASS
3	Occupied Bandwidth	2.1049	PASS
4	Band Edge Compliance	2.1051 / 22.917(a)	PASS
5	Peak-to-Average Power Ratio	22.913(d)/ KDB 971168 D01(5.7)	PASS
6	Frequency Stability	2.1055 / 22.355	PASS
7	Spurious Emissions at Antenna Terminals	2.1051 / 22.917(a)	PASS
8	Radiates Spurious Emission	2.1053 / 22.917 (a)	PASS
Date of Testing: January 9, 2019~ February 2, 2019			
Note: PASS: The EUT complies with the essential requirements in the standard. FAIL: The EUT does not comply with the essential requirements in the standard.			



## 1. Test Laboratory

### 1.1. Notes of the Test Report

This report shall not be reproduced in full or partial, without the written approval of **TA technology (shanghai) co., Ltd.** The results documented in this report apply only to the tested sample, under the conditions and modes of operation as described herein .Measurement Uncertainties were not taken into account and are published for informational purposes only. This report is written to support regulatory compliance of the applicable standards stated above.

### 1.2. Test facility

#### **CNAS (accreditation number: L2264)**

TA Technology (Shanghai) Co., Ltd. has obtained the accreditation of China National Accreditation Service for Conformity Assessment (CNAS).

#### **FCC (Designation number: CN1179, Test Firm Registration Number: 446626)**

TA Technology (Shanghai) Co., Ltd. has been listed on the US Federal Communications Commission list of test facilities recognized to perform electromagnetic emissions measurements.

#### **IC (recognition number is 8510A)**

TA Technology (Shanghai) Co., Ltd. has been listed by industry Canada to perform electromagnetic emission measurement.

#### **VCCI (recognition number is C-4595, T-2154, R-4113, G-10766)**

TA Technology (Shanghai) Co., Ltd. has been listed by industry Japan to perform electromagnetic emission measurement.

#### **A2LA (Certificate Number: 3857.01)**

TA Technology (Shanghai) Co., Ltd. has been listed by American Association for Laboratory Accreditation to perform electromagnetic emission measurement.



### 1.3. Testing Location

Company: TA Technology (Shanghai) Co., Ltd.  
Address: No.145, Jintang Rd, Tangzhen Industry Park, Pudong  
City: Shanghai  
Post code: 201201  
Country: P. R. China  
Contact: Xu Kai  
Telephone: +86-021-50791141/2/3  
Fax: +86-021-50791141/2/3-8000  
Website: <http://www.ta-shanghai.com>  
E-mail: [xukai@ta-shanghai.com](mailto:xukai@ta-shanghai.com)

## 2. General Description of Equipment under Test

### Client Information

Applicant	Quectel Wireless Solutions Co., Ltd.
Applicant address	7th Floor, Hongye Building, No.1801 Hongmei Road, Xuhui District, Shanghai 200233, China
Manufacturer	Quectel Wireless Solutions Co., Ltd.
Manufacturer address	7th Floor, Hongye Building, No.1801 Hongmei Road, Xuhui District, Shanghai 200233, China

### General Information

EUT Description			
Model	M66		
IMEI	867322039990304		
Hardware Version	R1.0		
Software Version	M66FAR01A12BT		
Power Supply	External Power Supply		
Antenna Type	External Antenna (The EUT don't have standard Antenna. The Antenna used for testing in this report is the after-market accessory.)		
Antenna Gain	4dBi		
Test Mode(s)	GSM 850		
Test Modulation	(GSM)GMSK		
GPRS Multislot Class	12		
Maximum E.R.P.	GSM 850:	29.65dBm	
Rated Power Supply Voltage	4.0V		
Extreme Voltage	Minimum: 3.3V    Maximum: 4.6V		
Extreme Temperature	Lowest: -40°C    Highest: +85°C		
Operating Frequency Range(s)	Band	Tx (MHz)	Rx (MHz)
	GSM850	824 ~ 849	869 ~ 894
Note: The information of the EUT is declared by the manufacturer.			



### **3. Applied Standards**

According to the specifications of the manufacturer, it must comply with the requirements of the following standards:

**FCC CFR47 Part 2 (2018)**

**FCC CFR 47 Part 22H (2018)**

**ANSI C63.26 (2015)**

**KDB 971168 D01 Power Meas License Digital Systems v03r01**

## 4. Test Configuration

Radiated measurements are performed by rotating the EUT in three different orthogonal test planes. EUT stand-up position (Z axis), lie-down position (X, Y axis). Receiver antenna polarization (horizontal and vertical), the worst emission was found in position (X axis, vertical polarization) and the worst case was recorded.

The following testing in GSM is set based on the maximum RF Output Power.

Test modes are chosen to be reported as the worst case configuration below:

Test items	Modes/Modulation
	GSM 850
RF power output	GSM GPRS
Effective Radiated Power	GSM GPRS(1Tx slot)
Occupied Bandwidth	GSM GPRS(1Tx slot)
Band Edge Compliance	GSM GPRS(1Tx slot)
Peak-to-Average Power Ratio	GSM GPRS(1Tx slot)
Frequency Stability	GSM GPRS(1Tx slot)
Spurious Emissions at Antenna Terminals	GSM
Radiates Spurious Emission	GSM



## 5. Test Case Results

### 5.1. RF Power Output

#### Ambient condition

Temperature	Relative humidity	Pressure
23°C ~25°C	45%~50%	101.5kPa

#### Methods of Measurement

During the process of the testing, The EUT is controlled by the Base Station Simulator to ensure max power transmission and proper modulation.

#### Test Setup

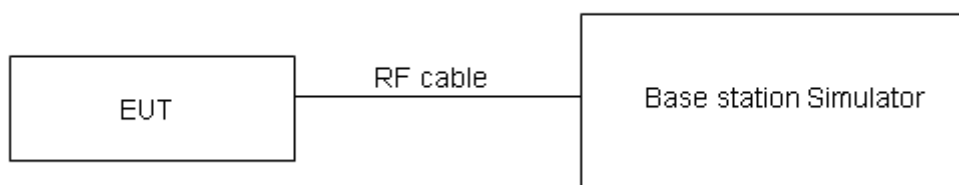

The loss between RF output port of the EUT and the input port of the tester has been taken into consideration.

#### Limits

No specific RF power output requirements in part 2.1046.

#### Measurement Uncertainty

The assessed measurement uncertainty to ensure 95% confidence level for the normal distribution is with the coverage factor  $k = 2$ ,  $U = 0.4$  dB.

**Test Results**

<b>GSM 850</b>			<b>Conducted Power(dBm)</b>		
Operation Mode		Power level	Channel 128	Channel 190	Channel 251
			824.2 (MHz)	836.6 (MHz)	848.8 (MHz)
GSM	CS	5	32.58	32.44	32.29
GPRS (GMSK)	1TXslot	5	32.66	32.44	32.30
	2TXslots	5	32.51	32.28	32.19
	3TXslots	5	31.03	31.18	31.27
	4TXslots	5	30.08	30.16	30.27
	4TXslots	10	22.95	23.03	22.88
	4TXslots	19	5.21	5.25	5.33

## 5.2. Effective Radiated Power

### Ambient condition

Temperature	Relative humidity	Pressure
23°C ~25°C	45%~50%	101.5kPa

### Methods of Measurement

The testing follows FCC KDB 971168 v03r01 Section 5.8 and ANSI C63.26 (2015).

- a) Connect the equipment as illustrated. Mount the equipment with the manufacturer specified antenna in a vertical orientation on a manufacturer specified mounting surface located on a non-conducting rotating platform of a RF anechoic chamber (preferred) or a standard radiation site.
- b) Key the transmitter, then rotate the EUT 360° azimuthally and record spectrum analyzer power level (LVL) measurements at angular increments that are sufficiently small to permit resolution of all peaks. If a standard radiation test site is used, raise and lower the test antenna to obtain a maximum reading at each angular increment. (Note: several batteries may be needed to offset the effect of battery voltage droop, which should not exceed 5% of the manufactured specified battery voltage during transmission).
- c) Replace the transmitter under test with a vertically polarized half-wave dipole (or an antenna whose gain is known relative to an ideal half-wave dipole). The center of the antenna should be at the same location as the center of the antenna under test.
- d) Connect the antenna to a signal generator with a known output power and record the path loss (in dB) as LOSS. If a standard radiation test site is used, raise and lower the test antenna to obtain a maximum reading.  $LOSS = \text{Generator Output Power (dBm)} - \text{Analyzer reading (dBm)}$
- e) Determine the effective radiated output power at each angular position from the readings in steps b) and d) using the following equation:  $ERP \text{ (dBm)} = \text{LVL (dBm)} + \text{LOSS (dB)}$
- f) The maximum ERP is the maximum value determined in the preceding step.
- g) When calculating ERP, in addition to knowing the antenna radiation and matching characteristics, it is necessary to know the loss values of all elements (e.g. transmission line attenuation, mismatches, filters, combiners) interposed between the point where transmitter output power is measured, and the point where power is applied to the antenna. ERP can then be calculated as follows:  
 $EIRP \text{ (dBm)} = \text{Output Power (dBm)} - \text{Losses (dB)} + \text{Antenna Gain (dBi)}$   
where: dBd refers to gain relative to an ideal dipole.  
 $EIRP \text{ (dBm)} = ERP \text{ (dBm)} + 2.15 \text{ (dB.)}$

The RB allocation refers to section 5.1, using the maximum output power configuration.

**Test setup**

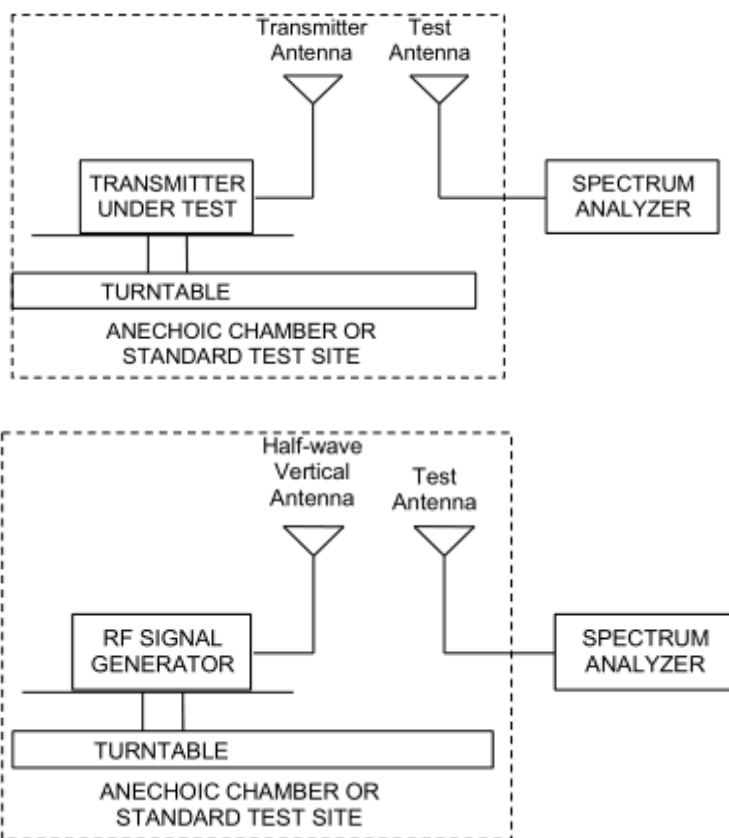

**Limits**

Rule Part 22.913(a)(5) specifies that "Mobile/portable stations are limited to 7 watts ERP".

Limit	$\leq 7 \text{ W}$ (38.45 dBm)
-------	--------------------------------

**Measurement Uncertainty**

The assessed measurement uncertainty to ensure 95% confidence level for the normal distribution is with the coverage factor  $k = 2$ ,  $U = 1.19 \text{ dB}$

**Test Results:**

The measurement is performed for both of horizontal and vertical antenna Polarization, and only the data of worst mode is recorded in this report.

Mode	Channel	Frequency (MHz)	Polarization	ERP (dBm)	Limit (dBm)	Conclusion
<b>GSM 850</b>	Low	824.2	Horizontal	28.48	38.45	Pass
	Mid	836.6	Horizontal	28.89	38.45	Pass
	High	848.8	Horizontal	29.11	38.45	Pass
<b>GPRS 850</b>	Low	824.2	Horizontal	29.11	38.45	Pass
	Mid	836.6	Horizontal	29.35	38.45	Pass
	High	848.8	Horizontal	29.65	38.45	Pass

### 5.3. Occupied Bandwidth

#### Ambient condition

Temperature	Relative humidity	Pressure
23°C ~25°C	45%~50%	101.5kPa

#### Method of Measurement

The EUT was connected to Spectrum Analyzer and Base Station Simulator via power Splitter. The occupied bandwidth is measured using spectrum analyzer.

RBW is set to 3kHz, VBW is set to 10kHz for GSM 850,

99% power and -26dBc occupied bandwidths are recorded. Spectrum analyzer plots are included on the following pages.

#### Test Setup

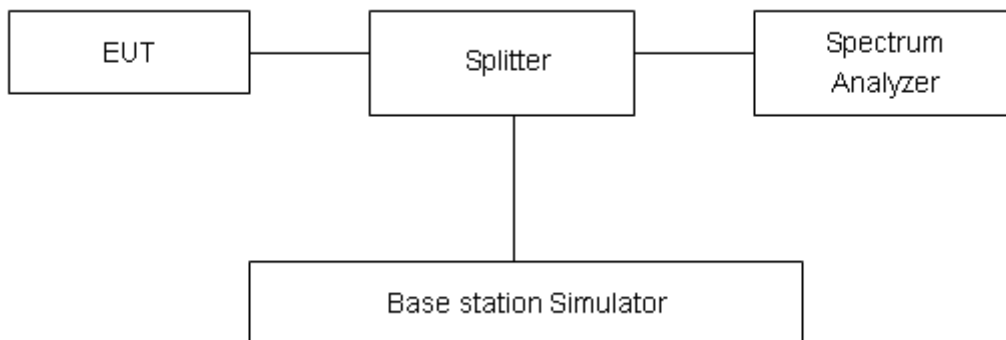

#### Limits

No specific occupied bandwidth requirements in part 2.1049.

#### Measurement Uncertainty

The assessed measurement uncertainty to ensure 95% confidence level for the normal distribution is with the coverage factor  $k = 2$ ,  $U = 624\text{Hz}$ .

**Test Result**

Mode	Channel	Frequency (MHz)	99% Power Bandwidth (MHz)	-26dBc Bandwidth(MHz)
<b>GSM 850 (GSM)</b>	128	824.2	0.247	0.312
	190	836.6	0.246	0.309
	251	848.8	0.249	0.305
<b>GPRS 850 (GMSK)</b>	128	824.2	0.244	0.313
	190	836.6	0.248	0.318
	251	848.8	0.246	0.314

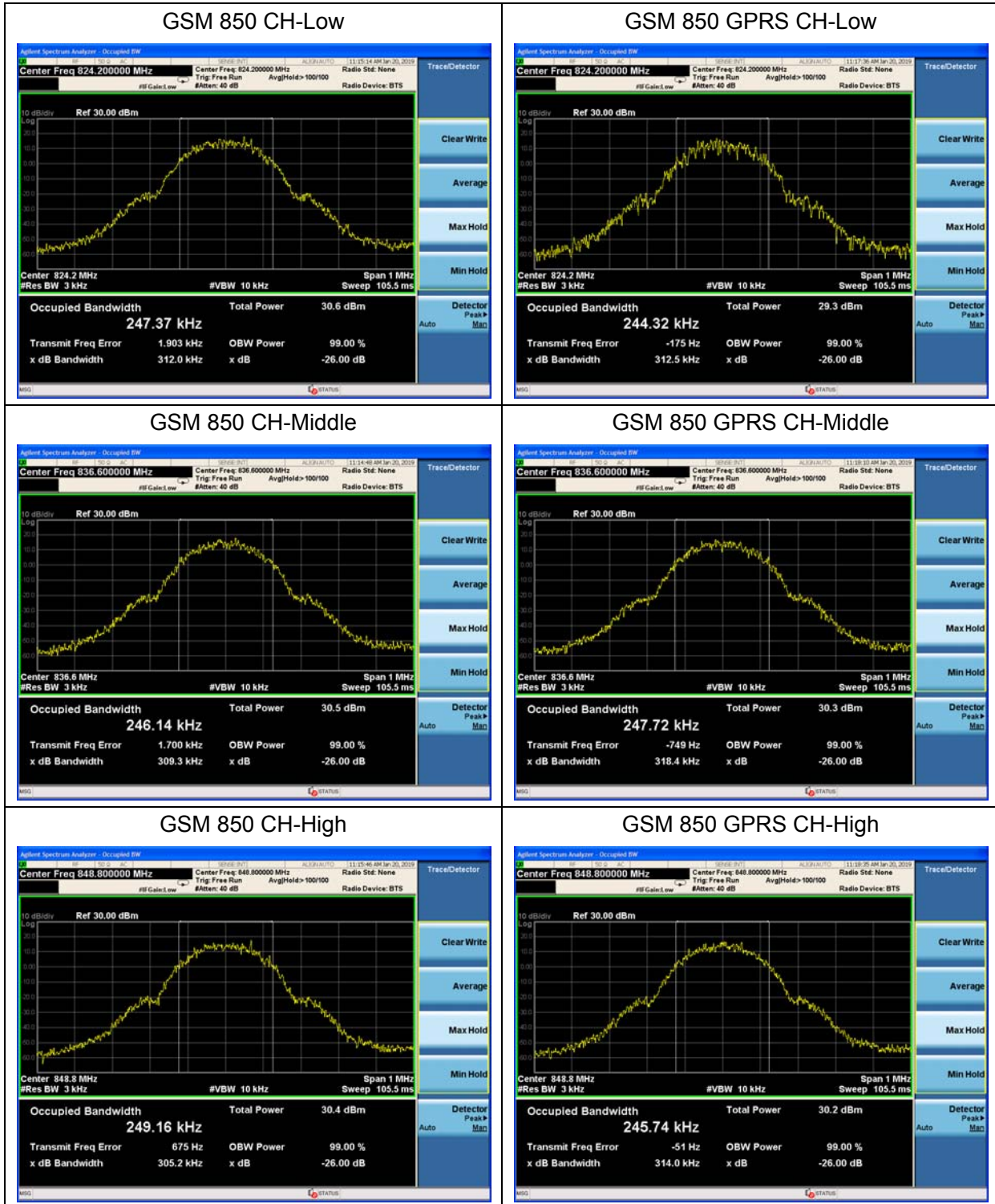



### 5.4. Band Edge Compliance

#### Ambient condition

Temperature	Relative humidity	Pressure
23°C ~25°C	45%~50%	101.5kPa

#### Method of Measurement

The EUT was connected to Spectrum Analyzer and Base Station Simulator via power Splitter. The band edge of the lowest and highest channels were measured. The average detector is used. RBW is set to 3kHz,VBW is set to 10kHz for GSM 850, Spectrum analyzer plots are included on the following pages.

#### Test Setup

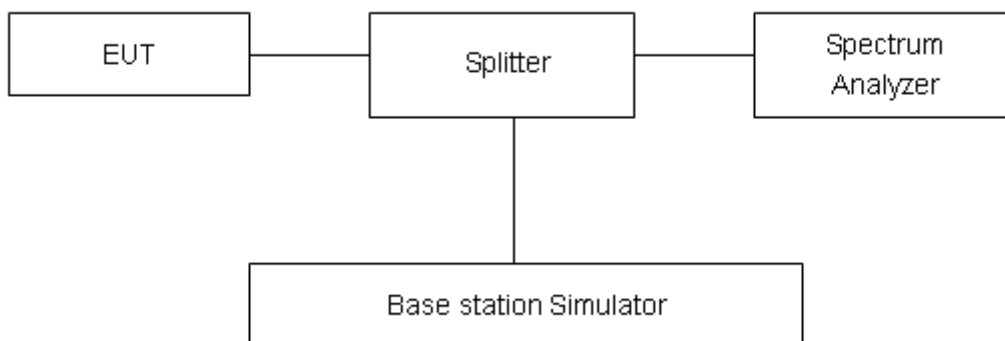

#### Limits

Rule Part 22.917(a) specifies that “The power of any emission outside of the authorized operating frequency ranges must be attenuated below the transmitting power (P) by a factor of at least 43 + 10 log(P) dB.”

Limit	-13 dBm
-------	---------

#### Measurement Uncertainty

The assessed measurement uncertainty to ensure 95% confidence level for the normal distribution is with the coverage factor  $k = 1.96$ ,  $U=0.684$ dB.



Test Result:

GSM 850 CH-Low



GSM 850 CH-High



GSM 850 GPRS CH-Low

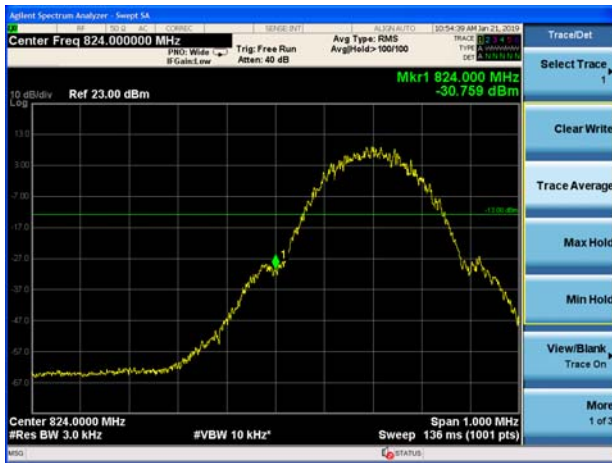

GSM 850 GPRS CH-High



### 5.5. Peak-to-Average Power Ratio (PAPR)

#### Ambient condition

Temperature	Relative humidity	Pressure
23°C ~25°C	45%~50%	101.5kPa

#### Methods of Measurement

Measure the total peak power and record as  $P_{Pk}$ . And measure the total average power and record as  $P_{Avg}$ . Both the peak and average power levels must be expressed in the same logarithmic units (e.g., dBm). Determine the PAPR from:

$$PAPR (dB) = P_{Pk} (dBm) - P_{Avg} (dBm).$$

#### Test Setup

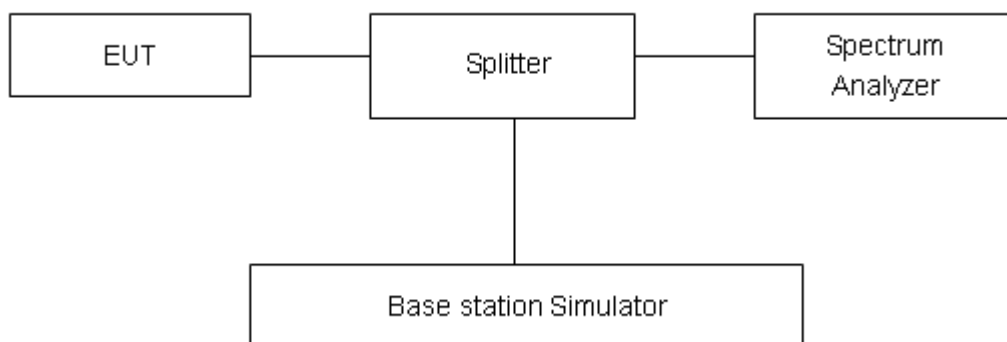

#### Limits

According to the Sec. 22.913(d), The peak-to-average ratio (PAR) of the transmission must not exceed 13 dB.

#### Measurement Uncertainty

The assessed measurement uncertainty to ensure 95% confidence level for the normal distribution is with the coverage factor  $k = 2$ ,  $U = 0.4$  dB.

**Test Results**

Mode	Channel	Frequency (MHz)	Peak (dBm)	Avg (dBm)	PAPR (dB)	Limit (dB)	Conclusion
<b>GSM 850 (GSM)</b>	128	824.2	29.57	28.59	0.98	≤13	PASS
	190	836.6	29.40	28.39	1.01	≤13	PASS
	251	848.8	30.21	29.24	0.97	≤13	PASS
<b>GPRS 850 (GMSK)</b>	128	824.2	24.32	23.34	0.98	≤13	PASS
	190	836.6	24.33	23.39	0.94	≤13	PASS
	251	848.8	24.58	23.53	1.05	≤13	PASS

## 5.6. Frequency Stability

### Ambient condition

Temperature	Relative humidity	Pressure
23°C ~25°C	45%~50%	101.5kPa

### Method of Measurement

#### Frequency Stability (Temperature Variation)

The temperature inside the climate chamber is varied from -40°C to +85°C in 10°C step size,

(1) With all power removed, the temperature was decreased to 0°C and permitted to stabilize for three hours.

(2) Measure the carrier frequency with the test equipment in a “call mode”. These measurements should be made within 1 minute of powering up the mobile station, to prevent significant self warming.

(3) Repeat the above measurements at 10°C increments from -40°C to +85°C. Allow at least 1.5 hours at each temperature, un-powered, before making measurements.

#### Frequency Stability (Voltage Variation)

The frequency stability shall be measured with variation of primary supply voltage as follows:

(1) Vary primary supply voltage from 85 to 115 percent of the nominal value for other than hand carried battery equipment.

(2) For hand carried, battery powered equipment, reduce primary supply voltage to the battery-operating end point which shall be specified by the manufacturer.

This transceiver is specified to operate with an input voltage of between 3.3 V and 4.6 V, with a nominal voltage of 4.0V.

### Test setup

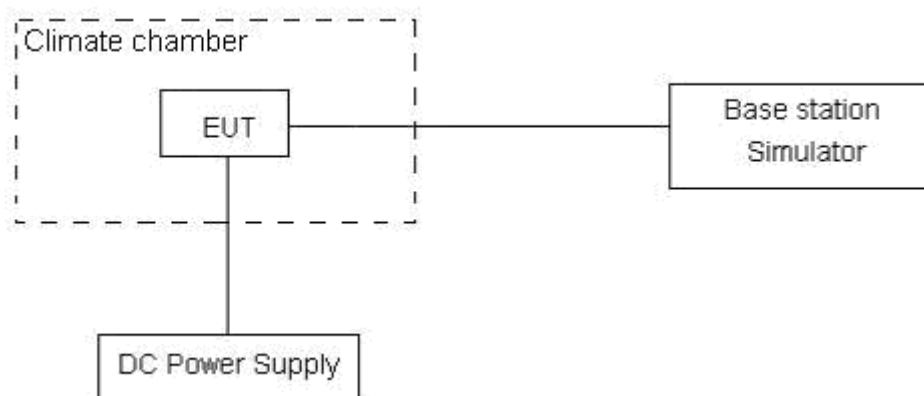

**Limits**

According to the Sec. 22.355, the frequency stability of the carrier shall be accurate to within 2.5 ppm of the received frequency for mobile stations.

Limits	$\leq 2.5$ ppm
--------	----------------

**Measurement Uncertainty**

The assessed measurement uncertainty to ensure 99.75% confidence level for the normal distribution is with the coverage factor  $k = 3$ ,  $U = 0.01$  ppm.



## Test Result

GSM 850					
Condition		824	849	Delta (Hz)	Frequency Stability (ppm)
Temperature	Voltage	F low@-13dBm(MHz)	F high@-13dBm(MHz)		
Normal (25°C)	Normal	824.0689	848.9736	3.24	0.00387
Extreme (85°C)		824.0687	848.9734	6.43	0.00769
Extreme (80°C)		824.0675	848.9722	7.51	0.00898
Extreme (70°C)		824.0688	848.9735	9.15	0.01094
Extreme (60°C)		824.0677	848.9724	2.48	0.00296
Extreme (50°C)		824.0676	848.9723	6.28	0.00751
Extreme (40°C)		824.0686	848.9733	3.01	0.00360
Extreme (30°C)		824.0677	848.9724	11.65	0.01393
Extreme (20°C)		824.0685	848.9732	10.89	0.01302
Extreme (10C)		824.0678	848.9725	8.99	0.01075
Extreme (0°C)		824.0684	848.9731	4.73	0.00565
Extreme (-10°C)		824.0679	848.9726	5.38	0.00643
Extreme (-20°C)		824.0683	848.9730	4.96	0.00593
Extreme (-30°C)		824.0680	848.9727	6.24	0.00746
Extreme (-40°C)		824.0682	848.9729	1.84	0.00220
25°C	LV	824.0681	848.9728	3.45	0.00412
	HV	824.0690	848.9737	7.62	0.00911
GPRS 850					
Condition		824	849	Delta (Hz)	Frequency Stability (ppm)
Temperature	Voltage	F low@-13dBm(MHz)	F high@-13dBm(MHz)		
Normal (25°C)	Normal	824.0654	848.9658	8.64	0.01033
Extreme (85°C)		824.0652	848.9656	9.42	0.01126
Extreme (80°C)		824.0640	848.9644	12.15	0.01452
Extreme (70°C)		824.0653	848.9657	14.38	0.01719
Extreme (60°C)		824.0642	848.9646	18.97	0.02268
Extreme (50°C)		824.0641	848.9645	4.87	0.00582
Extreme (40°C)		824.0651	848.9655	12.43	0.01486
Extreme (30°C)		824.0642	848.9646	13.25	0.01584
Extreme (20°C)		824.0650	848.9654	15.66	0.01872
Extreme (10C)		824.0643	848.9647	17.31	0.02069
Extreme (0°C)		824.0649	848.9653	11.28	0.01348
Extreme (-10°C)		824.0644	848.9648	13.75	0.01644
Extreme (-20°C)		824.0648	848.9652	15.69	0.01875



Extreme (-30°C)		824.0645	848.9649	9.78	0.01169
Extreme (-40°C)		824.0647	848.9651	12.30	0.01470
25°C	LV	824.0646	848.9650	4.85	0.00580
	HV	824.0655	848.9659	9.46	0.01131



### 5.7. Spurious Emissions at Antenna Terminals

#### Ambient condition

Temperature	Relative humidity	Pressure
23°C ~25°C	45%~50%	101.5kPa

#### Method of Measurement

The EUT was connected to Spectrum Analyzer and Base Station Simulator via power Splitter. The measurement is carried out using a spectrum analyzer. The spectrum analyzer scans from 9kHz to the 10th harmonic of the carrier.

The peak detector is used. RBW are set to 100 kHz and VBW are set to 300 kHz for below 1G, RBW are set to 1MHz and VBW are set to 3MHz for above 1G, Sweep is set to ATUO.

The modulation mode and RB allocation refer to section 5.1, using the maximum output power configuration.

#### Test setup

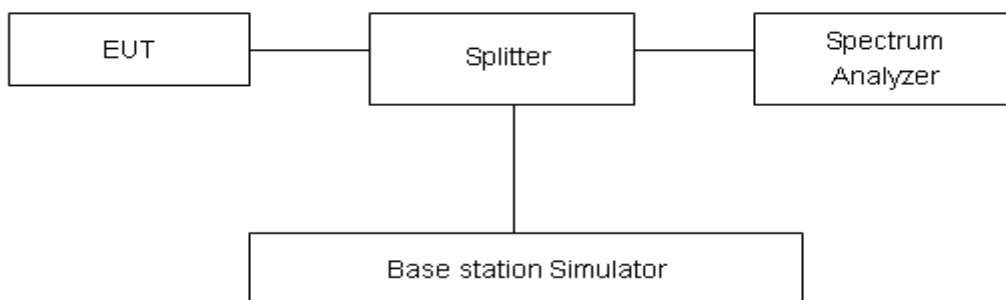

#### Limits

Rule Part 22.917(a) specifies that “The power of any emission outside of the authorized operating frequency ranges must be attenuated below the transmitting power (P) by a factor of at least 43 + 10 log (P) dB.”

Limit	-13 dBm
-------	---------

#### Measurement Uncertainty

The assessed measurement uncertainty to ensure 99.75% confidence level for the normal distribution is with the coverage factor  $k = 1.96$ .

Frequency	Uncertainty
9kHz-1GHz	0.684 dB
1GHz-18GHz	1.407 dB



### Test Result

Sweep the whole frequency band through the range from 9kHz to the 10th harmonic of the carrier, the emissions more than 20 dB below the limit are not reported.

The signal beyond the limit is carrier.

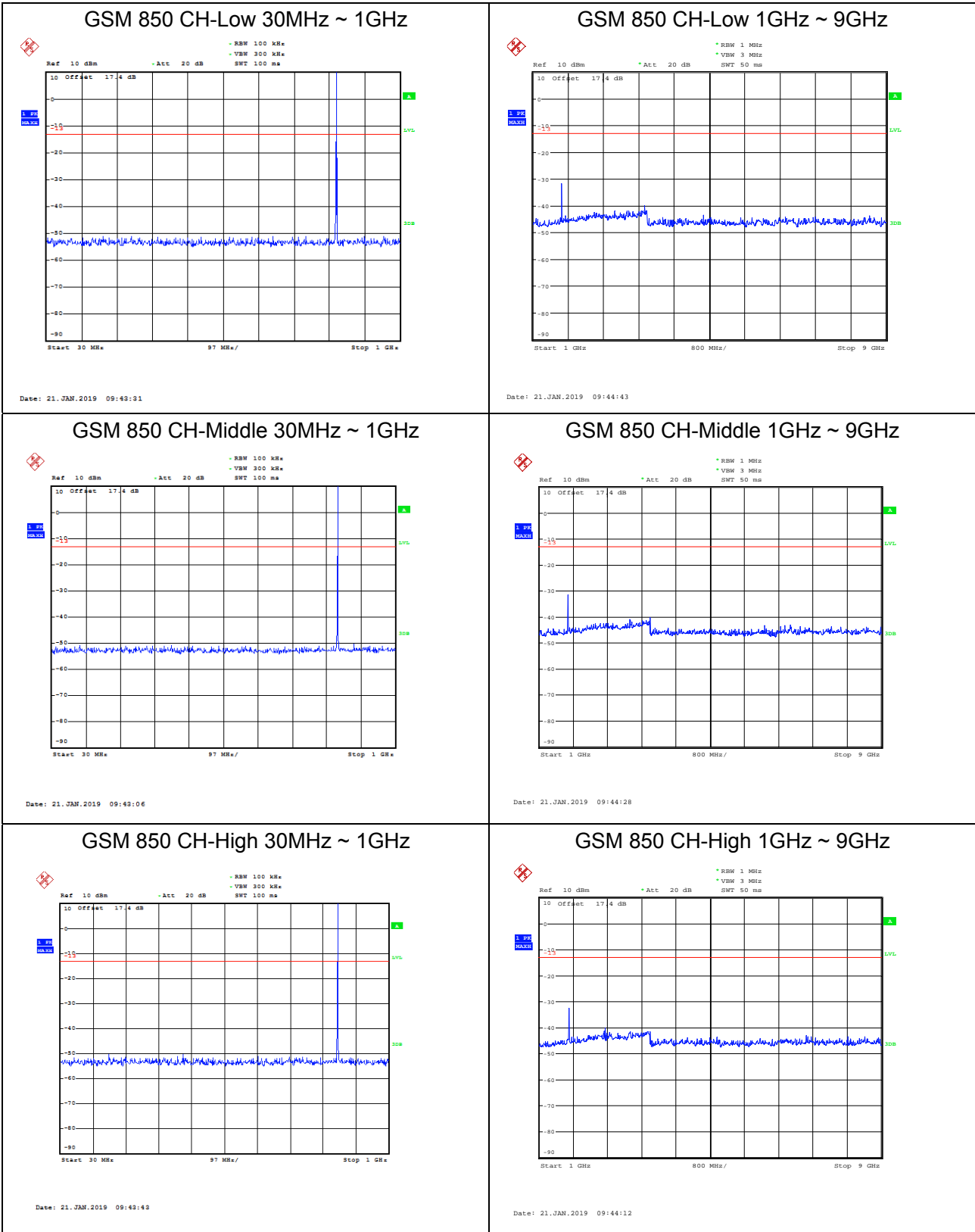



### GPRS 850 CH-Low 30MHz ~ 1GHz

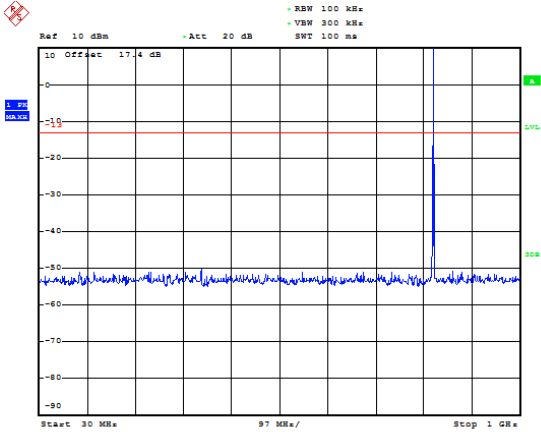

Date: 21.JAN.2019 09:46:32

### GPRS 850 CH-Low 1GHz ~ 9GHz

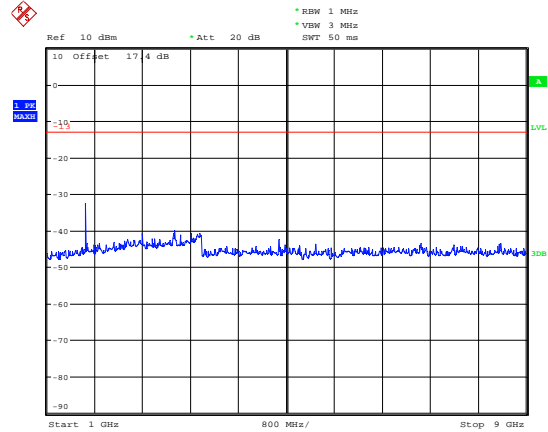

Date: 21.JAN.2019 09:45:38

### GPRS 850 CH-Middle 30MHz ~ 1GHz

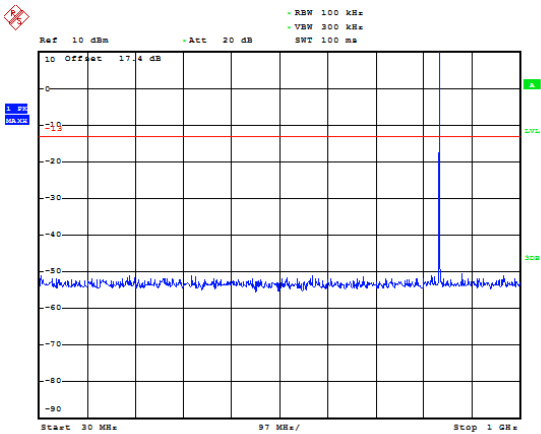

Date: 21.JAN.2019 09:46:20

### GPRS 850 CH-Middle 1GHz ~ 9GHz

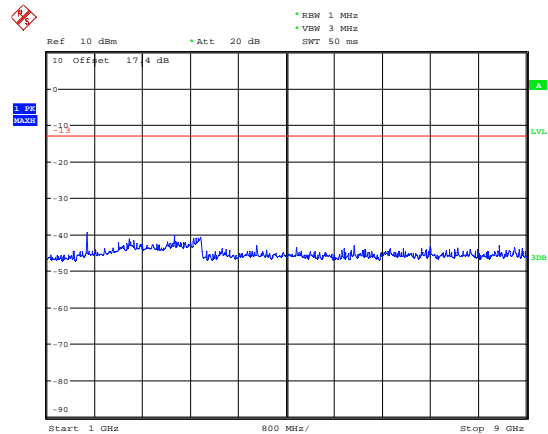

Date: 21.JAN.2019 09:45:26

### GPRS 850 CH-High 30MHz ~ 1GHz

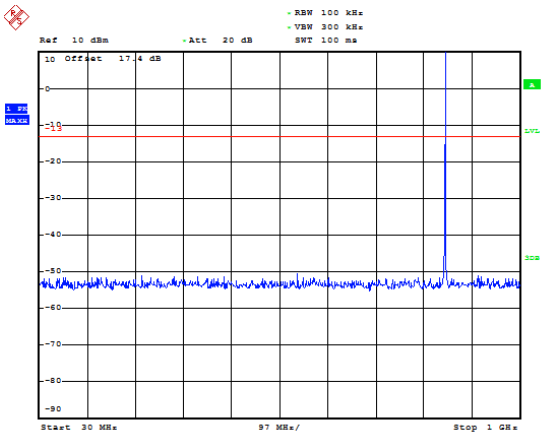

Date: 21.JAN.2019 09:46:07

### GPRS 850 CH-High 1GHz ~ 9GHz

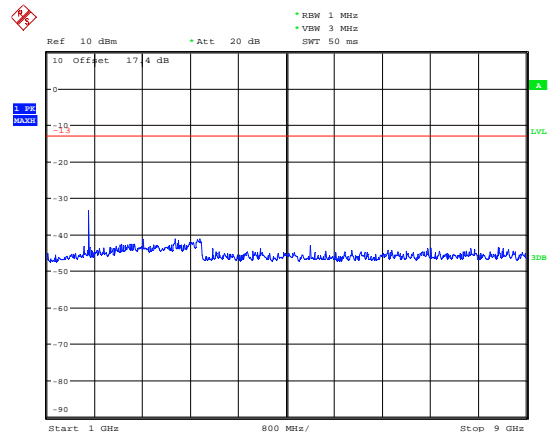

Date: 21.JAN.2019 09:45:51

## 5.8. Radiates Spurious Emission

### Ambient condition

Temperature	Relative humidity	Pressure
23°C ~25°C	45%~50%	101.5kPa

### Method of Measurement

1. The testing follows FCC KDB 971168 v03r01 Section 5.8 and ANSI C63.26 (2015).
2. Below 1GHz: The EUT is placed on a turntable 0.8 meters above the ground in the chamber, 3 meter away from the antenna. The maximal emission value is acquired by adjusting the antenna height, polarisation and turntable azimuth. Normally, the height range of antenna is 1 m to 4 m, the azimuth range of turntable is 0° to 360°, and the receive antenna has two polarizations Vertical (V) and Horizontal (H). Above 1GHz: (Note: the FCC's permission to use 1.5m as an alternative per TCBC Conf call of Dec. 2, 2014.) The EUT is placed on a turntable 1.5 meters above the ground in the chamber, 3 meter away from the antenna. The maximal emission value is acquired by adjusting the antenna height, polarisation and turntable azimuth. Normally, the height range of antenna is 1 m to 4 m, the azimuth range of turntable is 0° to 360°, and the receive antenna has two polarizations Vertical (V) and Horizontal (H).
3. A loop antenna, A log-periodic antenna or horn antenna shall be substituted in place of the EUT. The log-periodic antenna will be driven by a signal generator and the level will be adjusted till the same power value on the spectrum analyzer or receiver. The level of the spurious emissions can be calculated through the level of the signal generator, cable loss, the gain of the substitution antenna and the reading of the spectrum analyzer or receiver.
4. The EUT is then put into continuously transmitting mode at its maximum power level during the test. Set Test Receiver or Spectrum RBW=200Hz,VBW=600Hz for 9kHz150kHz , RBW=10kHz, VBW=30kHz 150kHz-30MHz , RBW=100kHz,VBW=300kHz for 30MHz to 1GHz and RBW=1MHz, VBW=3MHz for above 1GHz, And the maximum value of the receiver should be recorded as (Pr).
5. The EUT shall be replaced by a substitution antenna. In the chamber, an substitution antenna for the frequency band of interest is placed at the reference point of the chamber. An RF Signal source for the frequency band of interest is connected to the substitution antenna with a cable that has been constructed to not interfere with the radiation pattern of the antenna. A power (PMea) is applied to the input of the substitution antenna, and adjust the level of the signal generator output until the value of the receiver reach the previously recorded (Pr). The power of signal source (PMea) is recorded. The test should be performed by rotating the test item and adjusting the receiving antenna polarization.
6. A amplifier should be connected to the Signal Source output port. And the cable should be connect between the Amplifier and the Substitution Antenna. The cable loss (Pcl) ,the Substitution Antenna Gain (Ga) and the Amplifier Gain (PAg) should be recorded after test.
7. The measurement results are obtained as described below:  
Power(EIRP)=PMea- PAg - Pcl + Ga  
The measurement results are amend as described below:  
Power(EIRP)=PMea- Pcl + Ga
8. This value is EIRP since the measurement is calibrated using an antenna of known gain (2.15 dBi)

and known input power. ERP can be calculated from EIRP by subtracting the gain of the dipole,  $ERP = EIRP - 2.15\text{dBi}$ .

The modulation mode and RB allocation refer to section 5.1, using the maximum output power configuration.

**Test setup**

**9KHz ~ 30MHz**

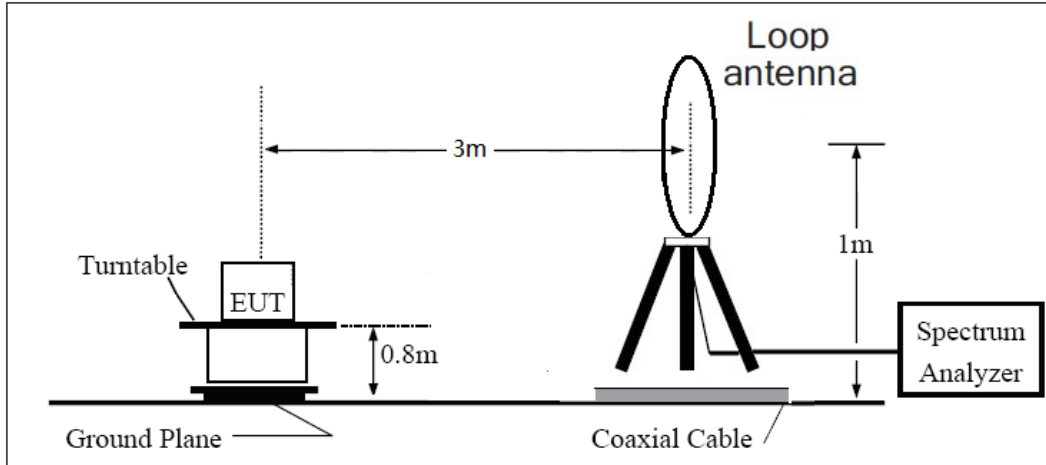

**30MHz ~ 1GHz**

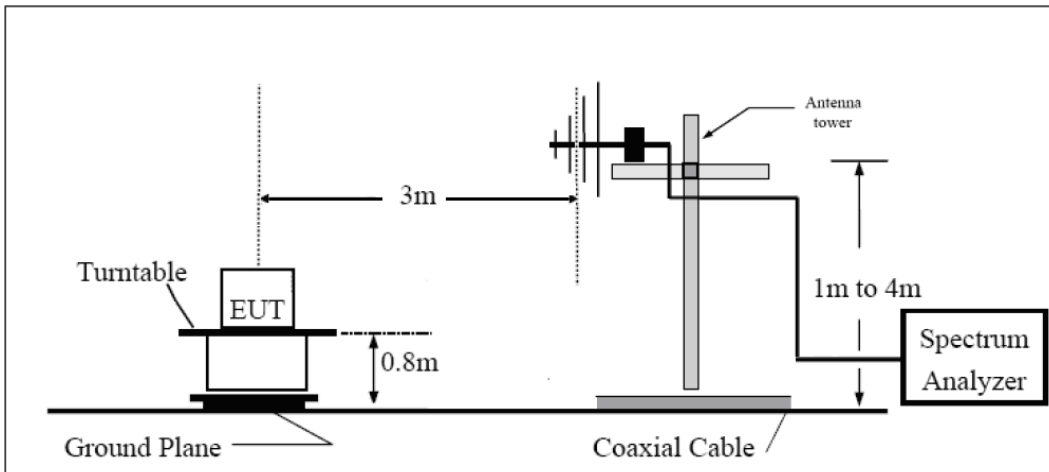

**Above 1GHz**

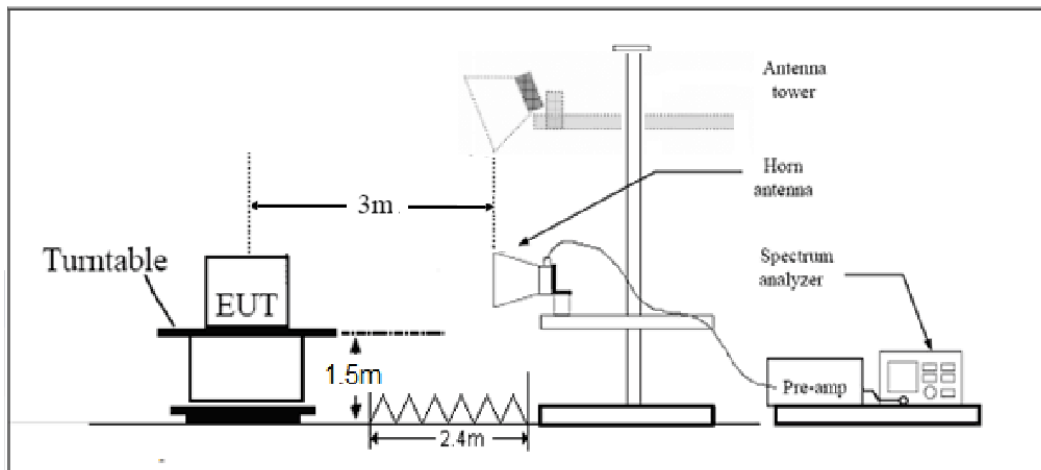



Note: Area side:2.4mX3.6m

**Limits**

Rule Part 22.917(a) specifies that “The power of any emission outside of the authorized operating frequency ranges must be attenuated below the transmitting power (P) by a factor of at least  $43 + 10 \log (P)$  dB.”

Limit	-13 dBm
-------	---------

**Measurement Uncertainty**

The assessed measurement uncertainty to ensure 95% confidence level for the normal distribution is with the coverage factor  $k = 1.96$ ,  $U = 3.55$  dB.

**Test Result**

Sweep the whole frequency band through the range from 9kHz to the 10th harmonic of the carrier, the emissions below the noise floor will not be recorded in the report.

## GSM 850 CH-Low

Harmonic	Frequency (MHz)	SG (dBm)	Cable Loss (dB)	Gain (dBi)	Antenna Polarization	ERP Level (dBm)	Limit (dBm)	Margin (dB)	Azimuth (deg)
2	1648.4	-48.24	2.00	10.15	Horizontal	-42.24	-13.00	29.24	45
3	2472.6	-47.78	2.51	11.35	Horizontal	-41.09	-13.00	28.09	45
4	3296.8	-52.66	4.20	10.85	Horizontal	-48.16	-13.00	35.16	270
5	4121.0	-37.49	5.20	11.35	Horizontal	-33.49	-13.00	20.49	225
6	4945.2	-52.98	5.50	11.95	Horizontal	-48.68	-13.00	35.68	315
7	5769.4	-55.80	5.70	13.55	Horizontal	-50.10	-13.00	37.10	180
8	6593.6	-51.54	6.30	13.75	Horizontal	-46.24	-13.00	33.24	90
9	7417.8	-49.18	6.80	13.85	Horizontal	-44.28	-13.00	31.28	135
10	8242.0	-51.72	6.90	14.25	Horizontal	-46.52	-13.00	33.52	45

Note: 1.The other Spurious RF Radiated emissions level is no more than noise floor.  
2.The worst emission was found in the antenna is Horizontal position.

## GSM 850 CH-Middle

Harmonic	Frequency (MHz)	SG (dBm)	Cable Loss (dB)	Gain (dBi)	Antenna Polarization	ERP Level (dBm)	Limit (dBm)	Margin (dB)	Azimuth (deg)
2	1673.2	-51.40	2.00	10.75	Horizontal	-44.80	-13.00	31.80	135
3	2509.8	-53.06	2.51	11.05	Horizontal	-46.67	-13.00	33.67	180
4	3346.4	-51.56	4.20	11.15	Horizontal	-46.76	-13.00	33.76	45
5	4183.0	-38.69	5.20	11.15	Horizontal	-34.89	-13.00	21.89	90
6	5019.6	-53.75	5.50	11.95	Horizontal	-49.45	-13.00	36.45	135
7	5856.2	-55.26	5.70	13.55	Horizontal	-49.56	-13.00	36.56	90
8	6692.8	-52.62	6.30	13.75	Horizontal	-47.32	-13.00	34.32	180
9	7529.4	-48.92	6.80	13.85	Horizontal	-44.02	-13.00	31.02	180
10	8366.0	-49.90	6.90	14.25	Horizontal	-44.70	-13.00	31.70	225

Note: 1.The other Spurious RF Radiated emissions level is no more than noise floor.  
2.The worst emission was found in the antenna is Horizontal position.



## GSM 850 CH-High

Harmonic	Frequency (MHz)	SG (dBm)	Cable Loss (dB)	Gain (dBi)	Antenna Polarization	ERP Level (dBm)	Limit (dBm)	Margin (dB)	Azimuth (deg)
2	1697.6	-48.10	2.00	10.15	Horizontal	-42.10	-13.00	29.10	45
3	2546.4	-53.02	2.51	11.05	Horizontal	-46.63	-13.00	33.63	90
4	3395.2	-52.33	4.20	11.15	Horizontal	-47.53	-13.00	34.53	45
5	4244.0	-42.42	5.20	11.15	Horizontal	-38.62	-13.00	25.62	135
6	5092.8	-52.97	5.50	11.95	Horizontal	-48.67	-13.00	35.67	90
7	5941.6	-55.28	5.70	13.55	Horizontal	-49.58	-13.00	36.58	180
8	6790.4	-52.37	6.30	13.75	Horizontal	-47.07	-13.00	34.07	225
9	7639.2	-50.27	6.80	13.85	Horizontal	-45.37	-13.00	32.37	180
10	8488.0	-48.69	6.90	14.25	Horizontal	-43.49	-13.00	30.49	315

Note: 1.The other Spurious RF Radiated emissions level is no more than noise floor.

2.The worst emission was found in the antenna is Horizontal position.



## 6. Main Test Instruments

Name	Manufacturer	Type	Serial Number	Calibration Date	Expiration Date
Power Splitter	Hua Xiang	SHX-GF2-2-13	10120101	/	/
Spectrum Analyzer	Key sight	N9010A	MY50210259	2018-05-20	2019-05-19
Universal Radio Communication Tester	Key sight	E5515C	MY48367192	2018-05-20	2019-05-19
Signal Analyzer	R&S	FSV30	100815	2018-12-16	2019-12-15
Loop Antenna	SCHWARZBECK	FMZB1519	1519-047	2017-09-26	2019-09-25
Trilog Antenna	SCHWARZBECK	VUBL 9163	9163-201	2017-11-18	2019-11-17
Horn Antenna	R&S	HF907	100126	2018-07-07	2020-07-06
Horn Antenna	ETS-Lindgren	3160-09	00102643	2018-06-20	2020-06-19
Signal generator	R&S	SMB 100A	102594	2018-05-20	2019-05-19
Climatic Chamber	ESPEC	SU-242	93000506	2017-12-17	2020-12-16
Preamplifier	R&S	SCU18	102327	2018-05-20	2019-05-19
MOB COMMS DC SUPPLY	Keysight	66319D	MY43004105	2018-05-21	2019-05-20
RF Cable	Agilent	SMA 15cm	0001	/	/
Software	R&S	EMC32	9.26.0	/	/

\*\*\*\*\*END OF REPORT \*\*\*\*\*

## ANNEX A: EUT Appearance and Test Setup

### A.1 EUT Appearance

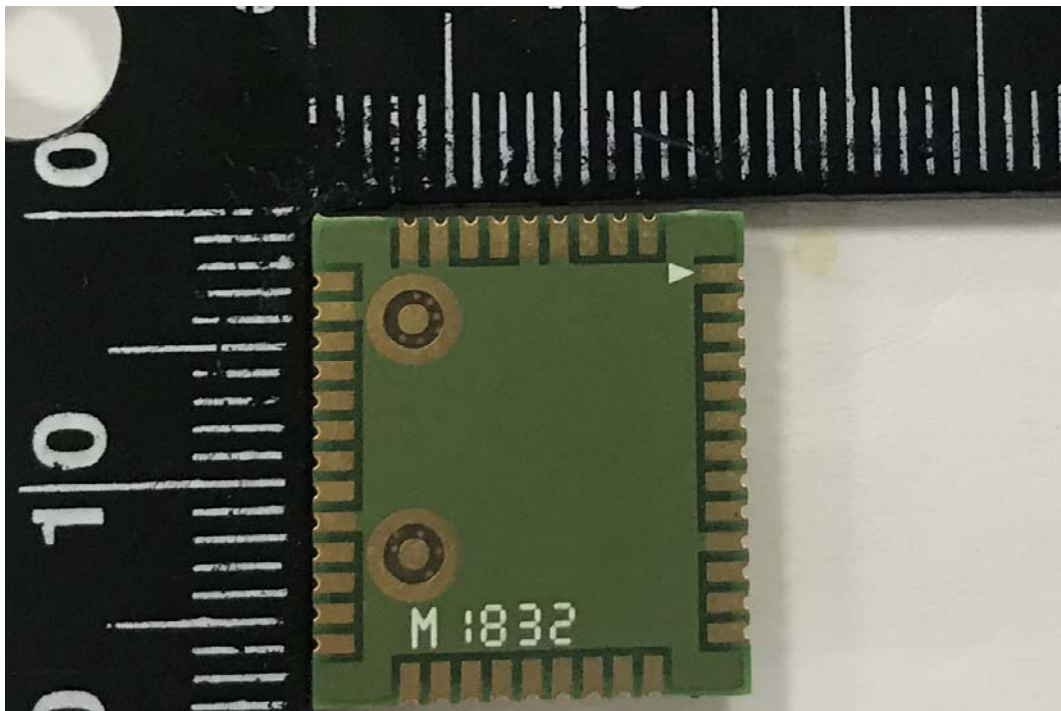
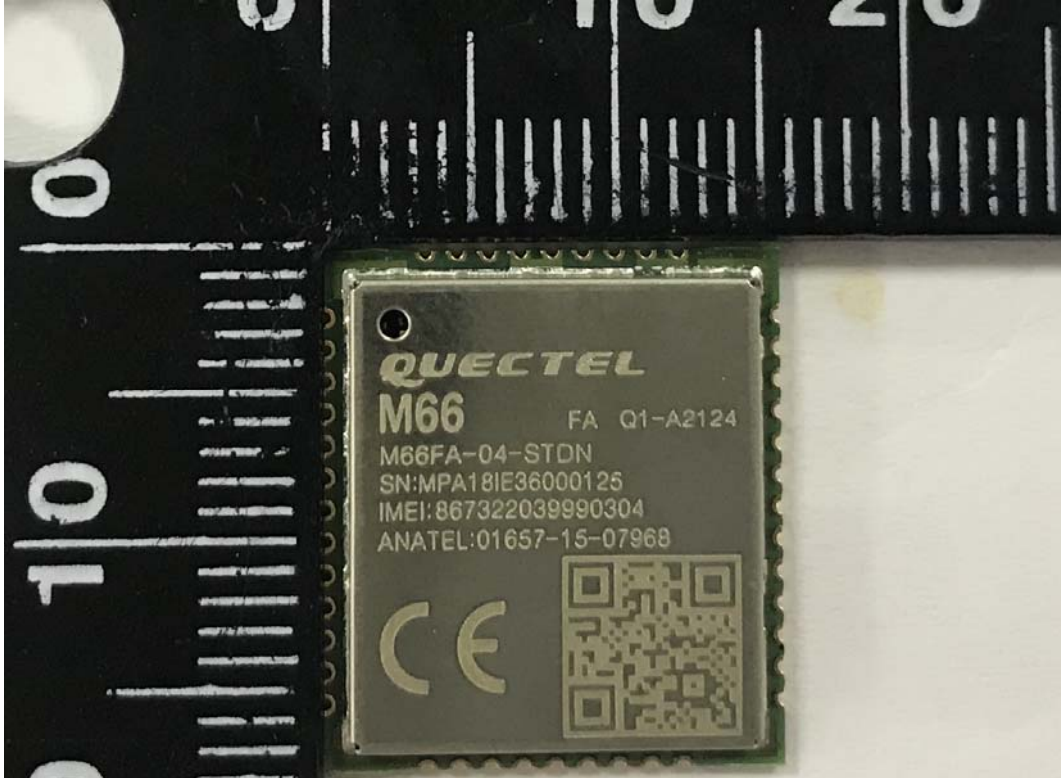

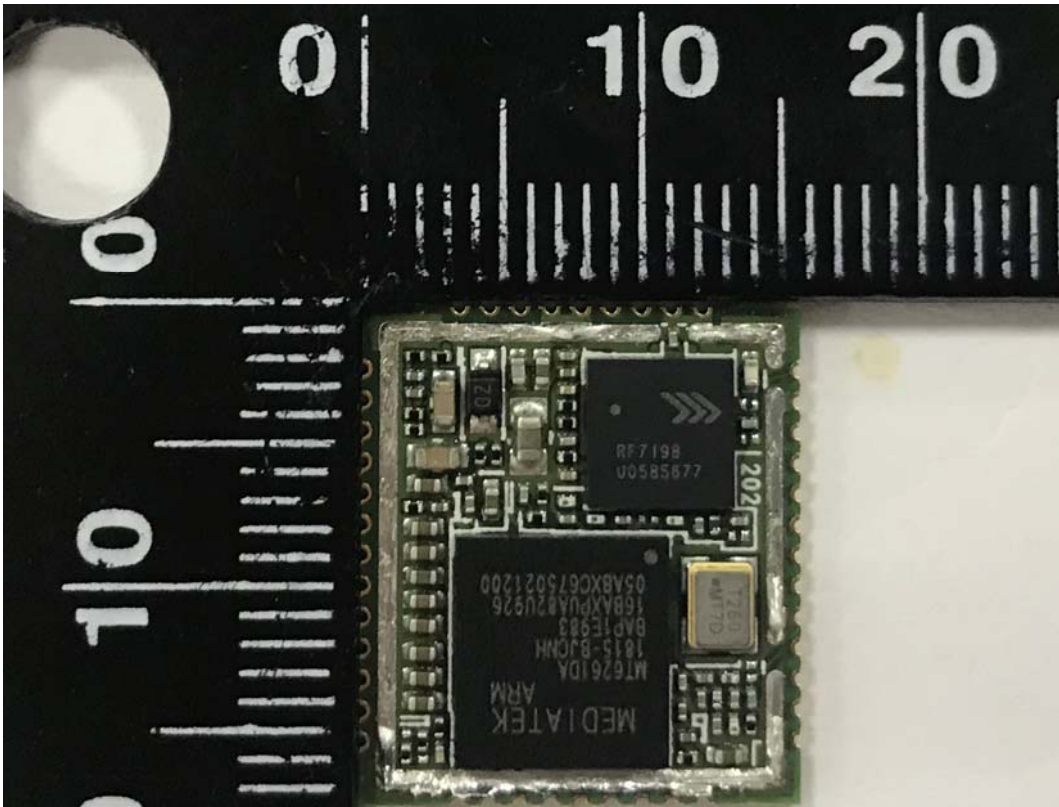

a: EUT

Picture 1 EUT

## A.2 Test Setup

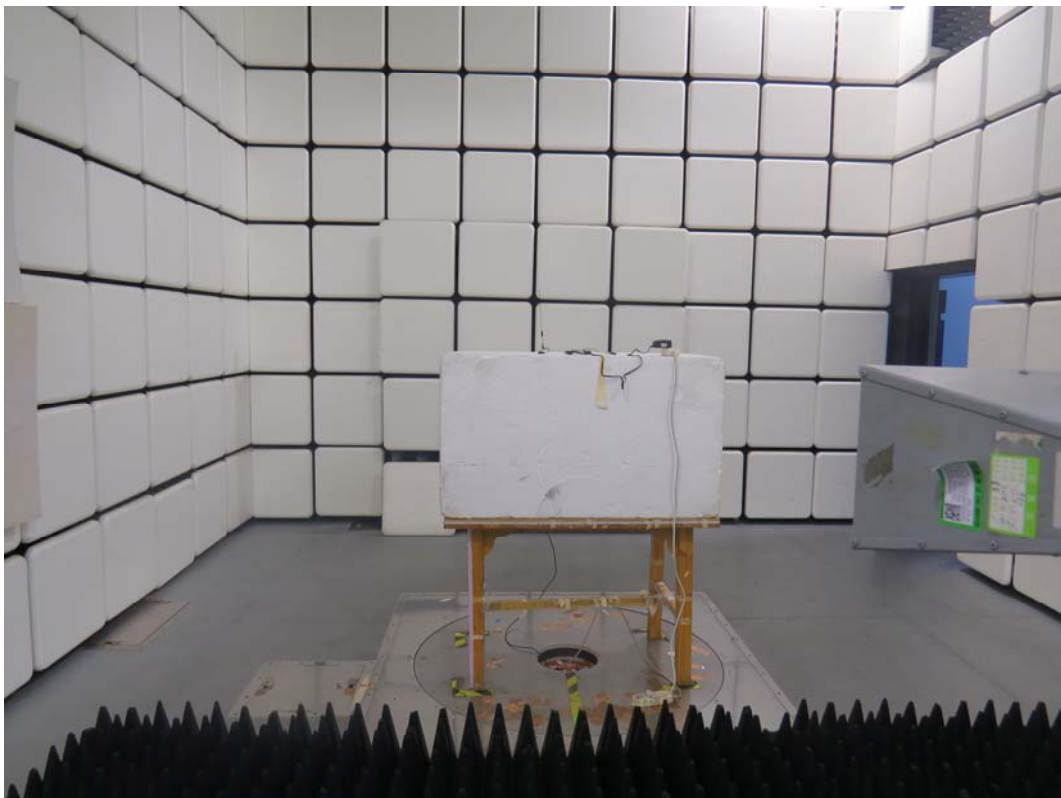

**Picture 2 Radiated Spurious Emissions Test setup**