



# RF TEST REPORT

**Applicant**      Quectel Wireless Solutions Co., Ltd  
**FCC ID**          XMR201901BG96M  
**Product**        LTE Cat M1 module  
**Brand**            Quectel  
**Model**            BG96-M  
**Report No.**      R1811A0537-R3V1  
**Issue Date**      March 26, 2019

TA Technology (Shanghai) Co., Ltd. tested the above equipment in accordance with the requirements in **FCC CFR47 Part 2 (2018)/ FCC CFR47 Part 27C (2018)**. The test results show that the equipment tested is capable of demonstrating compliance with the requirements as documented in this report.

*Performed by: Peng Tao*

*Approved by: Kai Xu*

---

## TA Technology (Shanghai) Co., Ltd.

*No.145, Jintang Rd, Tangzhen Industry Park, Pudong Shanghai, China*

*TEL: +86-021-50791141/2/3*

*FAX: +86-021-50791141/2/3-8000*

## Table of Contents

|          |                                                  |    |
|----------|--------------------------------------------------|----|
| 1        | Test Laboratory.....                             | 4  |
| 1.1      | Notes of the Test Report.....                    | 4  |
| 1.2      | Test facility.....                               | 4  |
| 1.3      | Testing Location.....                            | 5  |
| 2        | General Description of Equipment under Test..... | 6  |
| 3        | Applied Standards.....                           | 7  |
| 4        | Test Configuration.....                          | 8  |
| 5        | Test Case Results.....                           | 9  |
| 5.1      | RF Power Output.....                             | 9  |
| 5.2      | Effective Isotropic Radiated Power.....          | 12 |
| 5.3      | Occupied Bandwidth.....                          | 18 |
| 5.4      | Band Edge Compliance.....                        | 24 |
| 5.5      | Peak-to-Average Power Ratio (PAPR).....          | 42 |
| 5.6      | Frequency Stability.....                         | 44 |
| 5.7      | Spurious Emissions at Antenna Terminals.....     | 49 |
| 5.8      | Radiates Spurious Emission.....                  | 66 |
| 6        | Main Test Instruments.....                       | 74 |
| ANNEX A: | EUT Appearance and Test Setup.....               | 75 |
| A.1      | EUT Appearance.....                              | 75 |
| A.2      | Test Setup.....                                  | 75 |

## Summary of Measurement Results

| Number                                                                                                                                                          | Test Case                               | Clause in FCC rules                    | Verdict |
|-----------------------------------------------------------------------------------------------------------------------------------------------------------------|-----------------------------------------|----------------------------------------|---------|
| 1                                                                                                                                                               | RF power output                         | 2.1046                                 | PASS    |
| 2                                                                                                                                                               | Effective Isotropic Radiated power      | 27.50(d)(4)/27.50(b)(10)//27.50(c)(10) | PASS    |
| 3                                                                                                                                                               | Occupied Bandwidth                      | 2.1049                                 | PASS    |
| 4                                                                                                                                                               | Band Edge Compliance                    | 27.53(h)/27.53(g)/27.53(f) /27.53(c)   | PASS    |
| 5                                                                                                                                                               | Peak-to-Average Power Ratio             | 27.50(d)/KDB971168 D01(5.7)            | PASS    |
| 6                                                                                                                                                               | Frequency Stability                     | 2.1055 / 27.54                         | PASS    |
| 7                                                                                                                                                               | Spurious Emissions at Antenna Terminals | 2.1051/27.53(h) /27.53(g) /27.53(f)    | PASS    |
| 8                                                                                                                                                               | Radiates Spurious Emission              | 2.1053 /27.53(h) /27.53(g) /27.53(f)   | PASS    |
| Date of Testing: December 20, 2018~ January 10, 2019                                                                                                            |                                         |                                        |         |
| Note: PASS: The EUT complies with the essential requirements in the standard.<br>FAIL: The EUT does not comply with the essential requirements in the standard. |                                         |                                        |         |

# 1 Test Laboratory

## 1.1 Notes of the Test Report

This report shall not be reproduced in full or partial, without the written approval of **TA technology (shanghai) co., Ltd.** The results documented in this report apply only to the tested sample, under the conditions and modes of operation as described herein .Measurement Uncertainties were not taken into account and are published for informational purposes only. This report is written to support regulatory compliance of the applicable standards stated above.

## 1.2 Test facility

### **CNAS (accreditation number: L2264)**

TA Technology (Shanghai) Co., Ltd. has obtained the accreditation of China National Accreditation Service for Conformity Assessment (CNAS).

### **FCC (Designation number: CN1179, Test Firm Registration Number: 446626)**

TA Technology (Shanghai) Co., Ltd. has been listed on the US Federal Communications Commission list of test facilities recognized to perform electromagnetic emissions measurements.

### **IC (recognition number is 8510A)**

TA Technology (Shanghai) Co., Ltd. has been listed by industry Canada to perform electromagnetic emission measurement.

### **VCCI (recognition number is C-4595, T-2154, R-4113, G-10766)**

TA Technology (Shanghai) Co., Ltd. has been listed by industry Japan to perform electromagnetic emission measurement.

### **A2LA (Certificate Number: 3857.01)**

TA Technology (Shanghai) Co., Ltd. has been listed by American Association for Laboratory Accreditation to perform electromagnetic emission measurement.

### 1.3 Testing Location

Company: TA Technology (Shanghai) Co., Ltd.  
Address: No.145, Jintang Rd, Tangzhen Industry Park, Pudong Shanghai, China  
City: Shanghai  
Post code: 201201  
Country: P. R. China  
Contact: Xu Kai  
Telephone: +86-021-50791141/2/3  
Fax: +86-021-50791141/2/3-8000  
Website: <http://www.ta-shanghai.com>  
E-mail: [xukai@ta-shanghai.com](mailto:xukai@ta-shanghai.com)

## 2 General Description of Equipment under Test

### Client Information

|                             |                                                                                          |
|-----------------------------|------------------------------------------------------------------------------------------|
| <b>Applicant</b>            | Quectel Wireless Solutions Co., Ltd                                                      |
| <b>Applicant address</b>    | 7th Floor, Hongye Building, No.1801 Hongmei Road, Xuhui District, Shanghai 200233, China |
| <b>Manufacturer</b>         | Quectel Wireless Solutions Co., Ltd                                                      |
| <b>Manufacturer address</b> | 7th Floor, Hongye Building, No.1801 Hongmei Road, Xuhui District, Shanghai 200233, China |

### General information

| EUT Description                                                      |                                                                                                                                 |             |             |
|----------------------------------------------------------------------|---------------------------------------------------------------------------------------------------------------------------------|-------------|-------------|
| Model                                                                | BG96-M                                                                                                                          |             |             |
| IMEI                                                                 | 864834040000348                                                                                                                 |             |             |
| Hardware Version                                                     | R1.0                                                                                                                            |             |             |
| Software Version                                                     | BG96MMAR04A01M1G                                                                                                                |             |             |
| Power Supply                                                         | External Power Supply                                                                                                           |             |             |
| Antenna Type                                                         | The EUT don't have standard Antenna, The Antenna used for testing in this report is the after-market accessory (Dipole Antenna) |             |             |
| Antenna Gain                                                         | 4 dBi                                                                                                                           |             |             |
| Test Mode(s)                                                         | LTE Band 4/12/13;                                                                                                               |             |             |
| Test Modulation                                                      | QPSK 16QAM;                                                                                                                     |             |             |
| LTE Category                                                         | M1                                                                                                                              |             |             |
| Maximum E.I.R.P./ E.R.P.                                             | LTE Band 4:                                                                                                                     | 24.67 dBm   |             |
|                                                                      | LTE Band 12:                                                                                                                    | 21.04 dBm   |             |
|                                                                      | LTE Band 13:                                                                                                                    | 19.36 dBm   |             |
| Rated Power Supply Voltage:                                          | 3.8V                                                                                                                            |             |             |
| Extreme Voltage                                                      | Minimum: 3.3V    Maximum: 4.3V                                                                                                  |             |             |
| Extreme Temperature                                                  | Lowest: -40°C    Highest: +85°C                                                                                                 |             |             |
| Operating Frequency Range(s)                                         | Mode                                                                                                                            | Tx (MHz)    | Rx (MHz)    |
|                                                                      | LTE Band 4                                                                                                                      | 1710 ~ 1755 | 2110 ~ 2155 |
|                                                                      | LTE Band 12                                                                                                                     | 699 ~ 716   | 729 ~ 746   |
|                                                                      | LTE Band 13                                                                                                                     | 777 ~ 787   | 746 ~ 756   |
| Note: 1. The information of the EUT is declared by the manufacturer. |                                                                                                                                 |             |             |

### **3 Applied Standards**

According to the specifications of the manufacturer, it must comply with the requirements of the following standards:

#### **Test standards**

**FCC CFR47 Part 2 (2018)**

**FCC CFR47 Part 27C (2018)**

**ANSI C63.26 (2015)**

**KDB 971168 D01 Power Meas License Digital Systems v03r01**

## 4 Test Configuration

Radiated measurements are performed by rotating the EUT in three different orthogonal test planes. EUT stand-up position (Z axis), lie-down position (X, Y axis). Receiver antenna polarization (horizontal and vertical), the worst emission was found in position (Z axis, vertical polarization) and the worst case was recorded.

All mode and data rates and positions and RB size and modulations were investigated.

Subsequently, only the worst case emissions are reported.

The following testing in LTE is set based on the maximum RF Output Power.

The following testing in different Bandwidth is set to detail in the following table:

Test modes are chosen to be reported as the worst case configuration below for LTE Band 4/12/13:

| Test items                              | Modes                                                                                                                                 | Bandwidth (MHz) |   |   |    |    |    | Modulation |       | RB |     |      | Test Channel |   |   |
|-----------------------------------------|---------------------------------------------------------------------------------------------------------------------------------------|-----------------|---|---|----|----|----|------------|-------|----|-----|------|--------------|---|---|
|                                         |                                                                                                                                       | 1.4             | 3 | 5 | 10 | 15 | 20 | QPSK       | 16QAM | 1  | 50% | 100% | L            | M | H |
| RF power output                         | LTE 4                                                                                                                                 | O               | O | O | O  | O  | O  | O          | O     | O  | O   | O    | O            | O | O |
|                                         | LTE 12                                                                                                                                | O               | O | O | O  | -  | -  | O          | O     | O  | O   | O    | O            | O | O |
|                                         | LTE 13                                                                                                                                | -               | - | O | O  | -  | -  | O          | O     | O  | O   | O    | O            | O | O |
| Effective Isotropic Radiated power      | LTE 4                                                                                                                                 | O               | O | O | O  | O  | O  | O          | O     | O  | O   | O    | O            | O | O |
|                                         | LTE 12                                                                                                                                | O               | O | O | O  | -  | -  | O          | O     | O  | O   | O    | O            | O | O |
|                                         | LTE 13                                                                                                                                | -               | - | O | O  | -  | -  | O          | O     | O  | O   | O    | O            | O | O |
| Occupied Bandwidth                      | LTE 4                                                                                                                                 | O               | O | O | O  | O  | O  | O          | O     | -  | -   | O    | -            | O | - |
|                                         | LTE 12                                                                                                                                | O               | O | O | O  | -  | -  | O          | O     | -  | -   | O    | -            | O | - |
|                                         | LTE 13                                                                                                                                | -               | - | O | O  | -  | -  | O          | O     | -  | -   | O    | -            | O | - |
| Band Edge Compliance                    | LTE 4                                                                                                                                 | O               | O | O | O  | O  | O  | O          | O     | O  | -   | O    | O            | - | O |
|                                         | LTE 12                                                                                                                                | O               | O | O | O  | -  | -  | O          | O     | O  | -   | O    | O            | - | O |
|                                         | LTE 13                                                                                                                                | -               | - | O | O  | -  | -  | O          | O     | O  | -   | O    | O            | - | O |
| Peak-to-Average Power Ratio             | LTE 4                                                                                                                                 | O               | O | O | O  | O  | O  | O          | O     | -  | -   | O    | O            | O | O |
|                                         | LTE 12                                                                                                                                | O               | O | O | O  | -  | -  | O          | O     | -  | -   | O    | O            | O | O |
|                                         | LTE 13                                                                                                                                | -               | - | O | O  | -  | -  | O          | O     | -  | -   | O    | O            | O | O |
| Frequency Stability                     | LTE 4                                                                                                                                 | O               | O | O | O  | O  | O  | O          | O     | O  | O   | O    | O            | O | O |
|                                         | LTE 12                                                                                                                                | O               | O | O | O  | -  | -  | O          | O     | O  | O   | O    | O            | O | O |
|                                         | LTE 13                                                                                                                                | -               | - | O | O  | -  | -  | O          | O     | O  | O   | O    | O            | O | O |
| Spurious Emissions at Antenna Terminals | LTE 4                                                                                                                                 | O               | O | O | O  | O  | O  | O          | -     | O  | -   | -    | O            | O | O |
|                                         | LTE 12                                                                                                                                | O               | O | O | O  | -  | -  | O          | -     | O  | -   | -    | O            | O | O |
|                                         | LTE 13                                                                                                                                | -               | - | O | O  | -  | -  | O          | -     | O  | -   | -    | O            | O | O |
| Radiates Spurious Emission              | LTE 4                                                                                                                                 | -               | - | - | -  | -  | O  | O          | -     | O  | -   | -    | O            | O | O |
|                                         | LTE 12                                                                                                                                | -               | - | - | O  | -  | -  | O          | -     | O  | -   | -    | O            | O | O |
|                                         | LTE 13                                                                                                                                | -               | - | - | O  | -  | -  | O          | -     | O  | -   | -    | O            | O | O |
| Note                                    | 1. The mark "O" means that this configuration is chosen for testing.<br>2. The mark "-" means that this configuration is not testing. |                 |   |   |    |    |    |            |       |    |     |      |              |   |   |



## 5 Test Case Results

### 5.1 RF Power Output

#### Ambient condition

| Temperature | Relative humidity | Pressure |
|-------------|-------------------|----------|
| 23°C ~25°C  | 45%~50%           | 101.5kPa |

#### Methods of Measurement

During the process of the testing, The EUT is controlled by the Base Station Simulator to ensure max power transmission and proper modulation.

#### Test Setup

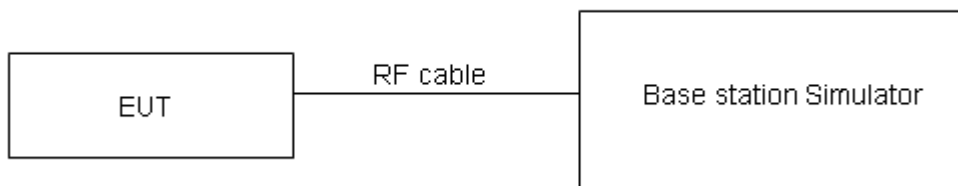

The loss between RF output port of the EUT and the input port of the tester has been taken into consideration.

#### Limits

No specific RF power output requirements in part 2.1046.

#### Measurement Uncertainty

The assessed measurement uncertainty to ensure 95% confidence level for the normal distribution is with the coverage factor  $k = 2$ ,  $U=0.4$  dB.

**Test Results**

| LTE Band 4 | Channel/<br>Frequency(MHz) | Index | RB#<br>RB start | Conducted Power (dBm) |       |
|------------|----------------------------|-------|-----------------|-----------------------|-------|
|            |                            |       |                 | QPSK                  | 16QAM |
| 1.4MHz     | 19957 1710.7               | 0     | 1#0             | 21.93                 | 22.06 |
|            |                            | 0     | 6#0             | 22.25                 | 22.38 |
|            | 20175/1732.5               | 0     | 1#0             | 22.03                 | 22.13 |
|            |                            | 0     | 6#0             | 22.24                 | 22.22 |
|            | 20393/1754.3               | 0     | 1#5             | 22.18                 | 22.32 |
|            |                            | 0     | 6#0             | 22.38                 | 22.41 |
| 3MHz       | 19965/1711.5               | 0     | 1#0             | 21.95                 | 22.10 |
|            |                            | 0     | 6#0             | 22.31                 | 22.41 |
|            | 20175/1732.5               | 0     | 1#0             | 21.91                 | 22.06 |
|            |                            | 0     | 6#0             | 22.22                 | 22.30 |
|            | 20385/1753.5               | 1     | 1#5             | 22.64                 | 22.09 |
|            |                            | 1     | 6#0             | 22.35                 | 22.70 |
| 5MHz       | 19975/1712.5               | 0     | 1#0             | 22.00                 | 22.84 |
|            |                            | 0     | 6#0             | 22.11                 | 22.35 |
|            | 20175/1732.5               | 0     | 1#0             | 21.94                 | 22.87 |
|            |                            | 0     | 6#0             | 22.16                 | 22.35 |
|            | 20375/1752.5               | 3     | 1#5             | 22.10                 | 22.44 |
|            |                            | 3     | 6#0             | 22.41                 | 22.37 |
| 10MHz      | 20000/1715                 | 0     | 1#0             | 21.85                 | 22.88 |
|            |                            | 0     | 4#0             | 22.17                 | 21.74 |
|            | 20175/1732.5               | 0     | 1#0             | 21.92                 | 22.84 |
|            |                            | 0     | 4#0             | 22.15                 | 21.80 |
|            | 20350/1750                 | 7     | 1#5             | 22.14                 | 22.53 |
|            |                            | 7     | 4#2             | 22.34                 | 21.93 |
| 15MHz      | 20025/1717.5               | 0     | 1#0             | 22.22                 | 22.18 |
|            |                            | 0     | 6#0             | 22.04                 | 22.42 |
|            | 20175/1732.5               | 0     | 1#0             | 22.33                 | 22.17 |
|            |                            | 0     | 6#0             | 22.13                 | 22.61 |
|            | 20325/1747.5               | 11    | 1#5             | 22.21                 | 23.12 |
|            |                            | 11    | 6#0             | 22.42                 | 22.35 |
| 20MHz      | 20050/1720                 | 0     | 1#0             | 22.12                 | 21.82 |
|            |                            | 0     | 6#0             | 22.05                 | 22.52 |
|            | 20175/1732.5               | 0     | 1#0             | 22.00                 | 22.66 |
|            |                            | 0     | 6#0             | 22.19                 | 22.38 |
|            | 20300/1745                 | 15    | 1#5             | 22.18                 | 22.62 |
|            |                            | 15    | 6#0             | 22.44                 | 22.51 |



| LTE Band 12 | Channel/<br>Frequency(MHz) | Index | RB#<br>RB start | Conducted Power (dBm) |       |
|-------------|----------------------------|-------|-----------------|-----------------------|-------|
|             |                            |       |                 | QPSK                  | 16QAM |
| 1.4MHz      | 23017/699.7                | 0     | 1#0             | 22.42                 | 23.12 |
|             |                            | 0     | 6#0             | 22.55                 | 22.43 |
|             | 23095/707.5                | 0     | 1#0             | 22.77                 | 22.41 |
|             |                            | 0     | 6#0             | 22.71                 | 23.13 |
|             | 23173/715.3                | 0     | 1#5             | 22.75                 | 22.47 |
|             |                            | 0     | 6#0             | 22.72                 | 23.08 |
| 3MHz        | 23025/700.5                | 0     | 1#0             | 22.85                 | 22.34 |
|             |                            | 0     | 6#0             | 22.68                 | 22.94 |
|             | 23095/707.5                | 0     | 1#0             | 22.94                 | 22.66 |
|             |                            | 0     | 6#0             | 22.75                 | 22.72 |
|             | 23165/714.5                | 1     | 1#5             | 22.86                 | 22.61 |
|             |                            | 1     | 6#0             | 22.60                 | 22.79 |
| 5MHz        | 23035/701.5                | 3     | 1#0             | 22.42                 | 23.32 |
|             |                            | 0     | 6#0             | 22.70                 | 22.67 |
|             | 23095/707.5                | 0     | 1#0             | 22.74                 | 22.66 |
|             |                            | 0     | 6#0             | 22.65                 | 22.68 |
|             | 23155/713.5                | 0     | 1#5             | 23.03                 | 23.10 |
|             |                            | 3     | 6#0             | 22.67                 | 22.77 |
| 10MHz       | 23060/704                  | 3     | 1#0             | 22.45                 | 23.33 |
|             |                            | 0     | 4#0             | 22.54                 | 22.30 |
|             | 23095/707.5                | 0     | 1#0             | 22.70                 | 22.51 |
|             |                            | 0     | 4#0             | 22.87                 | 23.26 |
|             | 23130/711                  | 4     | 1#5             | 22.80                 | 23.09 |
|             |                            | 7     | 4#2             | 22.62                 | 23.22 |

| LTE Band 13 | Channel/<br>Frequency(MHz) | Index | RB#<br>RB start | Conducted Power (dBm) |       |
|-------------|----------------------------|-------|-----------------|-----------------------|-------|
|             |                            |       |                 | QPSK                  | 16QAM |
| 5MHz        | 23205/779.5                | 0     | 1#0             | 22.99                 | 23.97 |
|             |                            | 0     | 6#0             | 23.09                 | 23.19 |
|             | 23230/782                  | 0     | 1#0             | 23.33                 | 23.06 |
|             |                            | 0     | 6#0             | 23.10                 | 22.94 |
|             | 23255/784.5                | 3     | 1#5             | 23.13                 | 23.51 |
|             |                            | 3     | 6#0             | 23.06                 | 23.04 |
| 10MHz       | 23230/782                  | 0     | 1#0             | 22.93                 | 23.73 |
|             |                            | 0     | 4#0             | 23.26                 | 22.95 |

## 5.2 Effective Isotropic Radiated Power

### Ambient condition

| Temperature | Relative humidity | Pressure |
|-------------|-------------------|----------|
| 23°C ~25°C  | 45%~50%           | 101.5kPa |

### Methods of Measurement

1. The testing follows FCC KDB 971168 D01 v03r01 Section 5.8 and ANSI C63.26 (2015).
  - a) Connect the equipment as illustrated. Mount the equipment with the manufacturer specified antenna in a vertical orientation on a manufacturer specified mounting surface located on a non-conducting rotating platform of a RF anechoic chamber (preferred) or a standard radiation site.
  - b) Key the transmitter, then rotate the EUT 360° azimuthally and record spectrum analyzer power level (LVL) measurements at angular increments that are sufficiently small to permit resolution of all peaks. If a standard radiation test site is used, raise and lower the test antenna to obtain a maximum reading at each angular increment. (Note: several batteries may be needed to offset the effect of battery voltage droop, which should not exceed 5% of the manufactured specified battery voltage during transmission).
  - c) Replace the transmitter under test with a vertically polarized half-wave dipole (or an antenna whose gain is known relative to an ideal half-wave dipole). The center of the antenna should be at the same location as the center of the antenna under test.
  - d) Connect the antenna to a signal generator with a known output power and record the path loss (in dB) as LOSS. If a standard radiation test site is used, raise and lower the test antenna to obtain a maximum reading.  $LOSS = \text{Generator Output Power (dBm)} - \text{Analyzer reading (dBm)}$
  - e) Determine the effective radiated output power at each angular position from the readings in steps b) and d) using the following equation:  $ERP \text{ (dBm)} = LVL \text{ (dBm)} + LOSS \text{ (dB)}$
  - f) The maximum ERP is the maximum value determined in the preceding step.
  - g) When calculating ERP, in addition to knowing the antenna radiation and matching characteristics, it is necessary to know the loss values of all elements (e.g. transmission line attenuation, mismatches, filters, combiners) interposed between the point where transmitter output power is measured, and the point where power is applied to the antenna. ERP can then be calculated as follows:  
 $EIRP \text{ (dBm)} = \text{Output Power (dBm)} - \text{Losses (dB)} + \text{Antenna Gain (dBi)}$   
 where: dBd refers to gain relative to an ideal dipole.  
 $EIRP \text{ (dBm)} = ERP \text{ (dBm)} + 2.15 \text{ (dB.)}$

The RB allocation refers to section 5.1, using the maximum output power configuration.

**Test setup**

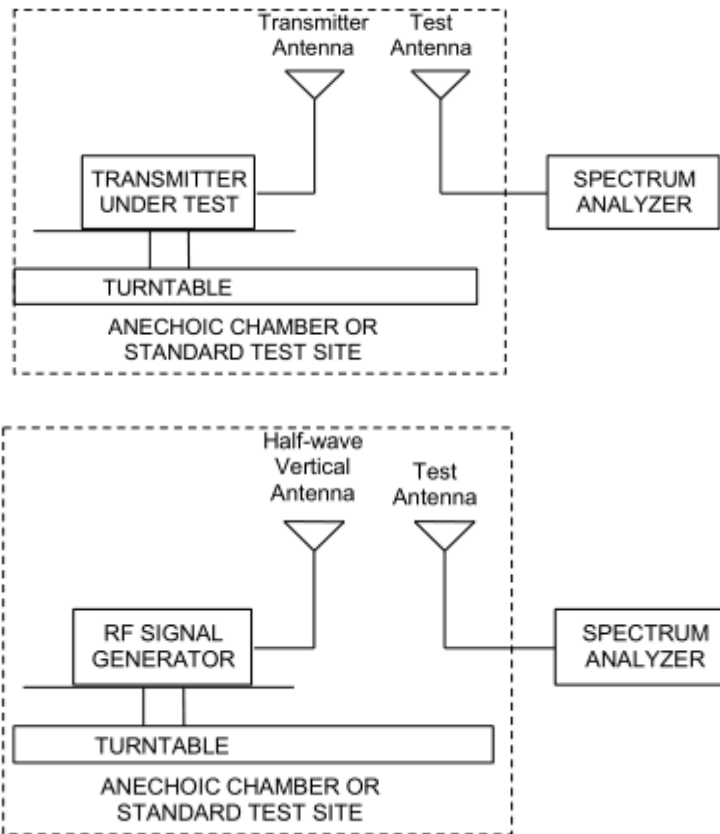

Note: Area side:2.4mX3.6m

The radiated emission was measured in the following position: EUT stand-up position (Z axis), lie-down position (X, Y axis). The worst emission was found in stand-up position (Z axis) and the worst case was recorded.

**Limits**

Rule Part 27.50(b) (10) specifies that “Portable stations (hand-held devices) transmitting in the 746-757 MHz, 776-788 MHz, and 805-806 MHz bands are limited to 3 watts ERP”

Rule Part 27.50(c) (10) specifies that “Portable stations (hand-held devices) in the 600 MHz uplink band and the 698-746 MHz band, and fixed and mobile stations in the 600 MHz uplink band are limited to 3 watts ERP”

Rule Part 27.50(d) (4) specifies that “Fixed, mobile and portable (hand-held) stations operating in the 1710–1755 MHz band are limited to 1 watt EIRP”

|                        |                                |
|------------------------|--------------------------------|
| Part 27.50(b)(10)Limit | $\leq 3 \text{ W}$ (34.77 dBm) |
| Part 27.50(c)(10)Limit | $\leq 3 \text{ W}$ (34.77 dBm) |
| Part 27.50(d)(4)Limit  | $\leq 1 \text{ W}$ (30 dBm)    |

**Measurement Uncertainty**

The assessed measurement uncertainty to ensure 95% confidence level for the normal distribution is with the coverage factor  $k = 2$ ,  $U = 1.19 \text{ dB}$

**Test Results**

The measurement is performed for both of horizontal and vertical antenna Polarization, and only the data of worst mode is recorded in this report.

| LTE Band 4      |                            |              |     |       |                          |               |                |            |
|-----------------|----------------------------|--------------|-----|-------|--------------------------|---------------|----------------|------------|
| Bandwidth       | Channel/<br>Frequency(MHz) | Polarization | RB  | Index | Output<br>power<br>(dBm) | EIRP<br>(dBm) | Limit<br>(dBm) | Conclusion |
| 1.4MHz<br>QPSK  | 19957 1710.7               | H            | 1#0 | 0     | -31.07                   | 24.67         | 30             | Pass       |
|                 | 20175/1732.5               | H            | 1#2 | 0     | -31.85                   | 24.03         | 30             | Pass       |
|                 | 20393/1754.3               | H            | 1#5 | 0     | -31.93                   | 23.89         | 30             | Pass       |
| 3MHz<br>QPSK    | 19965/1711.5               | H            | 1#0 | 0     | -31.36                   | 24.41         | 30             | Pass       |
|                 | 20175/1732.5               | H            | 1#5 | 0     | -31.91                   | 23.97         | 30             | Pass       |
|                 | 20385/1753.5               | H            | 1#5 | 1     | -31.95                   | 23.88         | 30             | Pass       |
| 5MHz<br>QPSK    | 19975/1712.5               | H            | 1#0 | 0     | -31.37                   | 24.41         | 30             | Pass       |
|                 | 20175/1732.5               | H            | 1#5 | 1     | -31.86                   | 24.02         | 30             | Pass       |
|                 | 20375/1752.5               | H            | 1#5 | 3     | -31.73                   | 24.11         | 30             | Pass       |
| 10MHz<br>QPSK   | 20000/1715                 | H            | 4#0 | 0     | -31.45                   | 24.32         | 30             | Pass       |
|                 | 20175/1732.5               | H            | 4#2 | 3     | -31.93                   | 23.95         | 30             | Pass       |
|                 | 20350/1750                 | H            | 4#2 | 7     | -31.84                   | 23.94         | 30             | Pass       |
| 15MHz<br>QPSK   | 20025/1717.5               | H            | 1#0 | 0     | -31.52                   | 24.31         | 30             | Pass       |
|                 | 20175/1732.5               | H            | 1#5 | 5     | -31.83                   | 24.05         | 30             | Pass       |
|                 | 20325/1747.5               | H            | 1#5 | 11    | -31.87                   | 23.96         | 30             | Pass       |
| 20MHz<br>QPSK   | 20050/1720                 | H            | 6#0 | 0     | -31.27                   | 24.59         | 30             | Pass       |
|                 | 20175/1732.5               | H            | 6#0 | 7     | -31.87                   | 24.01         | 30             | Pass       |
|                 | 20300/1745                 | H            | 6#0 | 15    | -31.80                   | 24.06         | 30             | Pass       |
| 1.4MHz<br>16QAM | 19957 1710.7               | H            | 1#0 | 0     | -31.71                   | 24.03         | 30             | Pass       |
|                 | 20175/1732.5               | H            | 1#2 | 0     | -32.32                   | 23.56         | 30             | Pass       |
|                 | 20393/1754.3               | H            | 1#5 | 0     | -32.45                   | 23.37         | 30             | Pass       |
| 3MHz<br>16QAM   | 19965/1711.5               | H            | 1#0 | 0     | -31.79                   | 23.98         | 30             | Pass       |
|                 | 20175/1732.5               | H            | 1#5 | 0     | -32.53                   | 23.35         | 30             | Pass       |
|                 | 20385/1753.5               | H            | 1#5 | 1     | -32.54                   | 23.29         | 30             | Pass       |
| 5MHz<br>16QAM   | 19975/1712.5               | H            | 1#0 | 0     | -31.83                   | 23.95         | 30             | Pass       |
|                 | 20175/1732.5               | H            | 1#5 | 1     | -32.40                   | 23.48         | 30             | Pass       |
|                 | 20375/1752.5               | H            | 1#5 | 3     | -32.33                   | 23.51         | 30             | Pass       |
| 10MHz<br>16QAM  | 20000/1715                 | H            | 4#0 | 0     | -31.93                   | 23.84         | 30             | Pass       |
|                 | 20175/1732.5               | H            | 4#2 | 3     | -32.47                   | 23.41         | 30             | Pass       |
|                 | 20350/1750                 | H            | 4#2 | 7     | -32.40                   | 23.38         | 30             | Pass       |
| 15MHz<br>16QAM  | 20025/1717.5               | H            | 1#0 | 0     | -31.96                   | 23.87         | 30             | Pass       |
|                 | 20175/1732.5               | H            | 1#5 | 5     | -32.29                   | 23.59         | 30             | Pass       |
|                 | 20325/1747.5               | H            | 1#5 | 11    | -32.45                   | 23.38         | 30             | Pass       |

| 20MHz<br>16QAM  | 20050/1720                 | H            | 6#0 | 0     | -31.79                   | 24.07        | 30             | Pass       |
|-----------------|----------------------------|--------------|-----|-------|--------------------------|--------------|----------------|------------|
|                 | 20175/1732.5               | H            | 6#0 | 7     | -32.20                   | 23.68        | 30             | Pass       |
|                 | 20300/1745                 | H            | 6#0 | 15    | -32.32                   | 23.54        | 30             | Pass       |
| LTE Band 12     |                            |              |     |       |                          |              |                |            |
| Bandwidth       | Channel/<br>Frequency(MHz) | Polarization | RB  | Index | Output<br>power<br>(dBm) | ERP<br>(dBm) | Limit<br>(dBm) | Conclusion |
| 1.4MHz<br>QPSK  | 23017/699.7                | H            | 1#0 | 0     | -28.07                   | 20.94        | 34.77          | Pass       |
|                 | 23095/707.5                | H            | 1#2 | 0     | -29.22                   | 20.06        | 34.77          | Pass       |
|                 | 23173/715.3                | H            | 1#5 | 0     | -30.46                   | 19.14        | 34.77          | Pass       |
| 3MHz<br>QPSK    | 23025/700.5                | H            | 1#0 | 0     | -28.00                   | 21.04        | 34.77          | Pass       |
|                 | 23095/707.5                | H            | 1#5 | 0     | -29.32                   | 19.96        | 34.77          | Pass       |
|                 | 23165/714.5                | H            | 1#5 | 1     | -30.22                   | 19.36        | 34.77          | Pass       |
| 5MHz<br>QPSK    | 23035/701.5                | H            | 1#0 | 0     | -28.10                   | 20.97        | 34.77          | Pass       |
|                 | 23095/707.5                | H            | 1#5 | 1     | -29.38                   | 19.90        | 34.77          | Pass       |
|                 | 23155/713.5                | H            | 1#5 | 3     | -30.25                   | 19.32        | 34.77          | Pass       |
| 10MHz<br>QPSK   | 23060/704                  | H            | 4#0 | 0     | -28.15                   | 20.99        | 34.77          | Pass       |
|                 | 23095/707.5                | H            | 4#2 | 3     | -29.35                   | 19.93        | 34.77          | Pass       |
|                 | 23130/711                  | H            | 4#2 | 7     | -30.33                   | 19.19        | 34.77          | Pass       |
| 1.4MHz<br>16QAM | 23017/699.7                | H            | 1#0 | 0     | -28.55                   | 20.46        | 34.77          | Pass       |
|                 | 23095/707.5                | H            | 1#2 | 0     | -29.60                   | 19.68        | 34.77          | Pass       |
|                 | 23173/715.3                | H            | 1#5 | 0     | -30.99                   | 18.61        | 34.77          | Pass       |
| 3MHz<br>16QAM   | 23025/700.5                | H            | 1#0 | 0     | -28.51                   | 20.53        | 34.77          | Pass       |
|                 | 23095/707.5                | H            | 1#5 | 0     | -28.90                   | 20.38        | 34.77          | Pass       |
|                 | 23165/714.5                | H            | 1#5 | 1     | -30.71                   | 18.87        | 34.77          | Pass       |
| 5MHz<br>16QAM   | 23035/701.5                | H            | 1#0 | 0     | -28.54                   | 20.53        | 34.77          | Pass       |
|                 | 23095/707.5                | H            | 1#5 | 1     | -29.97                   | 19.31        | 34.77          | Pass       |
|                 | 23155/713.5                | H            | 1#5 | 3     | -31.75                   | 17.82        | 34.77          | Pass       |
| 10MHz<br>16QAM  | 23060/704                  | H            | 4#0 | 0     | -28.80                   | 20.34        | 34.77          | Pass       |
|                 | 23095/707.5                | H            | 4#2 | 3     | -30.05                   | 19.23        | 34.77          | Pass       |
|                 | 23130/711                  | H            | 4#2 | 7     | -30.76                   | 18.76        | 34.77          | Pass       |
| LTE Band 13     |                            |              |     |       |                          |              |                |            |
| Bandwidth       | Channel/<br>Frequency(MHz) | Polarization | RB  | Index | Output<br>power<br>(dBm) | ERP<br>(dBm) | Limit<br>(dBm) | Conclusion |
| 5MHz<br>QPSK    | 23205/779.5                | H            | 1#0 | 0     | -28.78                   | 17.89        | 34.77          | Pass       |
|                 | 23230/782                  | H            | 1#5 | 1     | -29.08                   | 17.75        | 34.77          | Pass       |
|                 | 23255/784.5                | H            | 1#5 | 3     | -29.31                   | 17.96        | 34.77          | Pass       |
| 10MHz<br>QPSK   | 23230/782                  | H            | 4#2 | 3     | -28.43                   | 17.98        | 34.77          | Pass       |
| 5MHz            | 23205/779.5                | H            | 1#0 | 0     | -27.31                   | 19.36        | 34.77          | Pass       |





|                |             |   |     |   |        |       |       |      |
|----------------|-------------|---|-----|---|--------|-------|-------|------|
| 16QAM          | 23230/782   | H | 1#5 | 1 | -29.54 | 17.29 | 34.77 | Pass |
|                | 23255/784.5 | H | 1#5 | 3 | -29.73 | 17.54 | 34.77 | Pass |
| 10MHz<br>16QAM | 23230/782   | H | 4#2 | 3 | -29.07 | 17.34 | 34.77 | Pass |

### 5.3 Occupied Bandwidth

#### Ambient condition

|             |                   |          |
|-------------|-------------------|----------|
| Temperature | Relative humidity | Pressure |
| 23°C ~25°C  | 45%~50%           | 101.5kPa |

#### Method of Measurement

The EUT was connected to Spectrum Analyzer and Base Station Simulator via power Splitter. The occupied bandwidth is measured using spectrum analyzer.

RBW is set to 51kHz, VBW is set to 160kHz for LTE Band 4/12/13

99% power and -26dBc occupied bandwidths are recorded. Spectrum analyzer plots are included on the following pages.

#### Test Setup

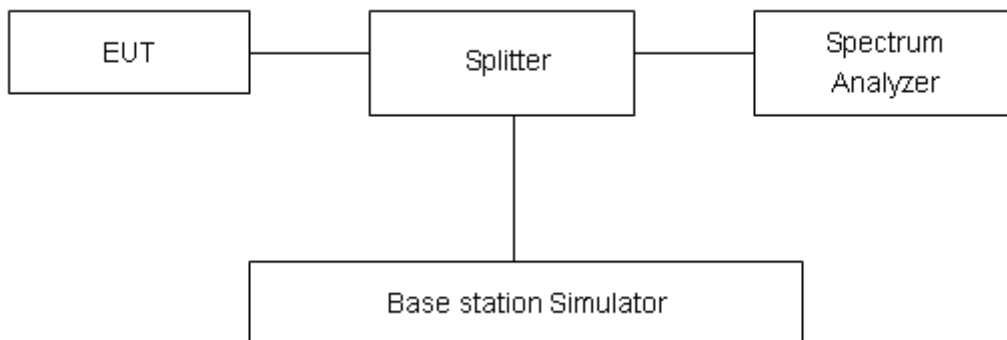

#### Limits

No specific occupied bandwidth requirements in part 2.1049.

#### Measurement Uncertainty

The assessed measurement uncertainty to ensure 95% confidence level for the normal distribution is with the coverage factor  $k = 2$ ,  $U=624\text{Hz}$ .

**Test Result**

| Mode          | Bandwidth | Modulation   | Channel/<br>Frequency(MHz) | RB  | Index  | Bandwidth(MHz) |        |
|---------------|-----------|--------------|----------------------------|-----|--------|----------------|--------|
|               |           |              |                            |     |        | 99% Power      | -26dBc |
| LTE<br>Band 4 | 1.4MHz    | QPSK         | 20175/1732.5               | 6#0 | 0      | 1.1098         | 1.375  |
|               |           | 16QAM        | 20175/1732.5               | 6#0 | 0      | 0.9495         | 1.363  |
|               | 3MHz      | QPSK         | 20175/1732.5               | 6#0 | 0      | 1.1484         | 1.654  |
|               |           | 16QAM        | 20175/1732.5               | 6#0 | 0      | 0.9682         | 1.313  |
|               | 5MHz      | QPSK         | 20175/1732.5               | 6#0 | 0      | 1.1419         | 1.747  |
|               |           | 16QAM        | 20175/1732.5               | 6#0 | 0      | 0.9879         | 1.429  |
|               | 10MHz     | QPSK         | 20175/1732.5               | 6#0 | 0      | 1.1821         | 1.830  |
|               |           | 16QAM        | 20175/1732.5               | 6#0 | 0      | 1.0386         | 1.575  |
|               | 15MHz     | QPSK         | 20175/1732.5               | 6#0 | 0      | 1.2017         | 1.898  |
|               |           | 16QAM        | 20175/1732.5               | 6#0 | 0      | 1.0558         | 1.732  |
| 20MHz         | QPSK      | 20175/1732.5 | 6#0                        | 0   | 1.2002 | 1.809          |        |
|               | 16QAM     | 20175/1732.5 | 6#0                        | 0   | 1.0830 | 1.956          |        |

| Mode           | Bandwidth | Modulation | Channel/<br>Frequency(MHz) | RB  | Index | Bandwidth(MHz) |        |
|----------------|-----------|------------|----------------------------|-----|-------|----------------|--------|
|                |           |            |                            |     |       | 99% Power      | -26dBc |
| LTE<br>Band 12 | 1.4MHz    | QPSK       | 23095/707.5                | 6#0 | 0     | 1.1074         | 1.315  |
|                |           | 16QAM      | 23095/707.5                | 6#0 | 0     | 0.9459         | 1.298  |
|                | 3MHz      | QPSK       | 23095/707.5                | 6#0 | 0     | 1.1321         | 1.576  |
|                |           | 16QAM      | 23095/707.5                | 6#0 | 0     | 0.9769         | 1.360  |
|                | 5MHz      | QPSK       | 23095/707.5                | 6#0 | 0     | 1.1330         | 1.567  |
|                |           | 16QAM      | 23095/707.5                | 6#0 | 0     | 0.9780         | 1.331  |
|                | 10MHz     | QPSK       | 23095/707.5                | 6#0 | 0     | 1.1827         | 1.725  |
|                |           | 16QAM      | 23095/707.5                | 6#0 | 0     | 1.0201         | 1.504  |

| Mode           | Bandwidth | Modulation | Channel/<br>Frequency(MHz) | RB  | Index | Bandwidth(MHz) |        |
|----------------|-----------|------------|----------------------------|-----|-------|----------------|--------|
|                |           |            |                            |     |       | 99% Power      | -26dBc |
| LTE<br>Band 13 | 5MHz      | QPSK       | 23230/782                  | 6#0 | 0     | 1.1381         | 1.548  |
|                |           | 16QAM      | 23230/782                  | 6#0 | 0     | 0.9788         | 1.358  |
|                | 10MHz     | QPSK       | 23230/782                  | 6#0 | 0     | 1.1748         | 1.722  |
|                |           | 16QAM      | 23230/782                  | 6#0 | 0     | 1.0299         | 1.538  |

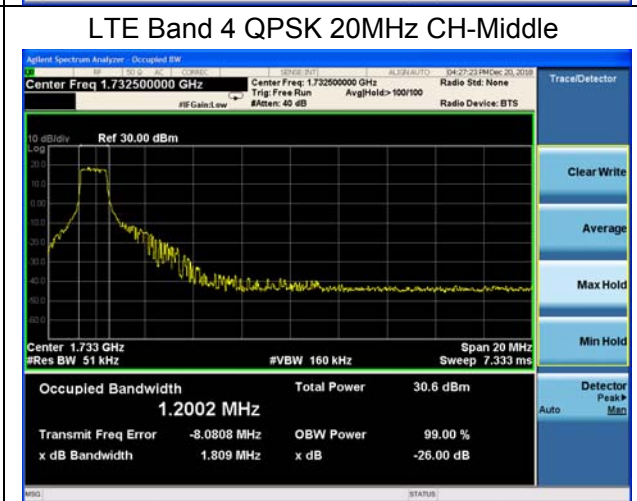
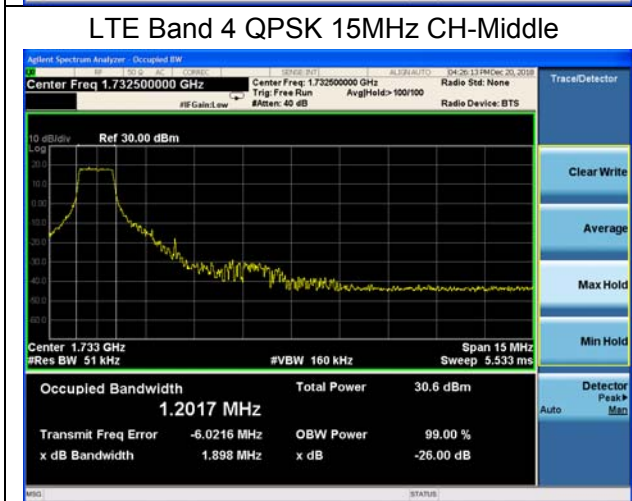
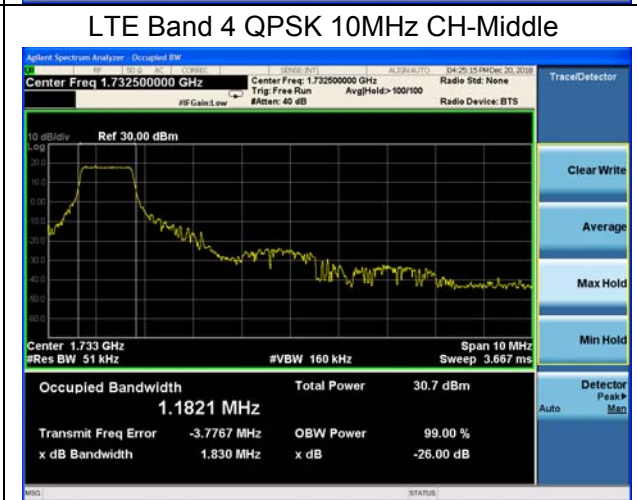
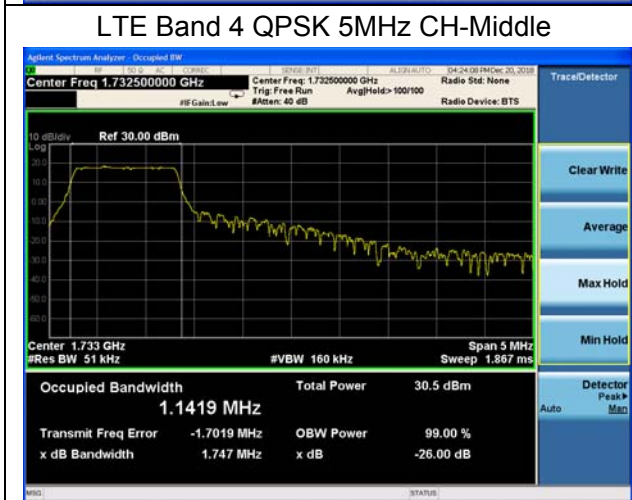
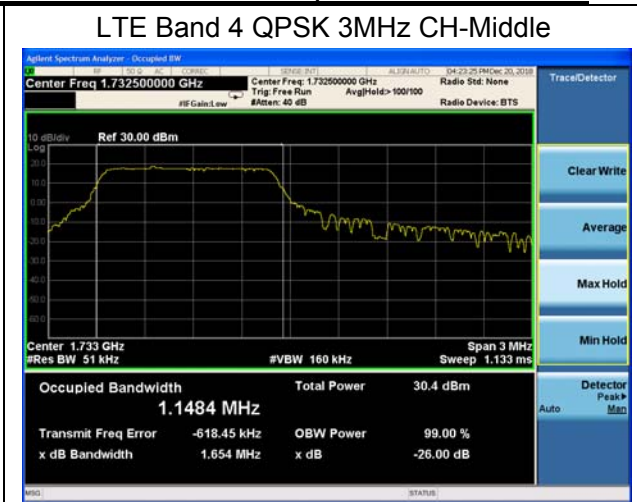
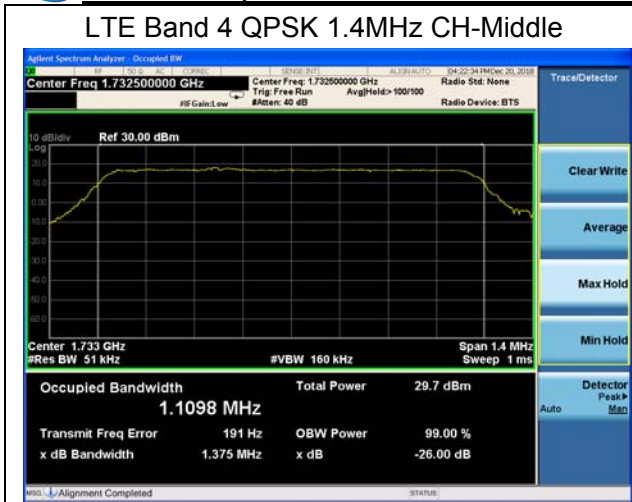

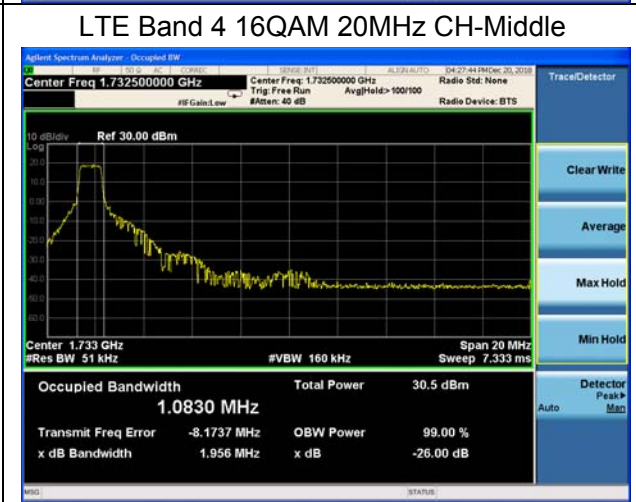
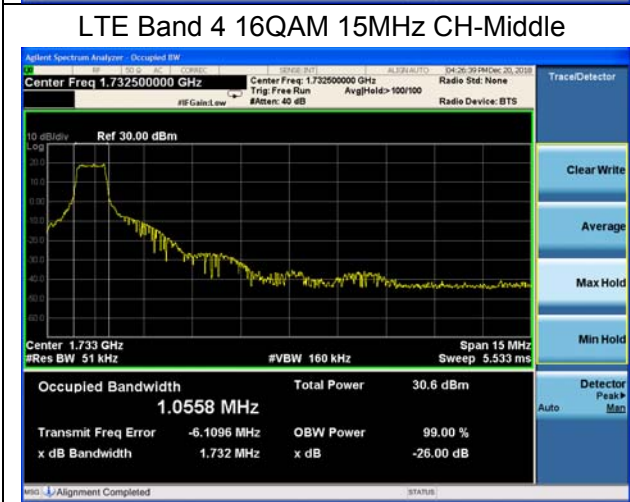
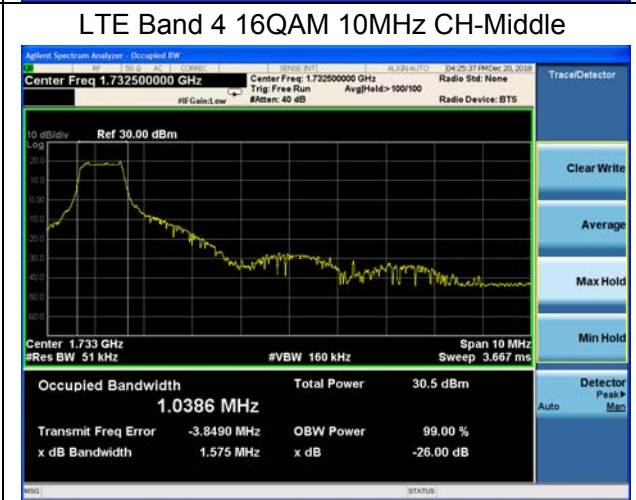
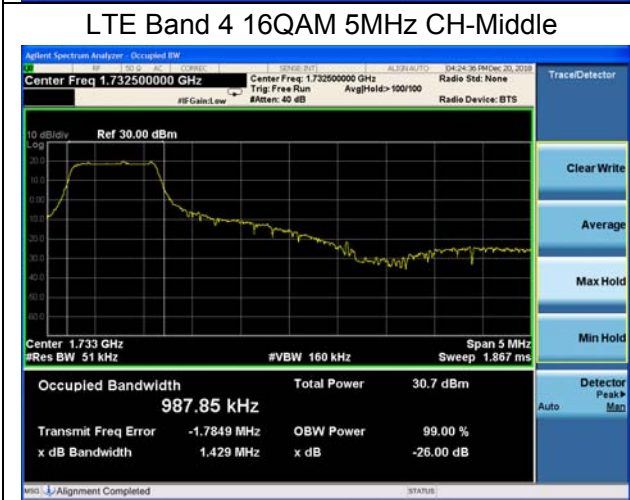
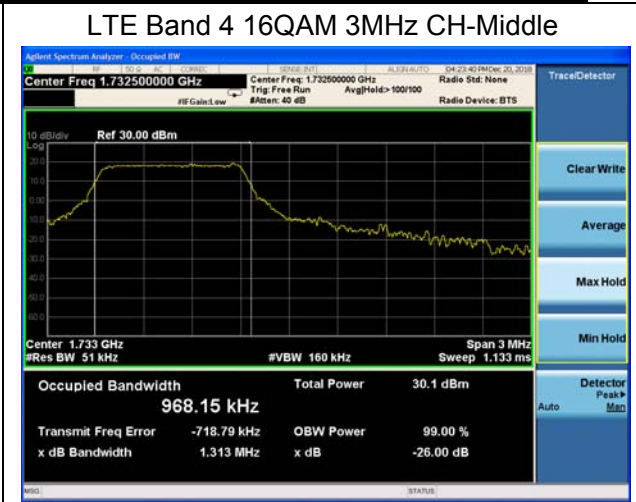
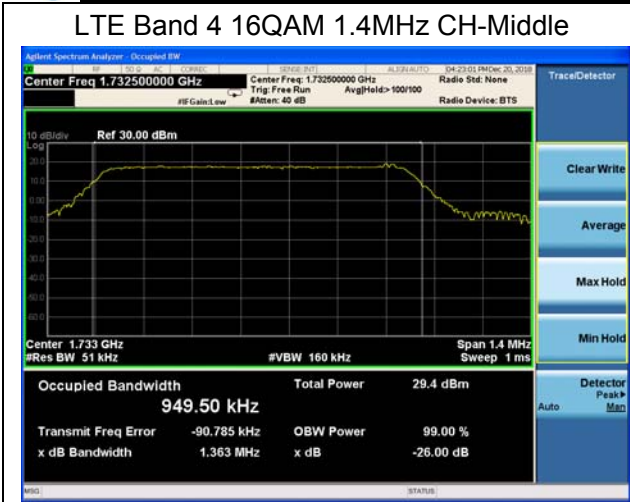



LTE Band 12 QPSK 1.4MHz CH-Middle



LTE Band 12 QPSK 3MHz CH-Middle

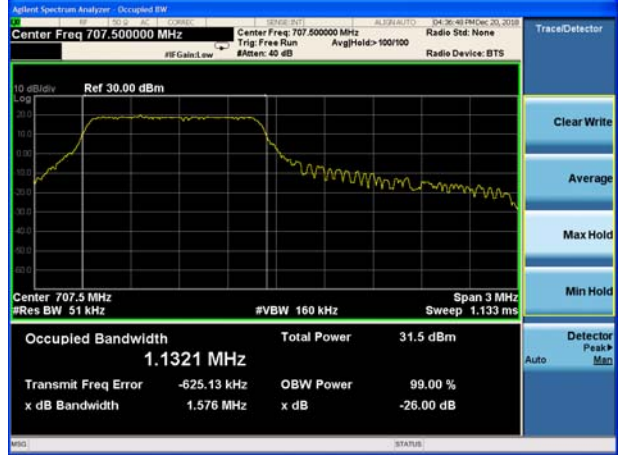

LTE Band 12 QPSK 5MHz CH-Middle



LTE Band 12 QPSK 10MHz CH-Middle

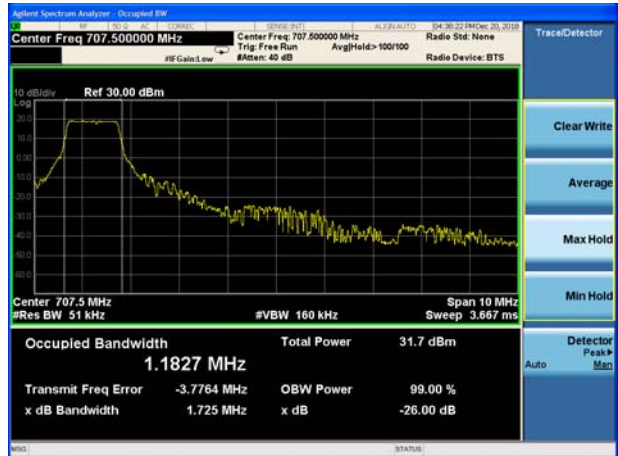

LTE Band 12 16QAM 1.4MHz CH-Middle



LTE Band 12 16QAM 3MHz CH-Middle





LTE Band 12 16QAM 5MHz CH-Middle



LTE Band 12 16QAM 10MHz CH-Middle



LTE Band 13 QPSK 5MHz CH-Middle

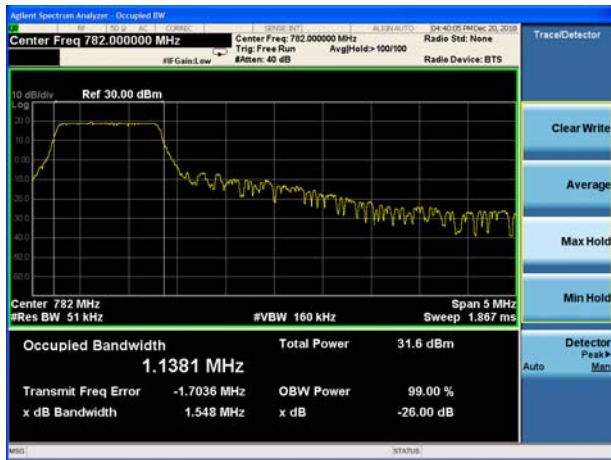

LTE Band 13 QPSK 10MHz CH-Middle



LTE Band 13 16QAM 5MHz CH-Middle



LTE Band 13 16QAM 10MHz CH-Middle

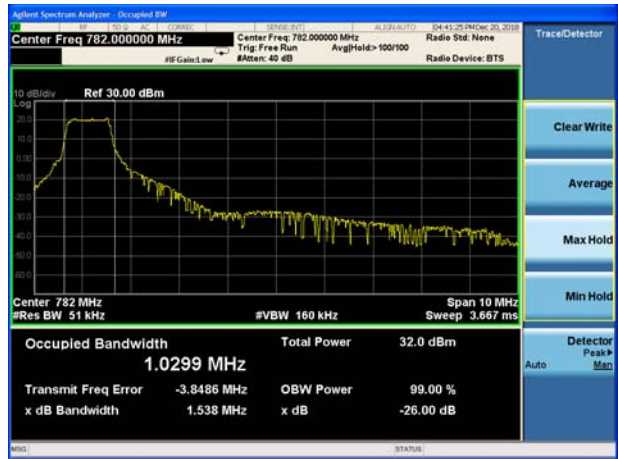

## 5.4 Band Edge Compliance

### Ambient condition

| Temperature | Relative humidity | Pressure |
|-------------|-------------------|----------|
| 23°C ~25°C  | 45%~50%           | 101.5kPa |

### Method of Measurement

The EUT was connected to Spectrum Analyzer and Base Station Simulator via power Splitter. The band edge of the lowest and highest channels were measured.

The testing follows KDB 971168 D01 v03r01 Section 6.0

1. The EUT was connected to spectrum analyzer and system simulator via a power divider.
2. The band edges of low and high channels for the highest RF powers were measured.
3. RBW is set to 51 kHz, VBW is set to 160 kHz for LTE Band 4/12/13 on spectrum analyzer.
4. Set spectrum analyzer with RMS detector.
5. The RF fundamental frequency should be excluded against the limit line in the operating frequency band.
6. Checked that all the results comply with the emission limit line.

### Test Setup

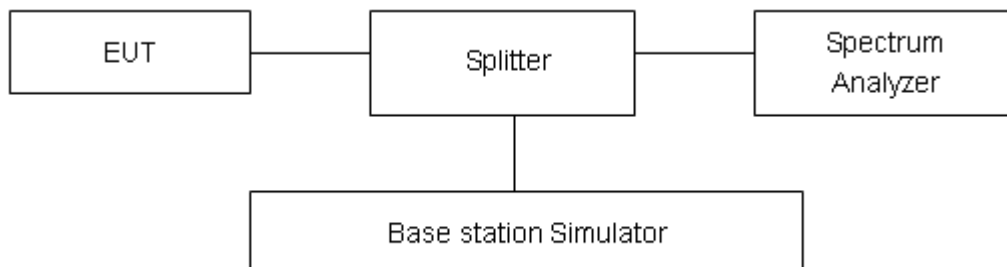

### Limits

Rule Part 27.53(h) specifies that “ for operations in the 1695-1710 MHz, 1710-1755 MHz, 1755-1780 MHz, 1915-1920 MHz, 1995-2000 MHz, 2000-2020 MHz, 2110-2155 MHz, 2155-2180 MHz, and 2180-2200 bands, the power of any emission outside a licensee's frequency block shall be attenuated below the transmitter power (P) in watts by at least  $43 + 10 \log_{10} (P)$  dB”

Part 27.53(g) For operations in the 600 MHz band and the 698-746 MHz band, the power of any emission outside a licensee's frequency band(s) of operation shall be attenuated below the transmitter power (P) within the licensed band(s) of operation, measured in watts, by at least  $43 + 10 \log (P)$  dB. Compliance with this provision is based on the use of measurement instrumentation employing a resolution bandwidth of 100 kilohertz or greater. However, in the 100 kilohertz bands immediately outside and adjacent to a licensee's frequency block, a resolution bandwidth of at least 30 kHz may be employed.





Rule Part 27.53(f) For operations in the 746-758 MHz, 775-788 MHz, and 805-806 MHz bands, emissions in the band 1559-1610 MHz shall be limited to  $-70$  dBW/MHz equivalent isotropically radiated power (EIRP) for wideband signals, and  $-80$  dBW EIRP for discrete emissions of less than 700 Hz bandwidth. For the purpose of equipment authorization, a transmitter shall be tested with an antenna that is representative of the type that will be used with the equipment in normal operation.

### Measurement Uncertainty

The assessed measurement uncertainty to ensure 95% confidence level for the normal distribution is with the coverage factor  $k = 1.96$ ,  $U=0.684$ dB.

**Test Result**

All the test traces in the plots shows the test results clearly.

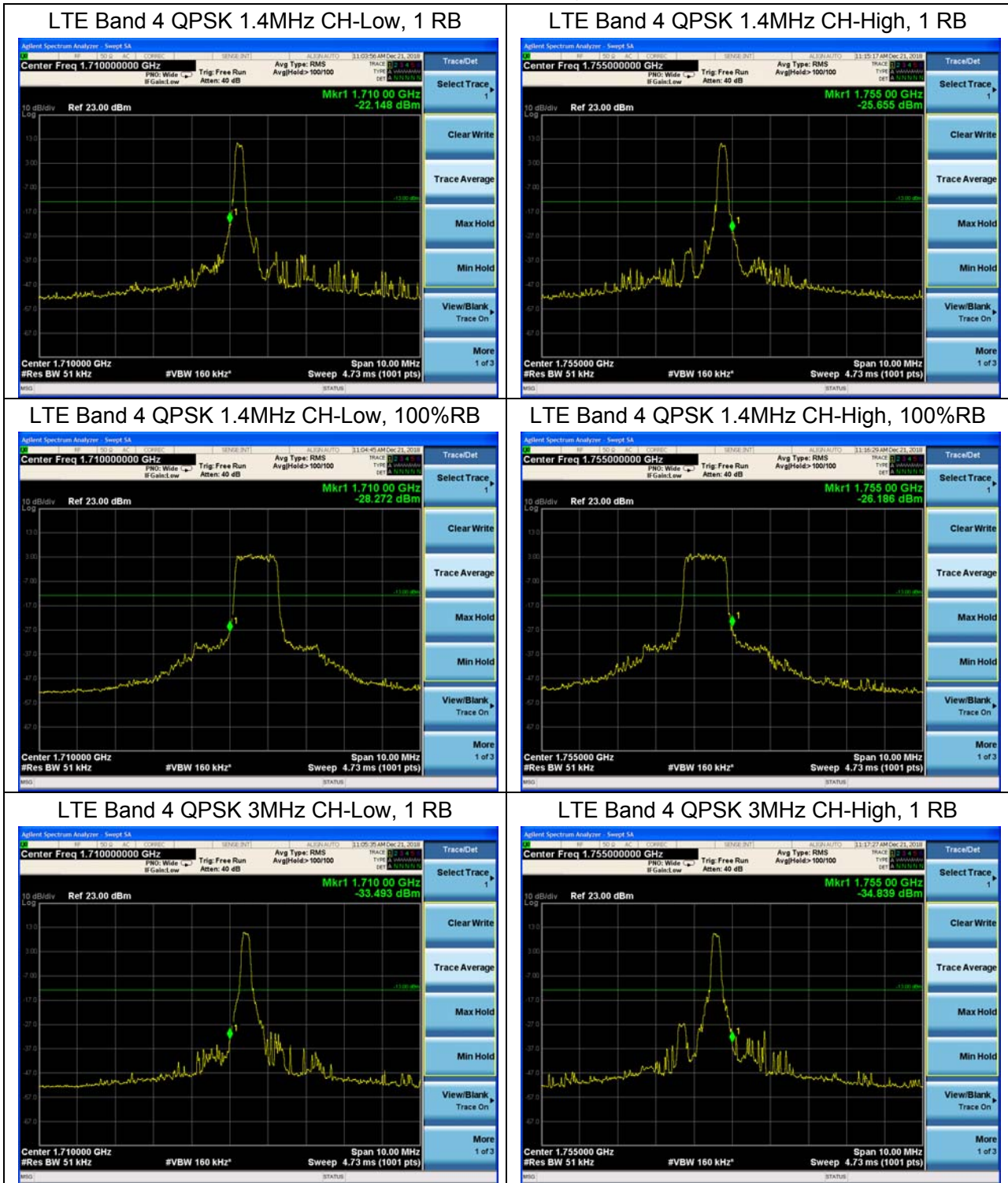



LTE Band 4 QPSK 3MHz CH-Low, 100%RB



LTE Band 4 QPSK 3MHz CH-High, 100%RB

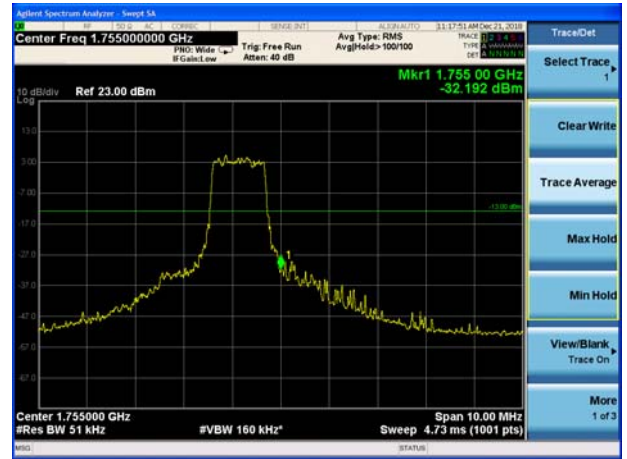

LTE Band 4 QPSK 5MHz CH-Low, 1 RB



LTE Band 4 QPSK 5MHz CH-High, 1 RB



LTE Band 4 QPSK 5MHz CH-Low, 100%RB



LTE Band 4 QPSK 5MHz CH-High, 100%RB





LTE Band 4 QPSK 10MHz CH-Low, 1 RB

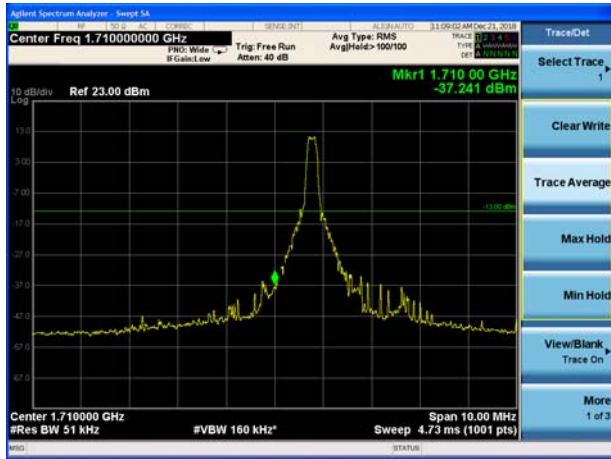

LTE Band 4 QPSK 10MHz CH-High, 1 RB

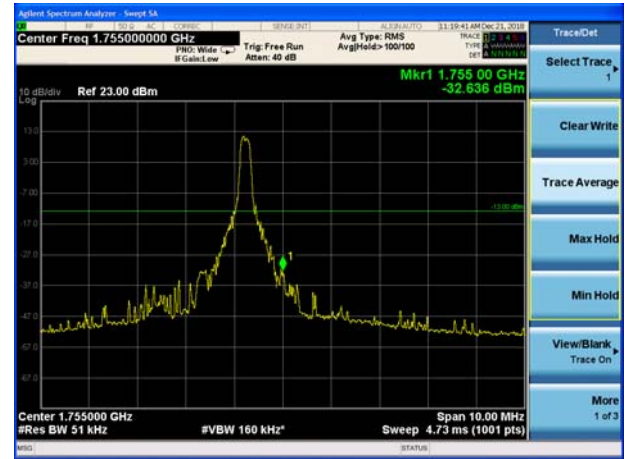

LTE Band 4 QPSK 10MHz CH-Low, 100%RB



LTE Band 4 QPSK 10MHz CH-High, 100%RB

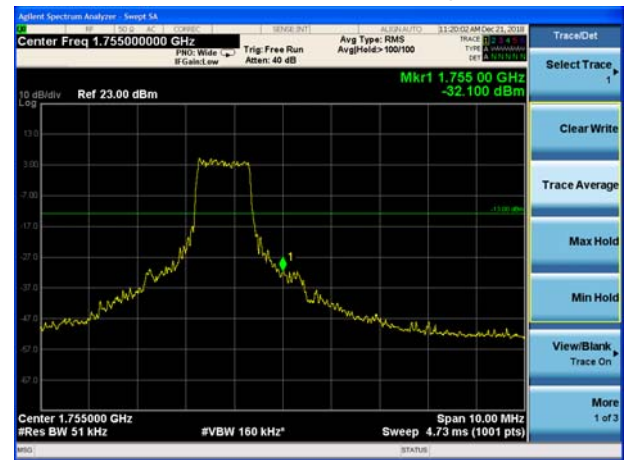

LTE Band 4 QPSK 15MHz CH-Low, 1 RB

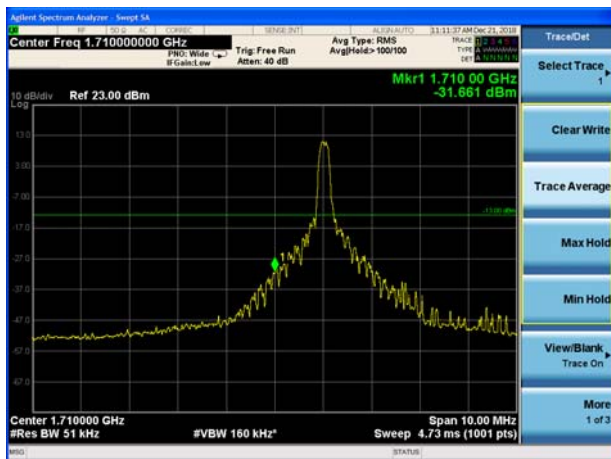

LTE Band 4 QPSK 15MHz CH-High, 1 RB

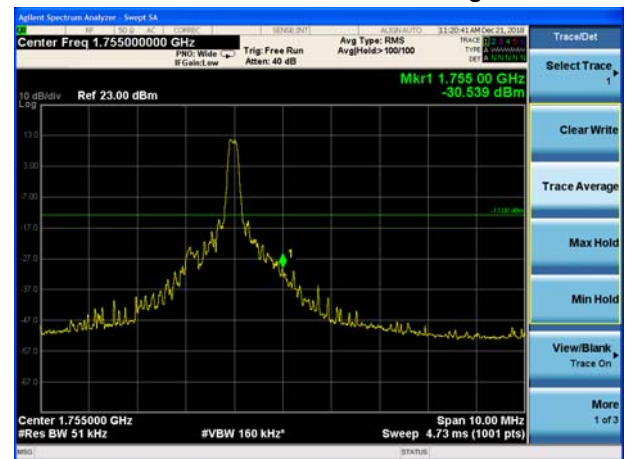



LTE Band 4 QPSK 15MHz CH-Low, 100%RB



LTE Band 4 QPSK 15MHz CH-High, 100%RB

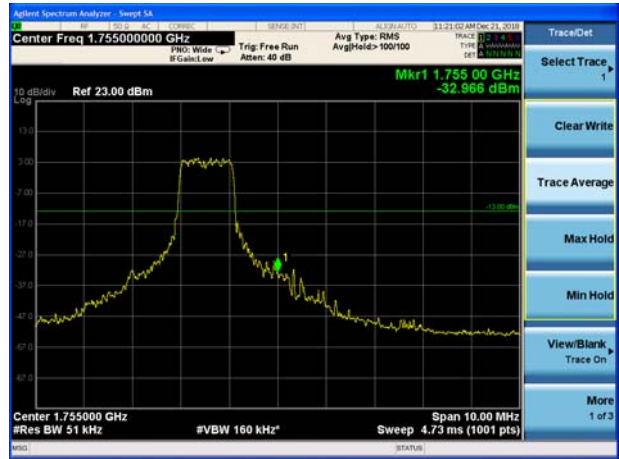

LTE Band 4 QPSK 20MHz CH-Low, 1 RB

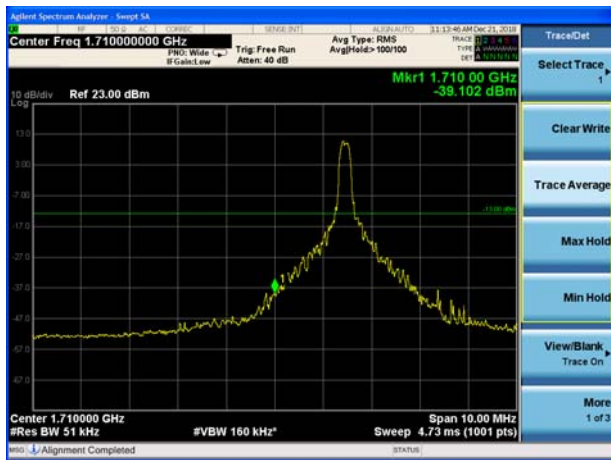

LTE Band 4 QPSK 20MHz CH-High, 1 RB

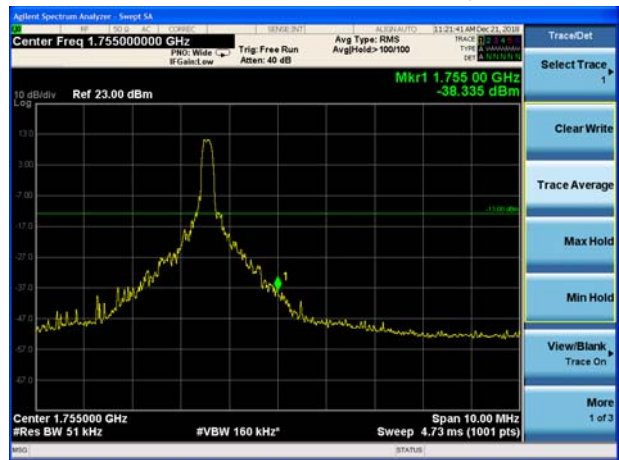

LTE Band 4 QPSK 20MHz CH-Low, 100%RB

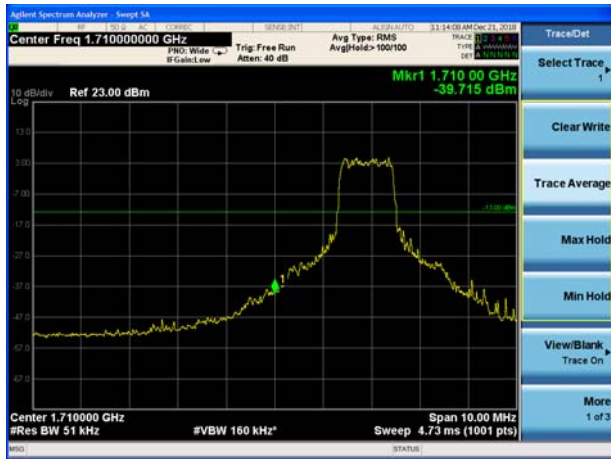

LTE Band 4 QPSK 20MHz CH-High, 100%RB





LTE Band 4 16QAM 1.4MHz CH-Low, 1 RB



LTE Band 4 16QAM 1.4MHz CH-High, 1 RB



LTE Band 4 16QAM 1.4MHz CH-Low, 100%RB

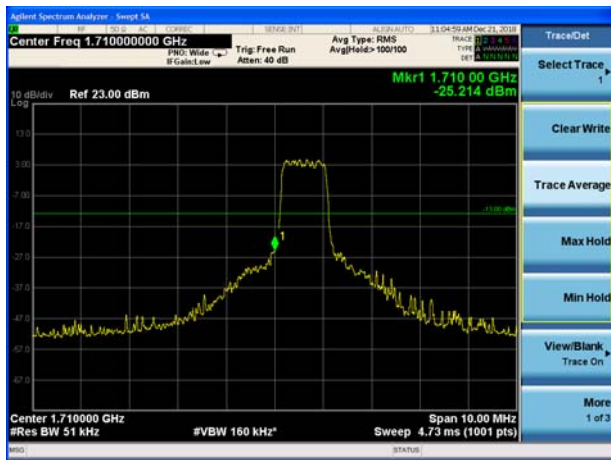

LTE Band 4 16QAM 1.4MHz CH-High, 100%RB

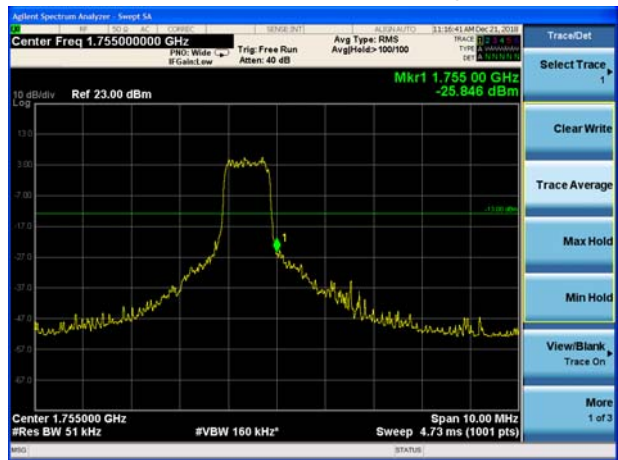

LTE Band 4 16QAM 3MHz CH-Low, 1 RB



LTE Band 4 16QAM 3MHz CH-High, 1 RB

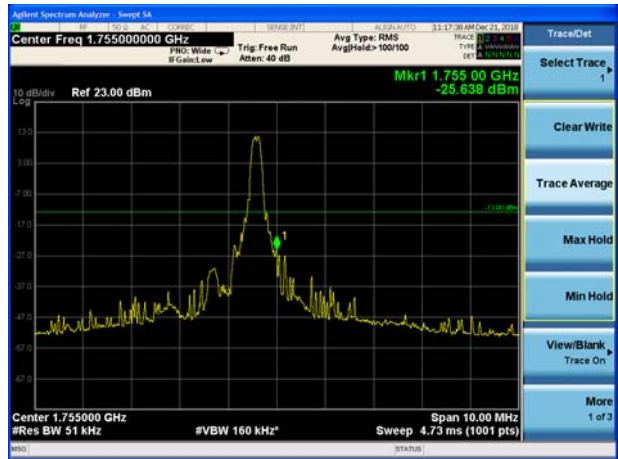



LTE Band 4 16QAM 3MHz CH-Low, 100%RB

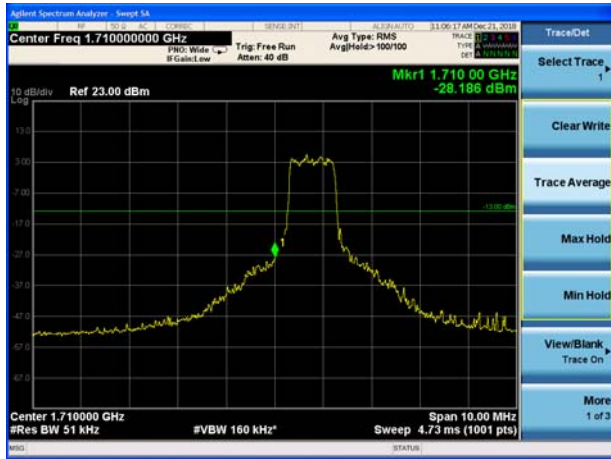

LTE Band 4 16QAM 3MHz CH-High, 100%RB

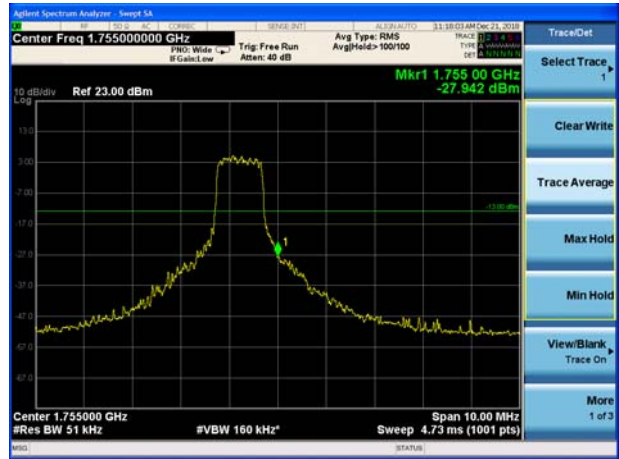

LTE Band 4 16QAM 5MHz CH-Low, 1 RB



LTE Band 4 16QAM 5MHz CH-High, 1 RB



LTE Band 4 16QAM 5MHz CH-Low, 100%RB



LTE Band 4 16QAM 5MHz CH-High, 100%RB





LTE Band 4 16QAM 10MHz CH-Low, 1 RB



LTE Band 4 16QAM 10MHz CH-High, 1 RB

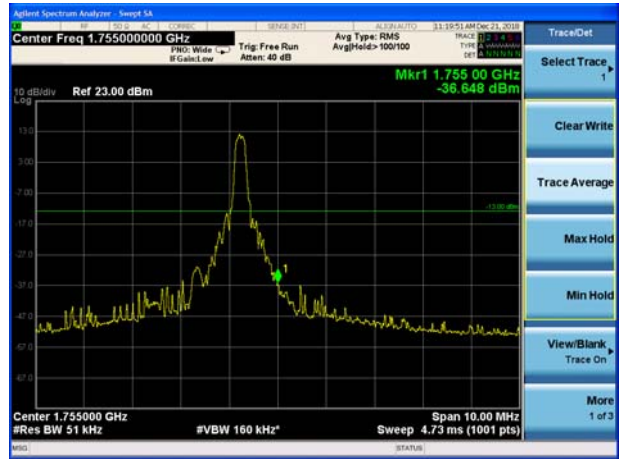

LTE Band 4 16QAM 10MHz CH-Low, 100%RB

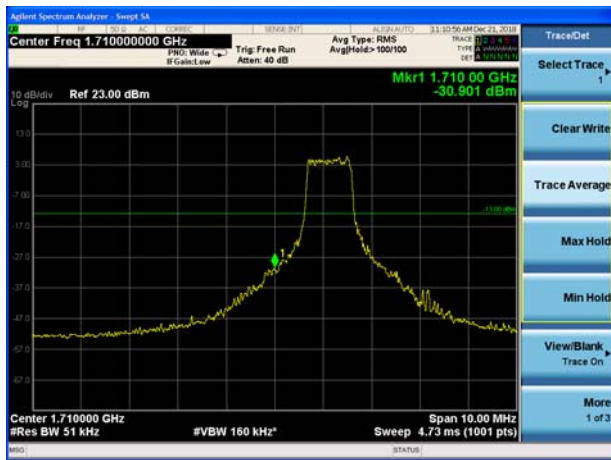

LTE Band 4 16QAM 10MHz CH-High, 100%RB



LTE Band 4 16QAM 15MHz CH-Low, 1 RB

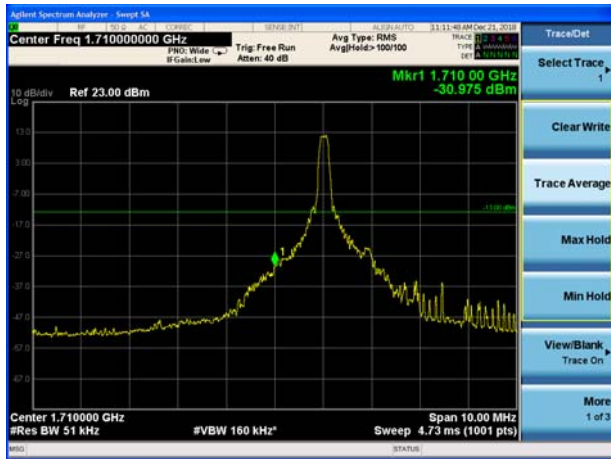

LTE Band 4 16QAM 15MHz CH-High, 1 RB

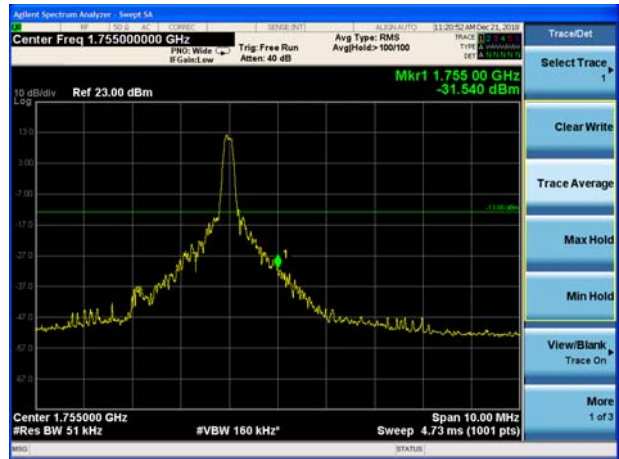





LTE Band 4 16QAM 15MHz CH-Low, 100%RB

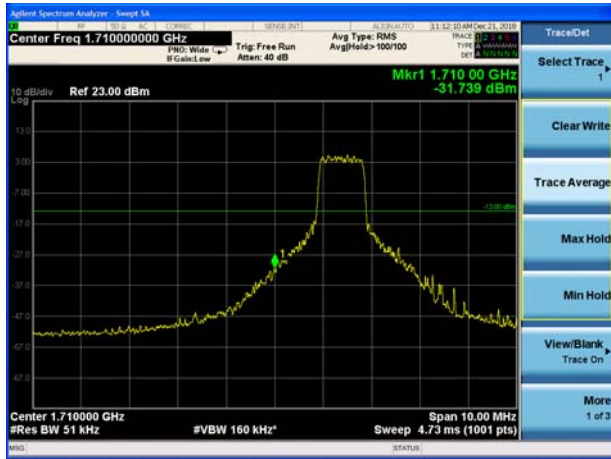

LTE Band 4 16QAM 15MHz CH-High, 100%RB

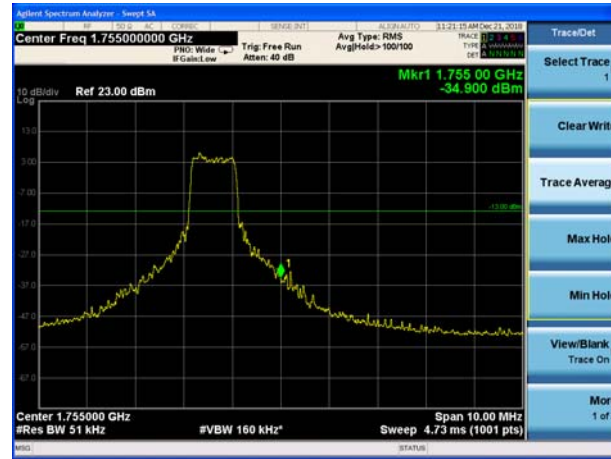

LTE Band 4 16QAM 20MHz CH-Low, 1 RB

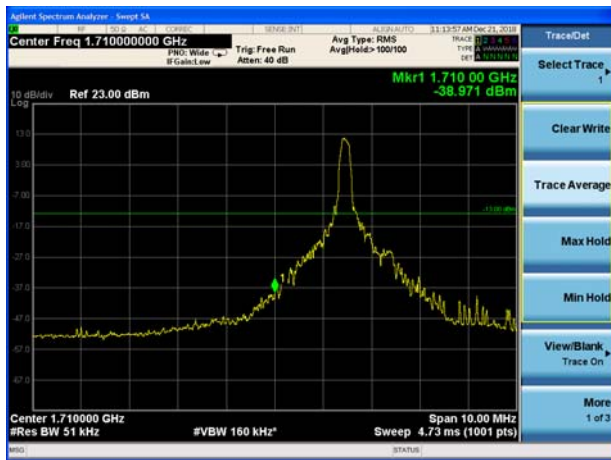

LTE Band 4 16QAM 20MHz CH-High, 1 RB

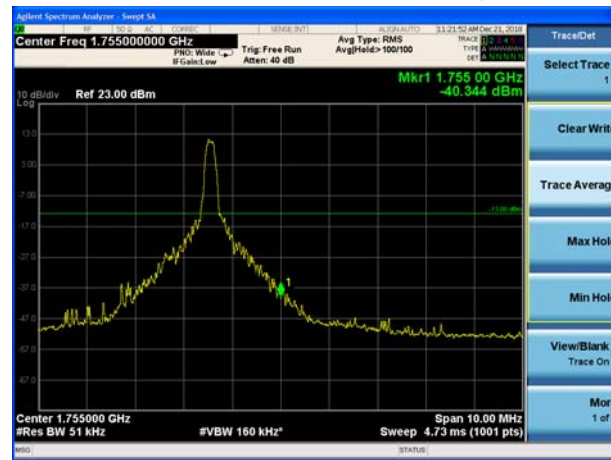

LTE Band 4 16QAM 20MHz CH-Low, 100%RB



LTE Band 4 16QAM 20MHz CH-High, 100%RB

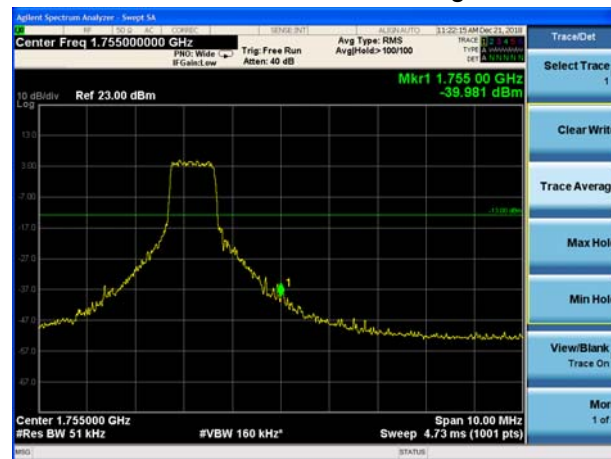

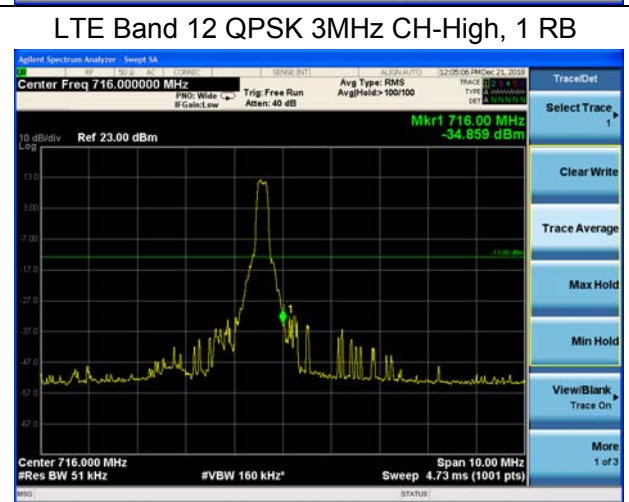
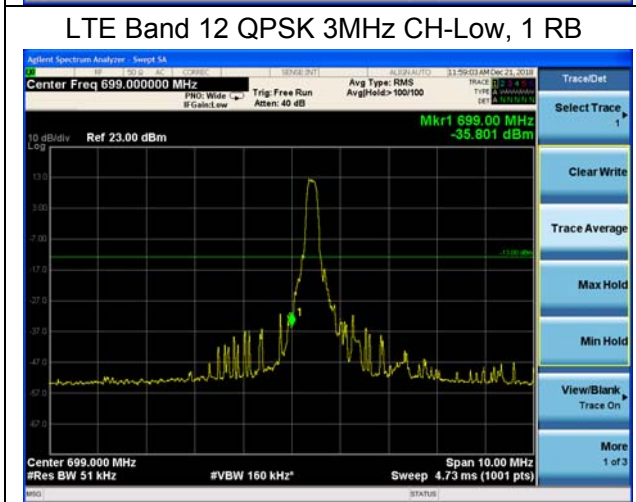
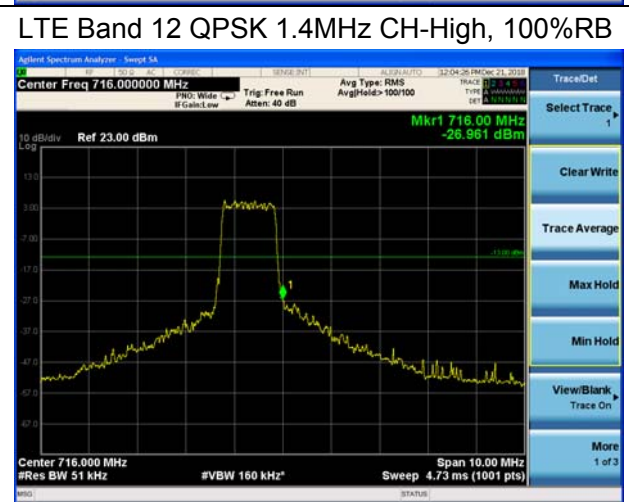
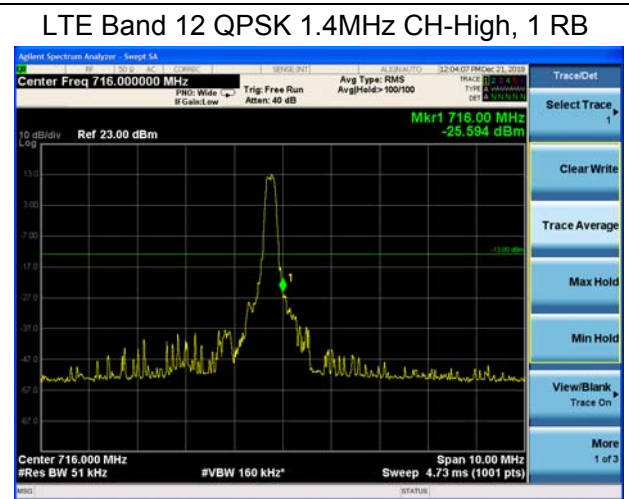
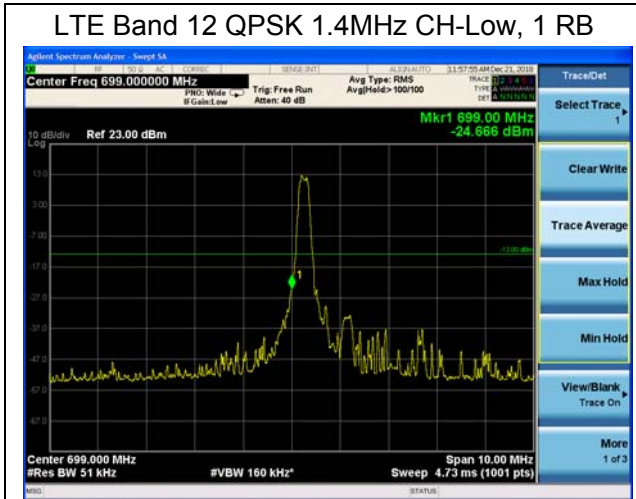



LTE Band 12 QPSK 3MHz CH-Low, 100%RB



LTE Band 12 QPSK 3MHz CH-High, 100%RB



LTE Band 12 QPSK 5MHz CH-Low, 1 RB

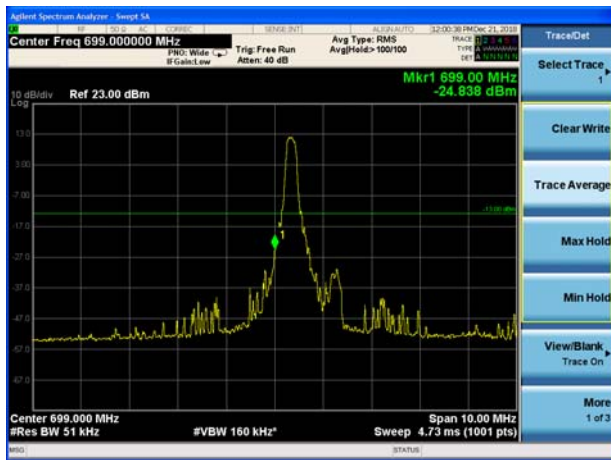

LTE Band 12 QPSK 5MHz CH-High, 1 RB

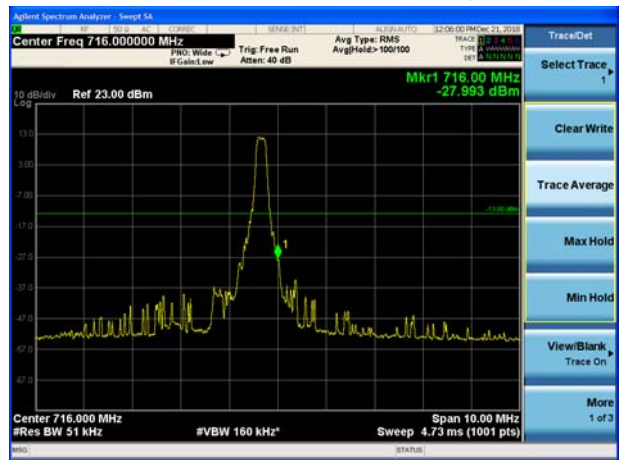

LTE Band 12 QPSK 5MHz CH-Low, 100%RB



LTE Band 12 QPSK 5MHz CH-High, 100%RB

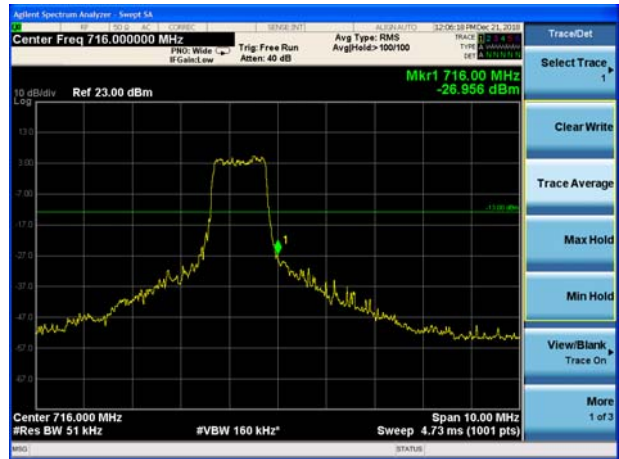



LTE Band 12 QPSK 10MHz CH-Low, 1 RB

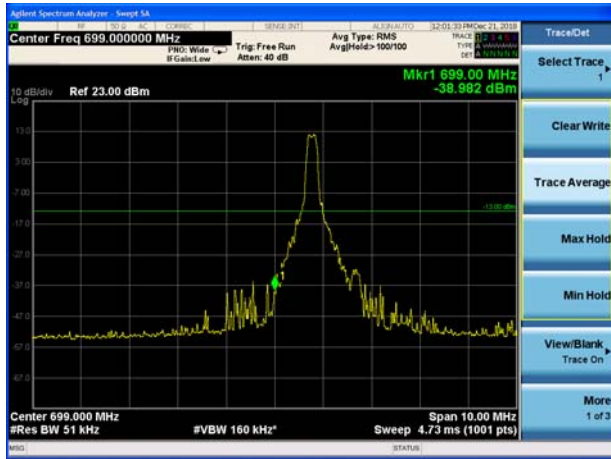

LTE Band 12 QPSK 10MHz CH-High, 1 RB

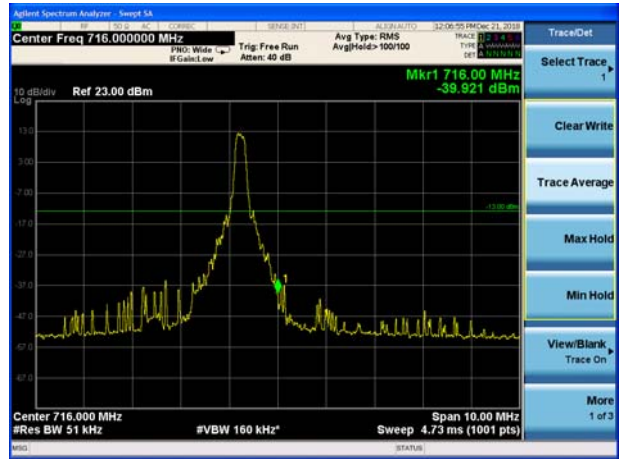

LTE Band 12 QPSK 10MHz CH-Low, 100%RB

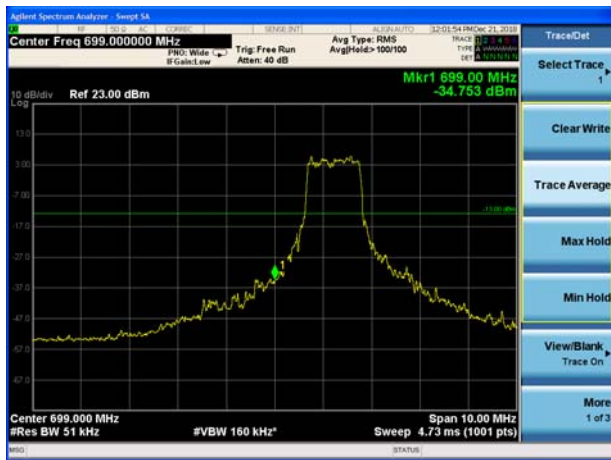

LTE Band 12 QPSK 10MHz CH-High, 100%RB

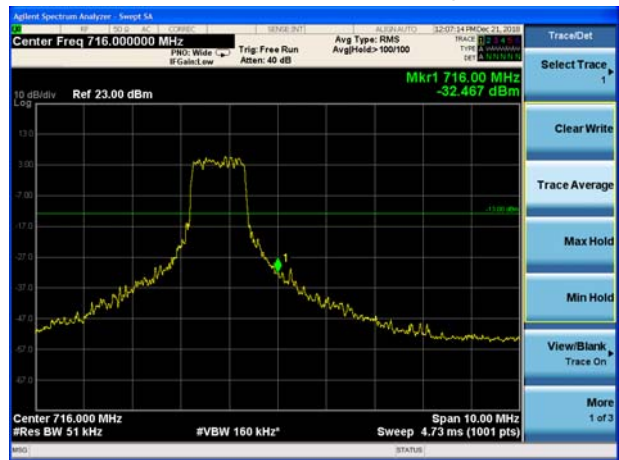

LTE Band 12 16QAM 1.4MHz CH-Low, 1 RB

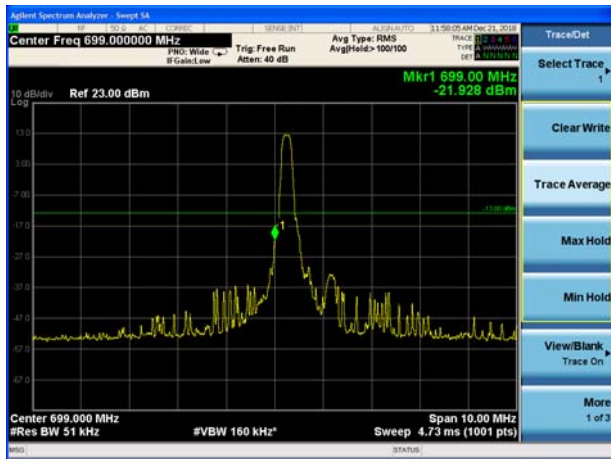

LTE Band 12 16QAM 1.4MHz CH-High, 1 RB

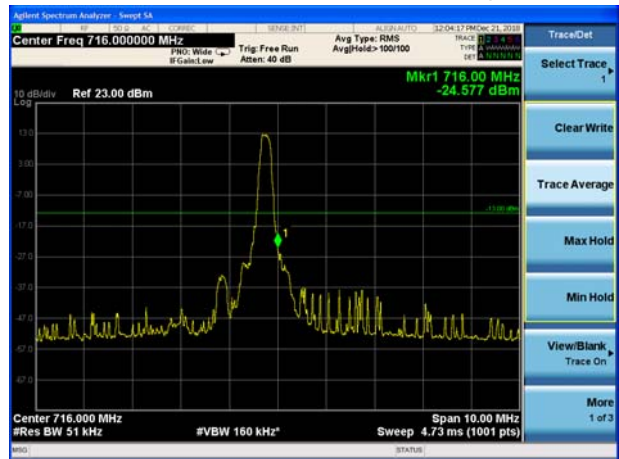



LTE Band 12 16QAM 1.4MHz CH-Low, 100%RB

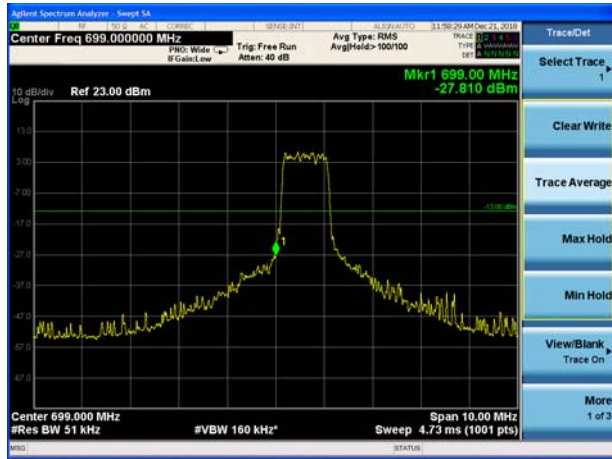

LTE Band 12 16QAM 1.4MHz CH-High, 100%RB

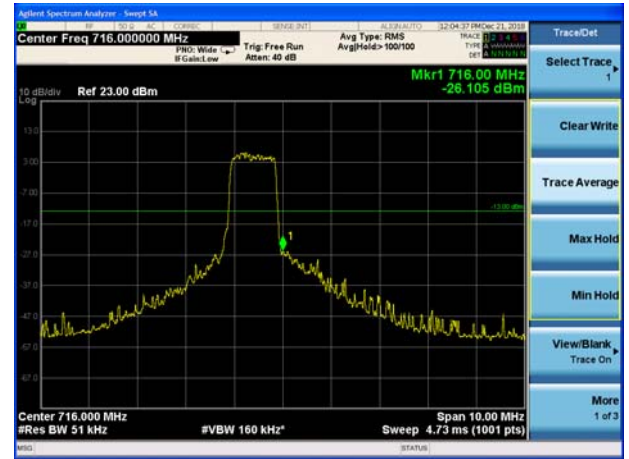

LTE Band 12 16QAM 3MHz CH-Low, 1 RB

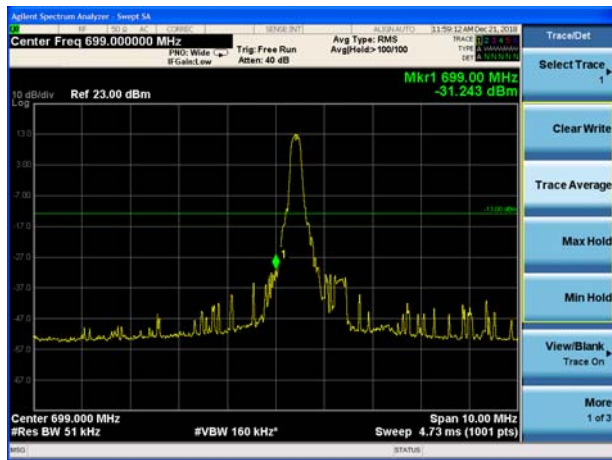

LTE Band 12 16QAM 3MHz CH-High, 1 RB



LTE Band 12 16QAM 3MHz CH-Low, 100%RB

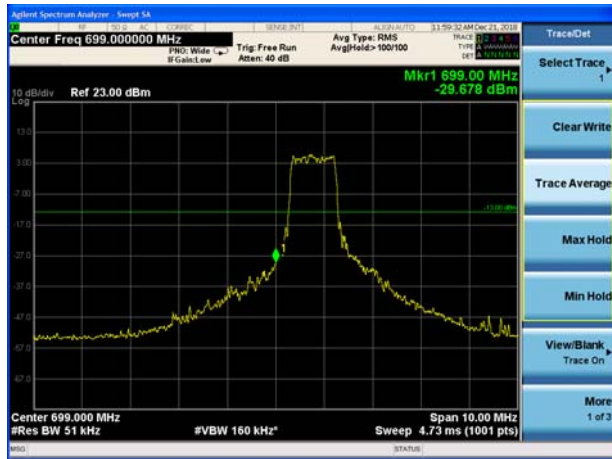

LTE Band 12 16QAM 3MHz CH-High, 100%RB

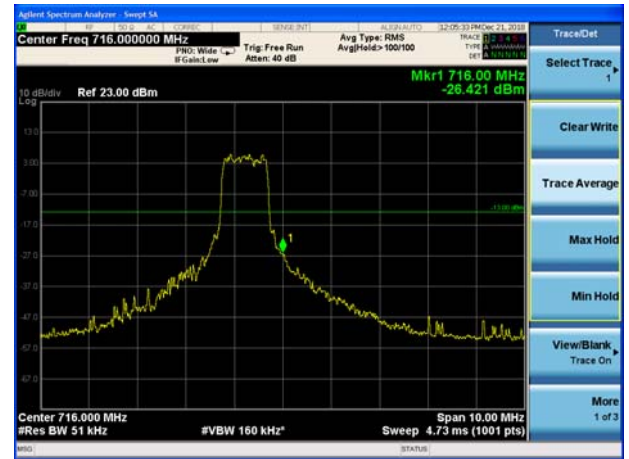



LTE Band 12 16QAM 5MHz CH-Low, 1 RB

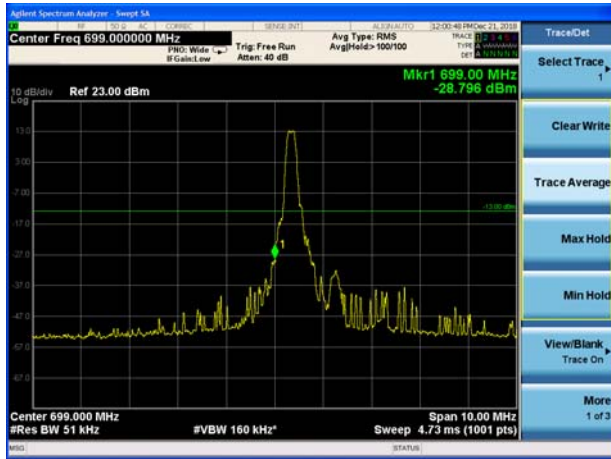

LTE Band 12 16QAM 5MHz CH-High, 1 RB

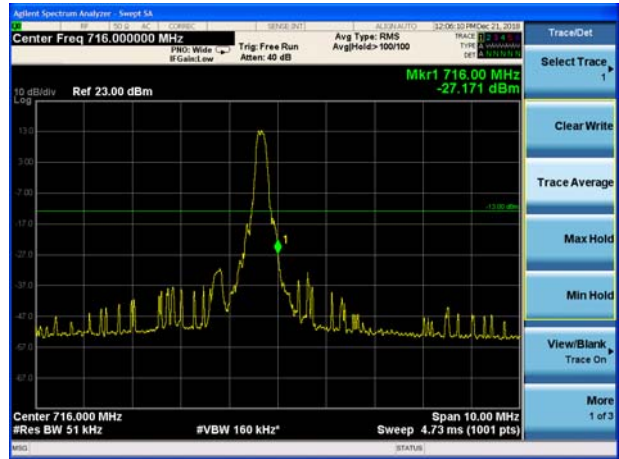

LTE Band 12 16QAM 5MHz CH-Low, 100%RB

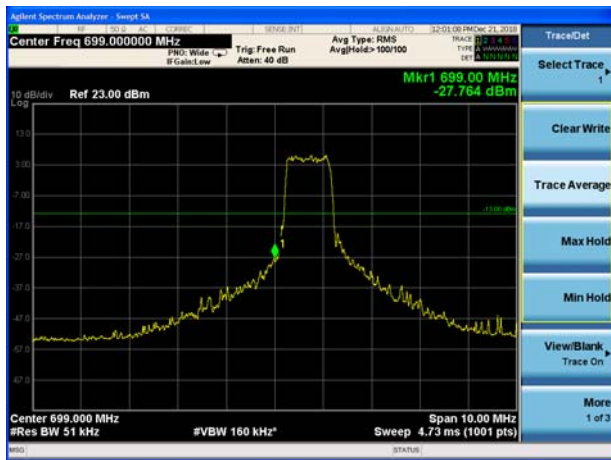

LTE Band 12 16QAM 5MHz CH-High, 100%RB

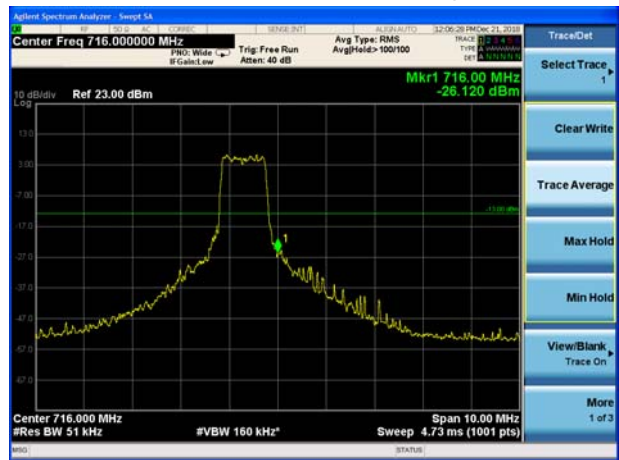

LTE Band 12 16QAM 10MHz CH-Low, 1 RB

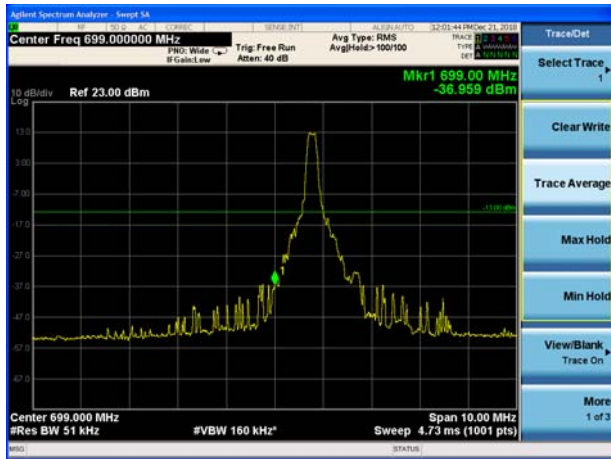

LTE Band 12 16QAM 10MHz CH-High, 1 RB

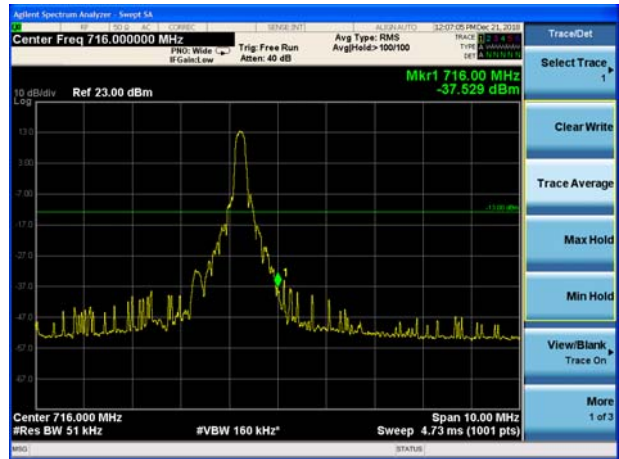



LTE Band 12 16QAM 10MHz CH-Low, 100%RB

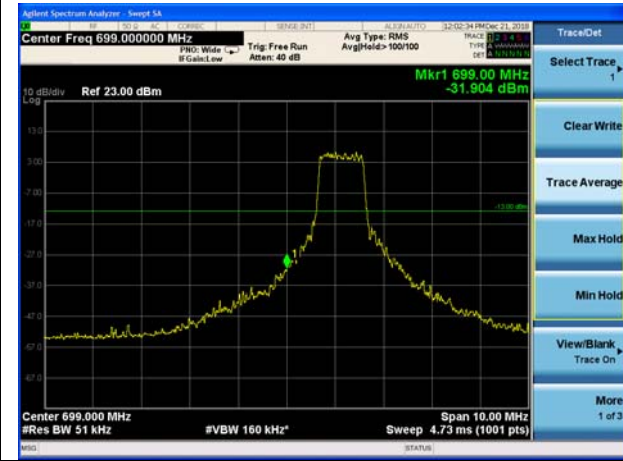

LTE Band 12 16QAM 10MHz CH-High, 100%RB

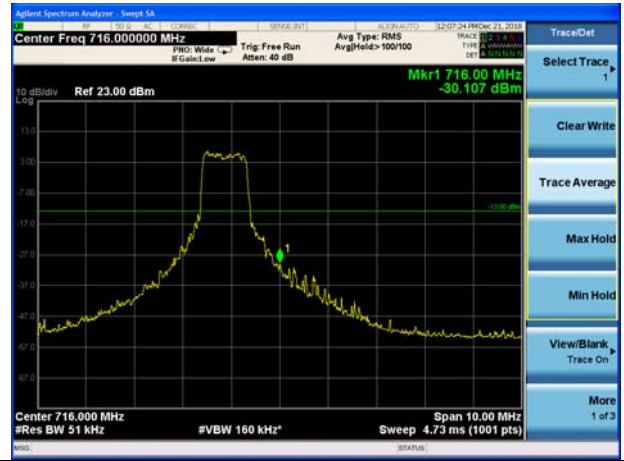

LTE Band 13 QPSK 5MHz CH-Low, 1 RB

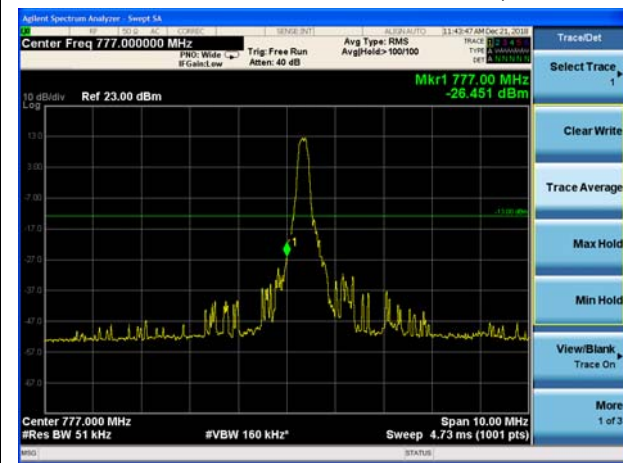

LTE Band 13 QPSK 5MHz CH-High, 1 RB



LTE Band 13 QPSK 5MHz CH-Low, 100%RB

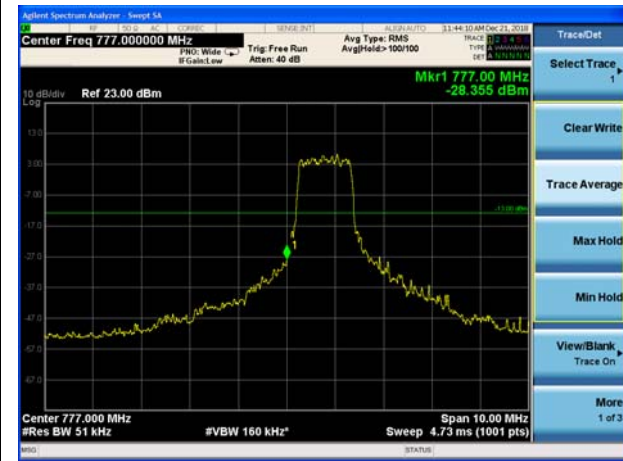

LTE Band 13 QPSK 5MHz CH-High, 100%RB

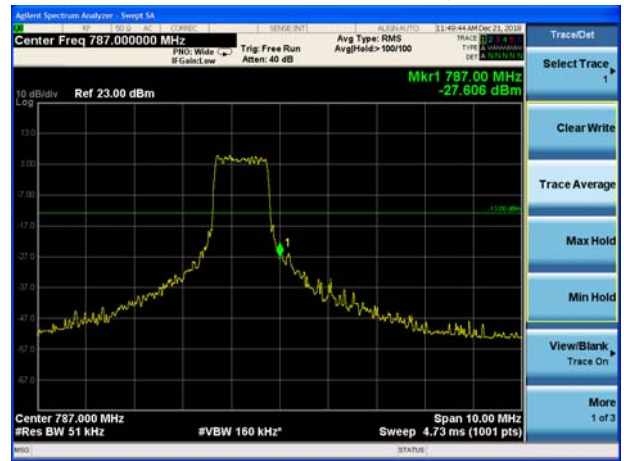



LTE Band 13 QPSK 10MHz CH-Low, 1 RB

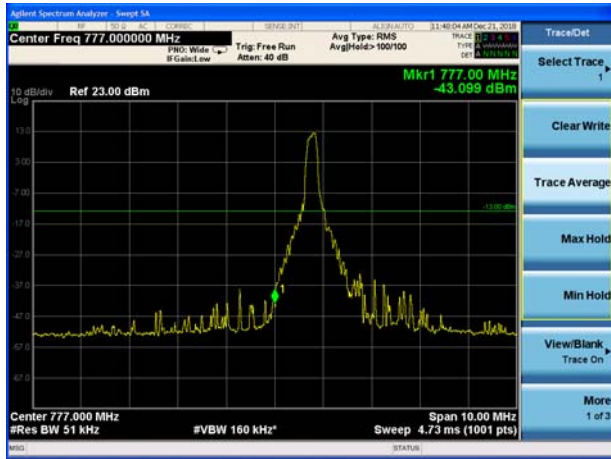

LTE Band 13 QPSK 10MHz CH-High, 1 RB

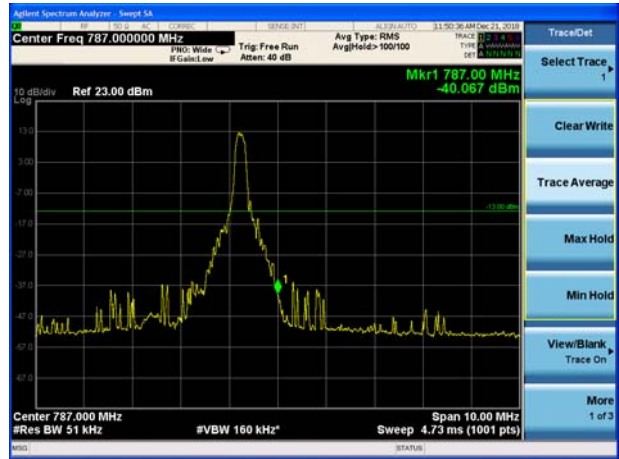

LTE Band 13 QPSK 10MHz CH-Low, 100%RB

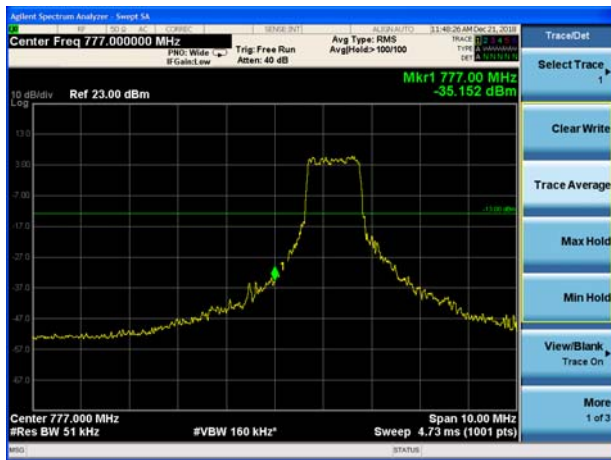

LTE Band 13 QPSK 10MHz CH-High, 100%RB

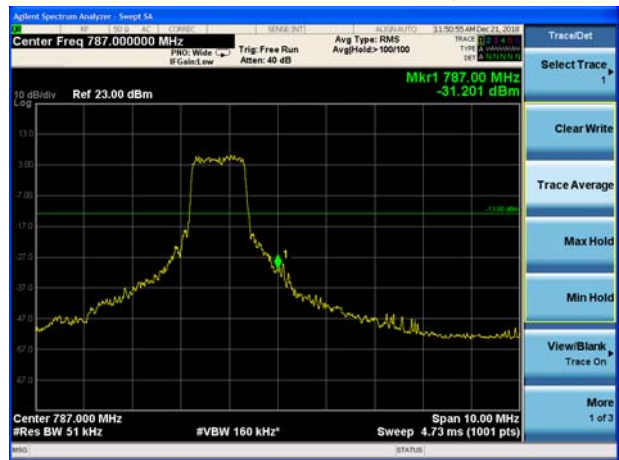

LTE Band 13 16QAM 5MHz CH-Low, 1 RB

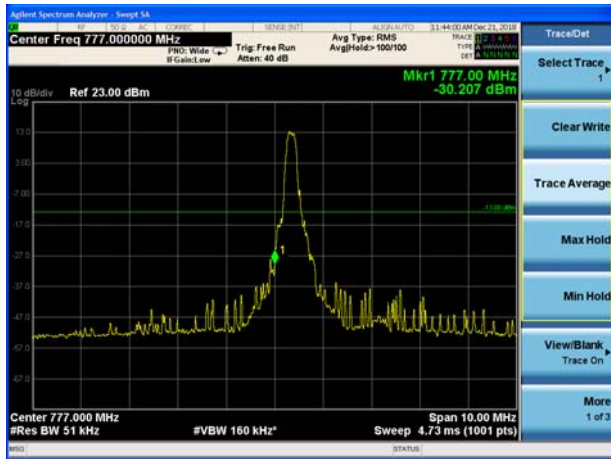

LTE Band 13 16QAM 5MHz CH-High, 1 RB

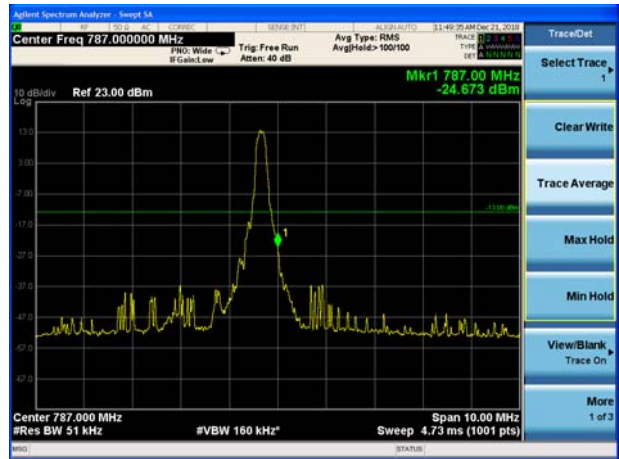





LTE Band 13 16QAM 5MHz CH-Low, 100%RB



LTE Band 13 16QAM 5MHz CH-High, 100%RB



LTE Band 13 16QAM 10MHz CH-Low, 1 RB

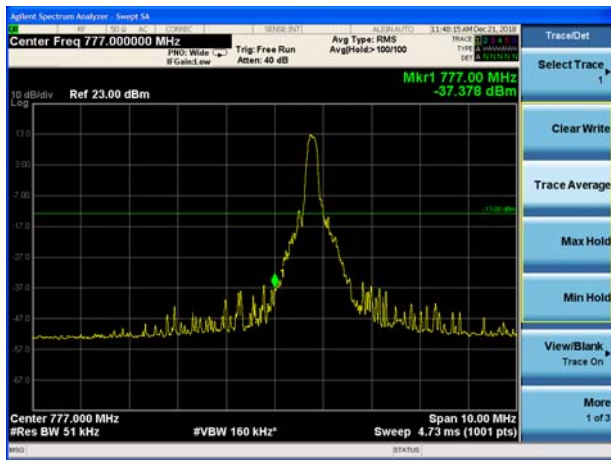

LTE Band 13 16QAM 10MHz CH-High, 1 RB

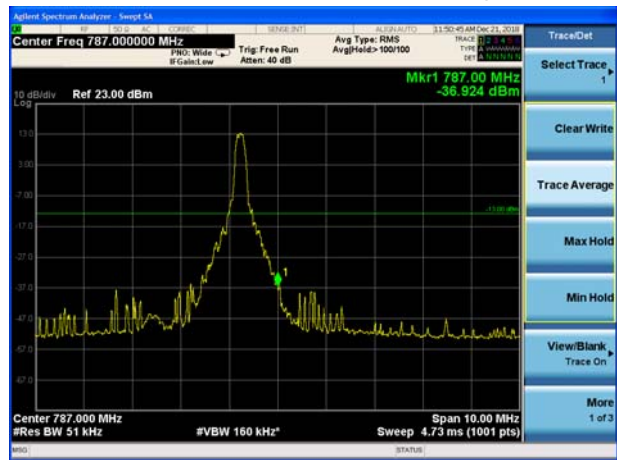

LTE Band 13 16QAM 10MHz CH-Low, 100%RB

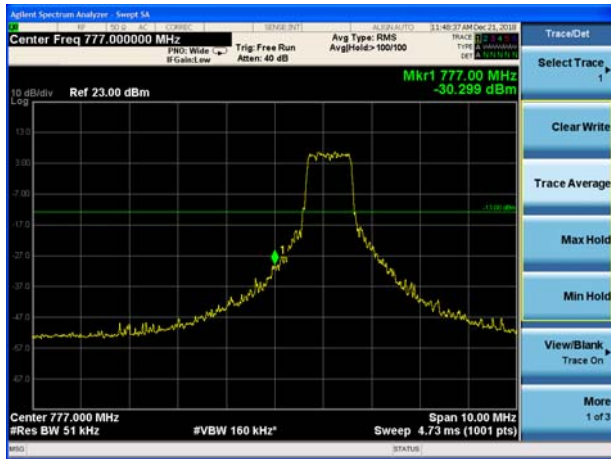

LTE Band 13 16QAM 10MHz CH-High, 100%RB

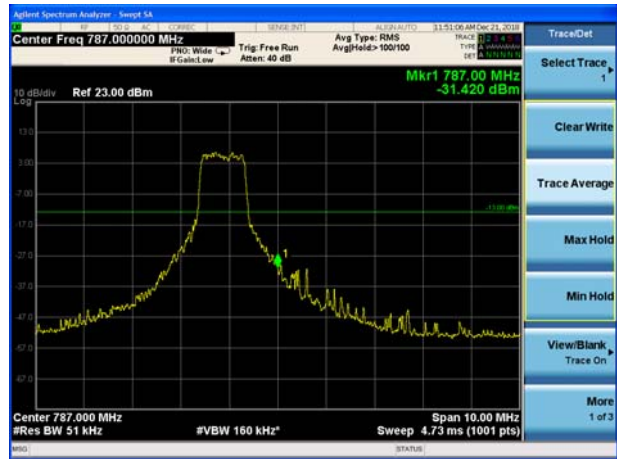

### 5.5 Peak-to-Average Power Ratio (PAPR)

#### Ambient condition

| Temperature | Relative humidity | Pressure |
|-------------|-------------------|----------|
| 23°C ~25°C  | 45%~50%           | 101.5kPa |

#### Methods of Measurement

Measure the total peak power and record as PPk. And measure the total average power and record as PAvg. Both the peak and average power levels must be expressed in the same logarithmic units (e.g., dBm). Determine the PAPR from:

$$PAPR (dB) = PPk (dBm) - PAvg (dBm).$$

#### Test Setup

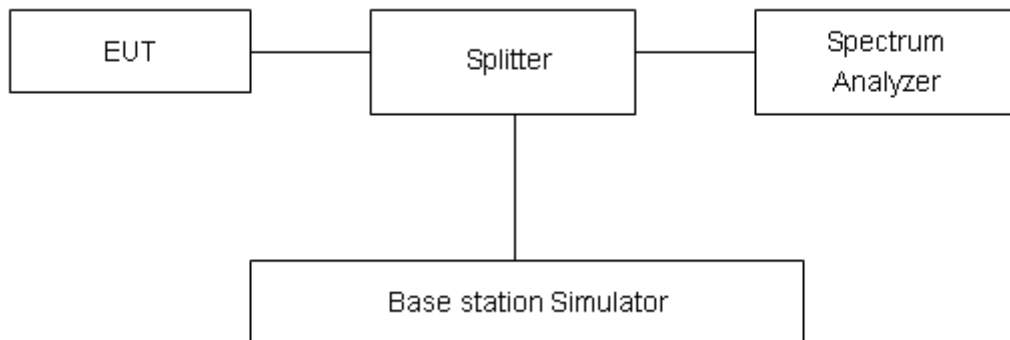

#### Limits

Rule Part 27.50(d)(5) Equipment employed must be authorized in accordance with the provisions of 24.51. Power measurements for transmissions by stations authorized under this section may be made either in accordance with a Commission-approved average power technique or in compliance with paragraph (d)(6) of this section. In measuring transmissions in this band using an average power technique, the peak-to-average ratio (PAR) of the transmission may not exceed 13 dB.

#### Measurement Uncertainty

The assessed measurement uncertainty to ensure 95% confidence level for the normal distribution is with the coverage factor k = 2, U= 0.4 dB.

**Test Results**

| Mode           | Bandwidth | Modulation | Channel/<br>Frequency(MHz) | Peak-to-Average Power Ratio (PAPR) |                                    |          |          |
|----------------|-----------|------------|----------------------------|------------------------------------|------------------------------------|----------|----------|
|                |           |            |                            | Peak(dBm)                          | Avg(dBm)                           | PAPR(dB) |          |
| LTE<br>Band 4  | 1.4MHz    | QPSK       | 20175/1732.5               | 25.23                              | 15.91                              | 9.32     |          |
|                |           | 16QAM      | 20175/1732.5               | 26.24                              | 16.74                              | 9.50     |          |
|                | 3MHz      | QPSK       | 20175/1732.5               | 25.45                              | 16.09                              | 9.36     |          |
|                |           | 16QAM      | 20175/1732.5               | 26.00                              | 16.28                              | 9.72     |          |
|                | 5MHz      | QPSK       | 20175/1732.5               | 25.35                              | 15.76                              | 9.59     |          |
|                |           | 16QAM      | 20175/1732.5               | 26.23                              | 16.97                              | 9.26     |          |
|                | 10MHz     | QPSK       | 20175/1732.5               | 25.31                              | 15.47                              | 9.84     |          |
|                |           | 16QAM      | 20175/1732.5               | 26.18                              | 16.72                              | 9.46     |          |
|                | 15MHz     | QPSK       | 20175/1732.5               | 25.25                              | 15.33                              | 9.92     |          |
|                |           | 16QAM      | 20175/1732.5               | 26.05                              | 16.72                              | 9.33     |          |
|                | 20MHz     | QPSK       | 20175/1732.5               | 25.40                              | 17.21                              | 8.19     |          |
|                |           | 16QAM      | 20175/1732.5               | 26.19                              | 16.06                              | 10.13    |          |
|                | Mode      | Bandwidth  | Modulation                 | Channel/<br>Frequency(MHz)         | Peak-to-Average Power Ratio (PAPR) |          |          |
|                |           |            |                            |                                    | Peak(dBm)                          | Avg(dBm) | PAPR(dB) |
| LTE<br>Band 12 | 1.4MHz    | QPSK       | 23095/707.5                | 26.72                              | 17.17                              | 9.55     |          |
|                |           | 16QAM      | 23095/707.5                | 27.44                              | 17.45                              | 9.99     |          |
|                | 3MHz      | QPSK       | 23095/707.5                | 26.66                              | 17.16                              | 9.50     |          |
|                |           | 16QAM      | 23095/707.5                | 27.56                              | 17.72                              | 9.84     |          |
|                | 5MHz      | QPSK       | 23095/707.5                | 26.72                              | 17.06                              | 9.66     |          |
|                |           | 16QAM      | 23095/707.5                | 27.65                              | 17.44                              | 10.21    |          |
|                | 10MHz     | QPSK       | 23095/707.5                | 26.65                              | 16.91                              | 9.74     |          |
|                |           | 16QAM      | 23095/707.5                | 27.72                              | 18.02                              | 9.70     |          |
|                | Mode      | Bandwidth  | Modulation                 | Channel/<br>Frequency(MHz)         | Peak-to-Average Power Ratio (PAPR) |          |          |
|                |           |            |                            |                                    | Peak(dBm)                          | Avg(dBm) | PAPR(dB) |
| LTE<br>Band 13 | 5MHz      | QPSK       | 23230/782                  | 26.66                              | 17.25                              | 9.41     |          |
|                |           | 16QAM      | 23230/782                  | 27.80                              | 18.78                              | 9.02     |          |
|                | 10MHz     | QPSK       | 23230/782                  | 26.65                              | 17.93                              | 8.72     |          |
|                |           | 16QAM      | 23230/782                  | 27.79                              | 18.43                              | 9.36     |          |

## 5.6 Frequency Stability

### Ambient condition

| Temperature | Relative humidity | Pressure |
|-------------|-------------------|----------|
| 23°C ~25°C  | 45%~50%           | 101.5kPa |

### Method of Measurement

#### Frequency Stability (Temperature Variation)

The temperature inside the climate chamber is varied from -40°C to +85°C in 10°C step size.

(1) With all power removed, the temperature was decreased to -10°C and permitted to stabilize for three hours.

(2) Measure the carrier frequency with the test equipment in a “call mode”. These measurements should be made within 1 minute of powering up the mobile station, to prevent significant self warming.

(3) Repeat the above measurements at 10°C increments from -40°C to +85°C. Allow at least 1.5 hours at each temperature, un-powered, before making measurements.

#### Frequency Stability (Voltage Variation)

The frequency stability shall be measured with variation of primary supply voltage as follows:

(1) Vary primary supply voltage from 85 to 115 percent of the nominal value for other than hand carried battery equipment.

(2) For hand carried, battery powered equipment, reduce primary supply voltage to the battery-operating end point which shall be specified by the manufacturer.

This transceiver is specified to operate with an input voltage of between 3.3 V and 4.3 V, with a nominal voltage of 3.8V.

### Test setup

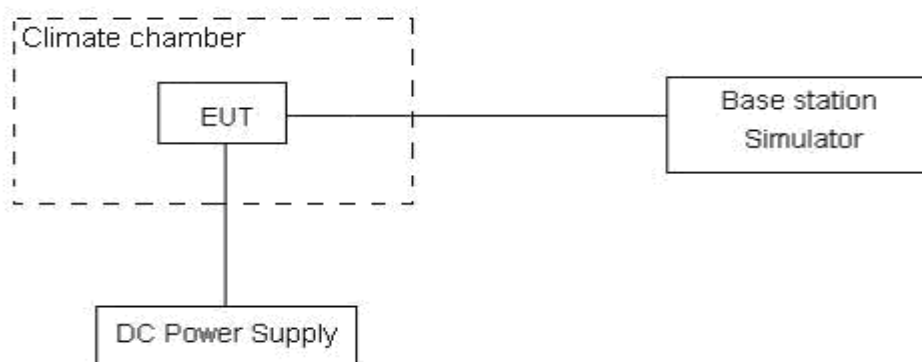

### Limits

The frequency stability shall be sufficient to ensure that the fundamental emissions stay within the authorized bands of operation.

### Measurement Uncertainty

The assessed measurement uncertainty to ensure 99.75% confidence level for the normal distribution is with the coverage factor  $k = 3, U=0.01\text{ppm}$ .

**Test Result**

| LTE Band 4              |         |                    |                     |       |                 |
|-------------------------|---------|--------------------|---------------------|-------|-----------------|
| QPSK,(20MHz BANDWIDTH)  |         |                    |                     |       |                 |
| Condition               |         | 1710               | 1755                | Delta | Frequency       |
| Temperature             | Voltage | F low@-13dBm (MHz) | F high@-13dBm (MHz) | (Hz)  | Stability (ppm) |
| Normal (25°C)           | Normal  | 1711.2376          | 1753.8212           | 2.65  | 0.00153         |
| Extreme (85°C)          |         | 1711.2373          | 1753.8215           | 14.76 | 0.00852         |
| Extreme (80°C)          |         | 1711.2371          | 1753.8218           | 6.52  | 0.00376         |
| Extreme (70°C)          |         | 1711.2375          | 1753.8213           | 8.95  | 0.00517         |
| Extreme (60°C)          |         | 1711.2371          | 1753.8217           | 13.54 | 0.00782         |
| Extreme (50°C)          |         | 1711.2456          | 1753.8132           | 25.11 | 0.01449         |
| Extreme (40°C)          |         | 1711.2412          | 1753.8178           | 23.01 | 0.01328         |
| Extreme (30°C)          |         | 1711.2417          | 1753.8171           | 18.41 | 0.01063         |
| Extreme (20°C)          |         | 1711.2423          | 1753.8168           | 7.22  | 0.00417         |
| Extreme (10°C)          |         | 1711.2385          | 1753.8203           | 19.64 | 0.01134         |
| Extreme (0°C)           |         | 1711.2444          | 1753.8144           | 17.43 | 0.01006         |
| Extreme (-10°C)         |         | 1711.2381          | 1753.8207           | 28.65 | 0.01654         |
| Extreme (-20°C)         |         | 1711.2422          | 1753.8166           | 30.42 | 0.01756         |
| Extreme (-30°C)         |         | 1711.2368          | 1753.8227           | 4.65  | 0.00268         |
| Extreme (-40°C)         |         | 1711.2376          | 1753.8212           | 2.84  | 0.00164         |
| 25°C                    | LV      | 1711.2425          | 1753.8168           | 7.95  | 0.00459         |
|                         | HV      | 1711.2369          | 1753.8219           | 18.46 | 0.01066         |
| 16QAM,(20MHz BANDWIDTH) |         |                    |                     |       |                 |
| Condition               |         | 1710               | 1755                | Delta | Frequency       |
| Temperature             | Voltage | F low@-13dBm (MHz) | F high@-13dBm (MHz) | (Hz)  | Stability (ppm) |
| Normal (25°C)           | Normal  | 1711.2331          | 1753.8258           | 2.84  | 0.00164         |
| Extreme (85°C)          |         | 1711.2334          | 1753.8255           | 7.58  | 0.00438         |
| Extreme (80°C)          |         | 1711.2337          | 1753.8252           | 18.34 | 0.01059         |
| Extreme (70°C)          |         | 1711.2332          | 1753.8257           | 19.64 | 0.01134         |
| Extreme (60°C)          |         | 1711.2335          | 1753.8253           | 25.03 | 0.01445         |
| Extreme (50°C)          |         | 1711.2254          | 1753.8338           | 27.63 | 0.01595         |
| Extreme (40°C)          |         | 1711.2296          | 1753.8292           | 21.45 | 0.01238         |
| Extreme (30°C)          |         | 1711.2289          | 1753.8299           | 13.58 | 0.00784         |
| Extreme (20°C)          |         | 1711.2286          | 1753.8302           | 9.64  | 0.00556         |
| Extreme (10°C)          |         | 1711.2321          | 1753.8267           | 3.78  | 0.00218         |
| Extreme (0°C)           |         | 1711.2262          | 1753.8326           | 6.95  | 0.00401         |
| Extreme (-10°C)         |         | 1711.2325          | 1753.8263           | 18.34 | 0.01059         |
| Extreme (-20°C)         |         | 1711.2284          | 1753.8304           | 2.44  | 0.00141         |
| Extreme (-30°C)         |         | 1711.2338          | 1753.8252           | 15.73 | 0.00908         |

|                 |    |           |           |       |         |
|-----------------|----|-----------|-----------|-------|---------|
| Extreme (-40°C) |    | 1711.2331 | 1753.8258 | 22.61 | 0.01305 |
| 25C             | LV | 1711.2286 | 1753.8302 | 15.39 | 0.00888 |
|                 | HV | 1711.2337 | 1753.8251 | 29.37 | 0.01695 |

| LTE Band 12            |         |                    |                     |       |                 |
|------------------------|---------|--------------------|---------------------|-------|-----------------|
| QPSK,(10MHz BANDWIDTH) |         |                    |                     |       |                 |
| Condition              |         | 699                | 716                 | Delta | Frequency       |
| Temperature            | Voltage | F low@-13dBm (MHz) | F high@-13dBm (MHz) | (Hz)  | Stability (ppm) |
| Normal (25°C)          | Normal  | 699.5339           | 715.4755            | 3.97  | 0.00561         |
| Extreme (85°C)         |         | 699.5342           | 715.4752            | 5.32  | 0.00752         |
| Extreme (80°C)         |         | 699.5345           | 715.4749            | 4.11  | 0.00581         |
| Extreme (70°C)         |         | 699.5340           | 715.4754            | 8.19  | 0.01158         |
| Extreme (60°C)         |         | 699.5334           | 715.4753            | 15.24 | 0.02154         |
| Extreme (50°C)         |         | 699.5419           | 715.4835            | 18.67 | 0.02639         |
| Extreme (40°C)         |         | 699.5373           | 715.4789            | 11.23 | 0.01587         |
| Extreme (30°C)         |         | 699.5380           | 715.4796            | 9.56  | 0.01351         |
| Extreme (20°C)         |         | 699.5383           | 715.4799            | 14.29 | 0.02020         |
| Extreme (10°C)         |         | 699.5348           | 715.4764            | 16.77 | 0.02370         |
| Extreme (0°C)          |         | 699.5407           | 715.4823            | 8.84  | 0.01249         |
| Extreme (-10°C)        |         | 699.5344           | 715.4762            | 2.64  | 0.00373         |
| Extreme (-20°C)        |         | 699.5385           | 715.4801            | 5.08  | 0.00718         |
| Extreme (-30°C)        |         | 699.5331           | 715.4747            | 14.37 | 0.02031         |
| Extreme (-40°C)        |         | 699.5331           | 715.4747            | 19.54 | 0.02762         |
| 25C                    | LV      | 699.5383           | 715.4799            | 7.77  | 0.01098         |
|                        | HV      | 699.5332           | 715.4748            | 9.64  | 0.01363         |

| 16QAM,(10MHz BANDWIDTH) |         |                    |                     |       |                 |
|-------------------------|---------|--------------------|---------------------|-------|-----------------|
| Condition               |         | 699                | 716                 | Delta | Frequency       |
| Temperature             | Voltage | F low@-13dBm (MHz) | F high@-13dBm (MHz) | (Hz)  | Stability (ppm) |
| Normal (25°C)           | Normal  | 699.5293           | 715.4709            | 9.64  | 0.01363         |
| Extreme (85°C)          |         | 699.5296           | 715.4706            | 6.26  | 0.00885         |
| Extreme (80°C)          |         | 699.5299           | 715.4703            | 9.54  | 0.01348         |
| Extreme (70°C)          |         | 699.5294           | 715.4708            | 4.86  | 0.00687         |
| Extreme (60°C)          |         | 699.5298           | 715.4714            | 15.84 | 0.02239         |
| Extreme (50°C)          |         | 699.5213           | 715.4629            | 14.31 | 0.02023         |
| Extreme (40°C)          |         | 699.5259           | 715.4675            | 4.20  | 0.00594         |
| Extreme (30°C)          |         | 699.5252           | 715.4668            | 6.57  | 0.00929         |
| Extreme (20°C)          |         | 699.5249           | 715.4665            | 18.92 | 0.02674         |
| Extreme (10°C)          |         | 699.5284           | 715.4765            | 3.22  | 0.00455         |
| Extreme (0°C)           |         | 699.5225           | 715.4641            | 7.46  | 0.01054         |



|                 |    |          |          |       |         |
|-----------------|----|----------|----------|-------|---------|
| Extreme (-10°C) |    | 699.5288 | 715.4704 | 12.38 | 0.01750 |
| Extreme (-20°C) |    | 699.5247 | 715.4663 | 9.73  | 0.01375 |
| Extreme (-30°C) |    | 699.5301 | 715.4717 | 6.01  | 0.00849 |
| Extreme (-40°C) |    | 699.5301 | 715.4717 | 16.74 | 0.02366 |
| 25C             | LV | 699.5249 | 715.4665 | 11.92 | 0.01685 |
|                 | HV | 699.5300 | 715.4716 | 13.45 | 0.01901 |

| LTE Band 13             |         |                    |                     |       |                 |
|-------------------------|---------|--------------------|---------------------|-------|-----------------|
| QPSK,(10MHz BANDWIDTH)  |         |                    |                     |       |                 |
| Condition               |         | 777                | 787                 | Delta | Frequency       |
| Temperature             | Voltage | F low@-13dBm (MHz) | F high@-13dBm (MHz) | (Hz)  | Stability (ppm) |
| Normal (25°C)           | Normal  | 777.5622           | 786.5358            | 9.27  | 0.01185         |
| Extreme (85°C)          |         | 777.5618           | 786.5354            | -8.92 | -0.01141        |
| Extreme (80°C)          |         | 777.5696           | 786.5432            | 11.24 | 0.01437         |
| Extreme (70°C)          |         | 777.5670           | 786.5406            | 13.21 | 0.01689         |
| Extreme (60°C)          |         | 777.5617           | 786.5353            | 6.25  | 0.00799         |
| Extreme (50°C)          |         | 777.5702           | 786.5438            | -7.63 | -0.00976        |
| Extreme (40°C)          |         | 777.5656           | 786.5392            | 3.61  | 0.00462         |
| Extreme (30°C)          |         | 777.5663           | 786.5399            | 1.66  | 0.00212         |
| Extreme (20°C)          |         | 777.5666           | 786.5402            | 10.12 | 0.01294         |
| Extreme (10°C)          |         | 777.5631           | 786.5367            | 0.17  | 0.00022         |
| Extreme (0°C)           |         | 777.5690           | 786.5426            | -0.56 | -0.00072        |
| Extreme (-10°C)         |         | 777.5627           | 786.5363            | -7.09 | -0.00907        |
| Extreme (-20°C)         |         | 777.5668           | 786.5404            | -1.18 | -0.00151        |
| Extreme (-30°C)         |         | 777.5614           | 786.5352            | -4.31 | -0.00551        |
| Extreme (-40°C)         |         | 777.5614           | 786.5354            | 4.21  | 0.00538         |
| 25C                     | LV      | 777.5666           | 786.5402            | 2.86  | 0.00366         |
|                         | HV      | 777.5615           | 786.5351            | 4.59  | 0.00587         |
| 16QAM,(10MHz BANDWIDTH) |         |                    |                     |       |                 |
| Condition               |         | 777                | 787                 | Delta | Frequency       |
| Temperature             | Voltage | F low@-13dBm (MHz) | F high@-13dBm (MHz) | (Hz)  | Stability (ppm) |
| Normal (25°C)           | Normal  | 777.558            | 786.5303            | -4.97 | -0.00636        |
| Extreme (85°C)          |         | 777.5584           | 786.5307            | -4.92 | -0.00629        |
| Extreme (80°C)          |         | 777.5506           | 786.5229            | -6.47 | -0.00827        |
| Extreme (70°C)          |         | 777.5532           | 786.5255            | 0.48  | 0.00061         |
| Extreme (60°C)          |         | 777.5585           | 786.5308            | -0.68 | -0.00087        |
| Extreme (50°C)          |         | 777.55             | 786.5223            | -1.78 | -0.00228        |
| Extreme (40°C)          |         | 777.5546           | 786.5269            | -0.60 | -0.00077        |
| Extreme (30°C)          |         | 777.5539           | 786.5262            | -5.19 | -0.00664        |
| Extreme (20°C)          |         | 777.5536           | 786.5259            | -8.51 | -0.01088        |



|                 |    |          |          |       |          |
|-----------------|----|----------|----------|-------|----------|
| Extreme (10°C)  |    | 777.5571 | 786.5294 | -1.29 | -0.00165 |
| Extreme (0°C)   |    | 777.5512 | 786.5235 | -3.75 | -0.00480 |
| Extreme (-10°C) |    | 777.5575 | 786.5298 | -1.77 | -0.00226 |
| Extreme (-20°C) |    | 777.5534 | 786.5257 | 2.39  | 0.00306  |
| Extreme (-30°C) |    | 777.5588 | 786.5311 | -2.87 | -0.00367 |
| Extreme (-40°C) |    | 777.5588 | 786.5311 | 3.74  | 0.00478  |
| 25C             | LV | 777.5536 | 786.5259 | 2.19  | 0.00280  |
|                 | HV | 777.5587 | 786.5314 | 0.82  | 0.00105  |



## 5.7 Spurious Emissions at Antenna Terminals

### Ambient condition

| Temperature | Relative humidity | Pressure |
|-------------|-------------------|----------|
| 23°C ~25°C  | 45%~50%           | 101.5kPa |

### Method of Measurement

The EUT was connected to Spectrum Analyzer and Base Station Simulator via power Splitter. The measurement is carried out using a spectrum analyzer. The spectrum analyzer scans from 9kHz to the 10th harmonic of the carrier. The peak detector is used.

RBW is set to 100kHz, VBW is set to 300kHz for 30MHz~1GHz

RBW is set to 1MHz, VBW is set to 3MHz for above 1GHz, Sweep is set to ATUO.

Of those disturbances below (limit – 20 dB), the mark is not required for the EUT.

The modulation mode and RB allocation refer to section 5.1, using the maximum output power configuration.

### Test setup

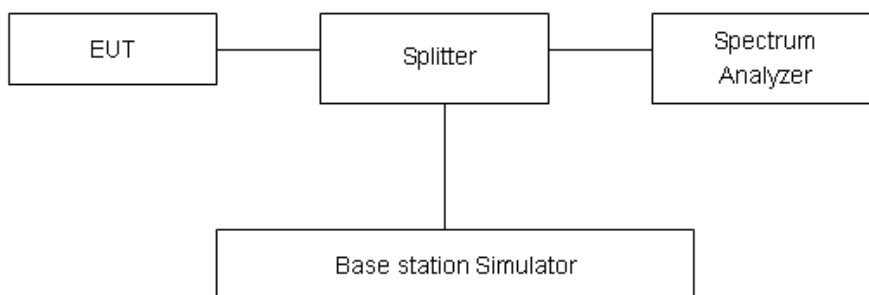

### Limits

Rule Part 27.53(h) specifies that “for operations in the 1695-1710 MHz, 1710-1755 MHz, 1755-1780 MHz, 1915-1920 MHz, 1995-2000 MHz, 2000-2020 MHz, 2110-2155 MHz, 2155-2180 MHz, and 2180-2200 bands, the power of any emission outside a licensee's frequency block shall be attenuated below the transmitter power (P) in watts by at least  $43 + 10 \log_{10}(P)$  dB.”

Rule Part 27.53 (g) For operations in the 600 MHz band and the 698-746 MHz band, the power of any emission outside a licensee's frequency band(s) of operation shall be attenuated below the transmitter power (P) within the licensed band(s) of operation, measured in watts, by at least  $43 + 10 \log(P)$  dB. Compliance with this provision is based on the use of measurement instrumentation employing a resolution bandwidth of 100 kilohertz or greater. However, in the 100 kilohertz bands immediately outside and adjacent to a licensee's frequency block, a resolution bandwidth of at least 30 kHz may be employed.

Rule Part 27.53(f) For operations in the 746-758 MHz, 775-788 MHz, and 805-806 MHz bands, emissions in the band 1559-1610 MHz shall be limited to  $-70$  dBW/MHz equivalent isotropically



radiated power (EIRP) for wideband signals, and -80 dBW EIRP for discrete emissions of less than 700 Hz bandwidth. For the purpose of equipment authorization, a transmitter shall be tested with an antenna that is representative of the type that will be used with the equipment in normal operation.

|                         |                                     |         |
|-------------------------|-------------------------------------|---------|
| Part 27.53(h)/(g) Limit |                                     | -13 dBm |
| Part 27.53(f) Limit     | Limit out of the band 1559-1610 MHz | -13 dBm |
|                         | Limit in the band 1559-1610 MHz     | -40 dBm |

### Measurement Uncertainty

The assessed measurement uncertainty to ensure 99.75% confidence level for the normal distribution is with the coverage factor  $k = 1.96$ .

| Frequency  | Uncertainty |
|------------|-------------|
| 9kHz-1GHz  | 0.684 dB    |
| 1GHz-27GHz | 1.407 dB    |

Test Result

Sweep the whole frequency band through the range from 9kHz to the 10th harmonic of the carrier, the emissions more than 20 dB below the limit are not reported.

The signal beyond the limit is carrier.

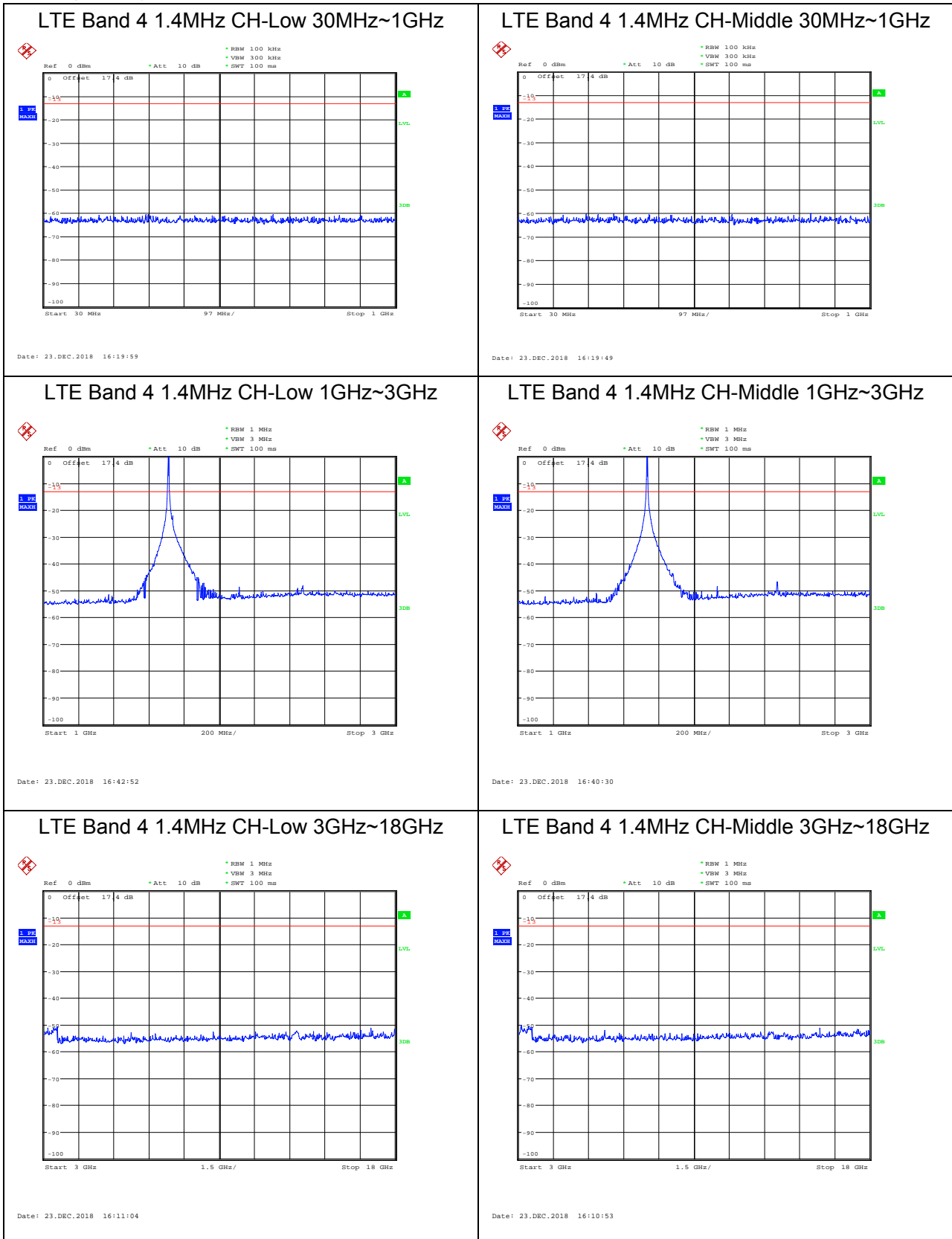

LTE Band 4 1.4MHz CH-High 30MHz~1GHz

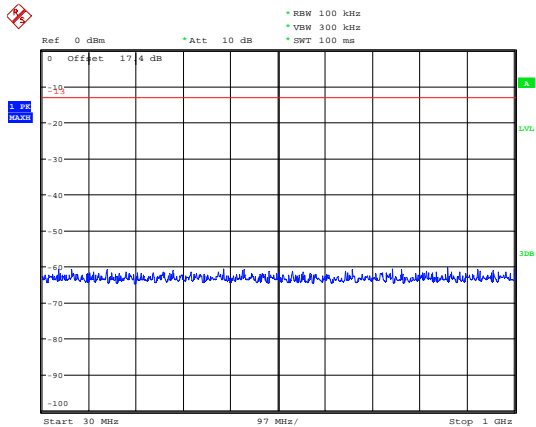

Date: 23.DEC.2018 16:20:07

LTE Band 4 3MHz CH-Low 30MHz~1GHz

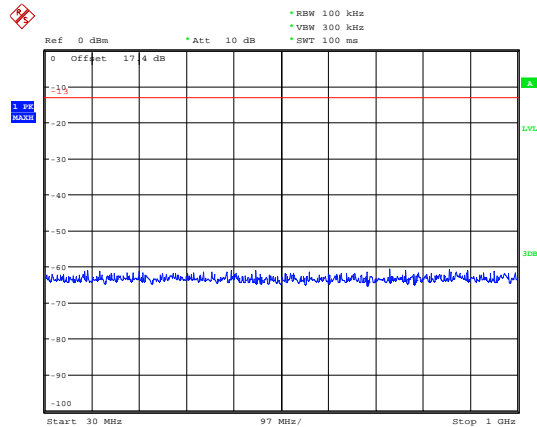

Date: 23.DEC.2018 16:18:55

LTE Band 4 1.4MHz CH-High 1GHz~3GHz

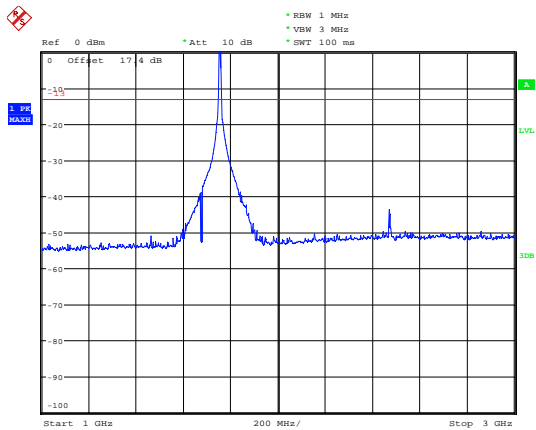

Date: 23.DEC.2018 16:47:09

LTE Band 4 3MHz CH-Low 1GHz~3GHz

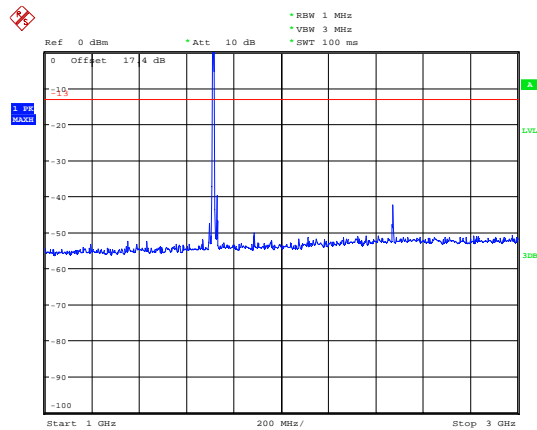

Date: 23.DEC.2018 16:51:37

LTE Band 4 1.4MHz CH-High 3GHz~18GHz

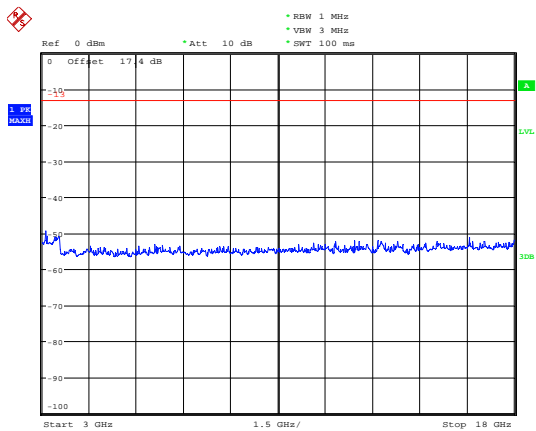

Date: 23.DEC.2018 16:11:13

LTE Band 4 3MHz CH-Low 3GHz~18GHz

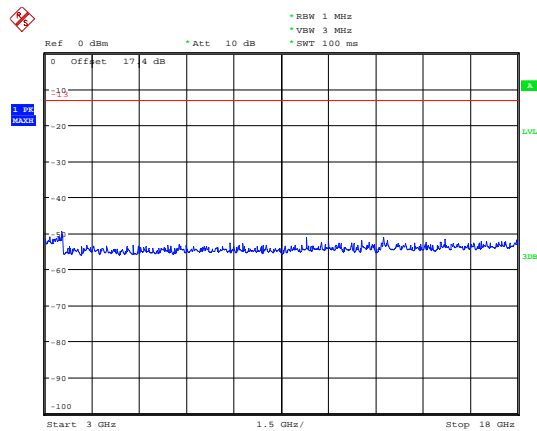

Date: 23.DEC.2018 16:12:42



### LTE Band 4 3MHz CH-Middle 30MHz~1GHz

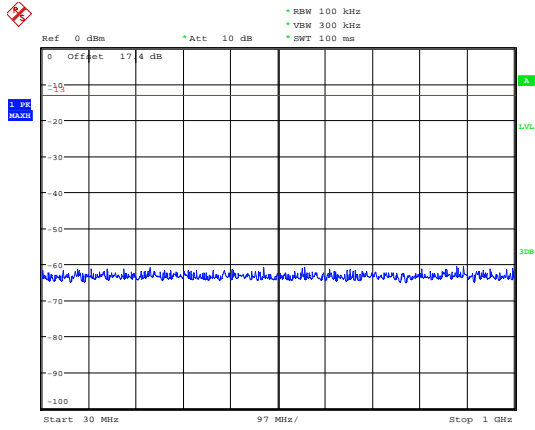

Date: 23.DEC.2018 16:18:45

### LTE Band 4 3MHz CH-High 30MHz~1GHz

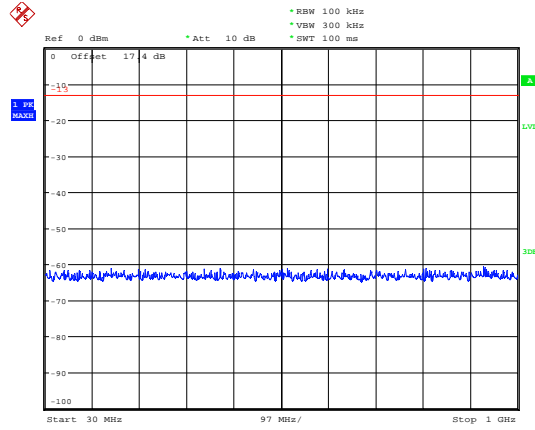

Date: 23.DEC.2018 16:19:04

### LTE Band 4 3MHz CH-Middle 1GHz~3GHz

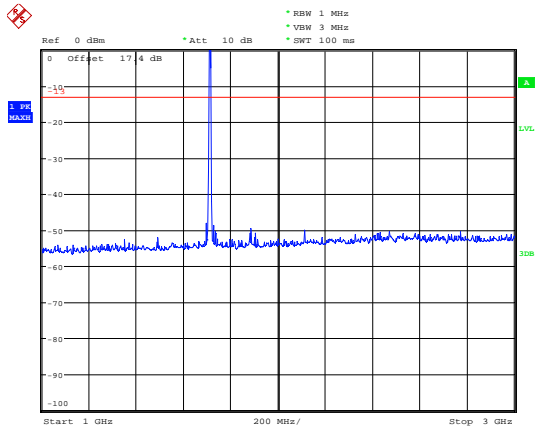

Date: 23.DEC.2018 16:51:58

### LTE Band 4 3MHz CH-High 1GHz~3GHz

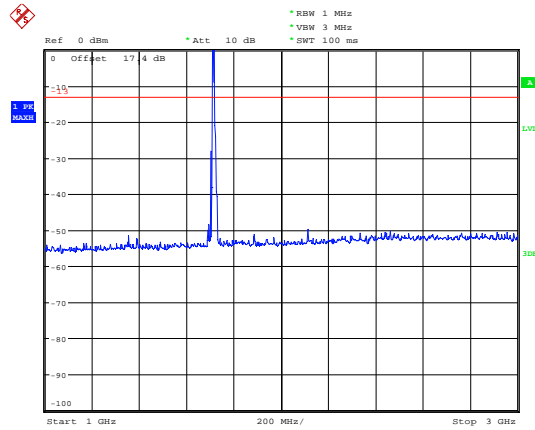

Date: 23.DEC.2018 16:52:07

### LTE Band 4 3MHz CH-Middle 3GHz~18GHz

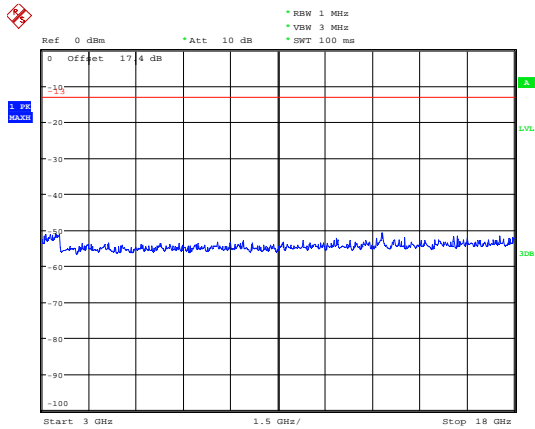

Date: 23.DEC.2018 16:12:28

### LTE Band 4 3MHz CH-High 3GHz~18GHz

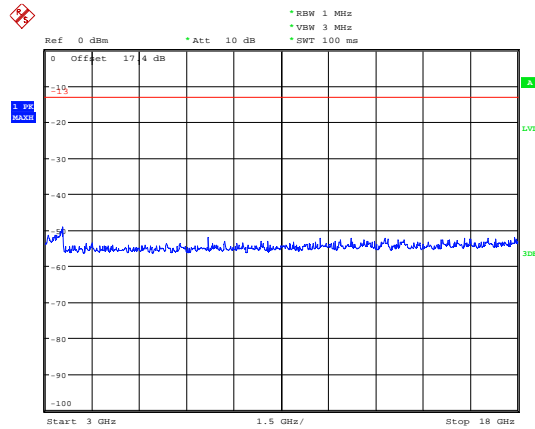

Date: 23.DEC.2018 16:12:50



### LTE Band 4 5MHz CH-Low 30MHz~1GHz

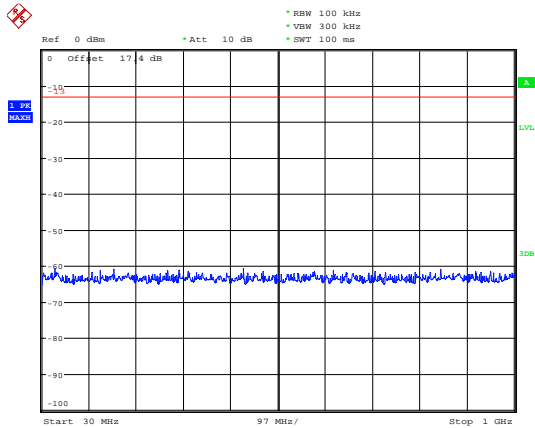

Date: 23.DEC.2018 16:18:23

### LTE Band 4 5MHz CH-Middle 30MHz~1GHz

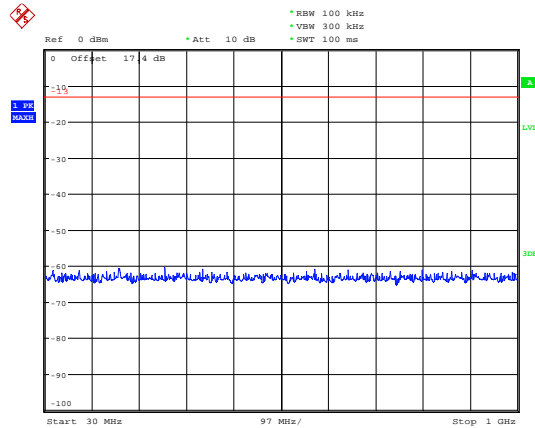

Date: 23.DEC.2018 16:18:13

### LTE Band 4 5MHz CH-Low 1GHz~3GHz

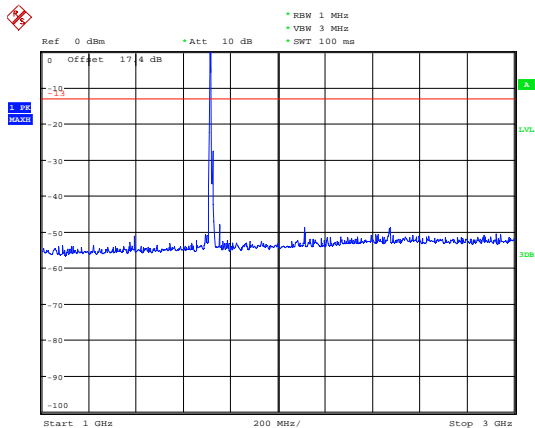

Date: 23.DEC.2018 17:01:57

### LTE Band 4 5MHz CH-Middle 1GHz~3GHz

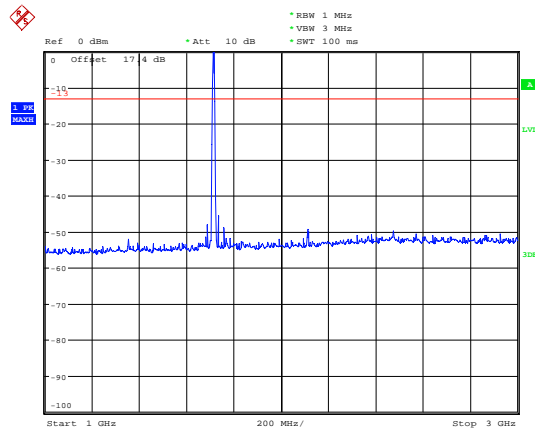

Date: 23.DEC.2018 17:02:28

### LTE Band 4 5MHz CH-Low 3GHz~18GHz

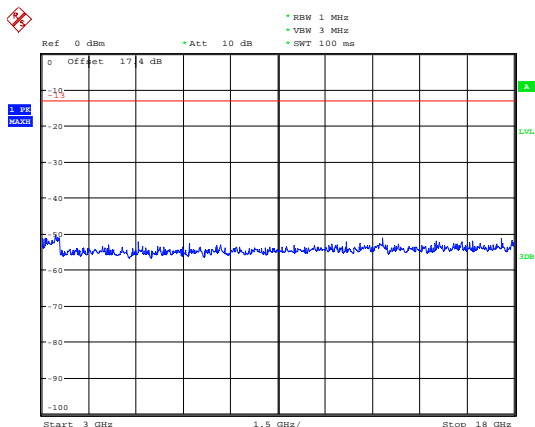

Date: 23.DEC.2018 16:13:13

### LTE Band 4 5MHz CH-Middle 3GHz~18GHz

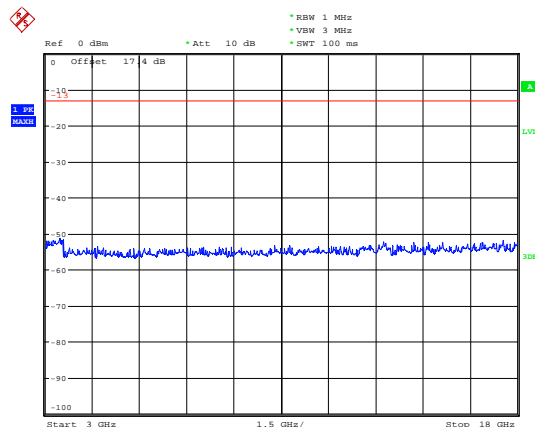

Date: 23.DEC.2018 16:13:05



### LTE Band 4 5MHz CH-High 30MHz~1GHz

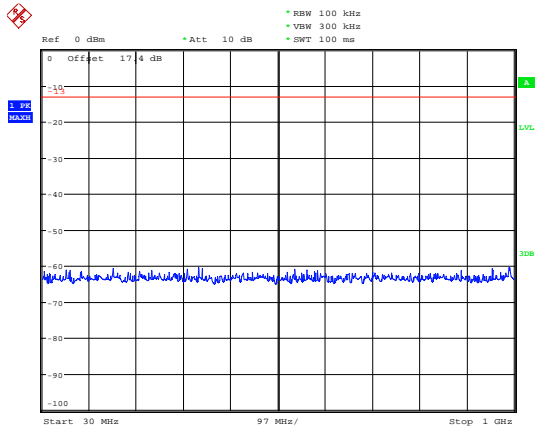

Date: 23.DEC.2018 16:18:31

### LTE Band 4 10MHz CH-Low 30MHz~1GHz

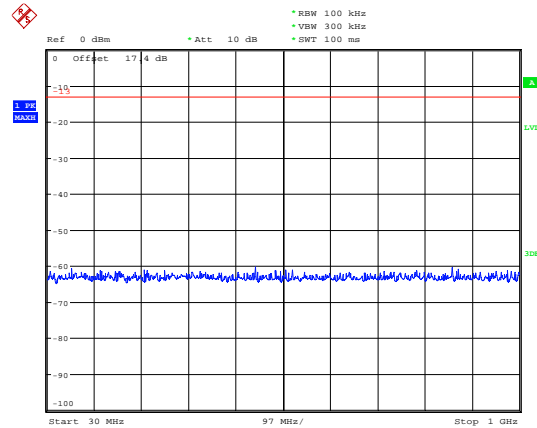

Date: 23.DEC.2018 16:17:43

### LTE Band 4 5MHz CH-High 1GHz~3GHz

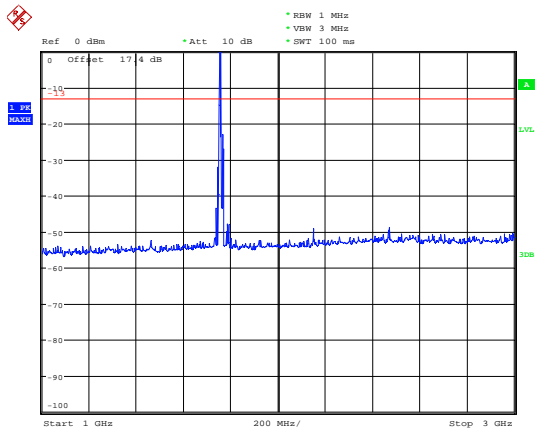

Date: 23.DEC.2018 17:03:54

### LTE Band 4 10MHz CH-Low 1GHz~3GHz

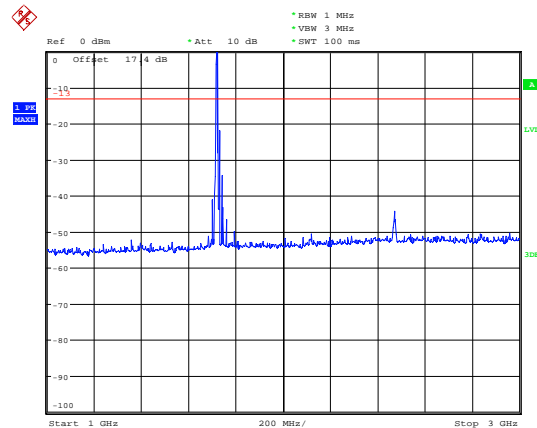

Date: 23.DEC.2018 17:04:36

### LTE Band 4 5MHz CH-High 3GHz~18GHz

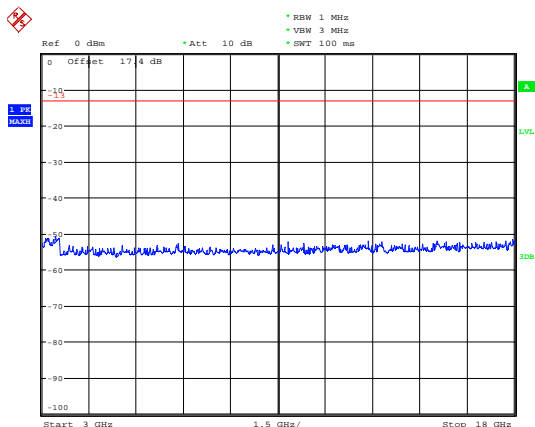

Date: 23.DEC.2018 16:13:22

### LTE Band 4 10MHz CH-Low 3GHz~18GHz

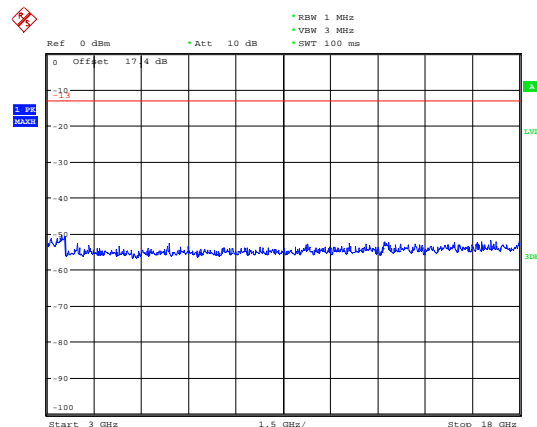

Date: 23.DEC.2018 16:13:52



### LTE Band 4 10MHz CH-Middle 30MHz~1GHz

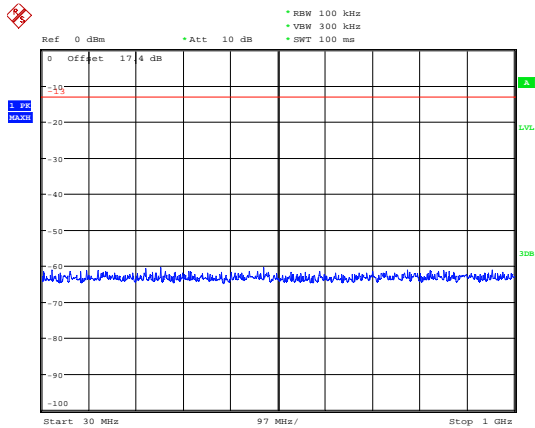

Date: 23.DEC.2018 16:17:32

### LTE Band 4 10MHz CH-High 30MHz~1GHz

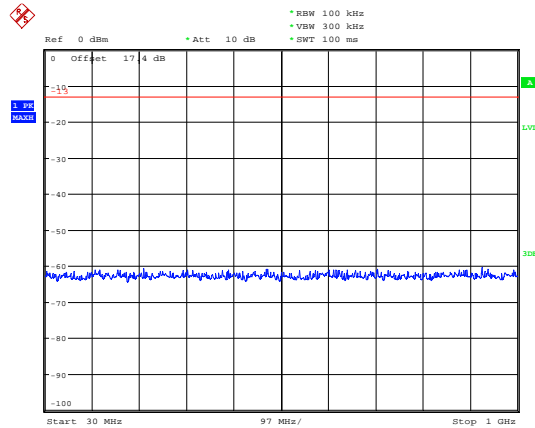

Date: 23.DEC.2018 16:17:54

### LTE Band 4 10MHz CH-Middle 1GHz~3GHz

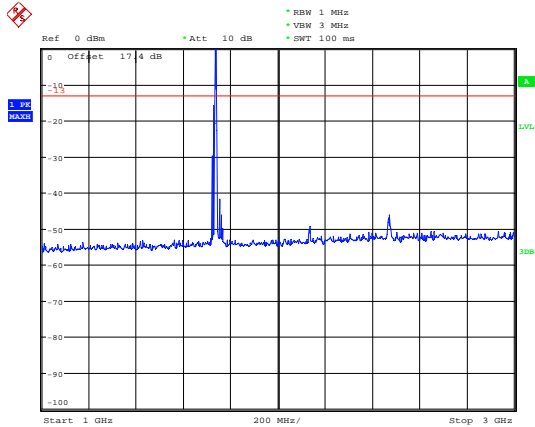

Date: 23.DEC.2018 17:05:28

### LTE Band 4 10MHz CH-High 1GHz~3GHz

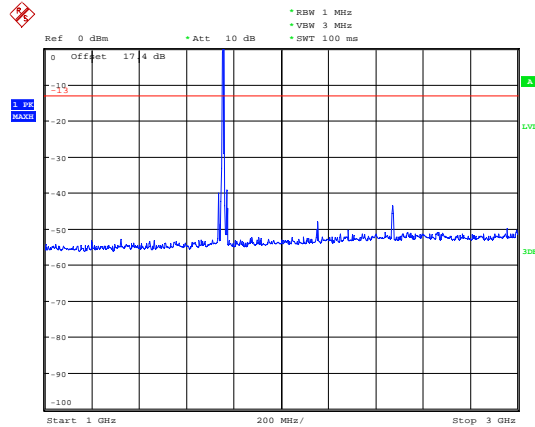

Date: 23.DEC.2018 17:07:36

### LTE Band 4 10MHz CH-Middle 3GHz~18GHz

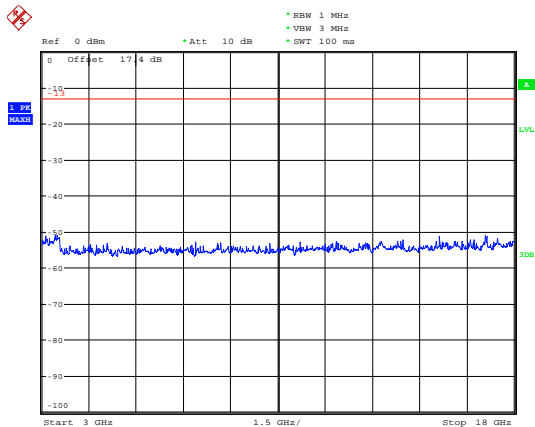

Date: 23.DEC.2018 16:13:45

### LTE Band 4 10MHz CH-High 3GHz~18GHz

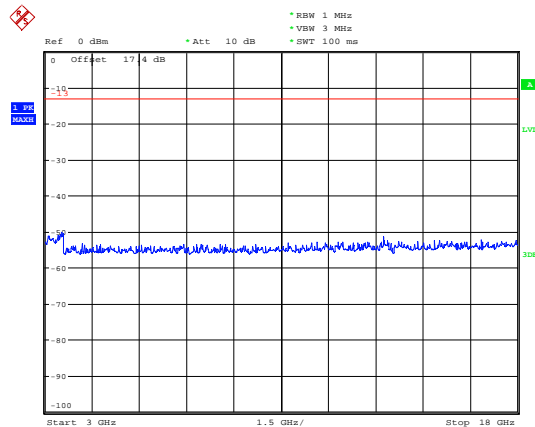

Date: 23.DEC.2018 16:14:00





### LTE Band 4 15MHz CH-Low 30MHz~1GHz

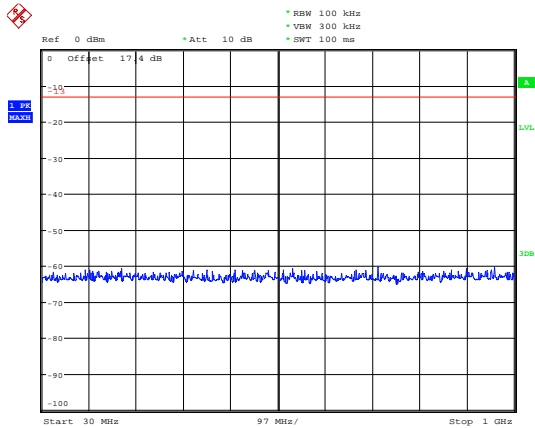

Date: 23.DEC.2018 16:17:07

### LTE Band 4 15MHz CH-Middle 30MHz~1GHz

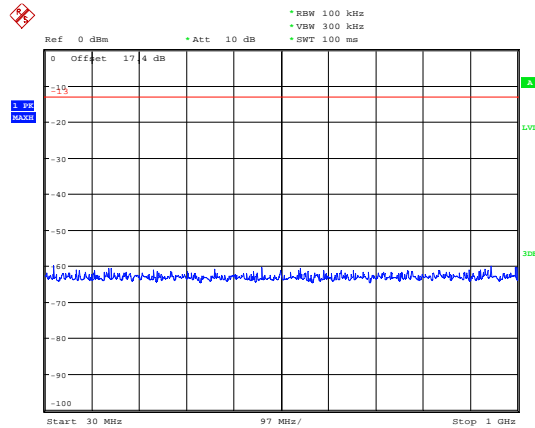

Date: 23.DEC.2018 16:16:36

### LTE Band 4 15MHz CH-Low 1GHz~3GHz

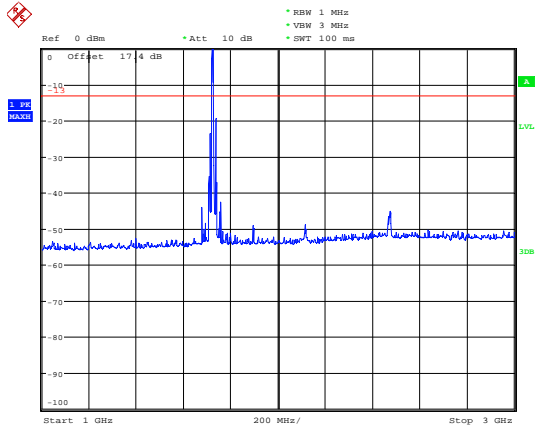

Date: 23.DEC.2018 17:09:07

### LTE Band 4 15MHz CH-Middle 1GHz~3GHz

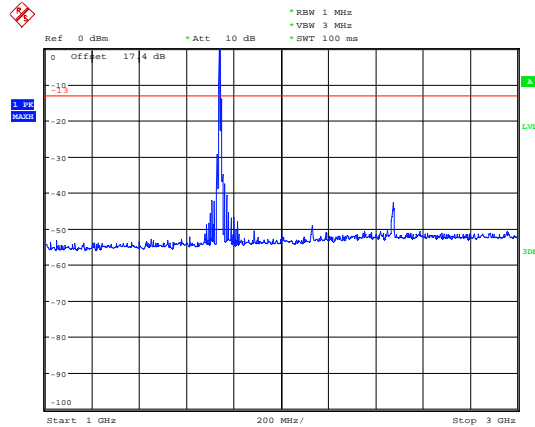

Date: 23.DEC.2018 17:09:50

### LTE Band 4 15MHz CH-Low 3GHz~18GHz

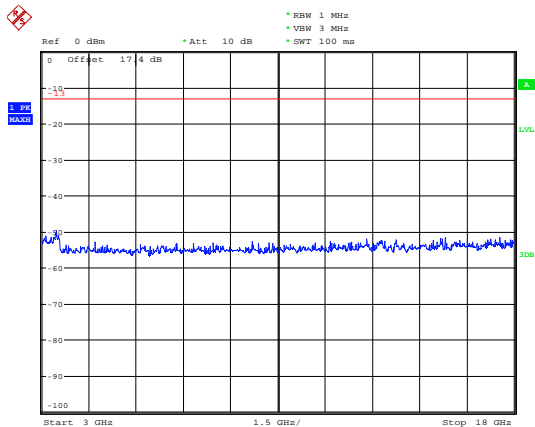

Date: 23.DEC.2018 16:14:27

### LTE Band 4 15MHz CH-Middle 3GHz~18GHz

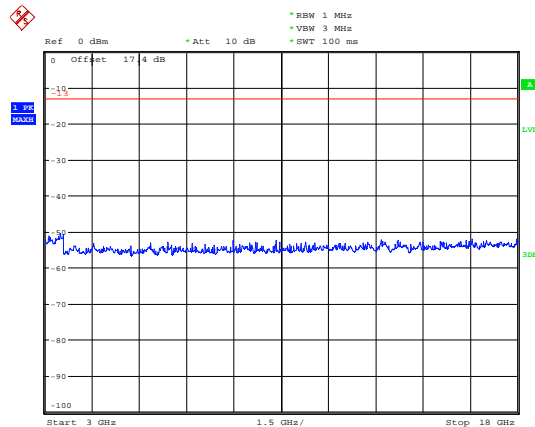

Date: 23.DEC.2018 16:14:16



### LTE Band 4 15MHz CH-High 30MHz~1GHz

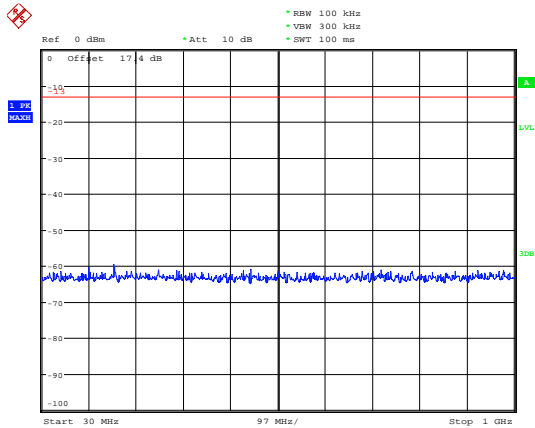

Date: 23.DEC.2018 16:17:15

### LTE Band 4 20MHz CH-Low 30MHz~1GHz

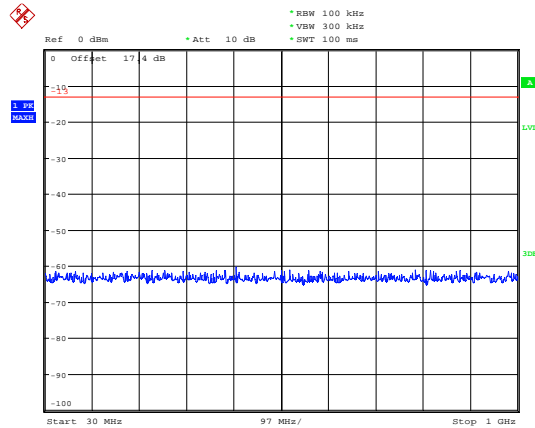

Date: 23.DEC.2018 16:16:11

### LTE Band 4 15MHz CH-High 1GHz~3GHz

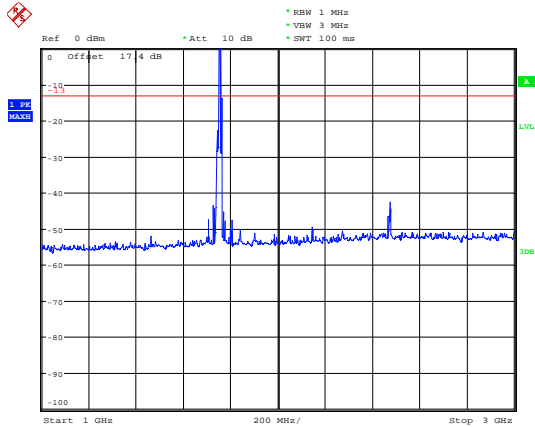

Date: 23.DEC.2018 17:10:48

### LTE Band 4 20MHz CH-Low 1GHz~3GHz

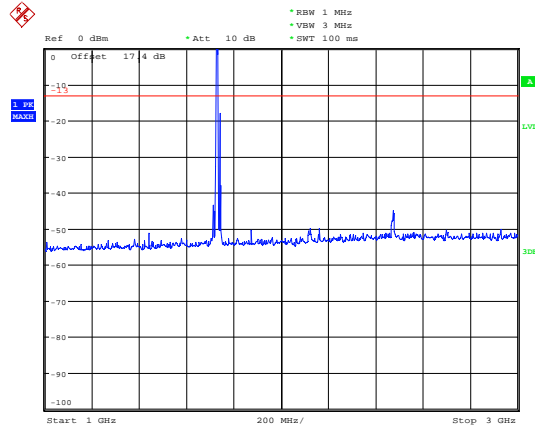

Date: 23.DEC.2018 17:12:19

### LTE Band 4 15MHz CH-High 3GHz~18GHz

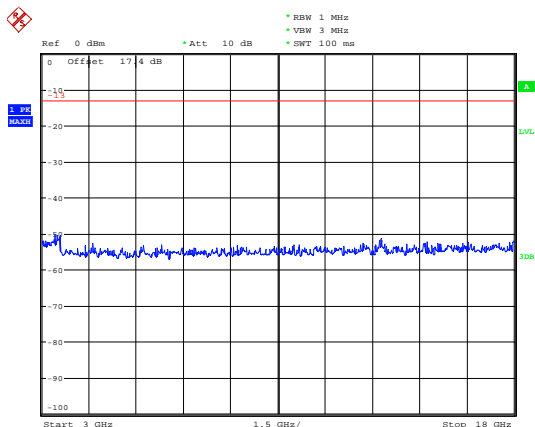

Date: 23.DEC.2018 16:14:40

### LTE Band 4 20MHz CH-Low 3GHz~18GHz

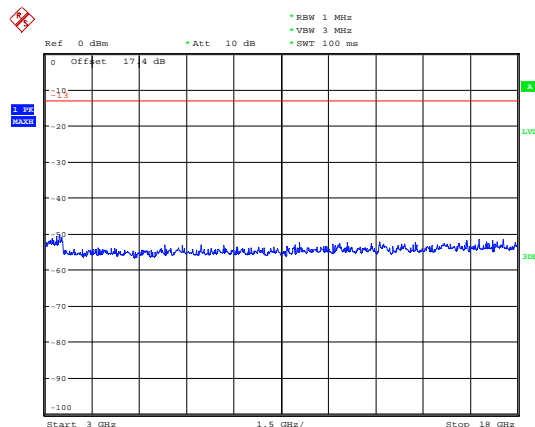

Date: 23.DEC.2018 16:15:02



### LTE Band 4 20MHz CH-Middle 30MHz~1GHz

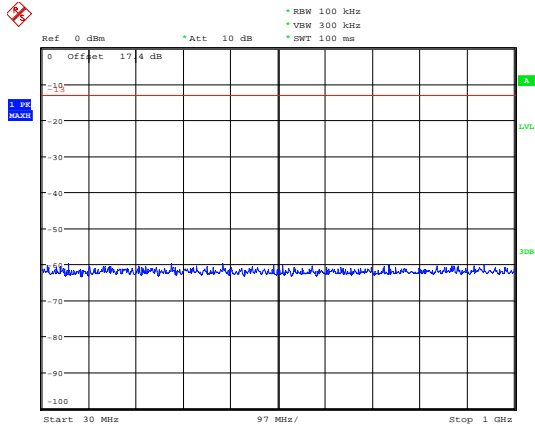

Date: 23.DEC.2018 16:16:03

### LTE Band 4 20MHz CH-High 30MHz~1GHz

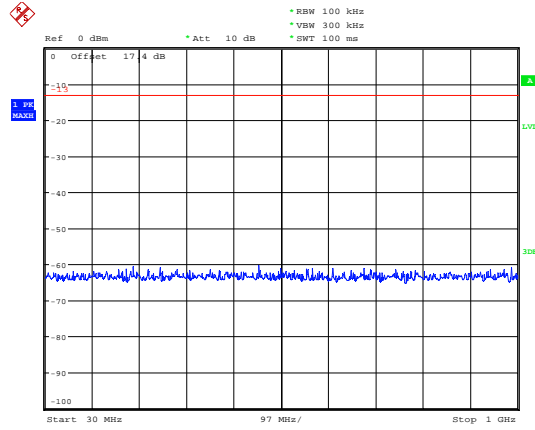

Date: 23.DEC.2018 16:16:20

### LTE Band 4 20MHz CH-Middle 1GHz~3GHz

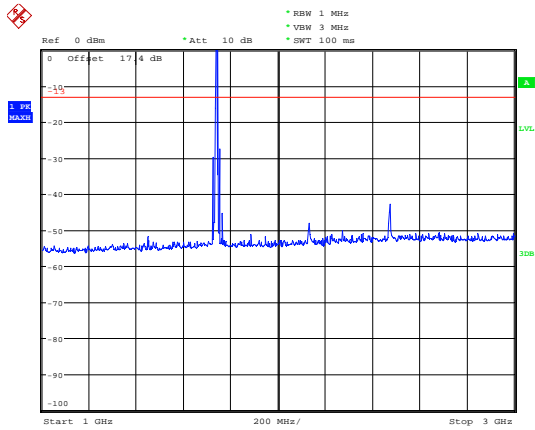

Date: 23.DEC.2018 17:12:39

### LTE Band 4 20MHz CH-High 1GHz~3GHz

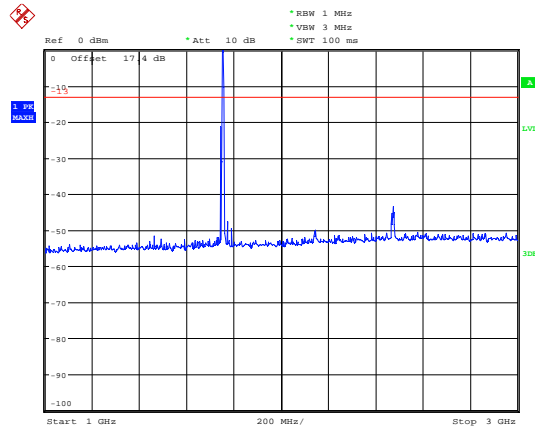

Date: 23.DEC.2018 17:13:49

### LTE Band 4 20MHz CH-Middle 3GHz~18GHz

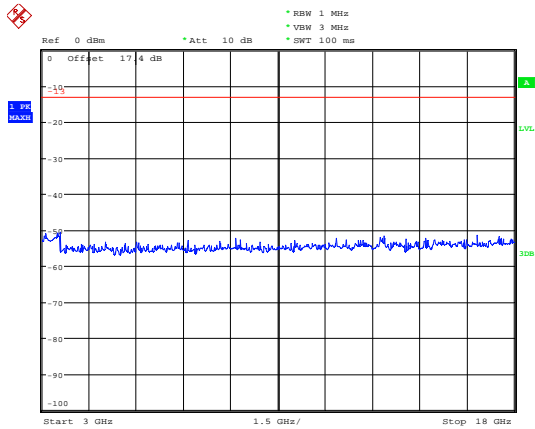

Date: 23.DEC.2018 16:14:55

### LTE Band 4 20MHz CH-High 3GHz~18GHz

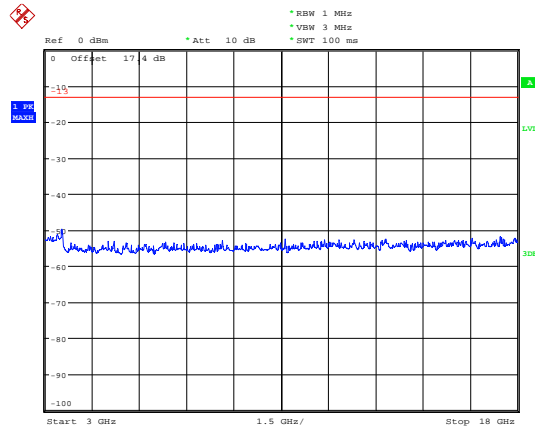

Date: 23.DEC.2018 16:15:10



LTE Band 12 1.4MHz CH-Low 30MHz~1GHz

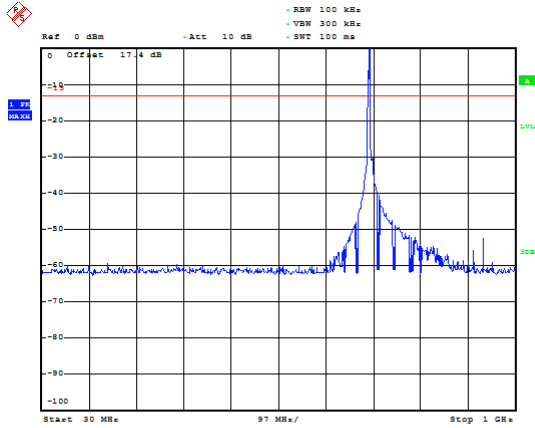

Date: 24.DEC.2018 10:44:32

LTE Band 12 1.4MHz CH-Low 1GHz~9GHz

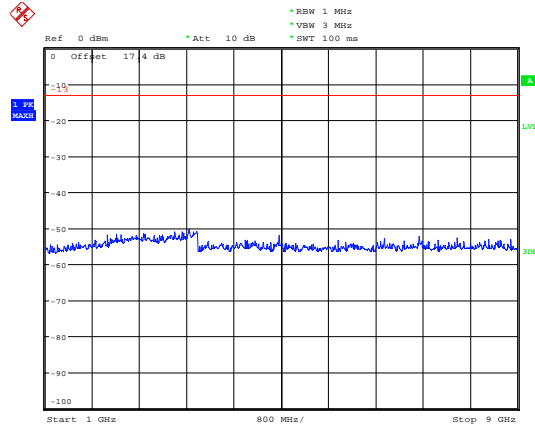

Date: 24.DEC.2018 11:05:11

LTE Band 12 1.4MHz CH- Middle 30MHz~1GHz

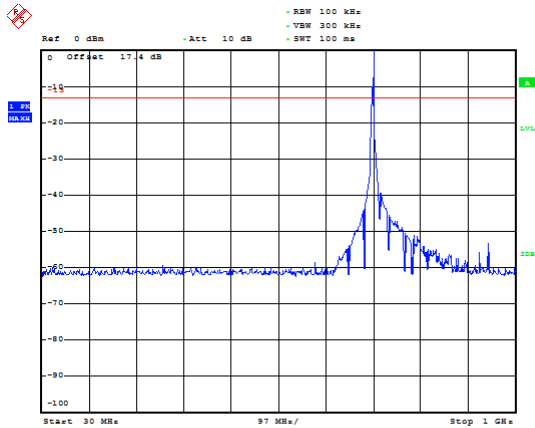

Date: 24.DEC.2018 10:50:54

LTE Band 12 1.4MHz CH- Middle 1GHz~9GHz

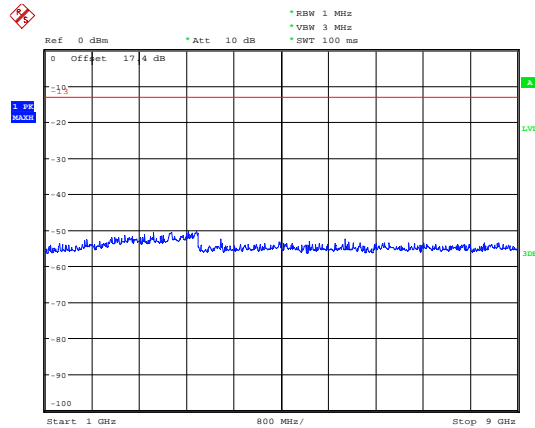

Date: 24.DEC.2018 11:05:38

LTE Band 12 1.4MHz CH-High 30MHz~1GHz

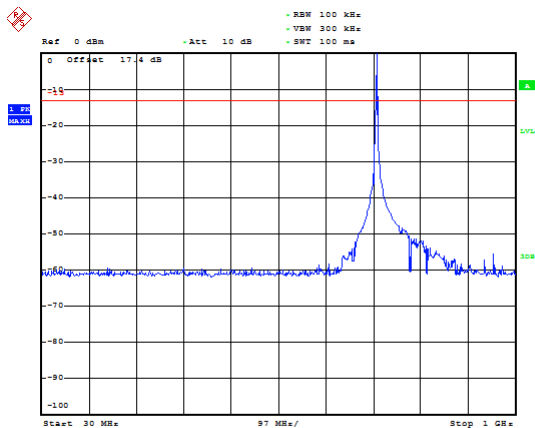

Date: 24.DEC.2018 10:56:50

LTE Band 12 1.4MHz CH-High 1GHz~9GHz

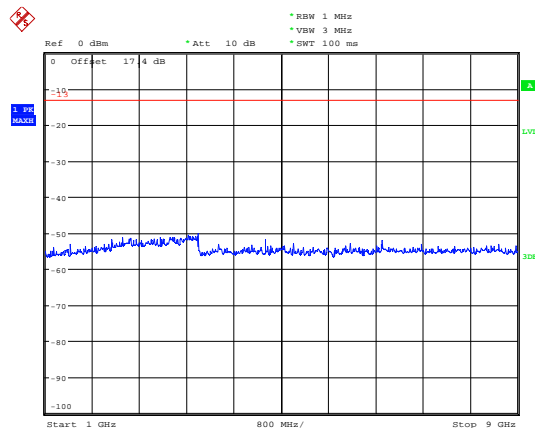

Date: 24.DEC.2018 11:09:03



### LTE Band 12 3MHz CH-Low 30MHz~1GHz

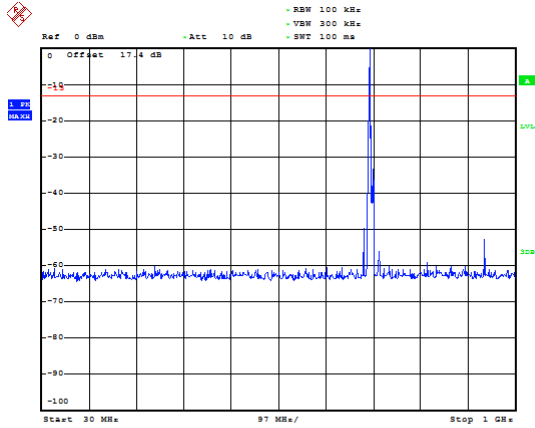

Date: 24.DEC.2018 10:58:15

### LTE Band 12 3MHz CH-Low 1GHz~9GHz

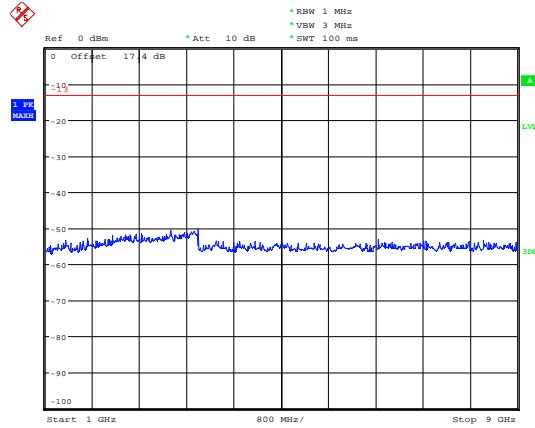

Date: 24.DEC.2018 11:10:25

### LTE Band 12 3MHz CH- Middle 30MHz~1GHz

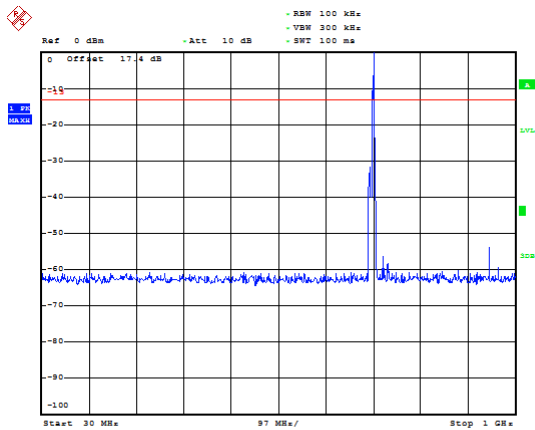

Date: 24.DEC.2018 10:58:53

### LTE Band 12 3MHz CH- Middle 1GHz~9GHz

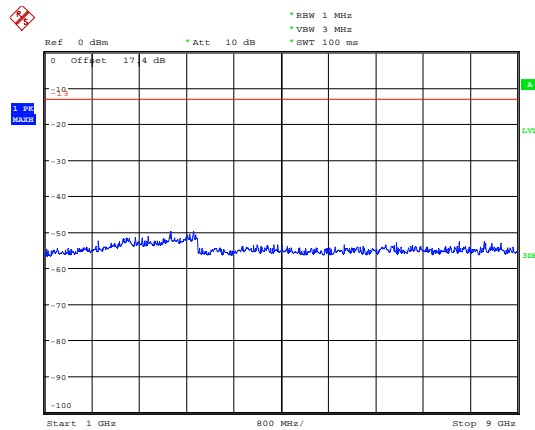

Date: 24.DEC.2018 11:11:37

### LTE Band 12 3MHz CH-High 30MHz~1GHz

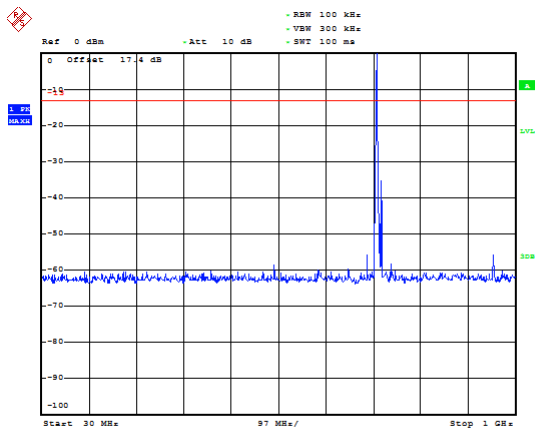

Date: 24.DEC.2018 10:59:27

### LTE Band 12 3MHz CH-High 1GHz~9GHz

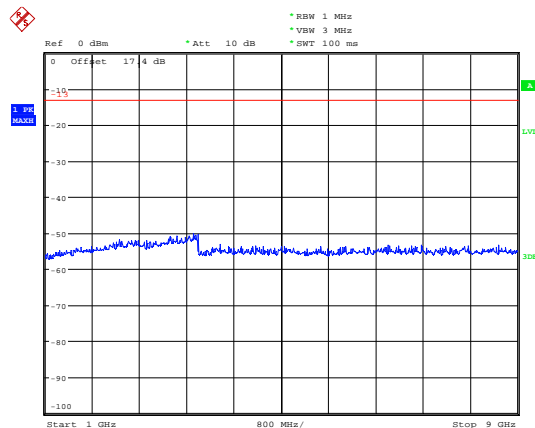

Date: 24.DEC.2018 11:12:16



### LTE Band 12 5MHz CH-Low 30MHz~1GHz

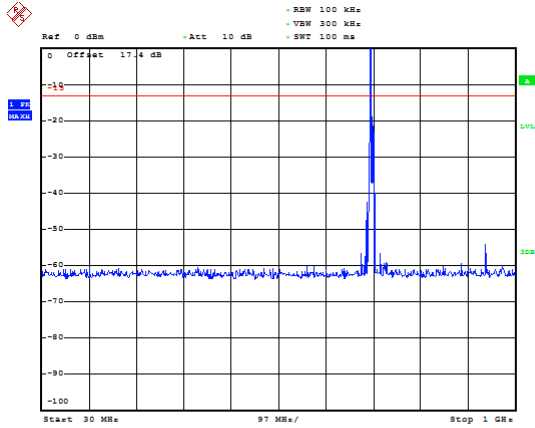

Date: 24.DEC.2018 11:00:11

### LTE Band 12 5MHz CH-Low 1GHz~9GHz

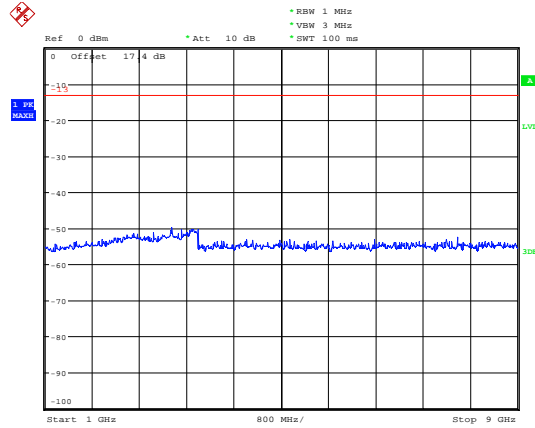

Date: 24.DEC.2018 11:13:17

### LTE Band 12 5MHz CH- Middle 30MHz~1GHz

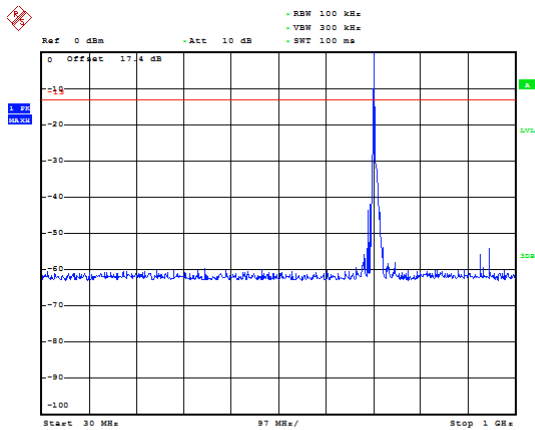

Date: 24.DEC.2018 11:00:53

### LTE Band 12 5MHz CH- Middle 1GHz~9GHz

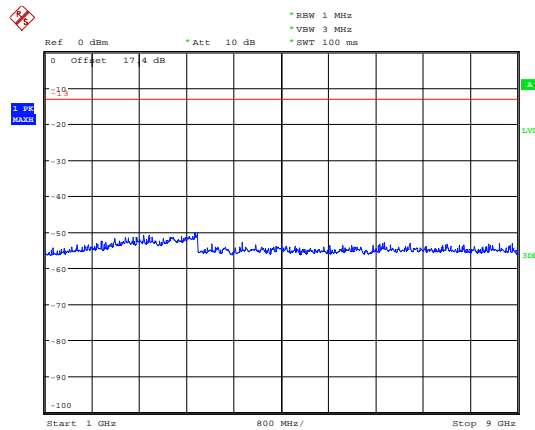

Date: 24.DEC.2018 11:14:59

### LTE Band 12 5MHz CH-High 30MHz~1GHz

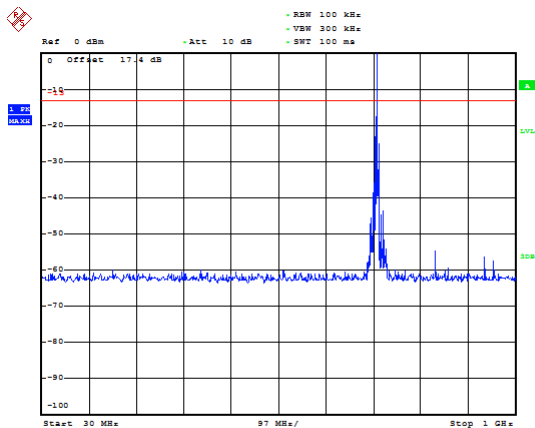

Date: 24.DEC.2018 11:01:49

### LTE Band 12 5MHz CH-High 1GHz~9GHz

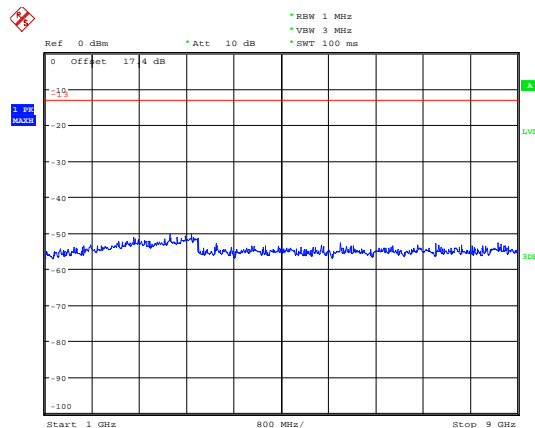

Date: 24.DEC.2018 11:16:19



### LTE Band 12 10MHz CH-Low 30MHz~1GHz

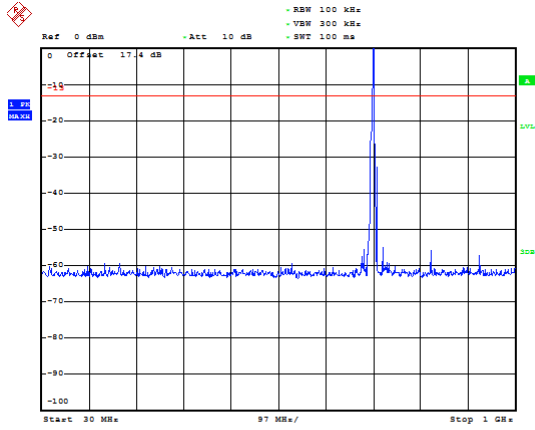

Date: 24.DEC.2018 11:02:36

### LTE Band 12 10MHz CH-Low 1GHz~9GHz

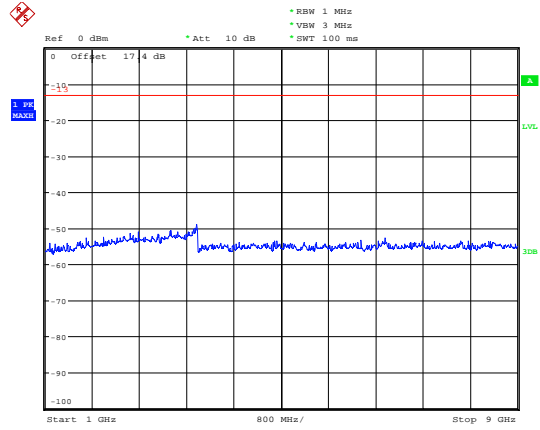

Date: 24.DEC.2018 11:17:04

### LTE Band 12 10MHz CH- Middle 30MHz~1GHz

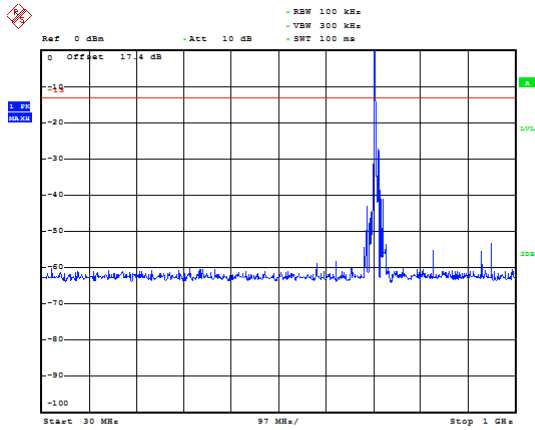

Date: 24.DEC.2018 11:09:16

### LTE Band 12 10MHz CH- Middle 1GHz~9GHz

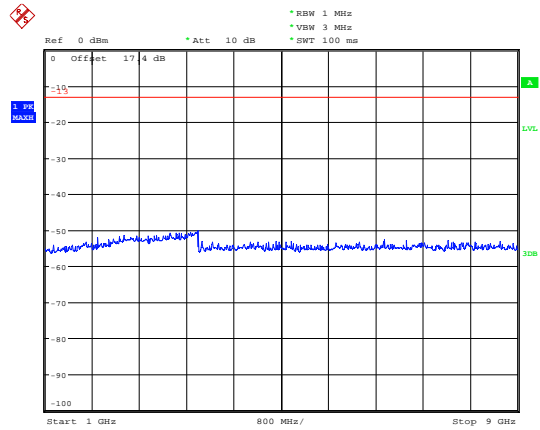

Date: 24.DEC.2018 11:17:44

### LTE Band 12 10MHz CH-High 30MHz~1GHz

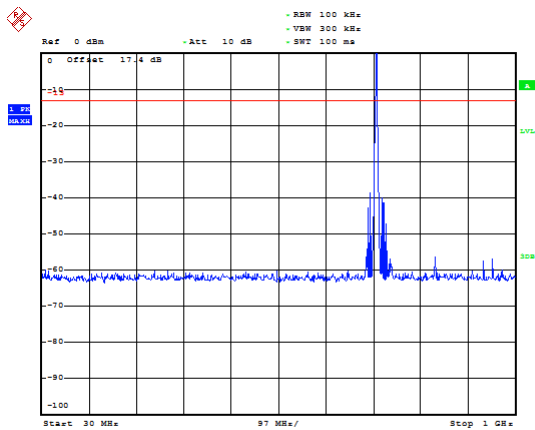

Date: 24.DEC.2018 11:09:50

### LTE Band 12 10MHz CH-High 1GHz~9GHz

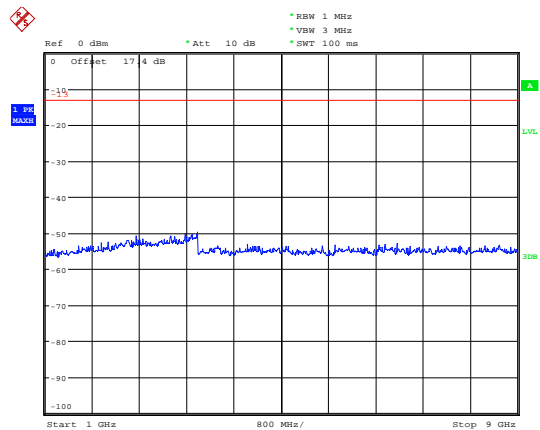

Date: 24.DEC.2018 11:18:38



### LTE Band 13 5MHz CH-Low 30MHz~1GHz

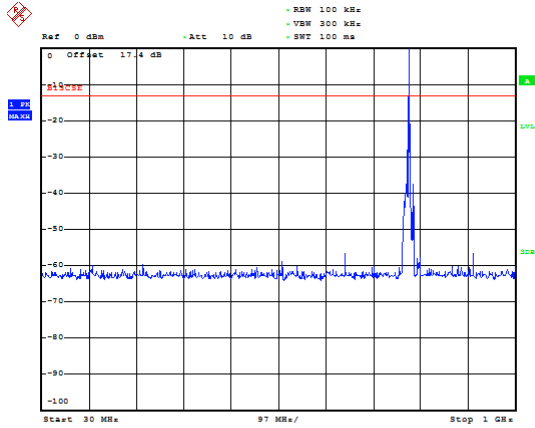

Date: 23.DEC.2018 12:11:29

### LTE Band 13 5MHz CH-Low 1GHz~9GHz

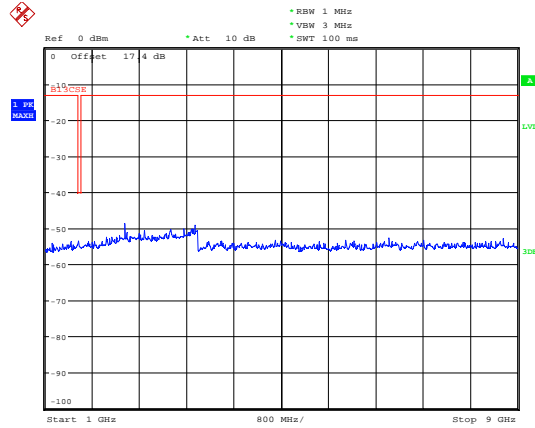

Date: 23.DEC.2018 13:30:26

### LTE Band 13 5MHz CH-Middle 30MHz~1GHz

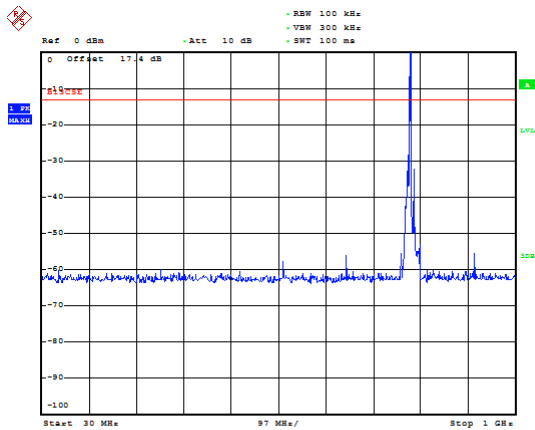

Date: 29.DEC.2018 19:33:44

### LTE Band 13 5MHz CH-Middle 1GHz~9GHz

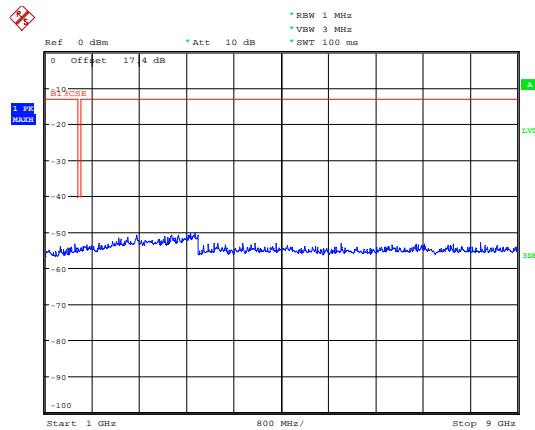

Date: 23.DEC.2018 13:32:48

### LTE Band 13 5MHz CH-High 30MHz~1GHz

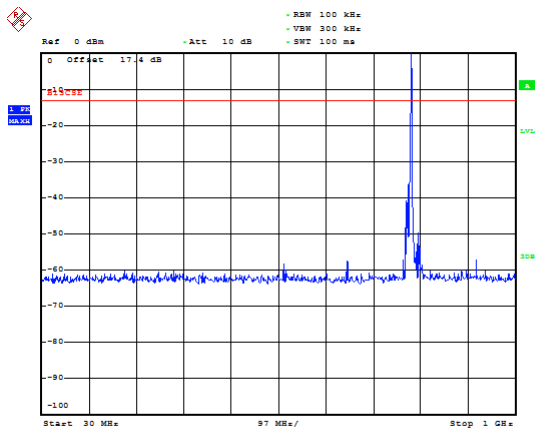

Date: 23.DEC.2018 18:36:45

### LTE Band 13 5MHz CH-High 1GHz~9GHz

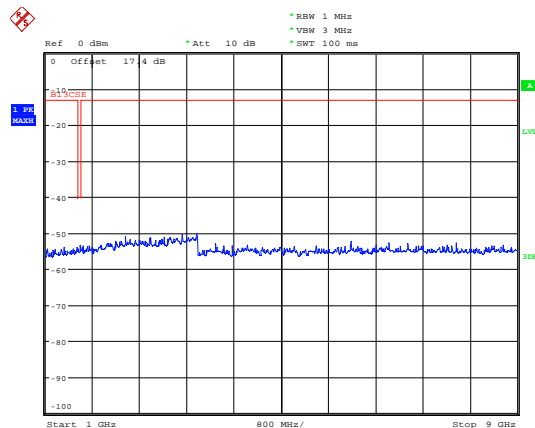

Date: 23.DEC.2018 13:37:28





### LTE Band 13 10MHz CH-Middle 30MHz~1GHz

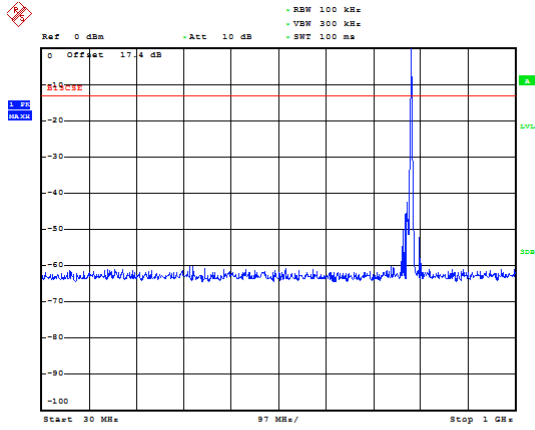

Date: 23.DEC.2018 18:38:44

### LTE Band 13 10MHz CH-Middle 1GHz~9GHz

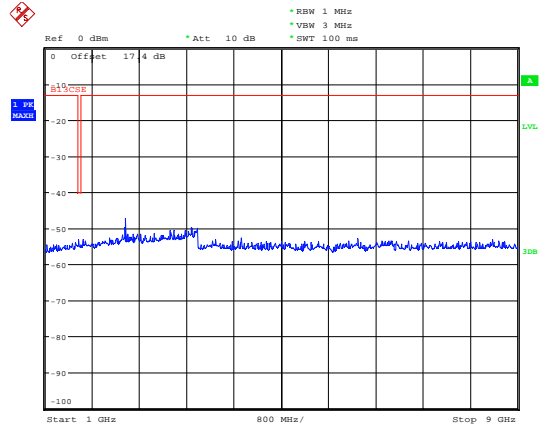

Date: 23.DEC.2018 13:38:08

## 5.8 Radiates Spurious Emission

### Ambient condition

| Temperature | Relative humidity | Pressure |
|-------------|-------------------|----------|
| 23°C ~25°C  | 45%~50%           | 101.5kPa |

### Method of Measurement

- The testing follows FCC KDB 971168 D01 v03r01 Section 5.8 and ANSI C63.26 (2015).
- Below 1GHz: The EUT is placed on a turntable 0.8 meters above the ground in the chamber, 3 meter away from the antenna. The maximal emission value is acquired by adjusting the antenna height, polarisation and turntable azimuth. Normally, the height range of antenna is 1 m to 4 m, the azimuth range of turntable is 0° to 360°, and the receive antenna has two polarizations Vertical (V) and Horizontal (H). Above 1GHz: (Note: the FCC's permission to use 1.5m as an alternative per TCBC Conf call of Dec. 2, 2014.) The EUT is placed on a turntable 1.5 meters above the ground in the chamber, 3 meter away from the antenna. The maximal emission value is acquired by adjusting the antenna height, polarisation and turntable azimuth. Normally, the height range of antenna is 1 m to 4 m, the azimuth range of turntable is 0° to 360°, and the receive antenna has two polarizations Vertical (V) and Horizontal (H).
- A loop antenna, A log-periodic antenna or horn antenna shall be substituted in place of the EUT. The log-periodic antenna will be driven by a signal generator and the level will be adjusted till the same power value on the spectrum analyzer or receiver. The level of the spurious emissions can be calculated through the level of the signal generator, cable loss, the gain of the substitution antenna and the reading of the spectrum analyzer or receiver.
- The EUT is then put into continuously transmitting mode at its maximum power level during the test. Set Test Receiver or Spectrum RBW=200Hz,VBW=600Hz for 9kHz150kHz , RBW=10kHz, VBW=30kHz 150kHz-30MHz ,RBW=100kHz,VBW=300kHz for 30MHz to 1GHz and RBW=1MHz, VBW=3MHz for above 1GHz And the maximum value of the receiver should be recorded as (Pr).
- The EUT shall be replaced by a substitution antenna. In the chamber, an substitution antenna for the frequency band of interest is placed at the reference point of the chamber. An RF Signal source for the frequency band of interest is connected to the substitution antenna with a cable that has been constructed to not interfere with the radiation pattern of the antenna. A power (PMea) is applied to the input of the substitution antenna, and adjust the level of the signal generator output until the value of the receiver reach the previously recorded (Pr). The power of signal source (PMea) is recorded. The test should be performed by rotating the test item and adjusting the receiving antenna polarization.
- A amplifier should be connected to the Signal Source output port. And the cable should be connect between the Amplifier and the Substitution Antenna. The cable loss (Pcl) ,the Substitution Antenna Gain (Ga) and the Amplifier Gain (PAg) should be recorded after test.
- The measurement results are obtained as described below:

$$\text{Power(EIRP)} = \text{PMea} - \text{PAg} - \text{Pcl} + \text{Ga}$$

The measurement results are amend as described below:

$$\text{Power(EIRP)} = \text{PMea} - \text{Pcl} + \text{Ga}$$

- This value is EIRP since the measurement is calibrated using an antenna of known gain (2.15 dBi) and known input power. ERP can be calculated from EIRP by subtracting the gain of the dipole, ERP

= EIRP-2.15dBi.

The modulation mode and RB allocation refer to section 5.1, using the maximum output power configuration.

**Test setup**

**9KHz ~ 30MHz**

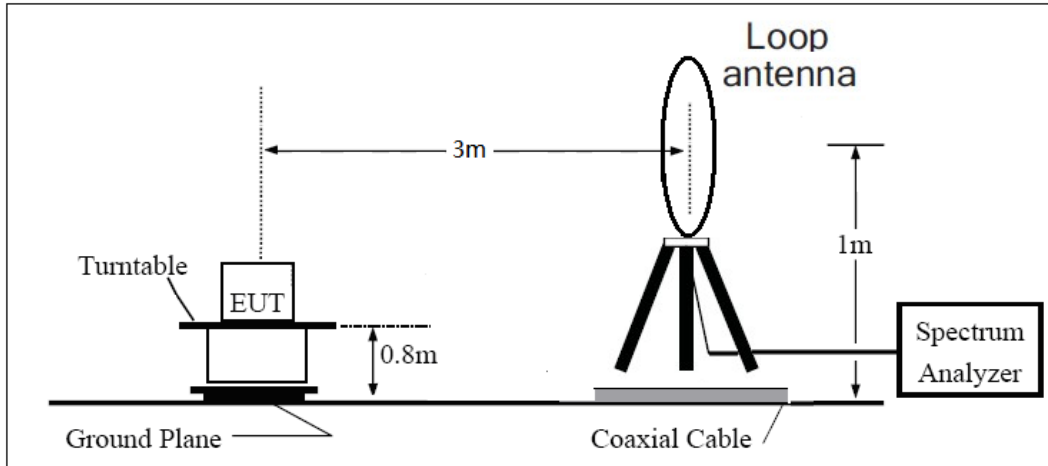

**30MHz ~ 1GHz**

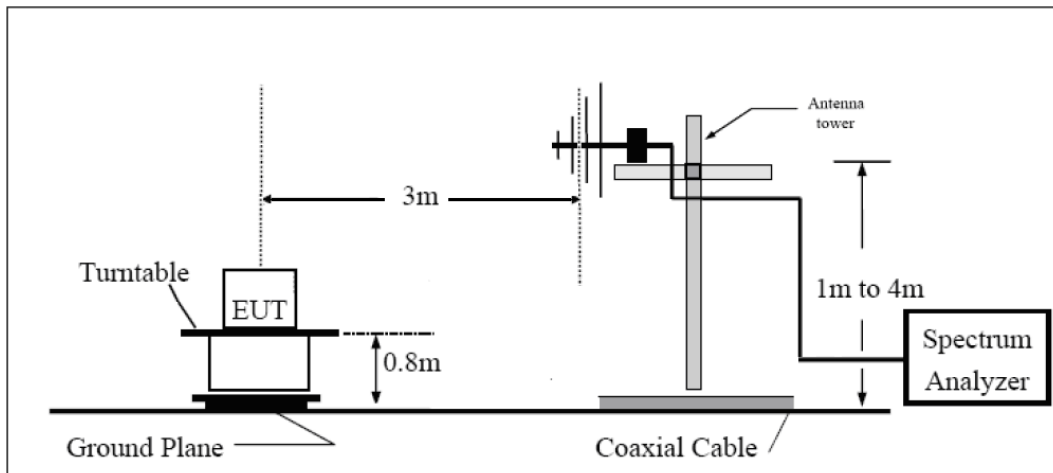

**Above 1GHz**

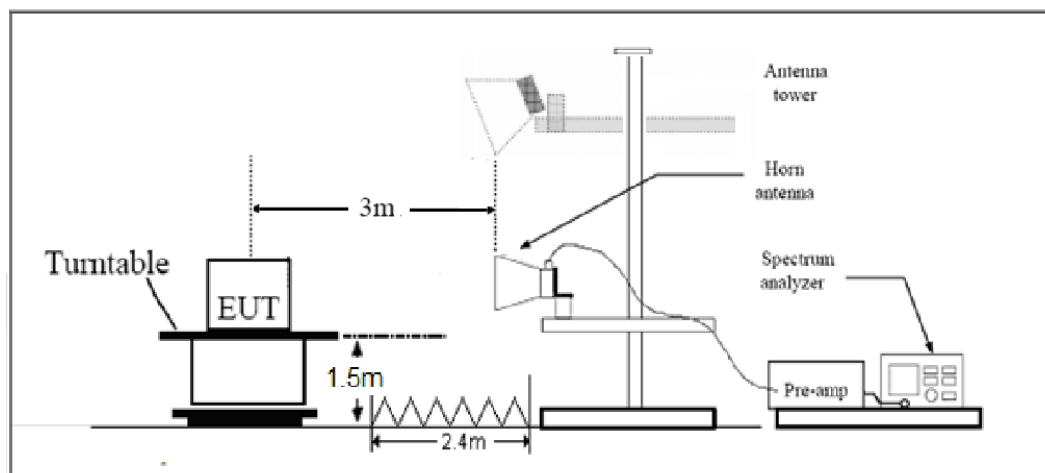

Note: Area side:2.4mX3.6m

**Limits**

Rule Part 27.53(h) specifies that “for operations in the 1695-1710 MHz, 1710-1755 MHz, 1755-1780 MHz, 1915-1920 MHz, 1995-2000 MHz, 2000-2020 MHz, 2110-2155 MHz, 2155-2180 MHz, and 2180-2200 bands, the power of any emission outside a licensee's frequency block shall be attenuated below the transmitter power (P) in watts by at least  $43 + 10 \log_{10} (P)$  dB.”

Rule Part 27.53 (g) For operations in the 600 MHz band and the 698-746 MHz band, the power of any emission outside a licensee's frequency band(s) of operation shall be attenuated below the transmitter power (P) within the licensed band(s) of operation, measured in watts, by at least  $43 + 10 \log (P)$  dB. Compliance with this provision is based on the use of measurement instrumentation employing a resolution bandwidth of 100 kilohertz or greater. However, in the 100 kilohertz bands immediately outside and adjacent to a licensee's frequency block, a resolution bandwidth of at least 30 kHz may be employed.

Rule Part 27.53(f) For operations in the 746-758 MHz, 775-788 MHz, and 805-806 MHz bands, emissions in the band 1559-1610 MHz shall be limited to  $-70$  dBW/MHz equivalent isotropically radiated power (EIRP) for wideband signals, and  $-80$  dBW EIRP for discrete emissions of less than 700 Hz bandwidth. For the purpose of equipment authorization, a transmitter shall be tested with an antenna that is representative of the type that will be used with the equipment in normal operation.

|                         |                                     |         |
|-------------------------|-------------------------------------|---------|
| Part 27.53(h)/(g) Limit |                                     | -13 dBm |
| Part 27.53(f) Limit     | Limit out of the band 1559-1610 MHz | -13 dBm |
|                         | Limit in the band 1559-1610 MHz     | -40 dBm |

**Measurement Uncertainty**

The assessed measurement uncertainty to ensure 95% confidence level for the normal distribution is with the coverage factor  $k = \pm 1.96$ ,  $U = \pm 3.55$  dB.

**Test Result**

Sweep the whole frequency band through the range from 9kHz to the 10th harmonic of the carrier, the emissions below the noise floor will not be recorded in the report.

LTE Band 4 QPSK 20MHz CH-Low, RB 1

| Harmonic | Frequency (MHz) | SG (dBm) | Cable Loss (dB) | Gain (dBi) | Antenna Polarization | EIRP Level (dBm) | Limit (dBm) | Margin (dB) | Azimuth (deg) |
|----------|-----------------|----------|-----------------|------------|----------------------|------------------|-------------|-------------|---------------|
| 2        | 3440.0          | -53.47   | 2.6             | 10.15      | Vertical             | -45.92           | -13.00      | 32.92       | 315           |
| 3        | 5133.4          | -61.86   | 2.4             | 11.35      | Vertical             | -52.91           | -13.00      | 39.91       | 45            |
| 4        | 6880.0          | -57.65   | 4.5             | 10.85      | Vertical             | -51.30           | -13.00      | 38.30       | 180           |
| 5        | 8600.0          | -53.97   | 5.1             | 11.35      | Vertical             | -47.72           | -13.00      | 34.72       | 315           |
| 6        | 10320.0         | -51.94   | 5.3             | 11.95      | Vertical             | -45.29           | -13.00      | 32.29       | 270           |
| 7        | 12040.0         | -51.89   | 5.5             | 13.55      | Vertical             | -43.84           | -13.00      | 30.84       | 135           |
| 8        | 13760.0         | -51.27   | 6.3             | 13.75      | Vertical             | -43.82           | -13.00      | 30.82       | 225           |
| 9        | 15480.0         | -48.77   | 6.7             | 13.85      | Vertical             | -41.62           | -13.00      | 28.62       | 45            |
| 10       | 17200.0         | -50.31   | 6.8             | 14.25      | Vertical             | -42.86           | -13.00      | 29.86       | 90            |

Note: 1.The other Spurious RF Radiated emissions level is no more than noise floor.

2. The worst emission was found in the antenna is Vertical position.

LTE Band 4 QPSK 20MHz CH-Middle, RB 1

| Harmonic | Frequency (MHz) | SG (dBm) | Cable Loss (dB) | Gain (dBi) | Antenna Polarization | EIRP Level (dBm) | Limit (dBm) | Margin (dB) | Azimuth (deg) |
|----------|-----------------|----------|-----------------|------------|----------------------|------------------|-------------|-------------|---------------|
| 2        | 3465.0          | -52.09   | 2.6             | 10.75      | Vertical             | -43.94           | -13.00      | 30.94       | 90            |
| 3        | 5170.9          | -61.02   | 2.4             | 11.05      | Vertical             | -52.37           | -13.00      | 39.37       | 225           |
| 4        | 6930.0          | -57.55   | 4.5             | 11.15      | Vertical             | -50.90           | -13.00      | 37.90       | 225           |
| 5        | 8662.5          | -54.39   | 5.1             | 11.35      | Vertical             | -48.14           | -13.00      | 35.14       | 315           |
| 6        | 10395.0         | -50.99   | 5.3             | 11.95      | Vertical             | -44.34           | -13.00      | 31.34       | 315           |
| 7        | 12127.5         | -51.95   | 5.5             | 13.55      | Vertical             | -43.90           | -13.00      | 30.90       | 0             |
| 8        | 13860.0         | -48.42   | 6.3             | 13.75      | Vertical             | -40.97           | -13.00      | 27.97       | 45            |
| 9        | 15592.5         | -53.45   | 6.7             | 13.85      | Vertical             | -46.30           | -13.00      | 33.30       | 315           |
| 10       | 17325.0         | -50.92   | 6.8             | 14.25      | Vertical             | -43.47           | -13.00      | 30.47       | 90            |

Note: 1.The other Spurious RF Radiated emissions level is no more than noise floor.

2. The worst emission was found in the antenna is Vertical position.

**LTE Band 4 QPSK 20MHz CH-High, RB 1**

| Harmonic | Frequency (MHz) | SG (dBm) | Cable Loss (dB) | Gain (dBi) | Antenna Polarization | EIRP Level (dBm) | Limit (dBm) | Margin (dB) | Azimuth (deg) |
|----------|-----------------|----------|-----------------|------------|----------------------|------------------|-------------|-------------|---------------|
| 2        | 3490.0          | -50.34   | 2.6             | 10.15      | Vertical             | -42.79           | -13.00      | 29.79       | 45            |
| 3        | 5235.0          | -61.76   | 2.4             | 11.05      | Vertical             | -53.11           | -13.00      | 40.11       | 180           |
| 4        | 6980.0          | -57.41   | 4.5             | 11.15      | Vertical             | -50.76           | -13.00      | 37.76       | 315           |
| 5        | 8725.0          | -53.79   | 5.1             | 11.35      | Vertical             | -47.54           | -13.00      | 34.54       | 45            |
| 6        | 10470.0         | -51.60   | 5.3             | 11.95      | Vertical             | -44.95           | -13.00      | 31.95       | 180           |
| 7        | 12215.0         | -51.29   | 5.5             | 13.55      | Vertical             | -43.24           | -13.00      | 30.24       | 315           |
| 8        | 13960.0         | -51.19   | 6.3             | 13.75      | Vertical             | -43.74           | -13.00      | 30.74       | 270           |
| 9        | 15705.0         | -52.75   | 6.7             | 13.85      | Vertical             | -45.60           | -13.00      | 32.60       | 90            |
| 10       | 17450.0         | -50.80   | 6.8             | 14.25      | Vertical             | -43.35           | -13.00      | 30.35       | 90            |

Note: 1.The other Spurious RF Radiated emissions level is no more than noise floor.  
2. The worst emission was found in the antenna is Vertical position.

**LTE Band 12 QPSK 10MHz CH-Low, RB 1**

| Harmonic | Frequency (MHz) | SG (dBm) | Cable Loss (dB) | Gain (dBi) | Antenna Polarization | ERP Level (dBm) | Limit (dBm) | Margin (dB) | Azimuth (deg) |
|----------|-----------------|----------|-----------------|------------|----------------------|-----------------|-------------|-------------|---------------|
| 2        | 1408.0          | -59.27   | 2.00            | 10.15      | Vertical             | -53.27          | -13.00      | 40.27       | 315           |
| 3        | 2112.0          | -59.34   | 2.51            | 11.35      | Vertical             | -52.65          | -13.00      | 39.65       | 90            |
| 4        | 2816.0          | -59.50   | 4.20            | 10.85      | Vertical             | -55.00          | -13.00      | 42.00       | 45            |
| 5        | 3520.0          | -61.93   | 5.20            | 11.35      | Vertical             | -57.93          | -13.00      | 44.93       | 90            |
| 6        | 4224.0          | -60.25   | 5.50            | 11.95      | Vertical             | -55.95          | -13.00      | 42.95       | 90            |
| 7        | 4928.0          | -60.44   | 5.70            | 13.55      | Vertical             | -54.74          | -13.00      | 41.74       | 225           |
| 8        | 5632.0          | -59.96   | 6.30            | 13.75      | Vertical             | -54.66          | -13.00      | 41.66       | 225           |
| 9        | 6336.0          | -57.87   | 6.80            | 13.85      | Vertical             | -52.97          | -13.00      | 39.97       | 90            |
| 10       | 7040.0          | -53.53   | 6.90            | 14.25      | Vertical             | -48.33          | -13.00      | 35.33       | 90            |

Note: 1.The other Spurious RF Radiated emissions level is no more than noise floor.  
2. The worst emission was found in the antenna is Vertical position.

**LTE Band 12 QPSK 10MHz CH-Middle, RB 1**

| Harmonic | Frequency (MHz) | SG (dBm) | Cable Loss (dB) | Gain (dBi) | Antenna Polarization | ERP Level (dBm) | Limit (dBm) | Margin (dB) | Azimuth (deg) |
|----------|-----------------|----------|-----------------|------------|----------------------|-----------------|-------------|-------------|---------------|
| 2        | 1415.0          | -59.67   | 2.00            | 10.75      | Vertical             | -53.07          | -13.00      | 40.07       | 315           |
| 3        | 2122.5          | -59.25   | 2.51            | 11.05      | Vertical             | -52.86          | -13.00      | 39.86       | 90            |
| 4        | 2830.0          | -59.82   | 4.20            | 11.15      | Vertical             | -55.02          | -13.00      | 42.02       | 45            |
| 5        | 3537.5          | -61.74   | 5.20            | 11.15      | Vertical             | -57.94          | -13.00      | 44.94       | 225           |
| 6        | 4245.0          | -60.42   | 5.50            | 11.95      | Vertical             | -56.12          | -13.00      | 43.12       | 225           |
| 7        | 4952.5          | -60.19   | 5.70            | 13.55      | Vertical             | -54.49          | -13.00      | 41.49       | 315           |
| 8        | 5660.0          | -59.04   | 6.30            | 13.75      | Vertical             | -53.74          | -13.00      | 40.74       | 315           |
| 9        | 6367.5          | -57.35   | 6.80            | 13.85      | Vertical             | -52.45          | -13.00      | 39.45       | 0             |
| 10       | 7075.0          | -53.90   | 6.90            | 14.25      | Vertical             | -48.70          | -13.00      | 35.70       | 45            |

Note: 1.The other Spurious RF Radiated emissions level is no more than noise floor.  
 2. The worst emission was found in the antenna is Vertical position.

**LTE Band 12 QPSK 10MHz CH-High, RB 1**

| Harmonic | Frequency (MHz) | SG (dBm) | Cable Loss (dB) | Gain (dBi) | Antenna Polarization | ERP Level (dBm) | Limit (dBm) | Margin (dB) | Azimuth (deg) |
|----------|-----------------|----------|-----------------|------------|----------------------|-----------------|-------------|-------------|---------------|
| 2        | 1422.0          | -59.03   | 2.00            | 10.15      | Vertical             | -53.03          | -13.00      | 40.03       | 180           |
| 3        | 2133.0          | -57.60   | 2.51            | 11.05      | Vertical             | -51.21          | -13.00      | 38.21       | 315           |
| 4        | 2844.0          | -59.08   | 4.20            | 11.15      | Vertical             | -54.28          | -13.00      | 41.28       | 45            |
| 5        | 3555.0          | -61.16   | 5.20            | 11.15      | Vertical             | -57.36          | -13.00      | 44.36       | 315           |
| 6        | 4266.0          | -60.19   | 5.50            | 11.95      | Vertical             | -55.89          | -13.00      | 42.89       | 90            |
| 7        | 4977.0          | -59.45   | 5.70            | 13.55      | Vertical             | -53.75          | -13.00      | 40.75       | 45            |
| 8        | 5688.0          | -59.01   | 6.30            | 13.75      | Vertical             | -53.71          | -13.00      | 40.71       | 315           |
| 9        | 6399.0          | -57.42   | 6.80            | 13.85      | Vertical             | -52.52          | -13.00      | 39.52       | 90            |
| 10       | 7110.0          | -53.14   | 6.90            | 14.25      | Vertical             | -47.94          | -13.00      | 34.94       | 45            |

Note: 1.The other Spurious RF Radiated emissions level is no more than noise floor.  
 2. The worst emission was found in the antenna is Vertical position.

**LTE Band 13 QPSK 10MHz CH-Low, RB 1**

| Harmonic | Frequency (MHz) | SG (dBm) | Cable Loss (dB) | Gain (dBi) | Antenna Polarization | ERP Level (dBm) | Limit (dBm) | Margin (dB) | Azimuth (deg) |
|----------|-----------------|----------|-----------------|------------|----------------------|-----------------|-------------|-------------|---------------|
| 2        | 1556.5          | -61.40   | 2.00            | 10.15      | Vertical             | -55.40          | -40.00      | 15.40       | 90            |
| 3        | 2346.0          | -42.67   | 2.51            | 11.35      | Vertical             | -35.98          | -13.00      | 22.98       | 90            |
| 4        | 3128.0          | -61.67   | 4.20            | 10.85      | Vertical             | -57.17          | -13.00      | 44.17       | 225           |
| 5        | 3910.0          | -60.84   | 5.20            | 11.35      | Vertical             | -56.84          | -13.00      | 43.84       | 315           |
| 6        | 4692.0          | -60.02   | 5.50            | 11.95      | Vertical             | -55.72          | -13.00      | 42.72       | 315           |
| 7        | 5474.0          | -60.18   | 5.70            | 13.55      | Vertical             | -54.48          | -13.00      | 41.48       | 0             |
| 8        | 6256.0          | -58.27   | 6.30            | 13.75      | Vertical             | -52.97          | -13.00      | 39.97       | 45            |
| 9        | 7038.0          | -54.56   | 6.80            | 13.85      | Vertical             | -49.66          | -13.00      | 36.66       | 90            |
| 10       | 7820.0          | -53.73   | 6.90            | 14.25      | Vertical             | -48.53          | -13.00      | 35.53       | 90            |

Note: 1.The other Spurious RF Radiated emissions level is no more than noise floor.  
2. The worst emission was found in the antenna is Vertical position.

**LTE Band 13 QPSK 10MHz CH-Middle, RB 1**

| Harmonic | Frequency (MHz) | SG (dBm) | Cable Loss (dB) | Gain (dBi) | Antenna Polarization | ERP Level (dBm) | Limit (dBm) | Margin (dB) | Azimuth (deg) |
|----------|-----------------|----------|-----------------|------------|----------------------|-----------------|-------------|-------------|---------------|
| 2        | 1555.3          | -61.44   | 2.00            | 10.75      | Vertical             | -54.84          | -40.00      | 14.84       | 225           |
| 3        | 2346.0          | -42.26   | 2.51            | 11.05      | Vertical             | -35.87          | -13.00      | 22.87       | 225           |
| 4        | 3128.0          | -59.89   | 4.20            | 11.15      | Vertical             | -55.09          | -13.00      | 42.09       | 225           |
| 5        | 3910.0          | -59.93   | 5.20            | 11.15      | Vertical             | -56.13          | -13.00      | 43.13       | 225           |
| 6        | 4692.0          | -58.69   | 5.50            | 11.95      | Vertical             | -54.39          | -13.00      | 41.39       | 315           |
| 7        | 5474.0          | -60.51   | 5.70            | 13.55      | Vertical             | -54.81          | -13.00      | 41.81       | 315           |
| 8        | 6256.0          | -58.79   | 6.30            | 13.75      | Vertical             | -53.49          | -13.00      | 40.49       | 0             |
| 9        | 7038.0          | -54.29   | 6.80            | 13.85      | Vertical             | -49.39          | -13.00      | 36.39       | 45            |
| 10       | 7820.0          | -54.61   | 6.90            | 14.25      | Vertical             | -49.41          | -13.00      | 36.41       | 315           |

Note: 1.The other Spurious RF Radiated emissions level is no more than noise floor.  
2. The worst emission was found in the antenna is Vertical position.



**LTE Band 13 QPSK 10MHz CH-High, RB 1**

| Harmonic | Frequency (MHz) | SG (dBm) | Cable Loss (dB) | Gain (dBi) | Antenna Polarization | ERP Level (dBm) | Limit (dBm) | Margin (dB) | Azimuth (deg) |
|----------|-----------------|----------|-----------------|------------|----------------------|-----------------|-------------|-------------|---------------|
| 2        | 1564.0          | -62.12   | 2.00            | 10.15      | Vertical             | -56.12          | -40.00      | 16.12       | 90            |
| 3        | 2346.0          | -42.66   | 2.51            | 11.05      | Vertical             | -36.27          | -13.00      | 23.27       | 90            |
| 4        | 3128.0          | -62.46   | 4.20            | 11.15      | Vertical             | -57.66          | -13.00      | 44.66       | 90            |
| 5        | 3910.0          | -58.99   | 5.20            | 11.15      | Vertical             | -55.19          | -13.00      | 42.19       | 225           |
| 6        | 4692.0          | -59.30   | 5.50            | 11.95      | Vertical             | -55.00          | -13.00      | 42.00       | 315           |
| 7        | 5474.0          | -60.11   | 5.70            | 13.55      | Vertical             | -54.41          | -13.00      | 41.41       | 315           |
| 8        | 6256.0          | -57.89   | 6.30            | 13.75      | Vertical             | -52.59          | -13.00      | 39.59       | 0             |
| 9        | 7038.0          | -53.97   | 6.80            | 13.85      | Vertical             | -49.07          | -13.00      | 36.07       | 45            |
| 10       | 7820.0          | -54.17   | 6.90            | 14.25      | Vertical             | -48.97          | -13.00      | 35.97       | 90            |

Note: 1.The other Spurious RF Radiated emissions level is no more than noise floor.  
2. The worst emission was found in the antenna is Vertical position.

## 6 Main Test Instruments

| Name                   | Manufacturer | Type         | Serial Number | Calibration Date | Expiration Date |
|------------------------|--------------|--------------|---------------|------------------|-----------------|
| Base Station Simulator | R&S          | CMW500       | 113824        | 2018-05-20       | 2019-05-19      |
| Power Splitter         | Hua Xiang    | SHX-GF2-2-13 | 10120101      | /                | /               |
| Spectrum Analyzer      | Key sight    | N9010A       | MY50210259    | 2018-05-20       | 2019-05-19      |
| Signal Analyzer        | R&S          | FSV30        | 100815        | 2018-12-16       | 2019-12-15      |
| EMI Test Receiver      | R&S          | ESCI         | 100948        | 2018-05-20       | 2019-05-19      |
| Loop Antenna           | SCHWARZBECK  | FMZB1519     | 1519-047      | 2017-09-26       | 2019-09-25      |
| Trilog Antenna         | SCHWARZBECK  | VUBL 9163    | 9163-201      | 2017-11-18       | 2019-11-17      |
| Horn Antenna           | R&S          | HF907        | 100126        | 2018-07-07       | 2020-07-06      |
| Horn Antenna           | ETS-Lindgren | 3160-09      | 00102643      | 2018-06-20       | 2020-06-19      |
| Signal generator       | R&S          | SMB 100A     | 102594        | 2018-05-20       | 2019-05-19      |
| Climatic Chamber       | ESPEC        | SU-242       | 93000506      | 2017-12-17       | 2020-12-16      |
| Preamplifier           | R&S          | SCU18        | 102327        | 2018-05-20       | 2019-05-19      |
| MOB COMMS DC SUPPLY    | Keysight     | 66319D       | MY43004105    | 2018-05-21       | 2019-05-20      |
| RF Cable               | Agilent      | SMA 15cm     | 0001          | /                | /               |
| Software               | R&S          | EMC32        | 9.26.0        | /                | /               |

\*\*\*\*\*END OF REPORT \*\*\*\*\*

## ANNEX A: EUT Appearance and Test Setup

### A.1 EUT Appearance



Front Side

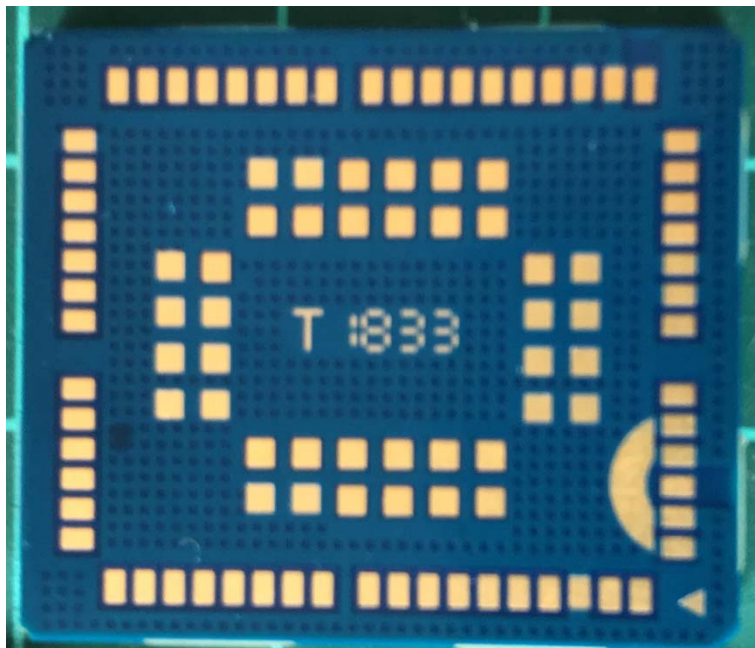

Back Side

Picture 1 EUT

## A.2 Test Setup



Picture 2 Radiated Spurious Emissions Test setup