



# RF TEST REPORT

**Applicant**      Quectel Wireless Solutions Co., Ltd  
**FCC ID**          XMR201901BG96M  
**Product**        LTE Cat M1 module  
**Brand**            Quectel  
**Model**            BG96-M  
**Report No.**      R1811A0537-R2V1  
**Issue Date**      March 26, 2019

TA Technology (Shanghai) Co., Ltd. tested the above equipment in accordance with the requirements in **FCC CFR47 Part 2 (2018)/ FCC CFR 47 Part 24E (2018)**. The test results show that the equipment tested is capable of demonstrating compliance with the requirements as documented in this report.

*Performed by: Peng Tao*

*Approved by: Kai Xu*

---

## TA Technology (Shanghai) Co., Ltd.

*No.145, Jintang Rd, Tangzhen Industry Park, Pudong Shanghai, China*

*TEL: +86-021-50791141/2/3*

*FAX: +86-021-50791141/2/3-8000*



## TABLE OF CONTENT

1. Test Laboratory .....	4
1.1. Notes of the test report.....	4
1.2. Test facility.....	4
1.3. Testing Location .....	5
2. General Description of Equipment under Test.....	6
3. Applied Standards.....	7
4. Test Configuration.....	8
5. Test Case Results.....	9
5.1. RF Power Output.....	9
5.2. Effective Isotropic Radiated Power .....	12
5.3. Occupied Bandwidth .....	17
5.4. Band Edge Compliance.....	23
5.5. Peak-to-Average Power Ratio (PAPR) .....	40
5.6. Frequency Stability .....	42
5.7. Spurious Emissions at Antenna Terminals .....	47
5.8. Radiates Spurious Emission .....	66
6. Main Test Instruments .....	72
ANNEX A: EUT Appearance and Test Setup.....	73
A.1 EUT Appearance .....	73
A.2 Test Setup.....	73



## Summary of measurement results

No.	Test Case	Clause in FCC rules	Verdict
1	RF power output	2.1046	PASS
2	Effective Isotropic Radiated power	24.232(c)	PASS
3	Occupied Bandwidth	2.1049	PASS
4	Band Edge Compliance	2.1051 /24.238(a)	PASS
5	Peak-to-Average Power Ratio	24.232/KDB 971168 D01(5.7)	PASS
6	Frequency Stability	2.1055 / 24.235	PASS
7	Spurious Emissions at Antenna Terminals	2.1051 / 24.238(a)	PASS
8	Radiates Spurious Emission	2.1053 / 24.238(a)	PASS
Date of Testing: December 20, 2018~ January 10, 2019			
Note: PASS: The EUT complies with the essential requirements in the standard. FAIL: The EUT does not comply with the essential requirements in the standard.			

## 1. Test Laboratory

### 1.1. Notes of the test report

This report shall not be reproduced in full or partial, without the written approval of **TA technology (shanghai) co., Ltd.** The results documented in this report apply only to the tested sample, under the conditions and modes of operation as described herein. Measurement Uncertainties were not taken into account and are published for informational purposes only. This report is written to support regulatory compliance of the applicable standards stated above.

### 1.2. Test facility

#### **CNAS (accreditation number: L2264)**

TA Technology (Shanghai) Co., Ltd. has obtained the accreditation of China National Accreditation Service for Conformity Assessment (CNAS).

#### **FCC (Designation number: CN1179, Test Firm Registration Number: 446626)**

TA Technology (Shanghai) Co., Ltd. has been listed on the US Federal Communications Commission list of test facilities recognized to perform electromagnetic emissions measurements.

#### **IC (recognition number is 8510A)**

TA Technology (Shanghai) Co., Ltd. has been listed by industry Canada to perform electromagnetic emission measurement.

#### **VCCI (recognition number is C-4595, T-2154, R-4113, G-10766)**

TA Technology (Shanghai) Co., Ltd. has been listed by industry Japan to perform electromagnetic emission measurement.

#### **A2LA (Certificate Number: 3857.01)**

TA Technology (Shanghai) Co., Ltd. has been listed by American Association for Laboratory Accreditation to perform electromagnetic emission measurement.



### 1.3. Testing Location

Company: TA Technology (Shanghai) Co., Ltd.  
Address: No.145, Jintang Rd, Tangzhen Industry Park, Pudong  
City: Shanghai  
Post code: 201201  
Country: P. R. China  
Contact: Xu Kai  
Telephone: +86-021-50791141/2/3  
Fax: +86-021-50791141/2/3-8000  
Website: <http://www.ta-shanghai.com>  
E-mail: [xukai@ta-shanghai.com](mailto:xukai@ta-shanghai.com)

## 2. General Description of Equipment under Test

### Client Information

Applicant	Quectel Wireless Solutions Co., Ltd
Applicant address	7th Floor, Hongye Building, No.1801 Hongmei Road, Xuhui District, Shanghai 200233, China
Manufacturer	Quectel Wireless Solutions Co., Ltd
Manufacturer address	7th Floor, Hongye Building, No.1801 Hongmei Road, Xuhui District, Shanghai 200233, China

### General information

EUT Description			
Model	BG96-M		
IMEI	864834040000348		
Hardware Version	R1.0		
Software Version	BG96MMAR04A01M1G		
Power Supply	External Power Supply		
Antenna Type	The EUT don't have standard Antenna, The Antenna used for testing in this report is the after-market accessory (Dipole Antenna)		
Antenna Gain	4 dBi		
Test Mode(s)	LTE Band 2/25;		
Test Modulation	QPSK,16QAM		
LTE Category	M1		
Maximum E.I.R.P	LTE Band 2:	21.81 dBm	
	LTE Band 25:	22.99 dBm	
Rated Power Supply Voltage	3.8V		
Extreme Voltage	Minimum: 3.3V    Maximum: 4.3V		
Extreme Temperature	Lowest: -40°C    Highest: +85°C		
Operating Frequency Range(s)	Band	Tx (MHz)	Rx (MHz)
	LTE Band 2	1850 ~ 1910	1930 ~ 1990
	LTE Band 25	1850 ~ 1915	1930 ~ 1995
Note: 1. The information of the EUT is declared by the manufacturer.			



### **3. Applied Standards**

According to the specifications of the manufacturer, it must comply with the requirements of the following standards:

**FCC CFR47 Part 2 (2018)**

**FCC CFR 47 Part 24E (2018)**

**ANSI C63.26 (2015)**

**KDB 971168 D01 Power Meas License Digital Systems v03r01**

### 4. Test Configuration

Radiated measurements are performed by rotating the EUT in three different orthogonal test planes. EUT stand-up position (Z axis), lie-down position (X, Y axis). Receiver antenna polarization (horizontal and vertical), the worst emission was found in position (X axis, vertical polarization) and the worst case was recorded.

All mode and data rates and positions and RB size and modulations were investigated.

Subsequently, only the worst case emissions are reported.

The following testing in LTE is set based on the maximum RF Output Power.

Test modes are chosen to be reported as the worst case configuration below for LTE Band 2/25:

Test items	Bandwidth (MHz)						Modulation		RB			Test Channel		
	1.4	3	5	10	15	20	QPSK	16QAM	1	50%	100%	L	M	H
RF power output	O	O	O	O	O	O	O	O	O	O	O	O	O	O
Effective Isotropic Radiated power	O	O	O	O	O	O	O	O	O	O	O	O	O	O
Occupied Bandwidth	O	O	O	O	O	O	O	O	-	-	O	-	O	-
Band Edge Compliance	O	O	O	O	O	O	O	O	O	-	O	O	-	O
Peak-to-Average Power Ratio	O	O	O	O	O	O	O	O	-	-	O	O	O	O
Frequency Stability	O	O	O	O	O	O	O	O	O	O	O	O	O	O
Conducted Spurious Emissions	O	O	O	O	O	O	O	-	O	-	-	O	O	O
Radiates Spurious Emission	-	-	-	-	-	O	O	-	O	-	-	O	O	O
Note	1. The mark "O" means that this configuration is chosen for testing. 2. The mark "-" means that this configuration is not testing.													



## 5. Test Case Results

### 5.1.RF Power Output

#### Ambient condition

Temperature	Relative humidity	Pressure
23°C ~25°C	45%~50%	101.5kPa

#### Methods of Measurement

During the process of the testing, The EUT is controlled by the Base Station Simulator to ensure max power transmission and proper modulation.

#### Test Setup

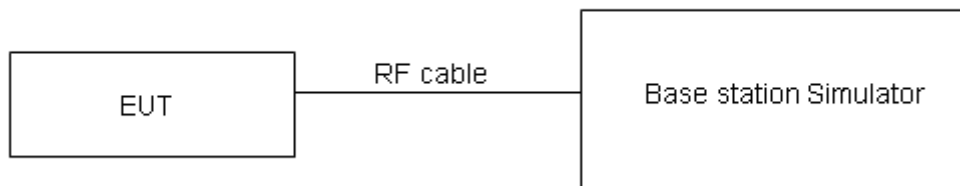

The loss between RF output port of the EUT and the input port of the tester has been taken into consideration.

#### Limits

No specific RF power output requirements in part 2.1046.

#### Measurement Uncertainty

The assessed measurement uncertainty to ensure 95% confidence level for the normal distribution is with the coverage factor  $k = 2$ ,  $U = 0.4$  dB.



## Test Results

LTE Band 2	Channel/ Frequency(MHz)	Index	RB# RB start	Conducted Power (dBm)	
				QPSK	16QAM
1.4MHz	18607/1850.7	0	1#0	22.60	22.96
		0	6#0	22.94	22.93
	18900/1880	0	1#0	22.37	22.79
		0	6#0	22.65	22.62
	19193/1909.3	0	1#5	22.39	22.81
		0	6#0	22.48	22.54
3MHz	18615/1851.5	0	1#0	22.58	22.93
		0	6#0	22.73	22.74
	18900/1880	0	1#0	22.36	22.75
		0	6#0	22.63	22.76
	19185/1908.5	1	1#5	22.42	23.01
		1	6#0	22.63	22.61
5MHz	18625/1852.5	3	1#0	22.37	23.00
		0	6#0	22.65	22.77
	18900/1880	0	1#0	22.38	22.87
		0	6#0	22.46	22.59
	19175/1907.5	0	1#5	22.21	22.74
		3	6#0	22.52	22.64
10MHz	18650/1855	3	1#0	22.47	23.03
		0	4#0	22.61	22.26
	18900/1880	0	1#0	22.39	22.87
		0	4#0	22.40	22.16
	19150/1905	4	1#5	22.18	22.83
		7	4#2	22.50	22.20
15MHz	18675/1857.5	3	1#0	22.41	23.48
		0	6#0	22.64	22.84
	18900/1880	0	1#0	22.27	22.75
		0	6#0	22.39	22.79
	19125/1902.5	8	1#5	22.36	22.82
		11	6#0	22.45	22.38
20MHz	18700/1860	3	1#0	22.34	23.22
		0	6#0	22.64	22.77
	18900/1880	0	1#0	22.34	23.13
		0	6#0	22.48	22.80
	19100/1900	12	1#5	22.53	22.54
		15	6#0	22.43	22.65



LTE Band 25	Channel/ Frequency(MHz)	Index	RB# RB start	Conducted Power (dBm)	
				QPSK	16QAM
1.4MHz	26047/1850.7	0	1#0	22.50	23.30
		0	6#0	22.76	22.96
	26365/1882.5	0	1#0	22.77	22.37
		0	6#0	22.73	23.11
	26683/1914.3	0	1#5	22.76	22.14
		0	6#0	22.61	23.08
3MHz	26055/1851.5	0	1#0	23.10	22.61
		0	6#0	22.97	23.36
	26365/1882.5	0	1#0	22.93	22.44
		0	6#0	22.78	23.08
	26675/1913.5	1	1#5	22.70	22.90
		1	6#0	22.48	22.85
5MHz	26065/1852.5	0	1#0	22.66	23.31
		0	6#0	22.93	23.04
	26365/1882.5	0	1#0	22.45	23.25
		0	6#0	22.70	22.63
	26665/1912.5	0	1#5	22.68	22.38
		3	6#0	22.48	22.96
10MHz	26090/1855	0	1#0	22.91	22.87
		0	4#0	23.14	23.29
	26365/1882.5	0	1#0	22.51	23.29
		0	4#0	22.72	22.43
	26640/1910	4	1#5	22.95	22.76
		7	4#2	22.65	23.00
15MHz	26115/1857.5	0	1#0	22.82	22.76
		0	6#0	22.77	23.26
	26365/1882.5	0	1#0	22.53	23.31
		0	6#0	22.58	22.75
	26615/1907.5	8	1#5	23.03	22.86
		11	6#0	22.64	22.52
20MHz	26140/1860	0	1#0	22.87	22.86
		0	6#0	22.72	23.22
	26365/1882.5	0	1#0	22.85	22.88
		0	6#0	22.64	22.77
	26590/1905	12	1#5	22.82	22.93
		15	6#0	22.61	22.55

## 5.2. Effective Isotropic Radiated Power

### Ambient condition

Temperature	Relative humidity	Pressure
23°C ~25°C	45%~50%	101.5kPa

### Methods of Measurement

The testing follows FCC KDB 971168 v03r01 Section 5.8 and ANSI C63.26 (2015).

- a) Connect the equipment as illustrated. Mount the equipment with the manufacturer specified antenna in a vertical orientation on a manufacturer specified mounting surface located on a non-conducting rotating platform of a RF anechoic chamber (preferred) or a standard radiation site.
- b) Key the transmitter, then rotate the EUT 360° azimuthally and record spectrum analyzer power level (LVL) measurements at angular increments that are sufficiently small to permit resolution of all peaks. If a standard radiation test site is used, raise and lower the test antenna to obtain a maximum reading at each angular increment. (Note: several batteries may be needed to offset the effect of battery voltage droop, which should not exceed 5% of the manufactured specified battery voltage during transmission).
- c) Replace the transmitter under test with a vertically polarized half-wave dipole (or an antenna whose gain is known relative to an ideal half-wave dipole). The center of the antenna should be at the same location as the center of the antenna under test.
- d) Connect the antenna to a signal generator with a known output power and record the path loss (in dB) as LOSS. If a standard radiation test site is used, raise and lower the test antenna to obtain a maximum reading.  $LOSS = \text{Generator Output Power (dBm)} - \text{Analyzer reading (dBm)}$
- e) Determine the effective radiated output power at each angular position from the readings in steps b) and d) using the following equation:  $ERP \text{ (dBm)} = \text{LVL (dBm)} + \text{LOSS (dB)}$
- f) The maximum ERP is the maximum value determined in the preceding step.
- g) When calculating ERP, in addition to knowing the antenna radiation and matching characteristics, it is necessary to know the loss values of all elements (e.g. transmission line attenuation, mismatches, filters, combiners) interposed between the point where transmitter output power is measured, and the point where power is applied to the antenna. ERP can then be calculated as follows:  
 $EIRP \text{ (dBm)} = \text{Output Power (dBm)} - \text{Losses (dB)} + \text{Antenna Gain (dBi)}$   
where: dBi refers to gain relative to an ideal dipole.  
 $EIRP \text{ (dBm)} = ERP \text{ (dBm)} + 2.15 \text{ (dB)}$

The RB allocation refers to section 5.1, using the maximum output power configuration.

**Test setup**

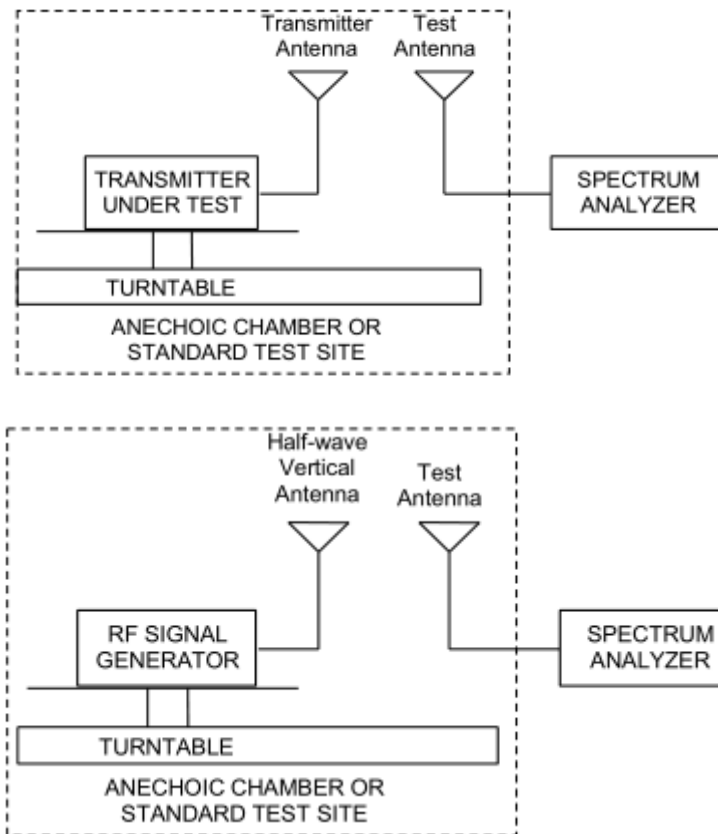

**Limits**

Rule Part 24.232(c) Mobile and portable stations are limited to 2 watts EIRP.

Rule Part 24.232(e) Peak transmit power must be measured over any interval of continuous transmission using instrumentation calibrated in terms of an rms-equivalent voltage.

Limit	$\leq 2\text{ W}$ (33 dBm)
-------	----------------------------

**Measurement Uncertainty**

The assessed measurement uncertainty to ensure 95% confidence level for the normal distribution is with the coverage factor  $k = 2$ ,  $U = 1.19\text{ dB}$

**Test Results:**

The measurement is performed for both of horizontal and vertical antenna Polarization, and only the data of worst mode is recorded in this report.

LTE Band 2								
Bandwidth	Channel/ Frequency(MHz)	Polarization	RB	Index	Output power (dBm)	EIRP (dBm)	Limit (dBm)	Conclusion
1.4MHz QPSK	18607/1850.7	H	1#0	0	-35.36	21.43	33	Pass
	18900/1880	H	1#2	0	-37.37	21.21	33	Pass
	19193/1909.3	H	1#5	0	-39.03	20.97	33	Pass
3MHz QPSK	18615/1851.5	H	1#0	0	-35.37	21.47	33	Pass
	18900/1880	H	1#5	0	-37.36	21.24	33	Pass
	19185/1908.5	H	1#5	1	-39.15	20.84	33	Pass
5MHz QPSK	18625/1852.5	H	1#0	0	-35.23	21.67	33	Pass
	18900/1880	H	1#5	1	-37.08	21.52	33	Pass
	19175/1907.5	H	1#5	3	-38.97	20.98	33	Pass
10MHz QPSK	18650/1855	H	4#0	0	-35.44	21.56	33	Pass
	18900/1880	H	4#2	3	-37.43	21.17	33	Pass
	19150/1905	H	4#2	7	-39.33	20.60	33	Pass
15MHz QPSK	18675/1857.5	H	1#0	0	-35.35	21.81	33	Pass
	18900/1880	H	1#5	5	-36.81	21.79	33	Pass
	19125/1902.5	H	1#5	11	-38.84	21.03	33	Pass
20MHz QPSK	18700/1860	H	6#0	0	-35.52	21.76	33	Pass
	18900/1880	H	6#0	7	-36.92	21.68	33	Pass
	19100/1900	H	6#0	15	-38.44	21.34	33	Pass
1.4MHz 16QAM	18607/1850.7	H	1#0	0	-35.77	21.02	33	Pass
	18900/1880	H	1#2	0	-37.79	20.79	33	Pass
	19193/1909.3	H	1#5	0	-39.62	20.38	33	Pass
3MHz 16QAM	18615/1851.5	H	1#0	0	-35.80	21.04	33	Pass
	18900/1880	H	1#5	0	-37.81	20.79	33	Pass
	19185/1908.5	H	1#5	1	-39.71	20.28	33	Pass
5MHz 16QAM	18625/1852.5	H	1#0	0	-35.72	21.18	33	Pass
	18900/1880	H	1#5	1	-37.57	21.03	33	Pass
	19175/1907.5	H	1#5	3	-39.57	20.38	33	Pass
10MHz 16QAM	18650/1855	H	4#0	0	-35.98	21.02	33	Pass
	18900/1880	H	4#2	3	-37.86	20.74	33	Pass
	19150/1905	H	4#2	7	-39.72	20.21	33	Pass
15MHz 16QAM	18675/1857.5	H	1#0	0	-35.77	21.39	33	Pass
	18900/1880	H	1#5	5	-37.32	21.28	33	Pass



	19125/1902.5	H	1#5	11	-39.36	20.51	33	Pass
20MHz 16QAM	18700/1860	H	6#0	0	-36.05	21.23	33	Pass
	18900/1880	H	6#0	7	-37.42	21.18	33	Pass
	19100/1900	H	6#0	15	-38.94	20.84	33	Pass
<b>LTE Band 25</b>								
Bandwidth	Channel/ Frequency(MHz)	Polarization	RB	Index	Output power (dBm)	EIRP (dBm)	Limit (dBm)	Conclusion
1.4MHz QPSK	26047/1850.7	V	1#0	0	-33.95	22.84	33	Pass
	26365/1882.5	V	1#2	0	-37.02	21.56	33	Pass
	26683/1914.3	V	1#5	0	-38.24	21.76	33	Pass
3MHz QPSK	26055/1851.5	V	1#0	0	-33.91	22.93	33	Pass
	26365/1882.5	V	1#5	0	-37.04	21.56	33	Pass
	26675/1913.5	V	1#5	1	-38.04	21.95	33	Pass
5MHz QPSK	26065/1852.5	V	1#0	0	-34.23	22.67	33	Pass
	26365/1882.5	V	1#5	1	-36.96	21.64	33	Pass
	26665/1912.5	V	1#5	3	-38.14	21.81	33	Pass
10MHz QPSK	26090/1855	V	4#0	0	-34.24	22.76	33	Pass
	26365/1882.5	V	4#2	3	-37.22	21.38	33	Pass
	26640/1910	V	4#2	7	-38.39	21.54	33	Pass
15MHz QPSK	26115/1857.5	V	1#0	0	-34.17	22.99	33	Pass
	26140/1882.5	V	1#5	5	-36.95	21.65	33	Pass
	26615/1907.5	V	1#5	11	-38.13	21.74	33	Pass
20MHz QPSK	26140/1860	V	6#0	0	-34.37	22.91	33	Pass
	26365/1882.5	V	6#0	7	-37.12	21.48	33	Pass
	26590/1905	V	6#0	15	-37.91	21.87	33	Pass
1.4MHz 16QAM	26047/1850.7	V	1#0	0	-34.55	22.24	33	Pass
	26365/1882.5	V	1#2	0	-37.52	21.06	33	Pass
	26683/1914.3	V	1#5	0	-38.77	21.23	33	Pass
3MHz 16QAM	26055/1851.5	V	1#0	0	-34.46	22.38	33	Pass
	26365/1882.5	V	1#5	0	-37.57	21.03	33	Pass
	26675/1913.5	V	1#5	1	-38.72	21.27	33	Pass
5MHz 16QAM	26065/1852.5	V	1#0	0	-34.69	22.21	33	Pass
	26365/1882.5	V	1#5	1	-37.37	21.23	33	Pass
	26665/1912.5	V	1#5	3	-38.58	21.37	33	Pass
10MHz 16QAM	26090/1855	V	4#0	0	-34.79	22.21	33	Pass
	26365/1882.5	V	4#2	3	-37.71	20.89	33	Pass
	26640/1910	V	4#2	7	-38.90	21.03	33	Pass
15MHz 16QAM	26115/1857.5	V	1#0	0	-34.81	22.35	33	Pass
	26140/1882.5	V	1#5	5	-37.49	21.11	33	Pass



	26615/1907.5	V	1#5	11	-38.64	21.23	33	Pass
20MHz 16QAM	26140/1860	V	6#0	0	-34.89	22.39	33	Pass
	26365/1882.5	V	6#0	7	-37.54	21.06	33	Pass
	26590/1905	V	6#0	15	-38.45	21.33	33	Pass



### 5.3.Occupied Bandwidth

#### Ambient condition

Temperature	Relative humidity	Pressure
23°C ~25°C	45%~50%	101.5kPa

#### Method of Measurement

The EUT was connected to Spectrum Analyzer and Base Station Simulator via power Splitter. The occupied bandwidth is measured using spectrum analyzer.

RBW is set to 51kHz, VBW is set to 160kHz for LTE Band 2

99% power and -26dBc occupied bandwidths are recorded. Spectrum analyzer plots are included on the following pages.

#### Test Setup

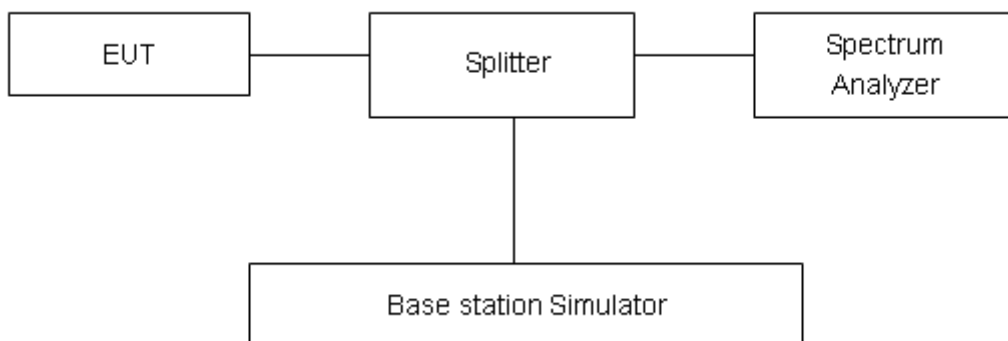

#### Limits

No specific occupied bandwidth requirements in part 2.1049.

#### Measurement Uncertainty

The assessed measurement uncertainty to ensure 95% confidence level for the normal distribution is with the coverage factor  $k = 2$ ,  $U = 624\text{Hz}$ .

**Test Result**

Mode	Bandwidth	Modulation	Channel/ Frequency(MHz)	RB	Index	Bandwidth(MHz)		
						99% Power	-26dBc	
LTE Band 2	1.4MHz	QPSK	18900/1880	6#0	0	1.1093	1.366	
		16QAM	18900/1880	6#0	0	0.9470	1.310	
	3MHz	QPSK	18900/1880	6#0	0	1.1479	1.728	
		16QAM	18900/1880	6#0	0	0.9797	1.316	
	5MHz	QPSK	18900/1880	6#0	0	1.1427	1.858	
		16QAM	18900/1880	6#0	0	0.9906	1.482	
	10MHz	QPSK	18900/1880	6#0	0	1.1707	1.799	
		16QAM	18900/1880	6#0	0	1.0412	1.623	
	15MHz	QPSK	18900/1880	6#0	0	1.1911	1.911	
		16QAM	18900/1880	6#0	0	1.0546	1.680	
	20MHz	QPSK	18900/1880	6#0	0	1.2271	1.812	
		16QAM	18900/1880	6#0	0	1.1411	1.932	
	Mode	Bandwidth	Modulation	Channel/ Frequency(MHz)	RB	Index	Bandwidth(MHz)	
							99% Power	-26dBc
LTE Band 25	1.4MHz	QPSK	26365/1882.5	6#0	0	1.1075	1.360	
		16QAM	26365/1882.5	6#0	0	0.9476	1.351	
	3MHz	QPSK	26365/1882.5	6#0	0	1.1435	1.741	
		16QAM	26365/1882.5	6#0	0	0.9746	1.328	
	5MHz	QPSK	26365/1882.5	6#0	0	1.1477	1.754	
		16QAM	26365/1882.5	6#0	0	0.9850	1.436	
	10MHz	QPSK	26365/1882.5	6#0	0	1.1691	1.809	
		16QAM	26365/1882.5	6#0	0	1.0269	1.596	
	15MHz	QPSK	26365/1882.5	6#0	0	1.2051	1.896	
		16QAM	26365/1882.5	6#0	0	1.0517	1.687	
	20MHz	QPSK	26365/1882.5	6#0	0	1.1953	1.798	
		16QAM	26365/1882.5	6#0	0	1.0770	1.925	

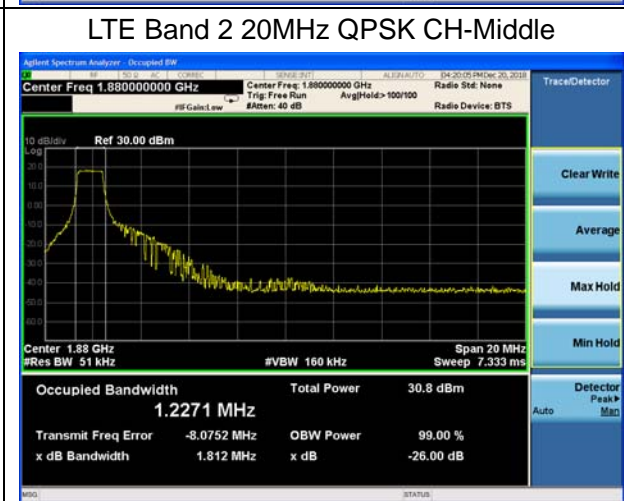
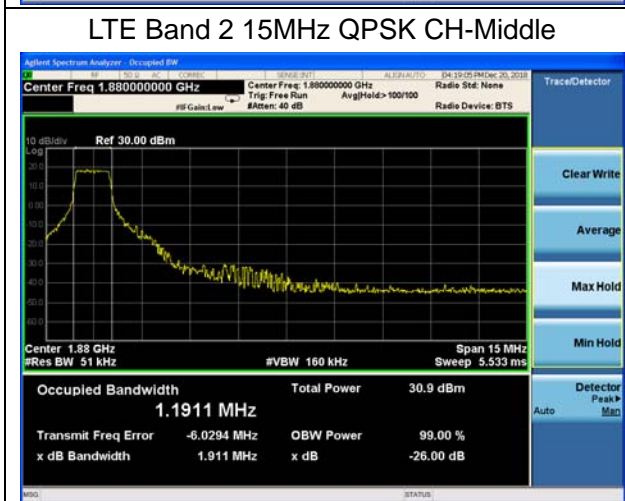
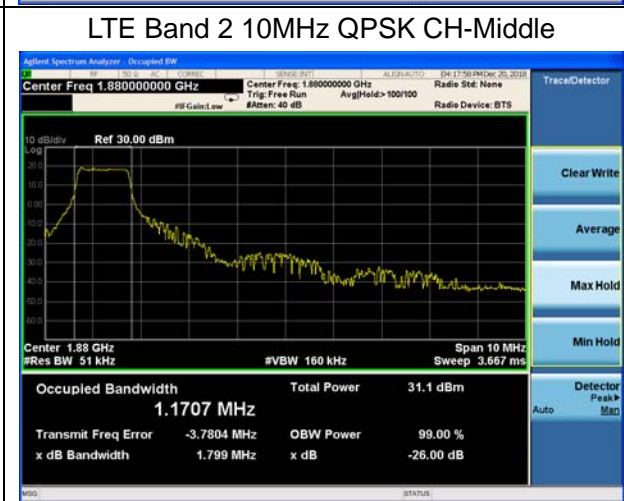
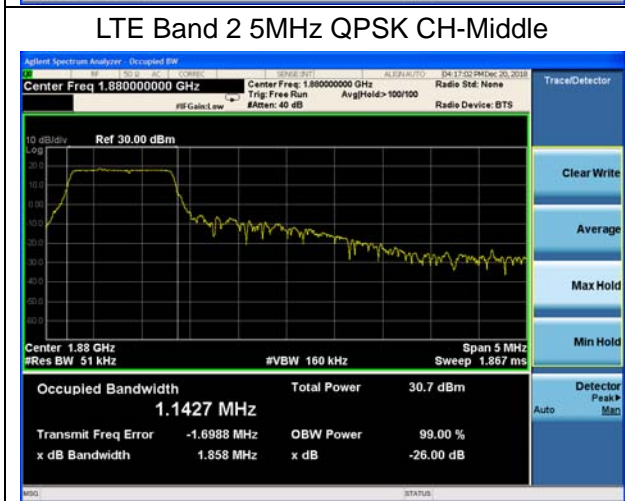
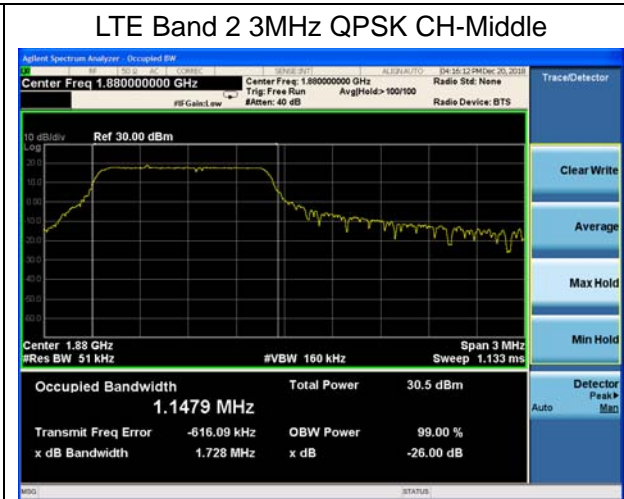
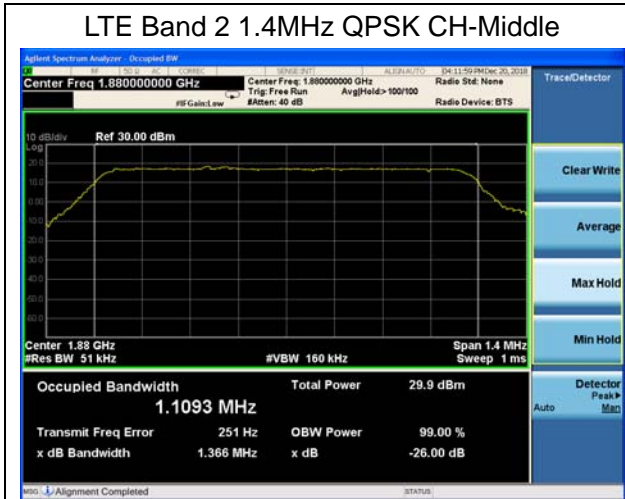



### LTE Band 2 1.4MHz 16QAM CH-Middle



### LTE Band 2 3MHz 16QAM CH-Middle



### LTE Band 2 5MHz 16QAM CH-Middle



### LTE Band 2 10MHz 16QAM CH-Middle



### LTE Band 2 15MHz 16QAM CH-Middle



### LTE Band 2 20MHz 16QAM CH-Middle



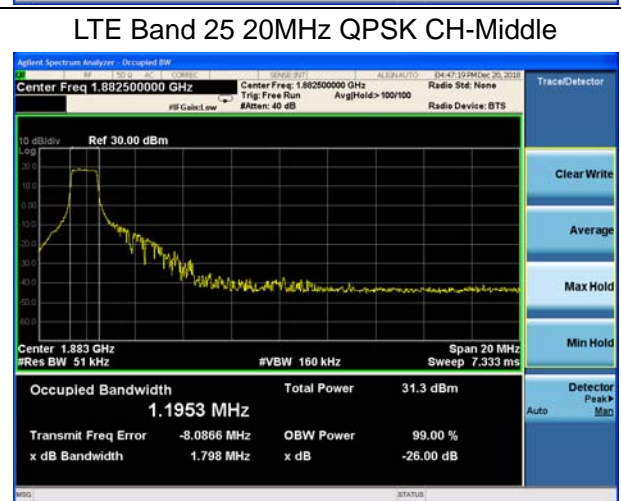
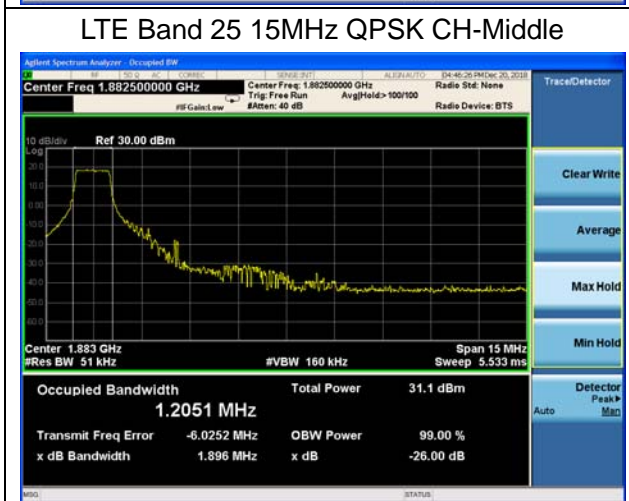
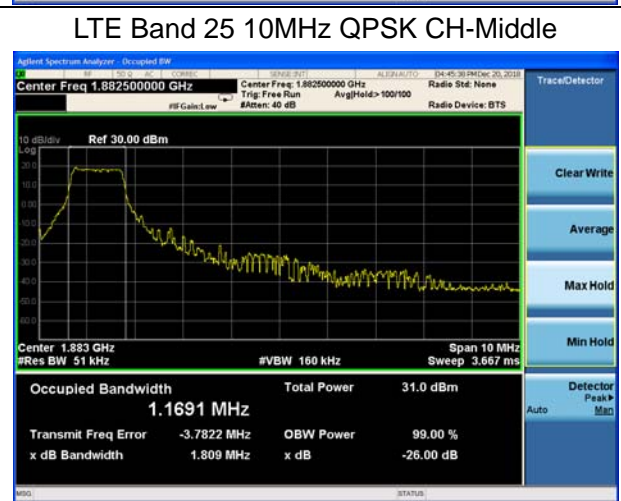
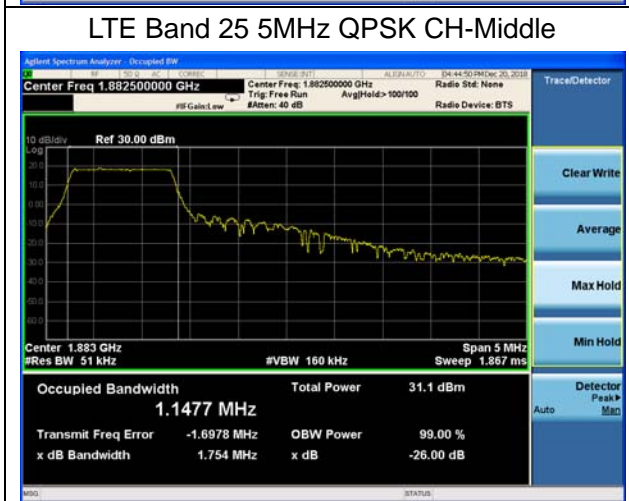
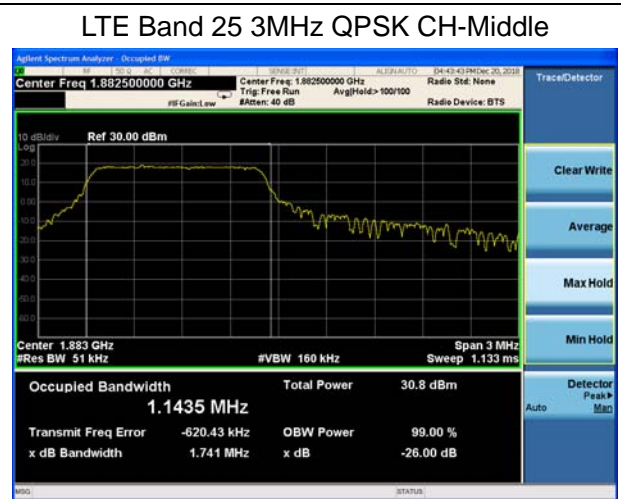
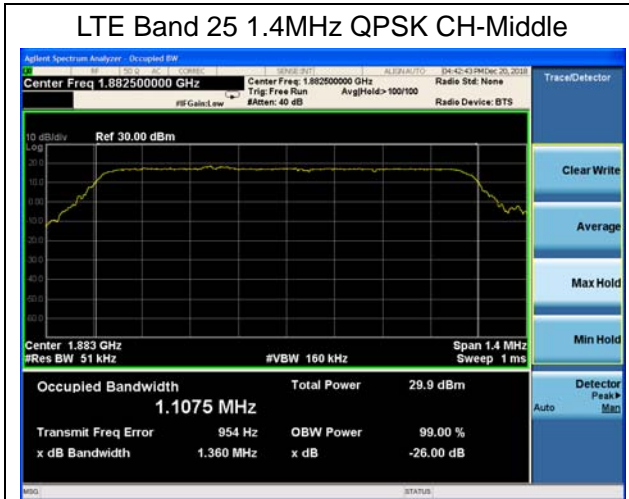



LTE Band 25 1.4MHz 16QAM CH-Middle



LTE Band 25 3MHz 16QAM CH-Middle



LTE Band 25 5MHz 16QAM CH-Middle



LTE Band 25 10MHz 16QAM CH-Middle



LTE Band 25 15MHz 16QAM CH-Middle



LTE Band 25 20MHz 16QAM CH-Middle

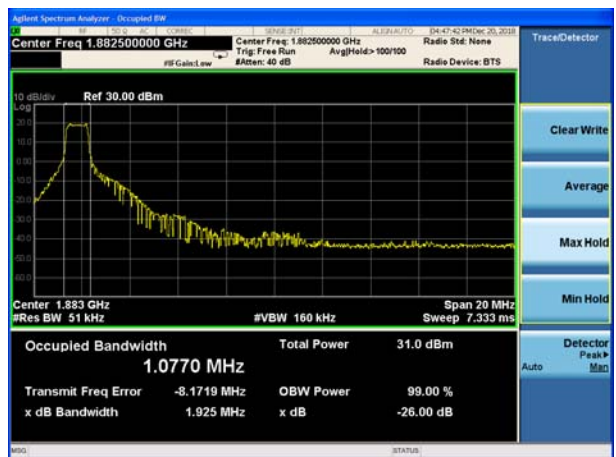

### 5.4. Band Edge Compliance

#### Ambient condition

Temperature	Relative humidity	Pressure
23°C ~25°C	45%~50%	101.5kPa

#### Method of Measurement

The EUT was connected to Spectrum Analyzer and Base Station Simulator via power Splitter. The band edge of the lowest and highest channels were measured. The Average detector is used and RBW is set to 51kHz,VBW is set to 160kHz for LTE Band 2/25.

Spectrum analyzer plots are included on the following pages.

#### Test Setup

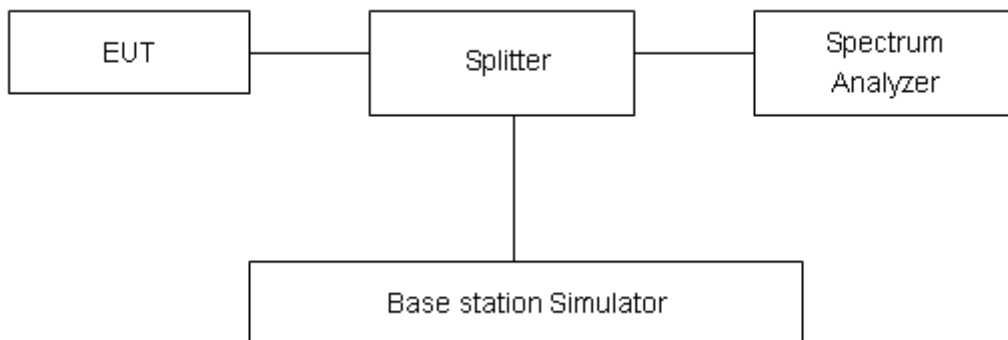

#### Limits

Rule Part 24.238(a) specifies that “on any frequency outside a licensee's frequency block, the power of any emission shall be attenuated below the transmitter power (P) by at least 43 + 10 log<sub>10</sub> (P) dB.”

Limit	-13 dBm
-------	---------

#### Measurement Uncertainty

The assessed measurement uncertainty to ensure 95% confidence level for the normal distribution is with the coverage factor  $k = 1.96$ ,  $U=0.684$ dB.



Test Result:

LTE Band 2 1.4MHz QPSK 1RB CH-Low



LTE Band 2 1.4MHz QPSK 1RB CH-High

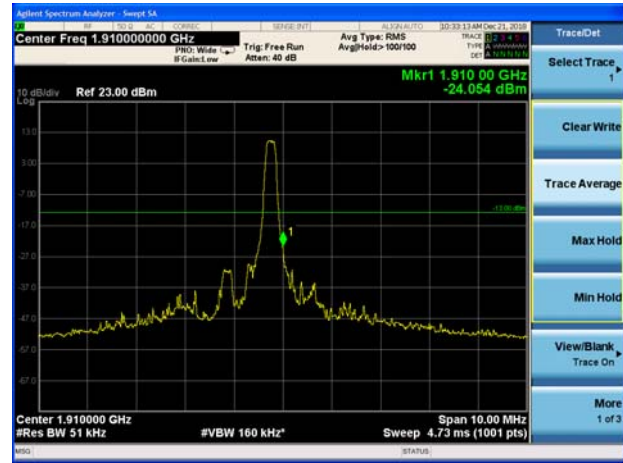

LTE Band 2 1.4MHz QPSK 100%RB CH-Low

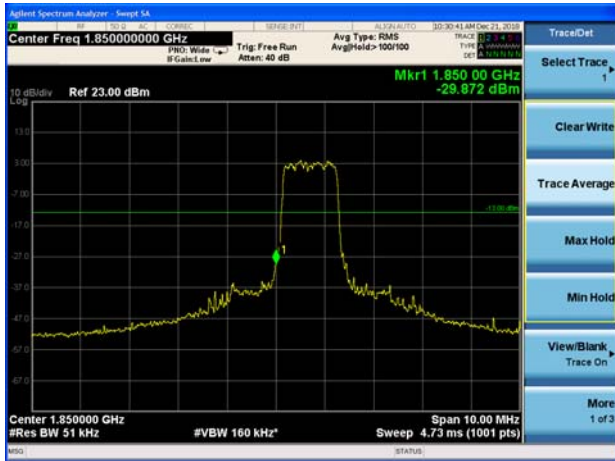

LTE Band 2 1.4MHz QPSK 100%RB CH-High



LTE Band 2 3MHz QPSK 1RB CH-Low



LTE Band 2 3MHz QPSK 1RB CH-High







LTE Band 2 3MHz QPSK 100%RB CH-Low

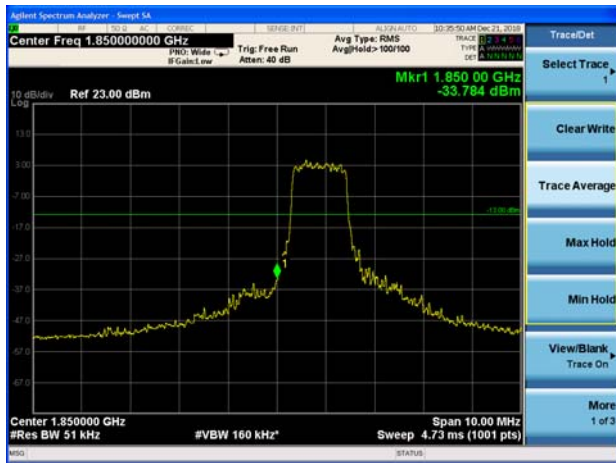

LTE Band 2 3MHz QPSK 100%RB CH-High



LTE Band 2 5MHz QPSK 1RB CH-Low



LTE Band 2 5MHz QPSK 1RB CH-High



LTE Band 2 5MHz QPSK 100%RB CH-Low



LTE Band 2 5MHz QPSK 100%RB CH-High

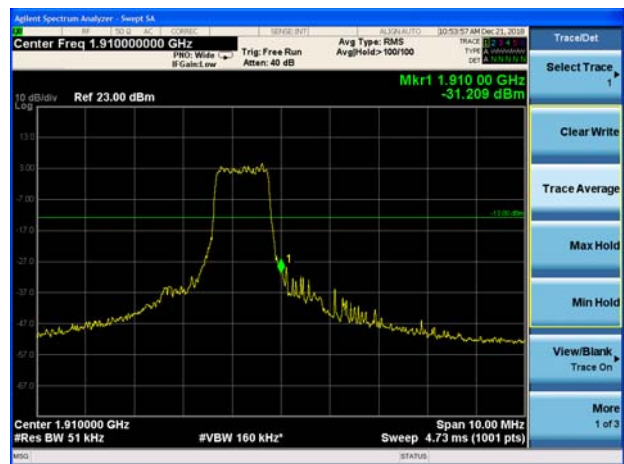



LTE Band 2 10MHz QPSK 1RB CH-Low

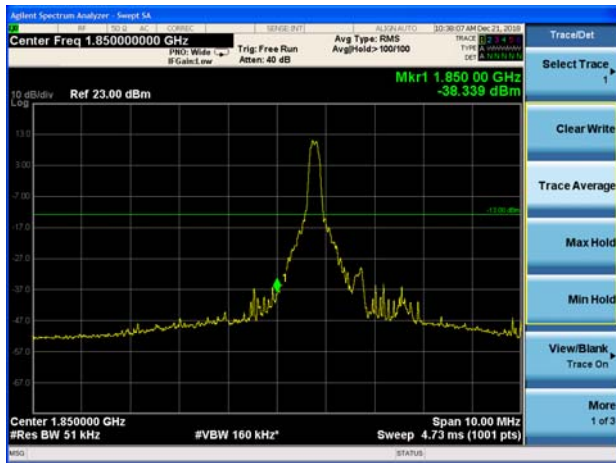

LTE Band 2 10MHz QPSK 1RB CH-High

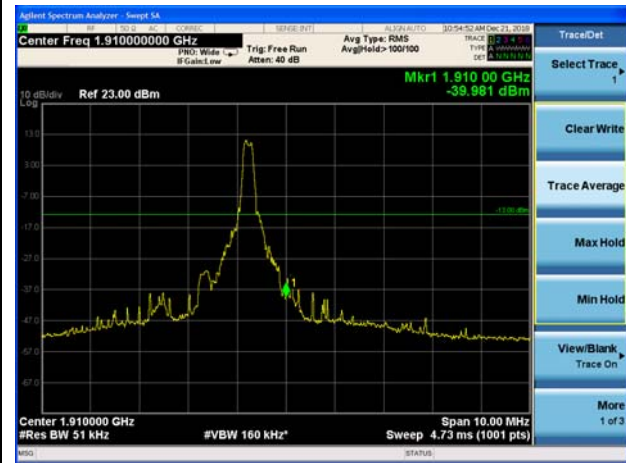

LTE Band 2 10MHz QPSK 100%RB CH-Low

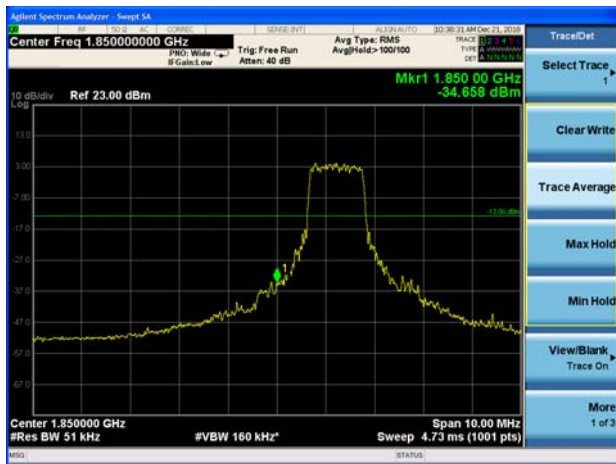

LTE Band 2 10MHz QPSK 100%RB CH-High

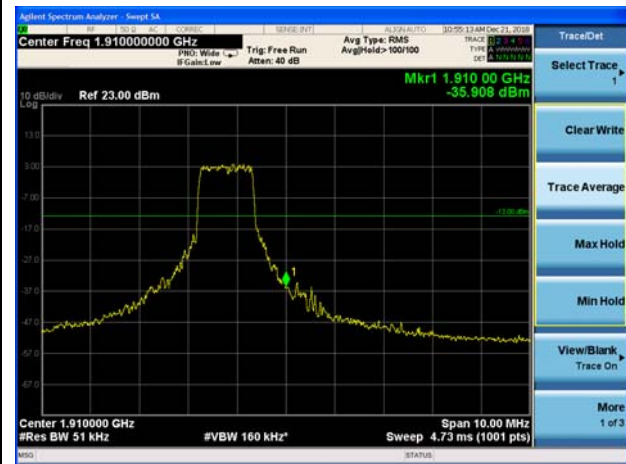

LTE Band 2 15MHz QPSK 1RB CH-Low

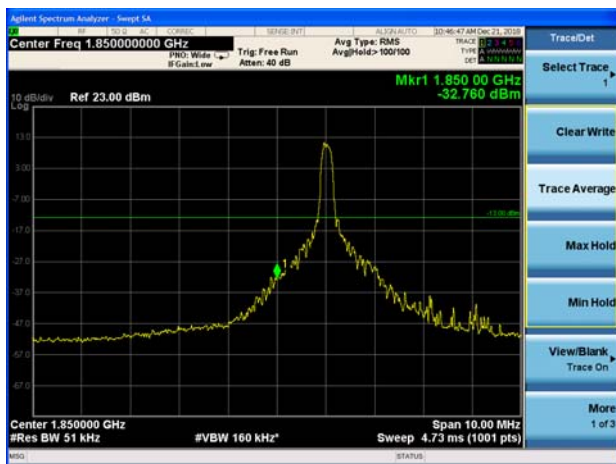

LTE Band 2 15MHz QPSK 1RB CH-High

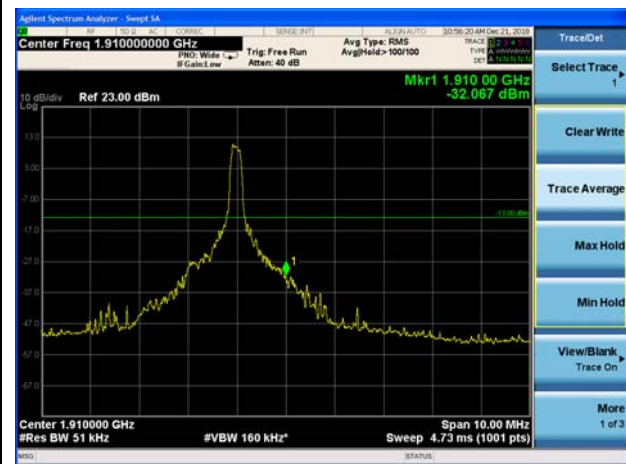



LTE Band 2 15MHz QPSK 100%RB CH-Low



LTE Band 2 15MHz QPSK 100%RB CH-High

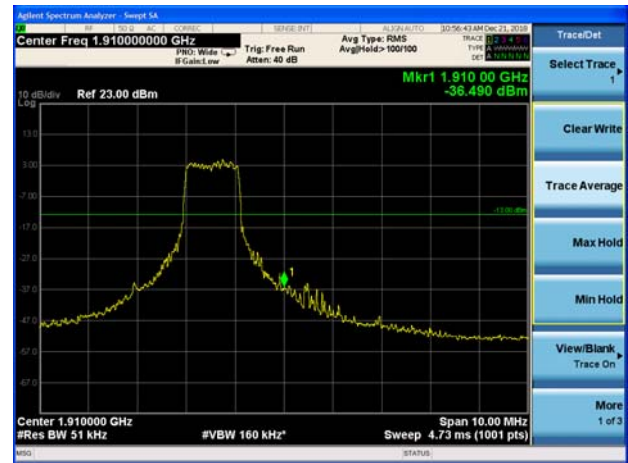

LTE Band 2 20MHz QPSK 1RB CH-Low

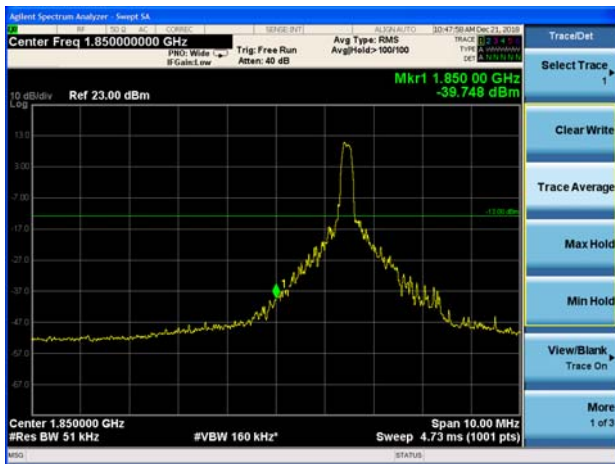

LTE Band 2 20MHz QPSK 1RB CH-High

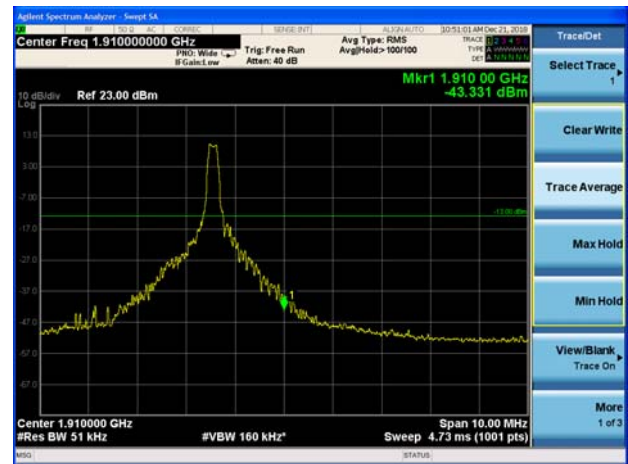

LTE Band 2 20MHz QPSK 100%RB CH-Low

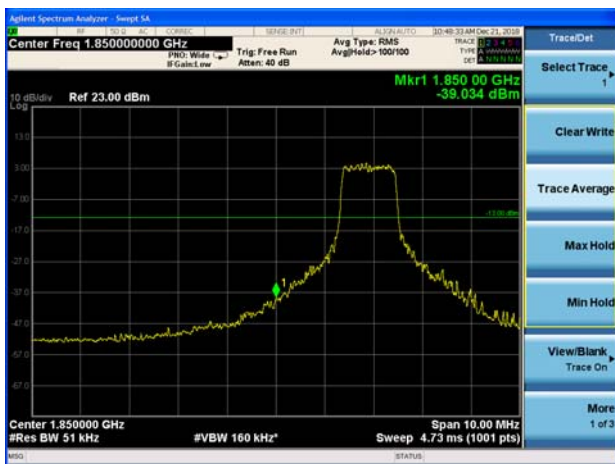

LTE Band 2 20MHz QPSK 100%RB CH-High

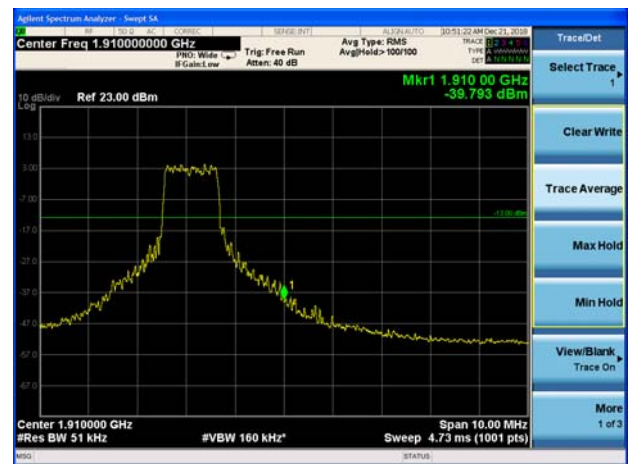



LTE Band 2 1.4MHz 16QAM 1RB CH-Low



LTE Band 2 1.4MHz 16QAM 1RB CH-High



LTE Band 2 1.4MHz 16QAM 100%RB CH-Low

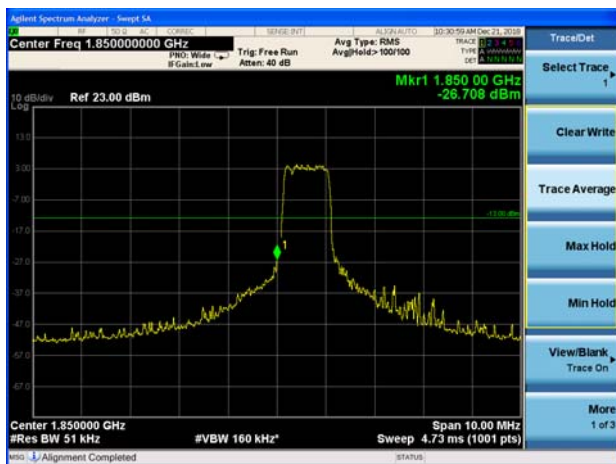

LTE Band 2 1.4MHz 16QAM 100%RB CH-High

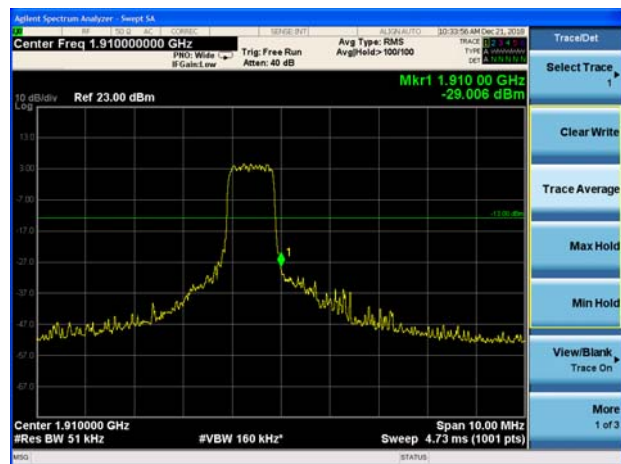

LTE Band 2 3MHz 16QAM 1RB CH-Low



LTE Band 2 3MHz 16QAM 1RB CH-High

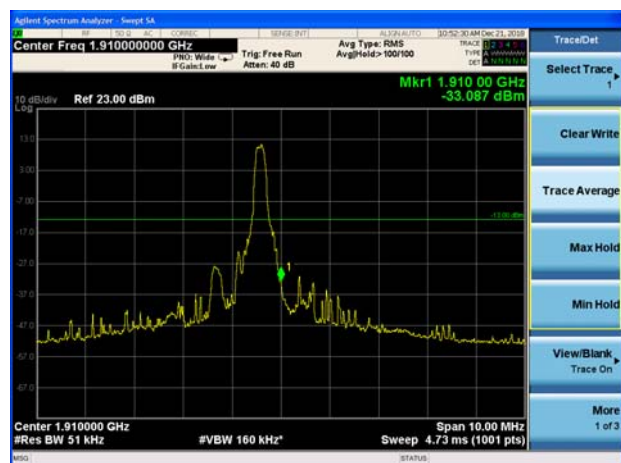



LTE Band 2 3MHz 16QAM 100%RB CH-Low

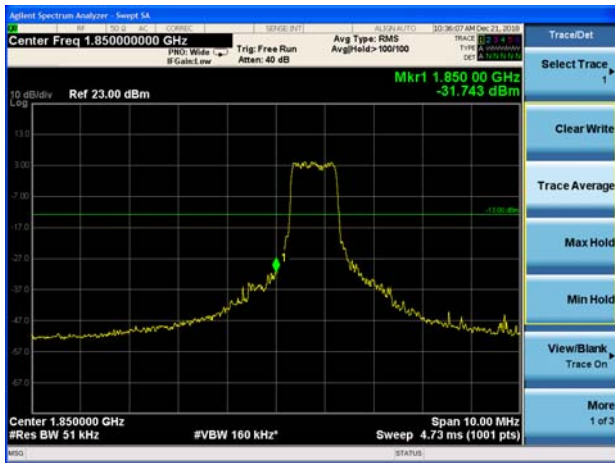

LTE Band 2 3MHz 16QAM 100%RB CH-High

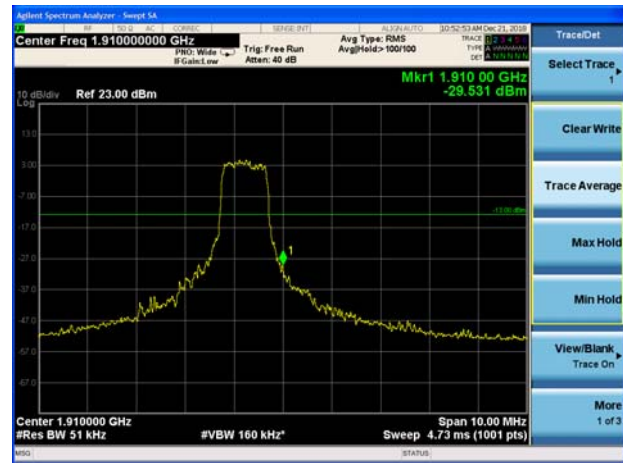

LTE Band 2 5MHz 16QAM 1RB CH-Low

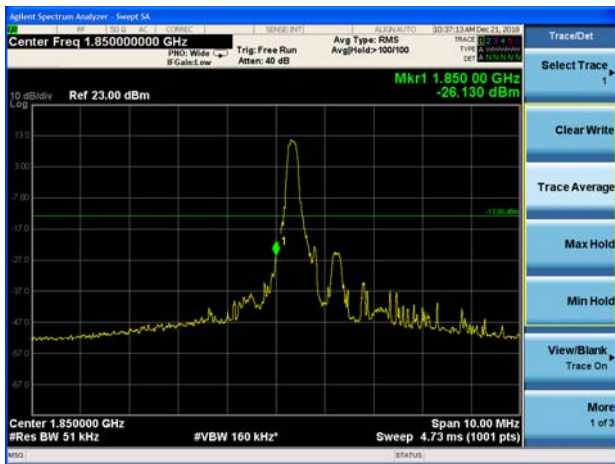

LTE Band 2 5MHz 16QAM 1RB CH-High



LTE Band 2 5MHz 16QAM 100%RB CH-Low

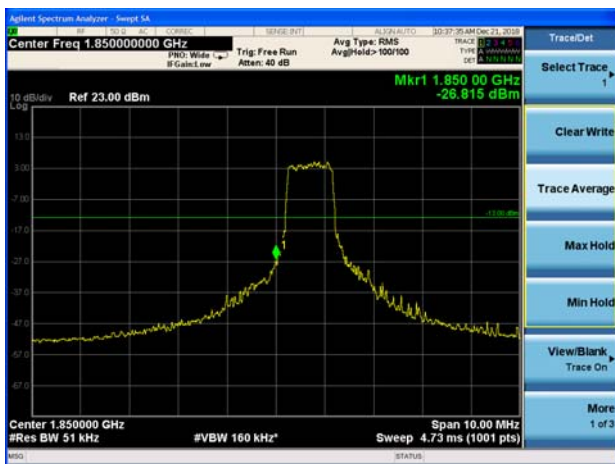

LTE Band 2 5MHz 16QAM 100%RB CH-High



LTE Band 2 10MHz 16QAM 1RB CH-Low

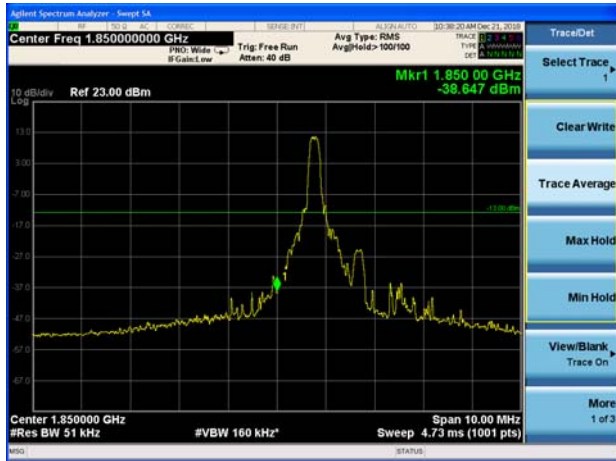

LTE Band 2 10MHz 16QAM 1RB CH-High

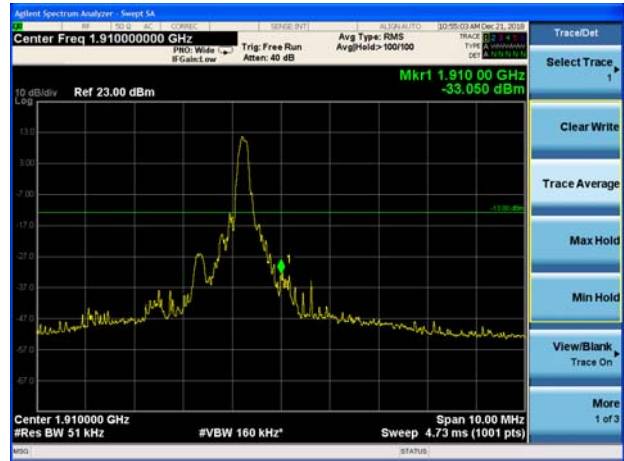

LTE Band 2 10MHz 16QAM 100%RB CH-Low

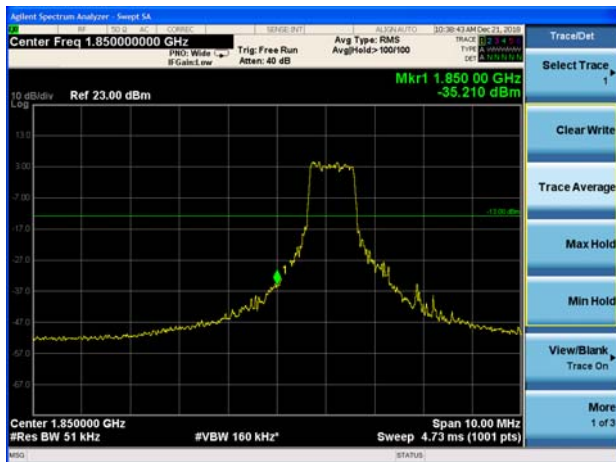

LTE Band 2 10MHz 16QAM 100%RB CH-High

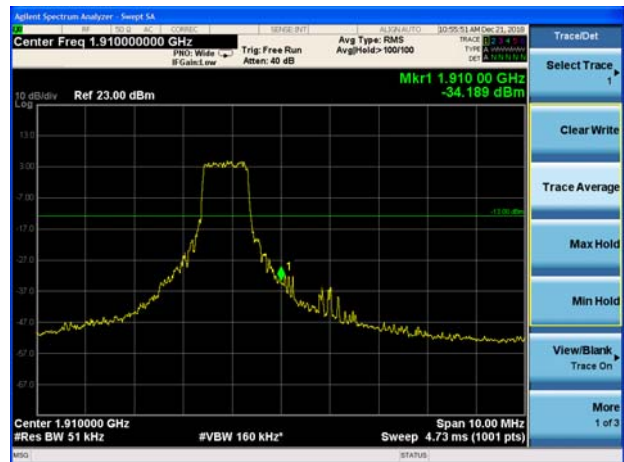

LTE Band 2 15MHz 16QAM 1RB CH-Low

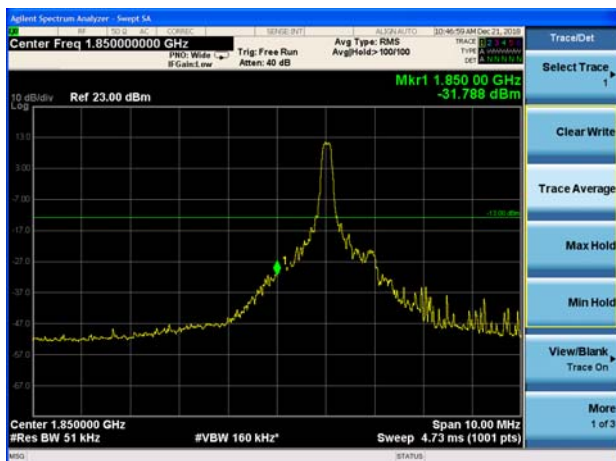

LTE Band 2 15MHz 16QAM 1RB CH-High

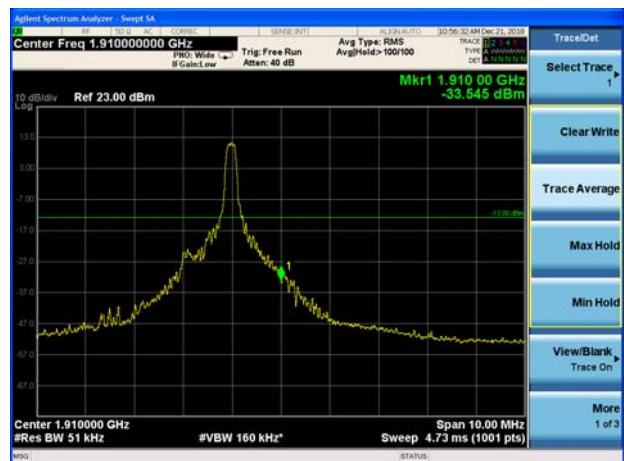



LTE Band 2 15MHz 16QAM 100%RB CH-Low

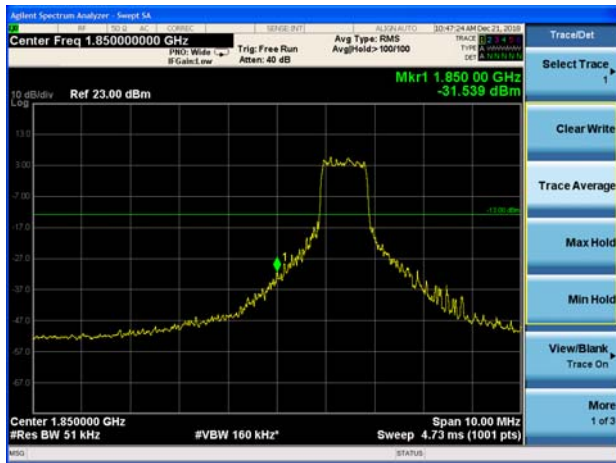

LTE Band 2 15MHz 16QAM 100%RB CH-High



LTE Band 2 20MHz 16QAM 1RB CH-Low

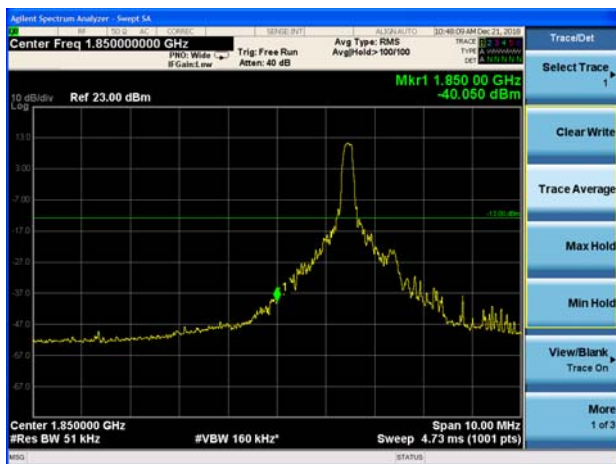

LTE Band 2 20MHz 16QAM 1RB CH-High

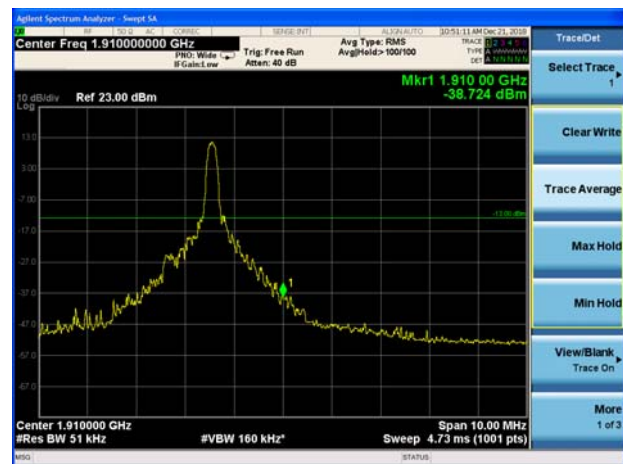

LTE Band 2 20MHz 16QAM 100%RB CH-Low

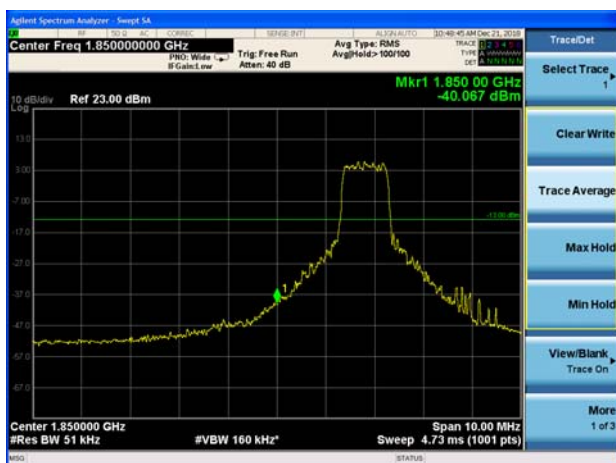

LTE Band 2 20MHz 16QAM 100%RB CH-High

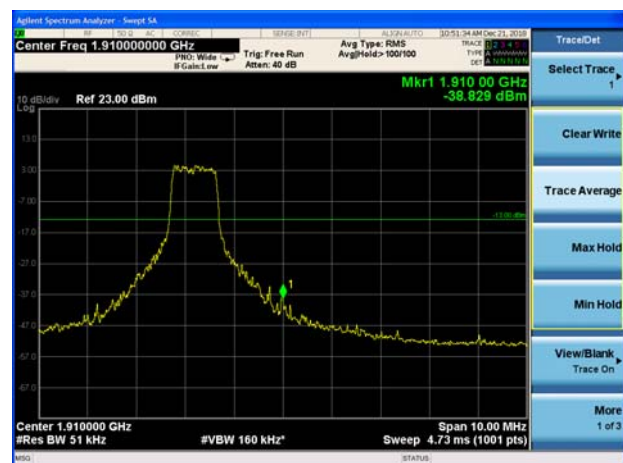



LTE Band 25 1.4MHz QPSK 1RB CH-Low



LTE Band 25 1.4MHz QPSK 1RB CH-High



LTE Band 25 1.4MHz QPSK 100%RB CH-Low



LTE Band 25 1.4MHz QPSK 100%RB CH-High



LTE Band 25 3MHz QPSK 1RB CH-Low



LTE Band 25 3MHz QPSK 1RB CH-High

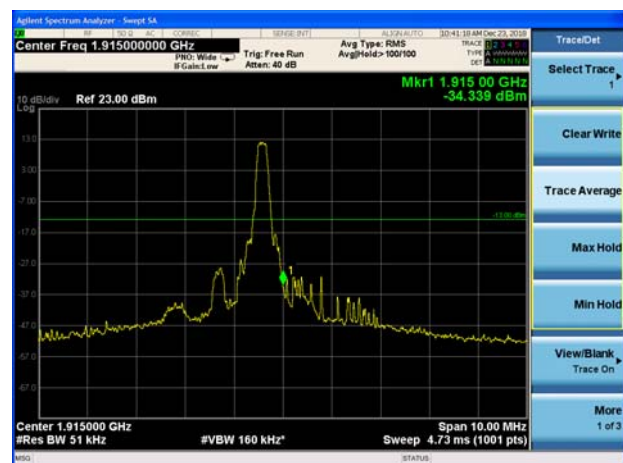





LTE Band 25 3MHz QPSK 100%RB CH-Low



LTE Band 25 3MHz QPSK 100%RB CH-High



LTE Band 25 5MHz QPSK 1RB CH-Low



LTE Band 25 5MHz QPSK 1RB CH-High



LTE Band 25 5MHz QPSK 100%RB CH-Low



LTE Band 25 5MHz QPSK 100%RB CH-High

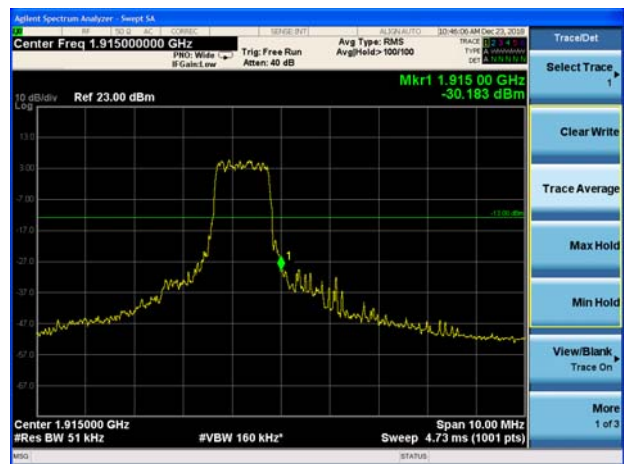



LTE Band 25 10MHz QPSK 1RB CH-Low

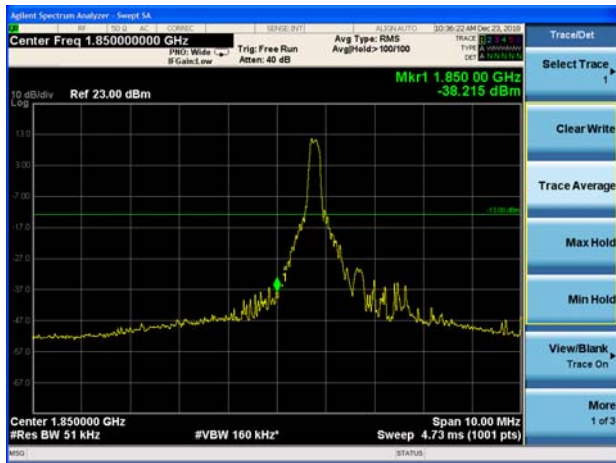

LTE Band 25 10MHz QPSK 1RB CH-High

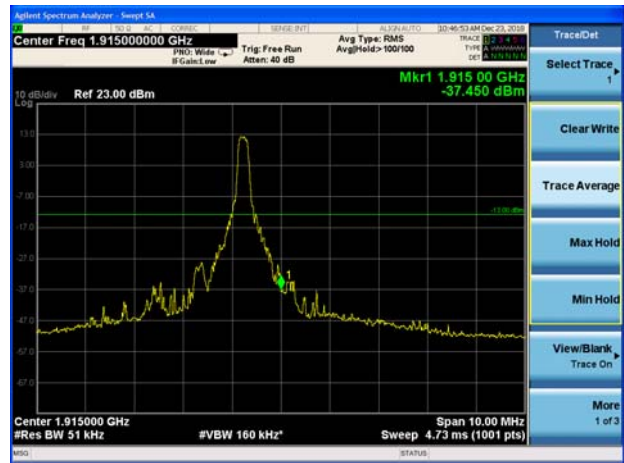

LTE Band 25 10MHz QPSK 100%RB CH-Low

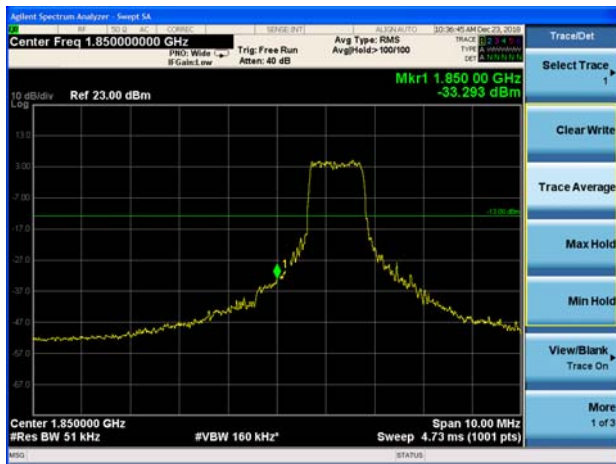

LTE Band 25 10MHz QPSK 100%RB CH-High



LTE Band 25 15MHz QPSK 1RB CH-Low

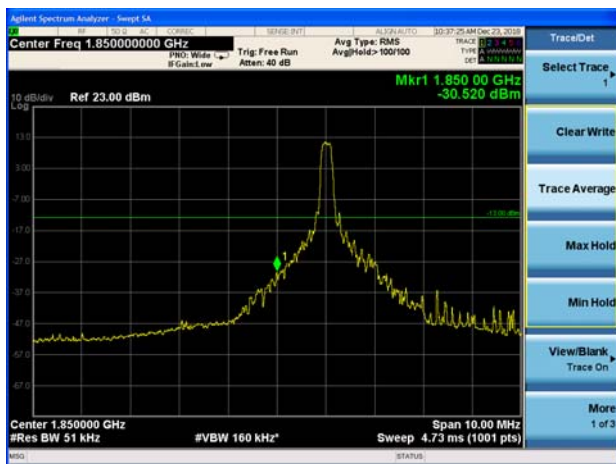

LTE Band 25 15MHz QPSK 1RB CH-High

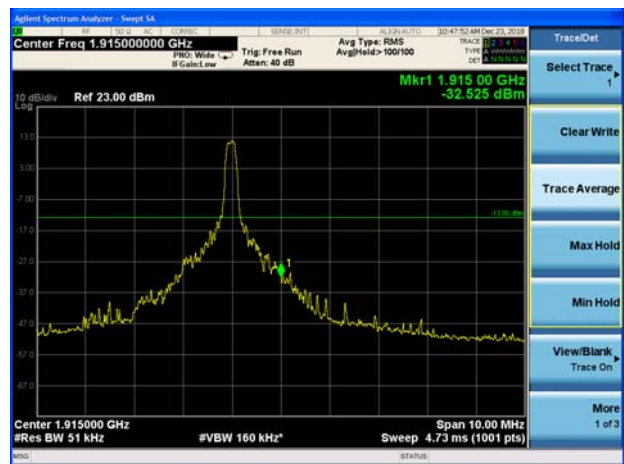



LTE Band 25 15MHz QPSK 100%RB CH-Low



LTE Band 25 15MHz QPSK 100%RB CH-High

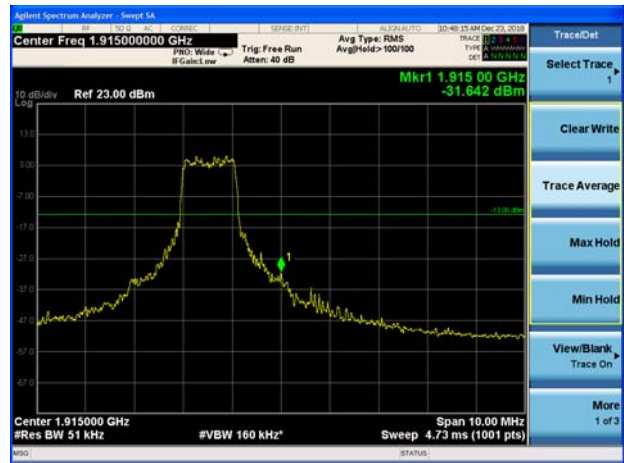

LTE Band 25 20MHz QPSK 1RB CH-Low



LTE Band 25 20MHz QPSK 1RB CH-High

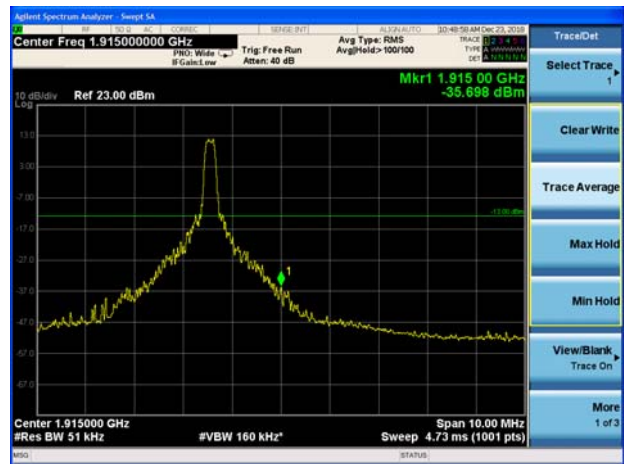

LTE Band 25 20MHz QPSK 100%RB CH-Low

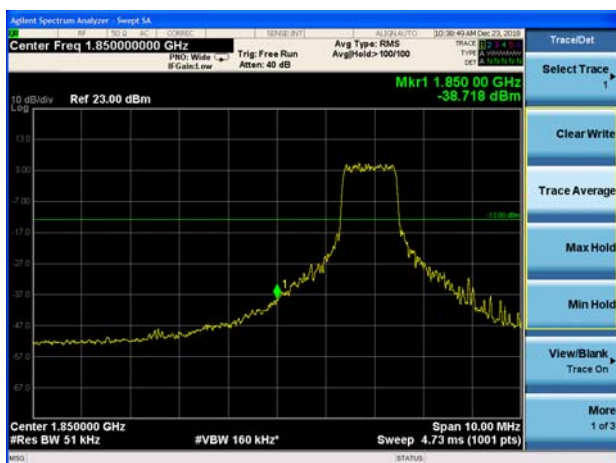

LTE Band 25 20MHz QPSK 100%RB CH-High

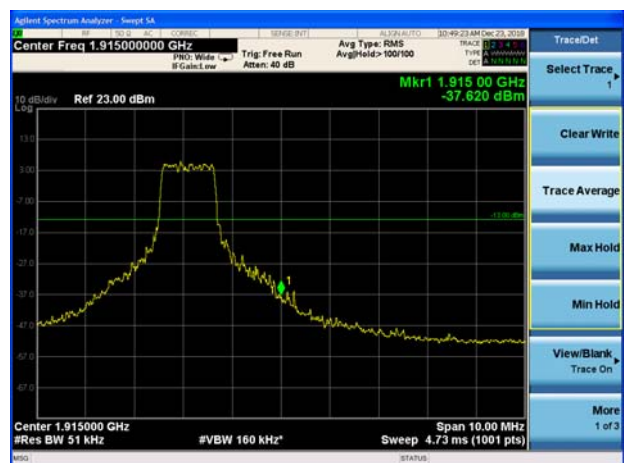



LTE Band 25 1.4MHz 16QAM 1RB CH-Low



LTE Band 25 1.4MHz 16QAM 1RB CH-High



LTE Band 25 1.4MHz 16QAM 100%RB CH-Low



LTE Band 25 1.4MHz 16QAM 100%RB CH-High



LTE Band 25 3MHz 16QAM 1RB CH-Low

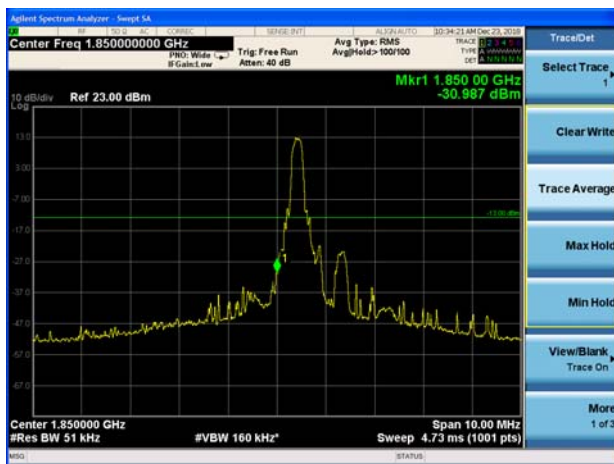

LTE Band 25 3MHz 16QAM 1RB CH-High





LTE Band 25 3MHz 16QAM 100%RB CH-Low

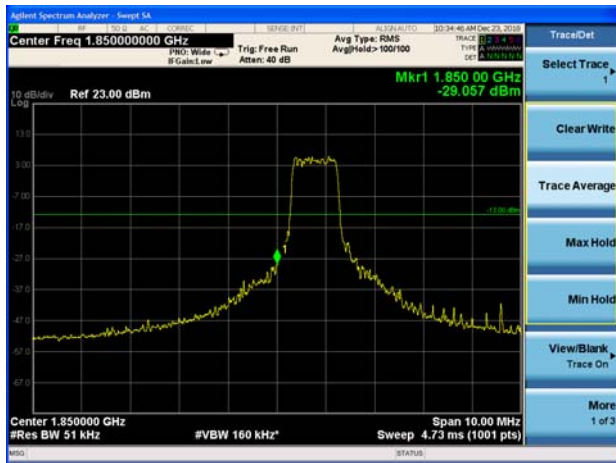

LTE Band 25 3MHz 16QAM 100%RB CH-High

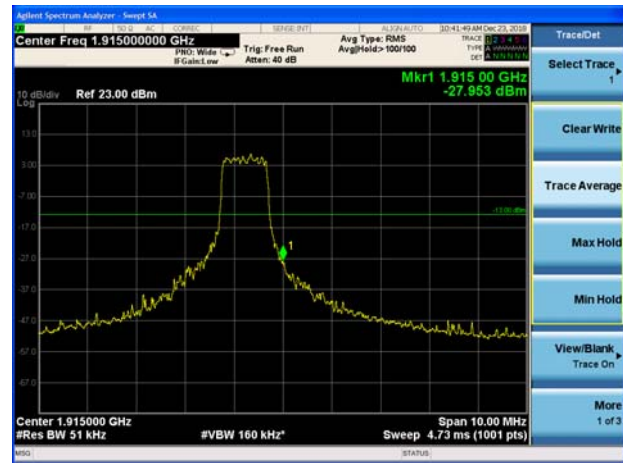

LTE Band 25 5MHz 16QAM 1RB CH-Low



LTE Band 25 5MHz 16QAM 1RB CH-High



LTE Band 25 5MHz 16QAM 100%RB CH-Low

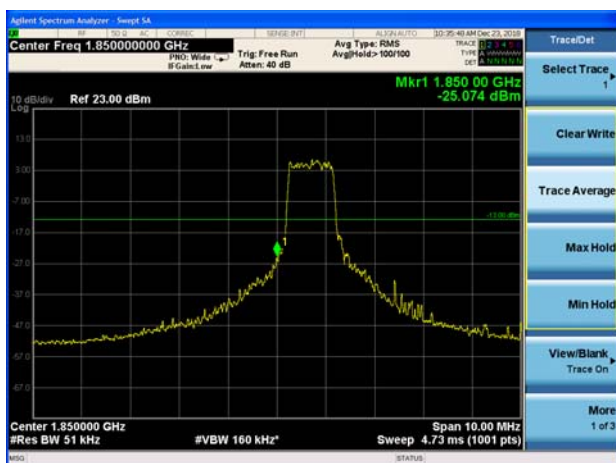

LTE Band 25 5MHz 16QAM 100%RB CH-High

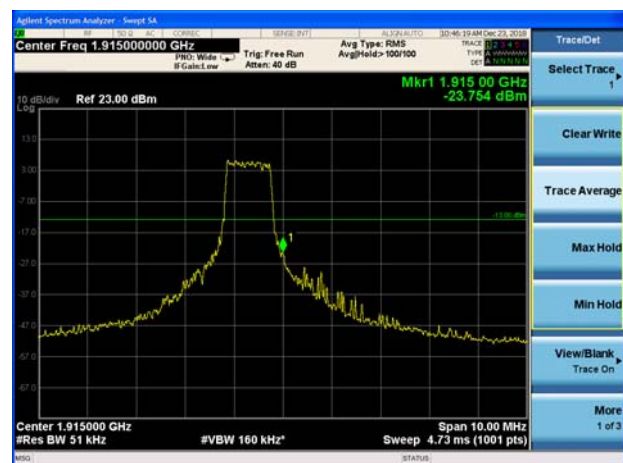



LTE Band 25 10MHz 16QAM 1RB CH-Low

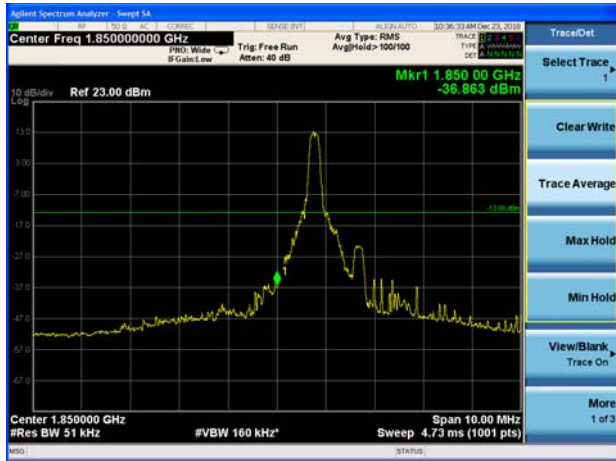

LTE Band 25 10MHz 16QAM 1RB CH-High

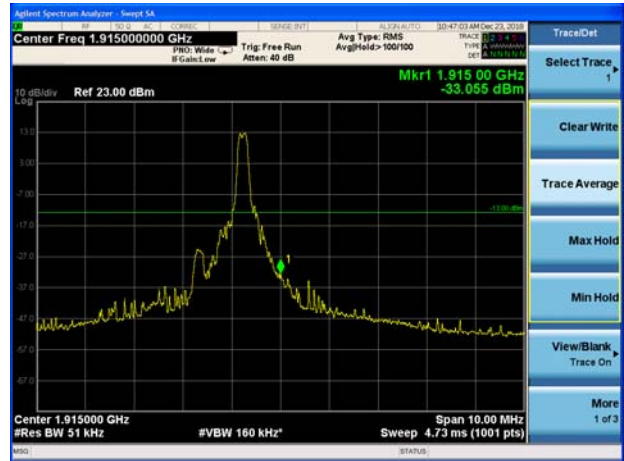

LTE Band 25 10MHz 16QAM 100%RB CH-Low

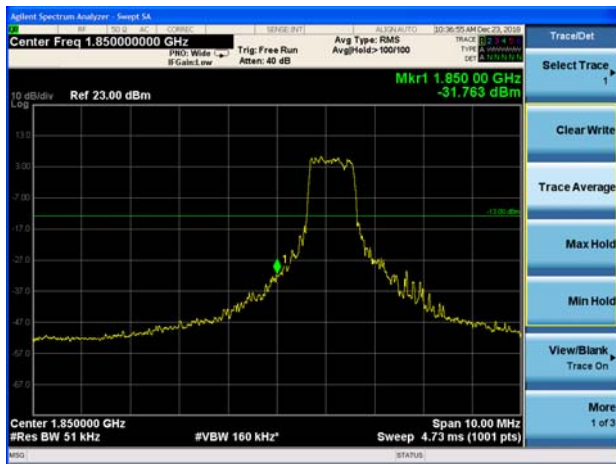

LTE Band 25 10MHz 16QAM 100%RB CH-High



LTE Band 25 15MHz 16QAM 1RB CH-Low

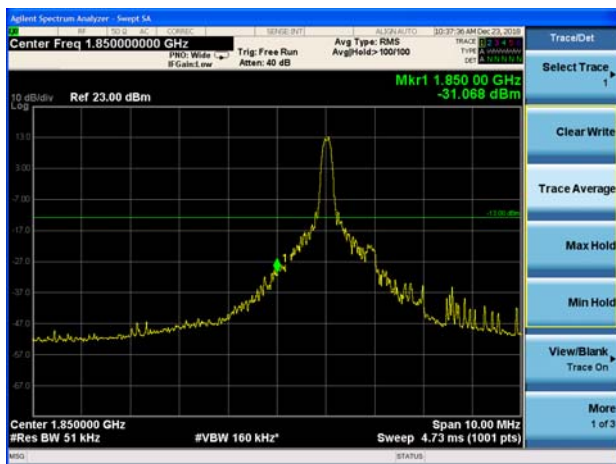

LTE Band 25 15MHz 16QAM 1RB CH-High

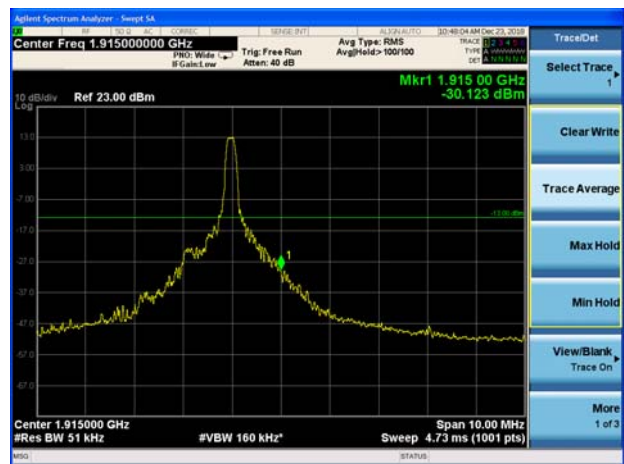



LTE Band 25 15MHz 16QAM 100%RB CH-Low

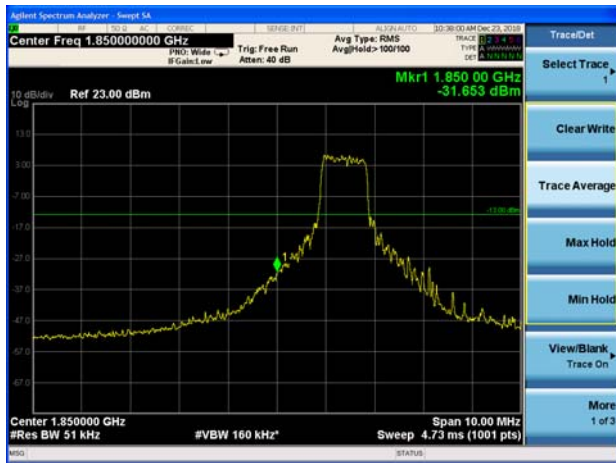

LTE Band 25 15MHz 16QAM 100%RB CH-High



LTE Band 25 20MHz 16QAM 1RB CH-Low

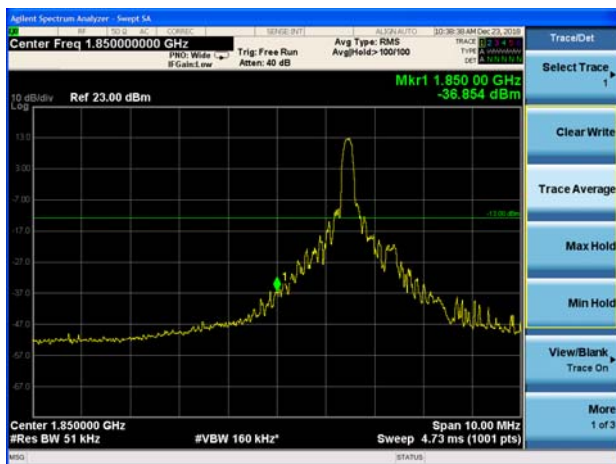

LTE Band 25 20MHz 16QAM 1RB CH-High

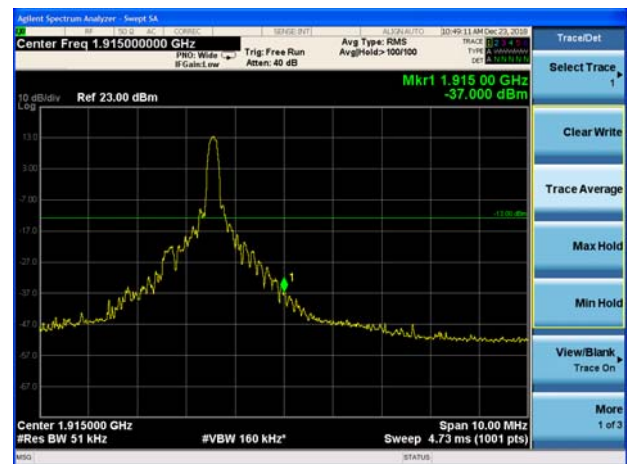

LTE Band 25 20MHz 16QAM 100%RB CH-Low

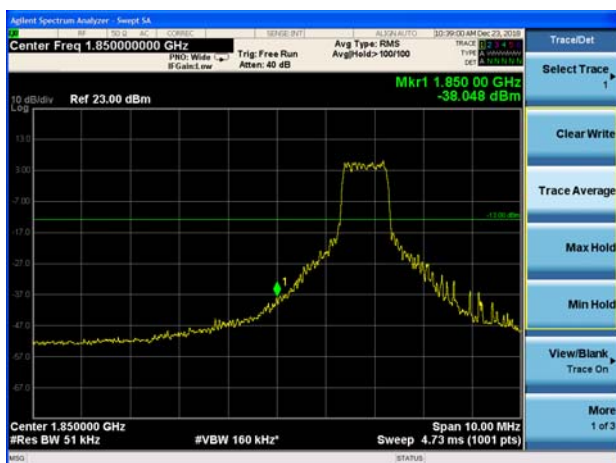

LTE Band 25 20MHz 16QAM 100%RB CH-High

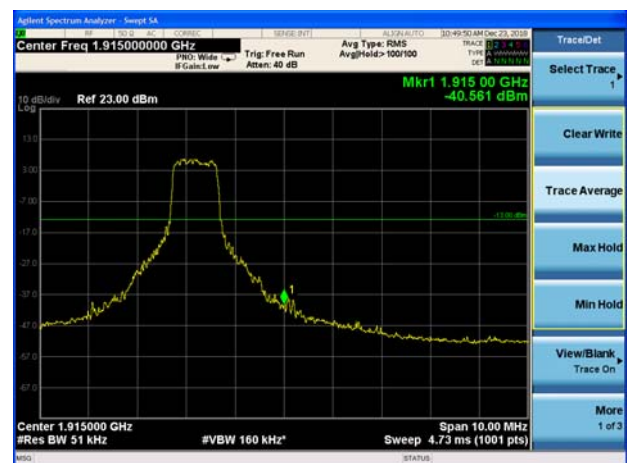

### 5.5. Peak-to-Average Power Ratio (PAPR)

#### Ambient condition

Temperature	Relative humidity	Pressure
23°C ~25°C	45%~50%	101.5kPa

#### Methods of Measurement

Measure the total peak power and record as PPk. And measure the total average power and record as PAvg. Both the peak and average power levels must be expressed in the same logarithmic units (e.g., dBm). Determine the PAPR from:

$$PAPR (dB) = PPk (dBm) - PAvg (dBm).$$

#### Test Setup

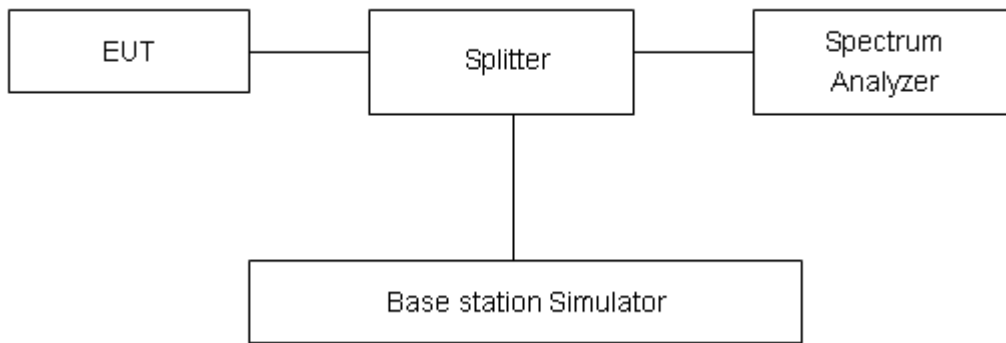

#### Limits

In measuring transmissions in this band using an average power technique, the peak-to-average ratio (PAR) of the transmission may not exceed 13 dB in 24.232(d).

#### Measurement Uncertainty

The assessed measurement uncertainty to ensure 95% confidence level for the normal distribution is with the coverage factor  $k = 2$ ,  $U = 0.4$  dB.





## Test Results

Mode	Bandwidth	Modulation	Channel/ Frequency(MHz)	Peak-to-Average Power Ratio (PAPR)			
				Peak(dBm)	Avg(dBm)	PAPR(dB)	
LTE Band 2	1.4MHz	QPSK	18900/1880	25.35	15.77	9.58	
		16QAM	18900/1880	26.16	16.30	9.86	
	3MHz	QPSK	18900/1880	25.24	15.67	9.57	
		16QAM	18900/1880	26.14	15.70	10.44	
	5MHz	QPSK	18900/1880	25.28	15.75	9.53	
		16QAM	18900/1880	26.40	17.09	9.31	
	10MHz	QPSK	18900/1880	25.14	15.31	9.83	
		16QAM	18900/1880	26.52	17.15	9.37	
	15MHz	QPSK	18900/1880	25.18	13.96	11.22	
		16QAM	18900/1880	26.53	16.77	9.76	
	20MHz	QPSK	18900/1880	25.89	15.74	10.15	
		16QAM	18900/1880	26.54	16.80	9.74	
	Mode	Bandwidth	Modulation	Channel/ Frequency(MHz)	Peak-to-Average Power Ratio (PAPR)		
					Peak(dBm)	Avg(dBm)	PAPR(dB)
LTE Band 25	1.4MHz	QPSK	26365/1882.5	25.56	16.03	9.53	
		16QAM	26365/1882.5	26.87	17.22	9.65	
	3MHz	QPSK	26365/1882.5	25.69	15.71	9.98	
		16QAM	26365/1882.5	26.49	16.44	10.05	
	5MHz	QPSK	26365/1882.5	25.80	15.64	10.16	
		16QAM	26365/1882.5	26.74	17.22	9.52	
	10MHz	QPSK	26365/1882.5	25.71	16.54	9.17	
		16QAM	26365/1882.5	26.25	16.55	9.70	
	15MHz	QPSK	26365/1882.5	25.57	15.89	9.68	
		16QAM	26365/1882.5	26.47	16.46	10.01	
	20MHz	QPSK	26365/1882.5	25.85	16.92	8.93	
		16QAM	26365/1882.5	26.57	17.08	9.49	

## 5.6. Frequency Stability

### Ambient condition

Temperature	Relative humidity	Pressure
23°C ~25°C	45%~50%	101.5kPa

### Method of Measurement

#### Frequency Stability (Temperature Variation)

The temperature inside the climate chamber is varied from -40°C to +85°C in 10°C step size,

(1) With all power removed, the temperature was decreased to 0°C and permitted to stabilize for three hours.

(2) Measure the carrier frequency with the test equipment in a “call mode”. These measurements should be made within 1 minute of powering up the mobile station, to prevent significant self warming.

(3) Repeat the above measurements at 10°C increments from -40°C to +85°C. Allow at least 1.5 hours at each temperature, un-powered, before making measurements.

#### Frequency Stability (Voltage Variation)

The frequency stability shall be measured with variation of primary supply voltage as follows:

(1) Vary primary supply voltage from 85 to 115 percent of the nominal value for other than hand carried battery equipment.

(2) For hand carried, battery powered equipment, reduce primary supply voltage to the battery-operating end point which shall be specified by the manufacturer.

This transceiver is specified to operate with an input voltage of between 3.3 V and 4.3 V, with a nominal voltage of 3.8V.

### Test setup

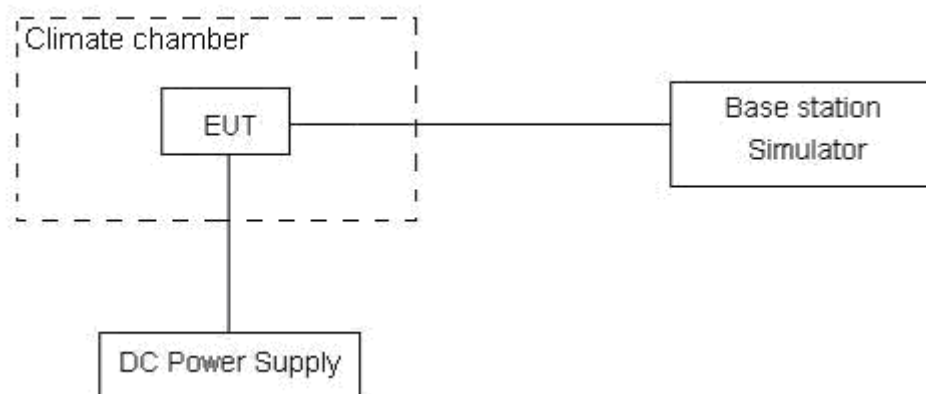

**Limits**

The frequency stability shall be sufficient to ensure that the fundamental emission stays within the authorized frequency block

**Measurement Uncertainty**

The assessed measurement uncertainty to ensure 99.75% confidence level for the normal distribution is with the coverage factor  $k = 3$ ,  $U = 0.01\text{ppm}$ .



## Test Result

LTE Band 2					
QPSK,(20MHz BANDWIDTH)					
Condition		1850	1910	Delta	Frequency
Temperature	Voltage	F low@-13dBm (MHz)	F high@-13dBm (MHz)	(Hz)	Stability (ppm)
Normal (25°C)	Normal	1851.1788	1908.8258	6.38	0.00339
Extreme (85°C)		1851.1791	1908.8255	3.82	0.00203
Extreme (80°C)		1851.1794	1908.8252	9.17	0.00488
Extreme (70°C)		1851.1789	1908.8257	17.50	0.00931
Extreme (60°C)		1851.1783	1908.8253	12.33	0.00656
Extreme (50°C)		1851.1868	1908.8338	2.16	0.00115
Extreme (40°C)		1851.1822	1908.8292	9.74	0.00518
Extreme (30°C)		1851.1829	1908.8299	6.03	0.00321
Extreme (20°C)		1851.1832	1908.8302	4.15	0.00221
Extreme (10°C)		1851.1797	1908.8267	6.75	0.00359
Extreme (0°C)		1851.1856	1908.8326	8.19	0.00436
Extreme (-10°C)		1851.1793	1908.8263	16.34	0.00869
Extreme (-20°C)		1851.1834	1908.8304	17.42	0.00927
Extreme (-30°C)		1851.1781	1908.8252	4.32	0.00230
Extreme (-40°C)		1851.1788	1908.8258	9.25	0.00492
25°C	LV	1851.1832	1908.8302	3.21	0.00171
	HV	1851.1781	1908.8251	6.57	0.00349
16QAM,(20MHz BANDWIDTH)					
Condition		1850	1910	Delta	Frequency
Temperature	Voltage	F low@-13dBm (MHz)	F high@-13dBm (MHz)	(Hz)	Stability (ppm)
Normal (25°C)	Normal	1851.1742	1908.8212	3.83	0.00204
Extreme (85°C)		1851.1745	1908.8209	4.68	0.00249
Extreme (80°C)		1851.1748	1908.8206	7.69	0.00409
Extreme (70°C)		1851.1743	1908.8211	2.18	0.00116
Extreme (60°C)		1851.1747	1908.8217	3.06	0.00163
Extreme (50°C)		1851.1662	1908.8132	17.94	0.00954
Extreme (40°C)		1851.1708	1908.8178	5.42	0.00288
Extreme (30°C)		1851.1701	1908.8171	12.31	0.00655
Extreme (20°C)		1851.1698	1908.8168	7.06	0.00376
Extreme (10°C)		1851.1733	1908.8203	11.50	0.00612
Extreme (0°C)		1851.1674	1908.8144	7.57	0.00403
Extreme (-10°C)		1851.1737	1908.8207	6.92	0.00368
Extreme (-20°C)		1851.1696	1908.8166	5.42	0.00288
Extreme (-30°C)		1851.1753	1908.8222	7.55	0.00402



Extreme (-40°C)		1851.1742	1908.8212	11.14	0.00593
25°C	LV	1851.1698	1908.8168	15.29	0.00813
	HV	1851.1749	1908.8219	11.02	0.00586

LTE Band 25					
QPSK,(20MHz BANDWIDTH)					
Condition		1850	1915	Delta	Frequency
Temperature	Voltage	F low@-13dBm (MHz)	F high@-13dBm (MHz)	(Hz)	Stability (ppm)
Normal (25°C)	Normal	1851.1788	1914.8258	7.71	0.00410
Extreme (85°C)		1851.1791	1914.8255	2.64	0.00140
Extreme (80°C)		1851.1794	1914.8252	17.23	0.00916
Extreme (70°C)		1851.1789	1914.8257	-7.62	-0.00405
Extreme (60°C)		1851.1783	1914.8253	1.43	0.00076
Extreme (50°C)		1851.1868	1914.8338	5.81	0.00309
Extreme (40°C)		1851.1822	1914.8292	-12.33	-0.00656
Extreme (30°C)		1851.1829	1914.8299	6.42	0.00341
Extreme (20°C)		1851.1832	1914.8302	2.39	0.00127
Extreme (10°C)		1851.1797	1914.8267	17.45	0.00928
Extreme (0°C)		1851.1856	1914.8326	8.46	0.00450
Extreme (-10°C)		1851.1793	1914.8263	-13.02	-0.00693
Extreme (-20°C)		1851.1834	1914.8304	12.35	0.00657
Extreme (-30°C)		1851.1781	1914.8252	9.76	0.00519
Extreme (-40°C)		1851.1788	1914.8258	5.25	0.00279
25°C		LV	1851.1832	1914.8302	-2.64
	HV	1851.1781	1914.8251	9.16	0.00487
16QAM,(20MHz BANDWIDTH)					
Condition		1850	1915	Delta	Frequency
Temperature	Voltage	F low@-13dBm (MHz)	F high@-13dBm (MHz)	(Hz)	Stability (ppm)
Normal (25°C)	Normal	1851.1742	1914.8212	-5.48	-0.00291
Extreme (85°C)		1851.1745	1914.8209	3.14	0.00167
Extreme (80°C)		1851.1748	1914.8206	7.68	0.00409
Extreme (70°C)		1851.1743	1914.8211	9.24	0.00491
Extreme (60°C)		1851.1747	1914.8217	-15.33	-0.00815
Extreme (50°C)		1851.1662	1914.8132	4.25	0.00226
Extreme (40°C)		1851.1708	1914.8178	8.13	0.00432
Extreme (30°C)		1851.1701	1914.8171	-2.54	-0.00135
Extreme (20°C)		1851.1698	1914.8168	14.10	0.00750
Extreme (10°C)		1851.1733	1914.8203	6.10	0.00324
Extreme (0°C)		1851.1674	1914.8144	2.84	0.00151
Extreme (-10°C)		1851.1737	1914.8207	13.64	0.00726



Extreme (-20°C)		1851.1696	1914.8166	-6.49	-0.00345
Extreme (-30°C)		1851.1753	1914.8222	2.01	0.00107
Extreme (-40°C)		1851.1742	1914.8212	7.38	0.00393
25°C	LV	1851.1698	1914.8168	4.32	0.00230
	HV	1851.1749	1914.8219	3.96	0.00211

### 5.7. Spurious Emissions at Antenna Terminals

#### Ambient condition

Temperature	Relative humidity	Pressure
23°C ~25°C	45%~50%	101.5kPa

#### Method of Measurement

The EUT was connected to Spectrum Analyzer and Base Station Simulator via power Splitter. The measurement is carried out using a spectrum analyzer. The spectrum analyzer scans from 9kHz to the 10th harmonic of the carrier. The peak detector is used.

RBW is set to 100kHz, VBW is set to 300kHz for 30MHz~1GHz

RBW is set to 1MHz, VBW is set to 3MHz for above 1GHz, Sweep is set to ATUO.

The modulation mode and RB allocation refer to section 5.1, using the maximum output power configuration.

#### Test setup

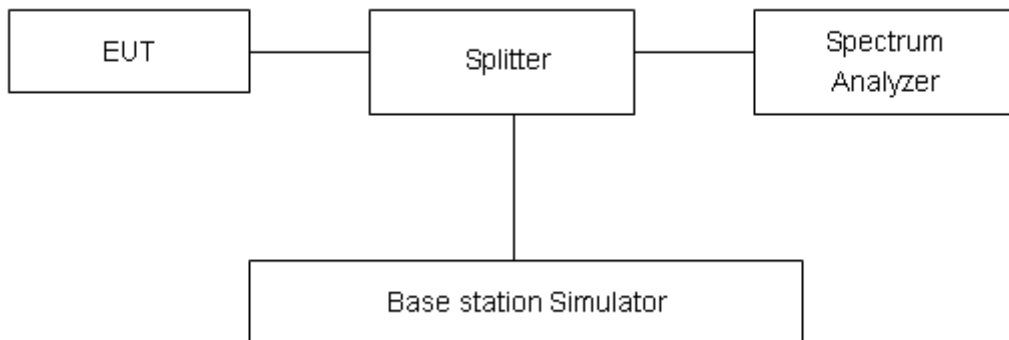

#### Limits

Rule Part 24.238(a) specifies that “on any frequency outside a licensee's frequency block, the power of any emission shall be attenuated below the transmitter power (P) by at least 43 + 10 log10 (P) dB.”

Limit	-13 dBm
-------	---------

#### Measurement Uncertainty

The assessed measurement uncertainty to ensure 99.75% confidence level for the normal distribution is with the coverage factor  $k = 1.96$ .

Frequency	Uncertainty
9kHz-1GHz	0.684 dB
1GHz-20GHz	1.407 dB



### Test Result

Sweep the whole frequency band through the range from 9kHz to the 10th harmonic of the carrier, the emissions more than 20 dB below the limit are not reported.

The signal beyond the limit is carrier.

#### LTE Band 2 1.4MHz CH-Low 30MHz~1GHz

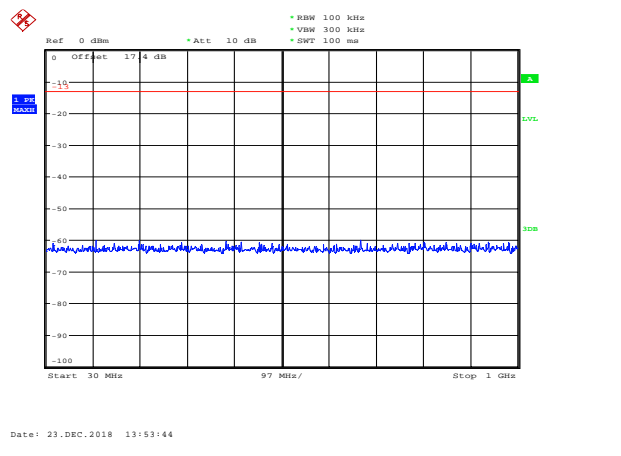

#### LTE Band 2 1.4MHz CH-Middle 30MHz~1GHz

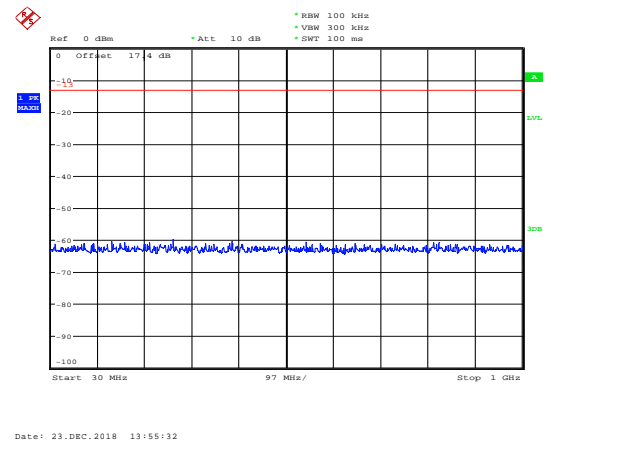

#### LTE Band 2 1.4MHz CH-Low 1GHz~3GHz

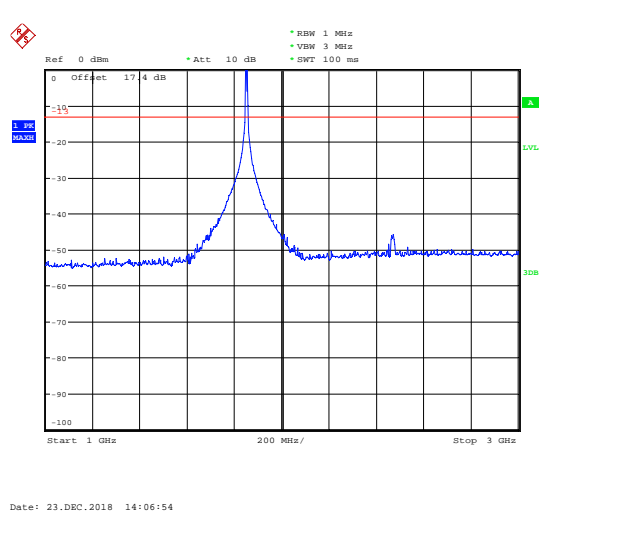

#### LTE Band 2 1.4MHz CH-Middle 1GHz~3GHz

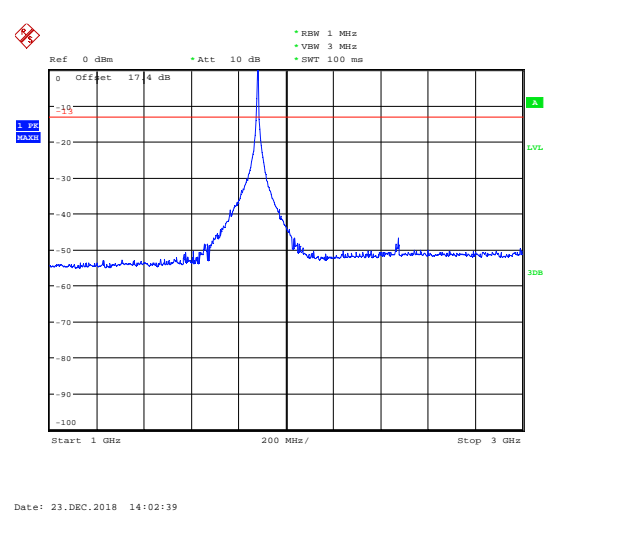

#### LTE Band 2 1.4MHz CH-Low 3GHz~20GHz

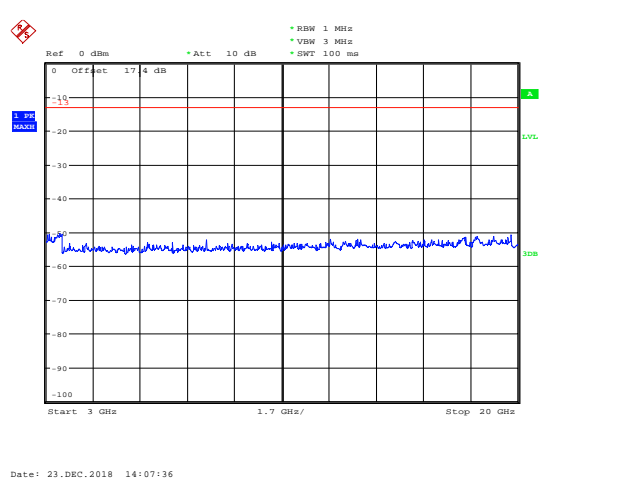

#### LTE Band 2 1.4MHz CH-Middle 3GHz~20GHz

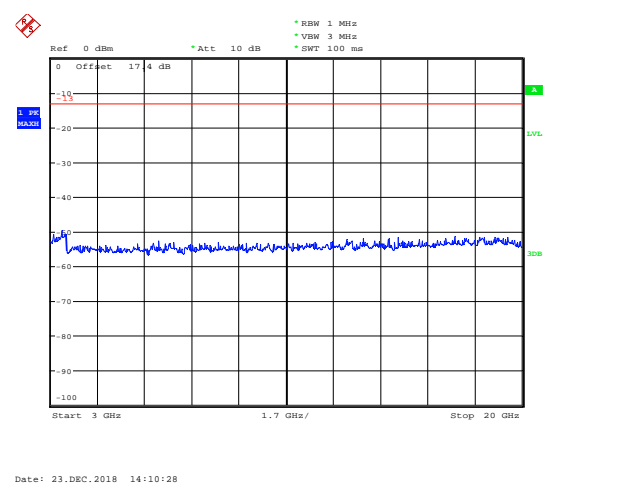





### LTE Band 2 1.4MHz CH-High 30MHz~1GHz

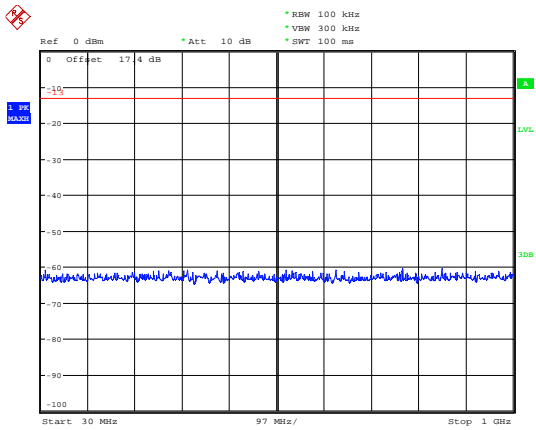

Date: 23.DEC.2018 13:58:04

### LTE Band 2 3MHz CH-Low 30MHz~1GHz

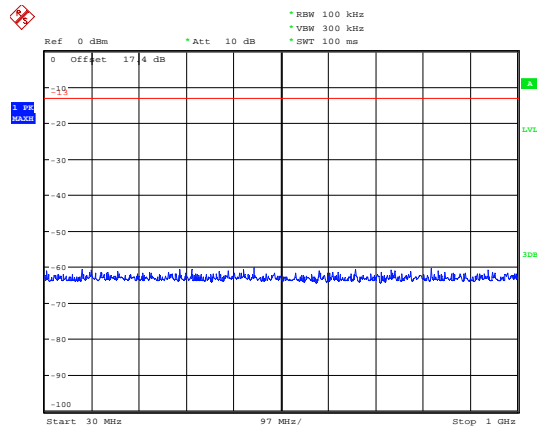

Date: 23.DEC.2018 14:16:42

### LTE Band 2 1.4MHz CH-High 1GHz~3GHz

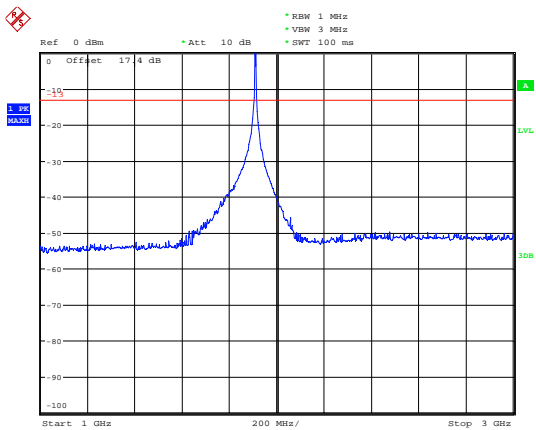

Date: 23.DEC.2018 13:59:21

### LTE Band 2 3MHz CH-Low 1GHz~3GHz

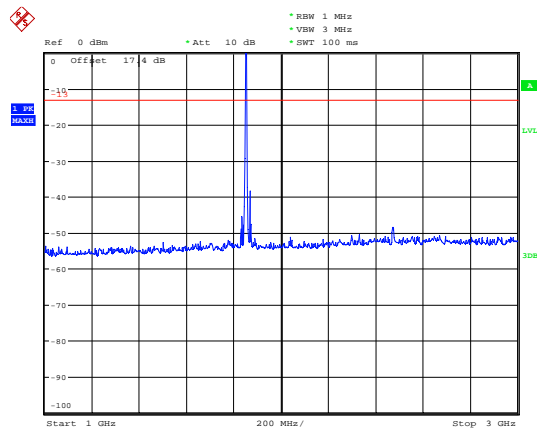

Date: 23.DEC.2018 14:16:23

### LTE Band 2 1.4MHz CH-High 3GHz~20GHz

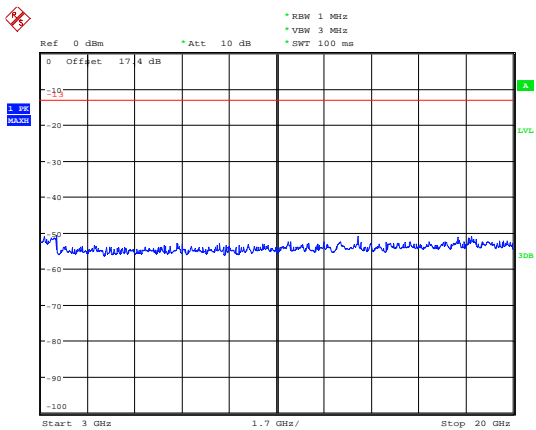

Date: 23.DEC.2018 14:11:04

### LTE Band 2 3MHz CH-Low 3GHz~20GHz

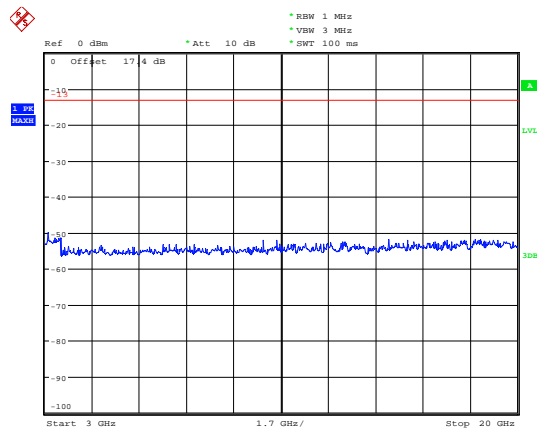

Date: 23.DEC.2018 14:11:38



### LTE Band 2 3MHz CH-Middle 30MHz~1GHz

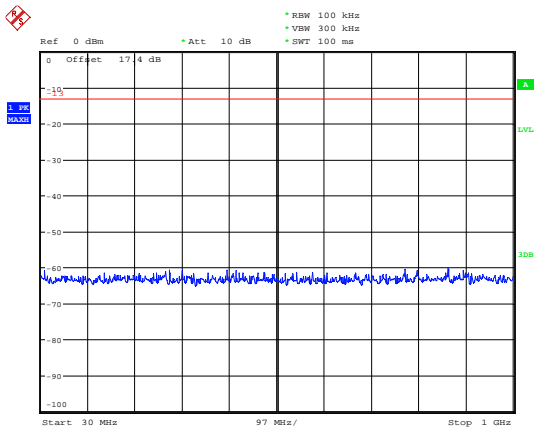

Date: 23.DEC.2018 14:15:25

### LTE Band 2 3MHz CH-High 30MHz~1GHz

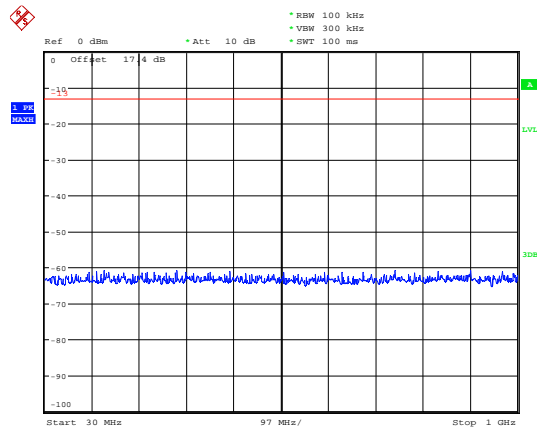

Date: 23.DEC.2018 14:14:51

### LTE Band 2 3MHz CH-Middle 1GHz~3GHz

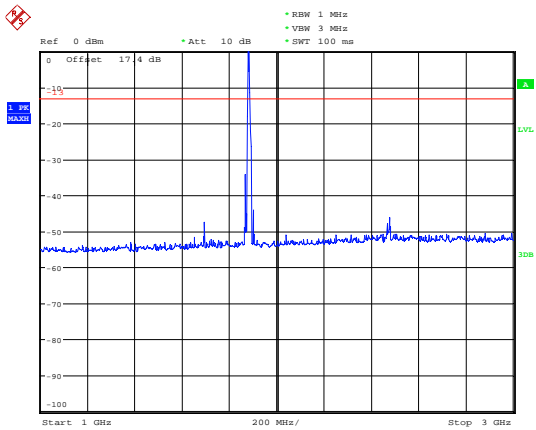

Date: 23.DEC.2018 14:15:48

### LTE Band 2 3MHz CH-High 1GHz~3GHz

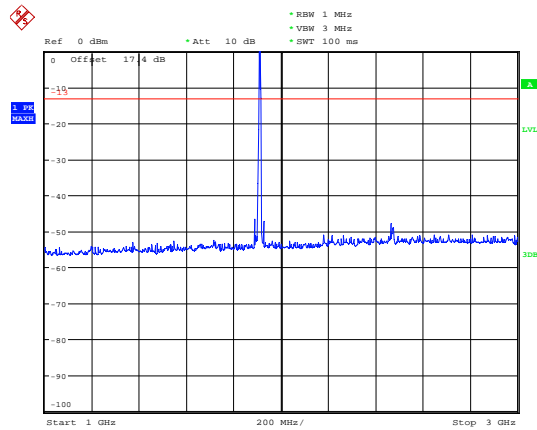

Date: 23.DEC.2018 14:14:29

### LTE Band 2 3MHz CH-Middle 3GHz~20GHz

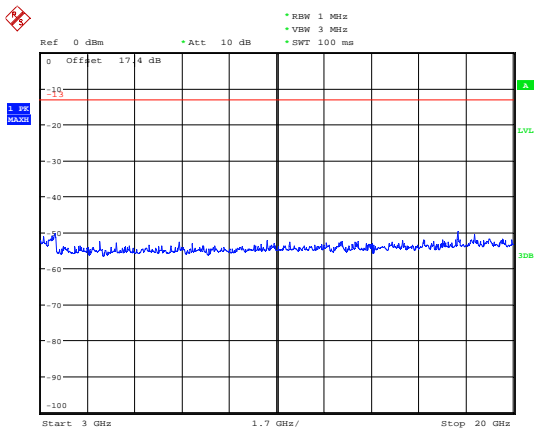

Date: 23.DEC.2018 14:13:33

### LTE Band 2 3MHz CH-High 3GHz~20GHz

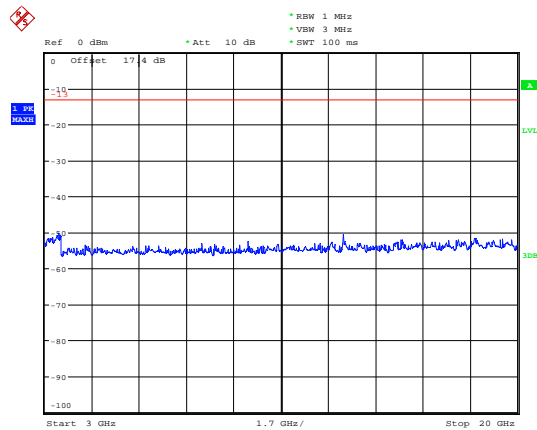

Date: 23.DEC.2018 14:14:14



### LTE Band 2 5MHz CH-Low 30MHz~1GHz

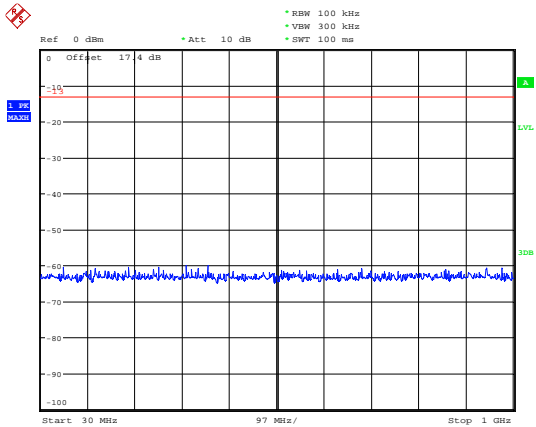

Date: 23.DEC.2018 14:17:35

### LTE Band 2 5MHz CH-Middle 30MHz~1GHz

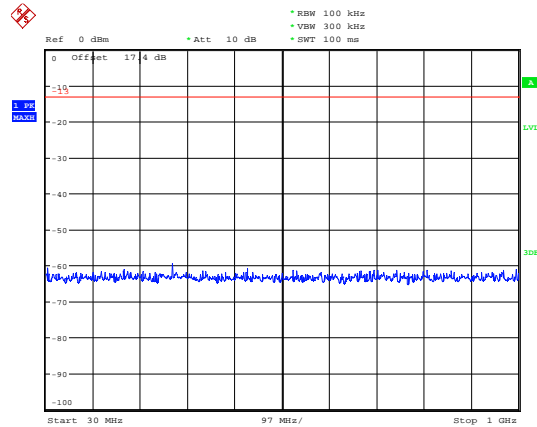

Date: 23.DEC.2018 14:17:53

### LTE Band 2 5MHz CH-Low 1GHz~3GHz

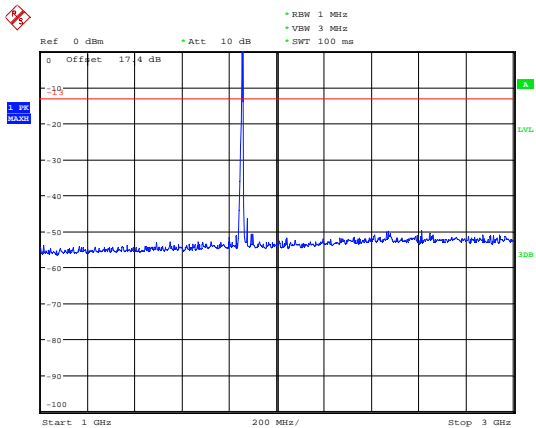

Date: 23.DEC.2018 14:32:50

### LTE Band 2 5MHz CH-Middle 1GHz~3GHz

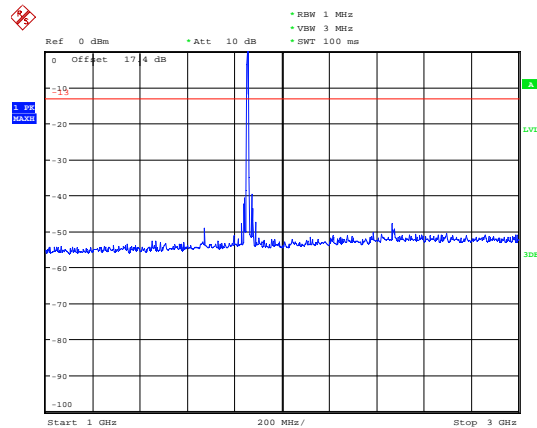

Date: 23.DEC.2018 14:33:09

### LTE Band 2 5MHz CH-Low 3GHz~20GHz

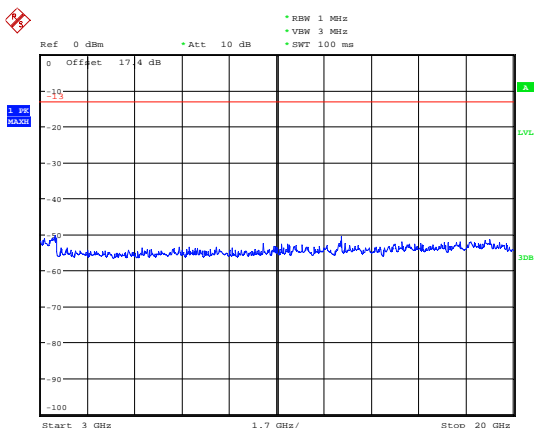

Date: 23.DEC.2018 15:20:30

### LTE Band 2 5MHz CH-Middle 3GHz~20GHz

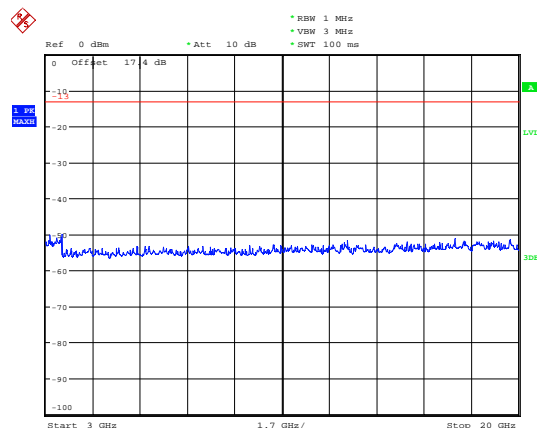

Date: 23.DEC.2018 15:20:18



### LTE Band 2 5MHz CH-High 30MHz~1GHz

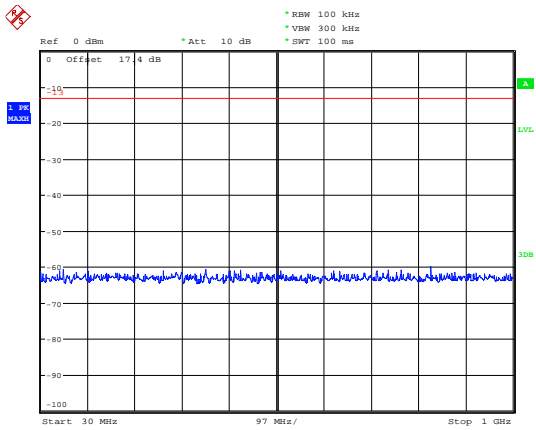

Date: 23.DEC.2018 14:18:02

### LTE Band 2 10MHz CH-Low 30MHz~1GHz

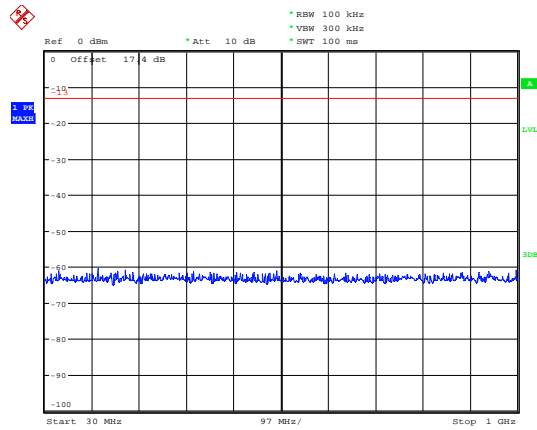

Date: 23.DEC.2018 14:18:36

### LTE Band 2 5MHz CH-High 1GHz~3GHz

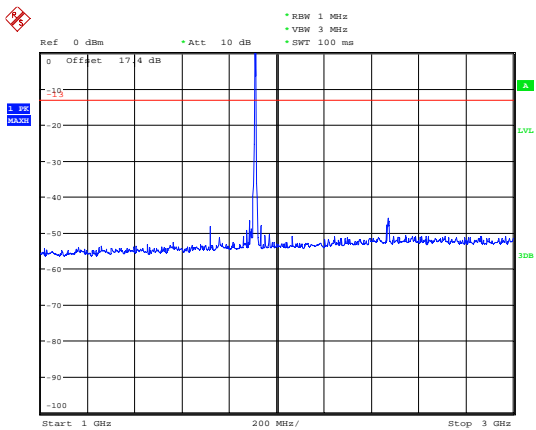

Date: 23.DEC.2018 14:34:31

### LTE Band 2 10MHz CH-Low 1GHz~3GHz

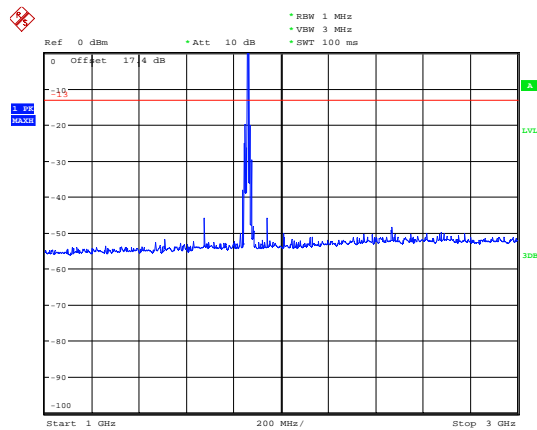

Date: 23.DEC.2018 14:30:49

### LTE Band 2 5MHz CH-High 3GHz~20GHz

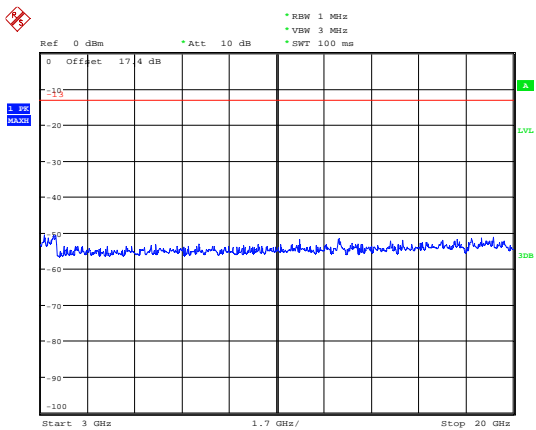

Date: 23.DEC.2018 14:34:53

### LTE Band 2 10MHz CH-Low 3GHz~20GHz

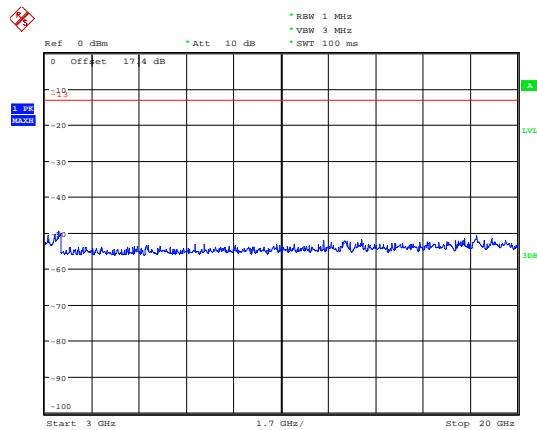

Date: 23.DEC.2018 15:21:18



### LTE Band 2 10MHz CH-Middle 30MHz~1GHz

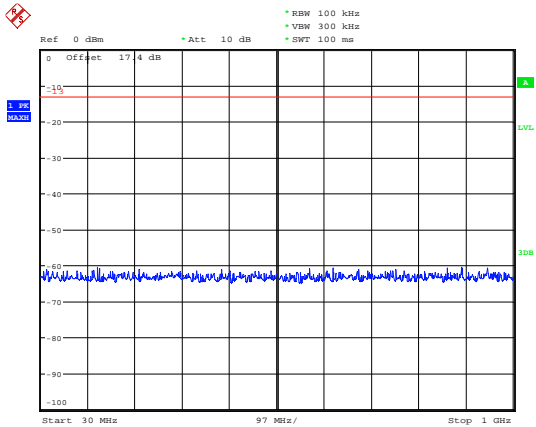

Date: 23.DEC.2018 14:18:24

### LTE Band 2 10MHz CH-High 30MHz~1GHz

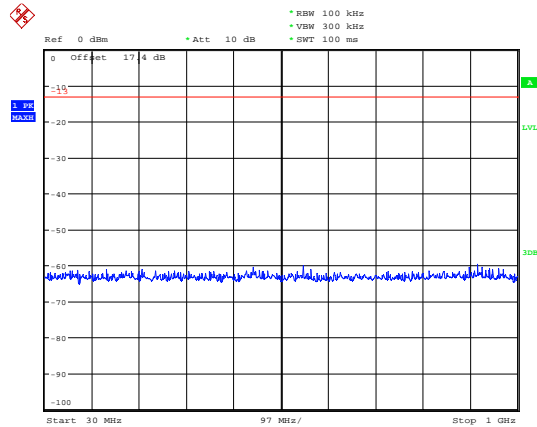

Date: 23.DEC.2018 14:18:44

### LTE Band 2 10MHz CH-Middle 1GHz~3GHz

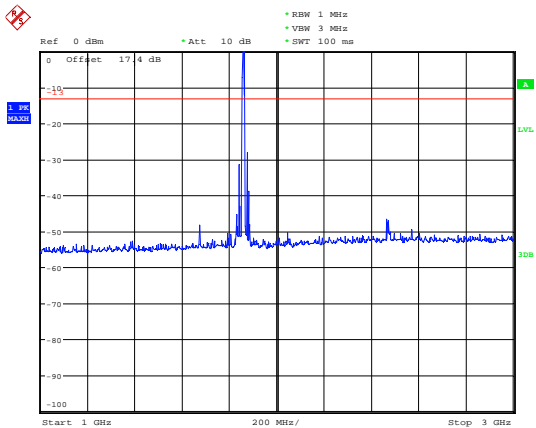

Date: 23.DEC.2018 14:31:11

### LTE Band 2 10MHz CH-High 1GHz~3GHz

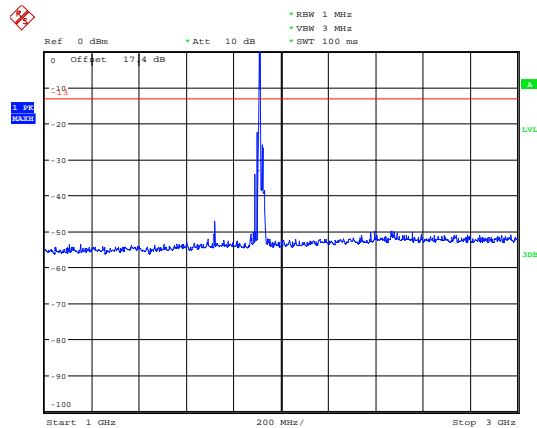

Date: 23.DEC.2018 14:32:16

### LTE Band 2 10MHz CH-Middle 3GHz~20GHz

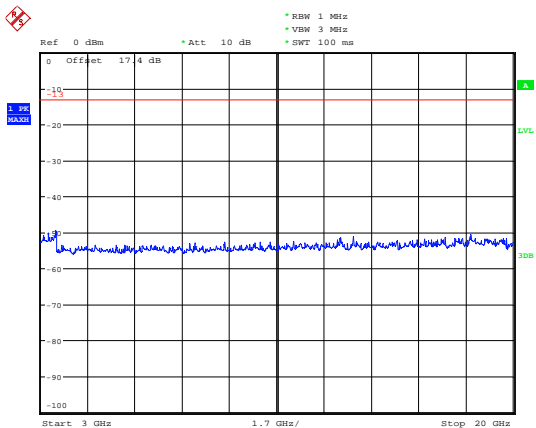

Date: 23.DEC.2018 15:21:02

### LTE Band 2 10MHz CH-High 3GHz~20GHz

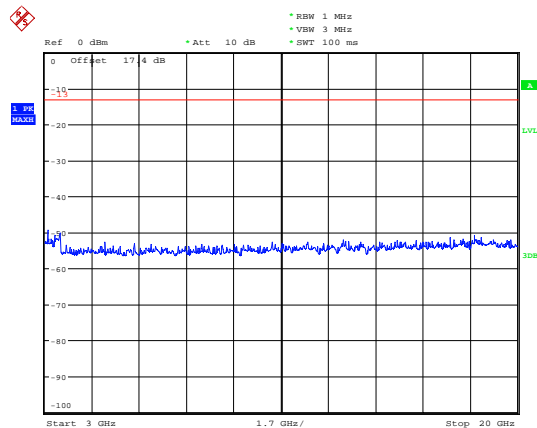

Date: 23.DEC.2018 15:21:28



### LTE Band 2 15MHz CH-Low 30MHz~1GHz

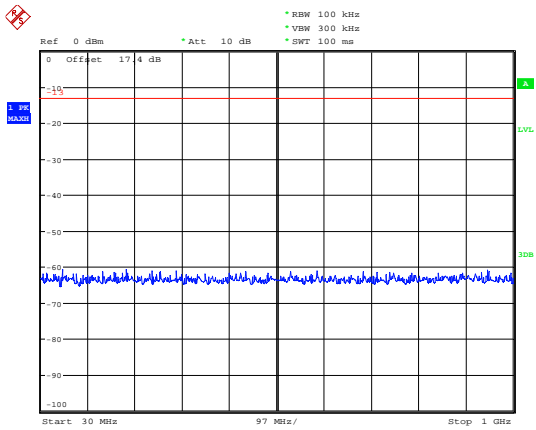

Date: 23.DEC.2018 14:19:13

### LTE Band 2 15MHz CH-Middle 30MHz~1GHz

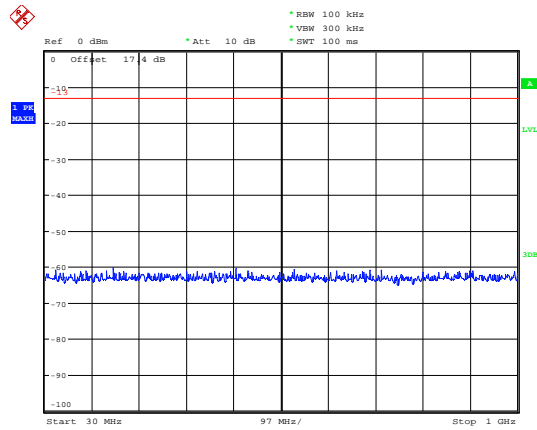

Date: 23.DEC.2018 14:19:06

### LTE Band 2 15MHz CH-Low 1GHz~3GHz

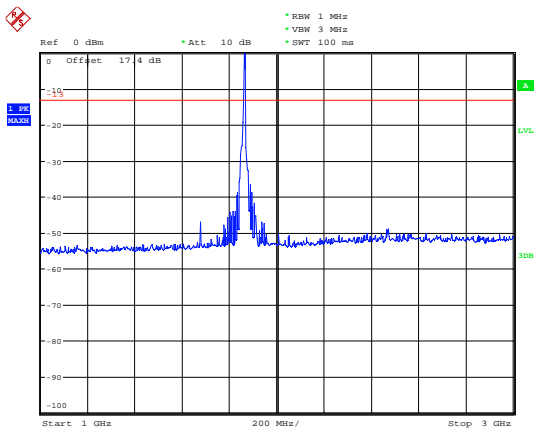

Date: 23.DEC.2018 14:27:09

### LTE Band 2 15MHz CH-Middle 1GHz~3GHz

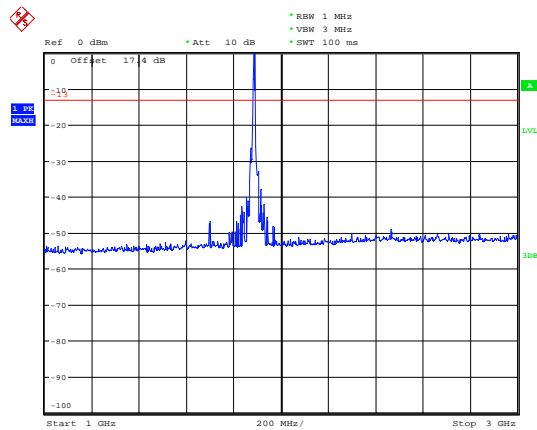

Date: 23.DEC.2018 14:27:48

### LTE Band 2 15MHz CH-Low 3GHz~20GHz

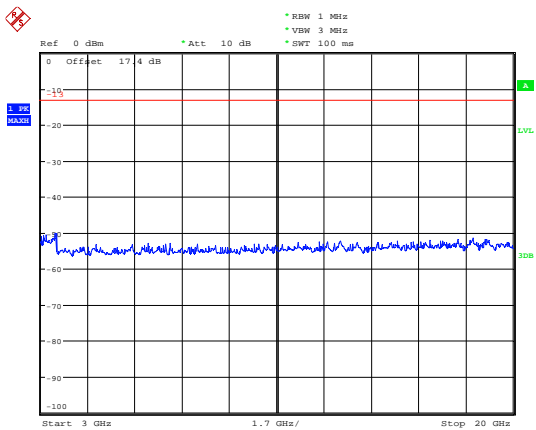

Date: 23.DEC.2018 15:21:57

### LTE Band 2 15MHz CH-Middle 3GHz~20GHz

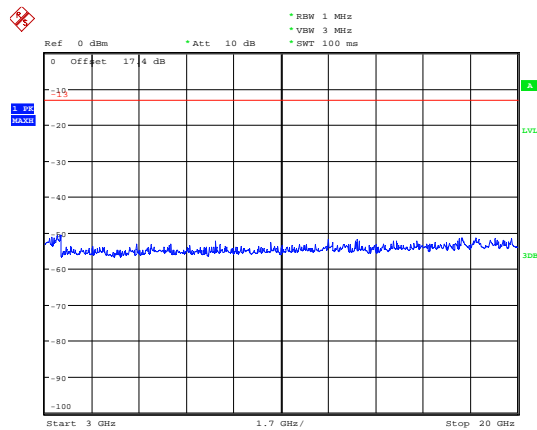

Date: 23.DEC.2018 15:21:47



### LTE Band 2 15MHz CH-High 30MHz~1GHz

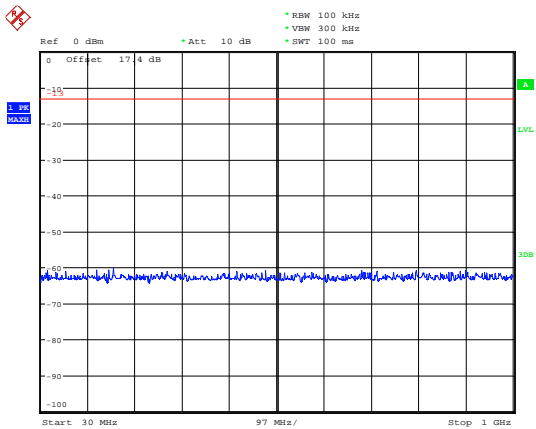

Date: 23.DEC.2018 14:19:25

### LTE Band 2 20MHz CH-Low 30MHz~1GHz

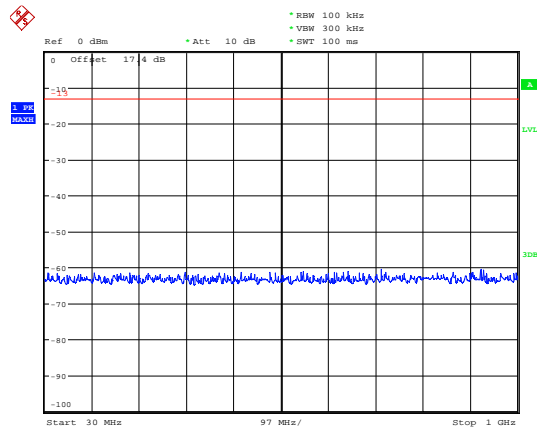

Date: 23.DEC.2018 14:19:50

### LTE Band 2 15MHz CH-High 1GHz~3GHz

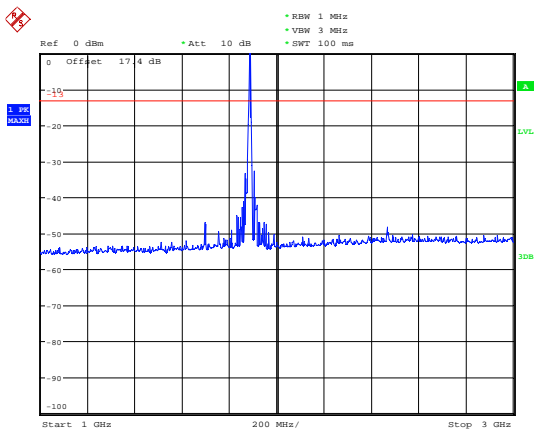

Date: 23.DEC.2018 14:28:21

### LTE Band 2 20MHz CH-Low 1GHz~3GHz

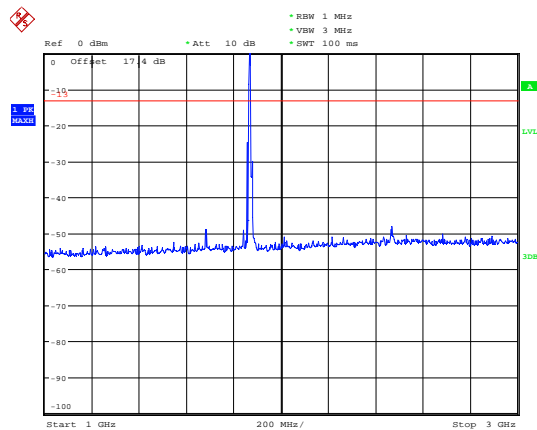

Date: 23.DEC.2018 14:24:40

### LTE Band 2 15MHz CH-High 3GHz~20GHz

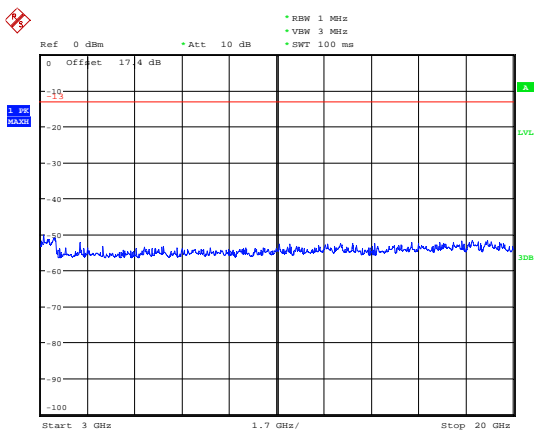

Date: 23.DEC.2018 15:22:06

### LTE Band 2 20MHz CH-Low 3GHz~20GHz

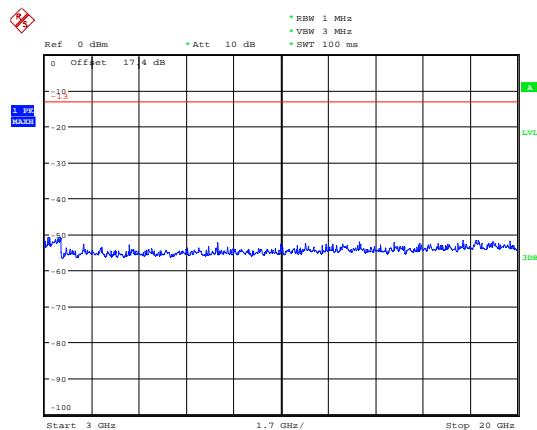

Date: 23.DEC.2018 15:22:30



### LTE Band 2 20MHz CH-Middle 30MHz~1GHz

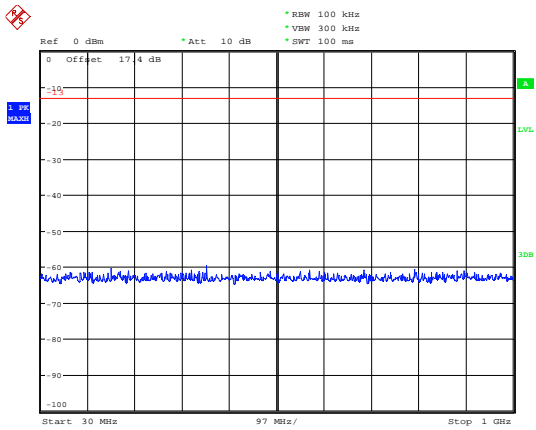

Date: 23.DEC.2018 14:19:42

### LTE Band 2 20MHz CH-High 30MHz~1GHz

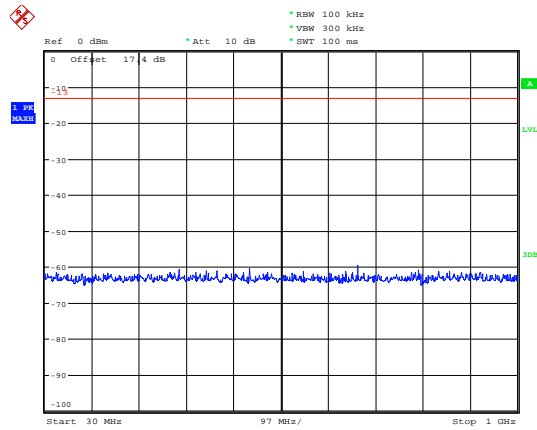

Date: 23.DEC.2018 14:19:58

### LTE Band 2 20MHz CH-Middle 1GHz~3GHz

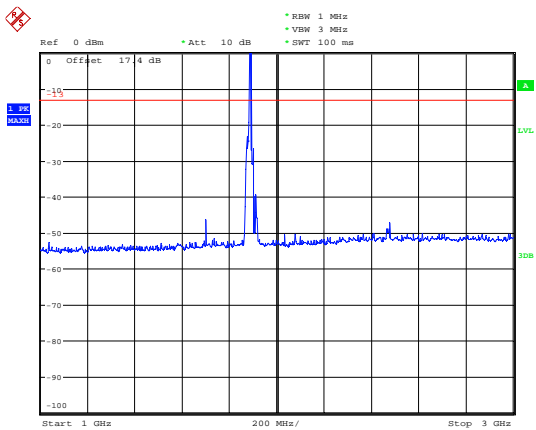

Date: 23.DEC.2018 14:20:33

### LTE Band 2 20MHz CH-High 1GHz~3GHz

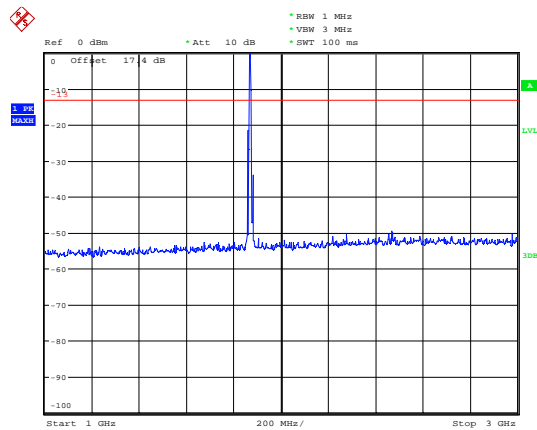

Date: 23.DEC.2018 14:25:04

### LTE Band 2 20MHz CH-Middle 3GHz~20GHz

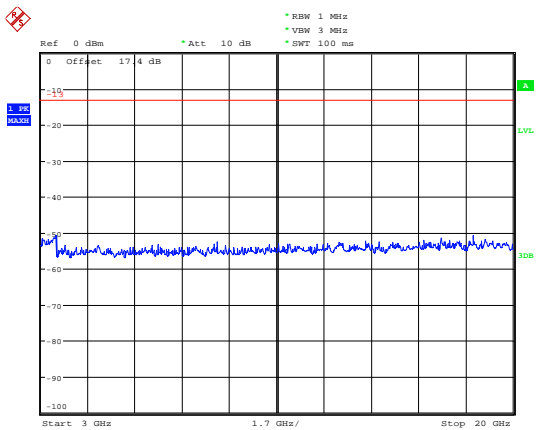

Date: 23.DEC.2018 15:22:23

### LTE Band 2 20MHz CH-High 3GHz~20GHz

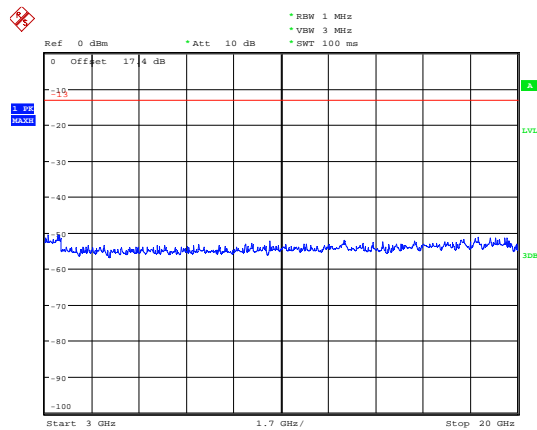

Date: 23.DEC.2018 15:22:39





LTE Band 25 1.4MHz CH-Low 30MHz~1GHz

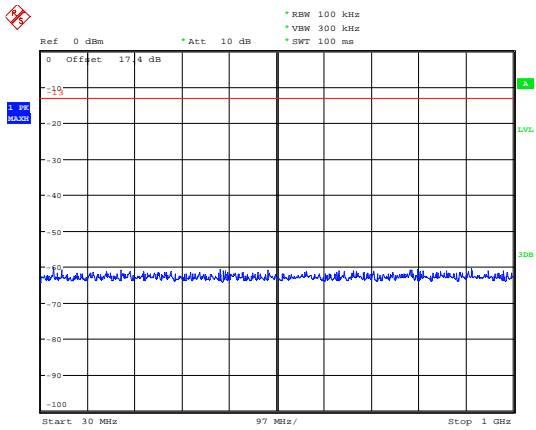

Date: 24.DEC.2018 11:30:21

LTE Band 25 1.4MHz CH-Middle 30MHz~1GHz

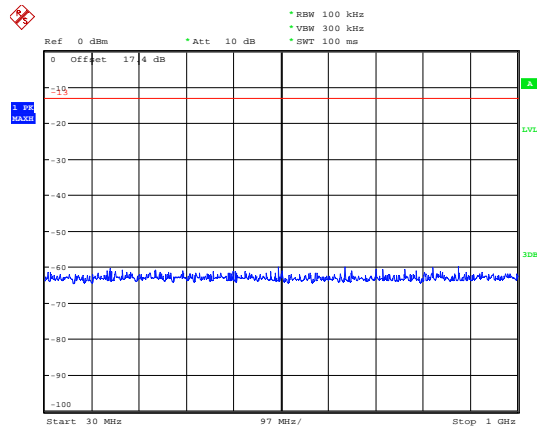

Date: 24.DEC.2018 11:31:46

LTE Band 25 1.4MHz CH-Low 1GHz~3GHz

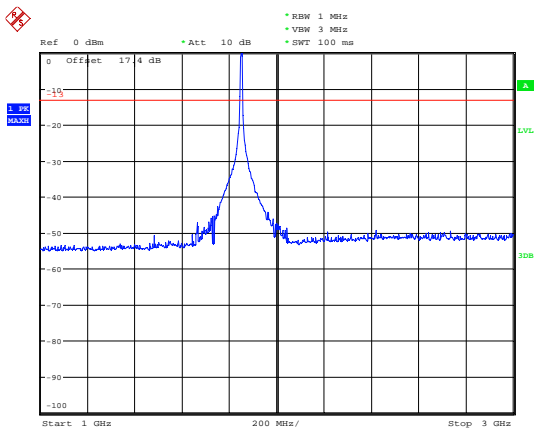

Date: 24.DEC.2018 13:20:37

LTE Band 25 1.4MHz CH-Middle 1GHz~3GHz

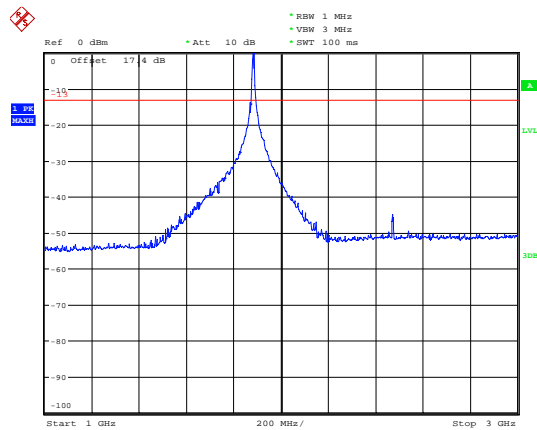

Date: 24.DEC.2018 19:13:30

LTE Band 25 1.4MHz CH-Low 3GHz~20GHz

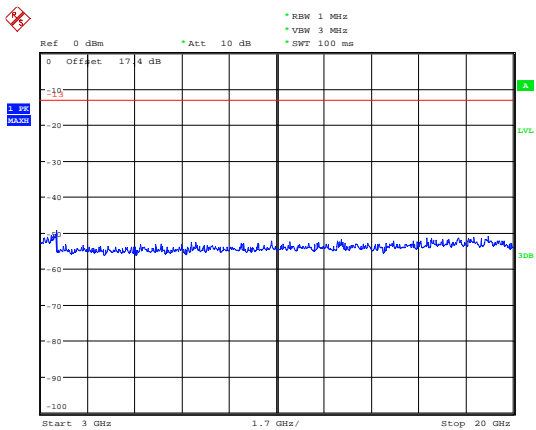

Date: 24.DEC.2018 12:01:14

LTE Band 25 1.4MHz CH-Middle 3GHz~20GHz

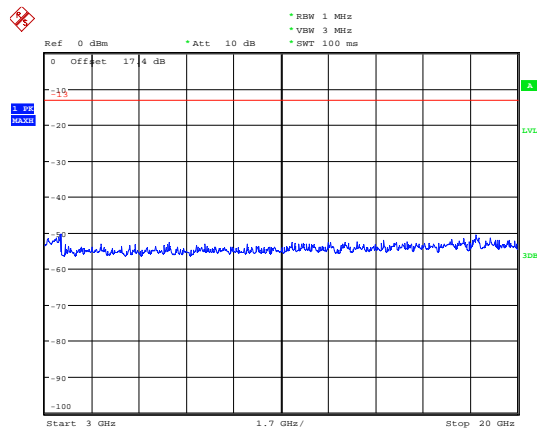

Date: 24.DEC.2018 12:01:37



### LTE Band 25 1.4MHz CH-High 30MHz~1GHz

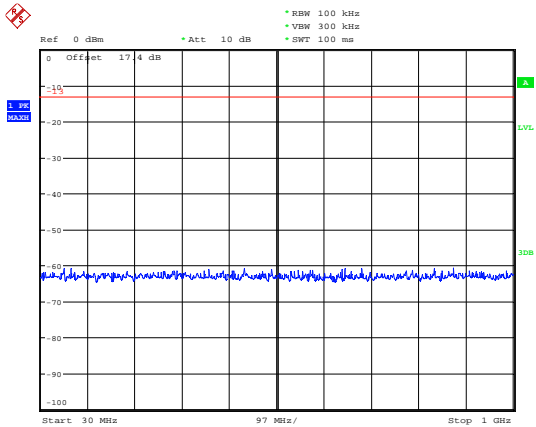

Date: 24.DEC.2018 11:32:43

### LTE Band 25 3MHz CH-Low 30MHz~1GHz

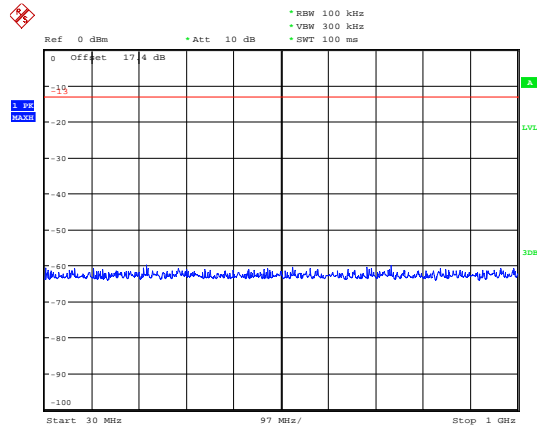

Date: 24.DEC.2018 11:33:32

### LTE Band 25 1.4MHz CH-High 1GHz~3GHz

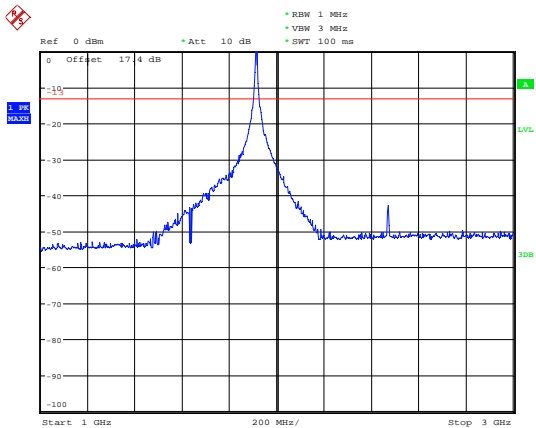

Date: 24.DEC.2018 19:21:33

### LTE Band 25 3MHz CH-Low 1GHz~3GHz

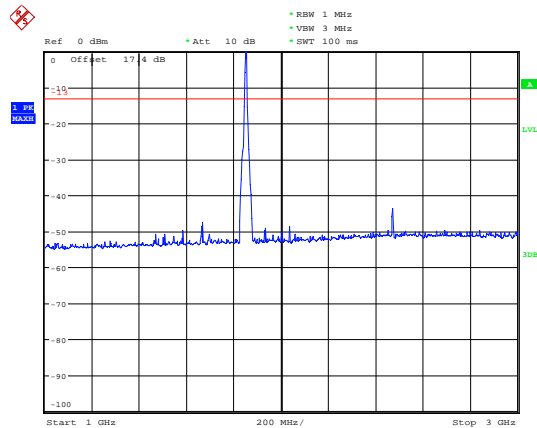

Date: 24.DEC.2018 19:24:10

### LTE Band 25 1.4MHz CH-High 3GHz~20GHz

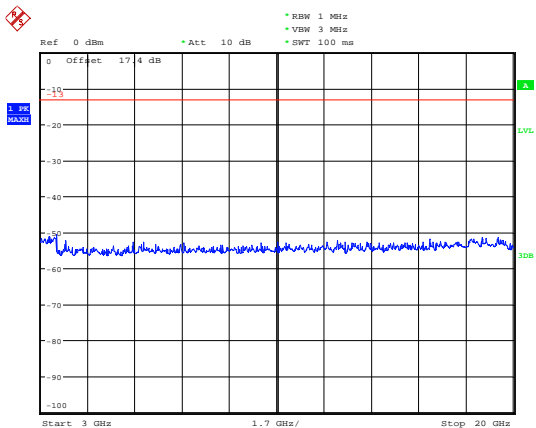

Date: 24.DEC.2018 12:02:09

### LTE Band 25 3MHz CH-Low 3GHz~20GHz

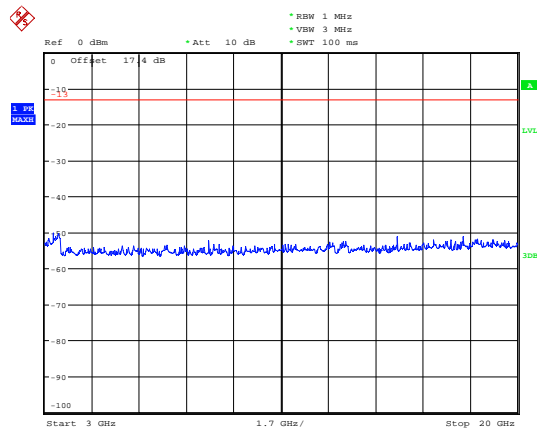

Date: 24.DEC.2018 12:03:41



### LTE Band 25 3MHz CH-Middle 30MHz~1GHz

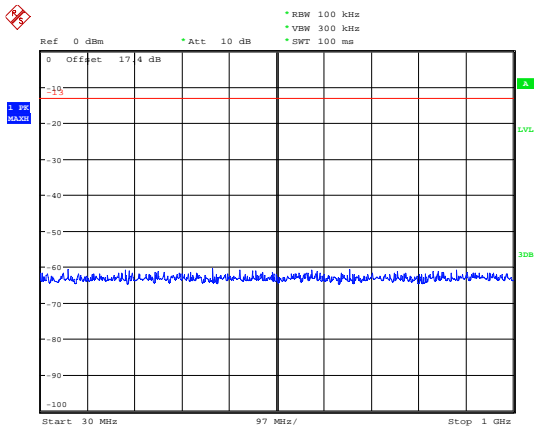

Date: 24.DEC.2018 11:33:14

### LTE Band 25 3MHz CH-High 30MHz~1GHz

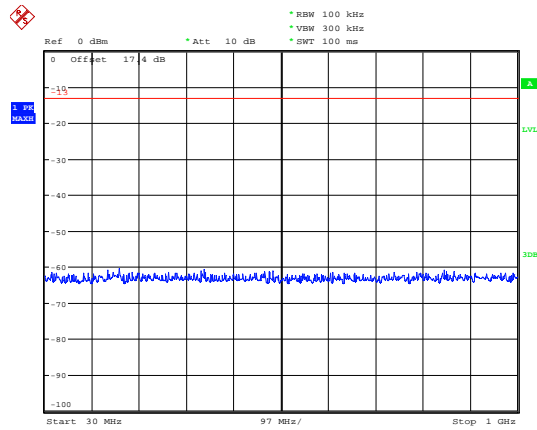

Date: 24.DEC.2018 11:33:42

### LTE Band 25 3MHz CH-Middle 1GHz~3GHz

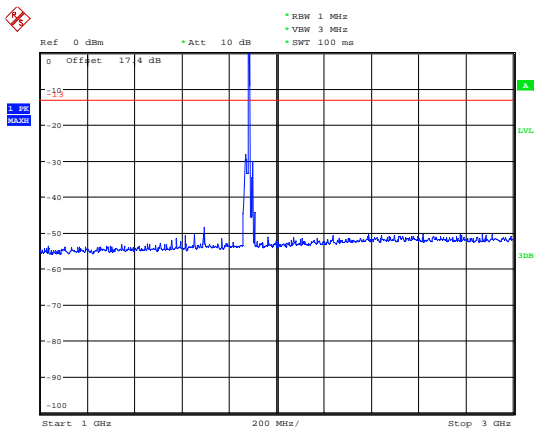

Date: 24.DEC.2018 19:24:57

### LTE Band 25 3MHz CH-High 1GHz~3GHz

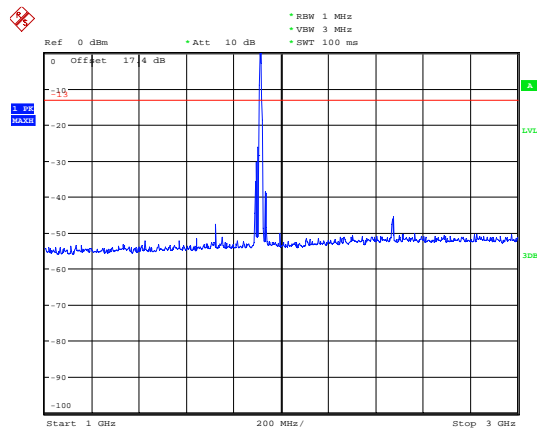

Date: 24.DEC.2018 19:25:35

### LTE Band 25 3MHz CH-Middle 3GHz~20GHz

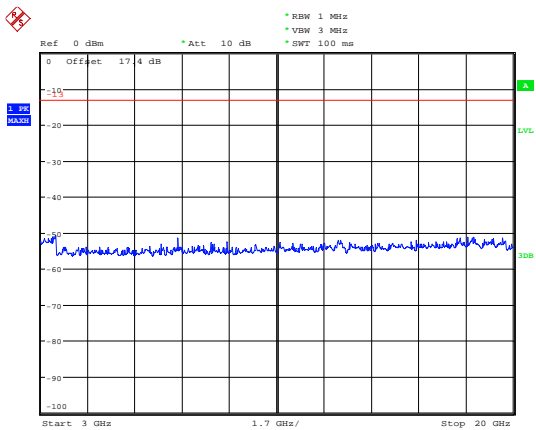

Date: 24.DEC.2018 12:04:13

### LTE Band 25 3MHz CH-High 3GHz~20GHz

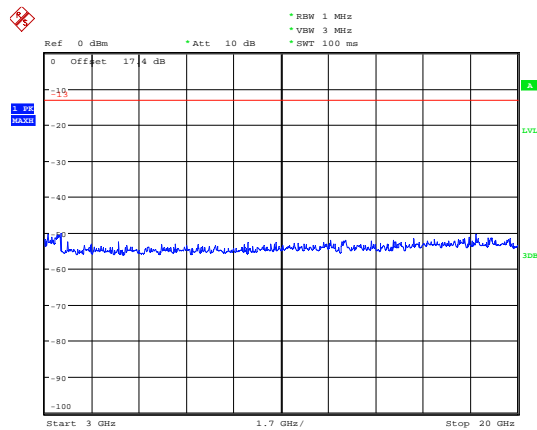

Date: 24.DEC.2018 12:04:36



### LTE Band 25 5MHz CH-Low 30MHz~1GHz

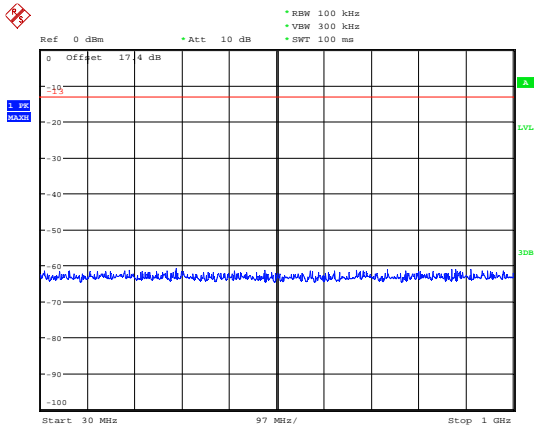

Date: 24.DEC.2018 11:37:04

### LTE Band 25 5MHz CH-Middle 30MHz~1GHz

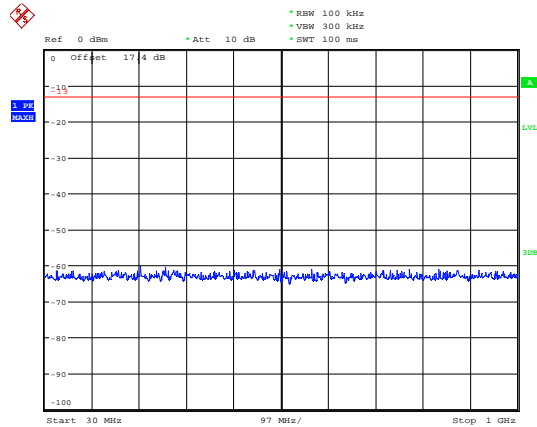

Date: 24.DEC.2018 11:34:44

### LTE Band 25 5MHz CH-Low 1GHz~3GHz

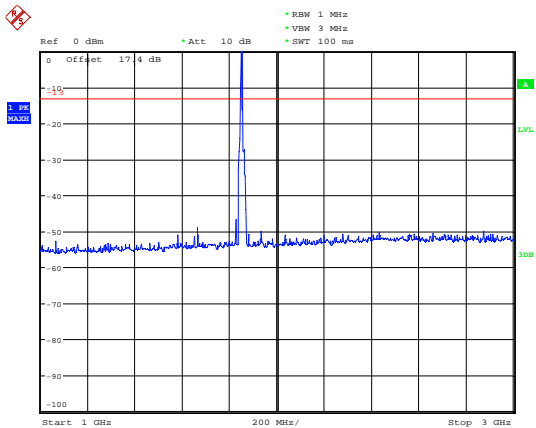

Date: 24.DEC.2018 19:26:17

### LTE Band 25 5MHz CH-Middle 1GHz~3GHz

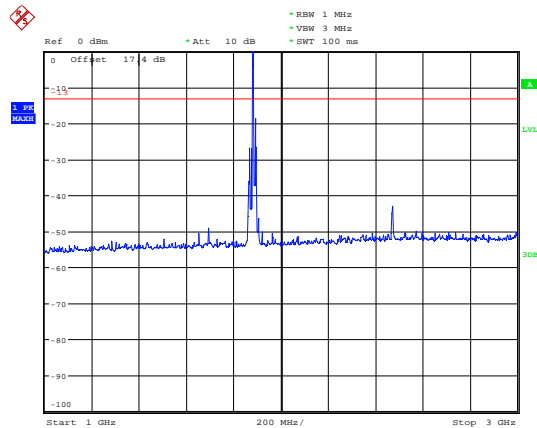

Date: 24.DEC.2018 19:26:55

### LTE Band 25 5MHz CH-Low 3GHz~20GHz

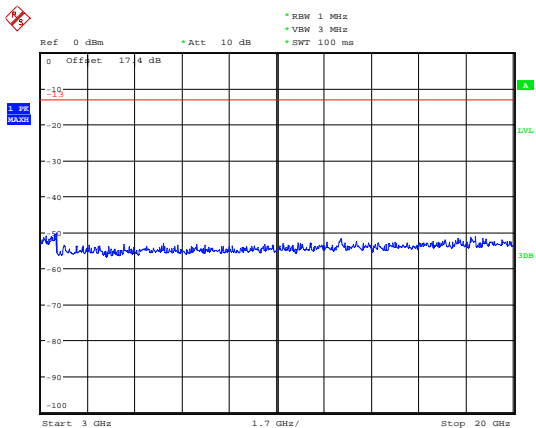

Date: 24.DEC.2018 12:08:44

### LTE Band 25 5MHz CH-Middle 3GHz~20GHz

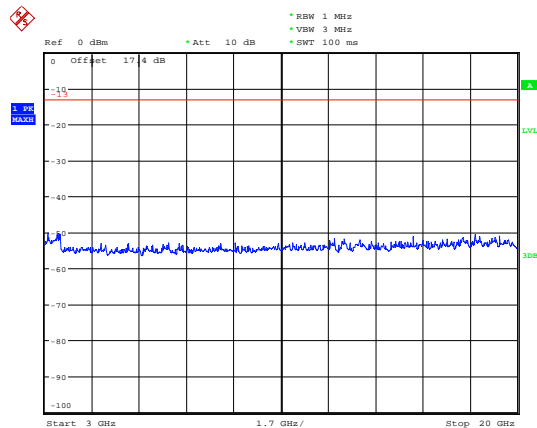

Date: 24.DEC.2018 12:09:26



### LTE Band 25 5MHz CH-High 30MHz~1GHz

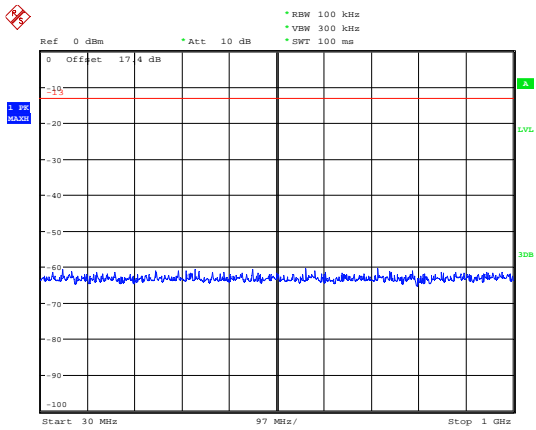

Date: 24.DEC.2018 11:37:43

### LTE Band 25 10MHz CH-Low 30MHz~1GHz

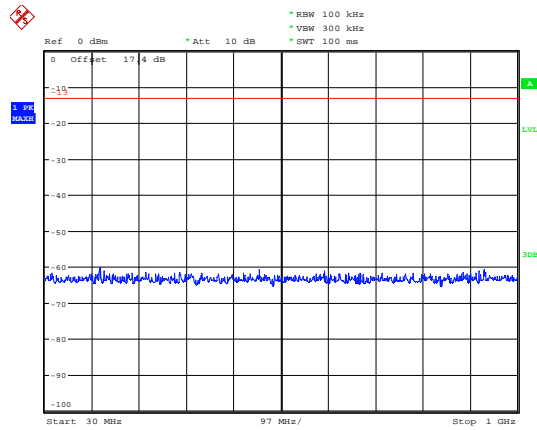

Date: 24.DEC.2018 11:39:25

### LTE Band 25 5MHz CH-High 1GHz~3GHz

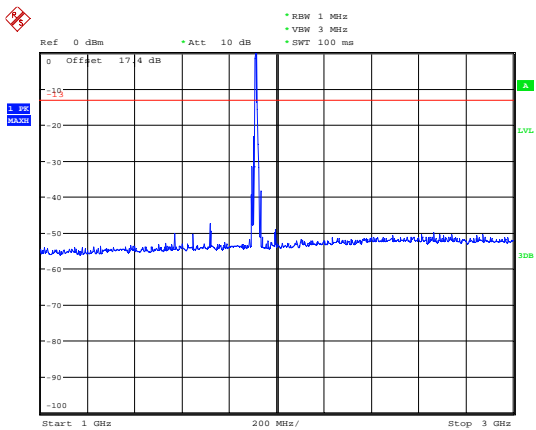

Date: 24.DEC.2018 19:27:26

### LTE Band 25 10MHz CH-Low 1GHz~3GHz

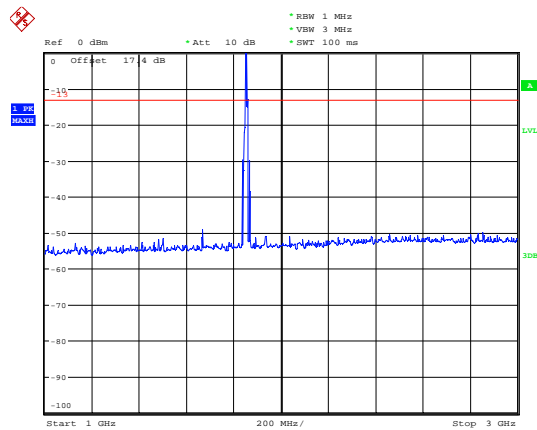

Date: 24.DEC.2018 19:28:08

### LTE Band 25 5MHz CH-High 3GHz~20GHz

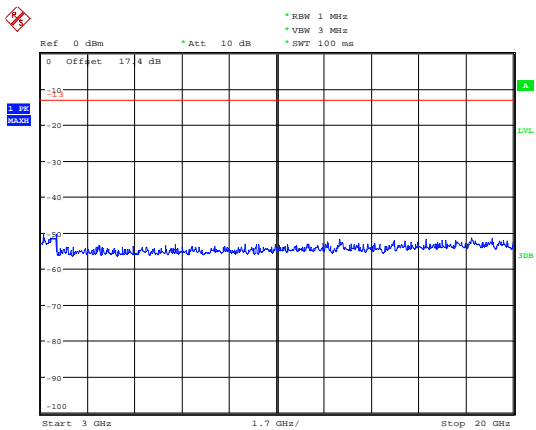

Date: 24.DEC.2018 12:10:45

### LTE Band 25 10MHz CH-Low 3GHz~20GHz

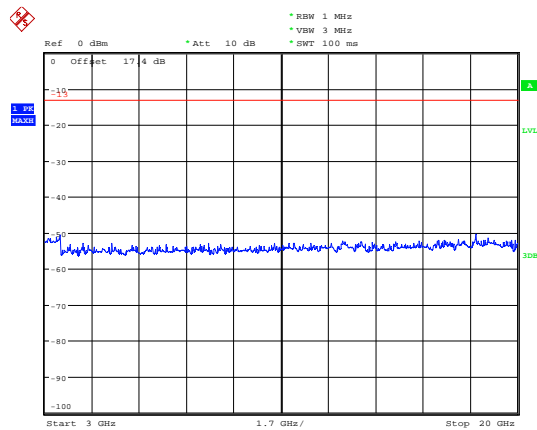

Date: 24.DEC.2018 12:12:14



### LTE Band 25 10MHz CH-Middle 30MHz~1GHz

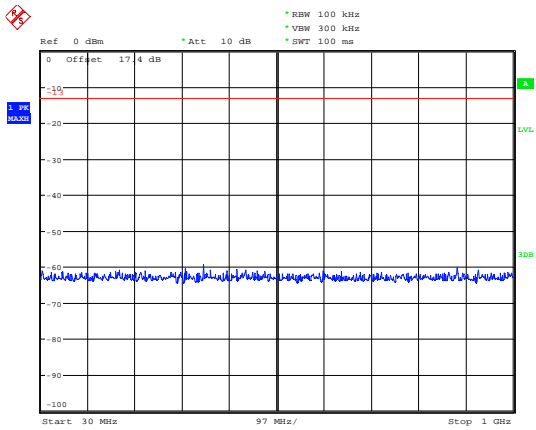

Date: 24.DEC.2018 11:38:48

### LTE Band 25 10MHz CH-High 30MHz~1GHz

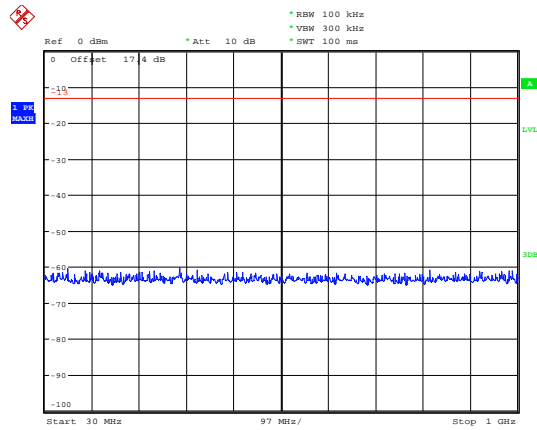

Date: 24.DEC.2018 11:40:00

### LTE Band 25 10MHz CH-Middle 1GHz~3GHz

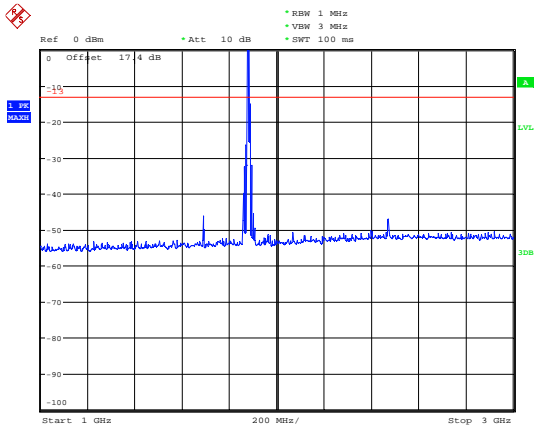

Date: 24.DEC.2018 19:28:34

### LTE Band 25 10MHz CH-High 1GHz~3GHz

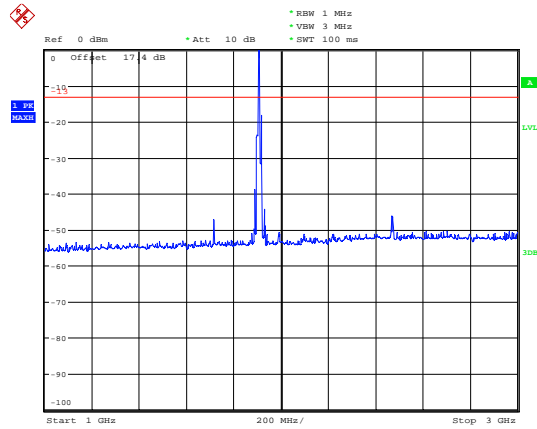

Date: 24.DEC.2018 19:29:25

### LTE Band 25 10MHz CH-Middle 3GHz~20GHz

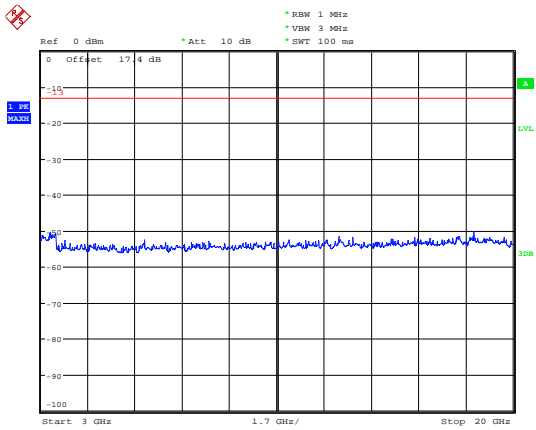

Date: 24.DEC.2018 12:13:48

### LTE Band 25 10MHz CH-High 3GHz~20GHz

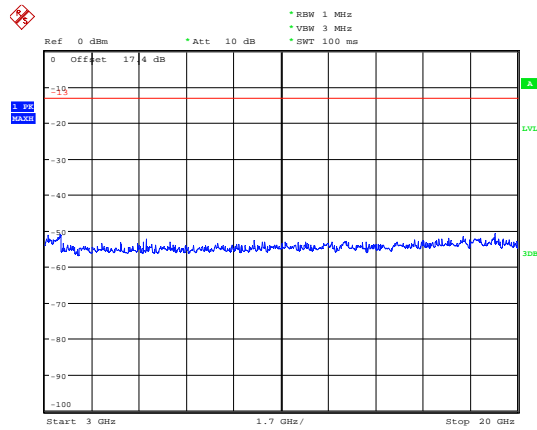

Date: 24.DEC.2018 12:14:16



### LTE Band 25 15MHz CH-Low 30MHz~1GHz

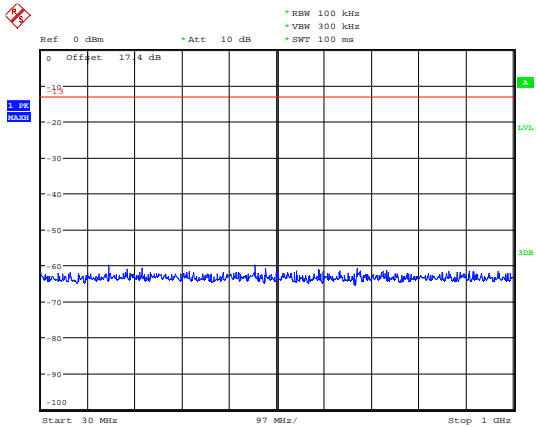

Date: 24.DEC.2018 11:41:19

### LTE Band 25 15MHz CH-Middle 30MHz~1GHz

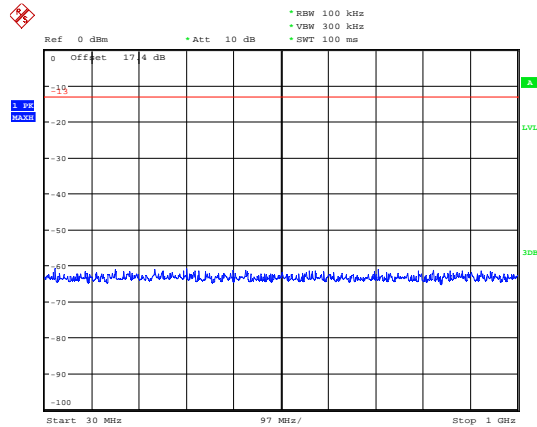

Date: 24.DEC.2018 11:40:57

### LTE Band 25 15MHz CH-Low 1GHz~3GHz

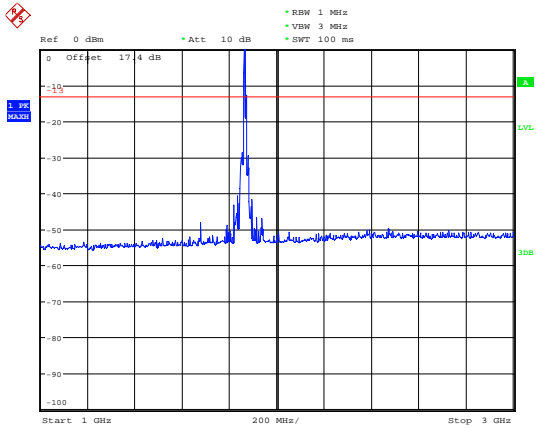

Date: 24.DEC.2018 12:38:36

### LTE Band 25 15MHz CH-Middle 1GHz~3GHz

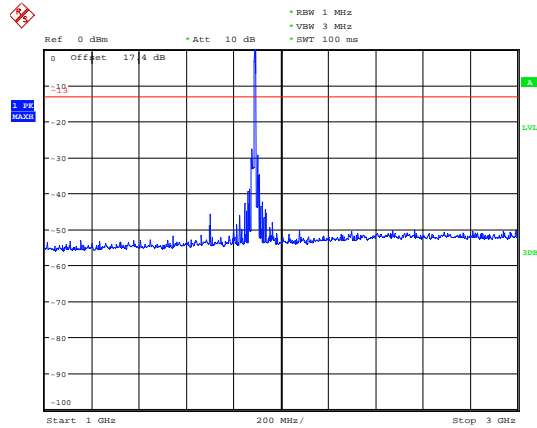

Date: 24.DEC.2018 12:17:41

### LTE Band 25 15MHz CH-Low 3GHz~20GHz

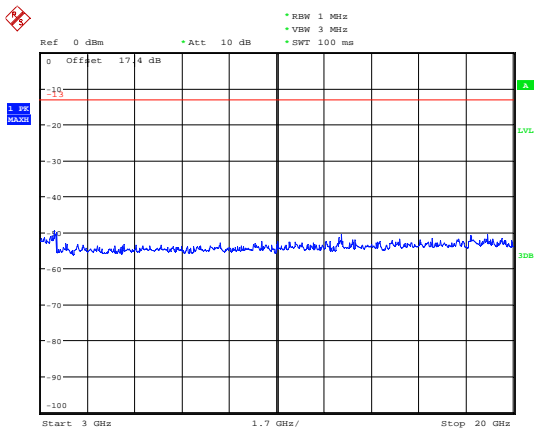

Date: 24.DEC.2018 12:15:06

### LTE Band 25 15MHz CH-Middle 3GHz~20GHz

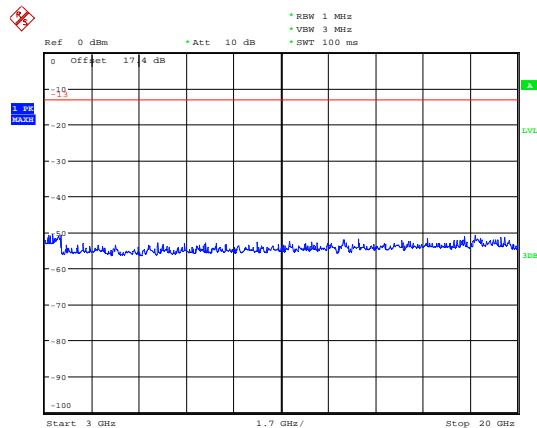

Date: 24.DEC.2018 12:15:36



### LTE Band 25 15MHz CH-High 30MHz~1GHz

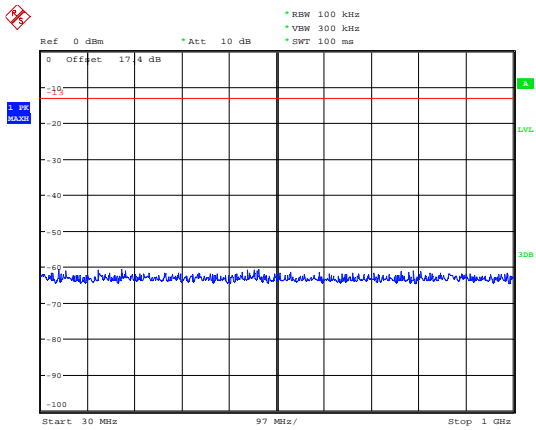

Date: 24.DEC.2018 11:41:38

### LTE Band 25 20MHz CH-Low 30MHz~1GHz

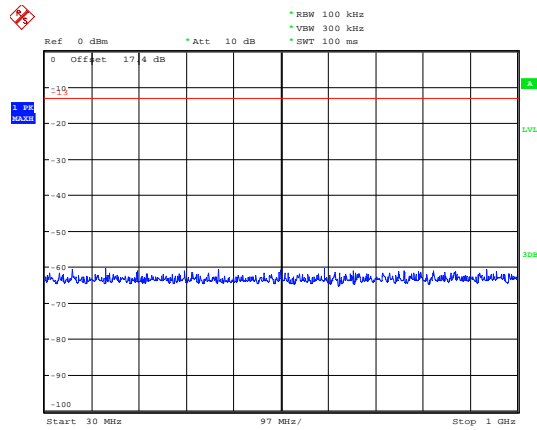

Date: 24.DEC.2018 11:42:00

### LTE Band 25 15MHz CH-High 1GHz~3GHz

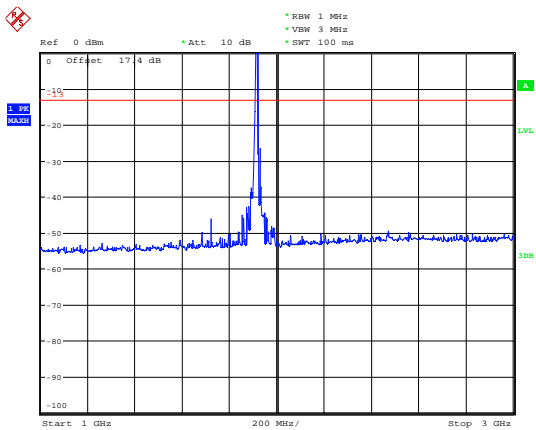

Date: 24.DEC.2018 12:17:11

### LTE Band 25 20MHz CH-Low 1GHz~3GHz

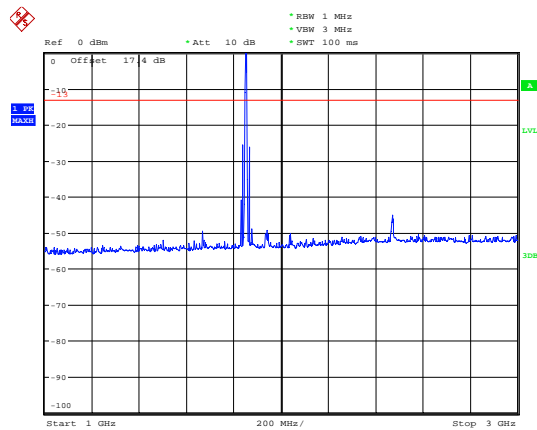

Date: 24.DEC.2018 19:30:00

### LTE Band 25 15MHz CH-High 3GHz~20GHz

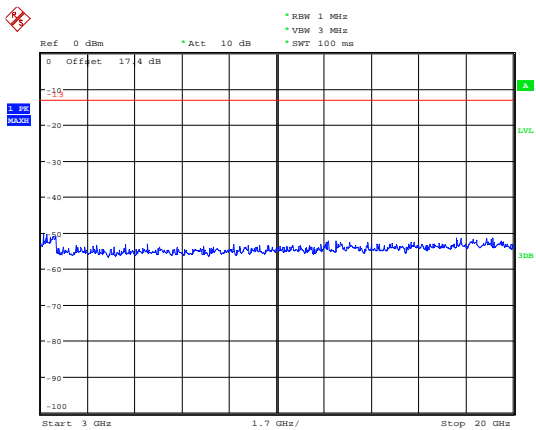

Date: 24.DEC.2018 12:16:17

### LTE Band 25 20MHz CH-Low 3GHz~20GHz

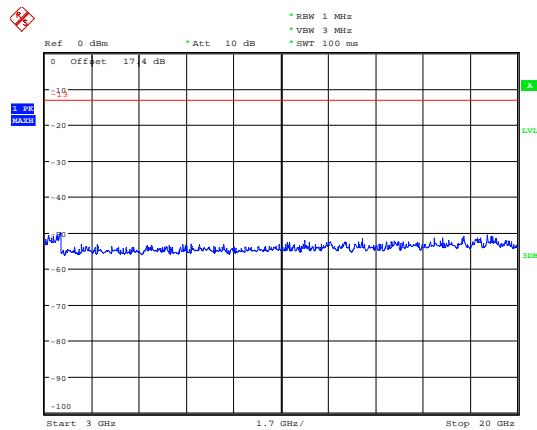

Date: 24.DEC.2018 12:00:35





### LTE Band 25 20MHz CH-Middle 30MHz~1GHz

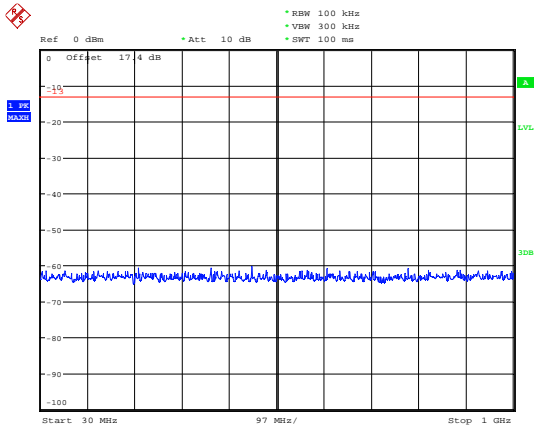

Date: 24.DEC.2018 11:42:26

### LTE Band 25 20MHz CH-High 30MHz~1GHz

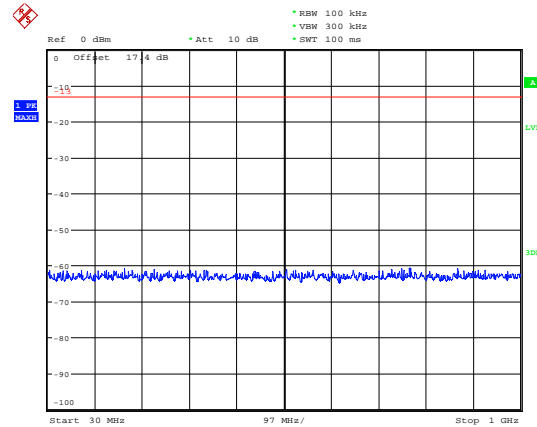

Date: 24.DEC.2018 11:43:29

### LTE Band 25 20MHz CH-Middle 1GHz~3GHz

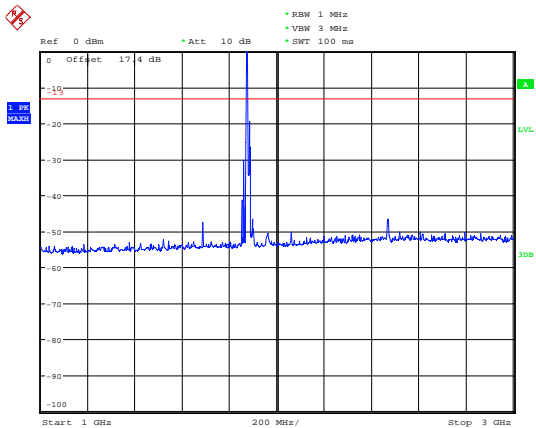

Date: 24.DEC.2018 19:30:45

### LTE Band 25 20MHz CH-High 1GHz~3GHz

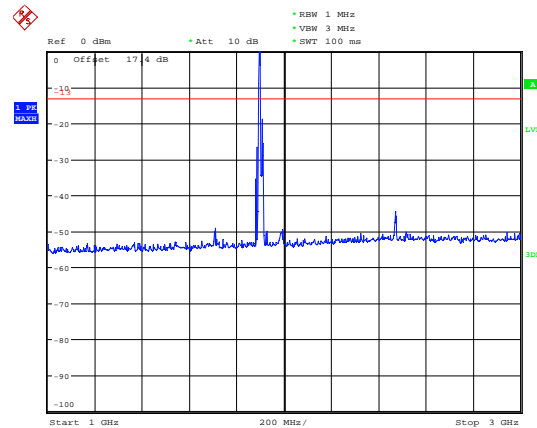

Date: 24.DEC.2018 19:31:17

### LTE Band 25 20MHz CH-Middle 3GHz~20GHz

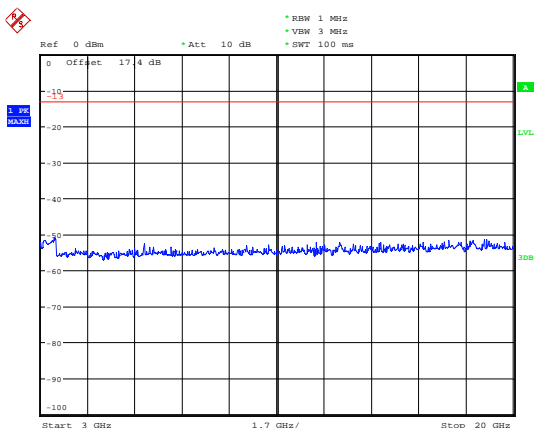

Date: 24.DEC.2018 12:00:01

### LTE Band 25 20MHz CH-High 3GHz~20GHz

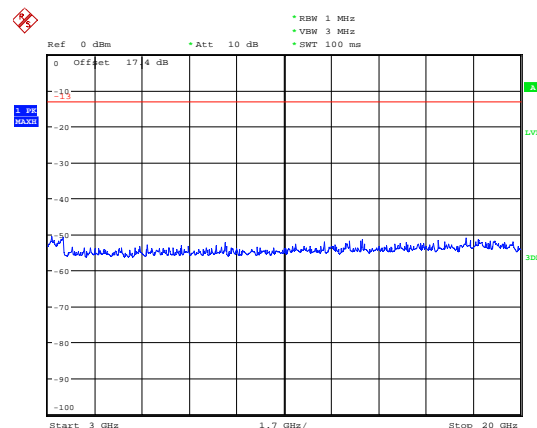

Date: 24.DEC.2018 11:48:24

## 5.8. Radiates Spurious Emission

### Ambient condition

Temperature	Relative humidity	Pressure
23°C ~25°C	45%~50%	101.5kPa

### Method of Measurement

- The testing follows FCC KDB 971168 v03r01 Section 5.8 and ANSI C63.26 (2015).
- Below 1GHz: The EUT is placed on a turntable 0.8 meters above the ground in the chamber, 3 meter away from the antenna. The maximal emission value is acquired by adjusting the antenna height, polarisation and turntable azimuth. Normally, the height range of antenna is 1 m to 4 m, the azimuth range of turntable is 0° to 360°, and the receive antenna has two polarizations Vertical (V) and Horizontal (H). Above 1GHz: (Note: the FCC's permission to use 1.5m as an alternative per TCBC Conf call of Dec. 2, 2014.) The EUT is placed on a turntable 1.5 meters above the ground in the chamber, 3 meter away from the antenna. The maximal emission value is acquired by adjusting the antenna height, polarisation and turntable azimuth. Normally, the height range of antenna is 1 m to 4 m, the azimuth range of turntable is 0° to 360°, and the receive antenna has two polarizations Vertical (V) and Horizontal (H).
- A loop antenna, A log-periodic antenna or horn antenna shall be substituted in place of the EUT. The log-periodic antenna will be driven by a signal generator and the level will be adjusted till the same power value on the spectrum analyzer or receiver. The level of the spurious emissions can be calculated through the level of the signal generator, cable loss, the gain of the substitution antenna and the reading of the spectrum analyzer or receiver.
- The EUT is then put into continuously transmitting mode at its maximum power level during the test. Set Test Receiver or Spectrum RBW=200Hz,VBW=600Hz for 9kHz150kHz , RBW=10kHz, VBW=30kHz 150kHz-30MHz , RBW=100kHz,VBW=300kHz for 30MHz to 1GHz and RBW=1MHz, VBW=3MHz for above 1GHz, And the maximum value of the receiver should be recorded as (Pr).
- The EUT shall be replaced by a substitution antenna. In the chamber, an substitution antenna for the frequency band of interest is placed at the reference point of the chamber. An RF Signal source for the frequency band of interest is connected to the substitution antenna with a cable that has been constructed to not interfere with the radiation pattern of the antenna. A power (PMea) is applied to the input of the substitution antenna, and adjust the level of the signal generator output until the value of the receiver reach the previously recorded (Pr). The power of signal source (PMea) is recorded. The test should be performed by rotating the test item and adjusting the receiving antenna polarization.
- A amplifier should be connected to the Signal Source output port. And the cable should be connect between the Amplifier and the Substitution Antenna. The cable loss (Pcl) ,the Substitution Antenna Gain (Ga) and the Amplifier Gain (PAg) should be recorded after test.
- The measurement results are obtained as described below:  
 $Power(EIRP)=PMea- PAg - Pcl + Ga$   
 The measurement results are amend as described below:  
 $Power(EIRP)=PMea- Pcl + Ga$
- This value is EIRP since the measurement is calibrated using an antenna of known gain (2.15 dBi)

and known input power. ERP can be calculated from EIRP by subtracting the gain of the dipole,  $ERP = EIRP - 2.15\text{dBi}$ .

The modulation mode and RB allocation refer to section 5.1, using the maximum output power configuration.

**Test setup**

**9KHz ~ 30MHz**

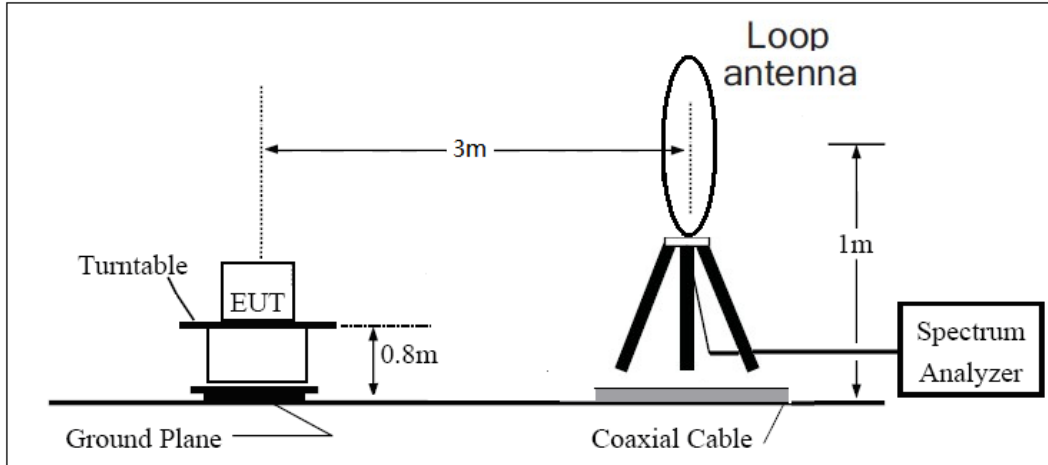

**30MHz ~ 1GHz**

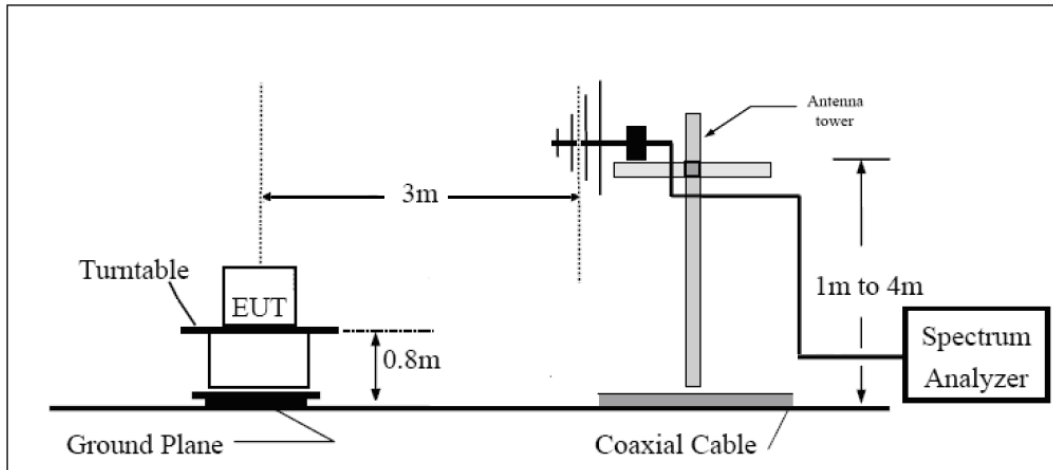

**Above 1GHz**

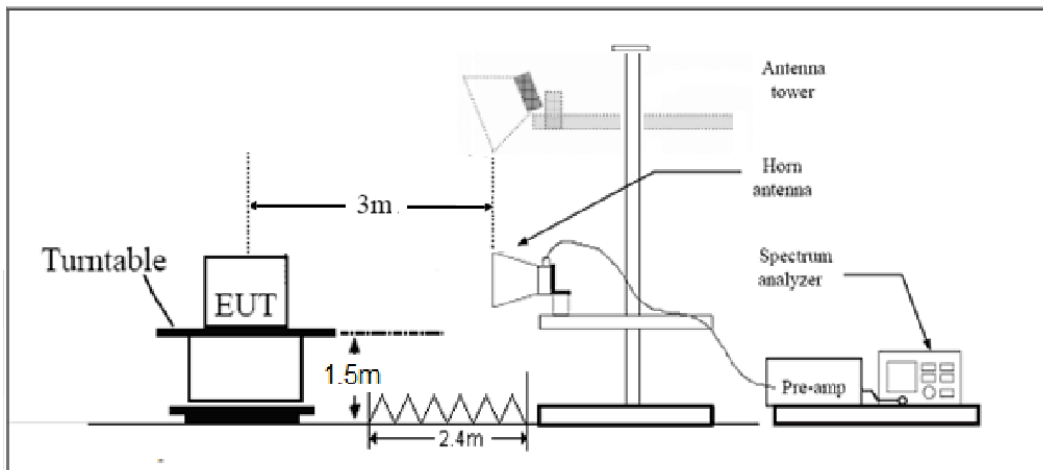



Note: Area side: 2.4mX3.6m

**Limits**

Rule Part 24.238(a) specifies that “on any frequency outside a licensee's frequency block, the power of any emission shall be attenuated below the transmitter power (P) by at least  $43 + 10 \log_{10} (P)$  dB.”

Limit	-13 dBm
-------	---------

**Measurement Uncertainty**

The assessed measurement uncertainty to ensure 95% confidence level for the normal distribution is with the coverage factor  $k = 1.96$ ,  $U = 3.55$  dB.

**Test Result**

Sweep the whole frequency band through the range from 9kHz to the 10th harmonic of the carrier, the emissions below the noise floor will not be recorded in the report.

## LTE Band 2 10MHz CH-Low

Harmonic	Frequency (MHz)	SG (dBm)	Cable Loss (dB)	Gain (dBi)	Antenna Polarization	EIRP Level (dBm)	Limit (dBm)	Margin (dB)	Azimuth (deg)
2	3702.0	-58.61	5.10	11.05	Vertical	-52.66	-13.00	39.66	45
3	5553.4	-58.52	5.42	12.65	Vertical	-51.29	-13.00	38.29	135
4	7440.0	-55.12	6.70	13.85	Vertical	-47.97	-13.00	34.97	90
5	9300.0	-54.91	7.01	14.75	Vertical	-47.17	-13.00	34.17	225
6	11160.0	-53.92	7.48	15.95	Vertical	-45.45	-13.00	32.45	225
7	13020.0	-52.93	7.51	16.55	Vertical	-43.89	-13.00	30.89	315
8	14880.0	-50.73	8.24	15.35	Vertical	-43.62	-13.00	30.62	0
9	16740.0	-51.33	8.41	14.95	Vertical	-44.79	-13.00	31.79	45
10	18600.0	/	/	/	/	/	/	/	\

Note: 1.The other Spurious RF Radiated emissions level is no more than noise floor.  
2. The worst emission was found in the antenna is Vertical position.

## LTE Band 2 10MHz CH-Middle

Harmonic	Frequency (MHz)	SG (dBm)	Cable Loss (dB)	Gain (dBi)	Antenna Polarization	EIRP Level (dBm)	Limit (dBm)	Margin (dB)	Azimuth (deg)
2	3742.1	-56.51	5.10	11.05	Vertical	-50.56	-13.00	37.56	90
3	5613.4	-59.54	5.42	12.65	Vertical	-52.31	-13.00	39.31	45
4	7484.6	-55.75	6.70	13.85	Vertical	-48.60	-13.00	35.60	180
5	9400.0	-54.75	7.01	14.75	Vertical	-47.01	-13.00	34.01	315
6	11280.0	-52.97	7.48	15.95	Vertical	-44.50	-13.00	31.50	270
7	13160.0	-52.59	7.51	16.55	Vertical	-43.55	-13.00	30.55	135
8	15040.0	-53.14	8.24	15.35	Vertical	-46.03	-13.00	33.03	225
9	16920.0	-50.39	8.41	14.95	Vertical	-43.85	-13.00	30.85	45
10	18800.0	/	/	/	/	/	/	/	\

Note: 1.The other Spurious RF Radiated emissions level is no more than noise floor.  
2. The worst emission was found in the antenna is Vertical position.



## LTE Band 2 10MHz CH-High

Harmonic	Frequency (MHz)	SG (dBm)	Cable Loss (dB)	Gain (dBi)	Antenna Polarization	EIRP Level (dBm)	Limit (dBm)	Margin (dB)	Azimuth (deg)
2	3781.9	-58.42	5.10	11.05	Vertical	-52.47	-13.00	39.47	90
3	5673.8	-57.49	5.42	12.65	Vertical	-50.26	-13.00	37.26	225
4	7564.1	-56.77	6.70	13.85	Vertical	-49.62	-13.00	36.62	225
5	9500.0	-55.75	7.01	14.75	Vertical	-48.01	-13.00	35.01	315
6	11400.0	-51.98	7.48	15.95	Vertical	-43.51	-13.00	30.51	0
7	13300.0	-52.78	7.51	16.55	Vertical	-43.74	-13.00	30.74	45
8	15200.0	-53.62	8.24	15.35	Vertical	-46.51	-13.00	33.51	315
9	17100.0	-49.94	8.41	14.95	Vertical	-43.40	-13.00	30.40	90
10	19000.0	/	/	/	/	/	/	/	\

Note: 1.The other Spurious RF Radiated emissions level is no more than noise floor.  
2. The worst emission was found in the antenna is Vertical position.

## LTE Band 25 10MHz CH-Low

Harmonic	Frequency (MHz)	SG (dBm)	Cable Loss (dB)	Gain (dBi)	Antenna Polarization	EIRP Level (dBm)	Limit (dBm)	Margin (dB)	Azimuth (deg)
2	3720.0	-59.47	5.10	11.05	Vertical	-53.52	-13.00	40.52	225
3	5580.0	-57.49	5.42	12.65	Vertical	-50.26	-13.00	37.26	225
4	7440.0	-56.22	6.70	13.85	Vertical	-49.07	-13.00	36.07	315
5	9300.0	-55.85	7.01	14.75	Vertical	-48.11	-13.00	35.11	315
6	11160.0	-54.79	7.48	15.95	Vertical	-46.32	-13.00	33.32	0
7	13020.0	-53.97	7.51	16.55	Vertical	-44.93	-13.00	31.93	225
8	14880.0	-51.93	8.24	15.35	Vertical	-44.82	-13.00	31.82	315
9	16740.0	-51.36	8.41	14.95	Vertical	-44.82	-13.00	31.82	315
10	18600.0	/	/	/	/	/	/	/	/

Note: 1.The other Spurious RF Radiated emissions level is no more than noise floor.  
2. The worst emission was found in the antenna is Vertical position.



## LTE Band 25 10MHz CH-Middle

Harmonic	Frequency (MHz)	SG (dBm)	Cable Loss (dB)	Gain (dBi)	Antenna Polarization	EIRP Level (dBm)	Limit (dBm)	Margin (dB)	Azimuth (deg)
2	3765.0	-58.59	5.10	11.05	Vertical	-52.64	-13.00	39.64	45
3	5647.5	-56.58	5.42	12.65	Vertical	-49.35	-13.00	36.35	315
4	7530.0	-57.04	6.70	13.85	Vertical	-49.89	-13.00	36.89	90
5	9412.5	-55.54	7.01	14.75	Vertical	-47.80	-13.00	34.80	225
6	11295.0	-53.58	7.48	15.95	Vertical	-45.11	-13.00	32.11	315
7	13177.5	-55.11	7.51	16.55	Vertical	-46.07	-13.00	33.07	315
8	15060.0	-52.93	8.24	15.35	Vertical	-45.82	-13.00	32.82	0
9	16942.5	-50.98	8.41	14.95	Vertical	-44.44	-13.00	31.44	45
10	18825.0	/	/	/	/	/	/	/	/

Note: 1.The other Spurious RF Radiated emissions level is no more than noise floor.

2. The worst emission was found in the antenna is Vertical position.

## LTE Band 25 10MHz CH-High

Harmonic	Frequency (MHz)	SG (dBm)	Cable Loss (dB)	Gain (dBi)	Antenna Polarization	EIRP Level (dBm)	Limit (dBm)	Margin (dB)	Azimuth (deg)
2	3810.0	-55.59	5.10	11.05	Vertical	-49.64	-13.00	36.64	90
3	5715.0	-59.10	5.42	12.65	Vertical	-51.87	-13.00	38.87	315
4	7620.0	-56.45	6.70	13.85	Vertical	-49.30	-13.00	36.30	0
5	9525.0	-56.50	7.01	14.75	Vertical	-48.76	-13.00	35.76	45
6	11430.0	-53.89	7.48	15.95	Vertical	-45.42	-13.00	32.42	315
7	13335.0	-53.74	7.51	16.55	Vertical	-44.70	-13.00	31.70	90
8	15240.0	-54.40	8.24	15.35	Vertical	-47.29	-13.00	34.29	225
9	17145.0	-50.00	8.41	14.95	Vertical	-43.46	-13.00	30.46	45
10	19050.0	/	/	/	/	/	/	/	/

Note: 1.The other Spurious RF Radiated emissions level is no more than noise floor.

2. The worst emission was found in the antenna is Vertical position.



## 6. Main Test Instruments

Name	Manufacturer	Type	Serial Number	Calibration Date	Expiration Date
Base Station Simulator	R&S	CMU200	118133	2018-05-13	2019-05-12
Base Station Simulator	R&S	CMW500	113824	2018-05-20	2019-05-19
Power Splitter	Hua Xiang	SHX-GF2-2-13	10120101	/	/
Spectrum Analyzer	Key sight	N9010A	MY50210259	2018-05-20	2019-05-19
Universal Radio Communication Tester	Key sight	E5515C	MY48367192	2018-05-20	2019-05-19
Signal Analyzer	R&S	FSV30	100815	2018-12-16	2019-12-15
EMI Test Receiver	R&S	ESCI	100948	2018-05-20	2019-05-19
Loop Antenna	SCHWARZBECK	FMZB1519	1519-047	2017-09-26	2019-09-25
Trilog Antenna	SCHWARZBECK	VUBL 9163	9163-201	2017-11-18	2019-11-17
Horn Antenna	R&S	HF907	100126	2018-07-07	2020-07-06
Horn Antenna	ETS-Lindgren	3160-09	00102643	2018-06-20	2020-06-19
Signal generator	R&S	SMB 100A	102594	2018-05-20	2019-05-19
Climatic Chamber	ESPEC	SU-242	93000506	2017-12-17	2020-12-16
Preampflifier	R&S	SCU18	102327	2018-05-20	2019-05-19
MOB COMMS DC SUPPLY	Keysight	66319D	MY43004105	2018-05-07	2019-05-06
RF Cable	Agilent	SMA 15cm	0001	/	/
Software	R&S	EMC32	9.26.0	/	/

\*\*\*\*\*END OF REPORT \*\*\*\*\*



## ANNEX A: EUT Appearance and Test Setup

### A.1 EUT Appearance



Front Side

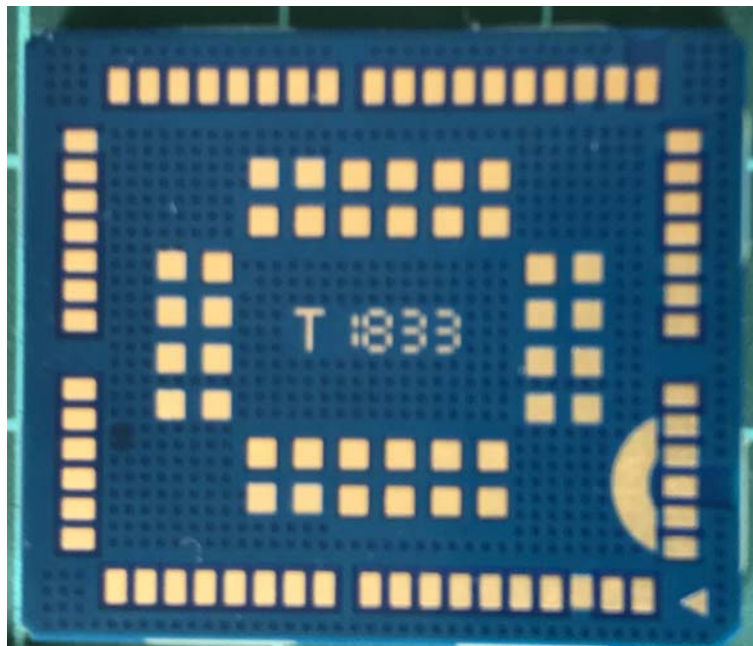

Back Side

Picture 1 EUT

## A.2 Test Setup

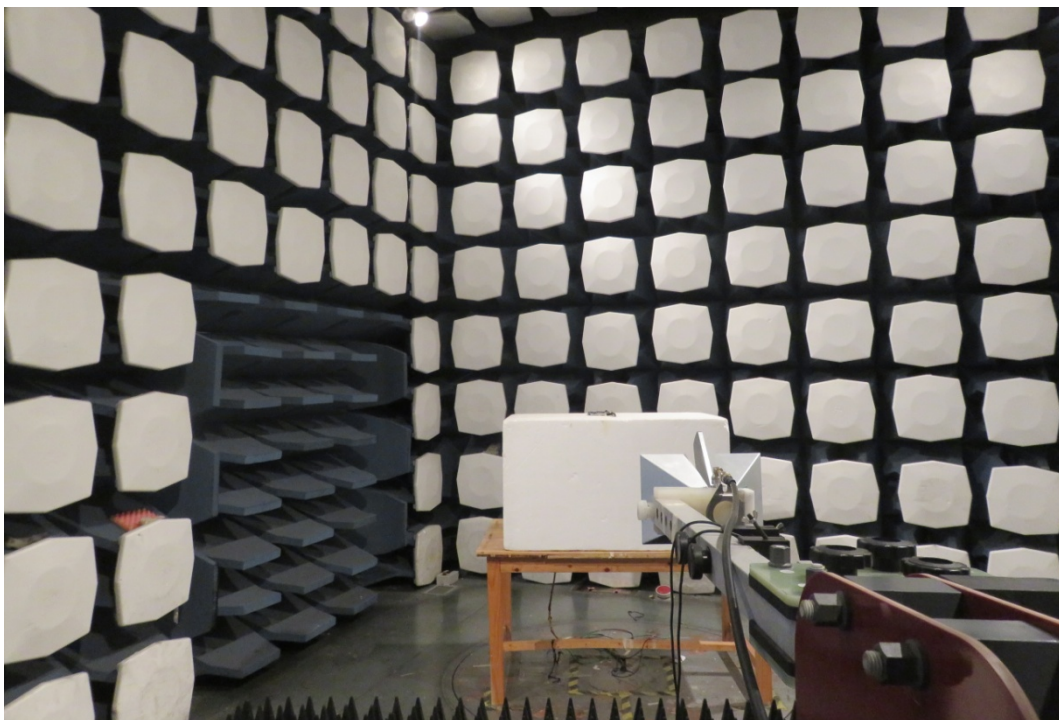

Picture 2 Radiated Spurious Emissions Test setup