



# RF TEST REPORT

**Applicant**      Quectel Wireless Solutions Co., Ltd  
**FCC ID**            XMR201808EC25AF  
**Product**          LTE Module  
**Brand**             Quectel  
**Model**             EC25-AF; EC25-AF MINIPCIE  
**Report No.**      R1806A0301-R2V1  
**Issue Date**      July 31, 2018

TA Technology (Shanghai) Co., Ltd. tested the above equipment in accordance with the requirements in **FCC CFR47 Part 2 (2017)/ FCC CFR 47 Part 24E (2017)**. The test results show that the equipment tested is capable of demonstrating compliance with the requirements as documented in this report.

*Jiang peng Lan*

*Performed by: Jiangpeng Lan*

*Kai Xu*

*Approved by: Kai Xu*

---

## TA Technology (Shanghai) Co., Ltd.

*No.145, Jintang Rd, Tangzhen Industry Park, Pudong Shanghai, China*

*TEL: +86-021-50791141/2/3*

*FAX: +86-021-50791141/2/3-8000*



# TABLE OF CONTENT

- 1. Test Laboratory ..... 4
  - 1.1. Notes of the test report..... 4
  - 1.2. Test facility ..... 4
  - 1.3. Testing Location ..... 5
- 2. General Description of Equipment under Test..... 6
- 3. Applied Standards ..... 8
- 4. Test Configuration ..... 9
- 5. Test Case Results ..... 11
  - 5.1. RF Power Output ..... 11
  - 5.2. Effective Isotropic Radiated Power ..... 16
  - 5.3. Occupied Bandwidth ..... 20
  - 5.4. Band Edge Compliance..... 30
  - 5.5. Peak-to-Average Power Ratio (PAPR)..... 40
  - 5.6. Frequency Stability..... 43
  - 5.7. Spurious Emissions at Antenna Terminals..... 47
  - 5.8. Radiates Spurious Emission ..... 59
- 6. Main Test Instruments ..... 72
- ANNEX A: EUT Appearance and Test Setup ..... 73
  - A.1 EUT Appearance..... 73
  - A.2 Test Setup..... 77

## Summary of measurement results

No.	Test Case	Clause in FCC rules	Verdict
1	RF power output	2.1046	PASS
2	Effective Isotropic Radiated power	24.232(c)	PASS
3	Occupied Bandwidth	2.1049	PASS
4	Band Edge Compliance	2.1051 /24.238(a)	PASS
5	Peak-to-Average Power Ratio	24.232/KDB 971168 D01(5.7)	PASS
6	Frequency Stability	2.1055 / 24.235	PASS
7	Spurious Emissions at Antenna Terminals	2.1051 / 24.238(a)	PASS
8	Radiates Spurious Emission	2.1053 / 24.238(a)	PASS
Date of Testing: June 29, 2018~ July 16, 2018 and July 30, 2018~ July 31, 2018			
Note: PASS: The EUT complies with the essential requirements in the standard. FAIL: The EUT does not comply with the essential requirements in the standard.			



## 1. Test Laboratory

### 1.1. Notes of the test report

This report shall not be reproduced in full or partial, without the written approval of **TA technology (shanghai) co., Ltd.** The results documented in this report apply only to the tested sample, under the conditions and modes of operation as described herein. Measurement Uncertainties were not taken into account and are published for informational purposes only. This report is written to support regulatory compliance of the applicable standards stated above.

### 1.2. Test facility

#### **CNAS (accreditation number: L2264)**

TA Technology (Shanghai) Co., Ltd. has obtained the accreditation of China National Accreditation Service for Conformity Assessment (CNAS).

#### **FCC (Designation number: CN1179, Test Firm Registration Number: 446626)**

TA Technology (Shanghai) Co., Ltd. has been listed on the US Federal Communications Commission list of test facilities recognized to perform electromagnetic emissions measurements.

#### **IC (recognition number is 8510A)**

TA Technology (Shanghai) Co., Ltd. has been listed by industry Canada to perform electromagnetic emission measurement.

#### **VCCI (recognition number is C-4595, T-2154, R-4113, G-10766)**

TA Technology (Shanghai) Co., Ltd. has been listed by industry Japan to perform electromagnetic emission measurement.

#### **A2LA (Certificate Number: 3857.01)**

TA Technology (Shanghai) Co., Ltd. has been listed by American Association for Laboratory Accreditation to perform electromagnetic emission measurement.



### 1.3. Testing Location

Company: TA Technology (Shanghai) Co., Ltd.  
Address: No.145, Jintang Rd, Tangzhen Industry Park, Pudong  
City: Shanghai  
Post code: 201201  
Country: P. R. China  
Contact: Xu Kai  
Telephone: +86-021-50791141/2/3  
Fax: +86-021-50791141/2/3-8000  
Website: <http://www.ta-shanghai.com>  
E-mail: [xukai@ta-shanghai.com](mailto:xukai@ta-shanghai.com)

## 2. General Description of Equipment under Test

### Client Information

Applicant	Quectel Wireless Solutions Co., Ltd
Applicant address	7th Floor, Hongye Building, No.1801 Hongmei Road, Xuhui District, Shanghai 200233, China
Manufacturer	Quectel Wireless Solutions Co., Ltd
Manufacturer address	7th Floor, Hongye Building, No.1801 Hongmei Road, Xuhui District, Shanghai 200233, China

### General information

EUT Description			
Model	EC25-AF; EC25-AF MINIPCIE		
IMEI	EC25-AF :866834040000767 EC25-AF MINIPCIE: 866834040002375		
Hardware Version	R1.0		
Software Version	EC25AFFAR07A02M4G		
Power Supply	External Power Supply		
Antenna Type	The EUT don't have standard Antenna, The Antenna used for testing in this report is the after-market accessory (Dipole Antenna)		
Antenna Gain	4dBi		
Test Mode(s)	WCDMA Band II; LTE Band 2;		
Test Modulation	(WCDMA)QPSK; (LTE)QPSK,16QAM		
HSDPA UE Category	24		
HSUPA UE Category	6		
LTE Category	4		
Maximum E.I.R.P	WCDMA Band II:	25.49dBm	
	LTE Band 2:	25.75dBm	
Rated Power Supply Voltage	3.8V		
Extreme Voltage	Minimum: 3.3V Maximum: 4.3V		
Extreme Temperature	Lowest: -40°C Highest: +85°C		
Operating Frequency Range(s)	Band	Tx (MHz)	Rx (MHz)
	WCDMA Band II	1850 ~ 1910	1930 ~ 1990
	LTE Band 2	1850 ~ 1910	1930 ~ 1990
Note: The information of the EUT is declared by the manufacturer.			

Accessory equipment	
Evaluation Board	RF Cable
RS232-to-USB Cable	Antenna: Dipole Antenna
Headset	DC 5V Adaptor



EC25-AF and EC25-AF MINIPCIE are all LTE modules. They support the same frequency bands, use the same chipset and share the same software & hardware design. The main difference is on the carrier board.

EC25-AF MINIPCIE makes up of EC25-AF module and PCIe transferred board.

The transferred board switches EC25-AF module to follow PCI Express Mini Card 1.2 standard connector protocol. No any other internal changes in EC25-AF module.

Two models are identical in interior structure and components, and just connector interface is different for the marketing requirement.



### **3. Applied Standards**

According to the specifications of the manufacturer, it must comply with the requirements of the following standards:

**FCC CFR47 Part 2 (2017)**

**FCC CFR 47 Part 24E (2017)**

**ANSI/TIA-603-E (2016)**

**KDB 971168 D01 Power Meas License Digital Systems v03r01**



## 4. Test Configuration

Radiated measurements are performed by rotating the EUT in three different orthogonal test planes. EUT stand-up position (Z axis), lie-down position (X, Y axis). Receiver antenna polarization (horizontal and vertical), the worst emission was found in position (X axis, horizontal polarization) and the worst case was recorded.

All mode and data rates and positions and RB size and modulations were investigated.

Subsequently, only the worst case emissions are reported.

The following testing in WCDMA/LTE is set based on the maximum RF Output Power.

Test modes are chosen to be reported as the worst case configuration below:

Test items	Modes/Modulation
	WCDMA Band II
RF power output	RMC HSDPA/HSUPA DC-HSDPA
Effective Isotropic Radiated power	RMC
Occupied Bandwidth	RMC
Band Edge Compliance	RMC
Peak-to-Average Power Ratio	RMC
Frequency Stability	RMC
Spurious Emissions at Antenna Terminals	RMC
Radiates Spurious Emission	RMC



Test modes are chosen to be reported as the worst case configuration below for LTE Band 2:

Test items	Bandwidth (MHz)						Modulation		RB			Test Channel		
	1.4	3	5	10	15	20	QPSK	16QAM	1	50%	100%	L	M	H
RF power output	O	O	O	O	O	O	O	O	O	O	O	O	O	O
Effective Isotropic Radiated power	O	O	O	O	O	O	O	O	O	O	O	O	O	O
Occupied Bandwidth	O	O	O	O	O	O	O	O	-	-	O	O	O	O
Band Edge Compliance	O	O	O	O	O	O	O	O	O	-	O	O	-	O
Peak-to-Average Power Ratio	O	O	O	O	O	O	O	O	-	-	O	O	O	O
Frequency Stability	O	O	O	O	O	O	O	O	-	-	O	O	-	O
Conducted Spurious Emissions	O	O	O	O	O	O	O	-	O	O	O	O	O	O
Radiates Spurious Emission	O	-	O	-	-	O	O	-	O	-	-	O	O	O
Note	1. The mark "O" means that this configuration is chosen for testing. 2. The mark "-" means that this configuration is not testing.													

## 5. Test Case Results

### 5.1.RF Power Output

#### Ambient condition

Temperature	Relative humidity	Pressure
23°C ~25°C	45%~50%	101.5kPa

#### Methods of Measurement

During the process of the testing, The EUT is controlled by the Base Station Simulator to ensure max power transmission and proper modulation.

#### Test Setup

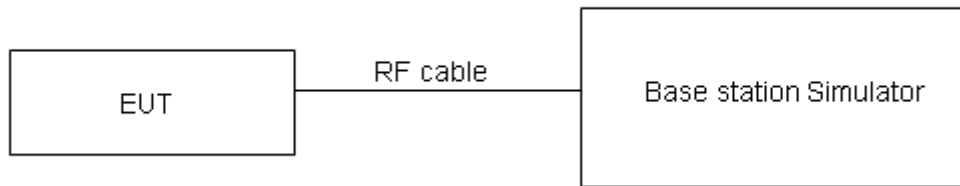

The loss between RF output port of the EUT and the input port of the tester has been taken into consideration.

#### Limits

No specific RF power output requirements in part 2.1046.

#### Measurement Uncertainty

The assessed measurement uncertainty to ensure 95% confidence level for the normal distribution is with the coverage factor  $k = 2$ ,  $U = 0.4$  dB.

**Test Results**

WCDMA Band II		Conducted Power(dBm)		
		Channel 9262	Channel 9400	Channel 9538
		1852.4(MHz)	1880(MHz)	1907.6(MHz)
<b>RMC</b>		23.19	23.05	23.04
<b>HSDPA</b>	Sub - Test 1	22.26	22.11	22.00
	Sub - Test 2	22.20	22.07	22.00
	Sub - Test 3	21.71	21.59	21.53
	Sub - Test 4	21.72	21.60	21.54
<b>HSUPA</b>	Sub - Test 1	22.26	22.15	22.05
	Sub - Test 2	21.67	21.62	21.61
	Sub - Test 3	22.21	22.08	22.02
	Sub - Test 4	22.31	22.18	22.13
	Sub - Test 5	22.20	22.07	22.02
<b>DC-HSDPA</b>	Sub - Test 1	23.12	22.94	22.93
	Sub - Test 2	23.11	22.93	22.92
	Sub - Test 3	22.60	22.42	22.41
	Sub - Test 4	22.59	22.51	22.39



LTE Band 2				Conducted Power(dBm)		
Bandwidth	Modulation	RB size	RB offset	Channel/Frequency (MHz)		
				18607/1850.7	18900/1880	19193/1909.3
1.4MHz	QPSK	1	0	23.37	23.41	22.99
		1	2	23.41	23.79	22.99
		1	5	23.33	23.26	22.91
		3	0	23.35	23.29	23.12
		3	2	23.18	23.09	23.21
		3	3	23.37	23.26	22.90
		6	0	22.23	22.49	22.07
	16QAM	1	0	22.36	22.91	22.68
		1	2	22.41	22.94	23.00
		1	5	22.20	22.95	23.02
		3	0	22.33	22.19	22.16
		3	2	22.42	22.16	22.07
		3	3	22.31	22.29	22.06
		6	0	21.36	21.29	21.30
Bandwidth	Modulation	RB size	RB offset	Channel/Frequency (MHz)		
				18615/1851.5	18900/1880	19185/1908.5
3MHz	QPSK	1	0	23.39	23.45	23.02
		1	7	23.44	23.84	23.03
		1	14	23.36	23.31	22.95
		8	0	22.45	22.41	22.25
		8	4	22.30	22.19	22.33
		8	7	22.47	22.37	22.00
		15	0	22.26	22.53	22.10
	16QAM	1	0	22.39	22.93	22.71
		1	7	22.44	22.99	23.04
		1	14	22.22	22.99	23.05
		8	0	21.44	21.32	21.28
		8	4	21.53	21.29	21.19
		8	7	21.41	21.41	21.19
		15	0	21.39	21.33	21.33
Bandwidth	Modulation	RB size	RB offset	Channel/Frequency (MHz)		
				18625/1852.5	18900/1880	19175/1907.5
5MHz	QPSK	1	0	23.36	23.43	22.98
		1	13	23.42	23.80	23.00
		1	24	23.33	23.26	22.91
		12	0	22.42	22.36	22.21



	16QAM	12	6	22.28	22.15	22.28
		12	13	22.45	22.35	21.96
		25	0	22.24	22.52	22.08
		1	0	22.36	22.89	22.68
		1	13	22.41	22.97	23.01
		1	24	22.19	22.97	23.01
		12	0	21.42	21.28	21.25
		12	6	21.50	21.24	21.15
		12	13	21.38	21.36	21.15
		25	0	21.37	21.29	21.28
Bandwidth	Modulation	RB size	RB offset	Channel/Frequency (MHz)		
				18650/1855	18900/1880	19150/1905
10MHz	QPSK	1	0	23.38	23.44	23.01
		1	25	23.45	23.85	23.04
		1	49	23.35	23.30	22.94
		25	0	22.45	22.41	22.25
		25	13	22.31	22.20	22.32
		25	25	22.47	22.39	22.01
		50	0	22.32	22.54	22.12
	16QAM	1	0	22.38	22.92	22.70
		1	25	22.44	23.01	23.04
		1	49	22.22	22.99	23.04
		25	0	21.45	21.33	21.29
		25	13	21.52	21.28	21.18
		25	25	21.41	21.41	21.19
		50	0	21.40	21.34	21.32
Bandwidth	Modulation	RB size	RB offset	Channel/Frequency (MHz)		
				18675/1857.5	18900/1880	19125/1902.5
15MHz	QPSK	1	0	23.37	23.40	22.99
		1	38	23.43	23.84	23.01
		1	74	23.32	23.25	22.90
		36	0	22.43	22.37	22.22
		36	18	22.28	22.15	22.28
		36	39	22.44	22.36	21.97
		75	0	22.30	22.50	22.07
	16QAM	1	0	22.33	22.90	22.68
		1	38	22.42	22.98	23.02
		1	74	22.19	22.95	23.01
		36	0	21.42	21.31	21.26
		36	18	21.49	21.23	21.14



		36	39	21.39	21.37	21.16
		75	0	21.37	21.29	21.28
Bandwidth	Modulation	RB size	RB offset	Channel/Frequency (MHz)		
				18700/1860	18900/1880	19100/1900
20MHz	QPSK	1	0	23.34	23.36	22.96
		1	50	23.42	23.80	22.99
		1	99	23.30	23.24	22.87
		50	0	22.40	22.32	22.18
		50	25	22.26	22.11	22.25
		50	50	22.41	22.31	21.93
		100	0	22.27	22.45	22.03
	16QAM	1	0	22.31	22.86	22.63
		1	50	22.38	22.96	22.98
		1	99	22.17	22.92	22.99
		50	0	21.39	21.27	21.23
		50	25	21.46	21.21	21.11
		50	50	21.36	21.32	21.12
		100	0	21.35	21.25	21.25

## 5.2. Effective Isotropic Radiated Power

### Ambient condition

Temperature	Relative humidity	Pressure
23°C ~25°C	45%~50%	101.5kPa

### Methods of Measurement

The testing follows FCC KDB 971168 v03r01 Section 5.8 and ANSI/TIA-603-E (2016).

- a) Connect the equipment as illustrated. Mount the equipment with the manufacturer specified antenna in a vertical orientation on a manufacturer specified mounting surface located on a non-conducting rotating platform of a RF anechoic chamber (preferred) or a standard radiation site.
- b) Key the transmitter, then rotate the EUT 360° azimuthally and record spectrum analyzer power level (LVL) measurements at angular increments that are sufficiently small to permit resolution of all peaks. If a standard radiation test site is used, raise and lower the test antenna to obtain a maximum reading at each angular increment. (Note: several batteries may be needed to offset the effect of battery voltage droop, which should not exceed 5% of the manufactured specified battery voltage during transmission).
- c) Replace the transmitter under test with a vertically polarized half-wave dipole (or an antenna whose gain is known relative to an ideal half-wave dipole). The center of the antenna should be at the same location as the center of the antenna under test.
- d) Connect the antenna to a signal generator with a known output power and record the path loss (in dB) as LOSS. If a standard radiation test site is used, raise and lower the test antenna to obtain a maximum reading.  $LOSS = \text{Generator Output Power (dBm)} - \text{Analyzer reading (dBm)}$
- e) Determine the effective radiated output power at each angular position from the readings in steps b) and d) using the following equation:  $ERP \text{ (dBm)} = \text{LVL (dBm)} + \text{LOSS (dB)}$
- f) The maximum ERP is the maximum value determined in the preceding step.
- g) When calculating ERP, in addition to knowing the antenna radiation and matching characteristics, it is necessary to know the loss values of all elements (e.g. transmission line attenuation, mismatches, filters, combiners) interposed between the point where transmitter output power is measured, and the point where power is applied to the antenna. ERP can then be calculated as follows:  
 $EIRP \text{ (dBm)} = \text{Output Power (dBm)} - \text{Losses (dB)} + \text{Antenna Gain (dBd)}$   
where: dBd refers to gain relative to an ideal dipole.  
 $EIRP \text{ (dBm)} = \text{ERP (dBm)} + 2.15 \text{ (dB.)}$

The RB allocation refers to section 5.1, using the maximum output power configuration.



**Test setup**

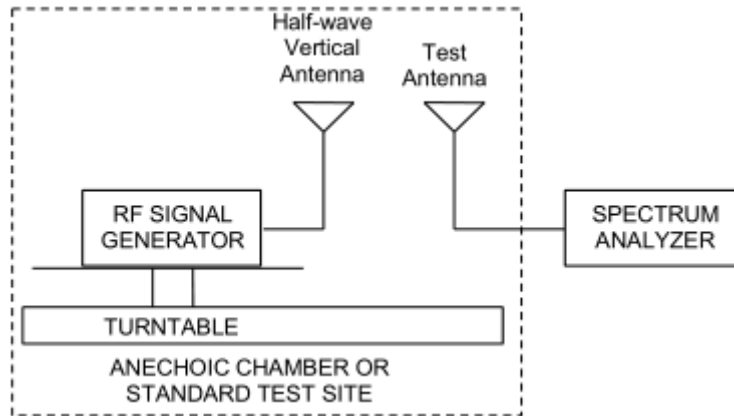
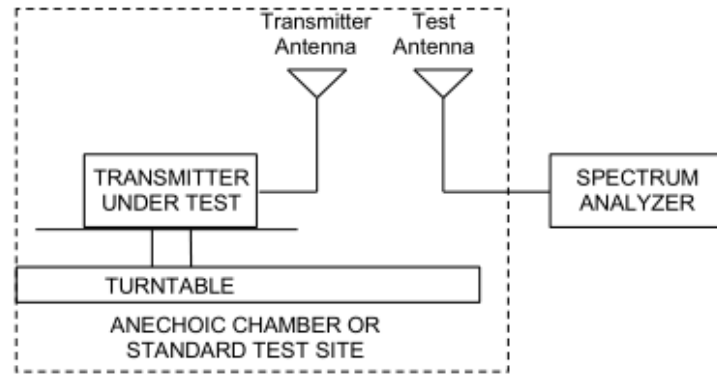

**Limits**

Rule Part 24.232(c) Mobile and portable stations are limited to 2 watts EIRP.

Rule Part 24.232(e) Peak transmit power must be measured over any interval of continuous transmission using instrumentation calibrated in terms of an rms-equivalent voltage.

Limit	$\leq 2\text{ W}$ (33 dBm)
-------	----------------------------

**Measurement Uncertainty**

The assessed measurement uncertainty to ensure 95% confidence level for the normal distribution is with the coverage factor  $k = 2$ ,  $U = 1.19\text{ dB}$

**Test Results:**

The measurement is performed for both of horizontal and vertical antenna Polarization, and only the data of worst mode is recorded in this report.

Mode	Channel	Frequency (MHz)	Polarization	EIRP (dBm)	Limit (dBm)	Conclusion
WCDMA Band II	Low	1852.4	Horizontal	23.76	33	Pass
	Mid	1880	Horizontal	24.38	33	Pass
	High	1907.6	Horizontal	25.49	33	Pass

LTE Band 2						
bandwidth	Channel	Frequency (MHz)	Polarization	EIRP (dBm)	Limit (dBm)	Conclusion
1.4 MHz (QPSK)	Low	1850.7	Horizontal	25.50	33	Pass
	Mid	1880	Horizontal	25.37	33	Pass
	High	1909.3	Horizontal	25.75	33	Pass
3 MHz (QPSK)	Low	1851.5	Horizontal	24.44	33	Pass
	Mid	1880	Horizontal	24.42	33	Pass
	High	1908.5	Horizontal	24.55	33	Pass
5 MHz (QPSK)	Low	1852.5	Horizontal	24.23	33	Pass
	Mid	1880	Horizontal	24.33	33	Pass
	High	1907.5	Horizontal	24.40	33	Pass
10 MHz (QPSK)	Low	1855	Horizontal	25.48	33	Pass
	Mid	1880	Horizontal	25.52	33	Pass
	High	1905	Horizontal	25.66	33	Pass
15 MHz (QPSK)	Low	1857.5	Horizontal	25.32	33	Pass
	Mid	1880	Horizontal	25.24	33	Pass
	High	1902.5	Horizontal	25.68	33	Pass
20 MHz (QPSK)	Low	1860	Horizontal	24.85	33	Pass
	Mid	1880	Horizontal	24.38	33	Pass
	High	1900	Horizontal	24.21	33	Pass
1.4 MHz (16QAM)	Low	1850.7	Horizontal	25.07	33	Pass
	Mid	1880	Horizontal	24.74	33	Pass
	High	1909.3	Horizontal	25.40	33	Pass
3 MHz (16QAM)	Low	1851.5	Horizontal	24.20	33	Pass
	Mid	1880	Horizontal	24.01	33	Pass
	High	1908.5	Horizontal	24.39	33	Pass
5 MHz (16QAM)	Low	1852.5	Horizontal	23.65	33	Pass
	Mid	1880	Horizontal	23.96	33	Pass
	High	1907.5	Horizontal	23.99	33	Pass
10 MHz (16QAM)	Low	1855	Horizontal	25.24	33	Pass
	Mid	1880	Horizontal	25.10	33	Pass
	High	1905	Horizontal	25.43	33	Pass
15 MHz (16QAM)	Low	1857.5	Horizontal	24.94	33	Pass
	Mid	1880	Horizontal	25.10	33	Pass
	High	1902.5	Horizontal	25.44	33	Pass
20 MHz (16QAM)	Low	1860	Horizontal	24.56	33	Pass
	Mid	1880	Horizontal	23.86	33	Pass
	High	1900	Horizontal	23.77	33	Pass

### 5.3.Occupied Bandwidth

#### Ambient condition

Temperature	Relative humidity	Pressure
23°C ~25°C	45%~50%	101.5kPa

#### Method of Measurement

The EUT was connected to Spectrum Analyzer and Base Station Simulator via power Splitter. The occupied bandwidth is measured using spectrum analyzer.

RBW is set to 51kHz, VBW is set to 160kHz for WCDMA Band II,

RBW is set to 51kHz, VBW is set to 160kHz for LTE Band 2 (1.4MHz),

RBW is set to 100kHz,VBW is set to 300kHz for LTE Band 2 (3MHz/5MHz),

RBW is set to 300kHz,VBW is set to 1MHz for LTE Band 2 (10MHz/15MHz/20MHz).

99% power and -26dBc occupied bandwidths are recorded. Spectrum analyzer plots are included on the following pages.

#### Test Setup

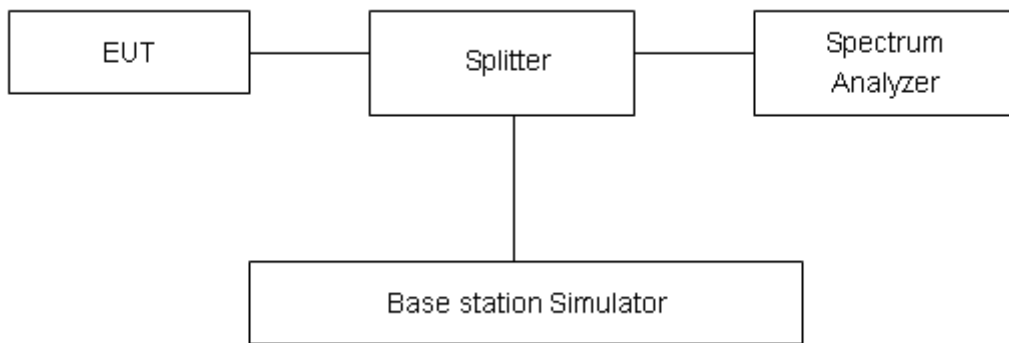

#### Limits

No specific occupied bandwidth requirements in part 2.1049.

#### Measurement Uncertainty

The assessed measurement uncertainty to ensure 95% confidence level for the normal distribution is with the coverage factor  $k = 2$ ,  $U = 624\text{Hz}$ .



## Test Result

Mode	Channel	Frequency (MHz)	99% Power Bandwidth (MHz)	-26dBc Bandwidth(MHz)
WCDMA Band II (RMC)	9262	1852.4	4.1326	4.698
	9400	1880	4.1256	4.703
	9538	1907.6	4.1260	4.695

LTE Band 2					
Modulation	Bandwidth (MHz)	Channel	Frequency (MHz)	99% Power Bandwidth(MHz)	-26dBc Bandwidth(MHz)
QPSK	1.4	18607	1850.7	1.1283	1.363
		18900	1880.0	1.1245	1.347
		19193	1909.3	1.1360	1.344
	3	18615	1851.5	2.7521	3.071
		18900	1880	2.7423	3.074
		19185	1908.5	2.7429	3.071
	5	18625	1852.5	4.5158	5.049
		18900	1880	4.5340	5.036
		19175	1907.5	4.5091	5.036
	10	18650	1855	8.9999	10.100
		18900	1880	9.0377	10.180
		19150	1905	9.0453	10.070
	15	18675	1857.5	13.4130	14.680
		18900	1880	13.4790	14.810
		19125	1902.5	13.4540	14.800
	20	18700	1860	17.8360	19.250
		18900	1880	17.8820	19.240
		19100	1900	17.8620	19.410
16QAM	1.4	18607	1850.7	1.1258	1.330
		18900	1880.0	1.1317	1.348
		19193	1909.3	1.1225	1.362
	3	18615	1851.5	2.7358	3.059
		18900	1880	2.7655	3.083



		19185	1908.5	2.7377	3.067
	5	18625	1852.5	4.5387	5.046
		18900	1880	4.5117	5.028
		19175	1907.5	4.5298	5.057
	10	18650	1855	9.0229	10.090
		18900	1880	9.0420	10.020
		19150	1905	9.0252	10.090
	15	18675	1857.5	13.4540	14.740
		18900	1880	13.4620	14.730
		19125	1902.5	13.4640	14.800
	20	18700	1860	17.8810	19.380
		18900	1880	17.9150	19.350
		19100	1900	17.8400	19.300

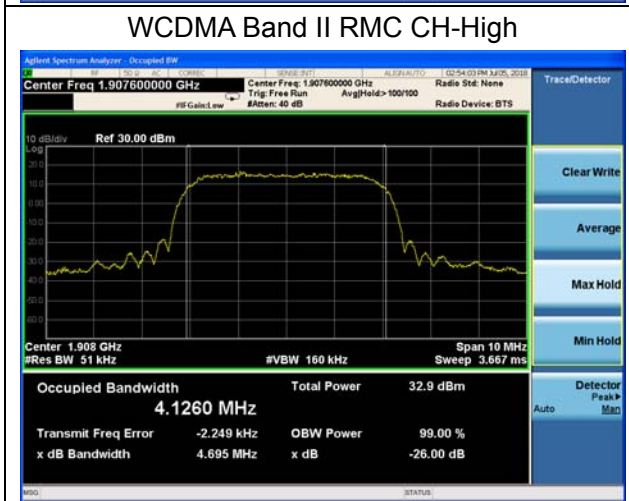
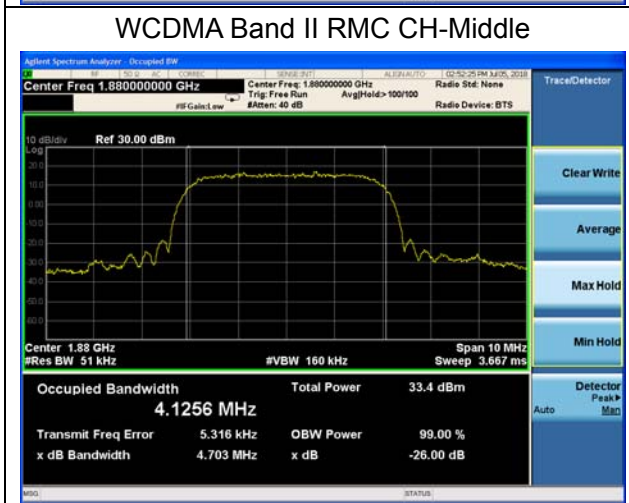
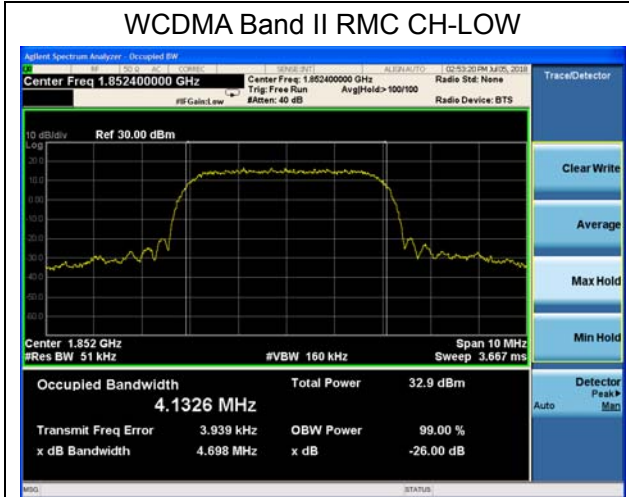

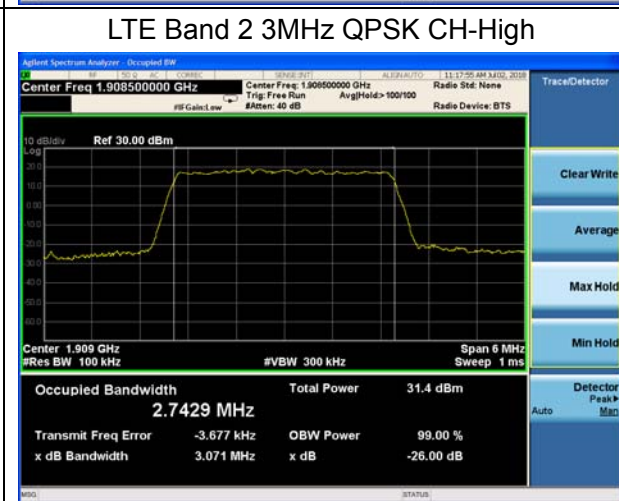
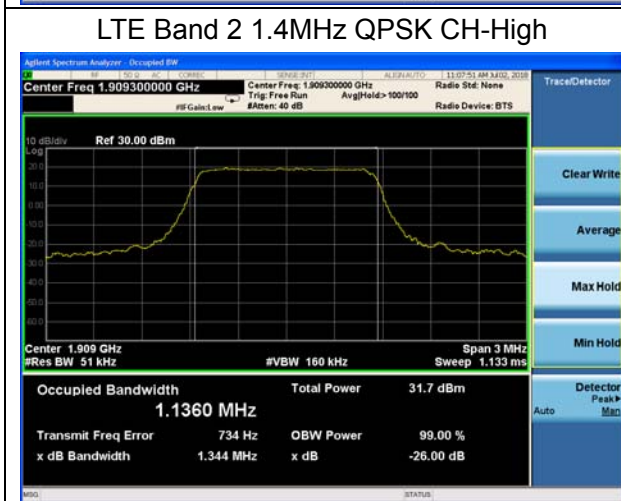
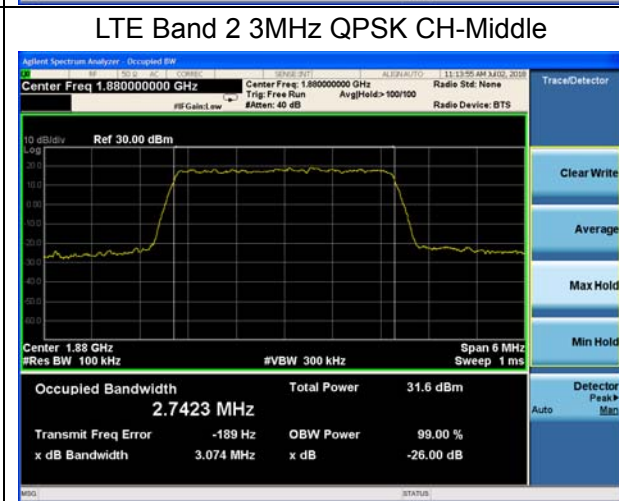
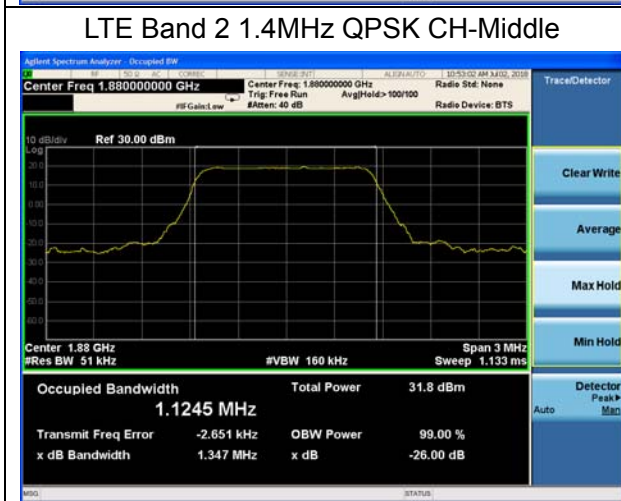
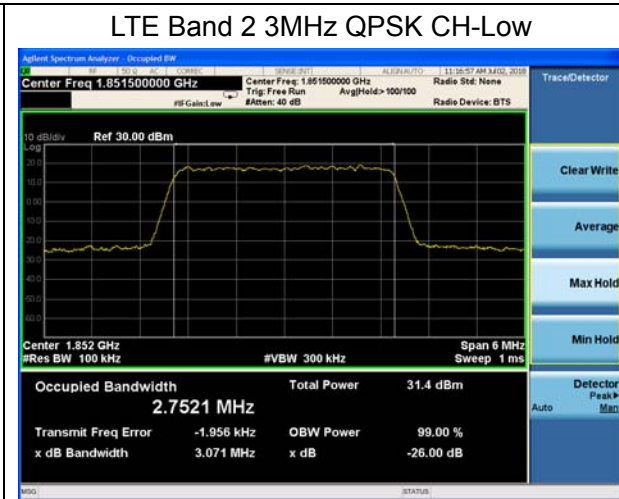
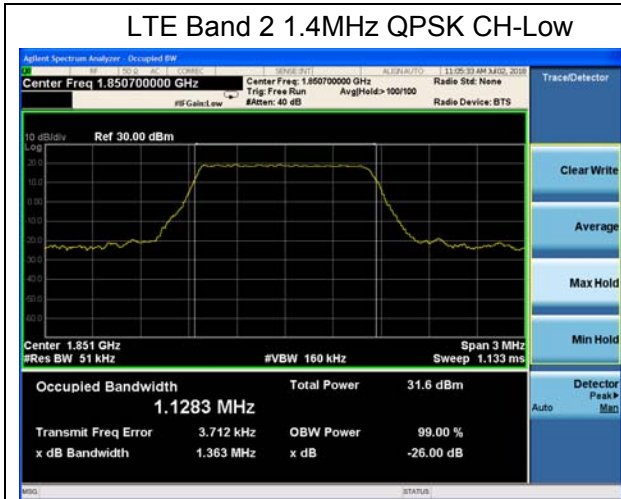



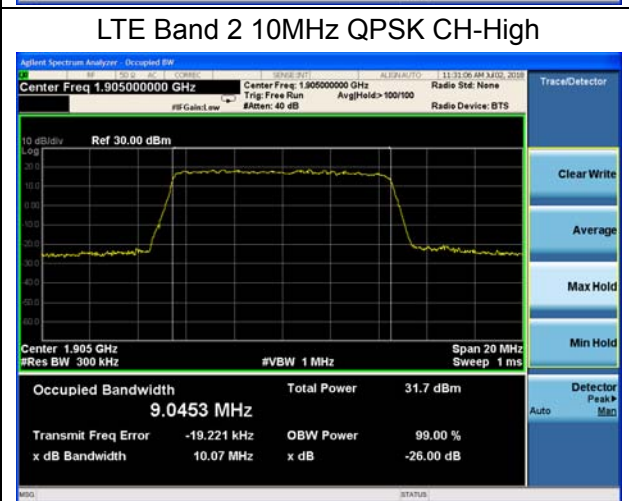
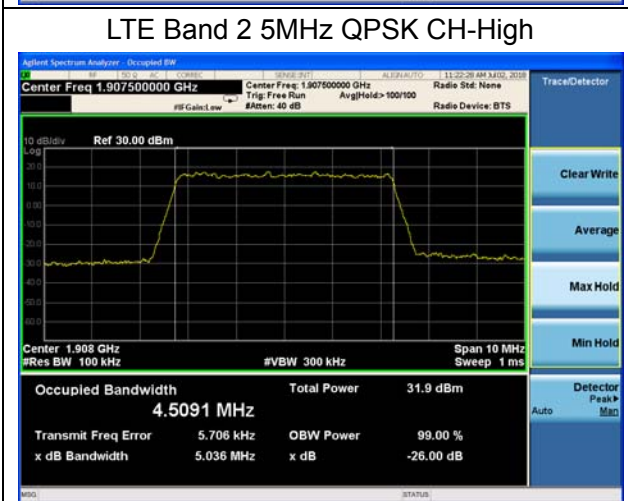
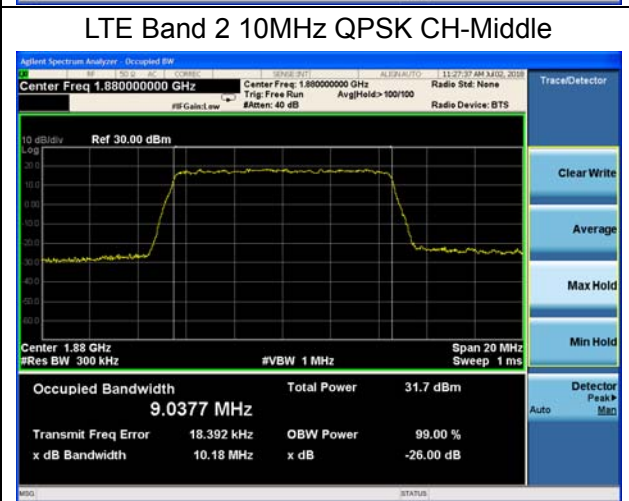
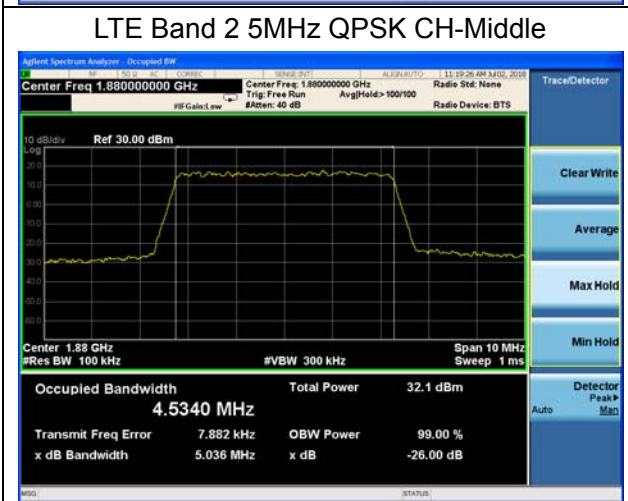
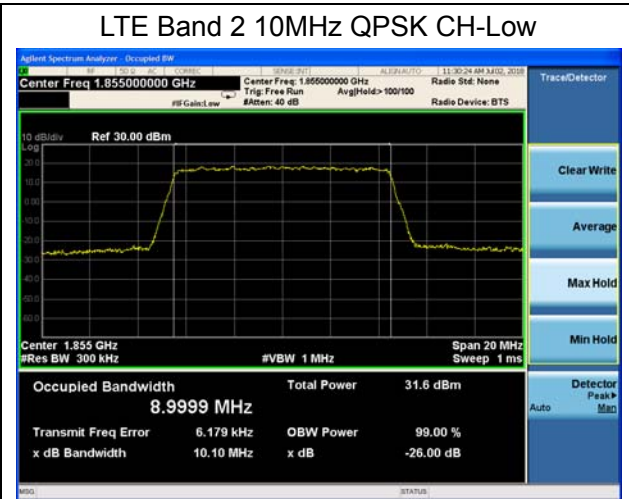
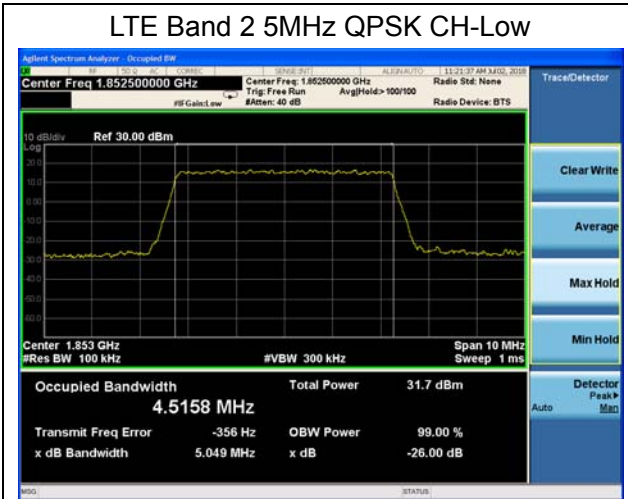

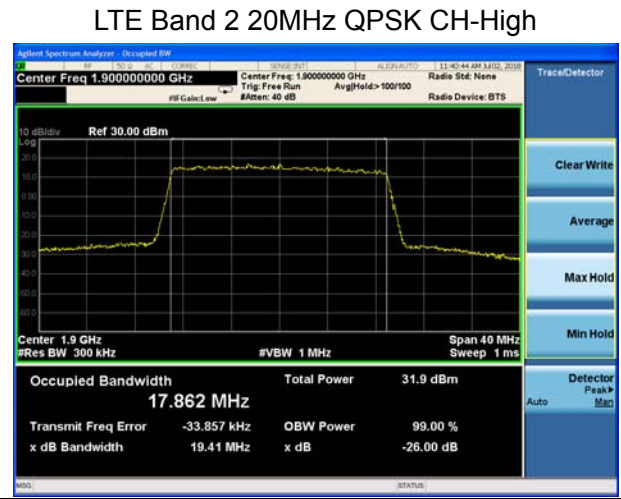
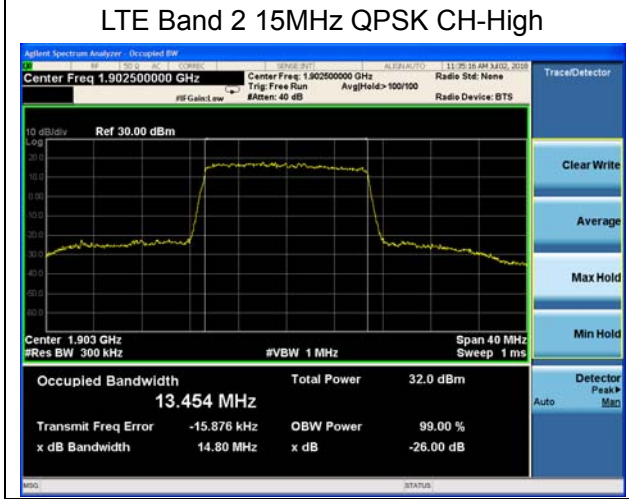
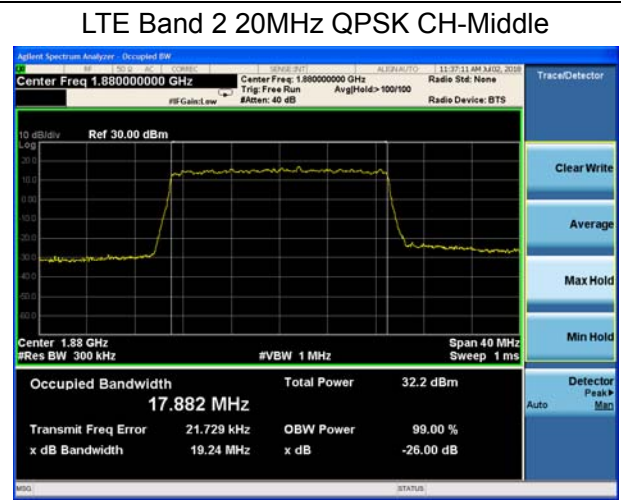
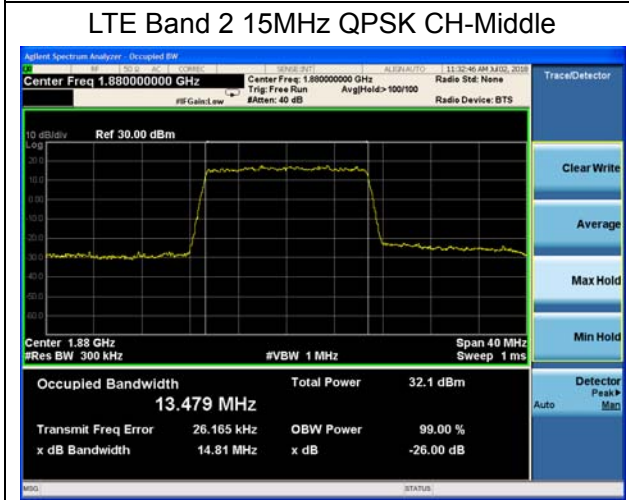
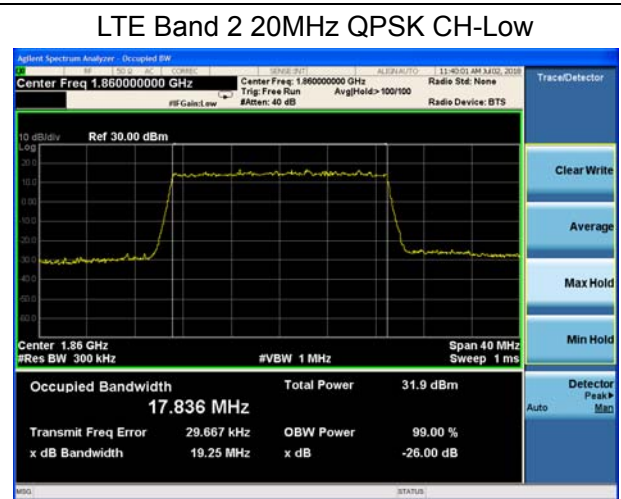
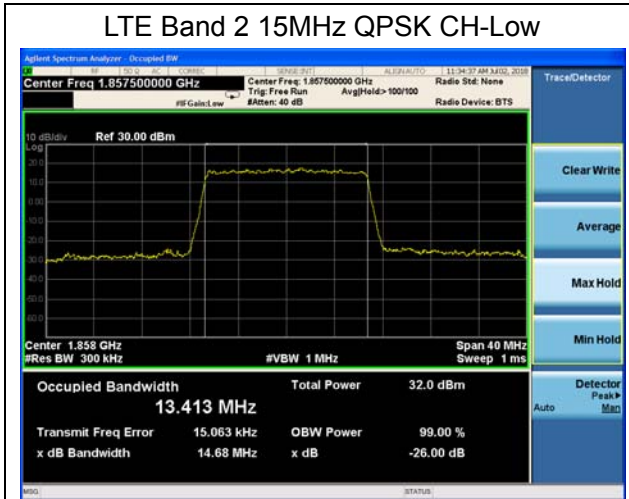

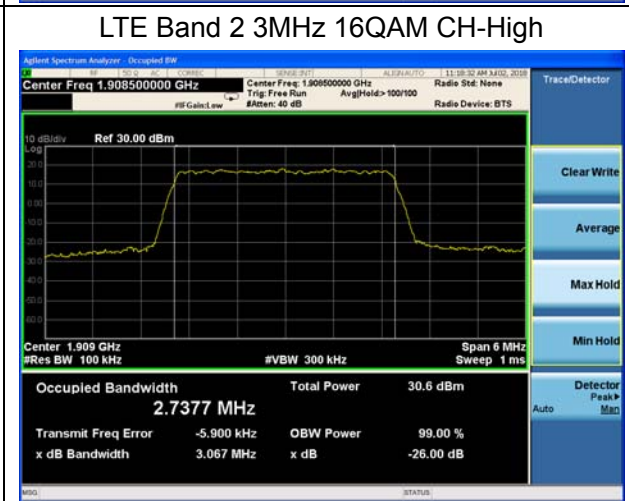
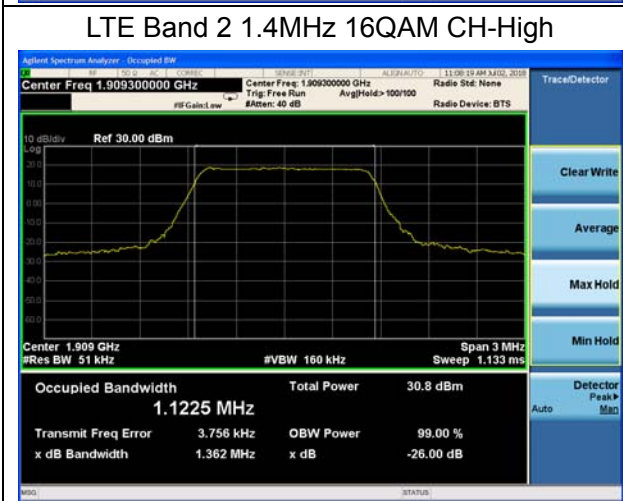
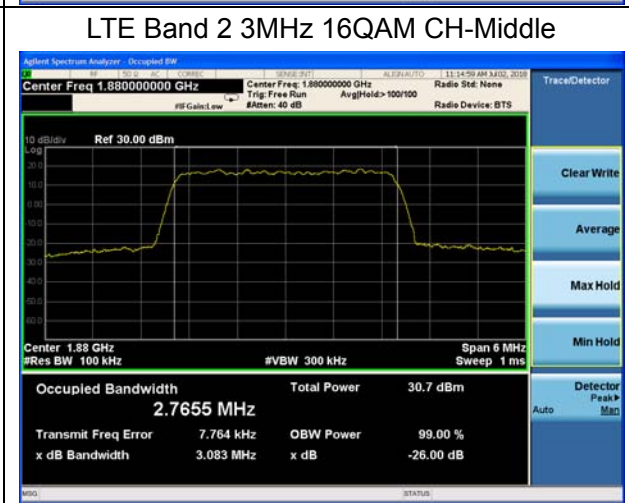
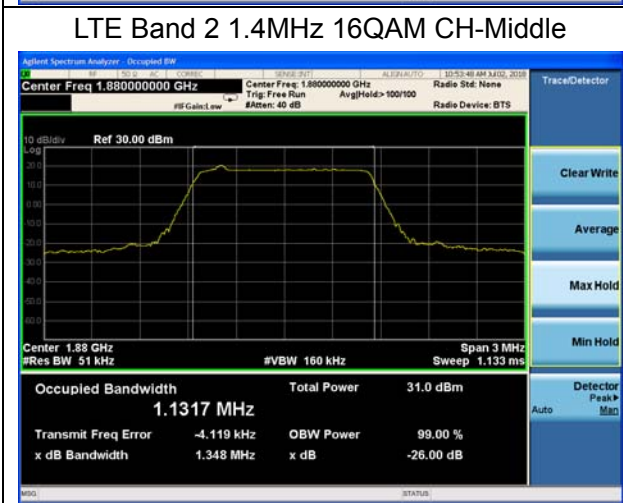
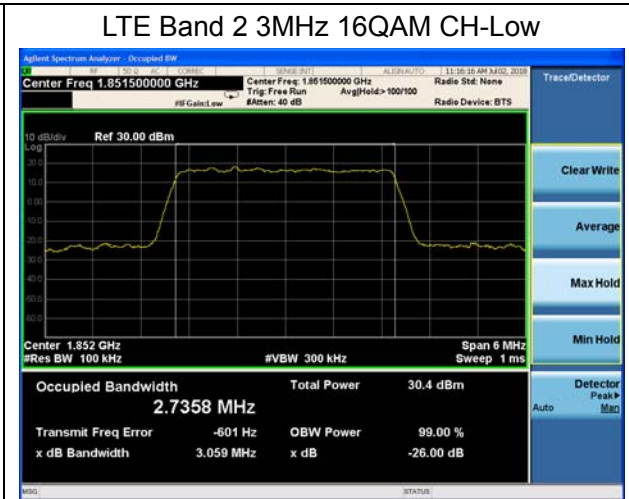
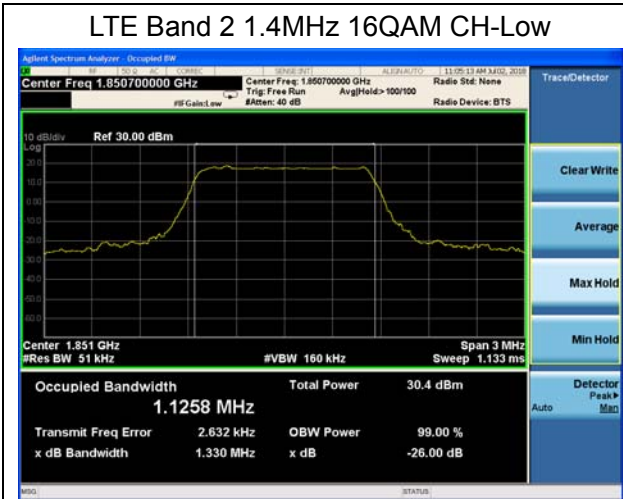

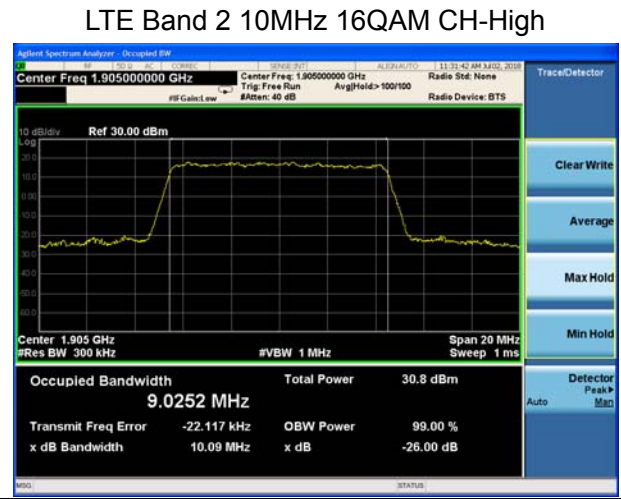
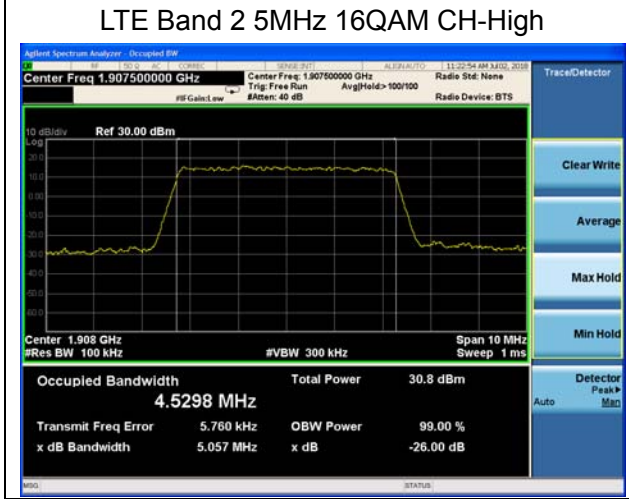
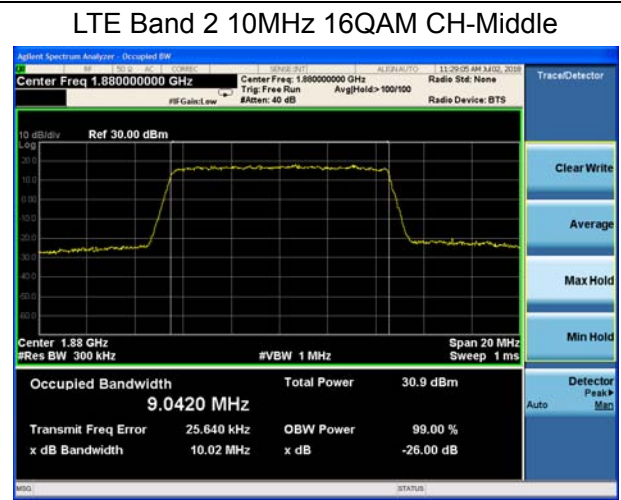
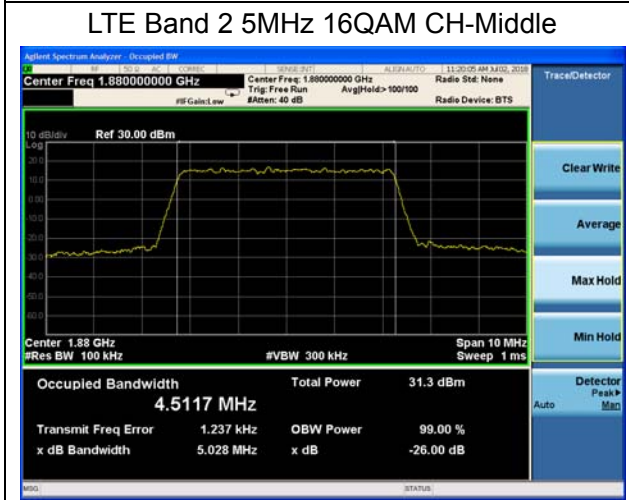
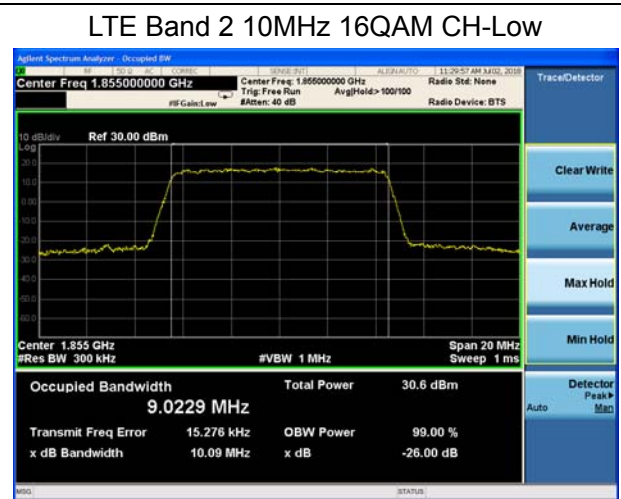
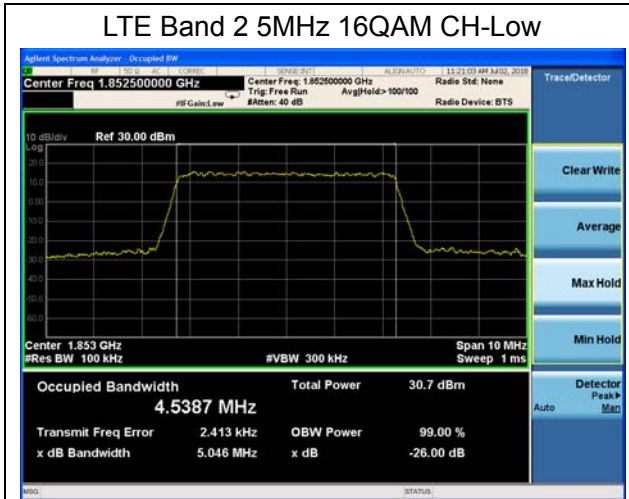

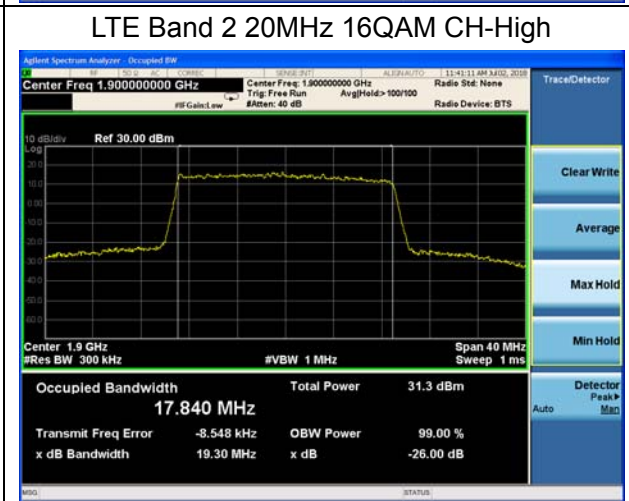
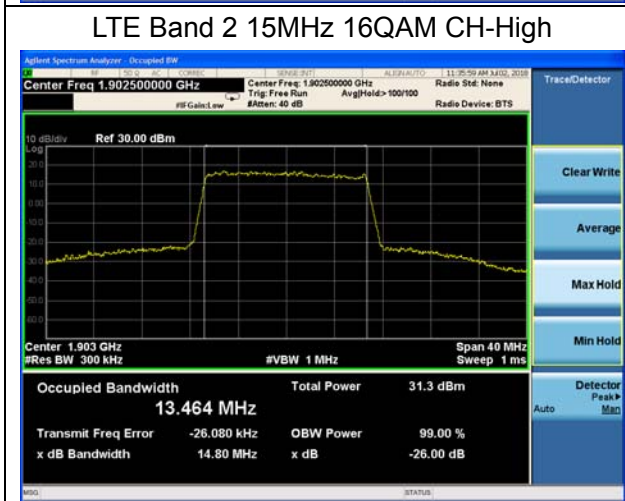
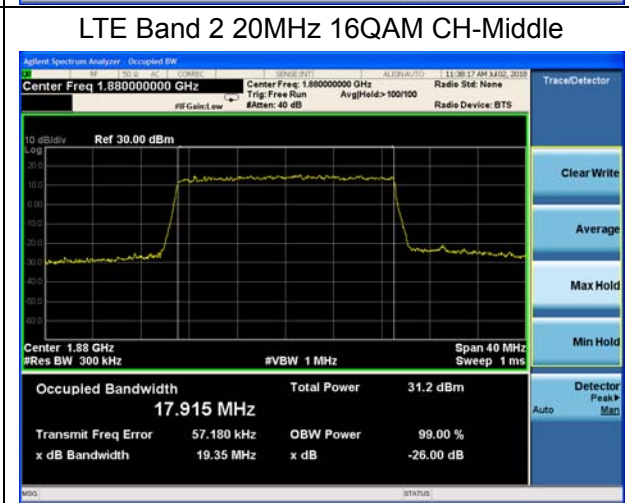
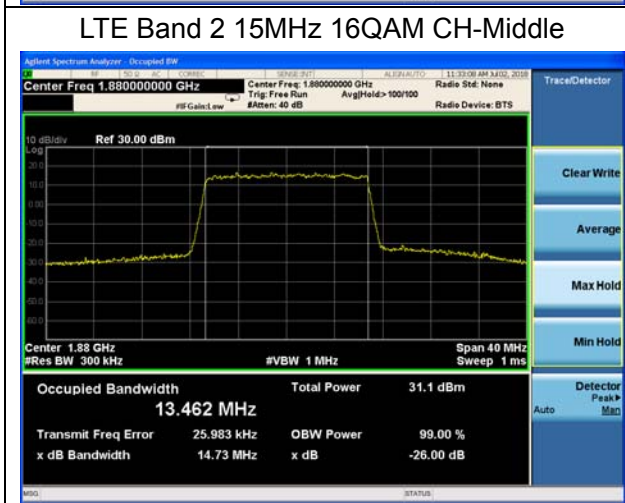
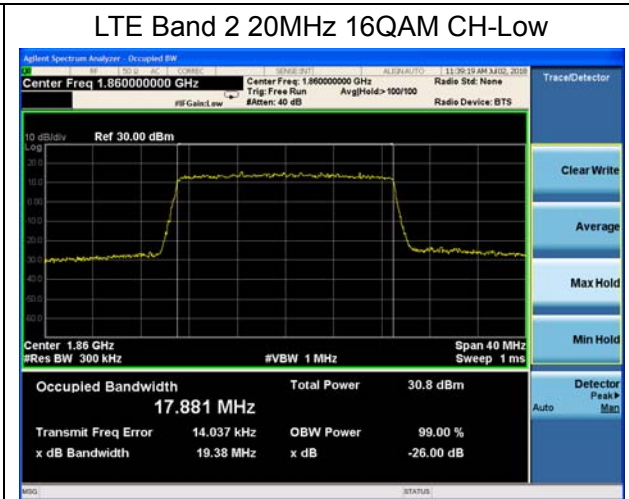
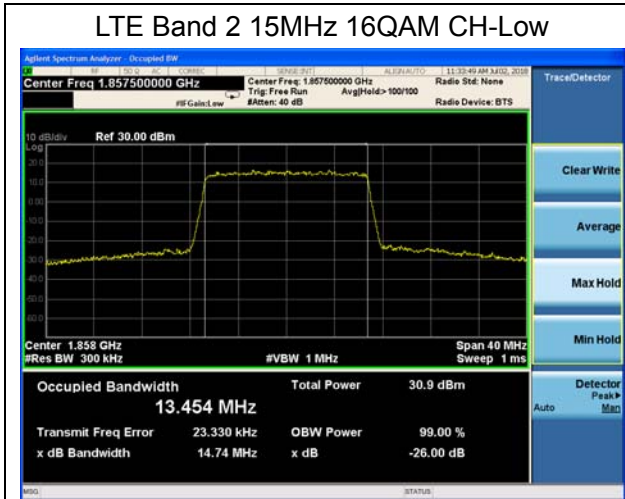

### 5.4. Band Edge Compliance

#### Ambient condition

Temperature	Relative humidity	Pressure
23°C ~25°C	45%~50%	101.5kPa

#### Method of Measurement

The EUT was connected to Spectrum Analyzer and Base Station Simulator via power Splitter. The band edge of the lowest and highest channels were measured. The Average detector is used and RBW is set to 51kHz, VBW is set to 160kHz for WCDMA Band II, RBW is set to 15kHz, VBW is set to 51kHz for LTE Band 2 (1.4MHz), RBW is set to 30kHz, VBW is set to 100kHz for LTE Band 2 (3MHz), RBW is set to 51kHz, VBW is set to 160kHz for LTE Band 2 (5MHz), RBW is set to 100kHz, VBW is set to 300kHz for LTE Band 2 (10MHz), RBW is set to 150kHz, VBW is set to 510kHz for LTE Band 2 (15MHz), RBW is set to 200kHz, VBW is set to 620kHz for LTE Band 2 (20MHz). Spectrum analyzer plots are included on the following pages.

#### Test Setup

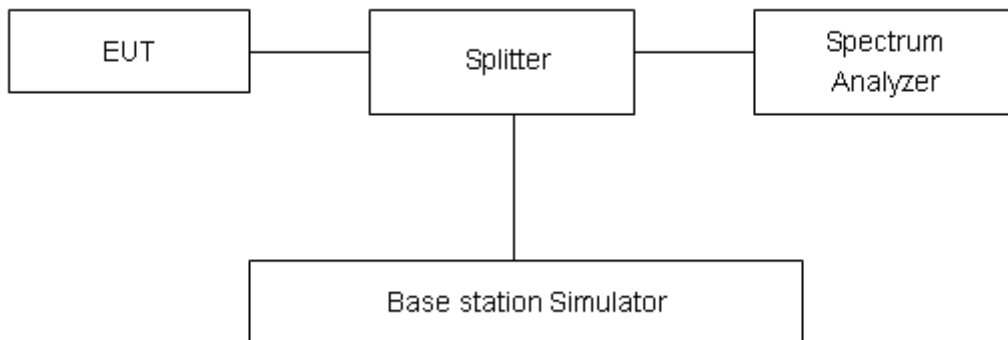

#### Limits

Rule Part 24.238(a) specifies that “on any frequency outside a licensee’s frequency block, the power of any emission shall be attenuated below the transmitter power (P) by at least 43 + 10 log<sub>10</sub> (P) dB.”

Limit	-13 dBm
-------	---------

#### Measurement Uncertainty

The assessed measurement uncertainty to ensure 95% confidence level for the normal distribution is with the coverage factor  $k = 1.96$ ,  $U=0.684$ dB.



Test Result:

WCDMA Band II RMC CH-Low

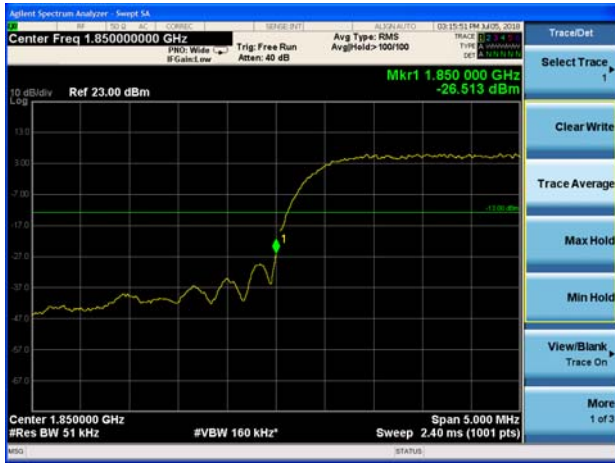

WCDMA Band II RMC CH-High



LTE Band 2 1.4MHz QPSK 1RB CH-Low



LTE Band 2 1.4MHz QPSK 1RB CH-High



LTE Band 2 1.4MHz QPSK 100%RB CH-Low

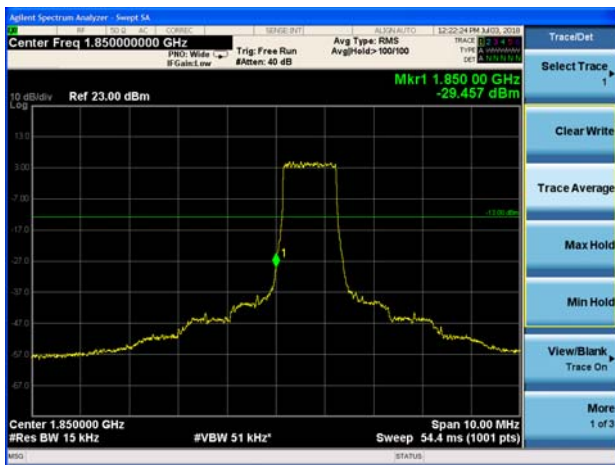

LTE Band 2 1.4MHz QPSK 100%RB CH-High



LTE Band 2 3MHz QPSK 1RB CH-Low

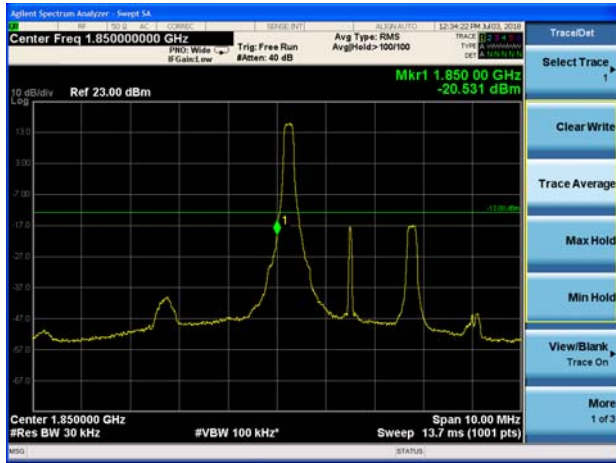

LTE Band 2 3MHz QPSK 1RB CH-High

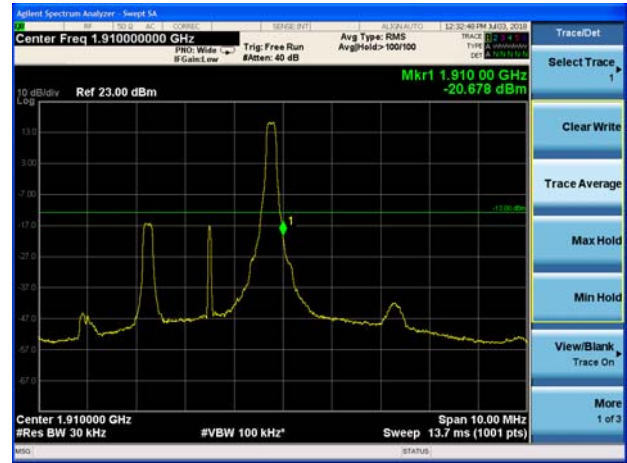

LTE Band 2 3MHz QPSK 100%RB CH-Low



LTE Band 2 3MHz QPSK 100%RB CH-High



LTE Band 2 5MHz QPSK 1RB CH-Low

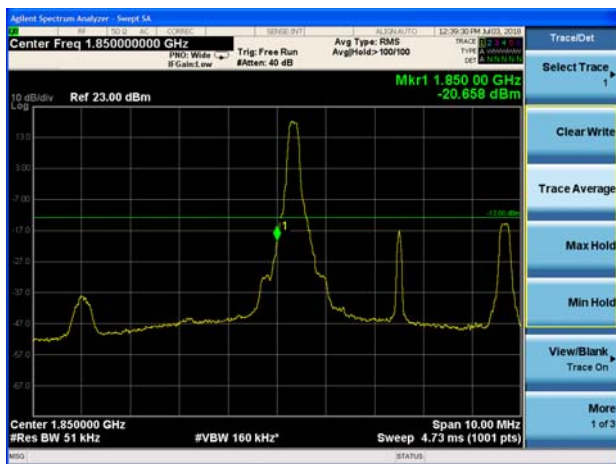

LTE Band 2 5MHz QPSK 1RB CH-High

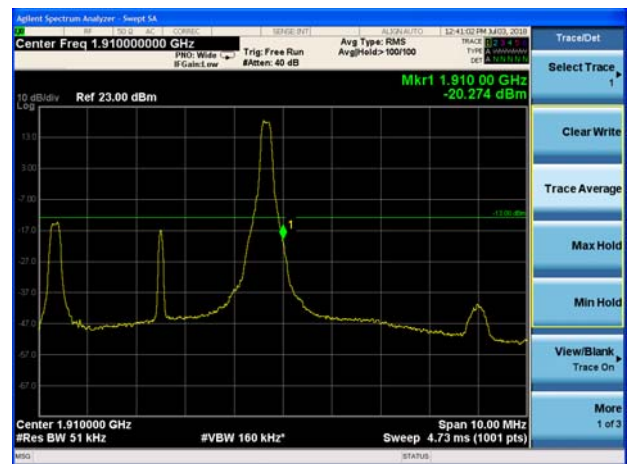





LTE Band 2 5MHz QPSK 100%RB CH-Low

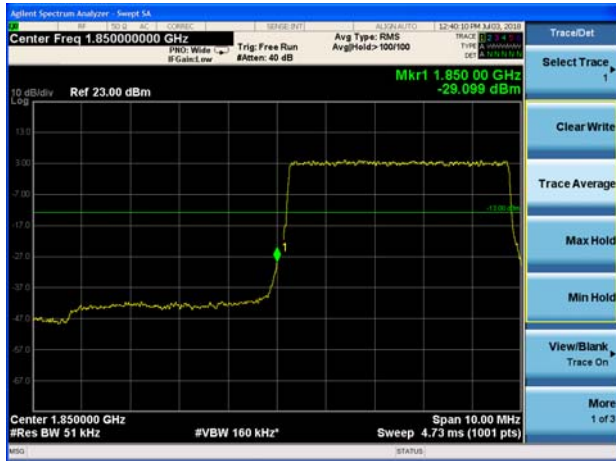

LTE Band 2 5MHz QPSK 100%RB CH-High

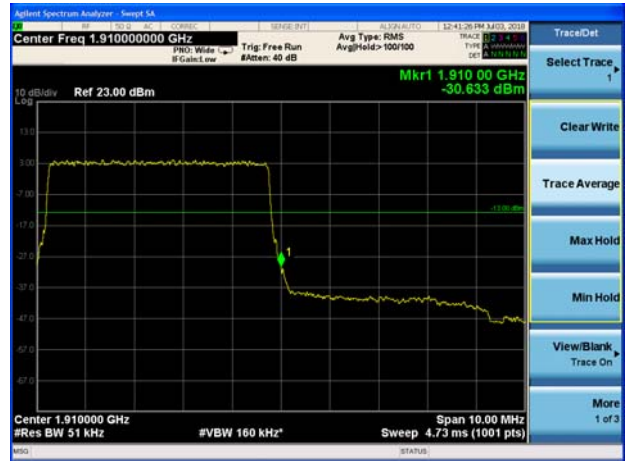

LTE Band 2 10MHz QPSK 1RB CH-Low

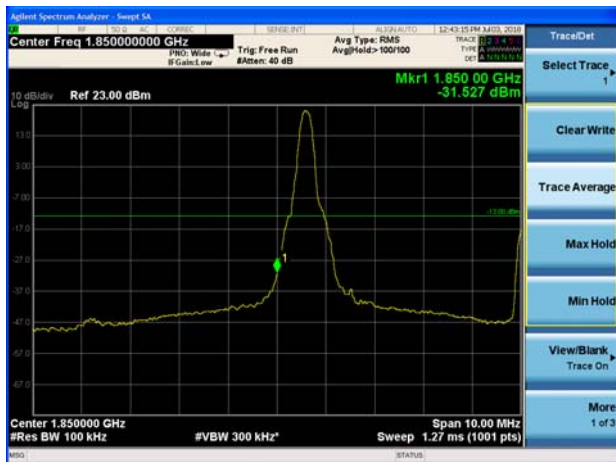

LTE Band 2 10MHz QPSK 1RB CH-High

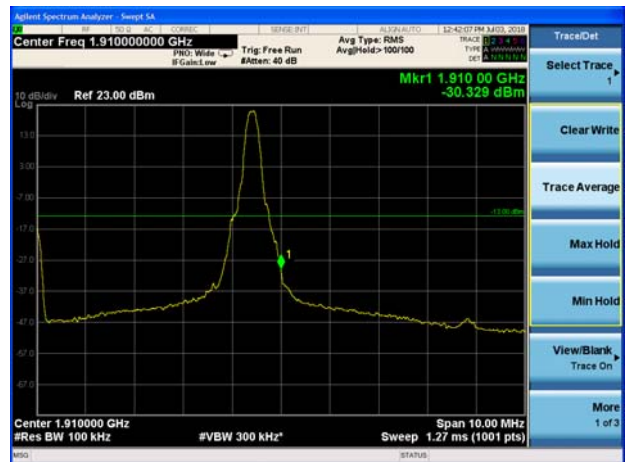

LTE Band 2 10MHz QPSK 100%RB CH-Low

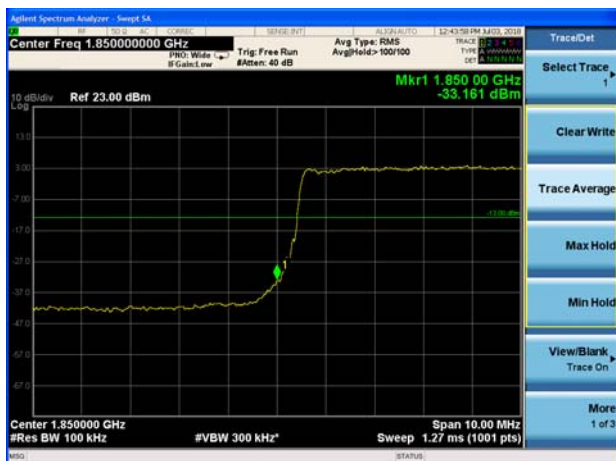

LTE Band 2 10MHz QPSK 100%RB CH-High





LTE Band 2 15MHz QPSK 1RB CH-Low

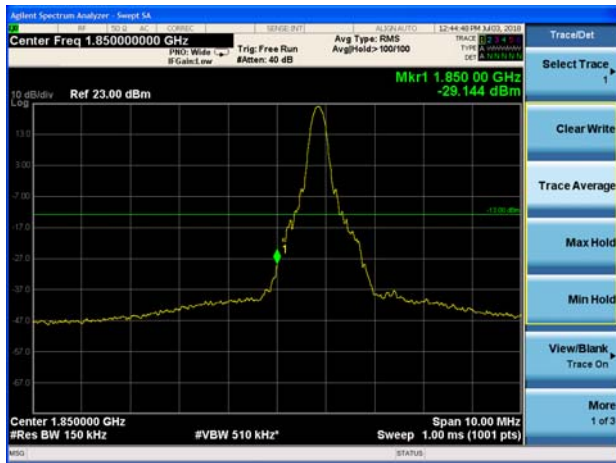

LTE Band 2 15MHz QPSK 1RB CH-High

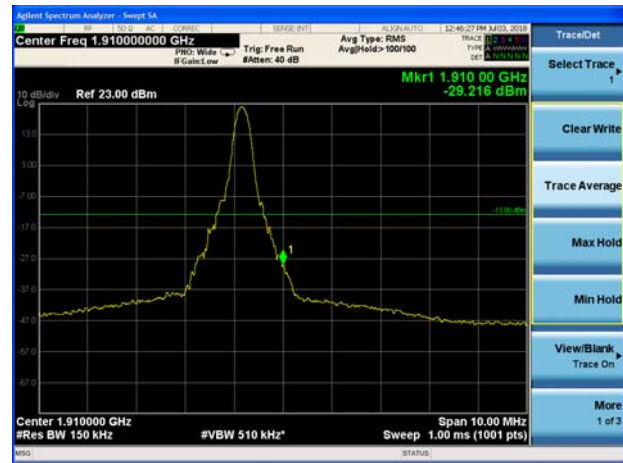

LTE Band 2 15MHz QPSK 100%RB CH-Low



LTE Band 2 15MHz QPSK 100%RB CH-High



LTE Band 2 20MHz QPSK 1RB CH-Low

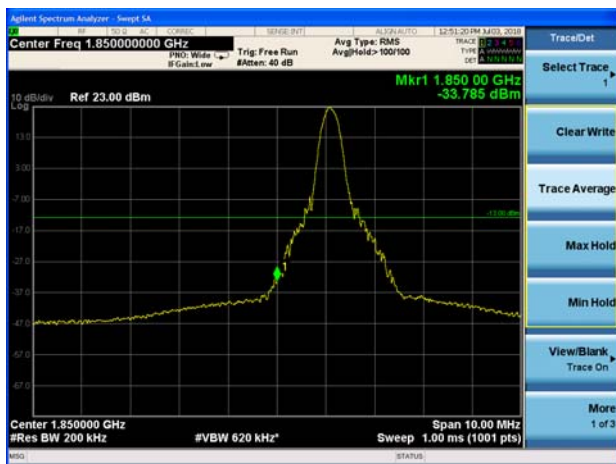

LTE Band 2 20MHz QPSK 1RB CH-High

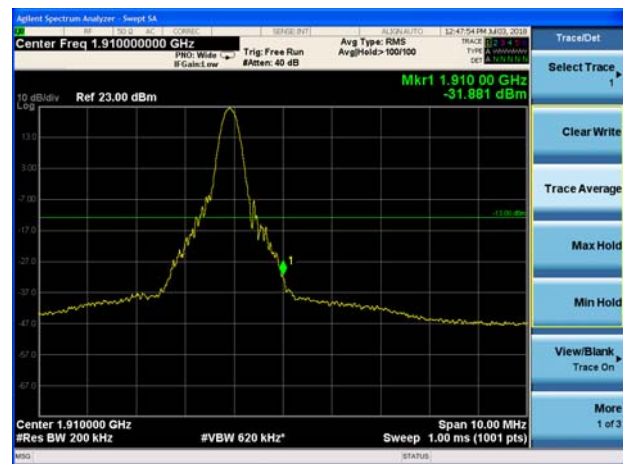

LTE Band 2 20MHz QPSK 100%RB CH-Low



LTE Band 2 20MHz QPSK 100%RB CH-High



LTE Band 2 1.4MHz 16QAM 1RB CH-Low

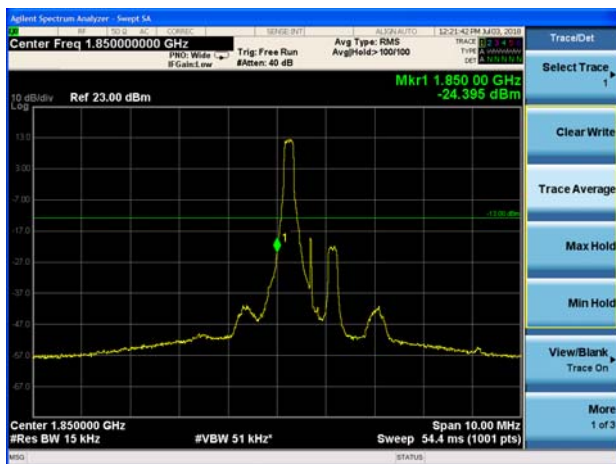

LTE Band 2 1.4MHz 16QAM 1RB CH-High

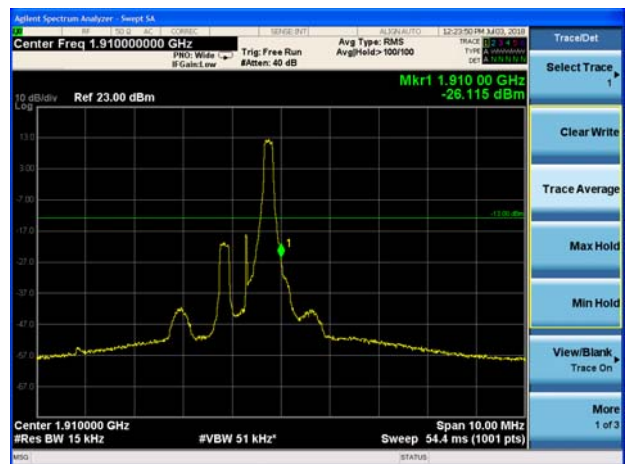

LTE Band 2 1.4MHz 16QAM 100%RB CH-Low

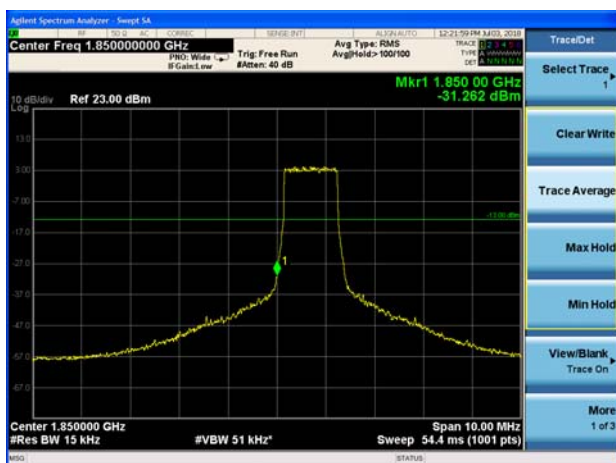

LTE Band 2 1.4MHz 16QAM 100%RB CH-High

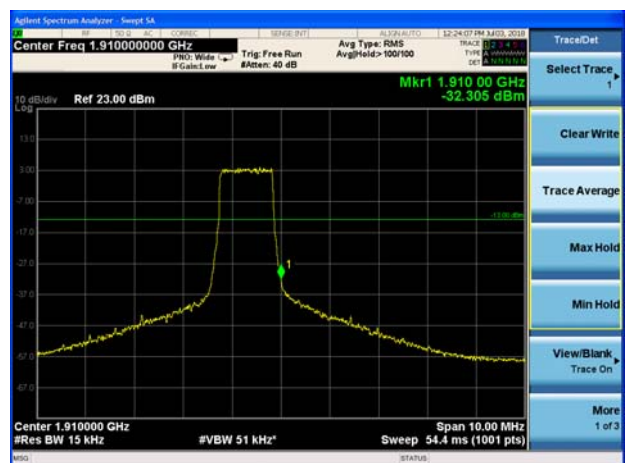



LTE Band 2 3MHz 16QAM 1RB CH-Low

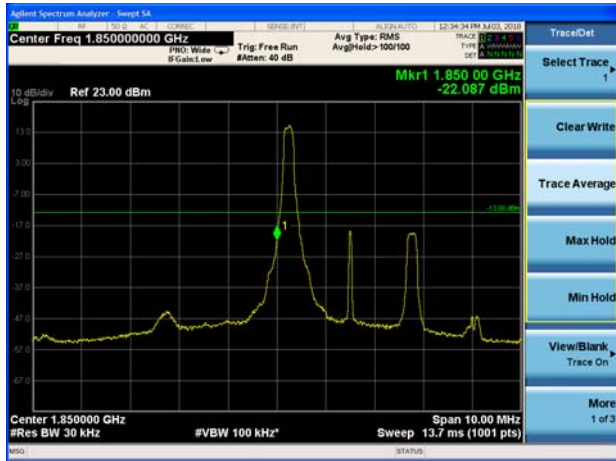

LTE Band 2 3MHz 16QAM 1RB CH-High

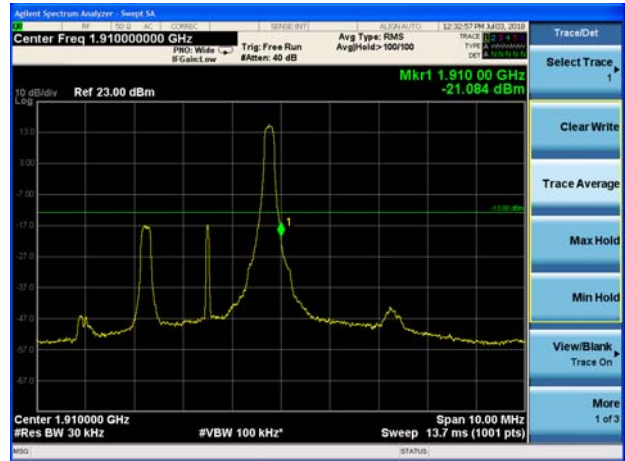

LTE Band 2 3MHz 16QAM 100%RB CH-Low

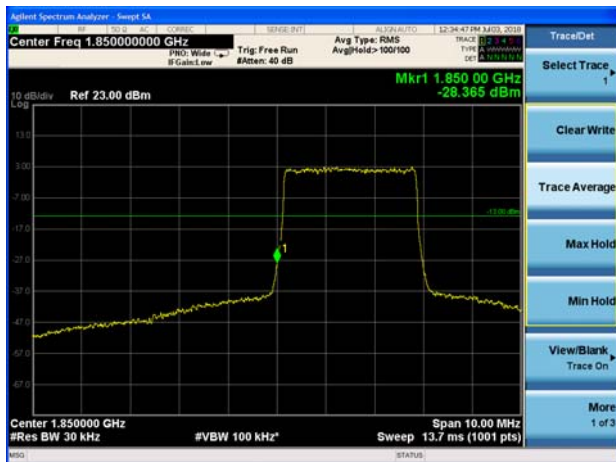

LTE Band 2 3MHz 16QAM 100%RB CH-High



LTE Band 2 5MHz 16QAM 1RB CH-Low

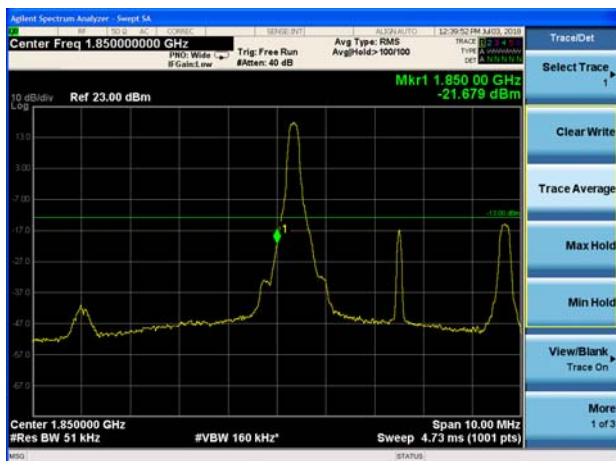

LTE Band 2 5MHz 16QAM 1RB CH-High

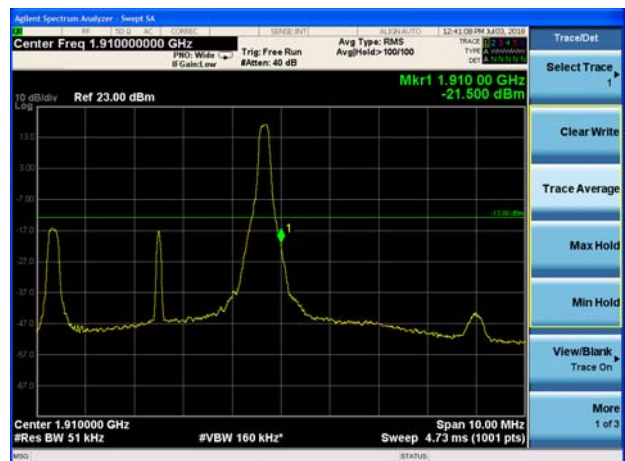



LTE Band 2 5MHz 16QAM 100%RB CH-Low



LTE Band 2 5MHz 16QAM 100%RB CH-High



LTE Band 2 10MHz 16QAM 1RB CH-Low

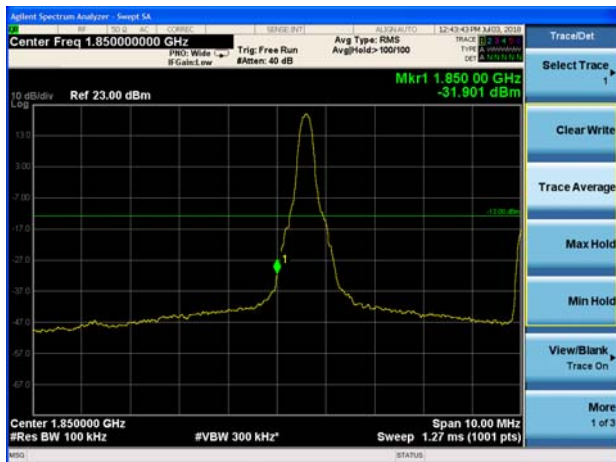

LTE Band 2 10MHz 16QAM 1RB CH-High

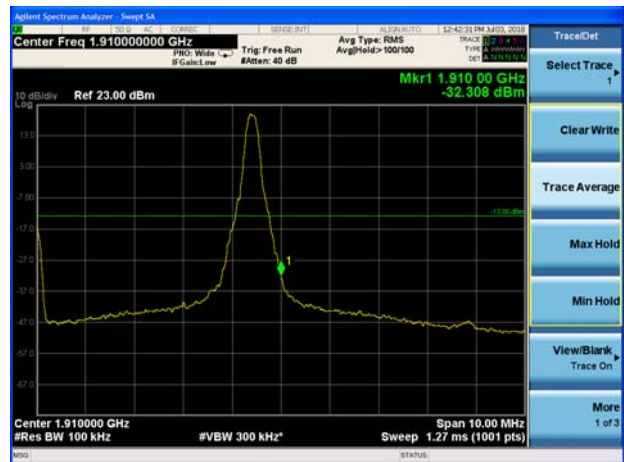

LTE Band 2 10MHz 16QAM 100%RB CH-Low

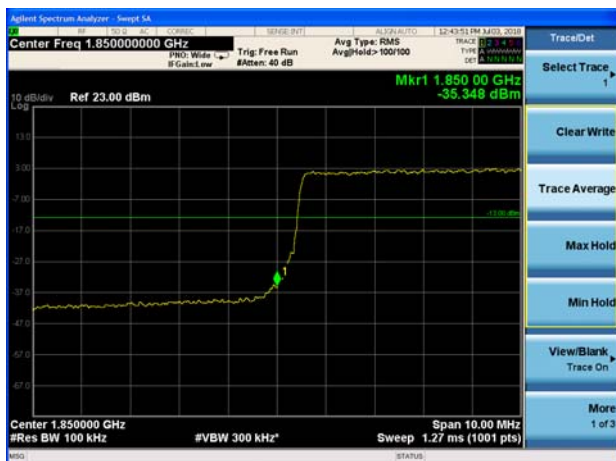

LTE Band 2 10MHz 16QAM 100%RB CH-High





LTE Band 2 15MHz 16QAM 1RB CH-Low

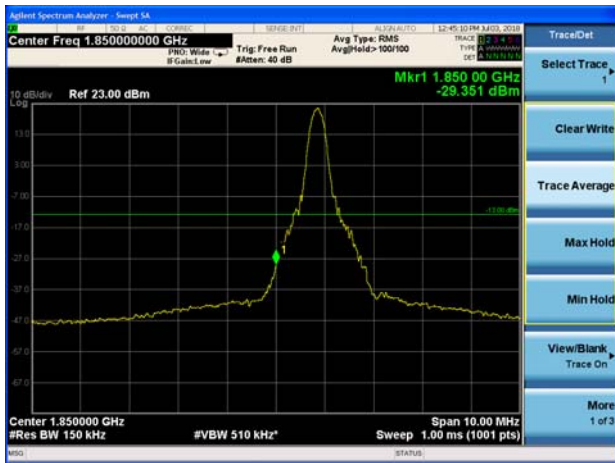

LTE Band 2 15MHz 16QAM 1RB CH-High

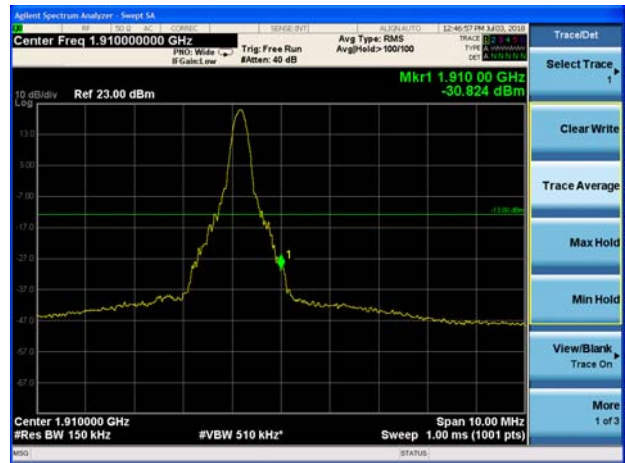

LTE Band 2 15MHz 16QAM 100%RB CH-Low

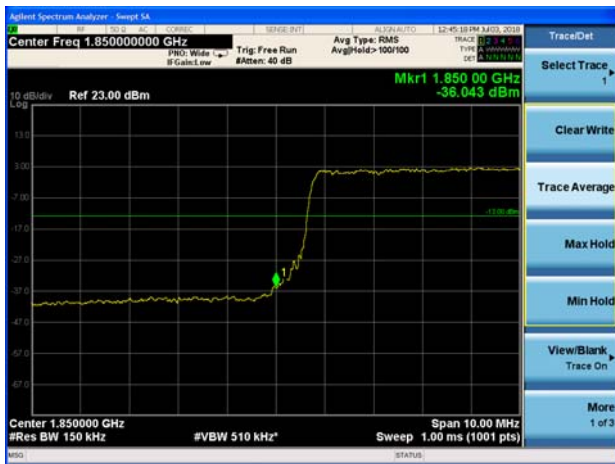

LTE Band 2 15MHz 16QAM 100%RB CH-High



LTE Band 2 20MHz 16QAM 1RB CH-Low

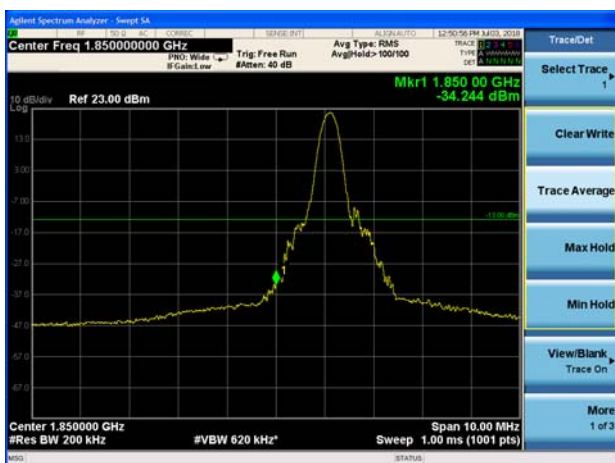

LTE Band 2 20MHz 16QAM 1RB CH-High

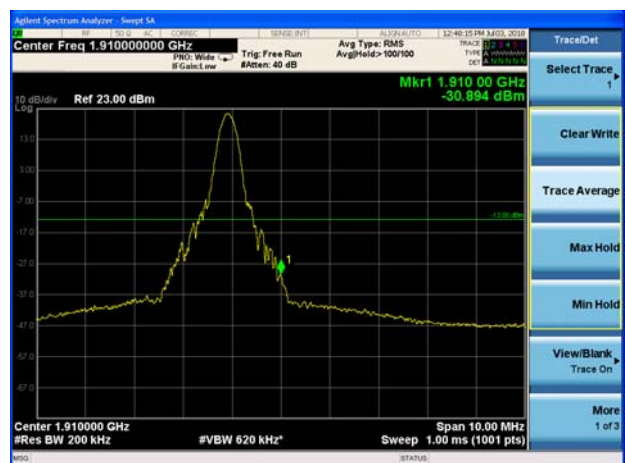



LTE Band 2 20MHz 16QAM 100%RB CH-Low



LTE Band 2 20MHz 16QAM 100%RB CH-High



### 5.5. Peak-to-Average Power Ratio (PAPR)

#### Ambient condition

Temperature	Relative humidity	Pressure
23°C ~25°C	45%~50%	101.5kPa

#### Methods of Measurement

Measure the total peak power and record as PPk. And measure the total average power and record as PAvg. Both the peak and average power levels must be expressed in the same logarithmic units (e.g., dBm). Determine the PAPR from:

$$PAPR (dB) = PPk (dBm) - PAvg (dBm).$$

#### Test Setup

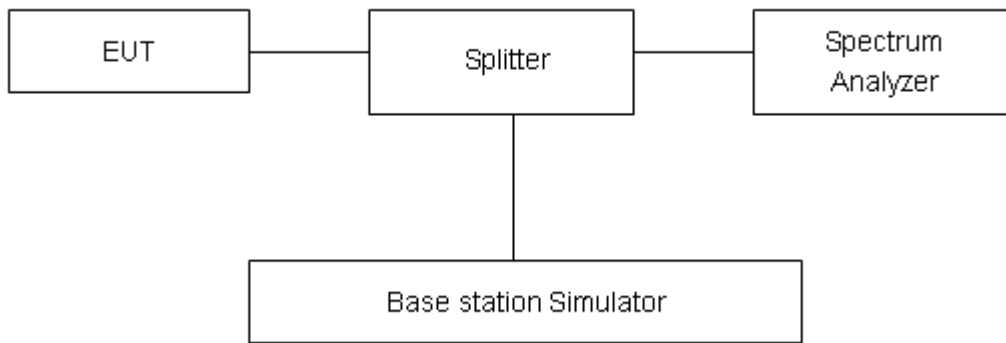

#### Limits

In measuring transmissions in this band using an average power technique, the peak-to-average ratio (PAR) of the transmission may not exceed 13 dB in 24.232(d).

#### Measurement Uncertainty

The assessed measurement uncertainty to ensure 95% confidence level for the normal distribution is with the coverage factor  $k = 2$ ,  $U = 0.4$  dB.





## Test Results

Mode	Channel	Frequency (MHz)	Peak(dBm)	Avg(dBm)	PAPR(dB)	Limit(dB)	Conclusion
WCDMA Band II (RMC)	9262	1852.4	26.20	23.19	3.01	≤13	PASS
	9400	1880	26.14	23.05	3.09	≤13	PASS
	9538	1907.6	26.15	23.04	3.11	≤13	PASS

LTE Band 2								
Modulation	Bandwidth (MHz)	Channel	Frequency (MHz)	Peak (dBm)	Avg (dBm)	PAPR (dB)	Limit (dB)	Conclusion
QPSK	1.4	18607	1850.7	27.15	22.23	4.92	≤13	PASS
		18900	1880.0	27.66	22.49	5.17	≤13	PASS
		19193	1909.3	27.20	22.07	5.13	≤13	PASS
	3	18615	1851.5	27.28	22.26	5.02	≤13	PASS
		18900	1880	27.76	22.53	5.23	≤13	PASS
		19185	1908.5	27.24	22.10	5.14	≤13	PASS
	5	18625	1852.5	27.29	22.24	5.05	≤13	PASS
		18900	1880	27.72	22.52	5.20	≤13	PASS
		19175	1907.5	27.20	22.08	5.12	≤13	PASS
	10	18650	1855	27.37	22.32	5.05	≤13	PASS
		18900	1880	27.69	22.54	5.15	≤13	PASS
		19150	1905	27.14	22.12	5.02	≤13	PASS
	15	18675	1857.5	27.41	22.30	5.11	≤13	PASS
		18900	1880	27.75	22.50	5.25	≤13	PASS
		19125	1902.5	27.08	22.07	5.01	≤13	PASS
20	18700	1860	27.29	22.27	5.02	≤13	PASS	
	18900	1880	27.53	22.45	5.08	≤13	PASS	
	19100	1900	26.92	22.03	4.89	≤13	PASS	
16QAM	1.4	18607	1850.7	27.15	21.36	5.79	≤13	PASS
		18900	1880.0	27.27	21.29	5.98	≤13	PASS
		19193	1909.3	27.33	21.30	6.03	≤13	PASS
	3	18615	1851.5	27.25	21.39	5.86	≤13	PASS
		18900	1880	27.37	21.33	6.04	≤13	PASS
		19185	1908.5	27.29	21.33	5.96	≤13	PASS
	5	18625	1852.5	27.19	21.37	5.82	≤13	PASS
		18900	1880	27.28	21.29	5.99	≤13	PASS
		19175	1907.5	27.20	21.28	5.92	≤13	PASS
	10	18650	1855	27.25	21.40	5.85	≤13	PASS
		18900	1880	27.28	21.34	5.94	≤13	PASS
		19150	1905	27.16	21.32	5.84	≤13	PASS



	15	18675	1857.5	27.21	21.37	5.84	≤13	PASS
		18900	1880	27.26	21.29	5.97	≤13	PASS
		19125	1902.5	26.99	21.28	5.71	≤13	PASS
	20	18700	1860	27.17	21.35	5.82	≤13	PASS
		18900	1880	27.16	21.25	5.91	≤13	PASS
		19100	1900	26.96	21.25	5.71	≤13	PASS

## 5.6. Frequency Stability

### Ambient condition

Temperature	Relative humidity	Pressure
23°C ~25°C	45%~50%	101.5kPa

### Method of Measurement

#### Frequency Stability (Temperature Variation)

The temperature inside the climate chamber is varied from -40°C to +85°C in 10°C step size,

(1) With all power removed, the temperature was decreased to 0°C and permitted to stabilize for three hours.

(2) Measure the carrier frequency with the test equipment in a “call mode”. These measurements should be made within 1 minute of powering up the mobile station, to prevent significant self warming.

(3) Repeat the above measurements at 10°C increments from -40°C to +85°C. Allow at least 1.5 hours at each temperature, un-powered, before making measurements.

#### Frequency Stability (Voltage Variation)

The frequency stability shall be measured with variation of primary supply voltage as follows:

(1) Vary primary supply voltage from 85 to 115 percent of the nominal value for other than hand carried battery equipment.

(2) For hand carried, battery powered equipment, reduce primary supply voltage to the battery-operating end point which shall be specified by the manufacturer.

This transceiver is specified to operate with an input voltage of between 3.3 V and 4.3V, with a nominal voltage of 3.8V.

### Test setup

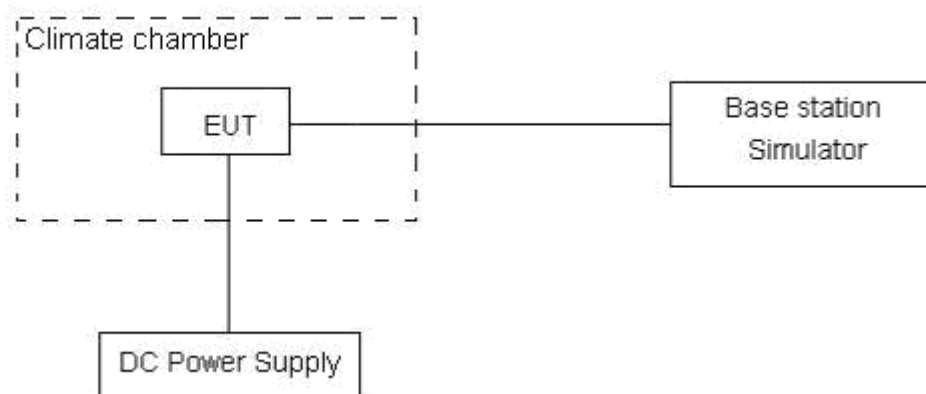



### **Limits**

No specific frequency stability requirements in part 24.235

### **Measurement Uncertainty**

The assessed measurement uncertainty to ensure 99.75% confidence level for the normal distribution is with the coverage factor  $k = 3$ ,  $U = 0.01\text{ppm}$ .



## Test Result

WCDMA Band II					
Condition		1850	1910	Delta(Hz)	Frequency Stability(ppm)
Temperature	Voltage	F low@-13dBm(MHz)	F high@-13dBm(MHz)		
Normal (25°C)	Normal	1850.0291	1909.9496	-1.78	-0.00095
Extreme (85°C)		1850.0301	1909.9482	-8.18	-0.00435
Extreme (80°C)		1850.0262	1909.9519	-3.97	-0.00211
Extreme (70°C)		1850.0281	1909.9543	1.47	0.00078
Extreme (60°C)		1850.0267	1909.9514	-4.27	-0.00227
Extreme (50°C)		1850.0273	1909.9508	-2.93	-0.00156
Extreme (40°C)		1850.0286	1909.9495	-1.19	-0.00063
Extreme (30°C)		1850.0293	1909.9488	-1.01	-0.00054
Extreme (20°C)		1850.0272	1909.9509	-1.09	-0.00058
Extreme (10C)		1850.0284	1909.9497	-3.50	-0.00186
Extreme (0°C)		1850.0271	1909.9514	-5.83	-0.00310
Extreme (-10°C)		1850.0266	1909.9515	-3.77	-0.00201
Extreme (-20°C)		1850.0277	1909.9504	0.31	0.00016
Extreme (-30°C)		1850.0312	1909.9471	-3.80	-0.00202
Extreme (-40°C)		1850.0322	1909.9459	1.15	0.00061
25°C	LV	1850.0274	1909.9507	-6.29	-0.00335
	HV	1850.0284	1909.9501	-2.78	-0.00148

LTE Band 2					
(QPSK, 20MHz BANDWIDTH)					
Condition		1850	1910	Delta(Hz)	Frequency Stability(ppm)
Temperature	Voltage	F low@-13dBm(MHz)	F high@-13dBm(MHz)		
Normal (25°C)	Normal	1850.6462	1909.4831	-1.29	-0.00069
Extreme (85°C)		1850.6471	1909.4827	-1.52	-0.00081
Extreme (80°C)		1850.6432	1909.4859	1.44	0.00077
Extreme (70°C)		1850.6451	1909.4845	0.86	0.00046
Extreme (60°C)		1850.6437	1909.4854	-2.69	-0.00143
Extreme (50°C)		1850.6443	1909.4848	-1.82	-0.00097
Extreme (40°C)		1850.6456	1909.4835	2.10	0.00112
Extreme (30°C)		1850.6463	1909.4828	0.86	0.00046
Extreme (20°C)		1850.6442	1909.4849	-0.07	-0.00004
Extreme (10C)		1850.6454	1909.4837	0.35	0.00019



Extreme (0°C)		1850.6441	1909.4857	-0.40	-0.00021
Extreme (-10°C)		1850.6436	1909.4855	-0.20	-0.00011
Extreme (-20°C)		1850.6447	1909.4844	0.56	0.00030
Extreme (-30°C)		1850.6483	1909.4811	-2.60	-0.00138
Extreme (-40°C)		1850.6492	1909.4799	-0.42	-0.00022
25°C	LV	1850.6444	1909.4847	1.26	0.00067
	HV	1850.6455	1909.4841	3.50	0.00186
(16QAM, 20MHz BANDWIDTH)					
Condition		1850	1910	Delta(Hz)	Frequency Stability(ppm)
Temperature	Voltage	F low@-13dBm(MHz)	F high@-13dBm(MHz)		
Normal (25°C)	Normal	1850.5825	1909.4472	-2.00	-0.00106
Extreme (85°C)		1850.5836	1909.4461	-0.91	-0.00048
Extreme (80°C)		1850.5797	1909.4523	-4.48	-0.00238
Extreme (70°C)		1850.5816	1909.4481	-2.62	-0.00139
Extreme (60°C)		1850.5802	1909.4495	-4.00	-0.00213
Extreme (50°C)		1850.5808	1909.4489	1.51	0.00080
Extreme (40°C)		1850.5821	1909.4476	0.79	0.00042
Extreme (30°C)		1850.5828	1909.4469	0.47	0.00025
Extreme (20°C)		1850.5807	1909.4491	-4.84	-0.00257
Extreme (10C)		1850.5819	1909.4478	-1.19	-0.00063
Extreme (0°C)		1850.5806	1909.4491	-4.88	-0.00260
Extreme (-10°C)		1850.5801	1909.4496	-3.63	-0.00193
Extreme (-20°C)		1850.5812	1909.4485	-0.77	-0.00041
Extreme (-30°C)		1850.5845	1909.4452	-2.98	-0.00159
Extreme (-40°C)			1850.5857	1909.4449	-4.68
25°C	LV	1850.5809	1909.4488	-4.04	-0.00215
	HV	1850.5815	1909.4482	-5.46	-0.00290

### 5.7. Spurious Emissions at Antenna Terminals

#### Ambient condition

Temperature	Relative humidity	Pressure
23°C ~25°C	45%~50%	101.5kPa

#### Method of Measurement

The EUT was connected to Spectrum Analyzer and Base Station Simulator via power Splitter. The measurement is carried out using a spectrum analyzer. The spectrum analyzer scans from 9kHz to the 10th harmonic of the carrier. The peak detector is used.

RBW is set to 100kHz, VBW is set to 300kHz for 30MHz~1GHz

RBW is set to 1MHz, VBW is set to 3MHz for above 1GHz, Sweep is set to ATUO.

The modulation mode and RB allocation refer to section 5.1, using the maximum output power configuration.

#### Test setup

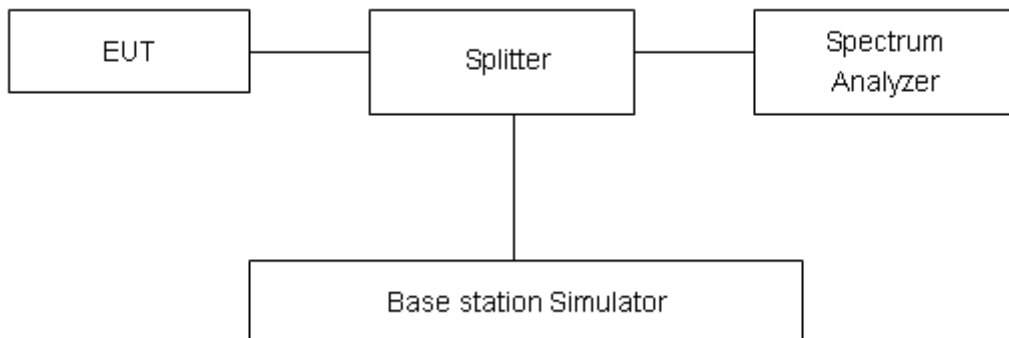

#### Limits

Rule Part 24.238(a) specifies that “on any frequency outside a licensee's frequency block, the power of any emission shall be attenuated below the transmitter power (P) by at least 43 + 10 log<sub>10</sub> (P) dB.”

Limit	-13 dBm
-------	---------

#### Measurement Uncertainty

The assessed measurement uncertainty to ensure 99.75% confidence level for the normal distribution is with the coverage factor  $k = 1.96$ .

Frequency	Uncertainty
9kHz-1GHz	0.684 dB
1GHz-20GHz	1.407 dB



### Test Result

Sweep the whole frequency band through the range from 9kHz to the 10th harmonic of the carrier, the emissions more than 20 dB below the limit are not reported.

The signal beyond the limit is carrier.

#### WCDMA Band II CH-Low 30MHz~1GHz

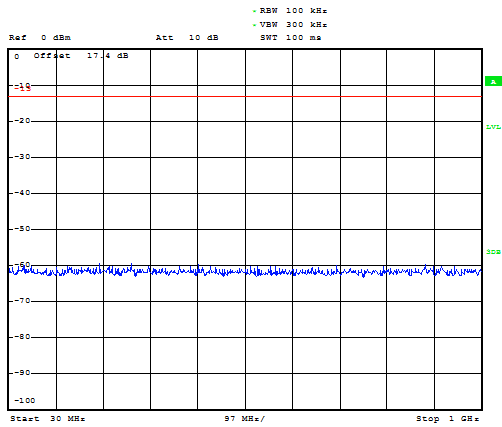

#### WCDMA Band II CH- Middle 30MHz~1GHz

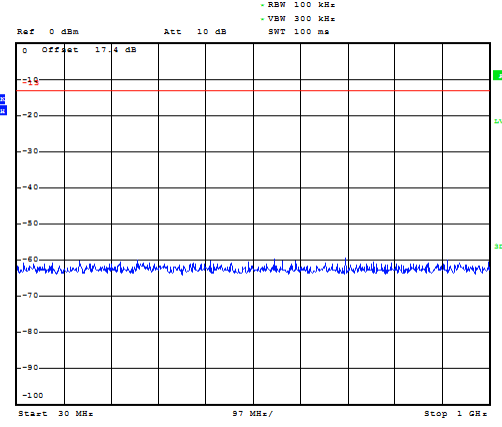

#### WCDMA BAND II CH-Low 1GHz~3GHz

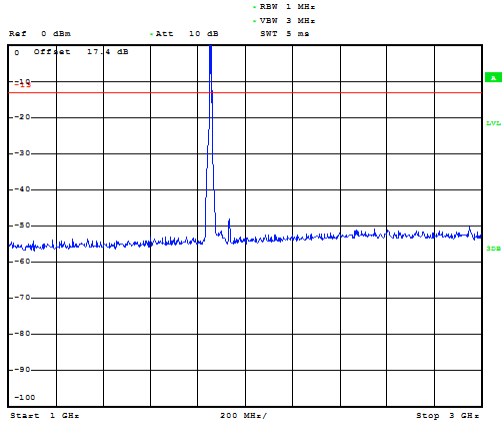

#### WCDMA BAND II CH-Middle 1GHz~3GHz

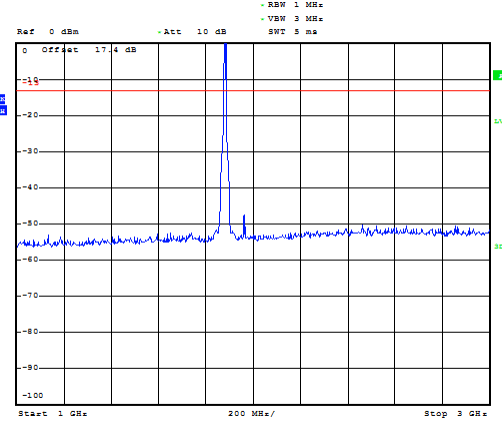

#### WCDMA BAND II CH-Low 3GHz~20GHz

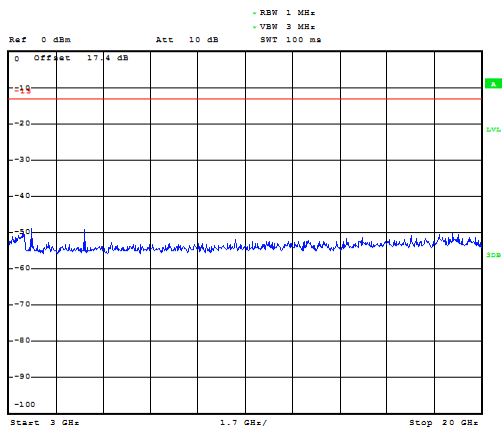

#### WCDMA BAND II CH-Middle 3GHz~20GHz

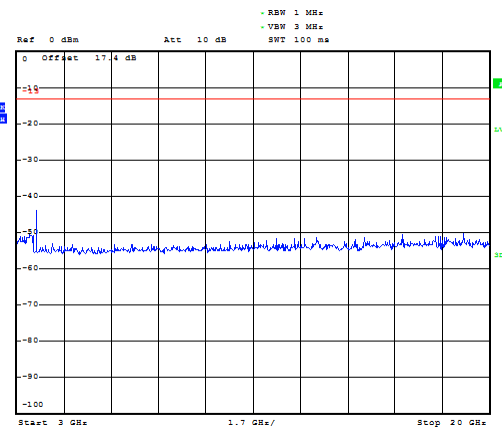





### WCDMA Band II CH- High 30MHz~1GHz

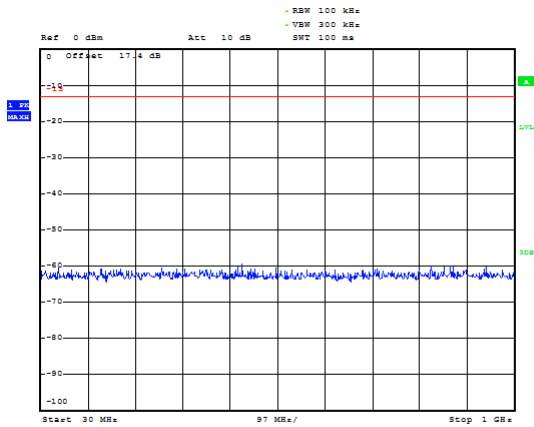

### WCDMA BAND II CH-High 1GHz~3GHz

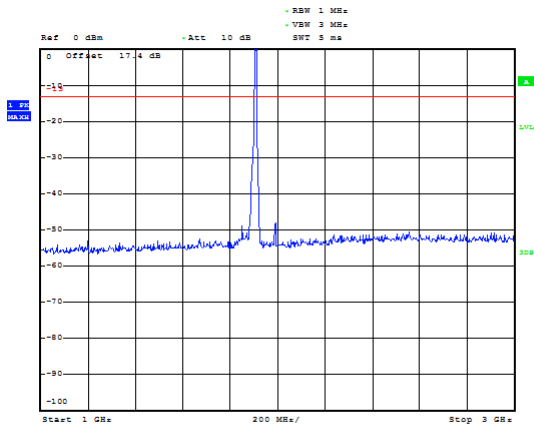

### WCDMA BAND II CH-High 3GHz~20GHz

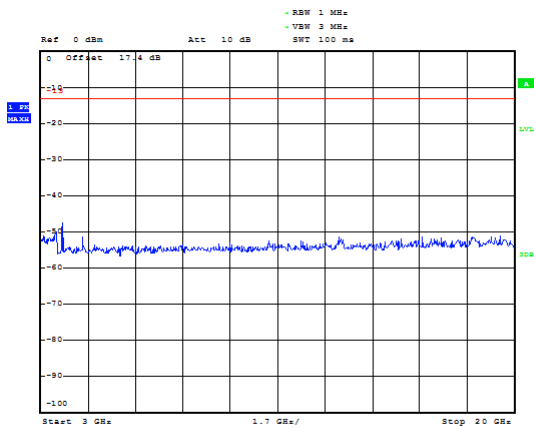



LTE Band 2 1.4MHz CH-Low 30MHz~1GHz

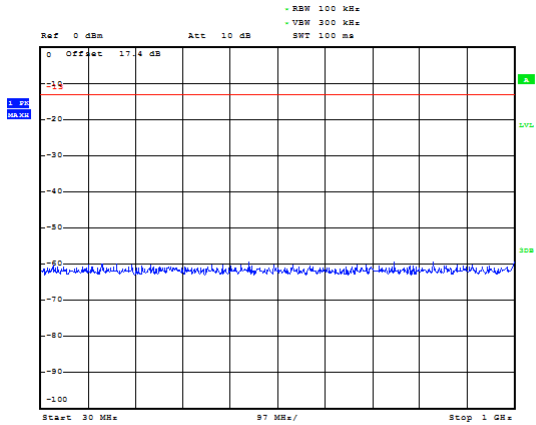

LTE Band 2 1.4MHz CH-Middle 30MHz~1GHz

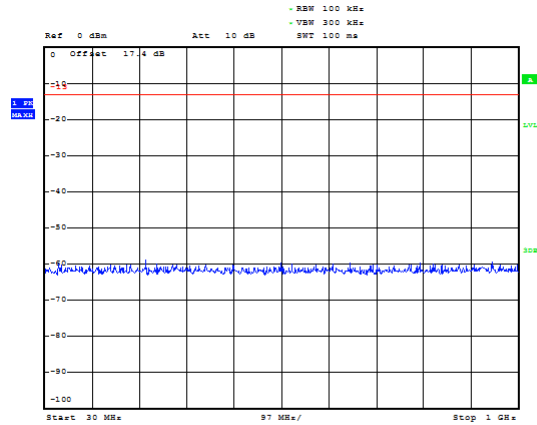

LTE Band 2 1.4MHz CH-Low 1GHz~3GHz

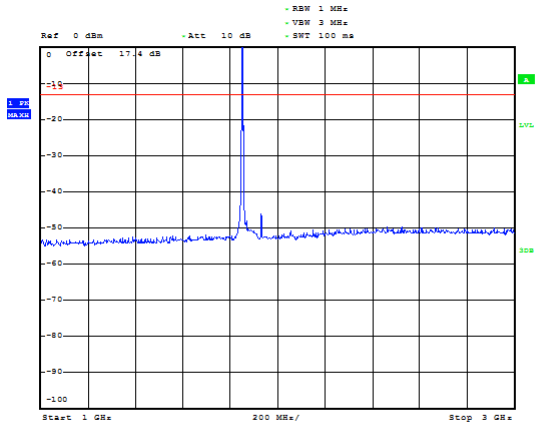

LTE Band 2 1.4MHz CH-Middle 1GHz~3GHz

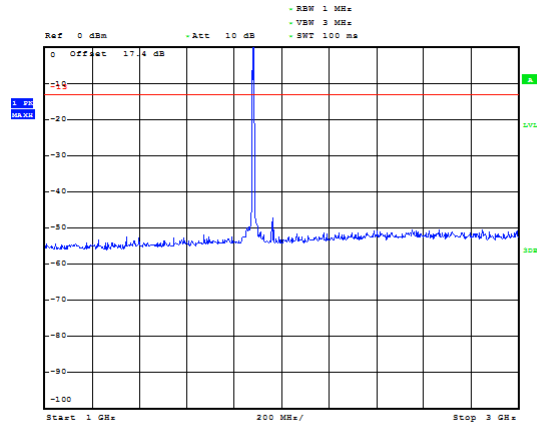

LTE Band 2 1.4MHz CH-Low 3GHz~20GHz

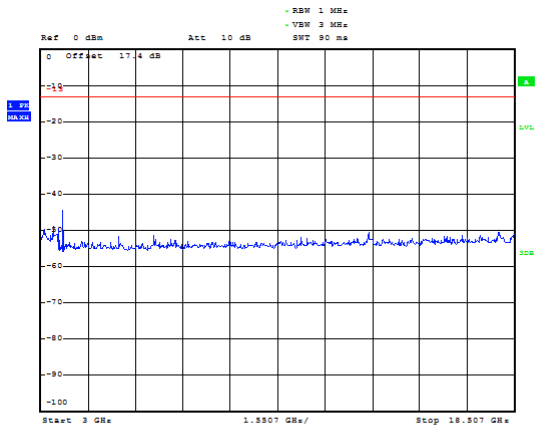

LTE Band 2 1.4MHz CH-Middle 3GHz~20GHz

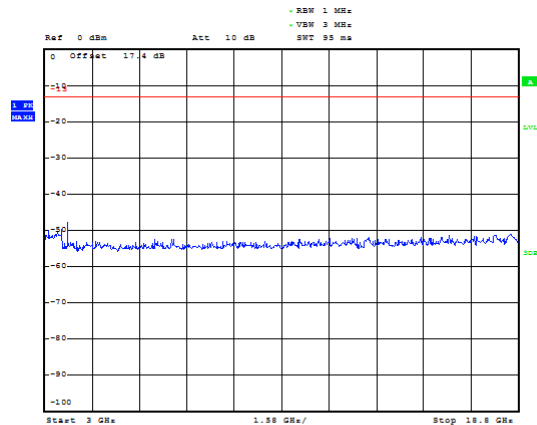



LTE Band 2 1.4MHz CH-High 30MHz~1GHz

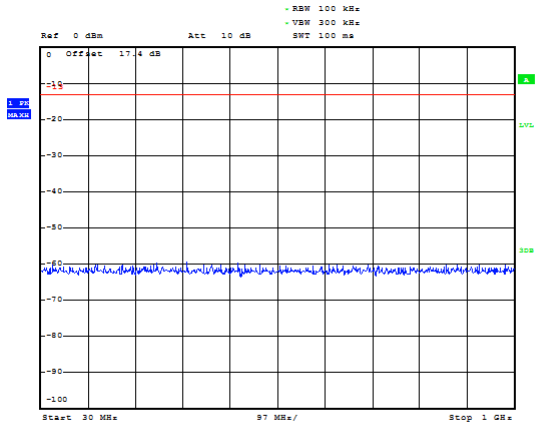

LTE Band 2 3MHz CH-Low 30MHz~1GHz

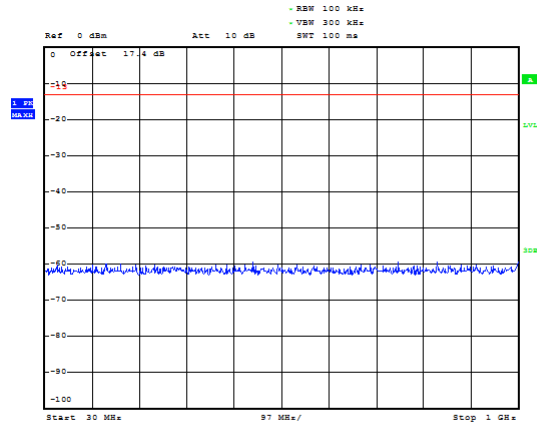

LTE Band 2 1.4MHz CH-High 1GHz~3GHz

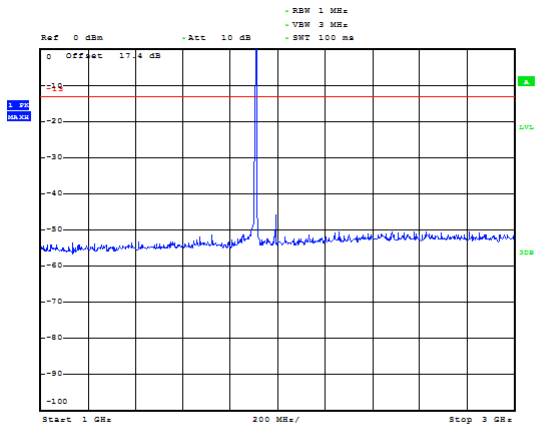

LTE Band 2 3MHz CH-Low 1GHz~3GHz

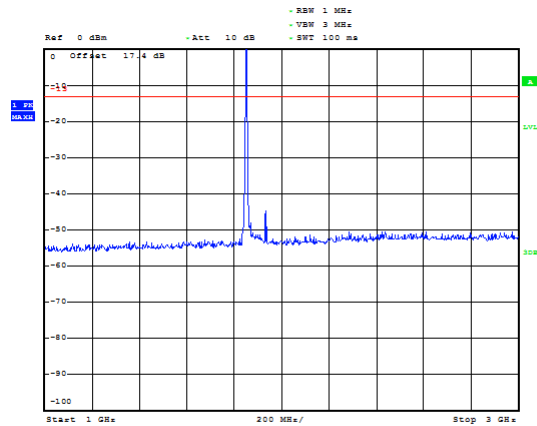

LTE Band 2 1.4MHz CH-High 3GHz~20GHz

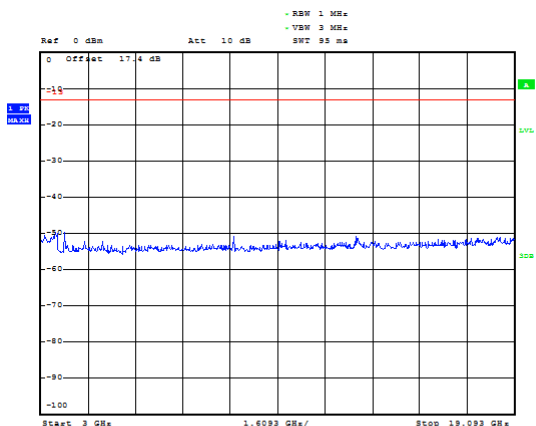

LTE Band 2 3MHz CH-Low 3GHz~20GHz

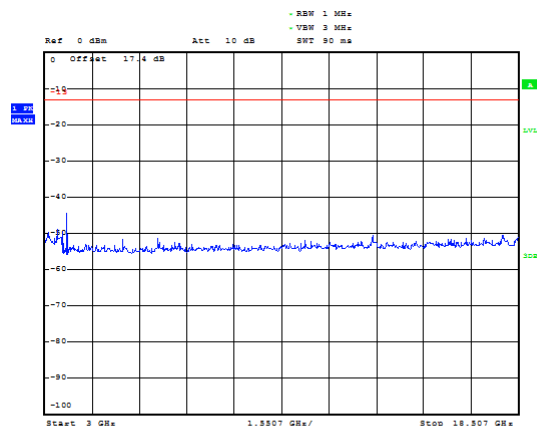



### LTE Band 2 3MHz CH-Middle 30MHz~1GHz

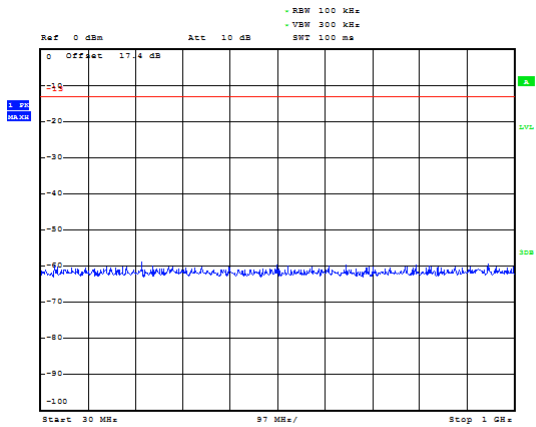

### LTE Band 2 3MHz CH-High 30MHz~1GHz

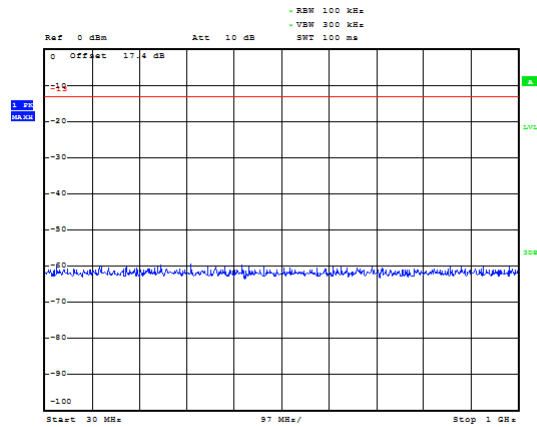

### LTE Band 2 3MHz CH-Middle 1GHz~3GHz

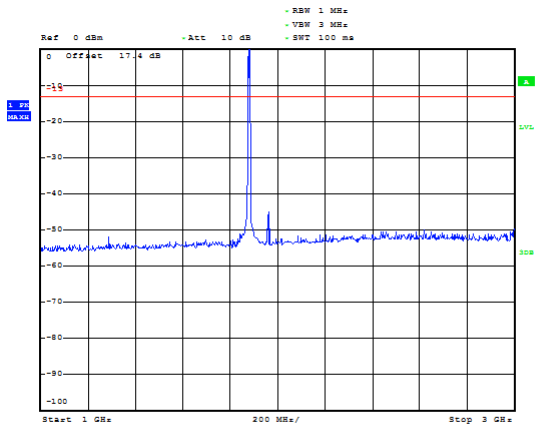

### LTE Band 2 3MHz CH-High 1GHz~3GHz

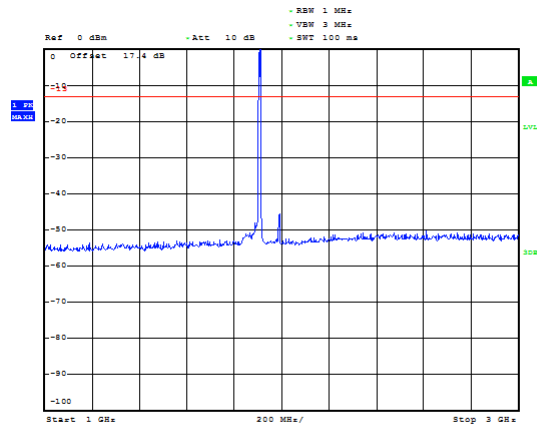

### LTE Band 2 3MHz CH-Middle 3GHz~20GHz

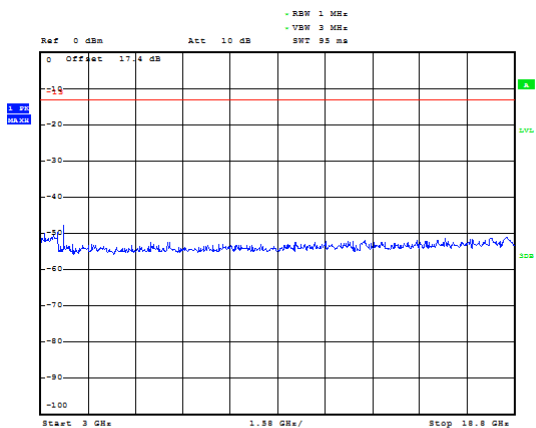

### LTE Band 2 3MHz CH-High 3GHz~20GHz

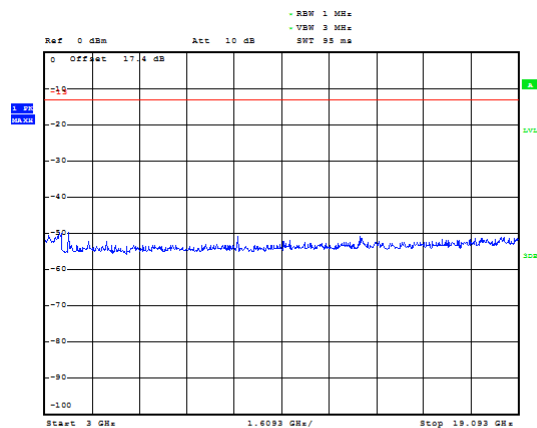



### LTE Band 2 5MHz CH-Low 30MHz~1GHz

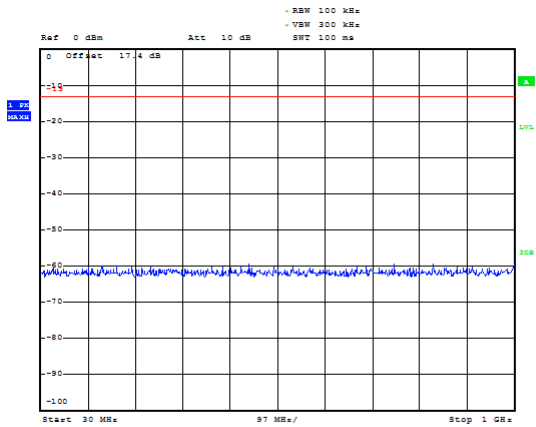

### LTE Band 2 5MHz CH-Middle 30MHz~1GHz

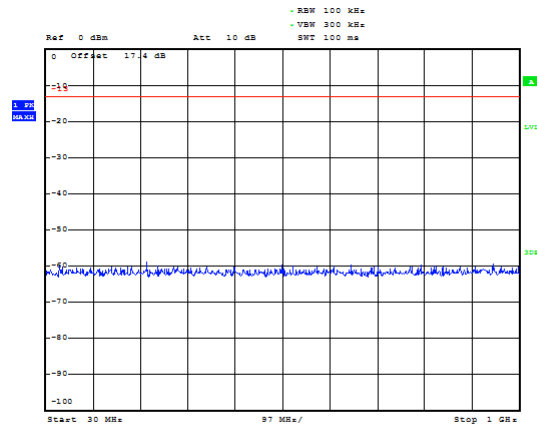

### LTE Band 2 5MHz CH-Low 1GHz~3GHz

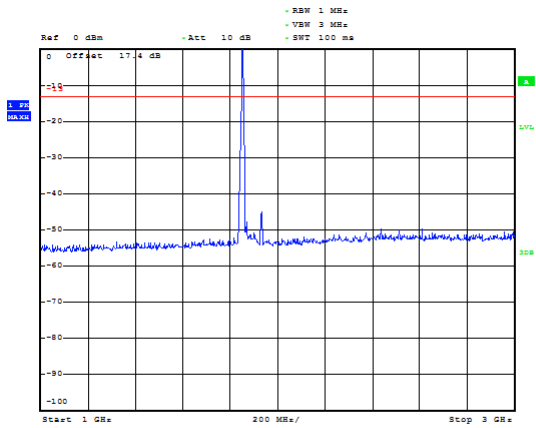

### LTE Band 2 5MHz CH-Middle 1GHz~3GHz

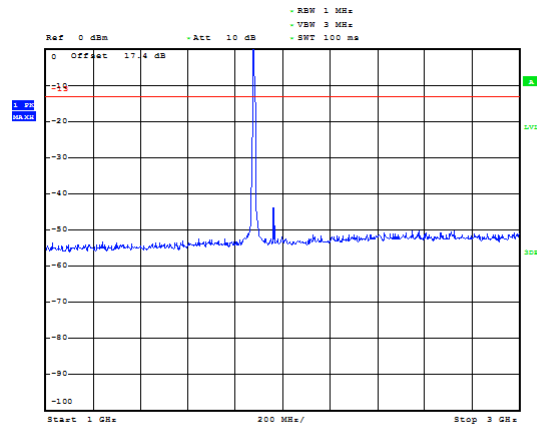

### LTE Band 2 5MHz CH-Low 3GHz~20GHz

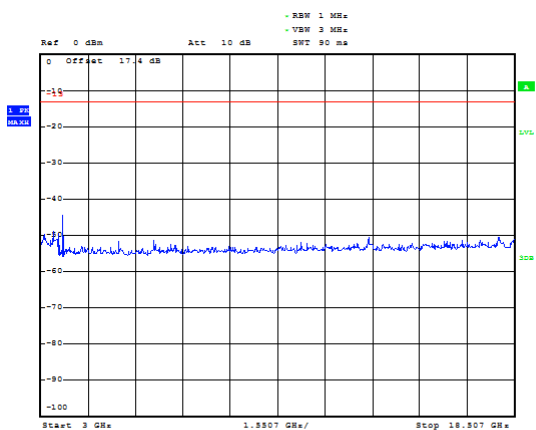

### LTE Band 2 5MHz CH-Middle 3GHz~20GHz

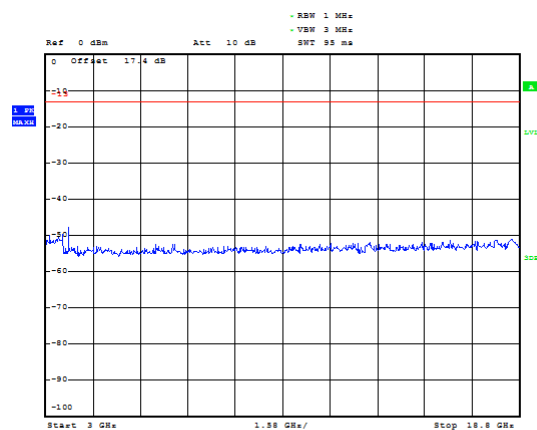



### LTE Band 2 5MHz CH-High 30MHz~1GHz

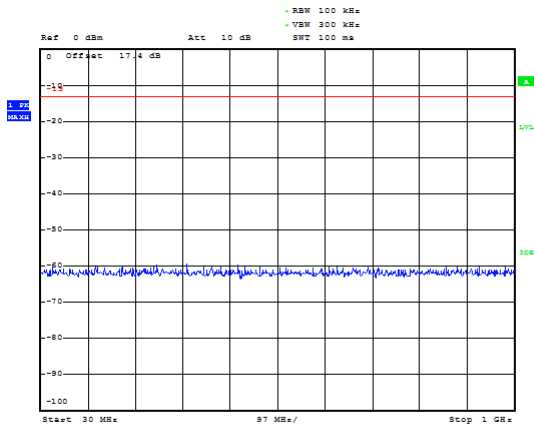

### LTE Band 2 10MHz CH-Low 30MHz~1GHz

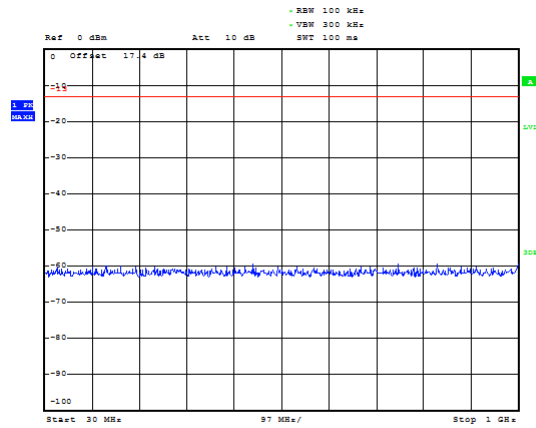

### LTE Band 2 5MHz CH-High 1GHz~3GHz

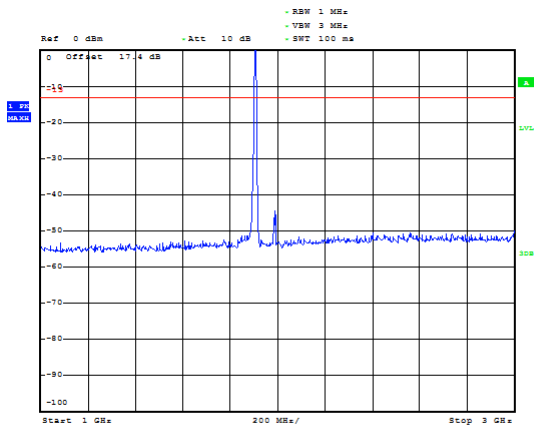

### LTE Band 2 10MHz CH-Low 1GHz~3GHz

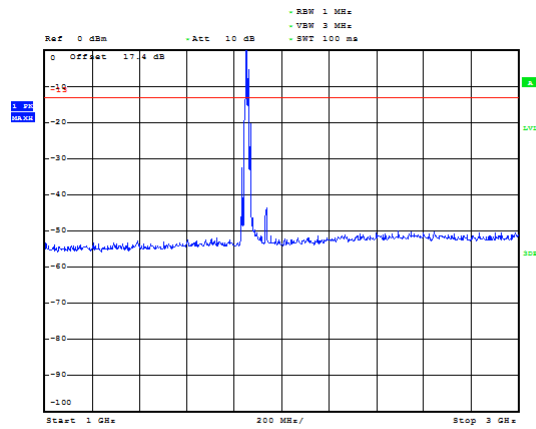

### LTE Band 2 5MHz CH-High 3GHz~20GHz

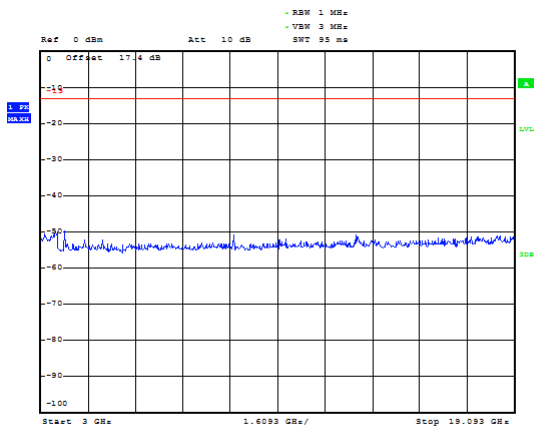

### LTE Band 2 10MHz CH-Low 3GHz~20GHz

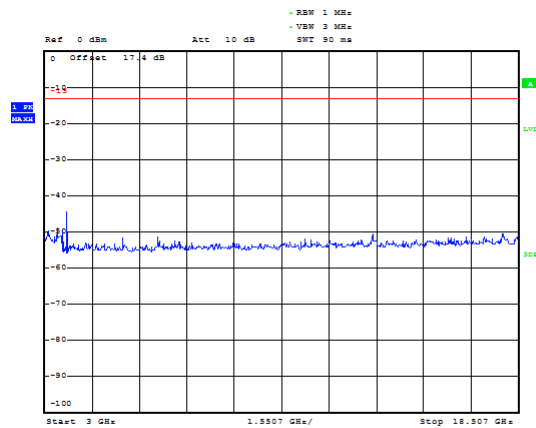



### LTE Band 2 10MHz CH-Middle 30MHz~1GHz

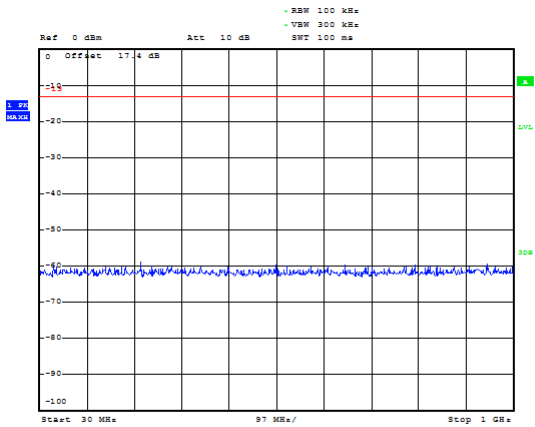

### LTE Band 2 10MHz CH-High 30MHz~1GHz

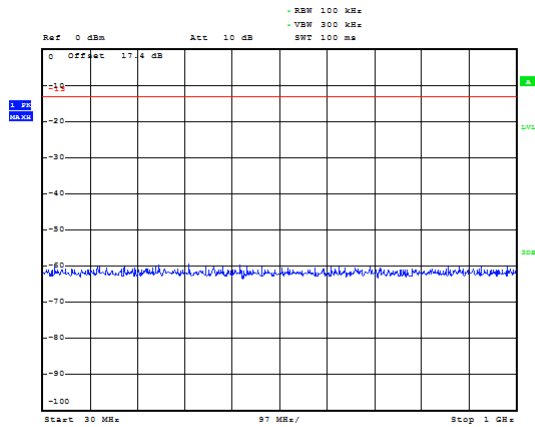

### LTE Band 2 10MHz CH-Middle 1GHz~3GHz

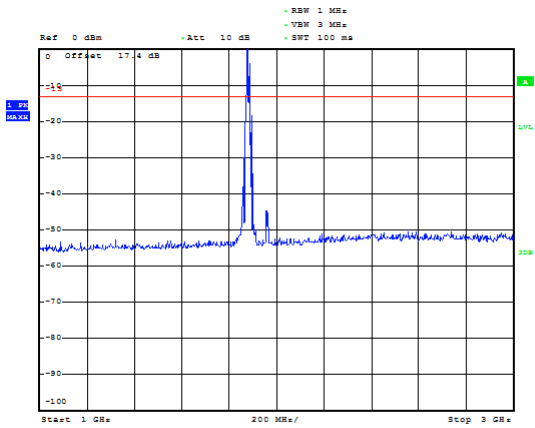

### LTE Band 2 10MHz CH-High 1GHz~3GHz

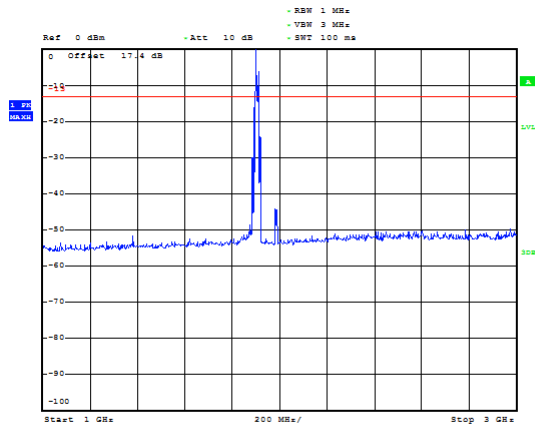

### LTE Band 2 10MHz CH-Middle 3GHz~20GHz

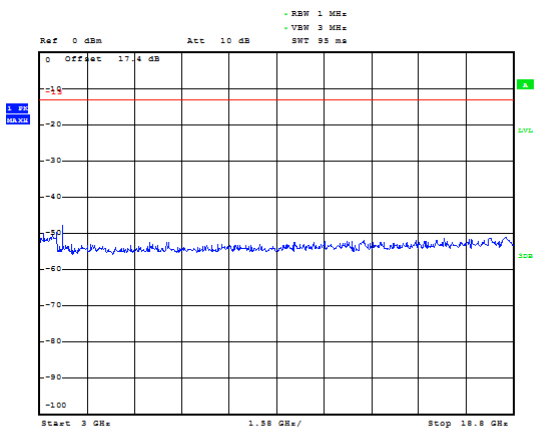

### LTE Band 2 10MHz CH-High 3GHz~20GHz

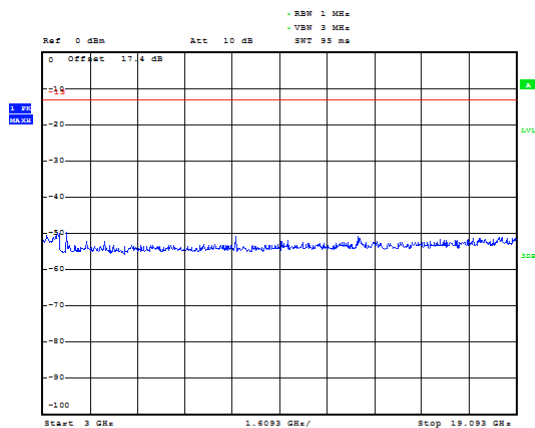



LTE Band 2 15MHz CH-Low 30MHz~1GHz

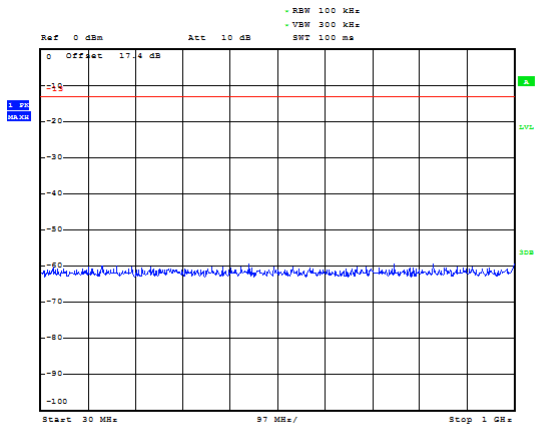

LTE Band 2 15MHz CH-Middle 30MHz~1GHz

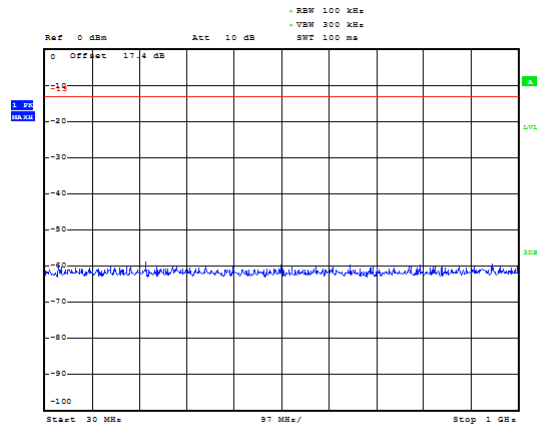

LTE Band 2 15MHz CH-Low 1GHz~3GHz

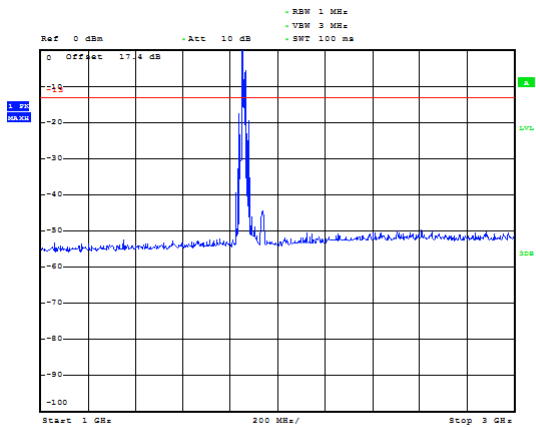

LTE Band 2 15MHz CH-Middle 1GHz~3GHz

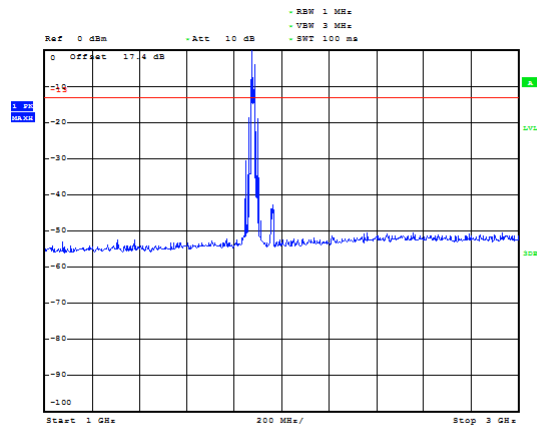

LTE Band 2 15MHz CH-Low 3GHz~20GHz

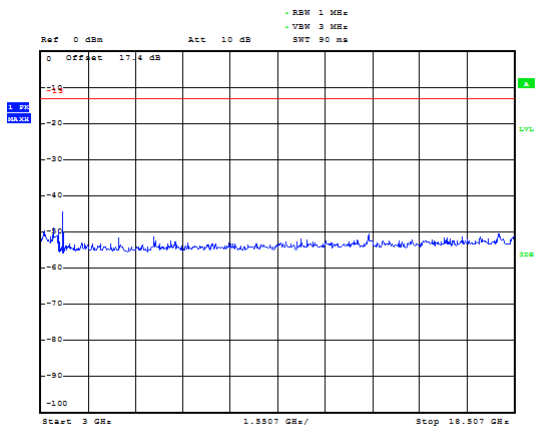

LTE Band 2 15MHz CH-Middle 3GHz~20GHz

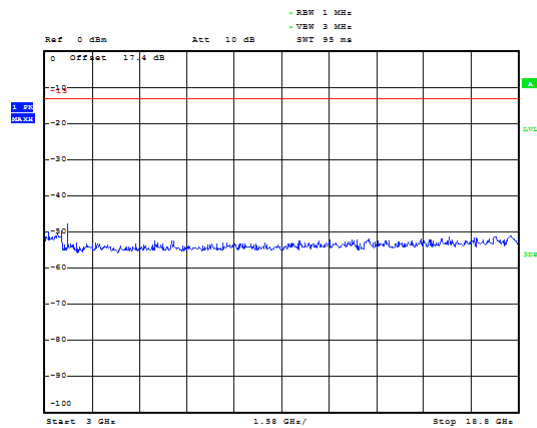





### LTE Band 2 15MHz CH-High 30MHz~1GHz

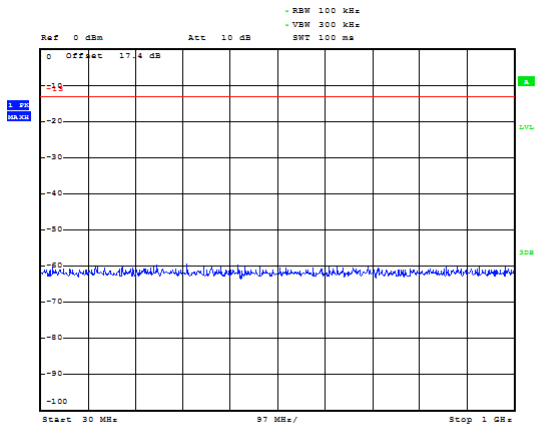

### LTE Band 2 20MHz CH-Low 30MHz~1GHz

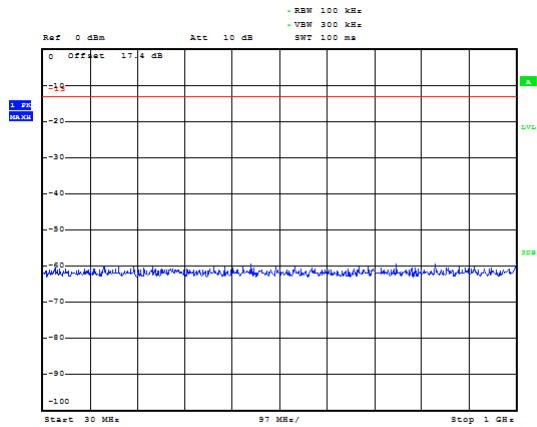

### LTE Band 2 15MHz CH-High 1GHz~3GHz

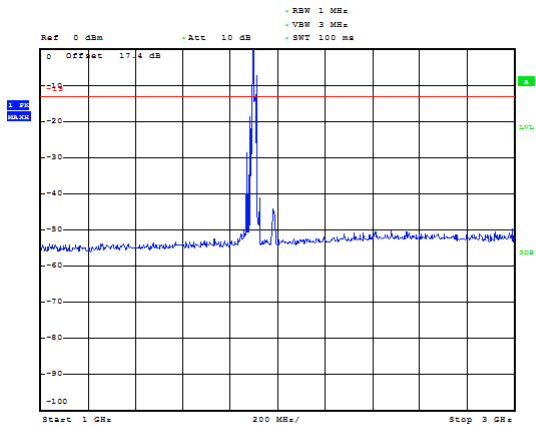

### LTE Band 2 20MHz CH-Low 1GHz~3GHz

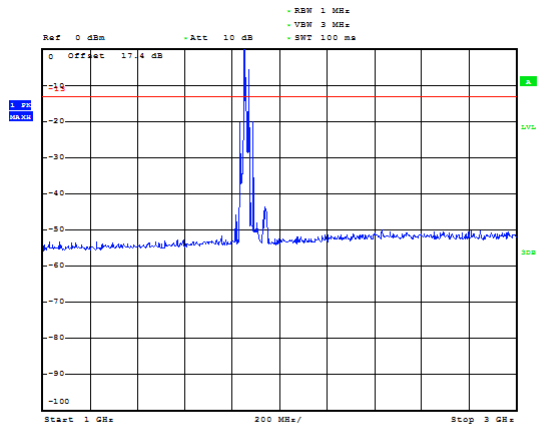

### LTE Band 2 15MHz CH-High 3GHz~20GHz

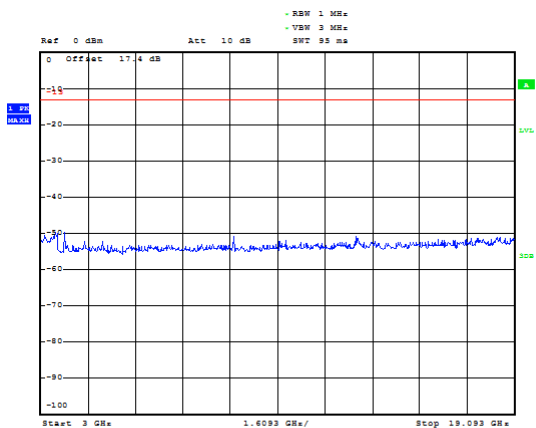

### LTE Band 2 20MHz CH-Low 3GHz~20GHz

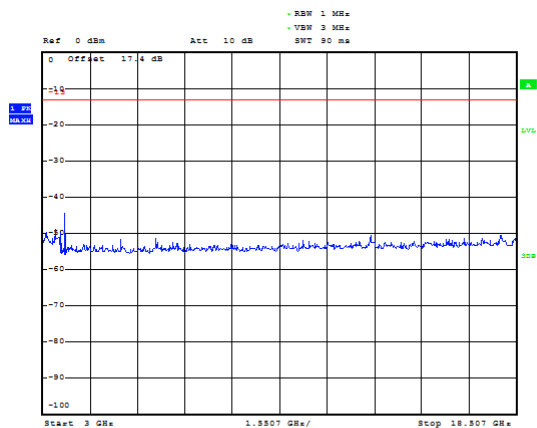



LTE Band 2 20MHz CH-Middle 30MHz~1GHz

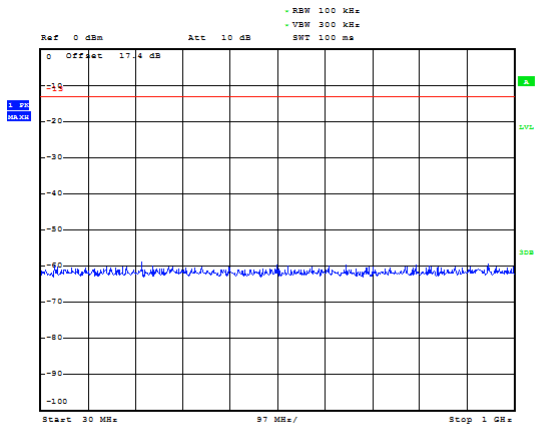

LTE Band 2 20MHz CH-High 30MHz~1GHz

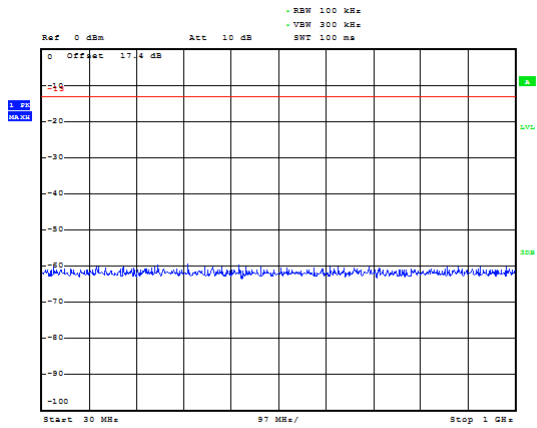

LTE Band 2 20MHz CH-Middle 1GHz~3GHz

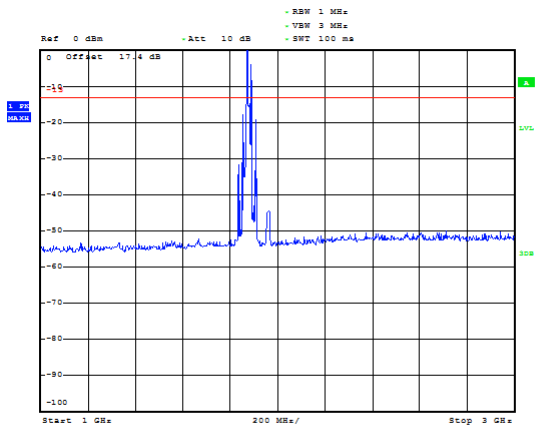

LTE Band 2 20MHz CH-High 1GHz~3GHz

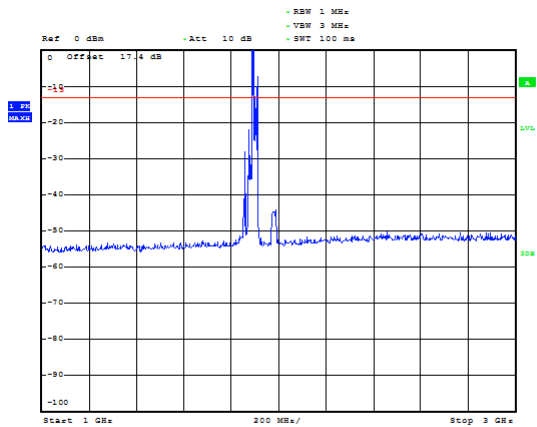

LTE Band 2 20MHz CH-Middle 3GHz~20GHz

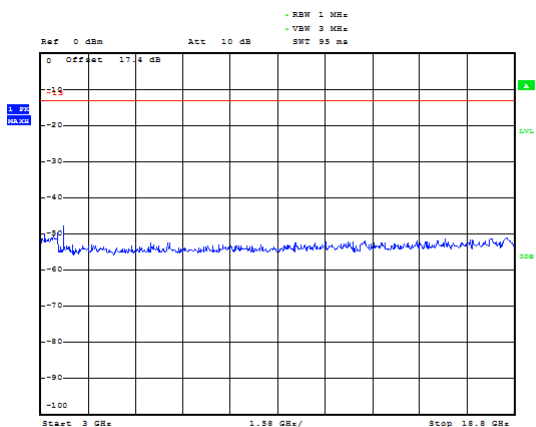

LTE Band 2 20MHz CH-High 3GHz~20GHz

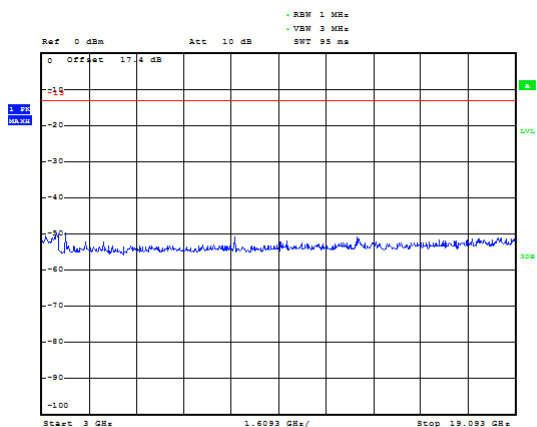

## 5.8. Radiates Spurious Emission

### Ambient condition

Temperature	Relative humidity	Pressure
23°C ~25°C	45%~50%	101.5kPa

### Method of Measurement

1. The testing follows FCC KDB 971168 v03r01 Section 5.8 and ANSI/TIA-603-E (2016).
2. The EUT is placed on a turntable 0.8 meters above the ground in the chamber, 3 meter away from the antenna. The maximal emission value is acquired by adjusting the antenna height, polarisation and turntable azimuth. Normally, the height range of antenna is 1 m to 4 m, the azimuth range of turntable is 0° to 360°, and the receive antenna has two polarizations Vertical (V) and Horizontal (H).
3. A log-periodic antenna or double-ridged waveguide horn antenna shall be substituted in place of the EUT. The log-periodic antenna will be driven by a signal generator and the level will be adjusted till the same power value on the spectrum analyzer or receiver. The level of the spurious emissions can be calculated through the level of the signal generator, cable loss, the gain of the substitution antenna and the reading of the spectrum analyzer or receiver.
4. The EUT is then put into continuously transmitting mode at its maximum power level during the test. Set Test Receiver or Spectrum RBW=1MHz, VBW=3MHz, And the maximum value of the receiver should be recorded as (Pr).
5. The EUT shall be replaced by a substitution antenna. In the chamber, an substitution antenna for the frequency band of interest is placed at the reference point of the chamber. An RF Signal source for the frequency band of interest is connected to the substitution antenna with a cable that has been constructed to not interfere with the radiation pattern of the antenna. A power (PMea) is applied to the input of the substitution antenna, and adjust the level of the signal generator output until the value of the receiver reach the previously recorded (Pr). The power of signal source (PMea) is recorded. The test should be performed by rotating the test item and adjusting the receiving antenna polarization.
6. A amplifier should be connected to the Signal Source output port. And the cable should be connect between the Amplifier and the Substitution Antenna. The cable loss (Pcl), the Substitution Antenna Gain (Ga) and the Amplifier Gain (PAg) should be recorded after test.
7. The measurement results are obtained as described below:  
$$\text{Power(EIRP)} = \text{PMea} - \text{PAg} - \text{Pcl} + \text{Ga}$$
  
The measurement results are amend as described below:  
$$\text{Power(EIRP)} = \text{PMea} - \text{Pcl} + \text{Ga}$$
8. This value is EIRP since the measurement is calibrated using an antenna of known gain (2.15 dBi) and known input power. ERP can be calculated from EIRP by subtracting the gain of the dipole,  $\text{ERP} = \text{EIRP} - 2.15\text{dBi}$ .

The modulation mode and RB allocation refer to section 5.1, using the maximum output power configuration.

**Test setup**

**30MHz~~~ 1GHz**

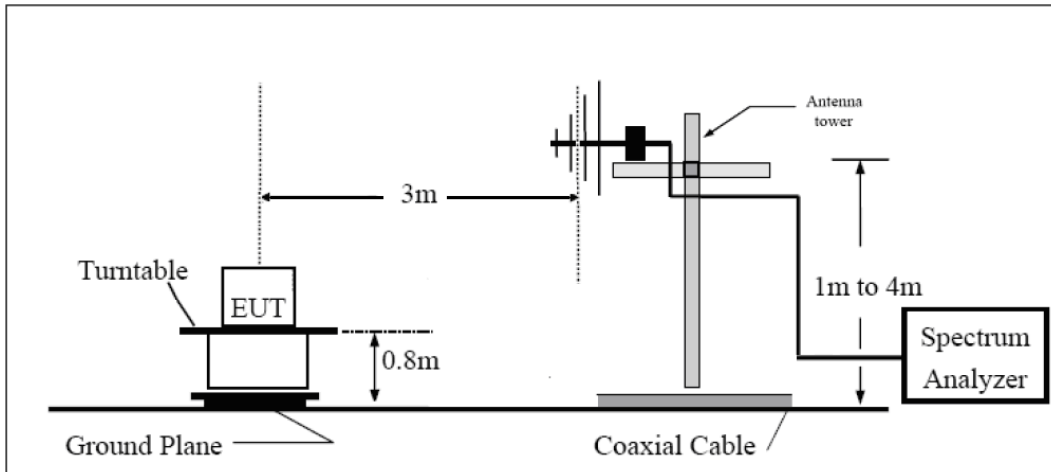

**Above 1GHz**

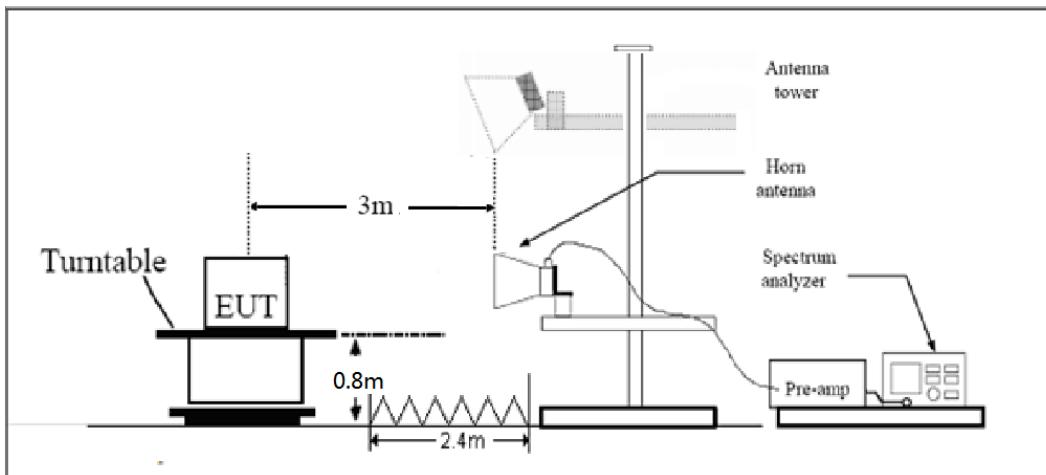

Note: Area side: 2.4mX3.6m

The radiated emission was measured in the following position: EUT stand-up position (Z axis), lie-down position (X, Y axis). The worst emission was found in lie-down position (X axis) and the worst case was recorded.

**Limits**

Rule Part 24.238(a) specifies that “on any frequency outside a licensee's frequency block, the power of any emission shall be attenuated below the transmitter power (P) by at least 43 + 10 log10 (P) dB.”

Limit	-13 dBm
-------	---------

**Measurement Uncertainty**

The assessed measurement uncertainty to ensure 95% confidence level for the normal distribution is with the coverage factor  $k = 1.96$ ,  $U = 3.55$  dB.

**Test Result**

Sweep the whole frequency band through the range from 30MHz to the 10th harmonic of the carrier, the emissions below the noise floor will not be recorded in the report.

**EC25-AF**

## WCDMA Band II CH-Low

Harmonic	Frequency (MHz)	SG (dBm)	Cable Loss (dB)	Gain (dBi)	Antenna Polarization	EIRP Level (dBm)	Limit (dBm)	Margin (dB)	Azimuth (deg)
2	3704.8	-56.67	5.1	11.05	Horizontal	-50.72	-13.00	37.72	180
3	5557.2	-55.71	5.42	12.65	Horizontal	-48.48	-13.00	35.48	270
4	7409.6	-36.08	6.7	13.85	Horizontal	-28.93	-13.00	15.93	135
5	9262.0	-42.56	7.01	14.75	Horizontal	-34.82	-13.00	21.82	45
6	11114.4	-51.49	7.48	15.95	Horizontal	-43.02	-13.00	30.02	270
7	12966.8	-50.49	7.51	16.55	Horizontal	-41.45	-13.00	28.45	180
8	14819.2	-45.99	8.24	15.35	Horizontal	-38.88	-13.00	25.88	270
9	16671.6	-46.87	8.41	14.95	Horizontal	-40.33	-13.00	27.33	135
10	18524.0	-	-	-	-	-	-	-	-

Note: 1.The other Spurious RF Radiated emissions level is no more than noise floor.

2. The worst emission was found in the antenna is Horizontal position.

## WCDMA Band II CH-Middle

Harmonic	Frequency (MHz)	SG (dBm)	Cable Loss (dB)	Gain (dBi)	Antenna Polarization	EIRP Level (dBm)	Limit (dBm)	Margin (dB)	Azimuth (deg)
2	3760.0	-57.99	5.1	11.05	Horizontal	-52.04	-13.00	39.04	270
3	5640.0	-56.91	5.42	12.65	Horizontal	-49.68	-13.00	36.68	135
4	7520.0	-37.80	6.7	13.85	Horizontal	-30.65	-13.00	17.65	45
5	9400.0	-45.56	7.01	14.75	Horizontal	-37.82	-13.00	24.82	270
6	11280.0	-51.26	7.48	15.95	Horizontal	-42.79	-13.00	29.79	180
7	13160.0	-51.87	7.51	16.55	Horizontal	-42.83	-13.00	29.83	270
8	15040.0	-48.74	8.24	15.35	Horizontal	-41.63	-13.00	28.63	135
9	16920.0	-46.53	8.41	14.95	Horizontal	-39.99	-13.00	26.99	180
10	18800.0	-	-	-	-	-	-	-	-

Note: 1.The other Spurious RF Radiated emissions level is no more than noise floor.

2. The worst emission was found in the antenna is Horizontal position.

WCDMA Band II CH-High

Harmonic	Frequency (MHz)	SG (dBm)	Cable Loss (dB)	Gain (dBi)	Antenna Polarization	EIRP Level (dBm)	Limit (dBm)	Margin (dB)	Azimuth (deg)
2	3813.8	-55.94	5.1	11.05	Horizontal	-49.99	-13.00	36.99	135
3	5722.8	-51.48	5.42	12.65	Horizontal	-44.25	-13.00	31.25	45
4	7630.4	-37.39	6.7	13.85	Horizontal	-30.24	-13.00	17.24	270
5	9538.0	-48.07	7.01	14.75	Horizontal	-40.33	-13.00	27.33	180
6	11445.6	-51.16	7.48	15.95	Horizontal	-42.69	-13.00	29.69	270
7	13353.2	-50.26	7.51	16.55	Horizontal	-41.22	-13.00	28.22	135
8	15260.8	-48.53	8.24	15.35	Horizontal	-41.42	-13.00	28.42	225
9	17168.4	-47.17	8.41	14.95	Horizontal	-40.63	-13.00	27.63	90
10	19076.0	-	-	-	-	-	-	-	-

Note: 1. The other Spurious RF Radiated emissions level is no more than noise floor.  
 2. The worst emission was found in the antenna is Horizontal position.

LTE Band 2 1.4MHz CH-Low

Harmonic	Frequency (MHz)	SG (dBm)	Cable Loss (dB)	Gain (dBi)	Antenna Polarization	EIRP Level (dBm)	Limit (dBm)	Margin (dB)	Azimuth (deg)
2	3700.5	-46.98	5.1	11.05	Horizontal	-41.03	-13.00	28.03	90
3	5550.8	-54.08	5.42	12.65	Horizontal	-46.85	-13.00	33.85	315
4	7402.8	-32.11	6.7	13.85	Horizontal	-24.96	-13.00	11.96	270
5	9253.5	-35.86	7.01	14.75	Horizontal	-28.12	-13.00	15.12	180
6	11104.2	-50.80	7.48	15.95	Horizontal	-42.33	-13.00	29.33	45
7	12954.9	-49.75	7.51	16.55	Horizontal	-40.71	-13.00	27.71	225
8	14805.6	-45.74	8.24	15.35	Horizontal	-38.63	-13.00	25.63	90
9	16656.3	-43.37	8.41	14.95	Horizontal	-36.83	-13.00	23.83	315
10	18507.0	-	-	-	-	-	-	-	-

Note: 1. The other Spurious RF Radiated emissions level is no more than noise floor.  
 2. The worst emission was found in the antenna is Horizontal position.



## LTE Band 2 1.4MHz CH-Middle

Harmonic	Frequency (MHz)	SG (dBm)	Cable Loss (dB)	Gain (dBi)	Antenna Polarization	EIRP Level (dBm)	Limit (dBm)	Margin (dB)	Azimuth (deg)
2	3759.0	-53.11	5.10	11.05	Horizontal	-47.16	-13.00	34.16	270
3	5638.9	-54.47	5.42	12.65	Horizontal	-47.24	-13.00	34.24	45
4	7520.0	-31.60	6.70	13.85	Horizontal	-24.45	-13.00	11.45	225
5	9400.0	-40.51	7.01	14.75	Horizontal	-32.77	-13.00	19.77	90
6	11280.0	-52.02	7.48	15.95	Horizontal	-43.55	-13.00	30.55	315
7	13160.0	-50.97	7.51	16.55	Horizontal	-41.93	-13.00	28.93	270
8	15040.0	-47.27	8.24	15.35	Horizontal	-40.16	-13.00	27.16	180
9	16920.0	-45.79	8.41	14.95	Horizontal	-39.25	-13.00	26.25	135
10	18800.0	-	-	-	-	-	-	-	-

Note: 1. The other Spurious RF Radiated emissions level is no more than noise floor.  
2. The worst emission was found in the antenna is Horizontal position.

## LTE Band 2 1.4MHz CH-High

Harmonic	Frequency (MHz)	SG (dBm)	Cable Loss (dB)	Gain (dBi)	Antenna Polarization	EIRP Level (dBm)	Limit (dBm)	Margin (dB)	Azimuth (deg)
2	3817.5	-52.68	5.10	11.05	Horizontal	-46.73	-13.00	33.73	270
3	5726.6	-50.29	5.42	12.65	Horizontal	-43.06	-13.00	30.06	180
4	7637.2	-33.03	6.70	13.85	Horizontal	-25.88	-13.00	12.88	135
5	9546.5	-42.50	7.01	14.75	Horizontal	-34.76	-13.00	21.76	45
6	11455.8	-50.00	7.48	15.95	Horizontal	-41.53	-13.00	28.53	225
7	13365.1	-50.39	7.51	16.55	Horizontal	-41.35	-13.00	28.35	90
8	15274.4	-47.90	8.24	15.35	Horizontal	-40.79	-13.00	27.79	315
9	17183.7	-44.28	8.41	14.95	Horizontal	-37.74	-13.00	24.74	225
10	19093.0	-	-	-	-	-	-	-	-

Note: 1. The other Spurious RF Radiated emissions level is no more than noise floor.  
2. The worst emission was found in the antenna is Horizontal position.



## LTE Band 2 5MHz CH-Low

Harmonic	Frequency (MHz)	SG (dBm)	Cable Loss (dB)	Gain (dBi)	Antenna Polarization	EIRP Level (dBm)	Limit (dBm)	Margin (dB)	Azimuth (deg)
2	3700.5	-56.37	5.10	11.05	Horizontal	-50.42	-13.00	37.42	180
3	5551.5	-56.19	5.42	12.65	Horizontal	-48.96	-13.00	35.96	135
4	7410.0	-38.43	6.70	13.85	Horizontal	-31.28	-13.00	18.28	45
5	9262.5	-41.49	7.01	14.75	Horizontal	-33.75	-13.00	20.75	225
6	11115.0	-51.53	7.48	15.95	Horizontal	-43.06	-13.00	30.06	90
7	12967.5	-50.31	7.51	16.55	Horizontal	-41.27	-13.00	28.27	315
8	14820.0	-45.32	8.24	15.35	Horizontal	-38.21	-13.00	25.21	315
9	16672.5	-46.72	8.41	14.95	Horizontal	-40.18	-13.00	27.18	225
10	18525.0	-	-	-	-	-	-	-	-

Note: 1.The other Spurious RF Radiated emissions level is no more than noise floor.  
2. The worst emission was found in the antenna is Horizontal position.

## LTE Band 2 5MHz CH-Middle

Harmonic	Frequency (MHz)	SG (dBm)	Cable Loss (dB)	Gain (dBi)	Antenna Polarization	EIRP Level (dBm)	Limit (dBm)	Margin (dB)	Azimuth (deg)
2	3755.6	-55.90	5.10	11.05	Horizontal	-49.95	-13.00	36.95	45
3	5633.6	-58.02	5.42	12.65	Horizontal	-50.79	-13.00	37.79	225
4	7520.0	-41.11	6.70	13.85	Horizontal	-33.96	-13.00	20.96	90
5	9400.0	-45.70	7.01	14.75	Horizontal	-37.96	-13.00	24.96	315
6	11280.0	-51.61	7.48	15.95	Horizontal	-43.14	-13.00	30.14	90
7	13160.0	-51.64	7.51	16.55	Horizontal	-42.60	-13.00	29.60	315
8	15040.0	-48.50	8.24	15.35	Horizontal	-41.39	-13.00	28.39	315
9	16920.0	-46.12	8.41	14.95	Horizontal	-39.58	-13.00	26.58	225
10	18800.0	-	-	-	-	-	-	-	-

Note: 1.The other Spurious RF Radiated emissions level is no more than noise floor.  
2. The worst emission was found in the antenna is Horizontal position.





## LTE Band 2 5MHz CH-High

Harmonic	Frequency (MHz)	SG (dBm)	Cable Loss (dB)	Gain (dBi)	Antenna Polarization	EIRP Level (dBm)	Limit (dBm)	Margin (dB)	Azimuth (deg)
2	3810.8	-55.98	5.10	11.05	Horizontal	-50.03	-13.00	37.03	135
3	5716.1	-54.46	5.42	12.65	Horizontal	-47.23	-13.00	34.23	45
4	7621.5	-39.83	6.70	13.85	Horizontal	-32.68	-13.00	19.68	225
5	9537.5	-48.19	7.01	14.75	Horizontal	-40.45	-13.00	27.45	90
6	11445.0	-50.09	7.48	15.95	Horizontal	-41.62	-13.00	28.62	315
7	13352.5	-50.18	7.51	16.55	Horizontal	-41.14	-13.00	28.14	315
8	15260.0	-47.24	8.24	15.35	Horizontal	-40.13	-13.00	27.13	180
9	17167.5	-45.86	8.41	14.95	Horizontal	-39.32	-13.00	26.32	225
10	19075.0	-	-	-	-	-	-	-	-

Note: 1. The other Spurious RF Radiated emissions level is no more than noise floor.  
2. The worst emission was found in the antenna is Horizontal position.

## LTE Band 2 20MHz CH-Low

Harmonic	Frequency (MHz)	SG (dBm)	Cable Loss (dB)	Gain (dBi)	Antenna Polarization	EIRP Level (dBm)	Limit (dBm)	Margin (dB)	Azimuth (deg)
2	3702.0	-53.05	5.10	11.05	Horizontal	-47.10	-13.00	34.10	45
3	5553.4	-53.79	5.42	12.65	Horizontal	-46.56	-13.00	33.56	225
4	7440.0	-31.79	6.70	13.85	Horizontal	-24.64	-13.00	11.64	90
5	9300.0	-35.13	7.01	14.75	Horizontal	-27.39	-13.00	14.39	45
6	11160.0	-51.44	7.48	15.95	Horizontal	-42.97	-13.00	29.97	225
7	13020.0	-50.79	7.51	16.55	Horizontal	-41.75	-13.00	28.75	90
8	14880.0	-46.46	8.24	15.35	Horizontal	-39.35	-13.00	26.35	315
9	16740.0	-43.61	8.41	14.95	Horizontal	-37.07	-13.00	24.07	180
10	18600.0	-	-	-	-	-	-	-	-

Note: 1. The other Spurious RF Radiated emissions level is no more than noise floor.  
2. The worst emission was found in the antenna is Horizontal position.



## LTE Band 2 20MHz CH-Middle

Harmonic	Frequency (MHz)	SG (dBm)	Cable Loss (dB)	Gain (dBi)	Antenna Polarization	EIRP Level (dBm)	Limit (dBm)	Margin (dB)	Azimuth (deg)
2	3742.1	-54.88	5.10	11.05	Horizontal	-48.93	-13.00	35.93	45
3	5613.4	-53.56	5.42	12.65	Horizontal	-46.33	-13.00	33.33	225
4	7484.6	-33.53	6.70	13.85	Horizontal	-26.38	-13.00	13.38	90
5	9400.0	-37.56	7.01	14.75	Horizontal	-29.82	-13.00	16.82	315
6	11280.0	-51.35	7.48	15.95	Horizontal	-42.88	-13.00	29.88	135
7	13160.0	-52.36	7.51	16.55	Horizontal	-43.32	-13.00	30.32	45
8	15040.0	-47.69	8.24	15.35	Horizontal	-40.58	-13.00	27.58	225
9	16920.0	-46.58	8.41	14.95	Horizontal	-40.04	-13.00	27.04	90
10	18800.0	-	-	-	-	-	-	-	-

Note: 1. The other Spurious RF Radiated emissions level is no more than noise floor.  
2. The worst emission was found in the antenna is Horizontal position.

## LTE Band 2 20MHz CH-High

Harmonic	Frequency (MHz)	SG (dBm)	Cable Loss (dB)	Gain (dBi)	Antenna Polarization	EIRP Level (dBm)	Limit (dBm)	Margin (dB)	Azimuth (deg)
2	3781.9	-53.97	5.10	11.05	Horizontal	-48.02	-13.00	35.02	180
3	5673.8	-52.04	5.42	12.65	Horizontal	-44.81	-13.00	31.81	135
4	7564.1	-33.34	6.70	13.85	Horizontal	-26.19	-13.00	39.19	45
5	9500.0	-40.10	7.01	14.75	Horizontal	-32.36	-13.00	19.36	225
6	11400.0	-50.69	7.48	15.95	Horizontal	-42.22	-13.00	29.22	90
7	13300.0	-50.76	7.51	16.55	Horizontal	-41.72	-13.00	28.72	315
8	15200.0	-47.73	8.24	15.35	Horizontal	-40.62	-13.00	27.62	315
9	17100.0	-43.24	8.41	14.95	Horizontal	-36.70	-13.00	23.70	225
10	19000.0	-	-	-	-	-	-	-	-

Note: 1. The other Spurious RF Radiated emissions level is no more than noise floor.  
2. The worst emission was found in the antenna is Horizontal position.

**EC25-AF MINIPCIE**

LTE Band 2 1.4MHz CH-Low

Harmonic	Frequency (MHz)	SG (dBm)	Cable Loss (dB)	Gain (dBi)	Antenna Polarization	EIRP Level (dBm)	Limit (dBm)	Margin (dB)	Azimuth (deg)
2	3700.1	-48.51	5.1	11.05	Horizontal	-42.56	-13.00	29.56	135
3	5550.7	-51.96	5.42	12.65	Horizontal	-44.73	-13.00	31.73	45
4	7167.0	-51.25	6.7	13.85	Horizontal	-44.10	-13.00	31.10	90
5	9253.5	-52.34	7.01	14.75	Horizontal	-44.60	-13.00	31.60	25
6	11104.2	-49.87	7.48	15.95	Horizontal	-41.40	-13.00	28.40	270
7	12954.9	-50.94	7.51	16.55	Horizontal	-41.90	-13.00	28.90	180
8	14805.6	-46.91	8.24	15.35	Horizontal	-39.80	-13.00	26.80	90
9	16656.3	-45.34	8.41	14.95	Horizontal	-38.80	-13.00	25.80	45
10	18507.0	-	-	-	-	-	-	-	-

Note: 1. The other Spurious RF Radiated emissions level is no more than noise floor.

2. The worst emission was found in the antenna is Horizontal position.

LTE Band 2 1.4MHz CH-Middle

Harmonic	Frequency (MHz)	SG (dBm)	Cable Loss (dB)	Gain (dBi)	Antenna Polarization	EIRP Level (dBm)	Limit (dBm)	Margin (dB)	Azimuth (deg)
2	3759.0	-46.05	5.10	11.05	Horizontal	-40.10	-13.00	27.10	90
3	5638.9	-53.03	5.42	12.65	Horizontal	-45.80	-13.00	32.80	135
4	7520.0	-53.95	6.70	13.85	Horizontal	-46.80	-13.00	33.80	225
5	9400.0	-55.24	7.01	14.75	Horizontal	-47.50	-13.00	34.50	135
6	11280.0	-49.77	7.48	15.95	Horizontal	-41.30	-13.00	28.30	90
7	13160.0	-49.54	7.51	16.55	Horizontal	-40.50	-13.00	27.50	45
8	15040.0	-46.71	8.24	15.35	Horizontal	-39.60	-13.00	26.60	180
9	16920.0	-45.24	8.41	14.95	Horizontal	-38.70	-13.00	25.70	270
10	18800.0	-	-	-	-	-	-	-	-

Note: 1. The other Spurious RF Radiated emissions level is no more than noise floor.

2. The worst emission was found in the antenna is Horizontal position.

LTE Band 2 1.4MHz CH-High

Harmonic	Frequency (MHz)	SG (dBm)	Cable Loss (dB)	Gain (dBi)	Antenna Polarization	EIRP Level (dBm)	Limit (dBm)	Margin (dB)	Azimuth (deg)
2	3817.5	-53.02	5.10	11.05	Horizontal	-47.07	-13.00	34.07	90
3	5726.6	-47.73	5.42	12.65	Horizontal	-40.50	-13.00	27.50	45
4	7637.2	-52.65	6.70	13.85	Horizontal	-45.50	-13.00	32.50	135
5	9546.5	-52.24	7.01	14.75	Horizontal	-44.50	-13.00	31.50	225
6	11455.8	-51.27	7.48	15.95	Horizontal	-42.80	-13.00	29.80	90
7	13365.1	-50.64	7.51	16.55	Horizontal	-41.60	-13.00	28.60	270
8	15274.4	-46.71	8.24	15.35	Horizontal	-39.60	-13.00	26.60	135
9	17183.7	-44.94	8.41	14.95	Horizontal	-38.40	-13.00	25.40	90
10	19093.0	-	-	-	-	-	-	-	-

Note: 1.The other Spurious RF Radiated emissions level is no more than noise floor.  
 2. The worst emission was found in the antenna is Horizontal position.

LTE Band 2 5MHz CH-Low

Harmonic	Frequency (MHz)	SG (dBm)	Cable Loss (dB)	Gain (dBi)	Antenna Polarization	EIRP Level (dBm)	Limit (dBm)	Margin (dB)	Azimuth (deg)
2	3700.5	-48.35	5.10	11.05	Horizontal	-42.40	-13.00	29.40	225
3	5551.5	-49.83	5.42	12.65	Horizontal	-42.60	-13.00	29.60	90
4	7410.0	-53.35	6.70	13.85	Horizontal	-46.20	-13.00	33.20	135
5	9262.5	-53.04	7.01	14.75	Horizontal	-45.30	-13.00	32.30	90
6	11115.0	-51.27	7.48	15.95	Horizontal	-42.80	-13.00	29.80	45
7	12967.5	-49.74	7.51	16.55	Horizontal	-40.70	-13.00	27.70	135
8	14820.0	-47.31	8.24	15.35	Horizontal	-40.20	-13.00	27.20	225
9	16672.5	-46.04	8.41	14.95	Horizontal	-39.50	-13.00	26.50	90
10	18525.0	-	-	-	-	-	-	-	-

Note: 1.The other Spurious RF Radiated emissions level is no more than noise floor.  
 2. The worst emission was found in the antenna is Horizontal position.



## LTE Band 2 5MHz CH-Middle

Harmonic	Frequency (MHz)	SG (dBm)	Cable Loss (dB)	Gain (dBi)	Antenna Polarization	EIRP Level (dBm)	Limit (dBm)	Margin (dB)	Azimuth (deg)
2	3755.6	-51.39	5.10	11.05	Horizontal	-45.44	-13.00	32.44	45
3	5633.6	-51.13	5.42	12.65	Horizontal	-43.90	-13.00	30.90	135
4	7520.0	-52.85	6.70	13.85	Horizontal	-45.70	-13.00	32.70	90
5	9400.0	-52.34	7.01	14.75	Horizontal	-44.60	-13.00	31.60	270
6	11280.0	-50.97	7.48	15.95	Horizontal	-42.50	-13.00	29.50	135
7	13160.0	-50.74	7.51	16.55	Horizontal	-41.70	-13.00	28.70	90
8	15040.0	-46.71	8.24	15.35	Horizontal	-39.60	-13.00	26.60	45
9	16920.0	-44.74	8.41	14.95	Horizontal	-38.20	-13.00	25.20	270
10	18800.0	-	-	-	-	-	-	-	-

Note: 1. The other Spurious RF Radiated emissions level is no more than noise floor.  
2. The worst emission was found in the antenna is Horizontal position.

## LTE Band 2 5MHz CH-High

Harmonic	Frequency (MHz)	SG (dBm)	Cable Loss (dB)	Gain (dBi)	Antenna Polarization	EIRP Level (dBm)	Limit (dBm)	Margin (dB)	Azimuth (deg)
2	3810.8	-53.85	5.10	11.05	Horizontal	-47.90	-13.00	34.90	135
3	5716.1	-47.13	5.42	12.65	Horizontal	-39.90	-13.00	26.90	90
4	7621.5	-54.65	6.70	13.85	Horizontal	-47.50	-13.00	34.50	45
5	9537.5	-54.24	7.01	14.75	Horizontal	-46.50	-13.00	33.50	270
6	11445.0	-51.17	7.48	15.95	Horizontal	-42.70	-13.00	29.70	225
7	13352.5	-50.34	7.51	16.55	Horizontal	-41.30	-13.00	28.30	90
8	15260.0	-47.31	8.24	15.35	Horizontal	-40.20	-13.00	27.20	135
9	17167.5	-45.14	8.41	14.95	Horizontal	-38.60	-13.00	25.60	180
10	19075.0	-	-	-	-	-	-	-	-

Note: 1. The other Spurious RF Radiated emissions level is no more than noise floor.  
2. The worst emission was found in the antenna is Horizontal position.



## LTE Band 2 20MHz CH-Low

Harmonic	Frequency (MHz)	SG (dBm)	Cable Loss (dB)	Gain (dBi)	Antenna Polarization	EIRP Level (dBm)	Limit (dBm)	Margin (dB)	Azimuth (deg)
2	3702.0	-47.15	5.10	11.05	Horizontal	-41.20	-13.00	28.20	180
3	5553.4	-49.23	5.42	12.65	Horizontal	-42.00	-13.00	29.00	90
4	7440.0	-55.81	6.70	13.85	Horizontal	-48.66	-13.00	35.66	45
5	9300.0	-53.04	7.01	14.75	Horizontal	-45.30	-13.00	32.30	270
6	11160.0	-51.17	7.48	15.95	Horizontal	-42.70	-13.00	29.70	135
7	13020.0	-49.34	7.51	16.55	Horizontal	-40.30	-13.00	27.30	90
8	14880.0	-48.81	8.24	15.35	Horizontal	-41.70	-13.00	28.70	135
9	16740.0	-46.24	8.41	14.95	Horizontal	-39.70	-13.00	26.70	45
10	18600.0	-	-	-	-	-	-	-	-

Note: 1. The other Spurious RF Radiated emissions level is no more than noise floor.  
2. The worst emission was found in the antenna is Horizontal position.

## LTE Band 2 20MHz CH-Middle

Harmonic	Frequency (MHz)	SG (dBm)	Cable Loss (dB)	Gain (dBi)	Antenna Polarization	EIRP Level (dBm)	Limit (dBm)	Margin (dB)	Azimuth (deg)
2	3742.1	-50.25	5.10	11.05	Horizontal	-44.30	-13.00	31.30	45
3	5613.4	-50.93	5.42	12.65	Horizontal	-43.70	-13.00	30.70	90
4	7484.6	-52.45	6.70	13.85	Horizontal	-45.30	-13.00	32.30	135
5	9400.0	-51.44	7.01	14.75	Horizontal	-43.70	-13.00	30.70	90
6	11280.0	-50.57	7.48	15.95	Horizontal	-42.10	-13.00	29.10	180
7	13160.0	-49.54	7.51	16.55	Horizontal	-40.50	-13.00	27.50	90
8	15040.0	-46.71	8.24	15.35	Horizontal	-39.60	-13.00	26.60	225
9	16920.0	-45.34	8.41	14.95	Horizontal	-38.80	-13.00	25.80	90
10	18800.0	-	-	-	-	-	-	-	-

Note: 1. The other Spurious RF Radiated emissions level is no more than noise floor.  
2. The worst emission was found in the antenna is Horizontal position.



## LTE Band 2 20MHz CH-High

Harmonic	Frequency (MHz)	SG (dBm)	Cable Loss (dB)	Gain (dBi)	Antenna Polarization	EIRP Level (dBm)	Limit (dBm)	Margin (dB)	Azimuth (deg)
2	3781.9	-50.26	5.10	11.05	Horizontal	-44.31	-13.00	31.31	135
3	5673.8	-49.13	5.42	12.65	Horizontal	-41.90	-13.00	28.90	90
4	7564.1	-54.25	6.70	13.85	Horizontal	-47.10	-13.00	34.10	225
5	9500.0	-53.04	7.01	14.75	Horizontal	-45.30	-13.00	32.30	90
6	11400.0	-51.17	7.48	15.95	Horizontal	-42.70	-13.00	29.70	180
7	13300.0	-49.54	7.51	16.55	Horizontal	-40.50	-13.00	27.50	270
8	15200.0	-46.71	8.24	15.35	Horizontal	-39.60	-13.00	26.60	45
9	17100.0	-44.94	8.41	14.95	Horizontal	-38.40	-13.00	25.40	90
10	19000.0	-	-	-	-	-	-	-	-

Note: 1. The other Spurious RF Radiated emissions level is no more than noise floor.

2. The worst emission was found in the antenna is Horizontal position.



## 6. Main Test Instruments

Name	Manufacturer	Type	Serial Number	Calibration Date	Expiration Date
Base Station Simulator	R&S	CMU200	118133	2018-05-13	2019-05-12
Base Station Simulator	R&S	CMW500	113645	2018-05-13	2019-05-12
Power Splitter	Hua Xiang	SHX-GF2-2-13	10120101	NA	NA
Spectrum Analyzer	Agilent	N9010A	MY47191109	2018-05-20	2019-05-19
Universal Radio Communication Tester	Agilent	E5515C	MY48367192	2018-05-20	2019-05-19
Signal Analyzer	R&S	FSV30	100815	2017-12-17	2018-12-16
EMI Test Receiver	R&S	ESCI	100948	2018-05-20	2019-05-19
Loop Antenna	SCHWARZBECK	FMZB1519	1519-047	2014-12-06	2019-12-05
Trilog Antenna	SCHWARZBECK	VUBL 9163	9163-201	2017-11-18	2020-11-17
Horn Antenna	R&S	HF907	100126	2014-12-06	2019-12-05
Climatic Chamber	ESPEC	SU-242	93000506	2017-12-17	2020-12-16
Horn Antenna	ETS-Lindgren	3160-09	00102644	2015-01-30	2020-01-29
RF Cable	Agilent	SMA 15cm	0001	2018-02-03	2018-08-02
Preamplifier	R&S	SCU18	102327	2018-05-20	2019-05-19
Software	R&S	EMC32	V9.26.0	NA	NA
MOB COMMS DC SUPPLY	Keysight	66319D	MY43004105	2018-05-07	2019-05-06

\*\*\*\*\*END OF REPORT \*\*\*\*\*



## ANNEX A: EUT Appearance and Test Setup

### A.1 EUT Appearance

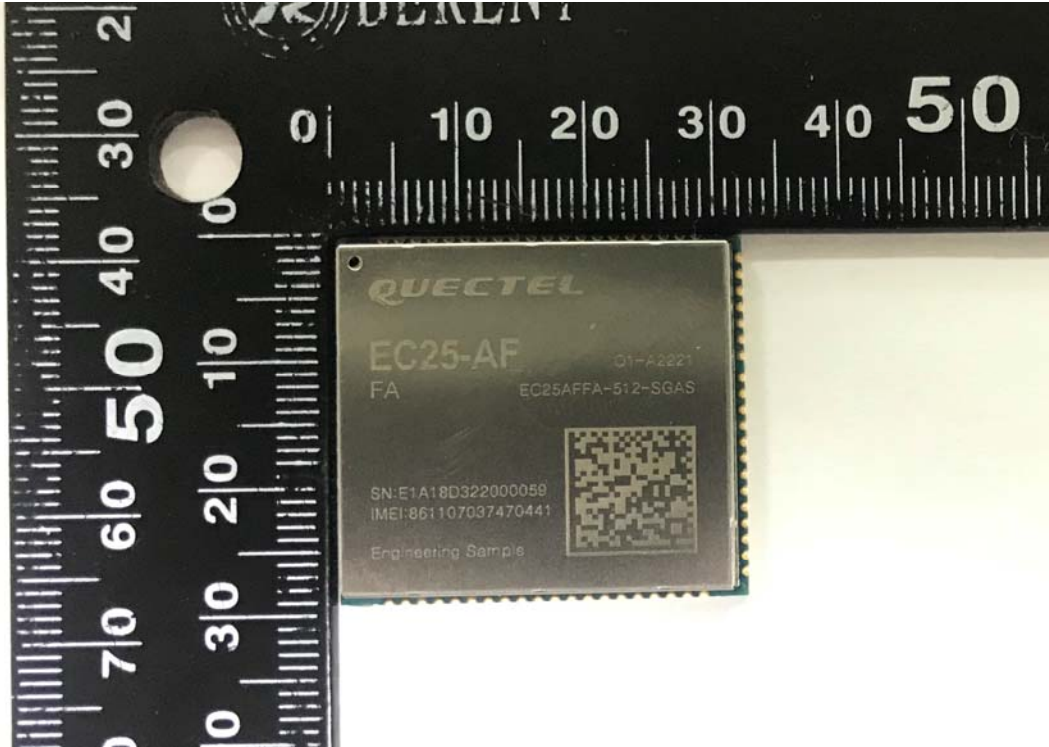

shielding

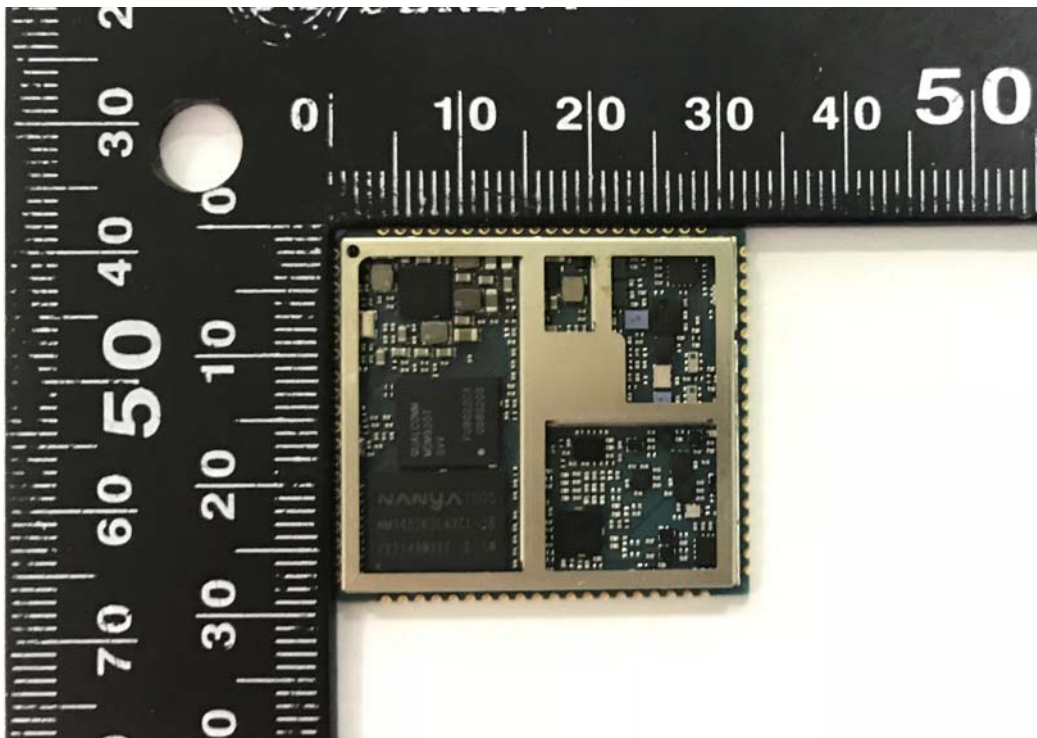

No shielding  
Front Side

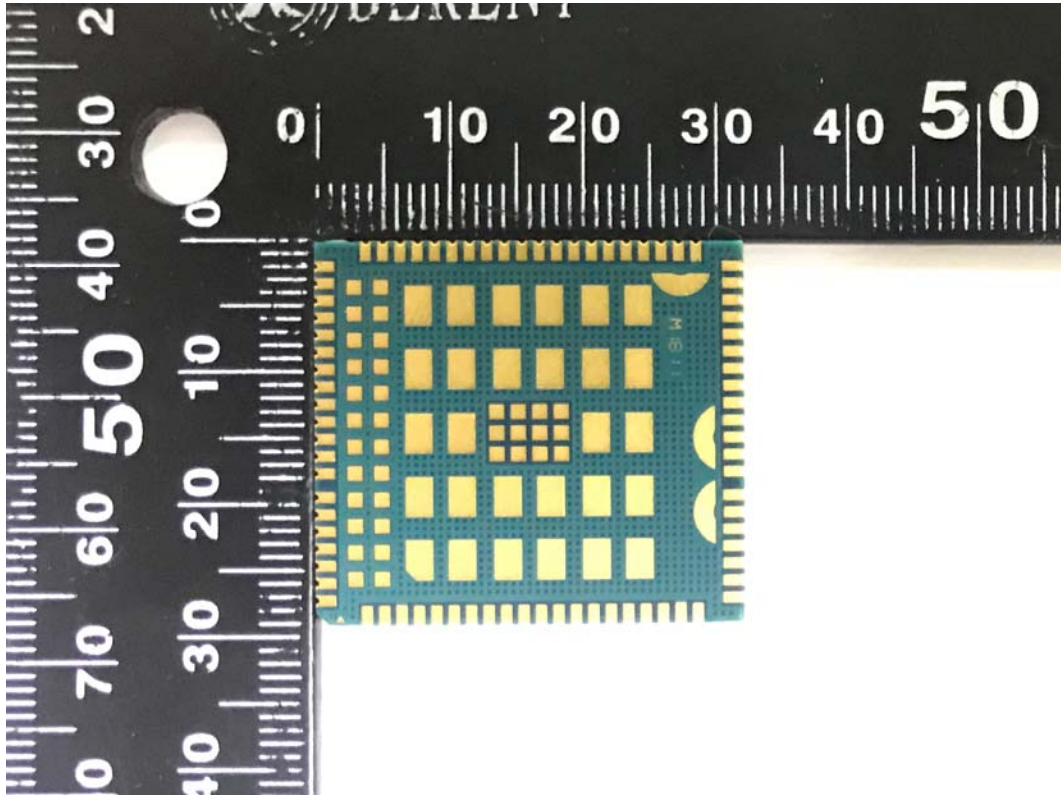

Back Side  
EC25-AF



shielding

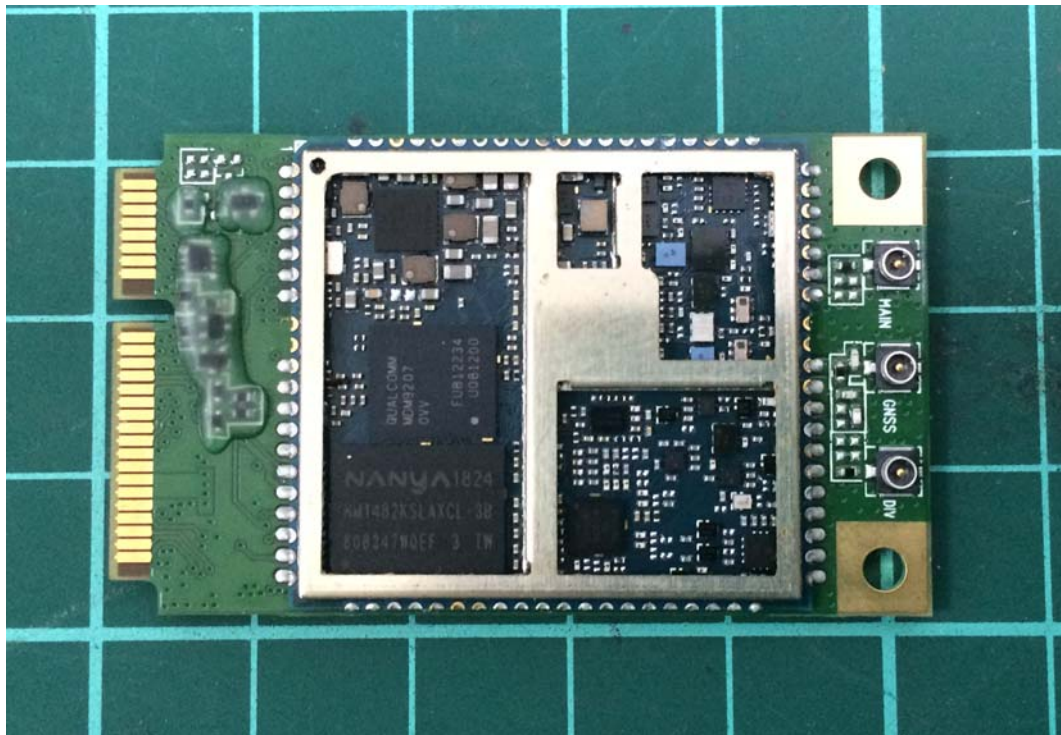

No shielding  
Front Side



shielding

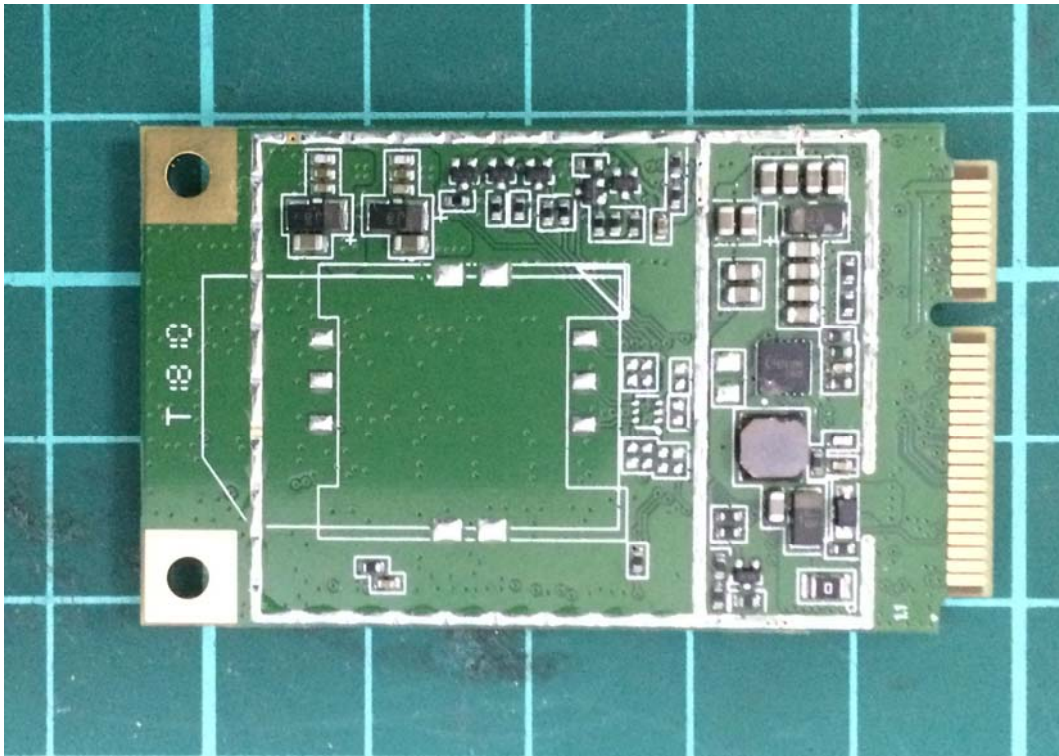

No shielding

Back Side

**EC25-AF MINIPCI-E**

**Picture 1 EUT and Accessory**

## A.2 Test Setup

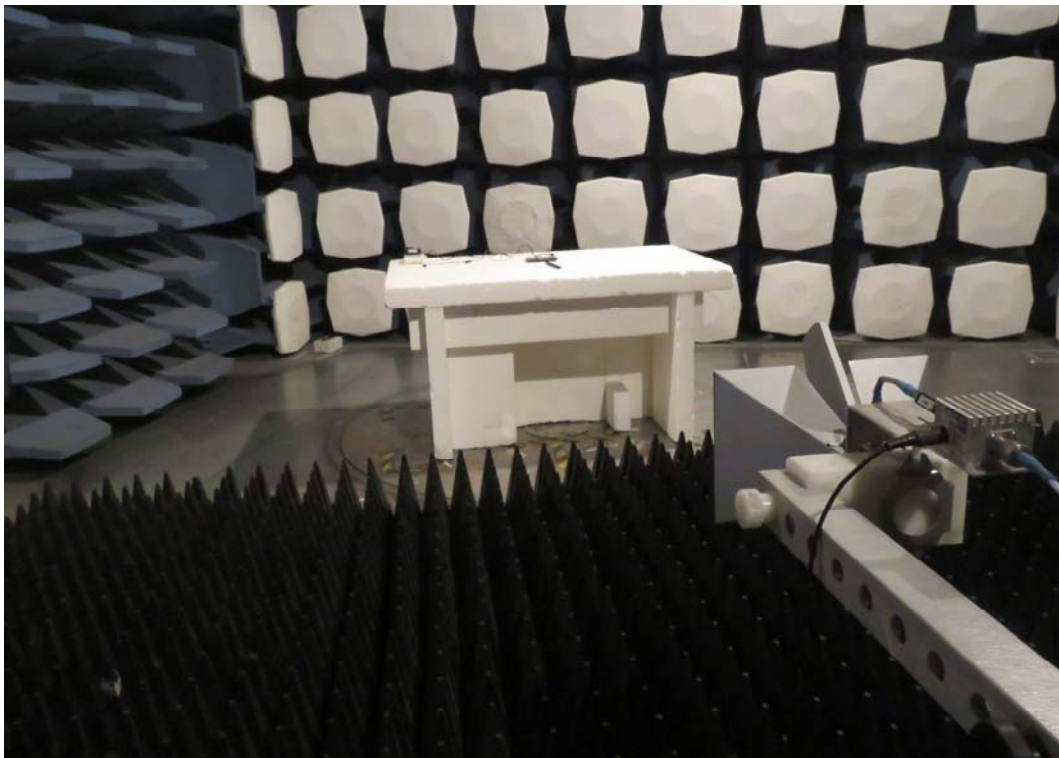

Picture 2: Radiated Spurious Emissions Test setup