



RF TEST REPORT

Applicant Quectel Wireless Solutions Co., Ltd
FCC ID XMR201805EC25AU
Product LTE Module
Brand Quectel
Model EC25-AU, EC25-AU MINIPCIE
Report No. R1804A0154-R3
Issue Date April 24, 2018

TA Technology (Shanghai) Co., Ltd. tested the above equipment in accordance with the requirements in **FCC CFR47 Part 2 (2017)/ FCC CFR47 Part 27C (2017)**. The test results show that the equipment tested is capable of demonstrating compliance with the requirements as documented in this report.

Performed by: Jiangpeng Lan

Approved by: Kai Xu

TA Technology (Shanghai) Co., Ltd.

No.145, Jintang Rd, Tangzhen Industry Park, Pudong Shanghai, China

TEL: +86-021-50791141/2/3

FAX: +86-021-50791141/2/3-8000

Table of Contents

1	Test Laboratory.....	4
1.1	Notes of the Test Report.....	4
1.2	Test facility.....	4
1.3	Testing Location.....	5
2	General Description of Equipment under Test.....	6
3	Applied Standards.....	7
4	Test Configuration.....	8
5	Test Case Results.....	9
5.1	RF Power Output.....	9
5.2	Effective Isotropic Radiated Power.....	14
5.3	Occupied Bandwidth.....	19
5.4	Band Edge Compliance.....	32
5.5	Peak-to-Average Power Ratio (PAPR).....	48
5.6	Frequency Stability.....	51
5.7	Spurious Emissions at Antenna Terminals.....	54
5.8	Radiates Spurious Emission.....	71
6	Main Test Instruments.....	89
ANNEX A:	EUT Appearance and Test Setup.....	90
A.1	EUT Appearance.....	90
A.2	Test Setup.....	92

Summary of Measurement Results

Number	Test Case	Clause in FCC rules	Verdict
1	RF power output	2.1046	PASS
2	Effective Isotropic Radiated power	27.50(d)(4)/27.50(h)(2)	PASS
3	Occupied Bandwidth	2.1049	PASS
4	Band Edge Compliance	27.53(h) /27.53(m)	PASS
5	Peak-to-Average Power Ratio	27.50(d)/KDB971168 D01(5.7)	PASS
6	Frequency Stability	2.1055 / 27.54	PASS
7	Spurious Emissions at Antenna Terminals	2.1051 /27.53(h) /27.53(m)	PASS
8	Radiates Spurious Emission	2.1053 /27.53(h) /27.53(m)	PASS
Date of Testing: April 12, 2018~ April 18, 2018			
Note: PASS: The EUT complies with the essential requirements in the standard. FAIL: The EUT does not comply with the essential requirements in the standard.			

1 Test Laboratory

1.1 Notes of the Test Report

This report shall not be reproduced in full or partial, without the written approval of **TA technology (shanghai) co., Ltd.** The results documented in this report apply only to the tested sample, under the conditions and modes of operation as described herein. Measurement Uncertainties were not taken into account and are published for informational purposes only. This report is written to support regulatory compliance of the applicable standards stated above.

1.2 Test facility

CNAS (accreditation number: L2264)

TA Technology (Shanghai) Co., Ltd. has obtained the accreditation of China National Accreditation Service for Conformity Assessment (CNAS).

FCC (Designation number: CN1179, Test Firm Registration Number: 446626)

TA Technology (Shanghai) Co., Ltd. has been listed on the US Federal Communications Commission list of test facilities recognized to perform electromagnetic emissions measurements.

IC (recognition number is 8510A)

TA Technology (Shanghai) Co., Ltd. has been listed by industry Canada to perform electromagnetic emission measurement.

VCCI (recognition number is C-4595, T-2154, R-4113, G-10766)

TA Technology (Shanghai) Co., Ltd. has been listed by industry Japan to perform electromagnetic emission measurement.

A2LA (Certificate Number: 3857.01)

TA Technology (Shanghai) Co., Ltd. has been listed by American Association for Laboratory Accreditation to perform electromagnetic emission measurement.

1.3 Testing Location

Company: TA Technology (Shanghai) Co., Ltd.
Address: No.145, Jintang Rd, Tangzhen Industry Park, Pudong Shanghai, China
City: Shanghai
Post code: 201201
Country: P. R. China
Contact: Xu Kai
Telephone: +86-021-50791141/2/3
Fax: +86-021-50791141/2/3-8000
Website: <http://www.ta-shanghai.com>
E-mail: xukai@ta-shanghai.com

2 General Description of Equipment under Test

Client Information

Applicant	Quectel Wireless Solutions Co., Ltd
Applicant address	7th Floor, Hongye Building, No.1801 Hongmei Road, Xuhui District, Shanghai 200233, China
Manufacturer	Quectel Wireless Solutions Co., Ltd
Manufacturer address	7th Floor, Hongye Building, No.1801 Hongmei Road, Xuhui District, Shanghai 200233, China

General information

EUT Description			
Model	EC25-AU, EC25-AU MINIPCIE		
IMEI	861107032349566		
Hardware Version	R1.0		
Software Version	EC25AUFAR02A04M4G		
Power Supply	External supply power		
Antenna Type	The EUT don't have standard Antenna, The Antenna used for testing in this report is the after-market accessory (Dipole Antenna)		
Test Mode(s)	LTE Band 4; LTE Band 7;		
Test Modulation	(LTE)QPSK 16QAM;		
LTE Category	4		
Maximum E.I.R.P.	LTE Band 4:	24.89dBm	
	LTE Band 7:	27.88dBm	
Rated Power Supply Voltage:	3.8 V		
Extreme Voltage	Minimum: 3.3 V Maximum: 4.3V		
Extreme Temperature	Lowest: -40°C Highest: +85°C		
Operating Frequency Range(s)	Mode	Tx (MHz)	Rx (MHz)
	LTE Band 4	1710 ~ 1755	2110 ~ 2155
	LTE Band 7	2500 ~ 2570	2620 ~ 2690
Note: The information of the EUT is declared by the manufacturer.			

The series model number is: EC25-AU MINIPCIE. The difference of these models are have different marketing requirement.

Accessory equipment	
Evaluation Board	RF Cable
RS232-to-USB Cable	Antenna: Dipole Antenna
Headset	DC 5V Adaptor

3 Applied Standards

According to the specifications of the manufacturer, it must comply with the requirements of the following standards:

Test standards

FCC CFR47 Part 2 (2017)

FCC CFR47 Part 27C (2017)

ANSI/TIA-603-E (2016)

KDB 971168 D01 Power Meas License Digital Systems v03

4 Test Configuration

Radiated measurements are performed by rotating the EUT in three different orthogonal test planes. EUT stand-up position (Z axis), lie-down position (X, Y axis). Receiver antenna polarization (horizontal and vertical), the worst emission was found in position (Z axis, vertical polarization) and the worst case was recorded.

All mode and data rates and positions and RB size and modulations were investigated.

Subsequently, only the worst case emissions are reported.

The following testing in LTE is set based on the maximum RF Output Power.

The following testing in different Bandwidth is set to detail in the following table:

Test modes are chosen to be reported as the worst case configuration below for LTE Band 4/7:

Test items	Modes	Bandwidth (MHz)						Modulation		RB			Test Channel		
		1.4	3	5	10	15	20	QPSK	16QAM	1	50%	100%	L	M	H
RF power output	LTE 4	O	O	O	O	O	O	O	O	O	O	O	O	O	O
	LTE 7	-	-	O	O	O	O	O	O	O	O	O	O	O	O
Effective Isotropic Radiated power	LTE 4	O	O	O	O	O	O	O	O	-	-	O	O	O	O
	LTE 7	-	-	O	O	O	O	O	O	-	-	O	O	O	O
Occupied Bandwidth	LTE 4	O	O	O	O	O	O	O	O	-	-	O	O	O	O
	LTE 7	-	-	O	O	O	O	O	O	-	-	O	O	O	O
Band Edge Compliance	LTE 4	O	O	O	O	O	O	O	O	O	-	O	O	-	O
	LTE 7	-	-	O	O	O	O	O	O	O	-	O	O	-	O
Peak-to-Average Power Ratio	LTE 4	O	O	O	O	O	O	O	O	-	-	O	O	O	O
	LTE 7	-	-	O	O	O	O	O	O	-	-	O	O	O	O
Frequency Stability	LTE 4	O	O	O	O	O	O	O	O	-	-	O	-	O	-
	LTE 7	-	-	O	O	O	O	O	O	-	-	O	-	O	-
Spurious Emissions at Antenna Terminals	LTE 4	O	O	O	O	O	O	O	-	O	-	-	O	O	O
	LTE 7	-	-	O	O	O	O	O	-	O	-	-	O	O	O
Radiates Spurious Emission	LTE 4	O	O	O	O	O	O	O	-	O	-	-	O	O	O
	LTE 7	-	-	O	O	O	O	O	-	O	-	-	O	O	O
Note	1. The mark "O" means that this configuration is chosen for testing. 2. The mark "-" means that this configuration is not testing.														

5 Test Case Results

5.1 RF Power Output

Ambient condition

Temperature	Relative humidity	Pressure
23°C ~25°C	45%~50%	101.5kPa

Methods of Measurement

During the process of the testing, The EUT is controlled by the Base Station Simulator to ensure max power transmission and proper modulation.

Test Setup

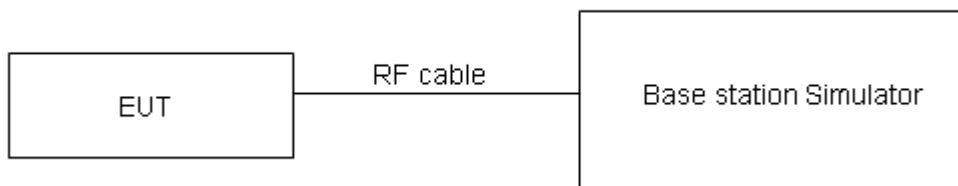

The loss between RF output port of the EUT and the input port of the tester has been taken into consideration.

Limits

No specific RF power output requirements in part 2.1046.

Measurement Uncertainty

The assessed measurement uncertainty to ensure 95% confidence level for the normal distribution is with the coverage factor $k = 2$, $U=0.4$ dB.

Test Results

LTE Band 4				AV Conducted Power(dBm)		
Bandwidth	Modulation	RB size	RB offset	Channel/Frequency (MHz)		
				19957/1710.7	20175/1732.5	20393/1754.3
1.4MHz	QPSK	1	0	23.68	23.84	23.81
		1	2	23.77	23.60	23.79
		1	5	23.63	23.71	23.75
		3	0	23.82	23.90	24.07
		3	2	23.61	23.85	23.99
		3	3	23.73	23.62	23.88
		6	0	23.01	22.79	22.96
	16QAM	1	0	23.43	22.31	23.15
		1	2	23.54	22.95	23.23
		1	5	23.33	22.74	23.19
		3	0	22.55	22.66	22.64
		3	2	22.62	22.59	22.57
		3	3	22.62	22.65	22.58
		6	0	21.53	21.77	21.64
Bandwidth	Modulation	RB size	RB offset	Channel/Frequency (MHz)		
				19965/1711.5	20175/1732.5	20385/1753.5
3MHz	QPSK	1	0	23.59	23.88	23.84
		1	7	23.87	23.65	23.83
		1	14	23.50	23.76	23.79
		8	0	22.88	23.02	23.20
		8	4	22.93	22.95	23.11
		8	7	23.01	22.73	22.98
		15	0	22.87	22.83	22.99
	16QAM	1	0	23.16	22.33	23.18
		1	7	23.16	23.00	23.27
		1	14	22.77	22.78	23.22
		8	0	21.66	21.79	21.76
		8	4	21.73	21.72	21.69
		8	7	21.72	21.77	21.71
		15	0	21.56	21.81	21.67
Bandwidth	Modulation	RB size	RB offset	Channel/Frequency (MHz)		
				19975/1712.5	20175/1732.5	20375/1752.5
5MHz	QPSK	1	0	23.56	23.86	23.80
		1	13	23.85	23.61	23.80
		1	24	23.47	23.71	23.75
		12	0	22.85	22.97	23.16
		12	6	22.91	22.91	23.06
		12	13	22.99	22.71	22.94
		25	0	22.85	22.82	22.97



Bandwidth	Modulation	RB size	RB offset	Channel/Frequency (MHz)		
				20000/1715	20175/1732.5	20350/1750
	16QAM	1	0	23.13	22.29	23.15
		1	13	23.13	22.98	23.24
		1	24	22.74	22.76	23.18
		12	0	21.64	21.75	21.73
		12	6	21.70	21.67	21.65
		12	13	21.69	21.72	21.67
		25	0	21.54	21.77	21.62
Bandwidth	Modulation	RB size	RB offset	Channel/Frequency (MHz)		
				20025/1717.5	20175/1732.5	20325/1747.5
10MHz	QPSK	1	0	23.58	23.87	23.83
		1	25	23.88	23.66	23.84
		1	49	23.49	23.75	23.78
		25	0	22.88	23.02	23.20
		25	13	22.94	22.96	23.10
		25	25	23.01	22.75	22.99
		50	0	22.93	22.84	23.01
	16QAM	1	0	23.15	22.32	23.17
		1	25	23.16	23.02	23.27
		1	49	22.77	22.78	23.21
		25	0	21.67	21.80	21.77
		25	13	21.72	21.71	21.68
		25	25	21.72	21.77	21.71
		50	0	21.57	21.82	21.66
Bandwidth	Modulation	RB size	RB offset	Channel/Frequency (MHz)		
				20050/1720	20175/1732.5	20300/1745
15MHz	QPSK	1	0	23.57	23.83	23.81
		1	38	23.86	23.65	23.81
		1	74	23.46	23.70	23.74
		36	0	22.86	22.98	23.17
		36	18	22.91	22.91	23.06
		36	39	22.98	22.72	22.95
		75	0	22.91	22.80	22.96
	16QAM	1	0	23.10	22.30	23.15
		1	38	23.14	22.99	23.25
		1	74	22.74	22.74	23.18
		36	0	21.64	21.78	21.74
		36	18	21.69	21.66	21.64
		36	39	21.70	21.73	21.68
		75	0	21.54	21.77	21.62
Bandwidth	Modulation	RB size	RB offset	Channel/Frequency (MHz)		
				20050/1720	20175/1732.5	20300/1745
20MHz	QPSK	1	0	23.54	23.79	23.78
		1	50	23.85	23.61	23.79



		1	99	23.44	23.69	23.71
		50	0	22.83	22.93	23.13
		50	25	22.89	22.87	23.03
		50	50	22.95	22.67	22.91
		100	0	22.88	22.75	22.92
	16QAM	1	0	23.08	22.26	23.10
		1	50	23.10	22.97	23.21
		1	99	22.72	22.71	23.16
		50	0	21.61	21.74	21.71
		50	25	21.66	21.64	21.61
		50	50	21.67	21.68	21.64
		100	0	21.52	21.73	21.59

LTE Band 7				Conducted Power(dBm)		
Bandwidth	Modulation	RB size	RB offset	Channel/Frequency (MHz)		
				20775/2502.5	21100/2535	21425/2567.5
5MHz	QPSK	1	0	23.23	23.77	23.92
		1	13	23.65	23.67	24.15
		1	24	23.68	23.38	24.17
		12	0	22.70	23.22	23.19
		12	6	22.87	23.11	23.21
		12	13	23.16	22.99	23.34
		25	0	22.98	23.11	23.25
	16QAM	1	0	23.17	22.95	22.96
		1	13	23.12	23.16	22.86
		1	24	23.01	22.75	23.07
		12	0	21.90	21.90	21.78
		12	6	21.83	21.99	21.83
		12	13	21.87	21.95	21.86
		25	0	22.00	22.06	21.84
Bandwidth	Modulation	RB size	RB offset	Channel/Frequency (MHz)		
				20800/2505	21100/2535	21400/2565
10MHz	QPSK	1	0	23.25	23.78	23.57
		1	25	23.68	23.72	24.16
		1	49	23.70	23.42	23.95
		25	0	22.73	23.27	23.12
		25	13	22.90	23.16	23.20
		25	25	23.18	23.03	23.20
		50	0	23.06	23.13	23.11
	16QAM	1	0	23.19	22.98	23.17
		1	25	23.15	23.20	23.83
		1	49	23.04	22.77	23.98



Bandwidth	Modulation	RB size	RB offset	Channel/Frequency (MHz)		
				20825/2507.5	21100/2535	21375/2562.5
		25	0	21.93	21.95	21.82
		25	13	21.85	22.03	21.86
		25	25	21.90	22.00	21.90
		50	0	22.03	22.11	21.88
15MHz	QPSK	1	0	23.24	23.74	23.55
		1	38	23.66	23.71	24.13
1		74	23.67	23.37	23.91	
36		0	22.71	23.23	23.09	
36		18	22.87	23.11	23.16	
36		39	23.15	23.00	23.16	
75		0	23.04	23.09	23.06	
15MHz	16QAM	1	0	23.14	22.96	23.15
		1	38	23.13	23.17	23.81
		1	74	23.01	22.73	23.95
		36	0	21.90	21.93	21.79
		36	18	21.82	21.98	21.82
		36	39	21.88	21.96	21.87
		75	0	22.00	22.06	21.84
20MHz		RB size	RB offset	Channel/Frequency (MHz)		
				20850/2510	21100/2535	21350/2560
20MHz	QPSK	1	0	23.21	23.70	23.52
		1	50	23.65	23.67	24.11
		1	99	23.65	23.36	23.88
		50	0	22.68	23.18	23.05
		50	25	22.85	23.07	23.13
		50	50	23.12	22.95	23.12
		100	0	23.01	23.04	23.02
	16QAM	1	0	23.12	22.92	23.10
		1	50	23.09	23.15	23.77
		1	99	22.99	22.70	23.93
		50	0	21.87	21.89	21.76
		50	25	21.79	21.96	21.79
		50	50	21.85	21.91	21.83
		100	0	21.98	22.02	21.81

5.2 Effective Isotropic Radiated Power

Ambient condition

Temperature	Relative humidity	Pressure
23°C ~25°C	45%~50%	101.5kPa

Methods of Measurement

1. The testing follows FCC KDB 971168 D01 v03 Section 5.8 and ANSI/TIA-603-E (2016).
 - a) Connect the equipment as illustrated. Mount the equipment with the manufacturer specified antenna in a vertical orientation on a manufacturer specified mounting surface located on a non-conducting rotating platform of a RF anechoic chamber (preferred) or a standard radiation site.
 - b) Key the transmitter, then rotate the EUT 360° azimuthally and record spectrum analyzer power level (LVL) measurements at angular increments that are sufficiently small to permit resolution of all peaks. If a standard radiation test site is used, raise and lower the test antenna to obtain a maximum reading at each angular increment. (Note: several batteries may be needed to offset the effect of battery voltage droop, which should not exceed 5% of the manufactured specified battery voltage during transmission).
 - c) Replace the transmitter under test with a vertically polarized half-wave dipole (or an antenna whose gain is known relative to an ideal half-wave dipole). The center of the antenna should be at the same location as the center of the antenna under test.
 - d) Connect the antenna to a signal generator with a known output power and record the path loss (in dB) as LOSS. If a standard radiation test site is used, raise and lower the test antenna to obtain a maximum reading. $LOSS = \text{Generator Output Power (dBm)} - \text{Analyzer reading (dBm)}$
 - e) Determine the effective radiated output power at each angular position from the readings in steps b) and d) using the following equation: $ERP \text{ (dBm)} = LVL \text{ (dBm)} + LOSS \text{ (dB)}$
 - f) The maximum ERP is the maximum value determined in the preceding step.
 - g) When calculating ERP, in addition to knowing the antenna radiation and matching characteristics, it is necessary to know the loss values of all elements (e.g. transmission line attenuation, mismatches, filters, combiners) interposed between the point where transmitter output power is measured, and the point where power is applied to the antenna. ERP can then be calculated as follows:
 $ERP \text{ (dBm)} = \text{Output Power (dBm)} - \text{Losses (dB)} + \text{Antenna Gain (dBd)}$
 where: dBd refers to gain relative to an ideal dipole.
 $EIRP \text{ (dBm)} = ERP \text{ (dBm)} + 2.15 \text{ (dB.)}$

Test setup

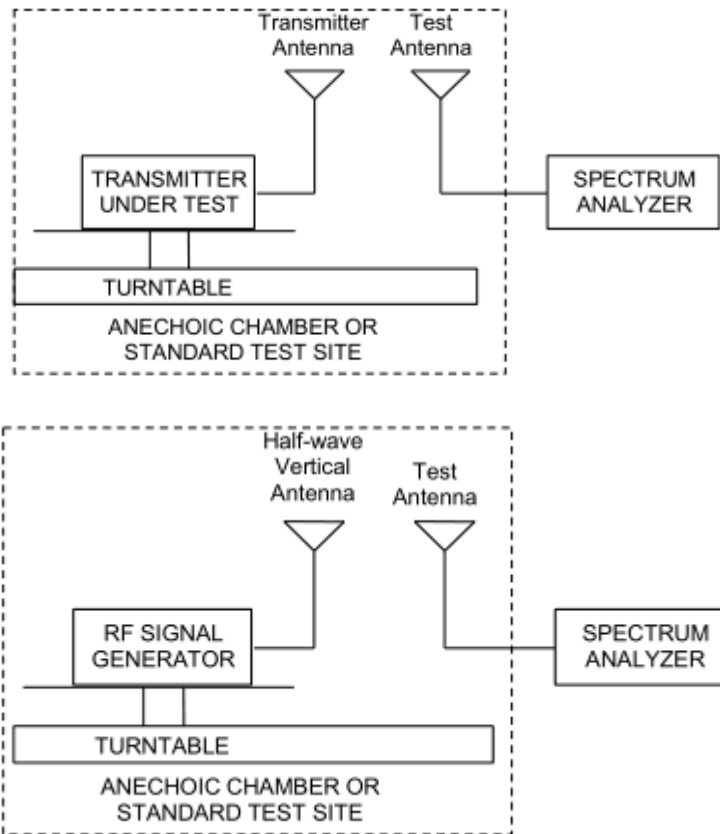

Note: Area side:2.4mX3.6m

The radiated emission was measured in the following position: EUT stand-up position (Z axis), lie-down position (X, Y axis). The worst emission was found in stand-up position (Z axis) and the worst case was recorded.

**Limits**

Rule Part 27.50(d) (4) specifies that “Fixed, mobile and portable (hand-held) stations operating in the 1710–1755 MHz band are limited to 1 watt EIRP”

Rule Part 27.50(h) (2) specifies that “Mobile and other user stations. Mobile stations are limited to 2.0 watts EIRP. All user stations are limited to 2.0 watts transmitter output power.”

Part 27.50(d)(4)Limit -LTE 4	$\leq 1 \text{ W}$ (30 dBm)
Part 27.50(h)(2) Limit-LTE 7	$\leq 2 \text{ W}$ (33 dBm)

Measurement Uncertainty

The assessed measurement uncertainty to ensure 95% confidence level for the normal distribution is with the coverage factor $k = 2$, $U = 1.19 \text{ dB}$

Test Results

The measurement is performed for both of horizontal and vertical antenna Polarization, and only the data of worst mode is recorded in this report.

LTE Band 4						
Bandwidth	Channel	Frequency (MHz)	Polarization	EIRP (dBm)	Limit (dBm)	Conclusion
1.4 MHz (QPSK)	Low	1710.7	Horizontal	24.32	30	Pass
	Mid	1732.5	Horizontal	24.51	30	Pass
	High	1754.3	Horizontal	24.21	30	Pass
3 MHz (QPSK)	Low	1711.5	Horizontal	24.58	30	Pass
	Mid	1732.5	Horizontal	24.36	30	Pass
	High	1753.5	Horizontal	24.62	30	Pass
5 MHz (QPSK)	Low	1712.5	Horizontal	24.37	30	Pass
	Mid	1732.5	Horizontal	24.56	30	Pass
	High	1752.5	Horizontal	24.32	30	Pass
10 MHz (QPSK)	Low	1715	Horizontal	24.55	30	Pass
	Mid	1732.5	Horizontal	24.77	30	Pass
	High	1750	Horizontal	24.51	30	Pass
15 MHz (QPSK)	Low	1717.5	Horizontal	24.32	30	Pass
	Mid	1732.5	Horizontal	24.16	30	Pass
	High	1747.5	Horizontal	24.00	30	Pass
20 MHz (QPSK)	Low	1720	Horizontal	24.86	30	Pass
	Mid	1732.5	Horizontal	24.66	30	Pass
	High	1745	Horizontal	24.89	30	Pass
1.4 MHz (16QAM)	Low	1710.7	Horizontal	24.17	30	Pass
	Mid	1732.5	Horizontal	24.36	30	Pass
	High	1754.3	Horizontal	24.06	30	Pass
3 MHz (16QAM)	Low	1711.5	Horizontal	24.43	30	Pass
	Mid	1732.5	Horizontal	24.21	30	Pass
	High	1753.5	Horizontal	24.47	30	Pass
5 MHz (16QAM)	Low	1712.5	Horizontal	24.22	30	Pass
	Mid	1732.5	Horizontal	24.41	30	Pass
	High	1752.5	Horizontal	24.17	30	Pass
10 MHz (16QAM)	Low	1715	Horizontal	24.40	30	Pass
	Mid	1732.5	Horizontal	24.62	30	Pass
	High	1750	Horizontal	24.36	30	Pass
15 MHz (16QAM)	Low	1717.5	Horizontal	24.17	30	Pass
	Mid	1732.5	Horizontal	24.01	30	Pass
	High	1747.5	Horizontal	23.85	30	Pass
20 MHz (16QAM)	Low	1720	Horizontal	24.71	30	Pass
	Mid	1732.5	Horizontal	24.51	30	Pass
	High	1745	Horizontal	24.74	30	Pass



LTE Band 7						
Band width	Channel	Frequency (MHz)	Polarization	EIRP (dBm)	Limit (dBm)	Conclusion
5 MHz (QPSK)	Low	2502.5	Horizontal	27.55	33	Pass
	Mid	2535	Horizontal	27.45	33	Pass
	High	2567.5	Horizontal	27.35	33	Pass
10 MHz (QPSK)	Low	2505	Horizontal	27.14	33	Pass
	Mid	2535	Horizontal	27.65	33	Pass
	High	2565	Horizontal	27.69	33	Pass
15 MHz (QPSK)	Low	2507.5	Horizontal	27.84	33	Pass
	Mid	2535	Horizontal	27.64	33	Pass
	High	2562.5	Horizontal	27.18	33	Pass
20 MHz (QPSK)	Low	2510	Horizontal	27.26	33	Pass
	Mid	2535	Horizontal	27.22	33	Pass
	High	2560	Horizontal	27.88	33	Pass
5 MHz (16QAM)	Low	2502.5	Horizontal	27.39	33	Pass
	Mid	2535	Horizontal	27.29	33	Pass
	High	2567.5	Horizontal	27.19	33	Pass
10 MHz (16QAM)	Low	2505	Horizontal	26.98	33	Pass
	Mid	2535	Horizontal	27.49	33	Pass
	High	2565	Horizontal	27.53	33	Pass
15 MHz (16QAM)	Low	2507.5	Horizontal	27.68	33	Pass
	Mid	2535	Horizontal	27.48	33	Pass
	High	2562.5	Horizontal	27.02	33	Pass
20 MHz (16QAM)	Low	2510	Horizontal	27.10	33	Pass
	Mid	2535	Horizontal	27.06	33	Pass
	High	2560	Horizontal	27.72	33	Pass

Note: 1. EIRP= E.R.P+2.15

5.3 Occupied Bandwidth

Ambient condition

Temperature	Relative humidity	Pressure
23°C ~25°C	45%~50%	101.5kPa

Method of Measurement

The EUT was connected to Spectrum Analyzer and Base Station Simulator via power Splitter. The occupied bandwidth is measured using spectrum analyzer.

RBW is set to 51 kHz, VBW is set to 160 kHz for LTE Band 4 (1.4MHz).

RBW is set to 100 kHz, VBW is set to 300 kHz for LTE Band 4 (3MHz).

RBW is set to 100 kHz, VBW is set to 300 kHz for LTE Band 4/7 (5MHz).

RBW is set to 300 kHz, VBW is set to 1MHz for LTE Band 4/7 (10MHz).

RBW is set to 300 kHz, VBW is set to 1MHz for LTE Band 4/7 (15MHz/20MHz).

99% power and -26dBc occupied bandwidths are recorded. Spectrum analyzer plots are included on the following pages.

Test Setup

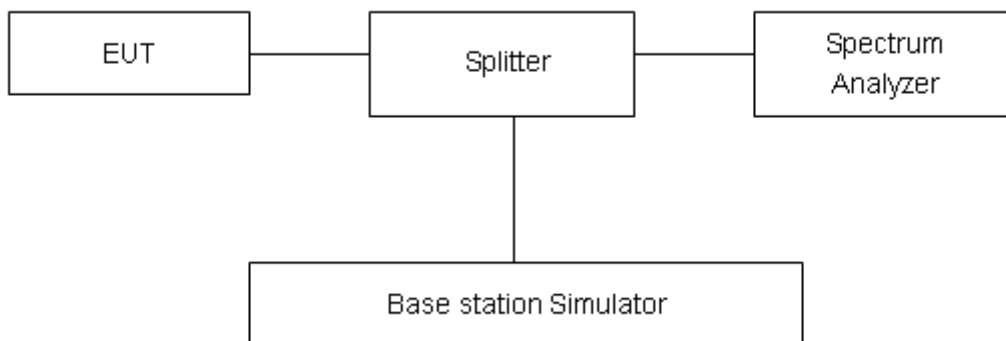

Limits

No specific occupied bandwidth requirements in part 2.1049.

Measurement Uncertainty

The assessed measurement uncertainty to ensure 95% confidence level for the normal distribution is with the coverage factor $k = 2$, $U=624\text{Hz}$.

Test Result

LTE Band 4						
RB	Modulation	Bandwidth (MHz)	Channel	Frequency (MHz)	99% Power Bandwidth(MHz)	-26dBc Bandwidth(MHz)
100%	QPSK	1.4	19957	1710.7	1.1187	1.336
			20175	1732.5	1.1225	1.352
			20393	1754.3	1.1389	1.342
		3	19965	1711.5	2.7418	3.072
			20175	1732.5	2.7414	3.041
			20385	1753.5	2.7397	3.060
		5	19975	1712.5	4.5353	5.022
			20175	1732.5	4.5163	5.039
			20375	1752.5	4.5110	4.977
		10	20000	1715	9.0304	10.160
			20175	1732.5	9.0190	10.080
			20350	1750	9.0257	10.080
		15	20025	1717.5	13.4420	14.840
			20175	1732.5	13.4270	14.690
			20325	1747.5	13.4580	14.740
	20	20050	1720	17.8450	19.140	
		20175	1732.5	17.8980	19.250	
		20300	1745	17.9200	19.470	
	16QAM	1.4	19957	1710.7	1.1300	1.341
			20175	1732.5	1.1249	1.337
			20393	1754.3	1.1220	1.343
		3	19965	1711.5	2.7620	3.064
			20175	1732.5	2.7345	3.056
			20385	1753.5	2.7381	3.068
		5	19975	1712.5	4.5154	5.010
			20175	1732.5	4.5315	5.030
			20375	1752.5	4.5227	5.045
		10	20000	1715	9.0398	10.020
			20175	1732.5	9.0187	10.100
			20350	1750	9.0298	10.060
15		20025	1717.5	13.4350	14.680	
		20175	1732.5	13.4650	14.730	
		20325	1747.5	13.4680	14.740	
20	20050	1720	17.8750	19.340		
	20175	1732.5	17.9060	19.400		
	20300	1745	17.8860	19.330		

LTE Band 7						
RB	Modulation	Bandwidth (MHz)	Channel	Frequency (MHz)	99% Power Bandwidth(MHz)	-26dBc Bandwidth(MHz)
100%	QPSK	5	20775	2502.5	4.5122	5.016
			21100	2535	4.0539	5.006
			21425	2567.5	4.5293	5.028
		10	20800	2505	9.0373	10.170
			21100	2535	9.0048	10.100
			21400	2565	9.0260	10.130
		15	20825	2507.5	13.4670	14.780
			21100	2535	13.4420	14.770
			21375	2562.5	13.4590	14.750
		20	20850	2510	17.8700	19.170
			21100	2535	17.8630	19.330
			21350	2560	17.8950	19.330
	16QAM	5	20775	2502.5	4.5357	5.037
			21100	2535	4.5306	5.055
			21425	2567.5	4.5117	5.025
		10	20800	2505	9.0432	10.020
			21100	2535	9.0084	10.040
			21400	2565	9.0287	10.010
		15	20825	2507.5	13.4520	14.730
			21100	2535	13.4650	14.760
			21375	2562.5	13.4680	14.710
		20	20850	2510	17.8590	19.380
			21100	2535	17.8920	19.350
			21350	2560	17.8460	19.390

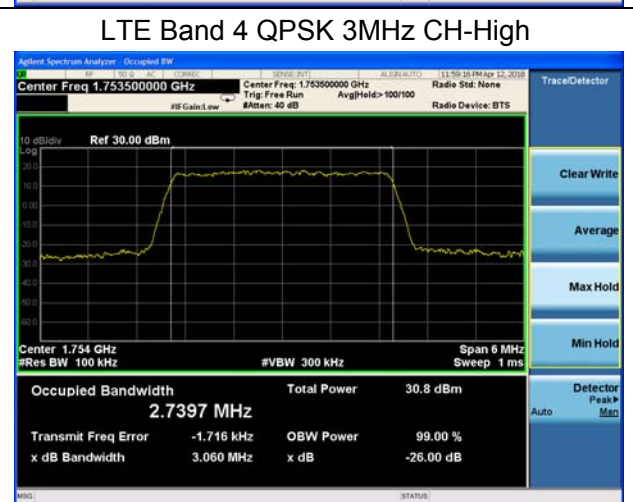
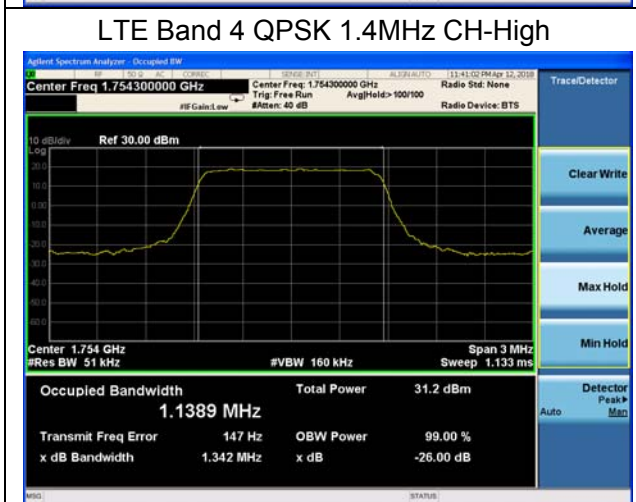
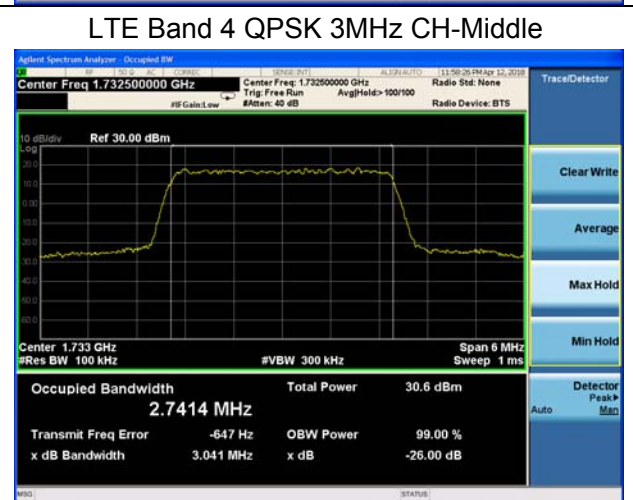
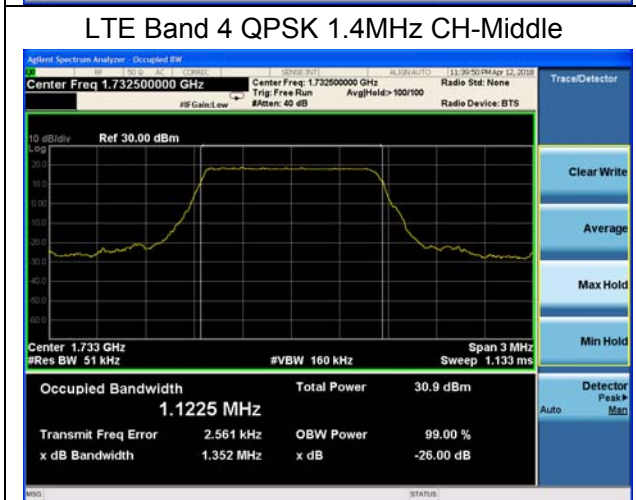
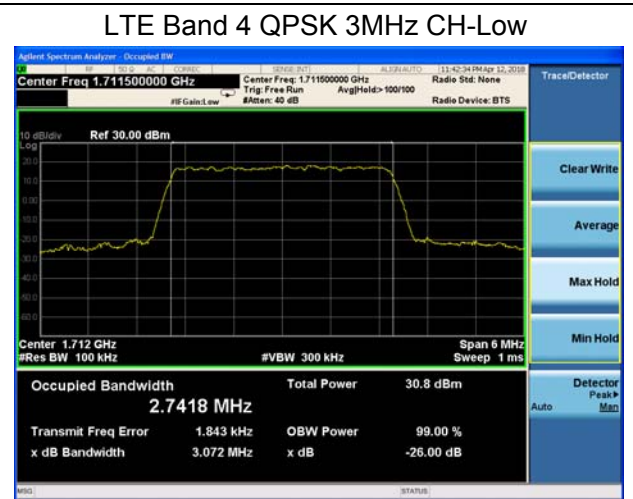
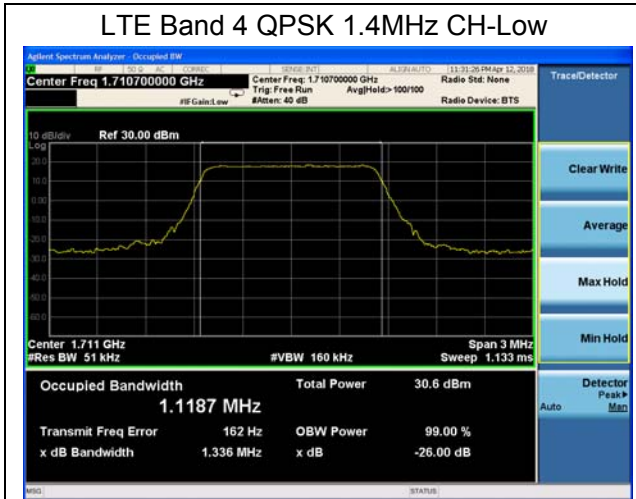

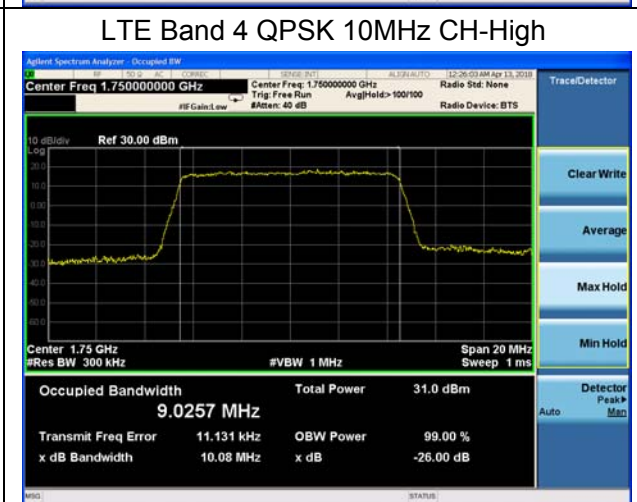
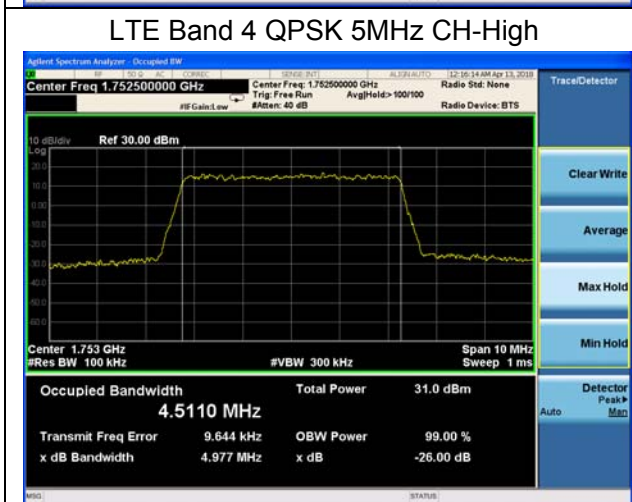
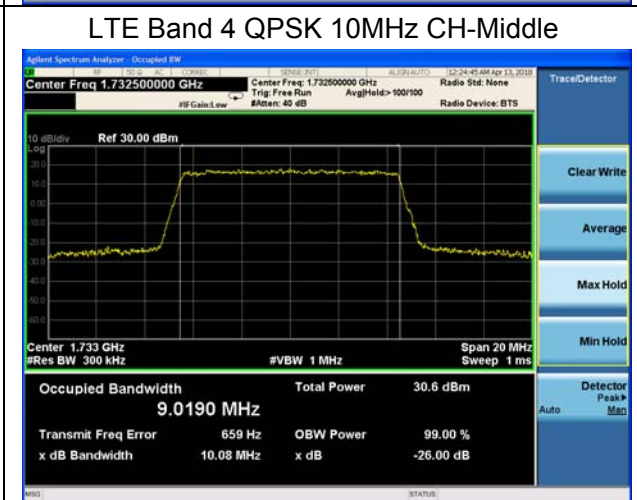
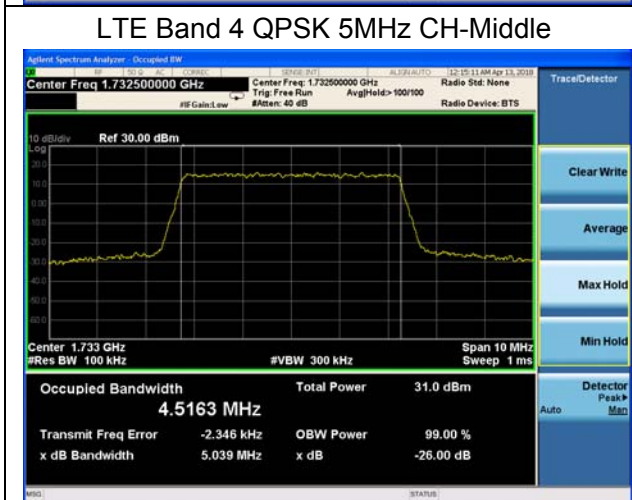
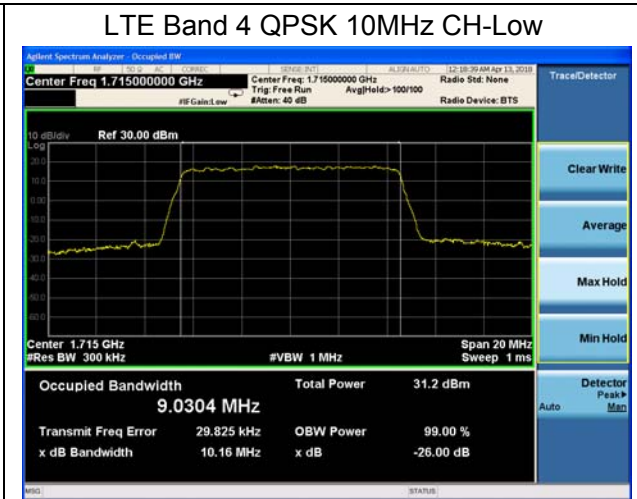
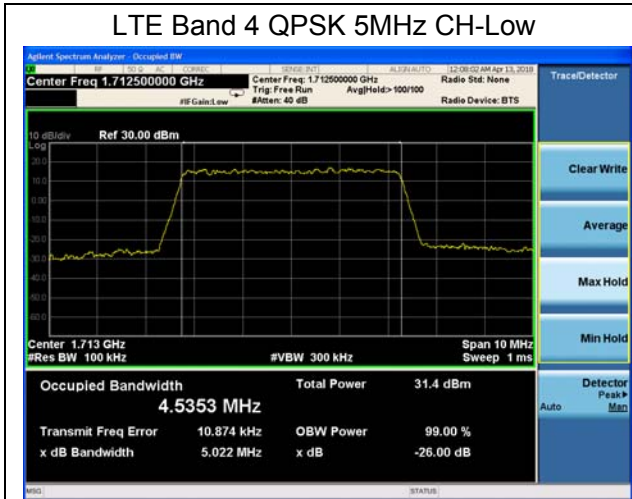



LTE Band 4 QPSK 15MHz CH-Low

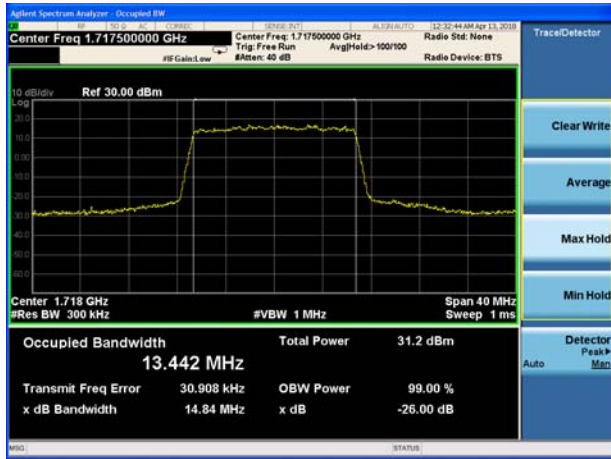

LTE Band 4 QPSK 20MHz CH-Low

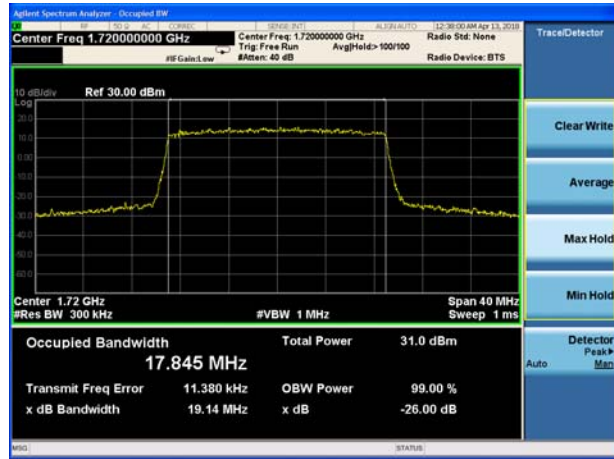

LTE Band 4 QPSK 15MHz CH-Middle

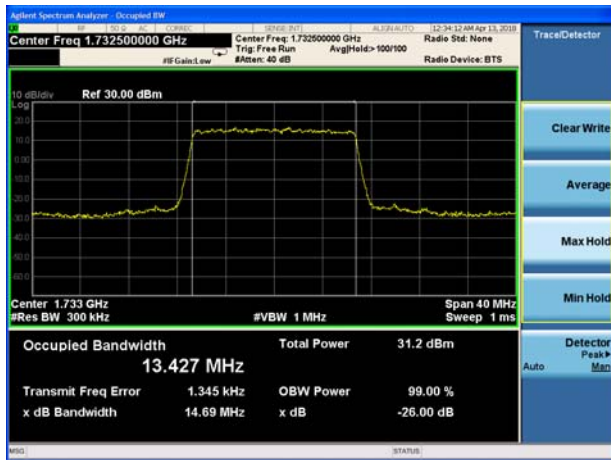

LTE Band 4 QPSK 20MHz CH-Middle

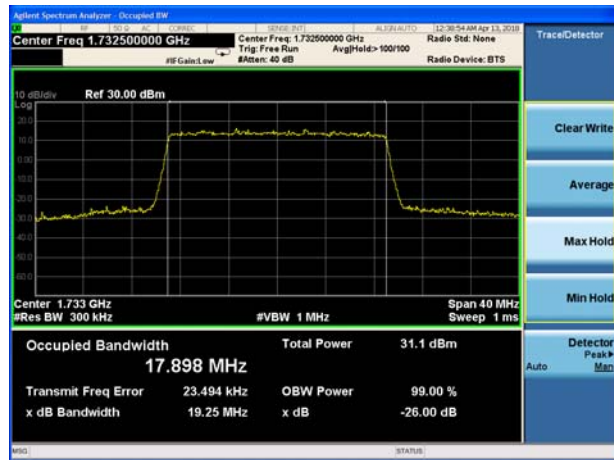

LTE Band 4 QPSK 15MHz CH-High

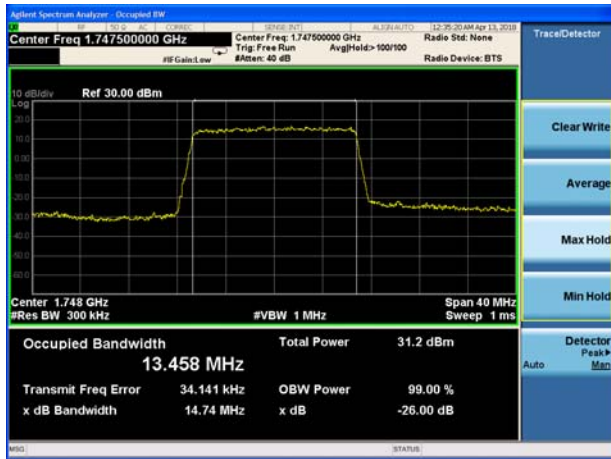

LTE Band 4 QPSK 20MHz CH-High

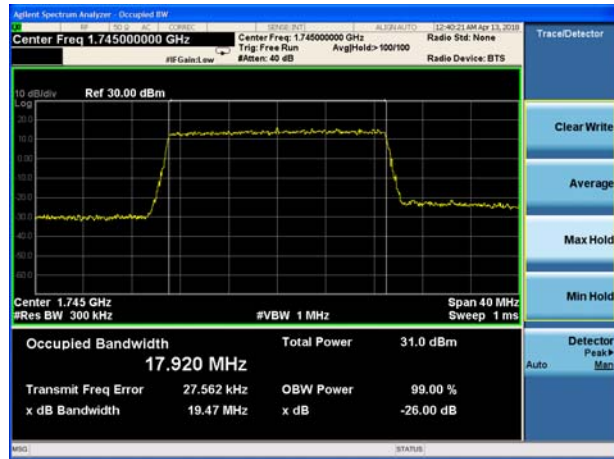

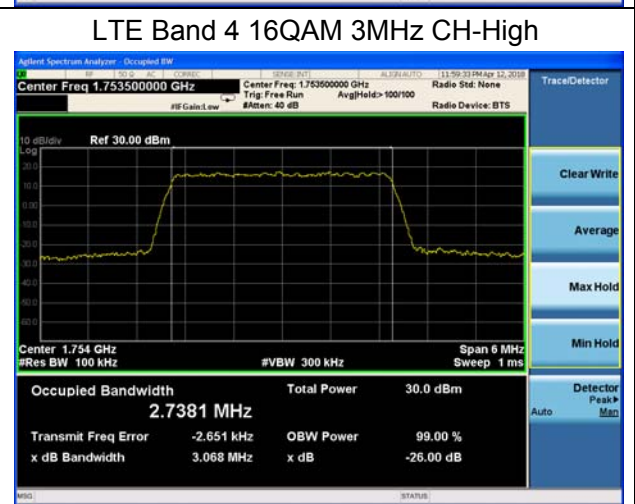
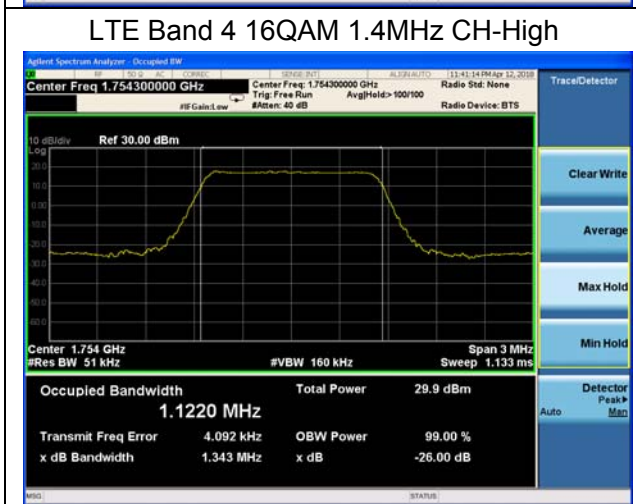
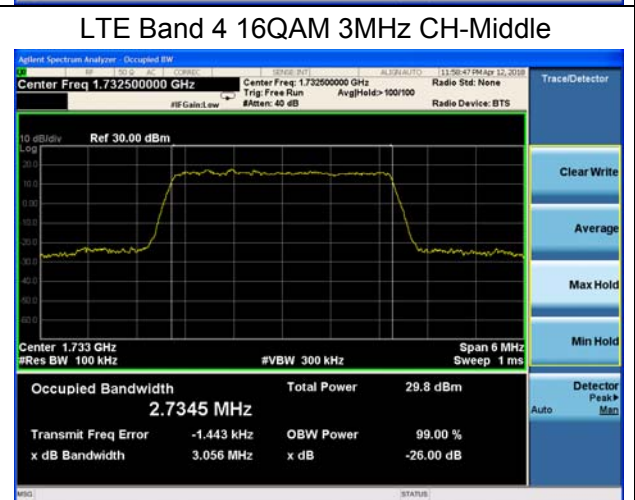
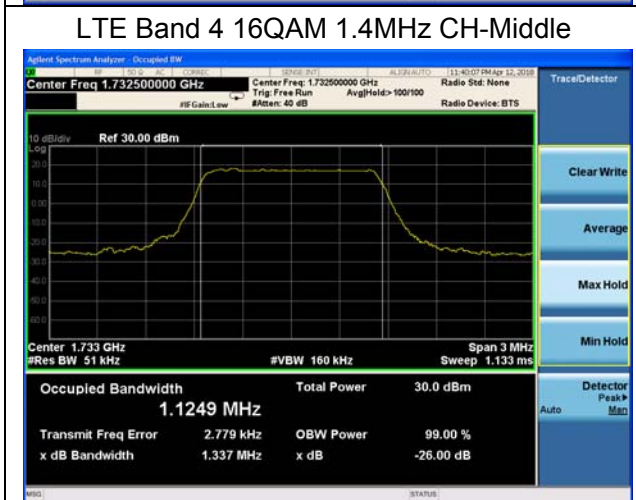
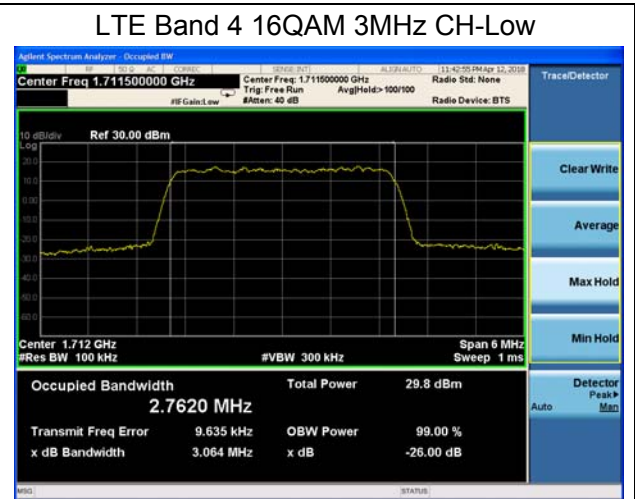
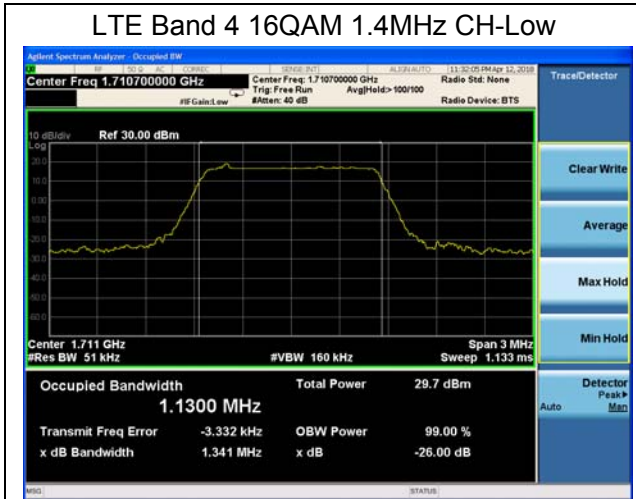

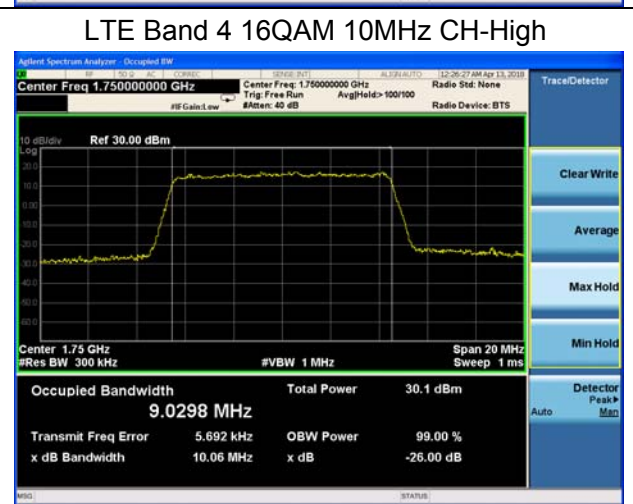
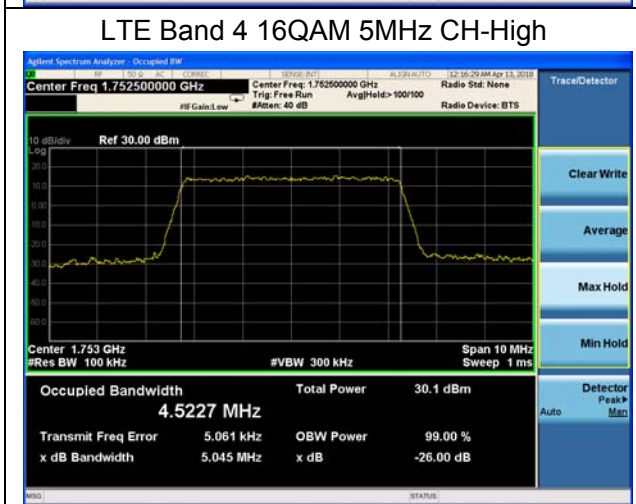
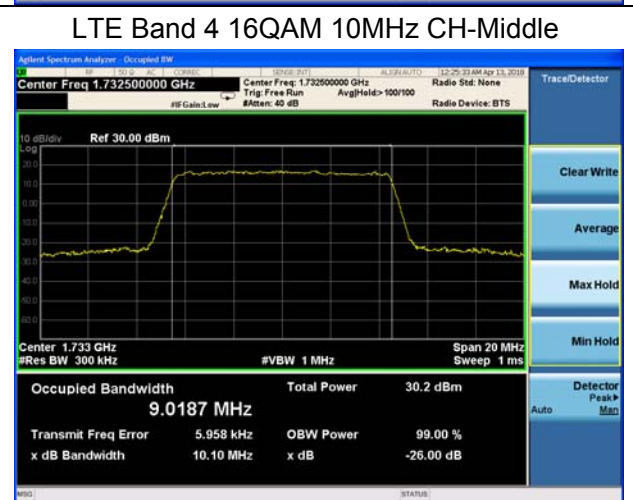
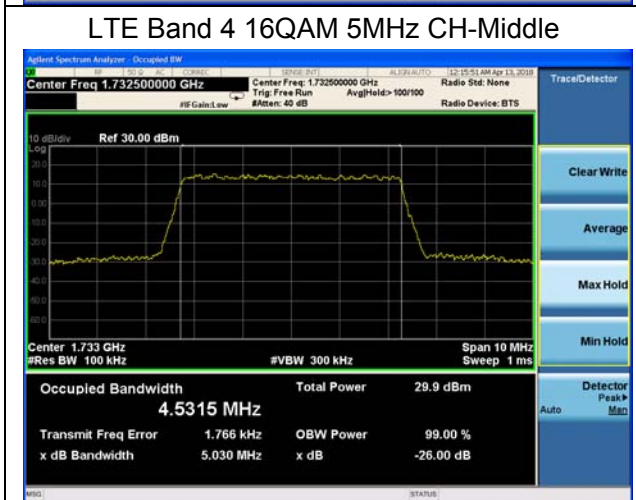
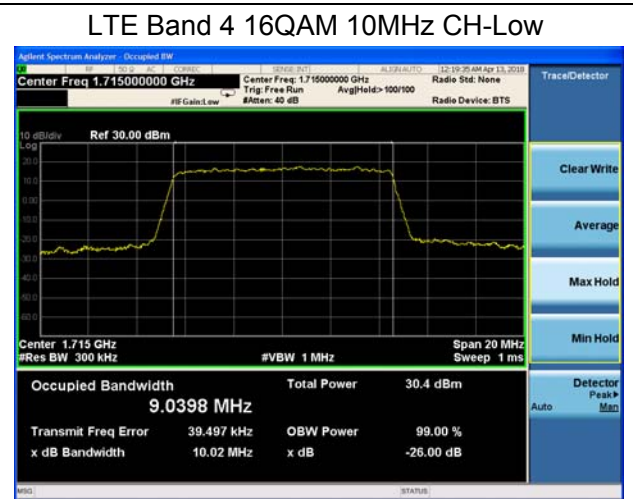
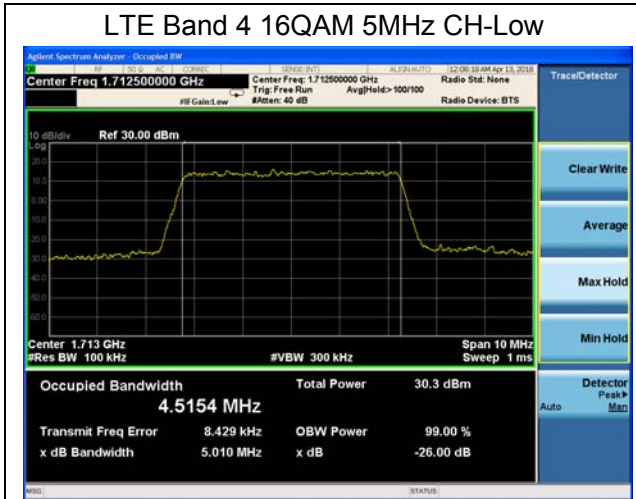

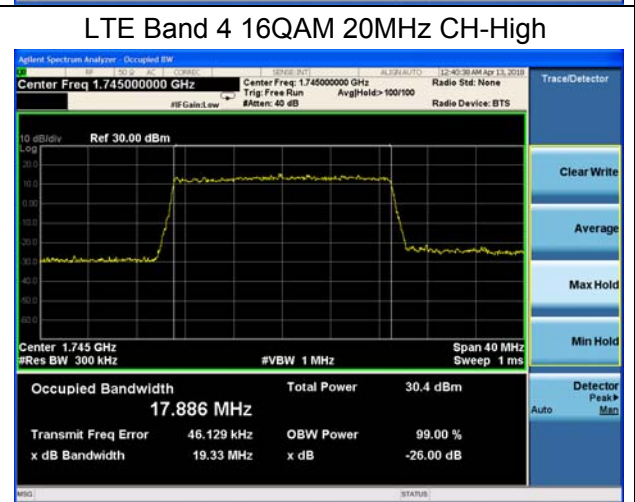
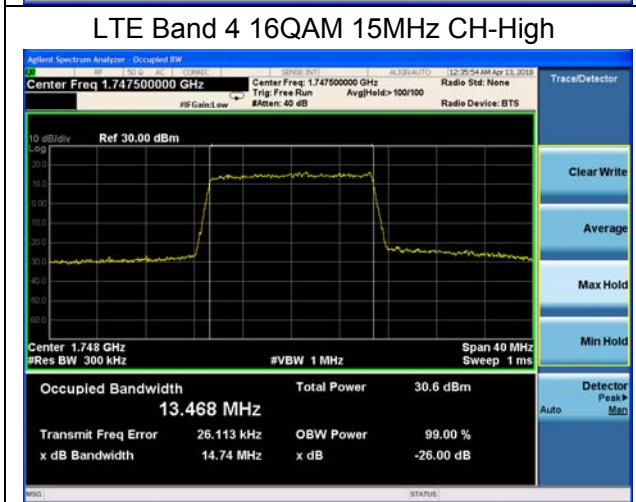
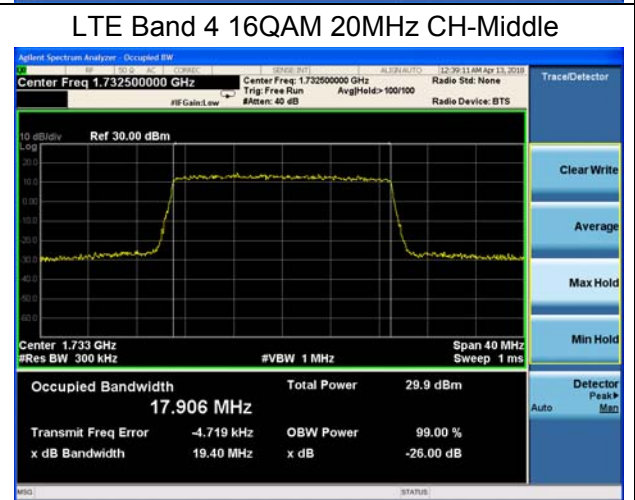
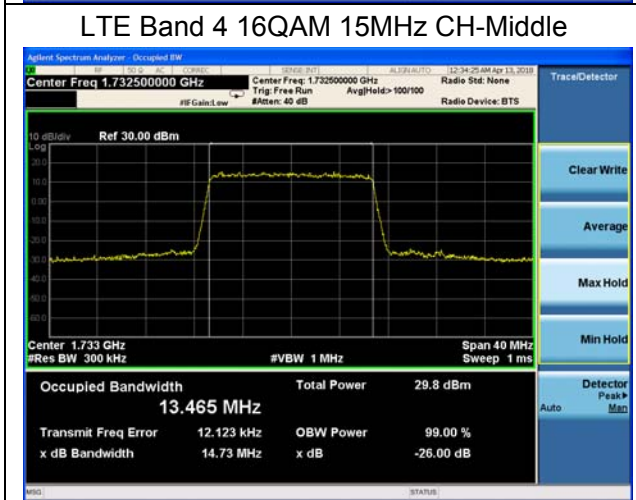
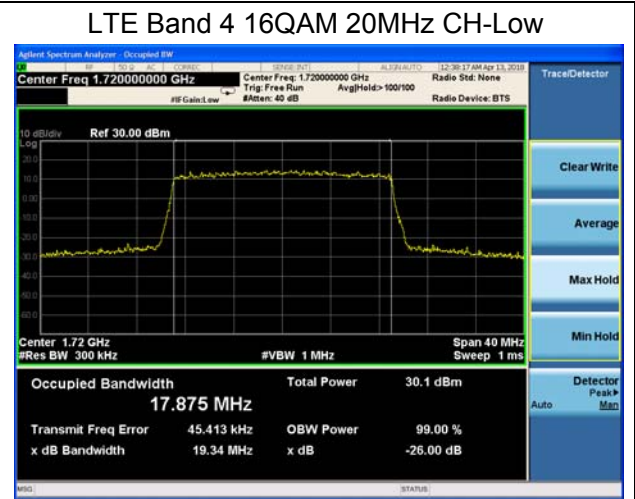
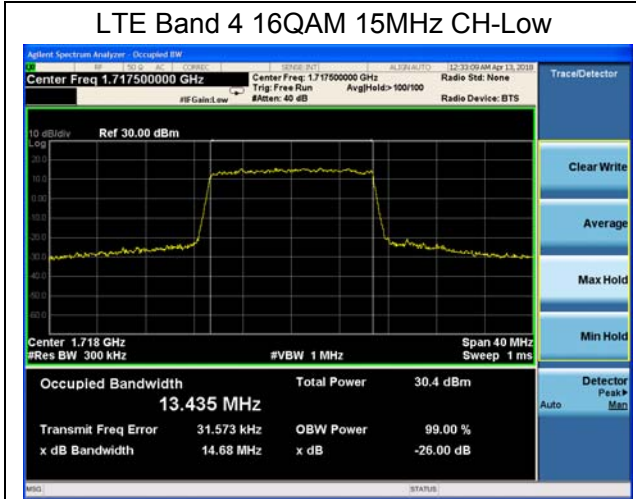

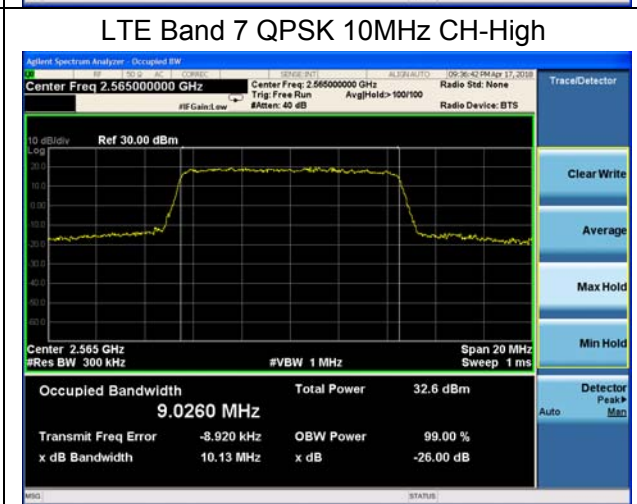
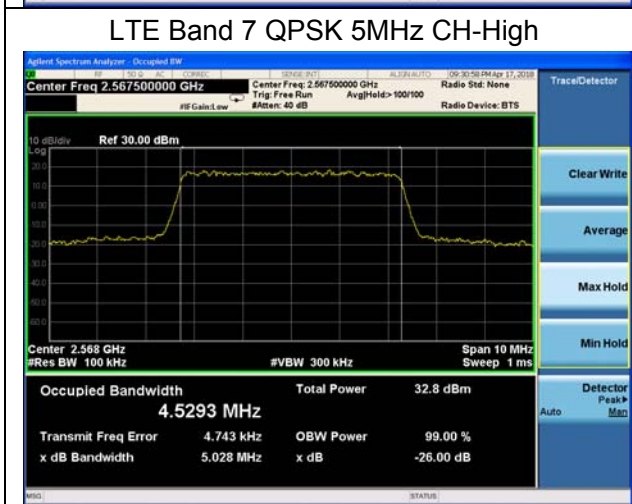
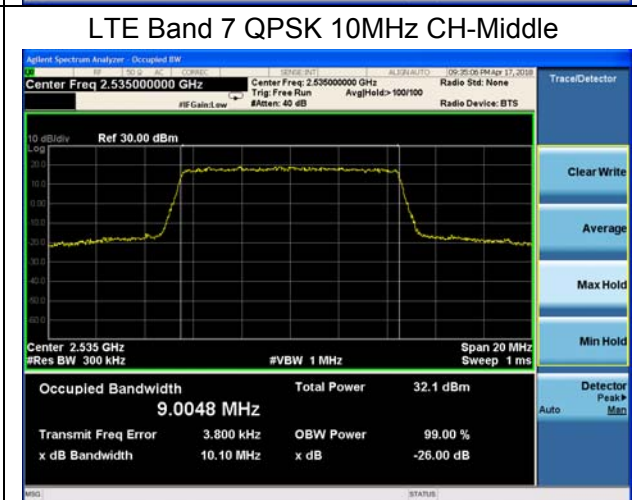
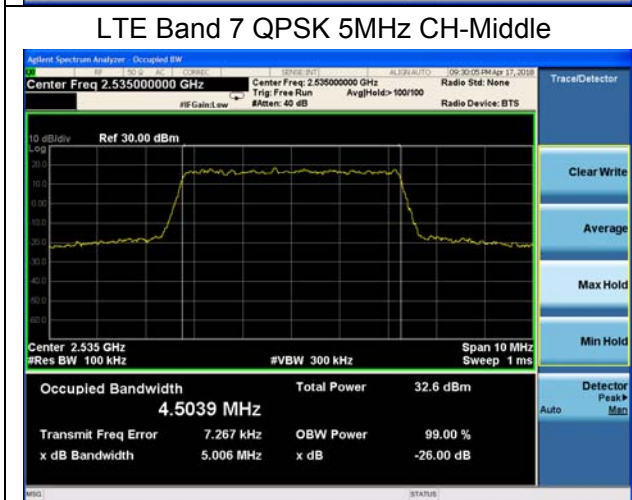
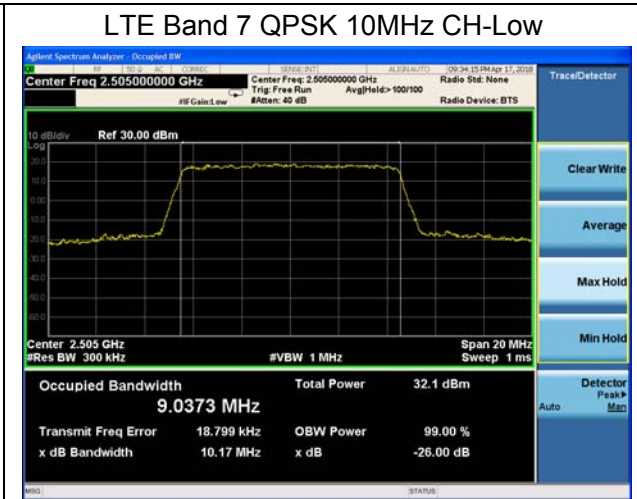
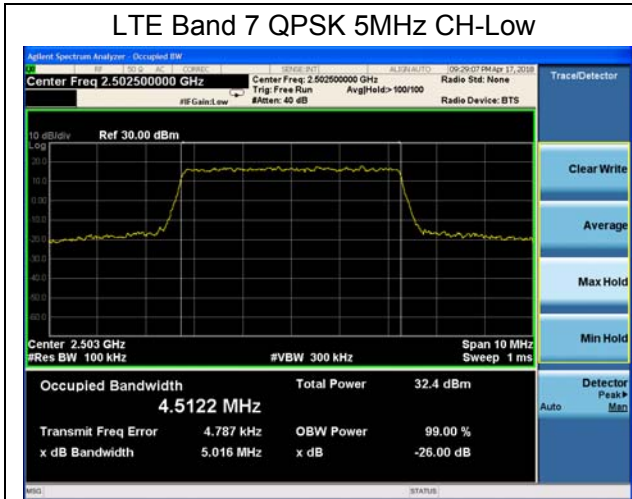

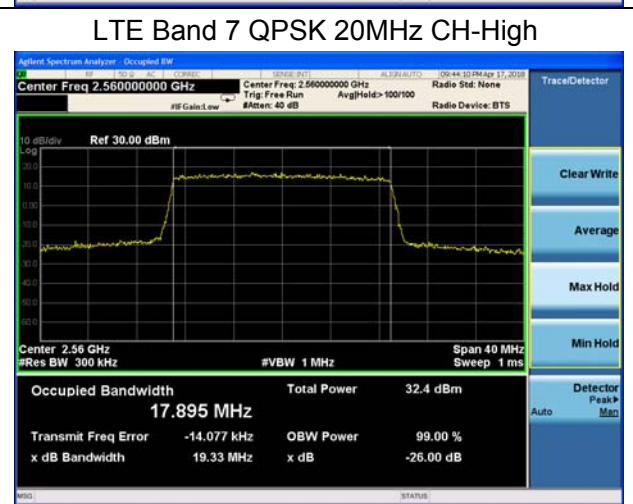
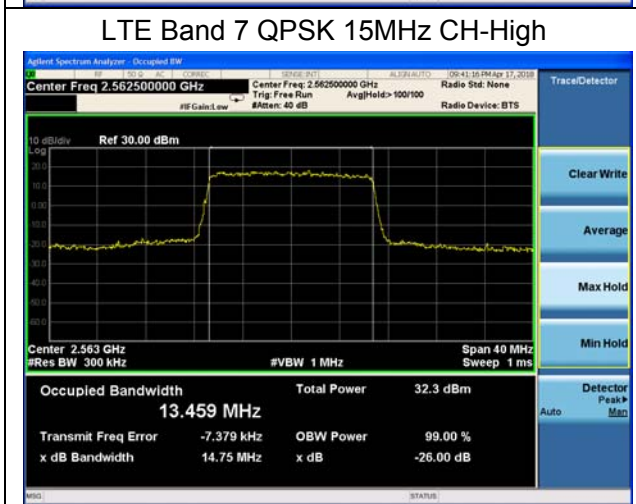
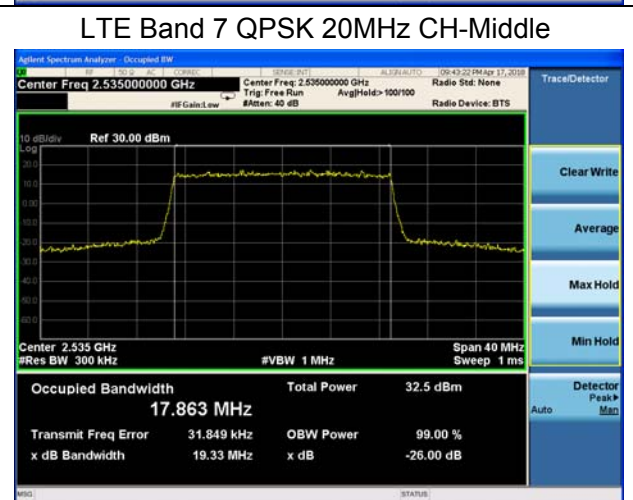
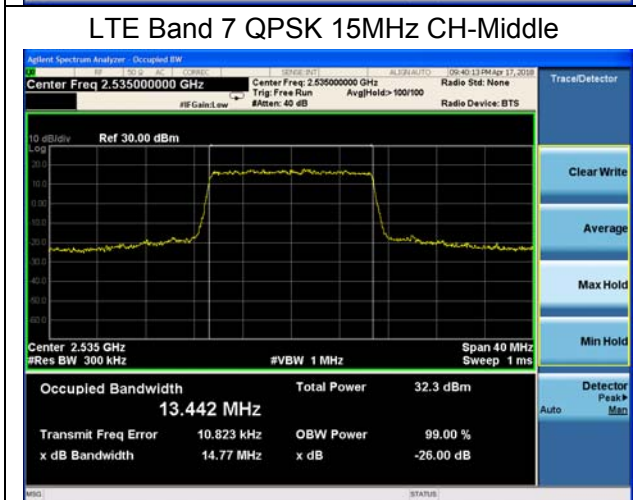
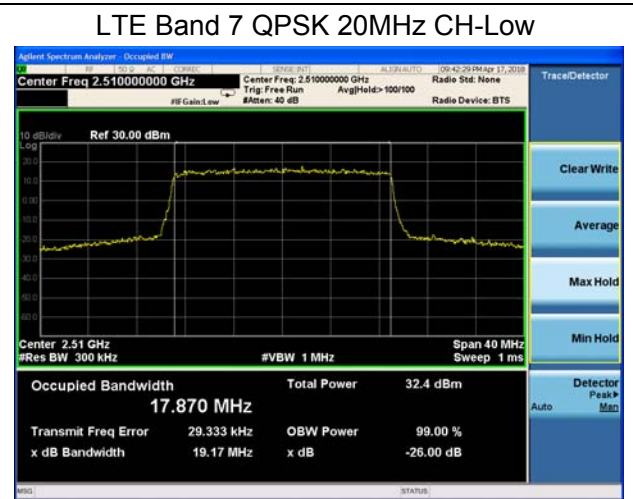
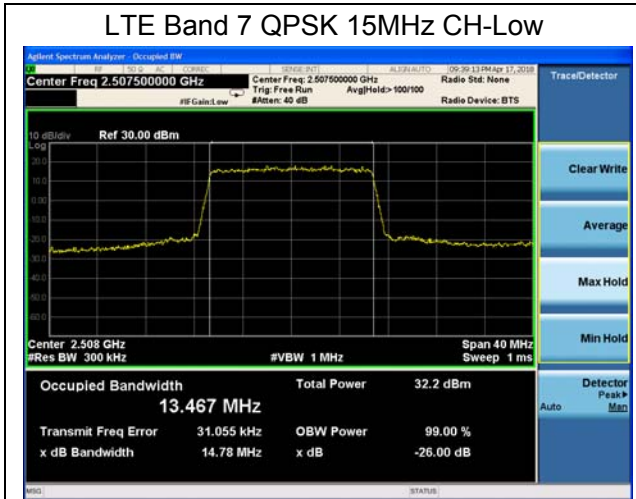

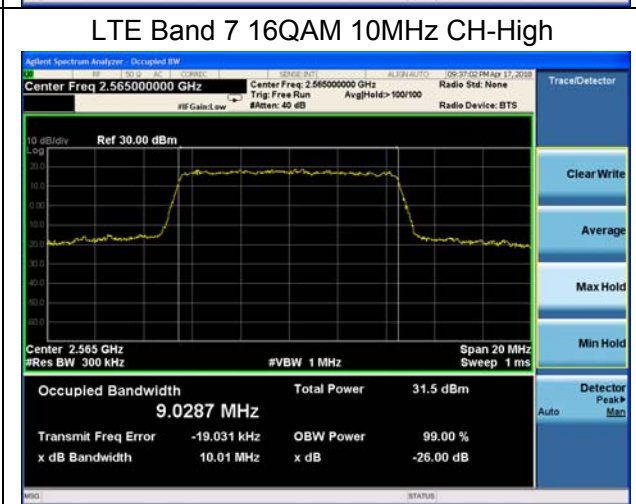
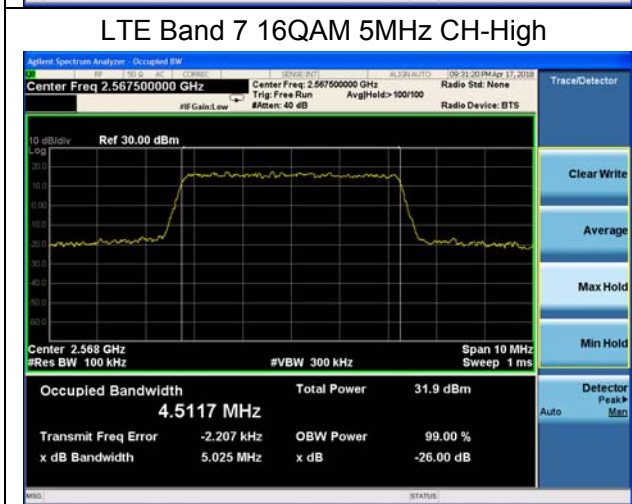
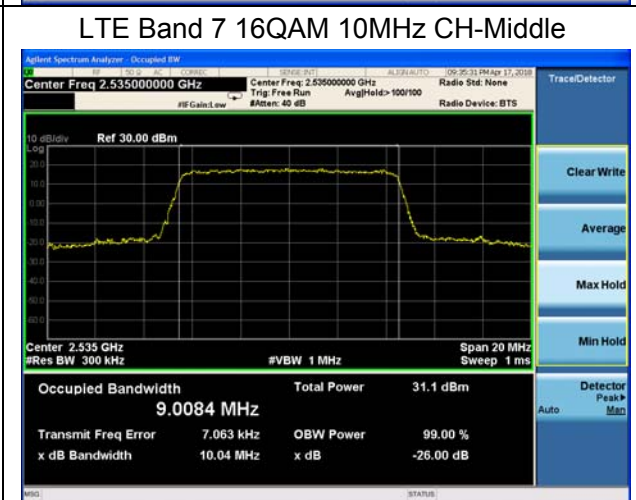
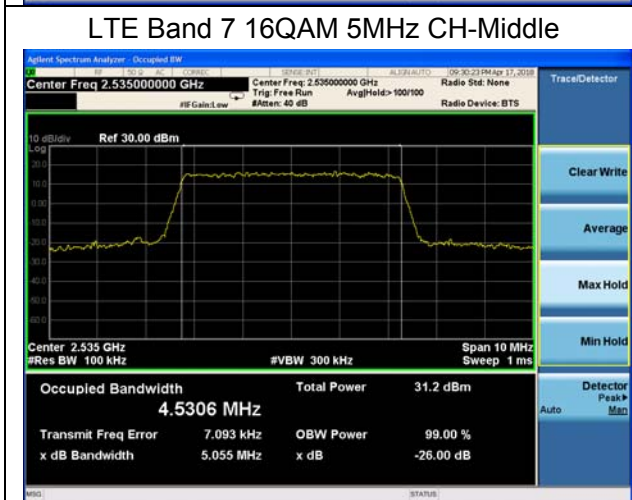
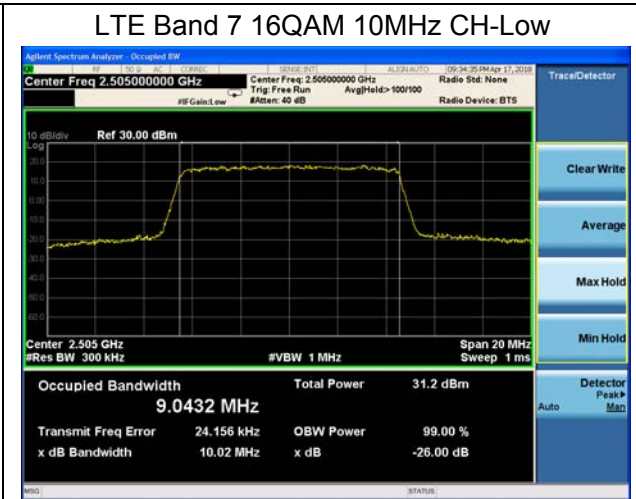
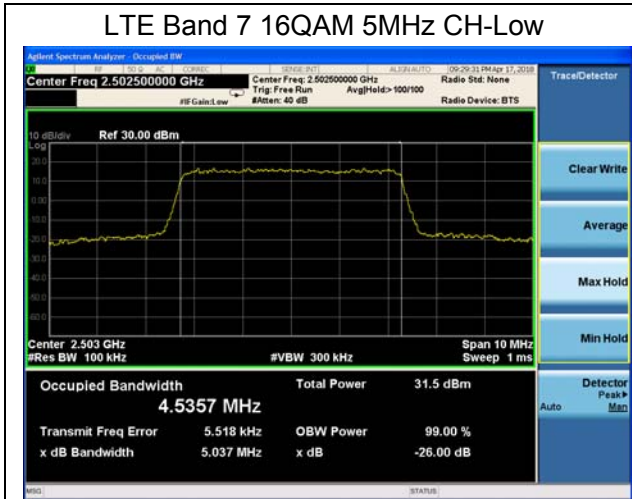

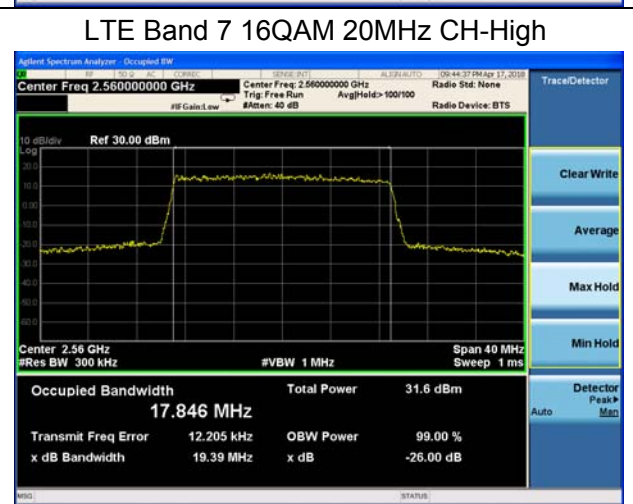
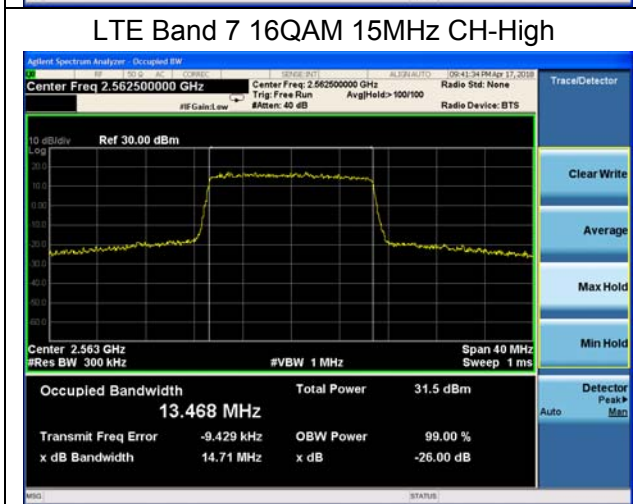
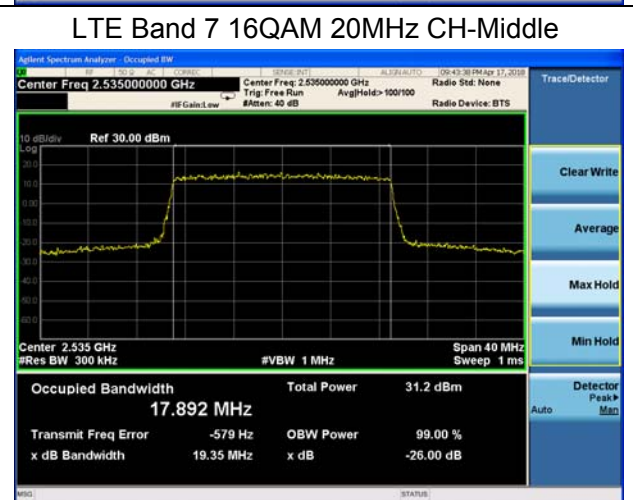
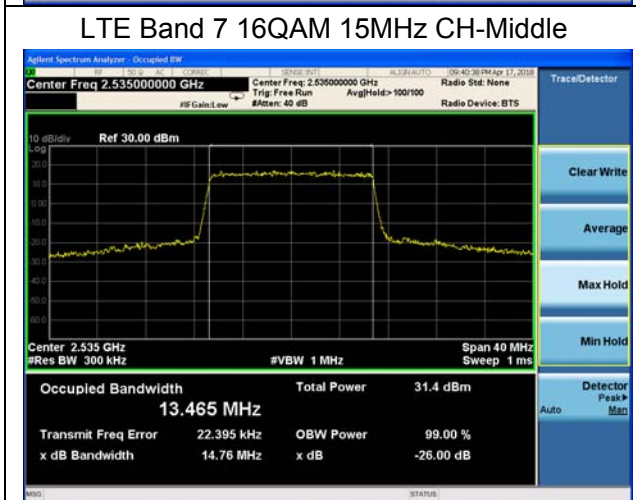
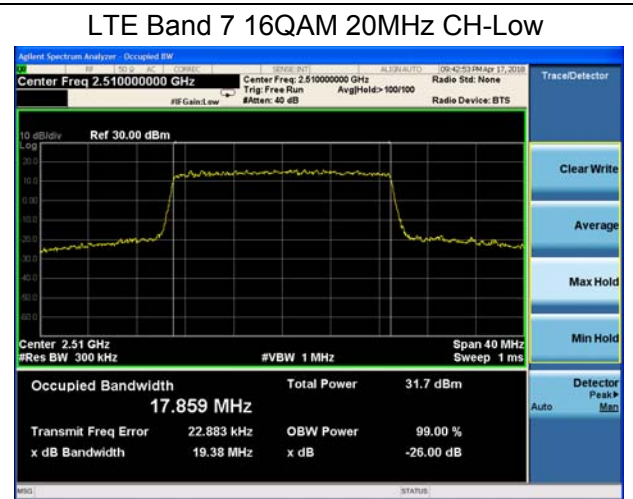
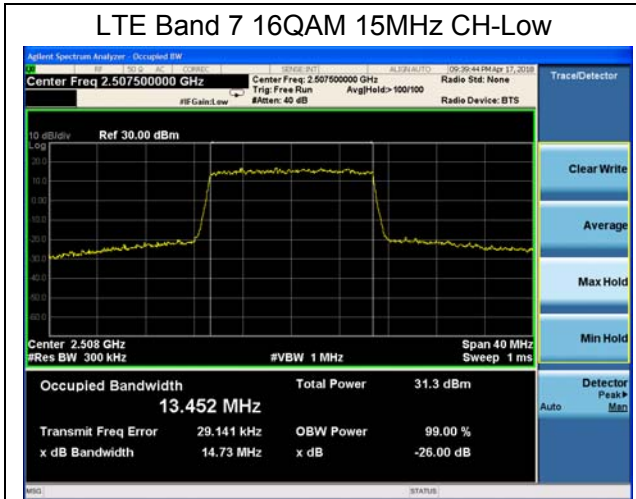

5.4 Band Edge Compliance

Ambient condition

Temperature	Relative humidity	Pressure
23°C ~25°C	45%~50%	101.5kPa

Method of Measurement

The EUT was connected to Spectrum Analyzer and Base Station Simulator via power Splitter. The band edge of the lowest and highest channels were measured.

The testing follows KDB 971168 D01 v03 Section 6.0

- 1.The EUT was connected to spectrum analyzer and system simulator via a power divider.
2. The band edges of low and high channels for the highest RF powers were measured.
 RBW is set to 15 kHz, VBW is set to 51 kHz for LTE Band 4 (1.4MHz).
 RBW is set to 30 kHz, VBW is set to 100 kHz for LTE Band 4 (3MHz).
 RBW is set to 51 kHz, VBW is set to 160 kHz for LTE Band 4 (5MHz).
 RBW is set to 100 kHz, VBW is set to 300kHz for LTE Band 4 (10MHz).
 RBW is set to 150 kHz, VBW is set to 510 kHz for LTE Band 4 (15MHz).
 RBW is set to 200 kHz, VBW is set to 620 kHz for LTE Band 4 (20MHz)
 RBW is set to 100 kHz, VBW is set to 300kHz for LTE Band 7 (5/10/15/20MHz) on spectrum analyzer.
4. Set spectrum analyzer with RMS detector.
5. The RF fundamental frequency should be excluded against the limit line in the operating frequency band.
6. Checked that all the results comply with the emission limit line.

Test Setup

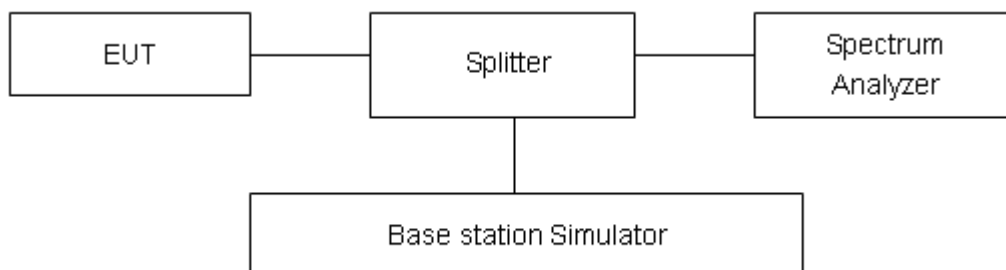

Limits

Rule Part 27.53(h)/ specifies that “ for operations in the 1695-1710 MHz, 1710-1755 MHz, 1755-1780 MHz, 1915-1920 MHz, 1995-2000 MHz, 2000-2020 MHz, 2110-2155 MHz, 2155-2180 MHz, and 2180-2200 bands, the power of any emission outside a licensee's frequency block shall be attenuated below the transmitter power (P) in watts by at least $43 + 10 \log_{10} (P)$ dB”

Part 27.53(m) (4)/ specifies that “for BRS and EBS stations. For mobile digital stations, the attenuation factor shall be not less than $40 + 10 \log (P)$ dB on all frequencies between the channel edge and 5 megahertz from the channel edge, $43 + 10 \log (P)$ dB on all frequencies between 5 megahertz and X megahertz from the channel edge, and $55 + 10 \log (P)$ dB on all frequencies more than X megahertz from the channel edge, where X is the greater of 6 megahertz or the actual emission bandwidth as defined in paragraph (m)(4) of this section. In addition, the attenuation factor shall not be less that $43 + 10 \log (P)$ dB on all frequencies between 2490.5 MHz and 2496 MHz and $55 + 10 \log (P)$ dB at or below 2490.5 MHz. Mobile Satellite Service licensees operating on frequencies below 2495 MHz may also submit a documented interference complaint against BRS licensees operating on channel BRS Channel 1 on the same terms and conditions as adjacent channel BRS or EBS licensees.

Example:

The limit line is derived from $43 + 10 \log (P)$ dB below the transmitter power P(Watts)

$$= P(W) - [43 + 10 \log(P)] \text{ (dB)}$$

$$= [30 + 10 \log (P)] \text{ (dBm)} - [43 + 10 \log(P)] \text{ (dB)} = -13 \text{ dBm.}$$

Measurement Uncertainty

The assessed measurement uncertainty to ensure 95% confidence level for the normal distribution is with the coverage factor $k = 1.96$, $U=0.684$ dB.

Test Result

All the test traces in the plots shows the test results clearly.

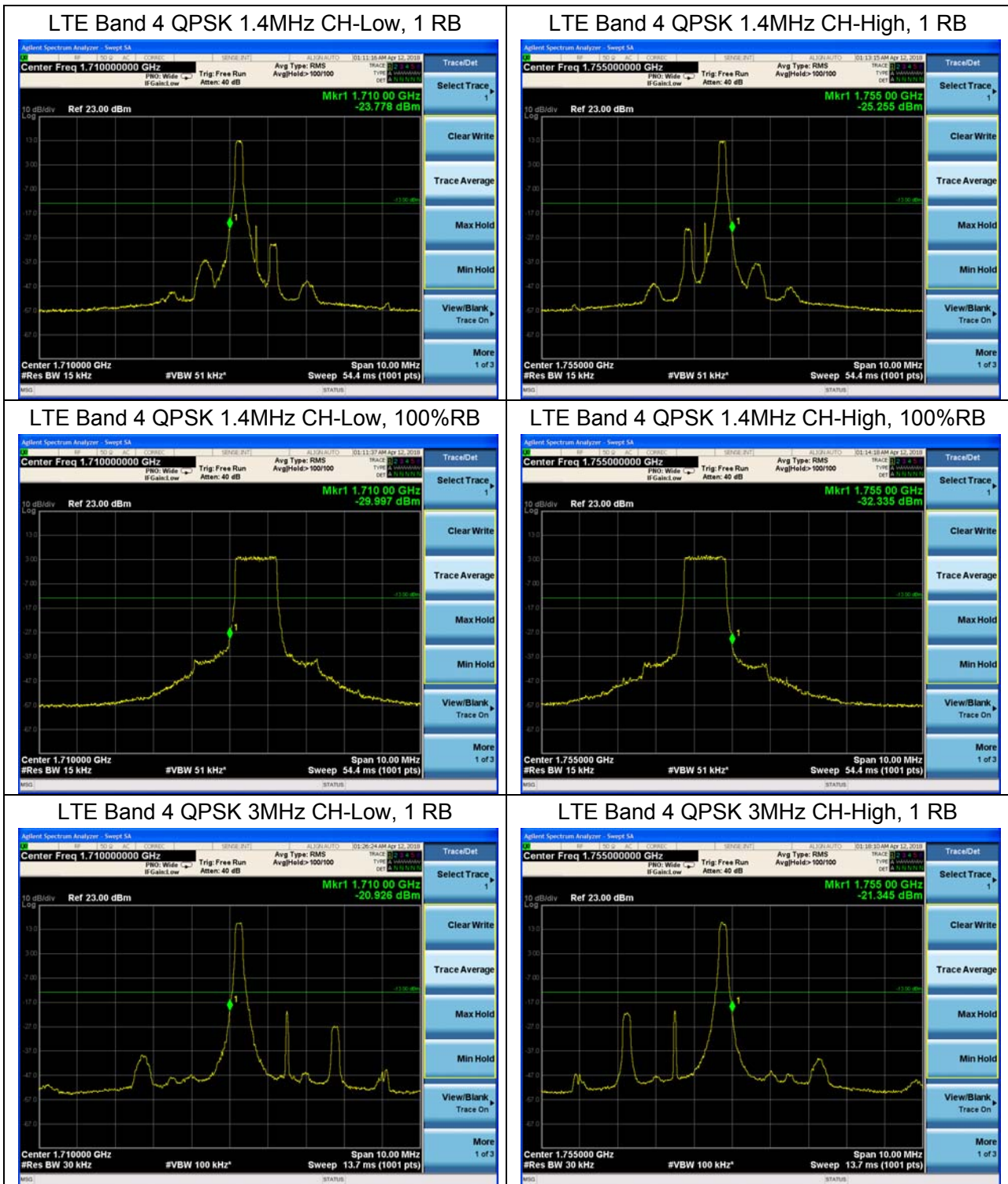



LTE Band 4 QPSK 3MHz CH-Low, 100%RB



LTE Band 4 QPSK 3MHz CH-High, 100%RB



LTE Band 4 QPSK 5MHz CH-Low, 1 RB

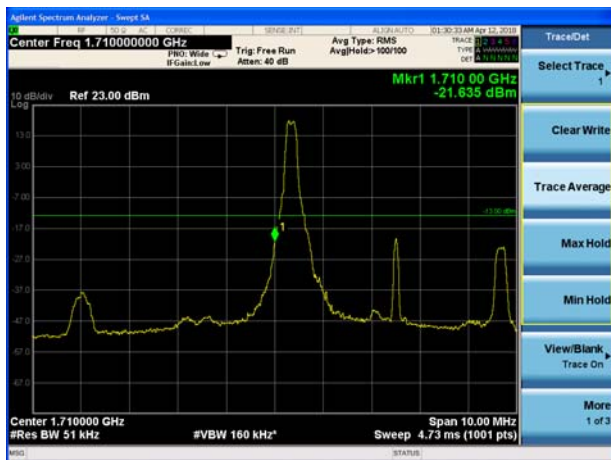

LTE Band 4 QPSK 5MHz CH-High, 1 RB

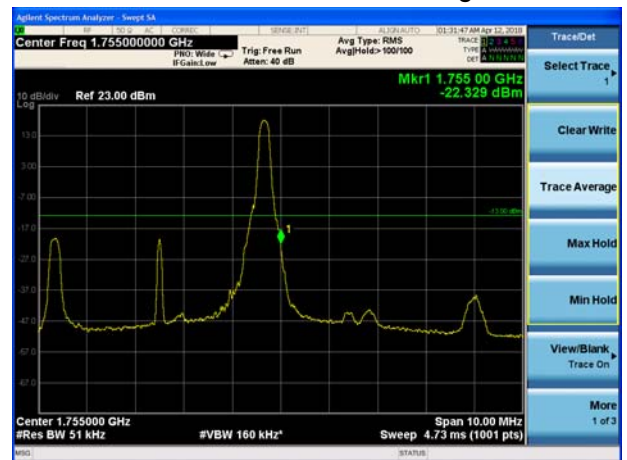

LTE Band 4 QPSK 5MHz CH-Low, 100%RB

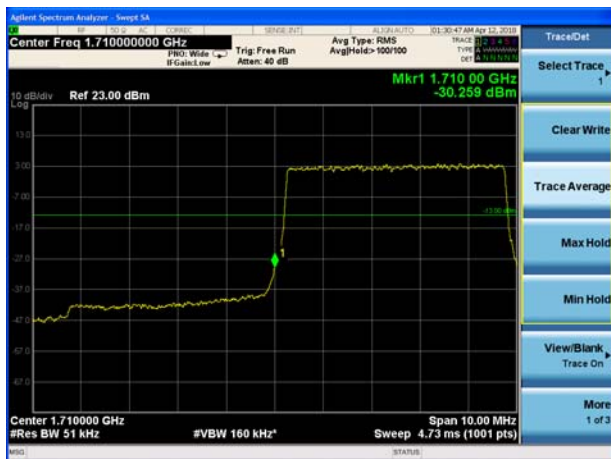

LTE Band 4 QPSK 5MHz CH-High, 100%RB





LTE Band 4 QPSK 10MHz CH-Low, 1 RB

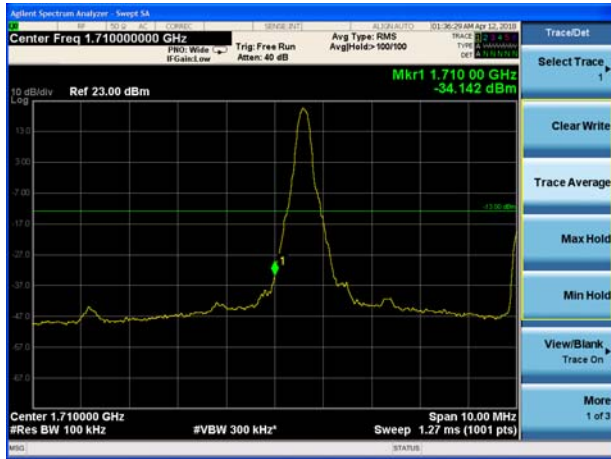

LTE Band 4 QPSK 10MHz CH-High, 1 RB

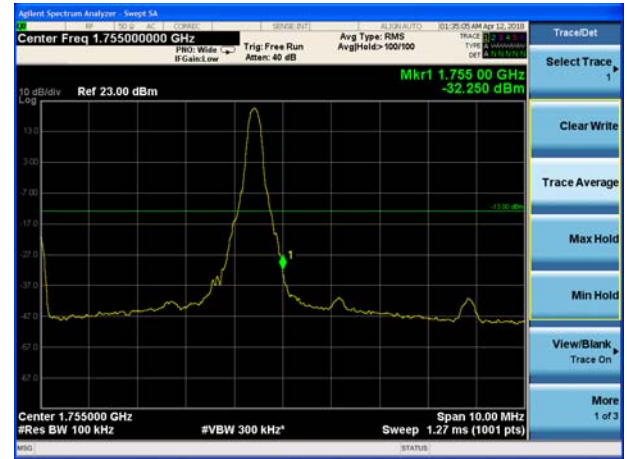

LTE Band 4 QPSK 10MHz CH-Low, 100%RB



LTE Band 4 QPSK 10MHz CH-High, 100%RB



LTE Band 4 QPSK 15MHz CH-Low, 1 RB

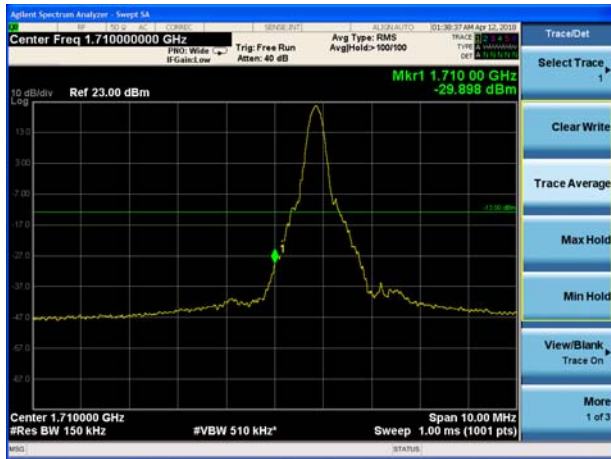

LTE Band 4 QPSK 15MHz CH-High, 1 RB





LTE Band 4 QPSK 15MHz CH-Low, 100%RB



LTE Band 4 QPSK 15MHz CH-High, 100%RB



LTE Band 4 QPSK 20MHz CH-Low, 1 RB

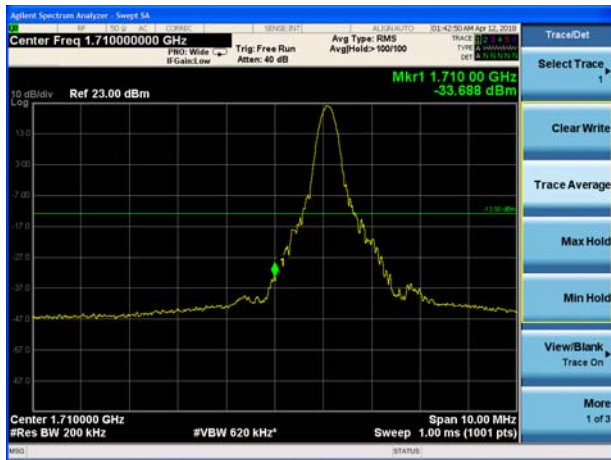

LTE Band 4 QPSK 20MHz CH-High, 1 RB

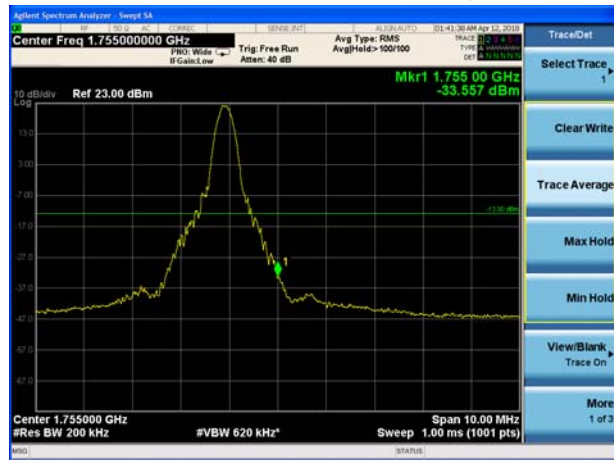

LTE Band 4 QPSK 20MHz CH-Low, 100%RB



LTE Band 4 QPSK 20MHz CH-High, 100%RB





LTE Band 4 16QAM 1.4MHz CH-Low, 1 RB

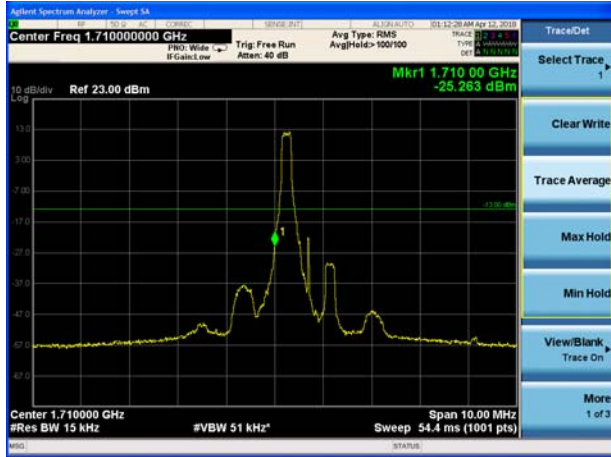

LTE Band 4 16QAM 1.4MHz CH-High, 1 RB

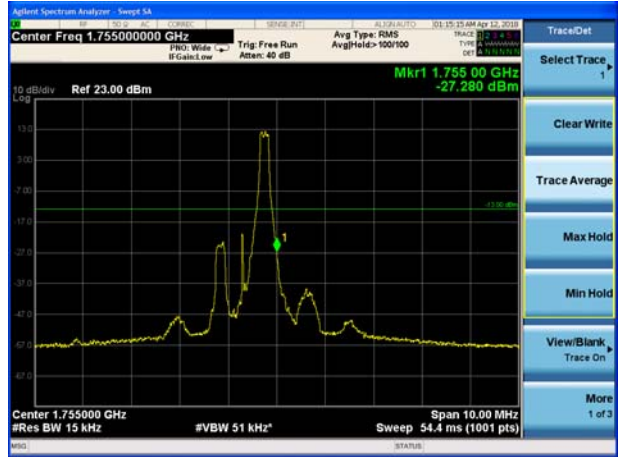

LTE Band 4 16QAM 1.4MHz CH-Low, 100%RB

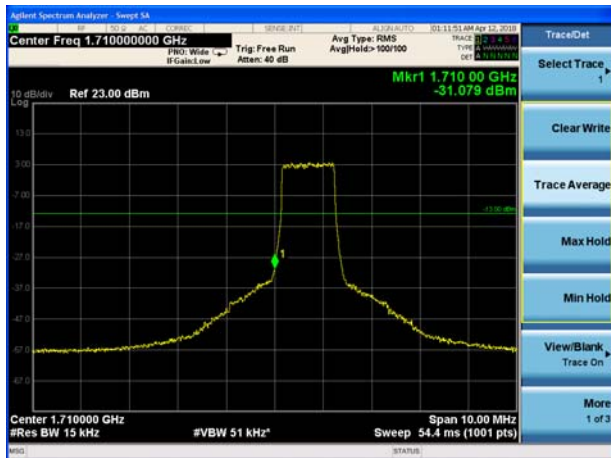

LTE Band 4 16QAM 1.4MHz CH-High, 100%RB

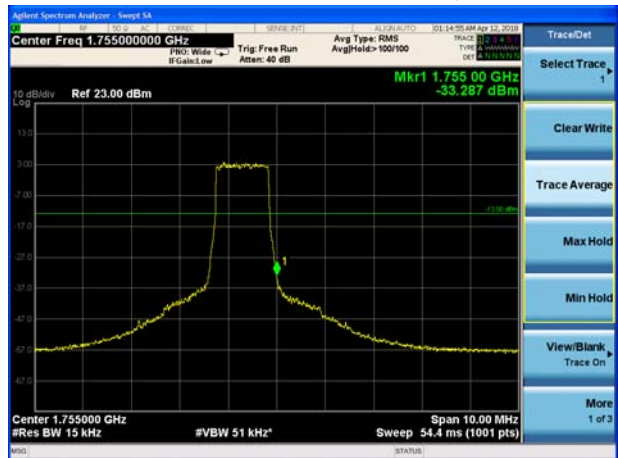

LTE Band 4 16QAM 3MHz CH-Low, 1 RB

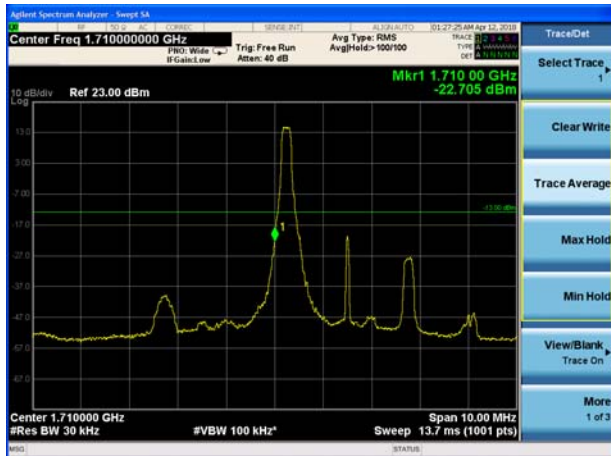

LTE Band 4 16QAM 3MHz CH-High, 1 RB

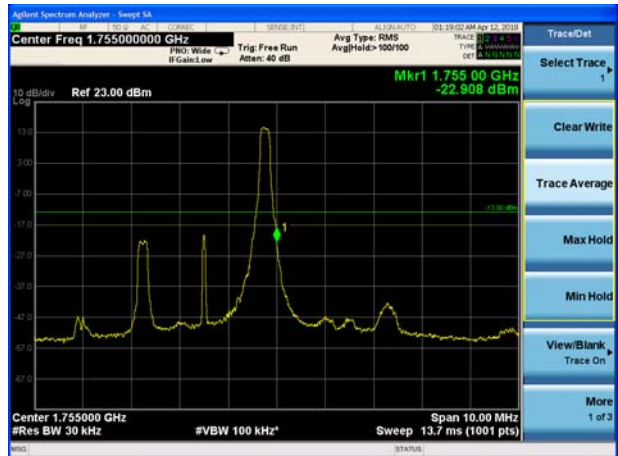



LTE Band 4 16QAM 3MHz CH-Low, 100%RB



LTE Band 4 16QAM 3MHz CH-High, 100%RB



LTE Band 4 16QAM 5MHz CH-Low, 1 RB

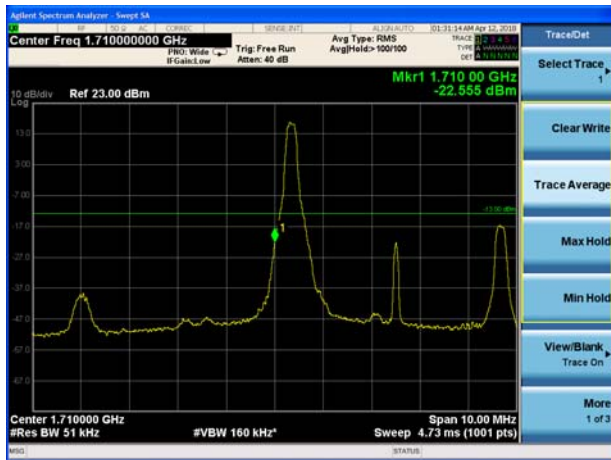

LTE Band 4 16QAM 5MHz CH-High, 1 RB

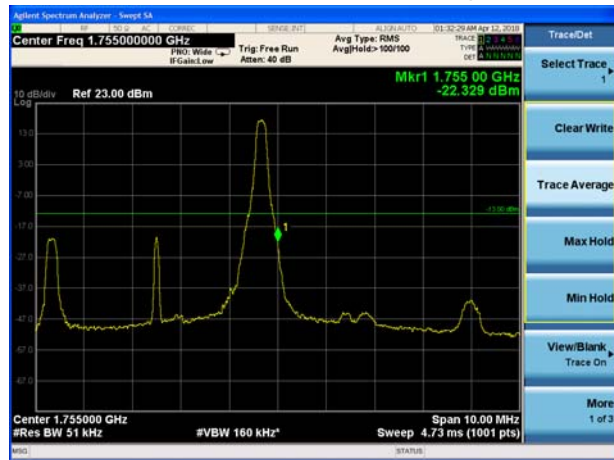

LTE Band 4 16QAM 5MHz CH-Low, 100%RB



LTE Band 4 16QAM 5MHz CH-High, 100%RB





LTE Band 4 16QAM 10MHz CH-Low, 1 RB

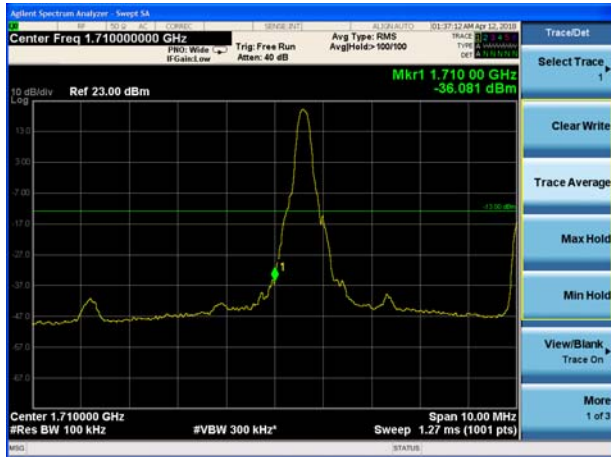

LTE Band 4 16QAM 10MHz CH-High, 1 RB

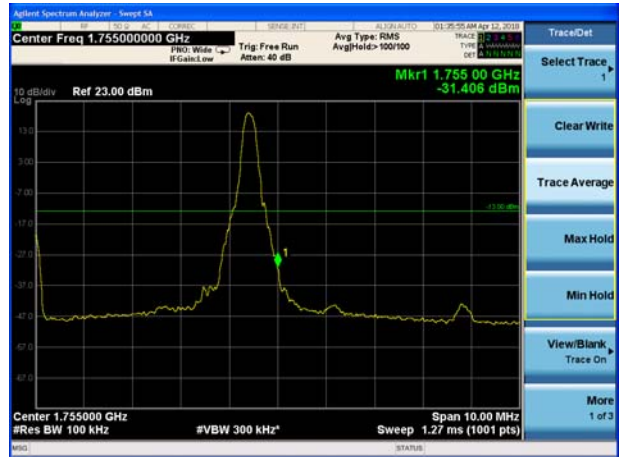

LTE Band 4 16QAM 10MHz CH-Low, 100%RB

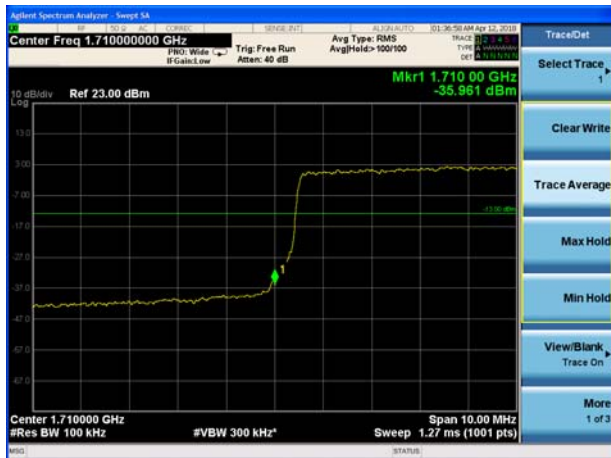

LTE Band 4 16QAM 10MHz CH-High, 100%RB

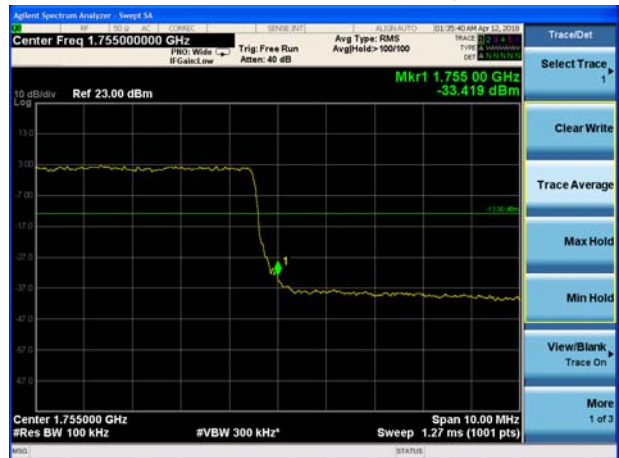

LTE Band 4 16QAM 15MHz CH-Low, 1 RB

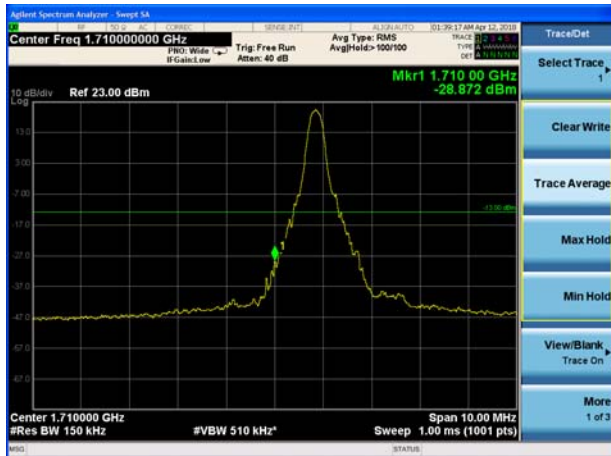

LTE Band 4 16QAM 15MHz CH-High, 1 RB

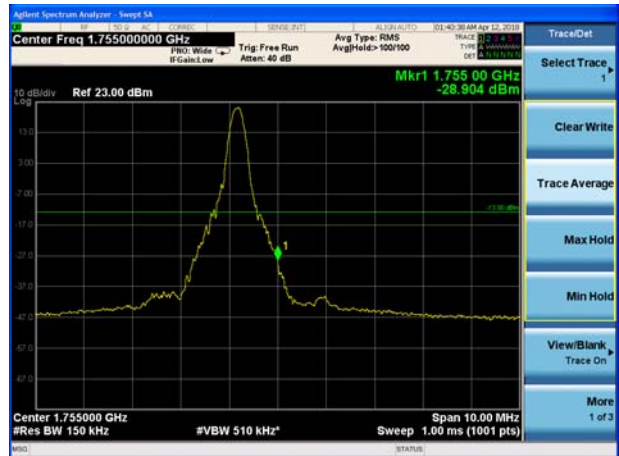



LTE Band 4 16QAM 15MHz CH-Low, 100%RB



LTE Band 4 16QAM 15MHz CH-High, 100%RB



LTE Band 4 16QAM 20MHz CH-Low, 1 RB

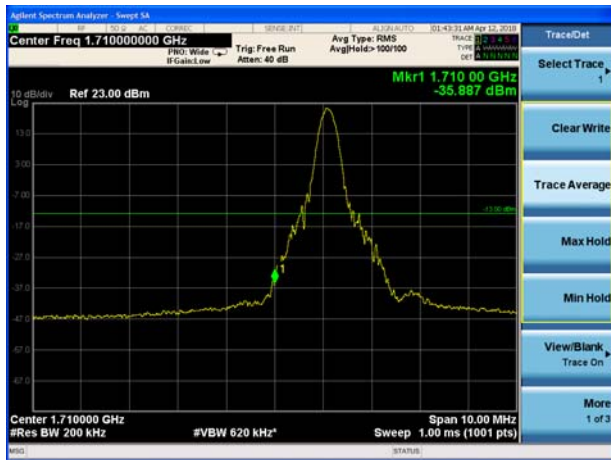

LTE Band 4 16QAM 20MHz CH-High, 1 RB

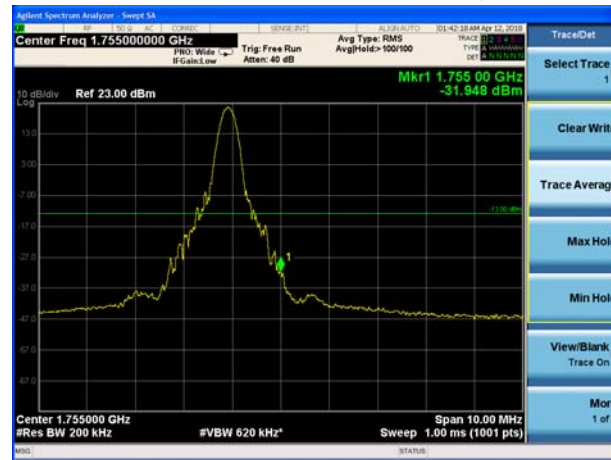

LTE Band 4 16QAM 20MHz CH-Low, 100%RB



LTE Band 4 16QAM 20MHz CH-High, 100%RB

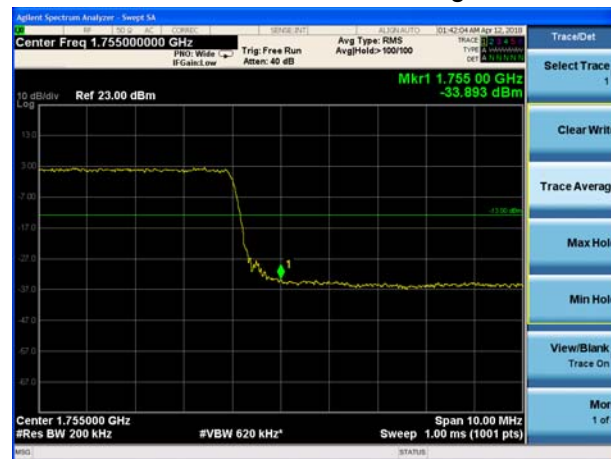

LTE Band 7 QPSK 5MHz CH-Low, 1 RB

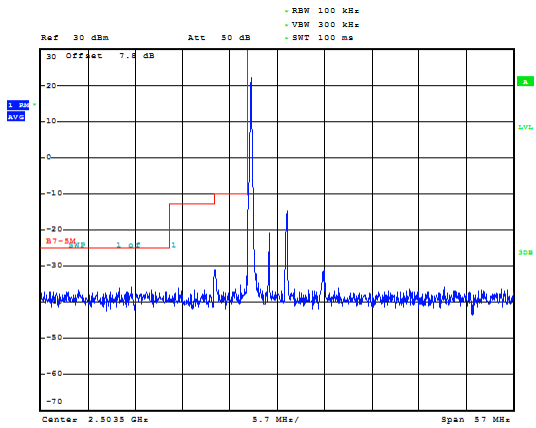

LTE Band 7 QPSK 5MHz CH-High, 1 RB

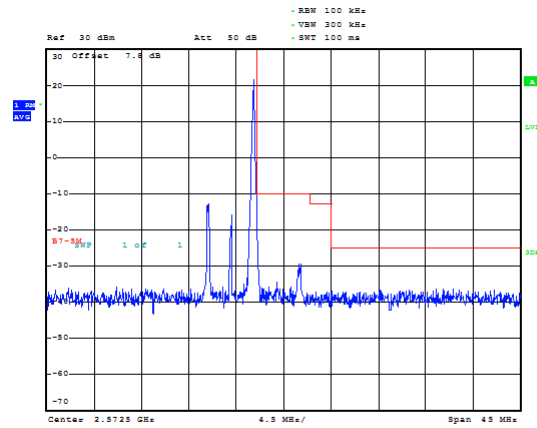

LTE Band 7 QPSK 5MHz CH-Low, 100%RB

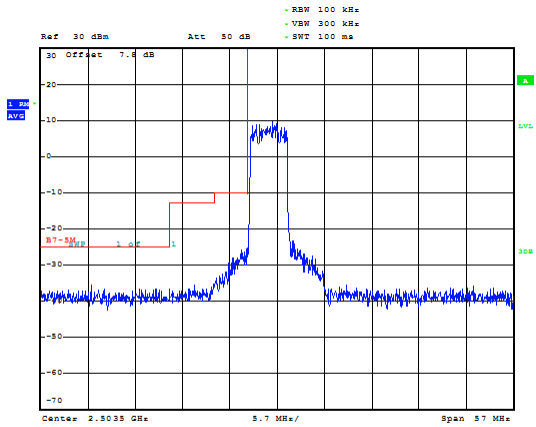

LTE Band 7 QPSK 5MHz CH-High, 100%RB

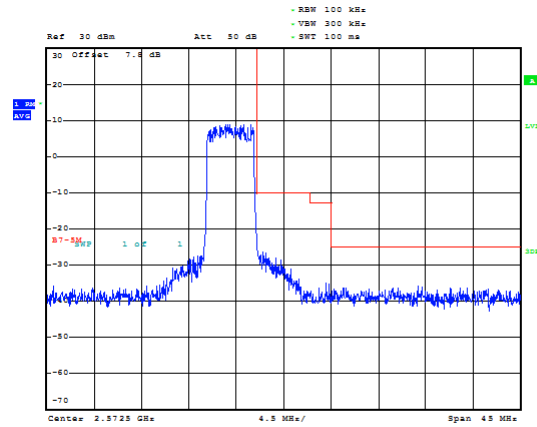

LTE Band 7 QPSK 10MHz CH-Low, 1 RB

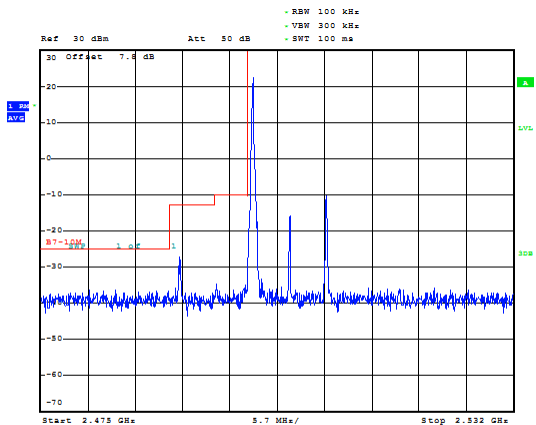

LTE Band 7 QPSK 10MHz CH-High, 1 RB

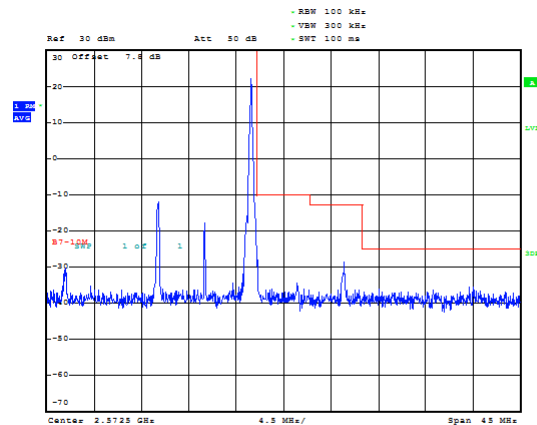



LTE Band 7 QPSK 10MHz CH-Low, 100%RB

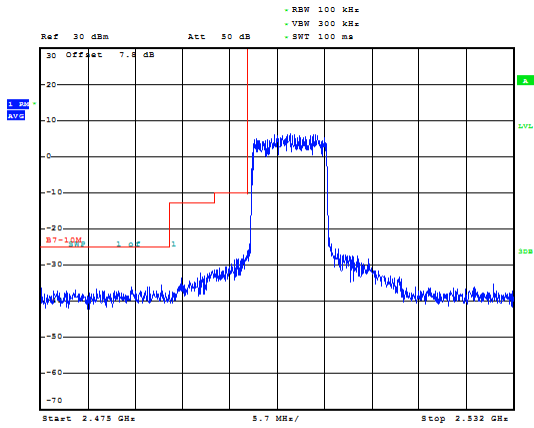

LTE Band 7 QPSK 10MHz CH-High, 100%RB

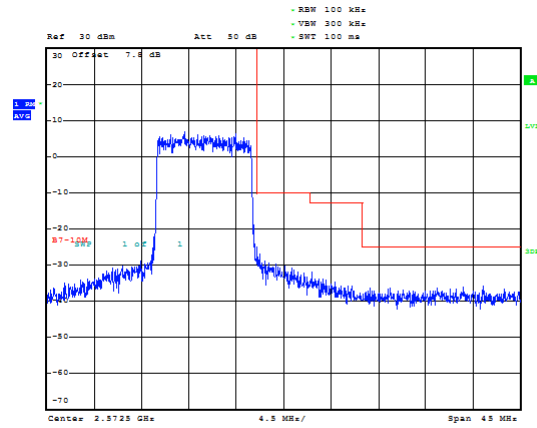

LTE Band 7 QPSK 15MHz CH-Low, 1 RB

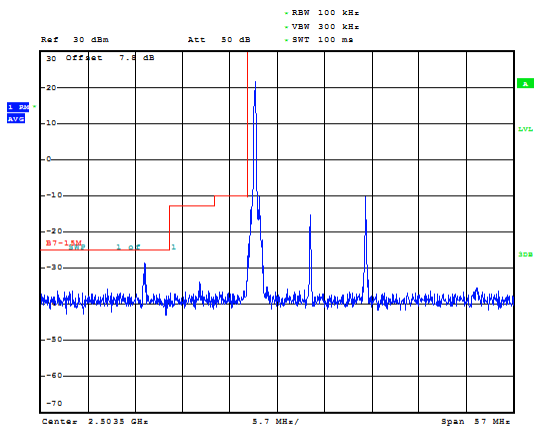

LTE Band 7 QPSK 15MHz CH-High, 1 RB

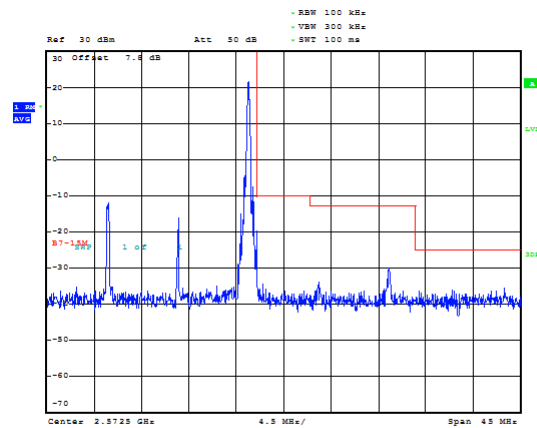

LTE Band 7 QPSK 15MHz CH-Low, 100%RB

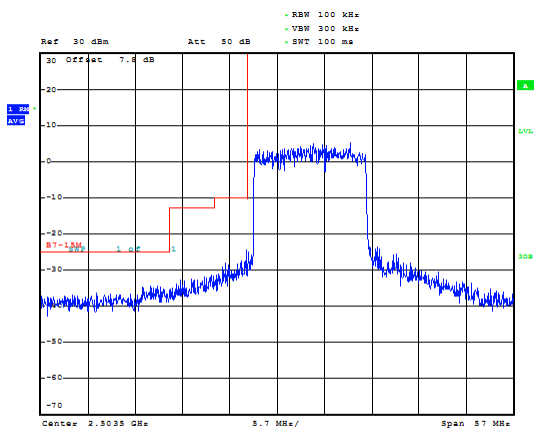

LTE Band 7 QPSK 15MHz CH-High, 100%RB

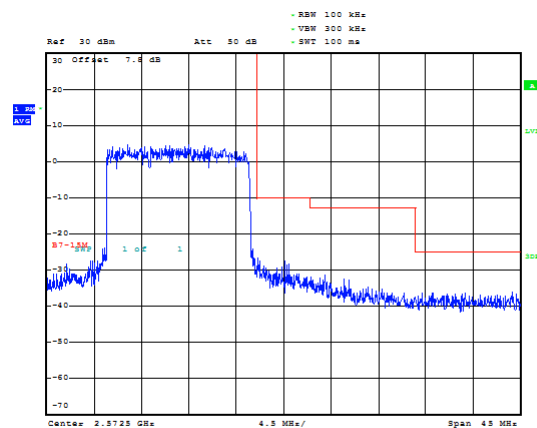



LTE Band 7 QPSK 20MHz CH-Low, 1 RB

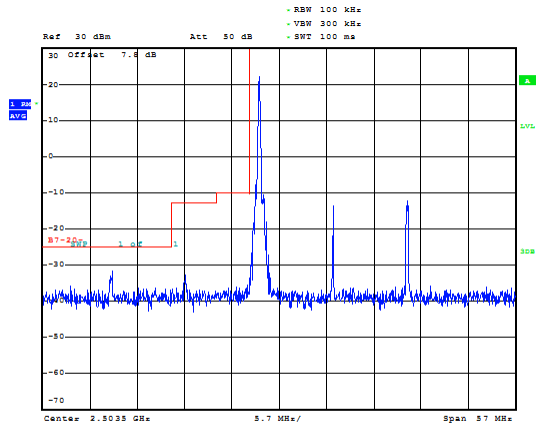

LTE Band 7 QPSK 20MHz CH-High, 1 RB

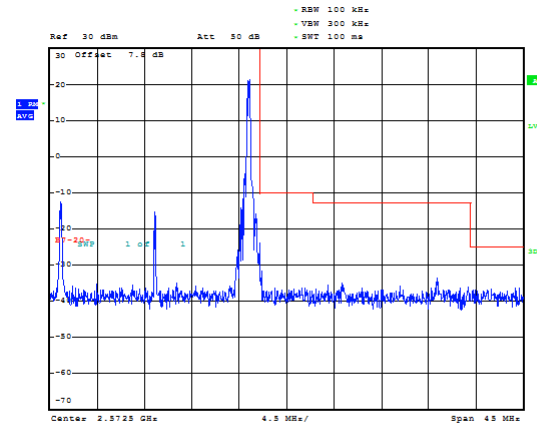

LTE Band 7 QPSK 20MHz CH-Low, 100%RB

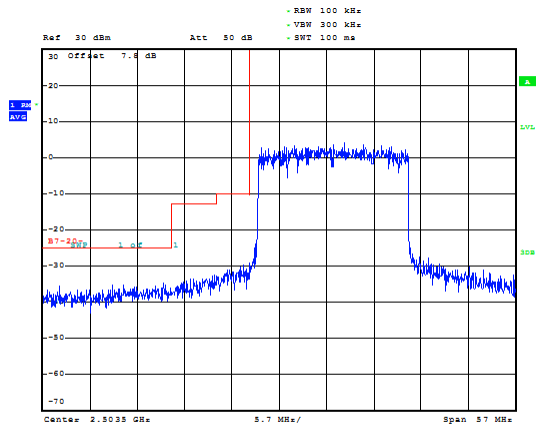

LTE Band 7 QPSK 20MHz CH-High, 100%RB

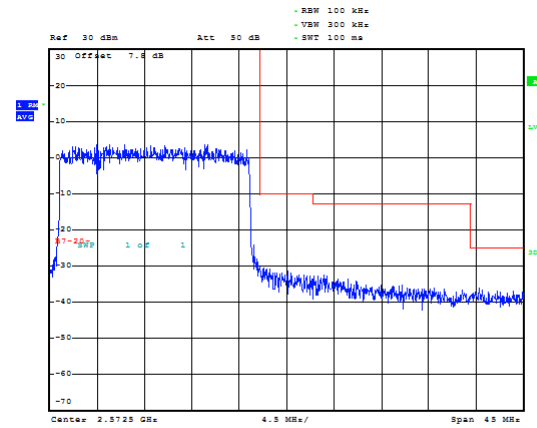

LTE Band 7 16QAM 5MHz CH-Low, 1 RB

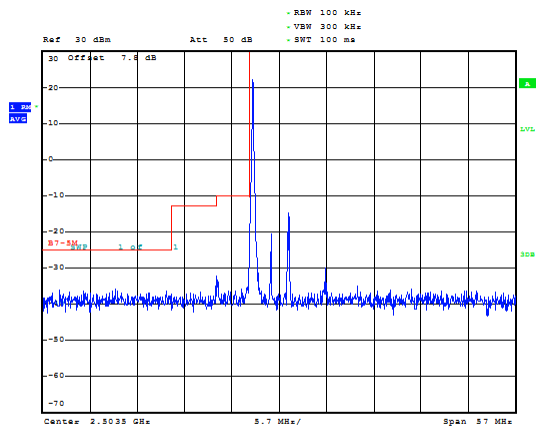

LTE Band 7 16QAM 5MHz CH-High, 1 RB

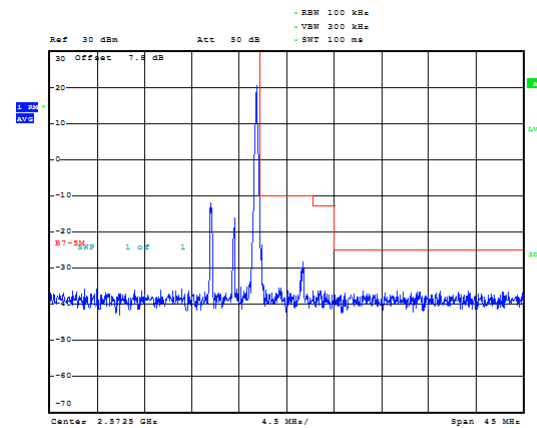



LTE Band 7 16QAM 5MHz CH-Low, 100%RB

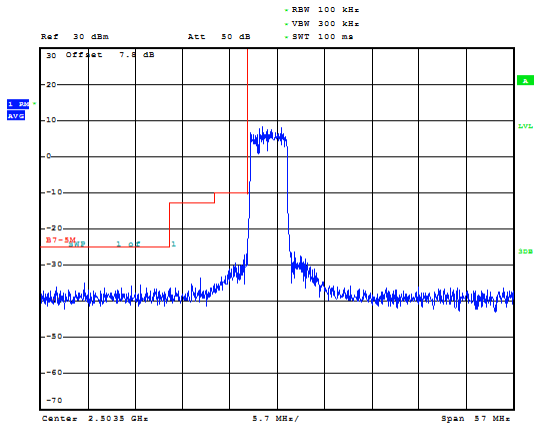

LTE Band 7 16QAM 5MHz CH-High, 100%RB

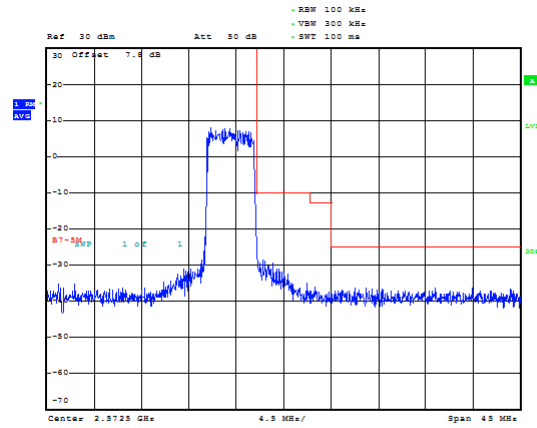

LTE Band 7 16QAM 10MHz CH-Low, 1 RB

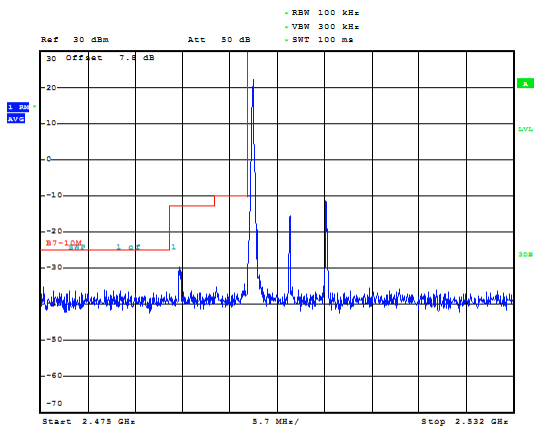

LTE Band 7 16QAM 10MHz CH-High, 1 RB

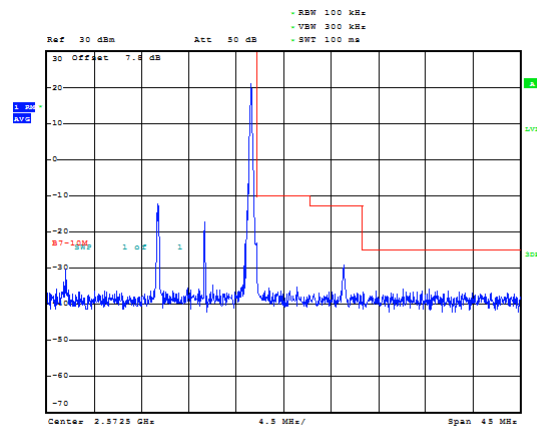

LTE Band 7 16QAM 10MHz CH-Low, 100%RB

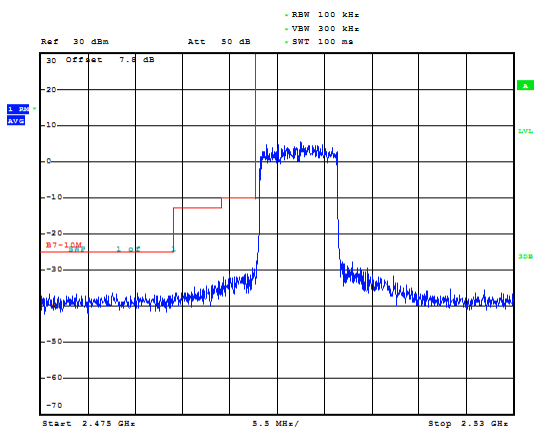

LTE Band 7 16QAM 10MHz CH-High, 100%RB

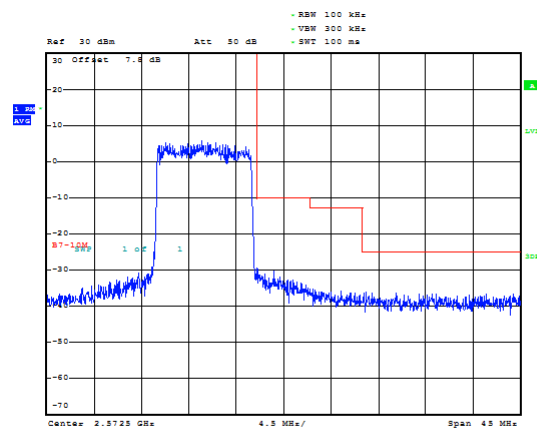



LTE Band 7 16QAM 15MHz CH-Low, 1 RB

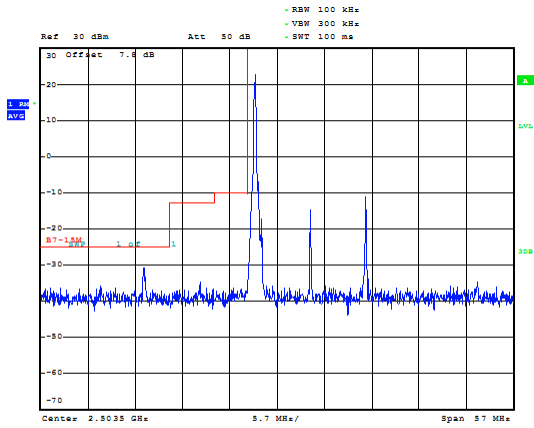

LTE Band 7 16QAM 15MHz CH-High, 1 RB

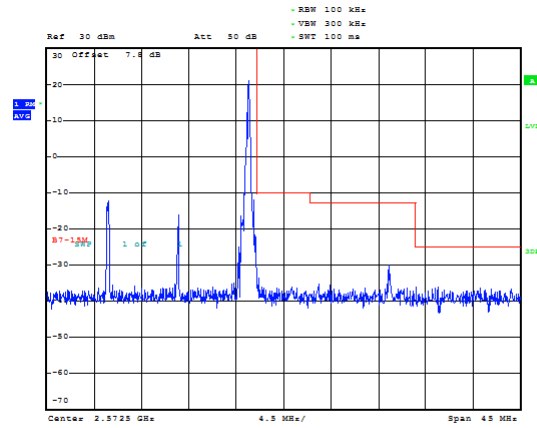

LTE Band 7 16QAM 15MHz CH-Low, 100%RB

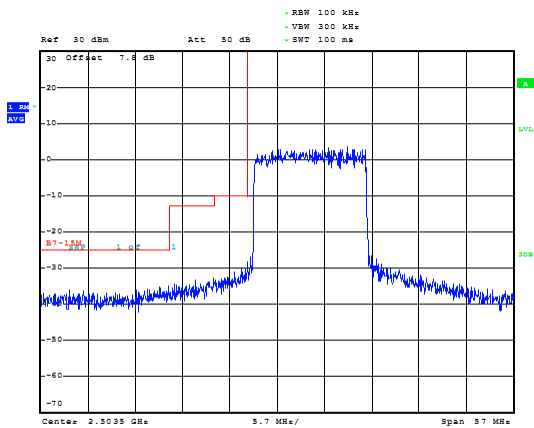

LTE Band 7 16QAM 15MHz CH-High, 100%RB

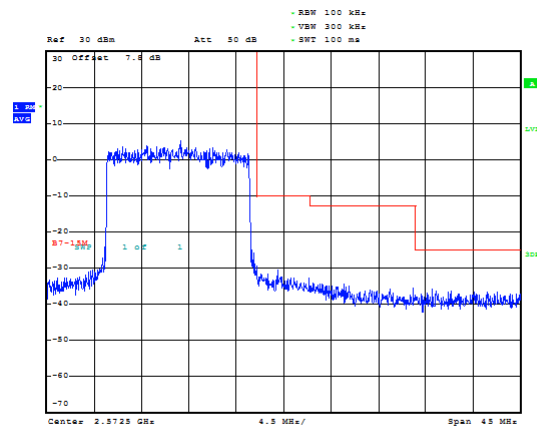

LTE Band 7 16QAM 20MHz CH-Low, 1 RB

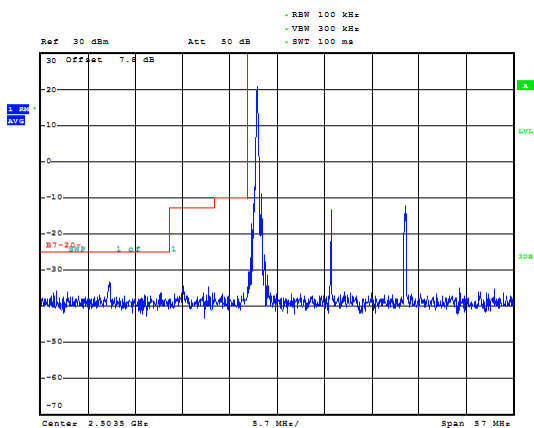

LTE Band 7 16QAM 20MHz CH-High, 1 RB

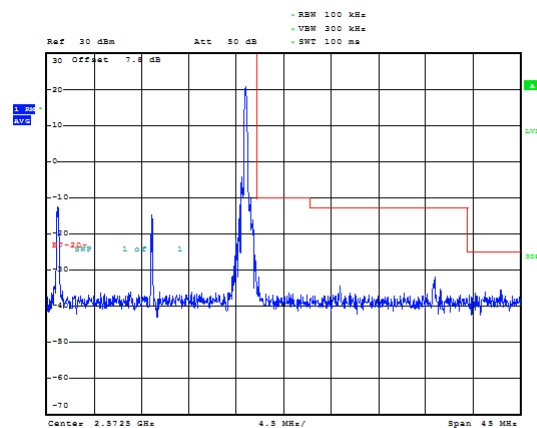

5.5 Peak-to-Average Power Ratio (PAPR)

Ambient condition

Temperature	Relative humidity	Pressure
23°C ~25°C	45%~50%	101.5kPa

Methods of Measurement

Measure the total peak power and record as Ppk. And measure the total average power and record as PAvg. Both the peak and average power levels must be expressed in the same logarithmic units (e.g., dBm). Determine the PAPR from:

$$PAPR (dB) = Ppk (dBm) - PAvg (dBm).$$

Test Setup

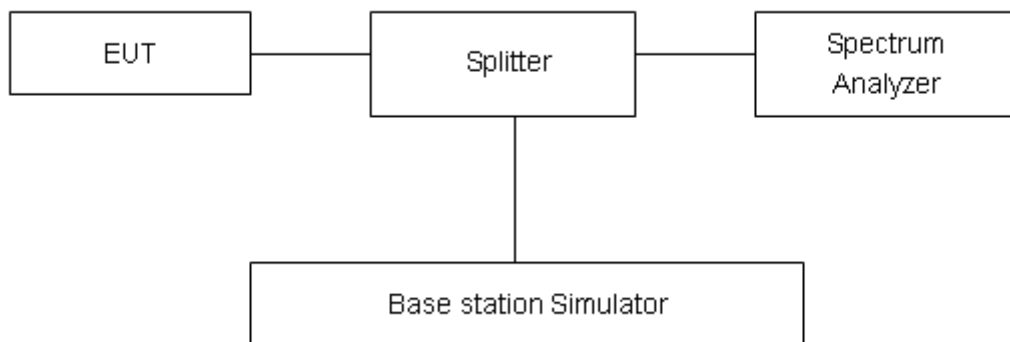

Limits

Rule Part 27.50(d)(5) Equipment employed must be authorized in accordance with the provisions of 24.51. Power measurements for transmissions by stations authorized under this section may be made either in accordance with a Commission-approved average power technique or in compliance with paragraph (d)(6) of this section. In measuring transmissions in this band using an average power technique, the peak-to-average ratio (PAR) of the transmission may not exceed 13 dB.

Measurement Uncertainty

The assessed measurement uncertainty to ensure 95% confidence level for the normal distribution is with the coverage factor k = 2, U= 0.4 dB.

Test Results

LTE Band 4								
Modulation	Bandwidth (MHz)	Channel	Frequency (MHz)	Peak (dBm)	Avg (dBm)	PAPR (dB)	Limit (dB)	Conclusion
QPSK	1.4	19957	1710.7	27.87	23.01	4.86	≤13	PASS
		20175	1732.5	27.84	22.79	5.05	≤13	PASS
		20393	1754.3	28.02	22.96	5.06	≤13	PASS
	3	19965	1711.5	27.85	22.87	4.98	≤13	PASS
		20175	1732.5	27.98	22.83	5.15	≤13	PASS
		20385	1753.5	28.18	22.99	5.19	≤13	PASS
	5	19975	1712.5	27.73	22.85	4.88	≤13	PASS
		20175	1732.5	27.95	22.82	5.13	≤13	PASS
		20375	1752.5	28.12	22.97	5.15	≤13	PASS
	10	20000	1715	27.74	22.93	4.81	≤13	PASS
		20175	1732.5	27.96	22.84	5.12	≤13	PASS
		20350	1750	28.22	23.01	5.21	≤13	PASS
	15	20025	1717.5	27.65	22.91	4.74	≤13	PASS
		20175	1732.5	27.92	22.80	5.12	≤13	PASS
		20325	1747.5	28.26	22.96	5.30	≤13	PASS
20	20050	1720	27.64	22.88	4.76	≤13	PASS	
	20175	1732.5	27.84	22.75	5.09	≤13	PASS	
	20300	1745	28.15	22.92	5.23	≤13	PASS	
16QAM	1.4	19957	1710.7	27.20	21.53	5.67	≤13	PASS
		20175	1732.5	27.64	21.77	5.87	≤13	PASS
		20393	1754.3	27.53	21.64	5.89	≤13	PASS
	3	19965	1711.5	27.34	21.56	5.78	≤13	PASS
		20175	1732.5	27.76	21.81	5.95	≤13	PASS
		20385	1753.5	27.68	21.67	6.01	≤13	PASS
	5	19975	1712.5	27.16	21.54	5.62	≤13	PASS
		20175	1732.5	27.65	21.77	5.88	≤13	PASS
		20375	1752.5	27.55	21.62	5.93	≤13	PASS
	10	20000	1715	27.17	21.57	5.60	≤13	PASS
		20175	1732.5	27.70	21.82	5.88	≤13	PASS
		20350	1750	27.65	21.66	5.99	≤13	PASS
	15	20025	1717.5	27.03	21.54	5.49	≤13	PASS
		20175	1732.5	27.60	21.77	5.83	≤13	PASS
		20325	1747.5	27.60	21.62	5.98	≤13	PASS
20	20050	1720	27.07	21.52	5.55	≤13	PASS	
	20175	1732.5	27.54	21.73	5.81	≤13	PASS	
	20300	1745	27.55	21.59	5.96	≤13	PASS	

LTE Band 7								
Modulation	Bandwidth (MHz)	Channel	Frequency (MHz)	Peak (dBm)	Avg (dBm)	PAPR (dB)	Limit (dB)	Conclusion
QPSK	5	20775	2502.5	28.11	22.98	5.13	≤13	PASS
		21100	2535	27.99	23.11	4.88	≤13	PASS
		21425	2567.5	28.15	23.25	4.90	≤13	PASS
	10	20800	2505	28.28	23.06	5.22	≤13	PASS
		21100	2535	28.15	23.13	5.02	≤13	PASS
		21400	2565	28.18	23.11	5.07	≤13	PASS
	15	20825	2507.5	28.20	23.04	5.16	≤13	PASS
		21100	2535	28.14	23.09	5.05	≤13	PASS
		21375	2562.5	28.21	23.06	5.15	≤13	PASS
	20	20850	2510	28.07	23.01	5.06	≤13	PASS
		21100	2535	28.18	23.04	5.14	≤13	PASS
		21350	2560	28.19	23.02	5.17	≤13	PASS
16QAM	5	20775	2502.5	27.93	22.00	5.93	≤13	PASS
		21100	2535	27.76	22.06	5.70	≤13	PASS
		21425	2567.5	27.55	21.84	5.71	≤13	PASS
	10	20800	2505	28.08	22.03	6.05	≤13	PASS
		21100	2535	27.95	22.11	5.84	≤13	PASS
		21400	2565	27.77	21.88	5.89	≤13	PASS
	15	20825	2507.5	27.95	22.00	5.95	≤13	PASS
		21100	2535	27.88	22.06	5.82	≤13	PASS
		21375	2562.5	27.79	21.84	5.95	≤13	PASS
	20	20850	2510	27.83	21.98	5.85	≤13	PASS
		21100	2535	27.92	22.02	5.90	≤13	PASS
		21350	2560	27.81	21.81	6.00	≤13	PASS

5.6 Frequency Stability

Ambient condition

Temperature	Relative humidity	Pressure
23°C ~25°C	45%~50%	101.5kPa

Method of Measurement

Frequency Stability (Temperature Variation)

The temperature inside the climate chamber is varied from -40°C to +85°C in 10°C step size.

(1) With all power removed, the temperature was decreased to -10°C and permitted to stabilize for three hours.

(2) Measure the carrier frequency with the test equipment in a “call mode”. These measurements should be made within 1 minute of powering up the mobile station, to prevent significant self warming.

(3) Repeat the above measurements at 10°C increments from -40°C to +85°C. Allow at least 1.5 hours at each temperature, un-powered, before making measurements.

Frequency Stability (Voltage Variation)

The frequency stability shall be measured with variation of primary supply voltage as follows:

(1) Vary primary supply voltage from 85 to 115 percent of the nominal value for other than hand carried battery equipment.

(2) For hand carried, battery powered equipment, reduce primary supply voltage to the battery-operating end point which shall be specified by the manufacturer.

This transceiver is specified to operate with an input voltage of between 3.3 V and 4.3 V, with a nominal voltage of 3.8V.

Test setup

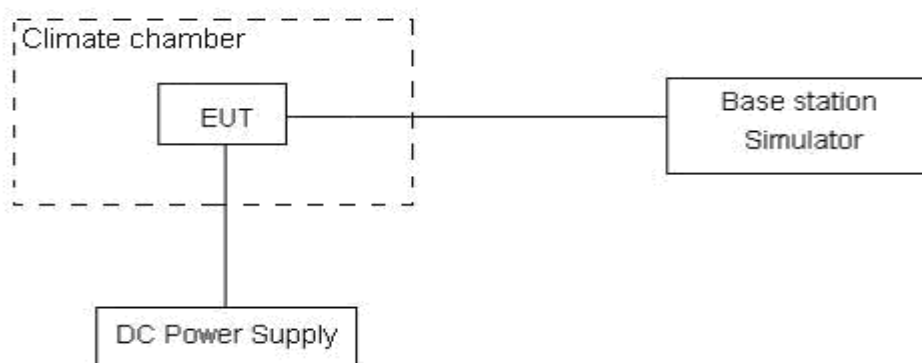

Limits

No specific frequency stability requirements in part 27.54

Measurement Uncertainty

The assessed measurement uncertainty to ensure 99.75% confidence level for the normal distribution is with the coverage factor $k = 3, U=0.01\text{ppm}$.

Test Result

LTE Band 4					
(QPSK, 20MHz BANDWIDTH)					
Condition		1710	1755	Delta(Hz)	Frequency Stability(ppm)
Temperature	Voltage	F low@-13dBm(MHz)	F high@-13dBm(MHz)		
Normal (25°C)	Normal	1710.6497	1754.4261	-3.91	-0.00226
Extreme (85°C)		1710.6497	1754.4262	2.54	0.00147
Extreme (80°C)		1710.6497	1754.4262	-0.32	-0.00018
Extreme (70°C)		1710.6497	1754.4262	-1.43	-0.00083
Extreme (60°C)		1710.6497	1754.4262	-2.41	-0.00139
Extreme (50°C)		1710.6497	1754.4262	-2.50	-0.00144
Extreme (40°C)		1710.6497	1754.4262	0.82	0.00047
Extreme (30°C)		1710.6497	1754.4262	-1.43	-0.00083
Extreme (20°C)		1710.6497	1754.4262	2.92	0.00169
Extreme (10C)		1710.6497	1754.4262	-1.20	-0.00069
Extreme (0°C)		1710.6497	1754.4262	2.21	0.00128
Extreme (-10°C)		1710.6497	1754.4262	0.38	0.00022
Extreme (-20°C)		1710.6497	1754.4262	3.45	0.00199
Extreme (-30°C)		1710.6497	1754.4262	-1.44	-0.00083
Extreme (-40°C)		1710.6497	1754.4262	6.79	0.00392
25°C	LV	1710.6497	1754.4262	1.79	0.00103
	HV	1710.6497	1754.4262	3.18	0.00184
(16QAM, 20MHz BANDWIDTH)					
Condition		1710	1755	Delta(Hz)	Frequency Stability(ppm)
Temperature	Voltage	F low@-13dBm(MHz)	F high@-13dBm(MHz)		
Normal (25°C)	Normal	1710.6421	1754.5146	0.55	0.00032
Extreme (85°C)		1710.6421	1754.5146	0.15	0.00009
Extreme (80°C)		1710.6421	1754.5146	3.19	0.00184
Extreme (70°C)		1710.6421	1754.5146	-0.31	-0.00018
Extreme (60°C)		1710.6421	1754.5146	-1.48	-0.00085
Extreme (50°C)		1710.6421	1754.5146	0.33	0.00019
Extreme (40°C)		1710.6421	1754.5146	0.29	0.00017
Extreme (30°C)		1710.6421	1754.5146	2.69	0.00155
Extreme (20°C)		1710.6421	1754.5146	3.32	0.00192
Extreme (10C)		1710.6421	1754.5146	2.46	0.00142
Extreme (0°C)		1710.6421	1754.5146	3.09	0.00178
Extreme (-10°C)		1710.6421	1754.5146	-1.03	-0.00059
Extreme (-20°C)		1710.6421	1754.5146	-0.53	-0.00031
Extreme (-30°C)		1710.6421	1754.5146	3.08	0.00178
Extreme (-40°C)		1710.6421	1754.5146	0.09	0.00005
25°C	LV	1710.6421	1754.5146	1.81	0.00104
	HV	1710.6421	1754.5146	2.46	0.00142

LTE Band 7					
(QPSK, 20MHz BANDWIDTH)					
Condition		2500	2570	Delta(Hz)	Frequency Stability(ppm)
Temperature	Voltage	F low@-13dBm(MHz)	F high@-13dBm(MHz)		
Normal (25°C)	Normal	2500.4379	2569.6783	-5.64	-0.00222
Extreme (85°C)		2500.4379	2569.6783	-0.38	-0.00015
Extreme (80°C)		2500.4379	2569.6783	-1.02	-0.00040
Extreme (70°C)		2500.4379	2569.6783	-1.09	-0.00043
Extreme (60°C)		2500.4379	2569.6783	3.16	0.00125
Extreme (50°C)		2500.4379	2569.6783	1.15	0.00045
Extreme (40°C)		2500.4379	2569.6783	-3.64	-0.00144
Extreme (30°C)		2500.4379	2569.6783	-4.34	-0.00171
Extreme (20°C)		2500.4379	2569.6783	-0.35	-0.00014
Extreme (10C)		2500.4379	2569.6783	2.28	0.00090
Extreme (0°C)		2500.4379	2569.6783	-3.92	-0.00155
Extreme (-10°C)		2500.4379	2569.6783	-5.58	-0.00220
Extreme (-20°C)		2500.4379	2569.6783	0.20	0.00008
Extreme (-30°C)		2500.4379	2569.6783	-5.57	-0.00220
Extreme (-40°C)		2500.4379	2569.6783	5.87	0.00232
25°C	LV	2500.4379	2569.6783	1.88	0.00074
	HV	2500.4379	2569.6783	3.96	0.00156
(16QAM, 20MHz BANDWIDTH)					
Condition		2500	2570	Delta(Hz)	Frequency Stability(ppm)
Temperature	Voltage	F low@-13dBm(MHz)	F high@-13dBm(MHz)		
Normal (25°C)	Normal	2500.3994	2569.6124	-0.54	-0.00021
Extreme (85°C)		2500.3994	2569.6124	3.06	0.00121
Extreme (80°C)		2500.3994	2569.6124	0.85	0.00034
Extreme (70°C)		2500.3994	2569.6124	-0.85	-0.00034
Extreme (60°C)		2500.3994	2569.6124	-0.21	-0.00008
Extreme (50°C)		2500.3994	2569.6124	-1.63	-0.00064
Extreme (40°C)		2500.3994	2569.6124	-1.10	-0.00043
Extreme (30°C)		2500.3994	2569.6124	0.86	0.00034
Extreme (20°C)		2500.3994	2569.6124	-1.34	-0.00053
Extreme (10C)		2500.3994	2569.6124	-3.09	-0.00122
Extreme (0°C)		2500.3994	2569.6124	-2.91	-0.00115
Extreme (-10°C)		2500.3994	2569.6124	-2.10	-0.00083
Extreme (-20°C)		2500.3994	2569.6124	0.08	0.00003
Extreme (-30°C)		2500.3994	2569.6124	2.56	0.00101
Extreme (-40°C)		2500.3994	2569.6124	-1.21	-0.00048
25°C	LV	2500.3994	2569.6124	0.69	0.00027
	HV	2500.3994	2569.6124	3.45	0.00136

5.7 Spurious Emissions at Antenna Terminals

Ambient condition

Temperature	Relative humidity	Pressure
23°C ~25°C	45%~50%	101.5kPa

Method of Measurement

The EUT was connected to Spectrum Analyzer and Base Station Simulator via power Splitter. The measurement is carried out using a spectrum analyzer. The spectrum analyzer scans from 30MHz to the 10th harmonic of the carrier. The peak detector is used. Set RBW 1MHz and VBW 3MHz, Sweep is set to ATUO.

Of those disturbances below (limit – 20 dB), the mark is not required for the EUT.

Test setup

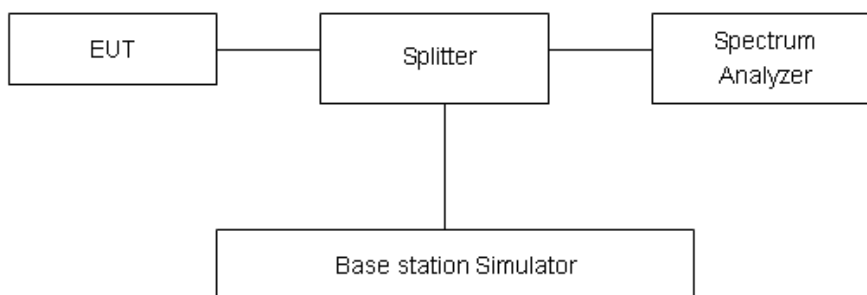

Limits

Rule Part 27.53(h) specifies that “for operations in the 1695-1710 MHz, 1710-1755 MHz, 1755-1780 MHz, 1915-1920 MHz, 1995-2000 MHz, 2000-2020 MHz, 2110-2155 MHz, 2155-2180 MHz, and 2180-2200 bands, the power of any emission outside a licensee's frequency block shall be attenuated below the transmitter power (P) in watts by at least $43 + 10 \log_{10} (P)$ dB..”

Rule Part 27.53(m) $55 + 10 \log (P)$ dB on all frequencies more than X megahertz from the channel edge, where X is the greater of 6 megahertz or the actual emission bandwidth as defined in paragraph (m)(4) of this section.

Part 27.53(h) Limit	-13 dBm
Part 27.53(m) Limit	-25 dBm

Measurement Uncertainty

The assessed measurement uncertainty to ensure 99.75% confidence level for the normal



distribution is with the coverage factor $k = 1.96$.

Frequency	Uncertainty
9kHz-1GHz	0.684 dB
1GHz-26GHz	1.407 dB

Test Result

Sweep from 9 kHz to 30MHz, and the emissions more than 20 dB below the permissible value are not reported.

If disturbances were found more than 20dB below limit line, the mark is not required for the EUT. The signal beyond the limit is carrier.

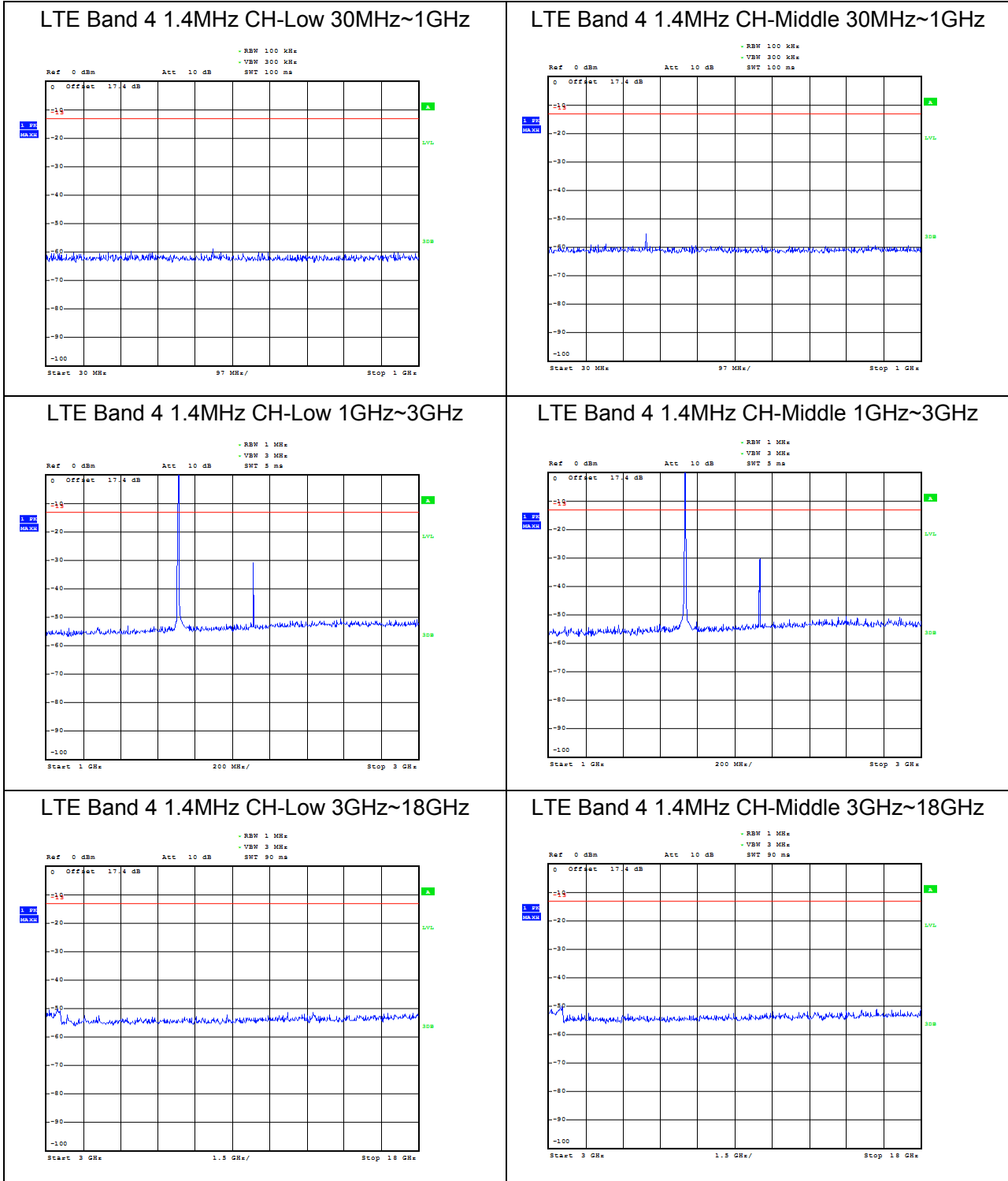



LTE Band 4 1.4MHz CH-High 30MHz~1GHz

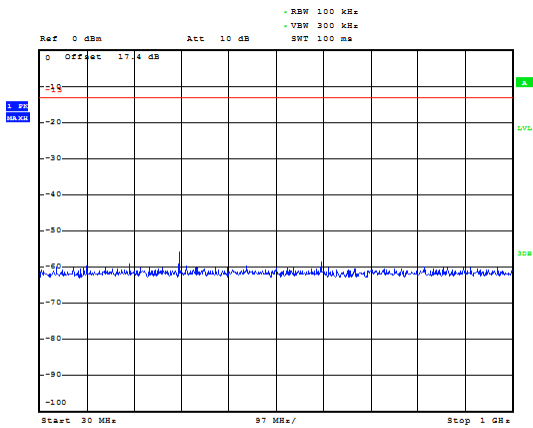

LTE Band 4 3MHz CH-Low 30MHz~1GHz

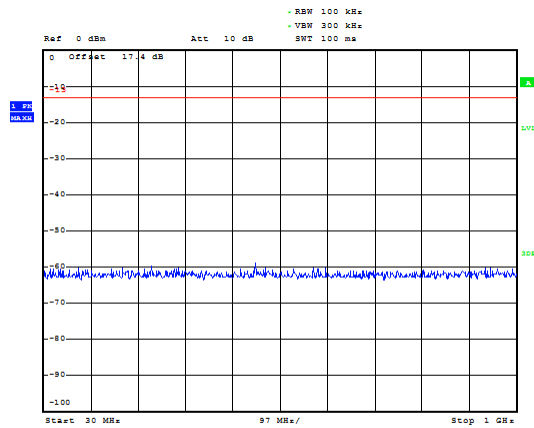

LTE Band 4 1.4MHz CH-High 1GHz~3GHz

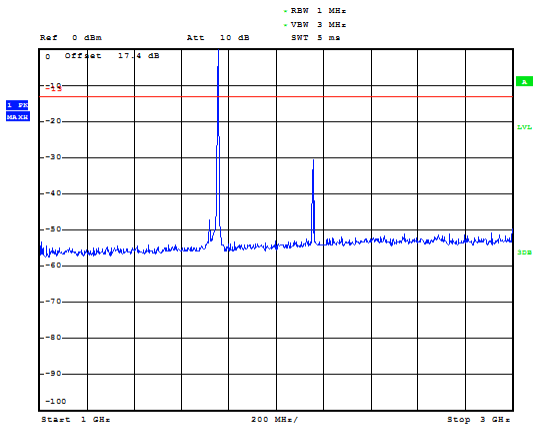

LTE Band 4 3MHz CH-Low 1GHz~3GHz

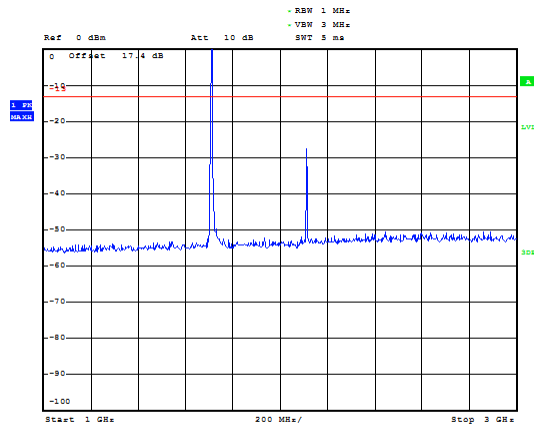

LTE Band 4 1.4MHz CH-High 3GHz~18GHz

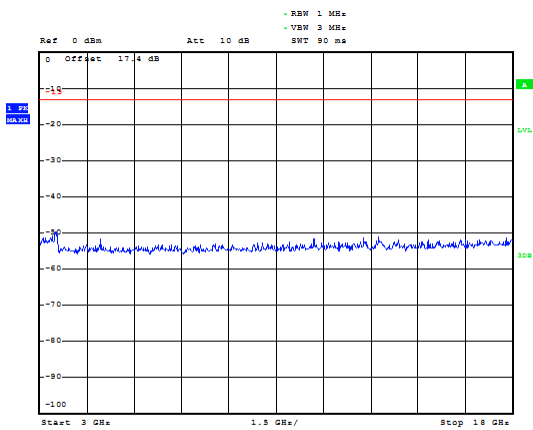

LTE Band 4 3MHz CH-Low 3GHz~18GHz

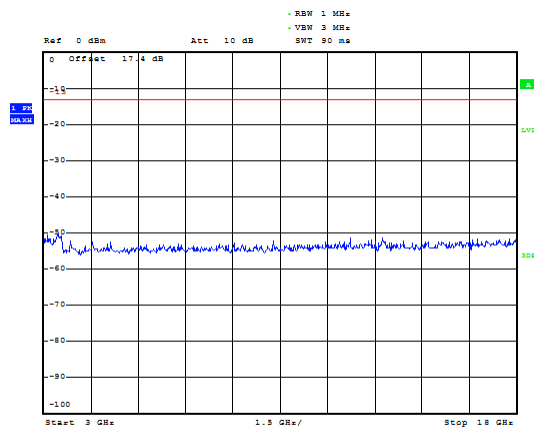



LTE Band 4 3MHz CH-Middle 30MHz~1GHz

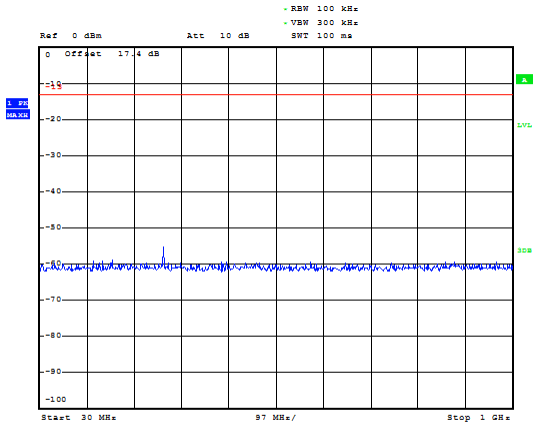

LTE Band 4 3MHz CH-High 30MHz~1GHz

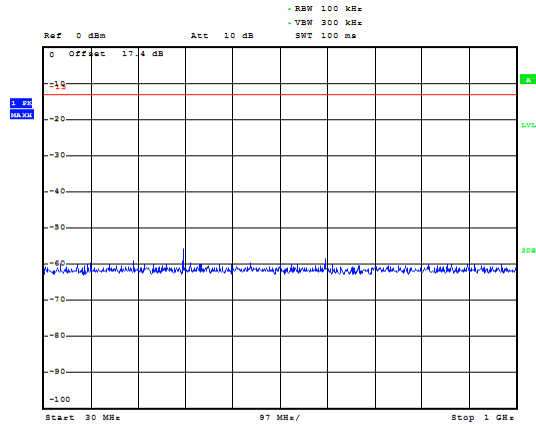

LTE Band 4 3MHz CH-Middle 1GHz~3GHz

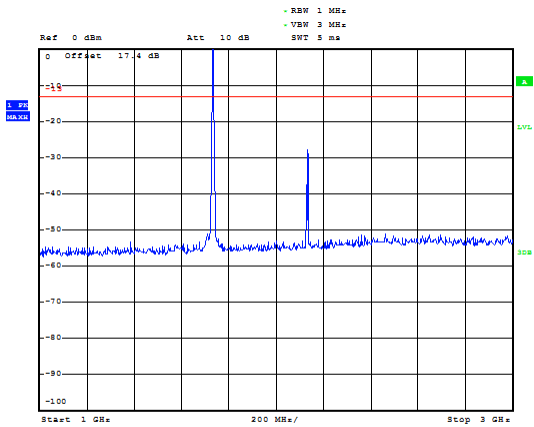

LTE Band 4 3MHz CH-High 1GHz~3GHz

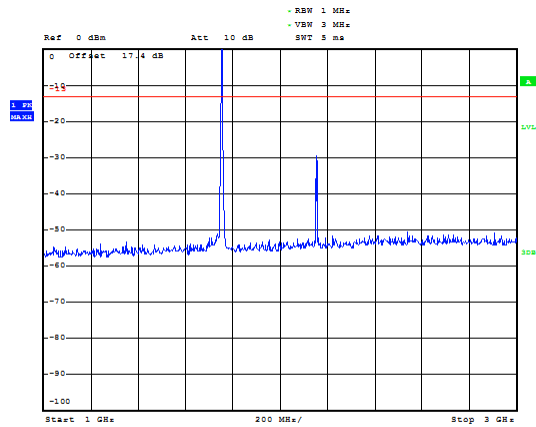

LTE Band 4 3MHz CH-Middle 3GHz~18GHz

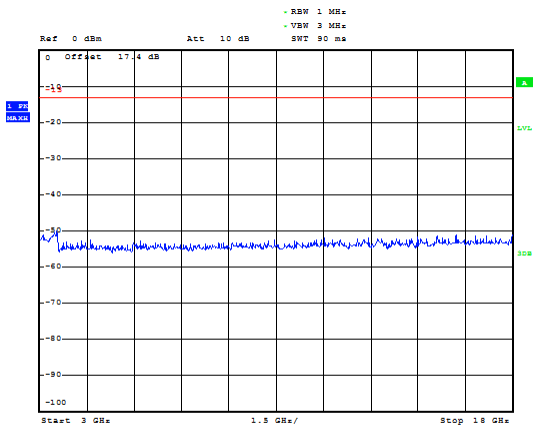

LTE Band 4 3MHz CH-High 3GHz~18GHz

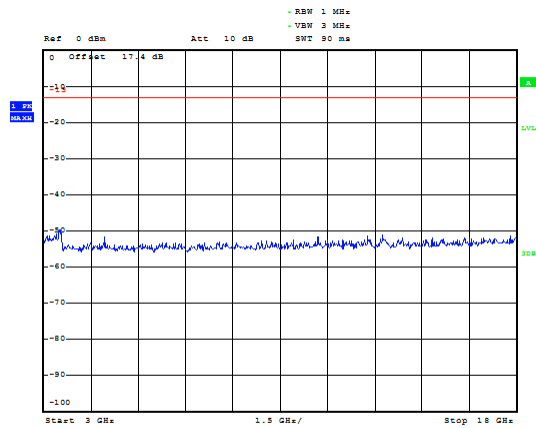



LTE Band 4 5MHz CH-Low 30MHz~1GHz

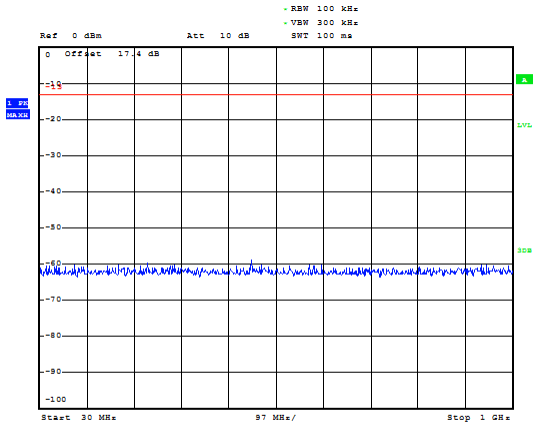

LTE Band 4 5MHz CH-Middle 30MHz~1GHz

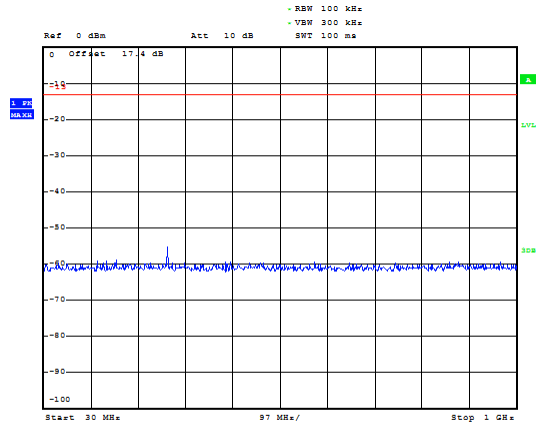

LTE Band 4 5MHz CH-Low 1GHz~3GHz

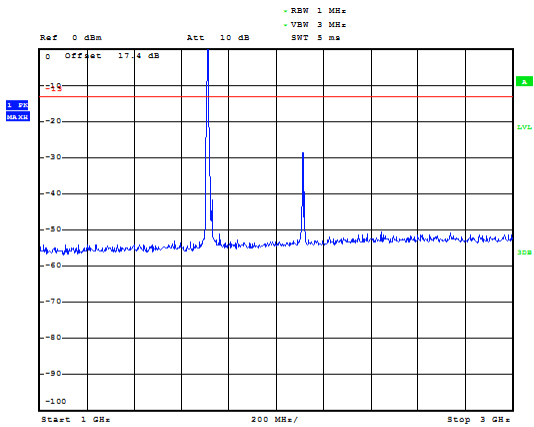

LTE Band 4 5MHz CH-Middle 1GHz~3GHz

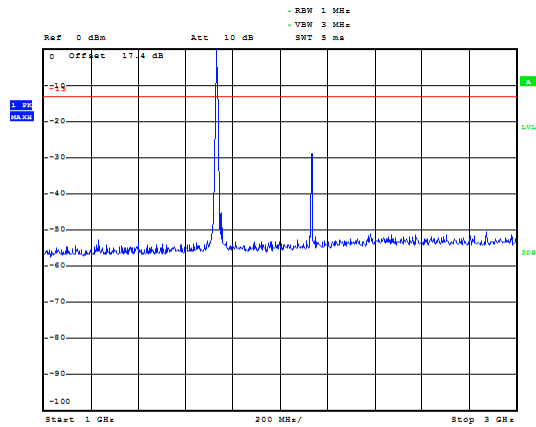

LTE Band 4 5MHz CH-Low 3GHz~18GHz

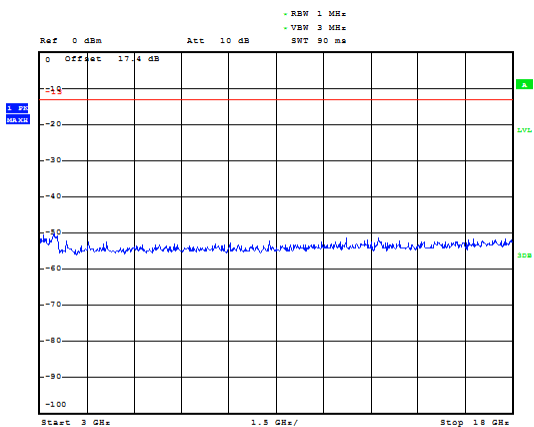

LTE Band 4 5MHz CH-Middle 3GHz~18GHz

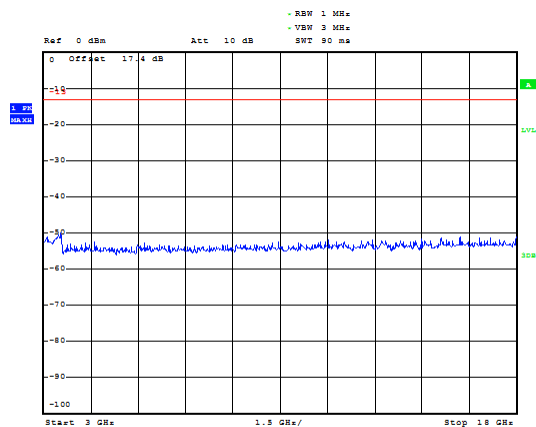



LTE Band 4 5MHz CH-High 30MHz~1GHz

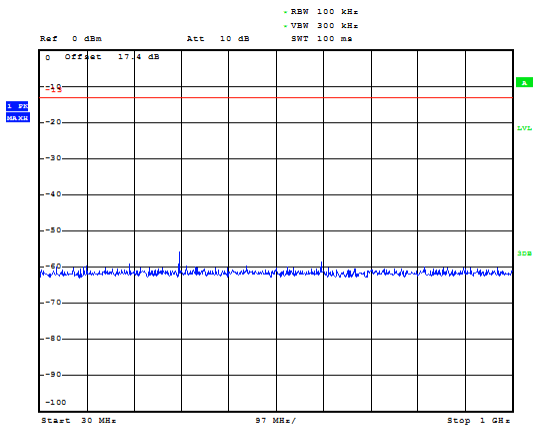

LTE Band 4 10MHz CH-Low 30MHz~1GHz

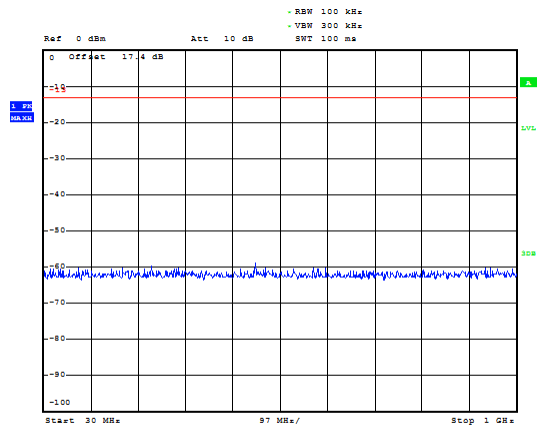

LTE Band 4 5MHz CH-High 1GHz~3GHz

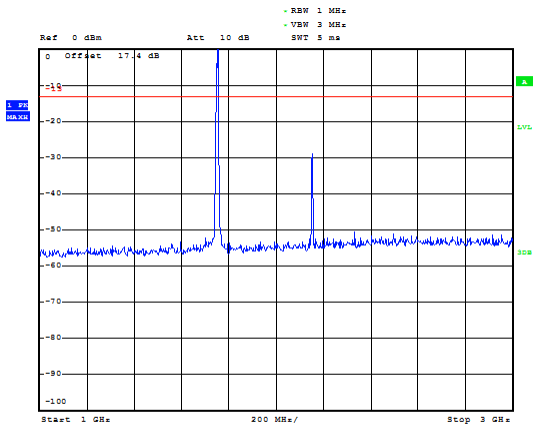

LTE Band 4 10MHz CH-Low 1GHz~3GHz

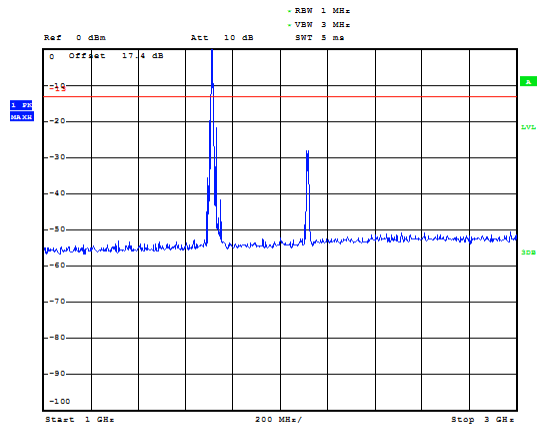

LTE Band 4 5MHz CH-High 3GHz~18GHz

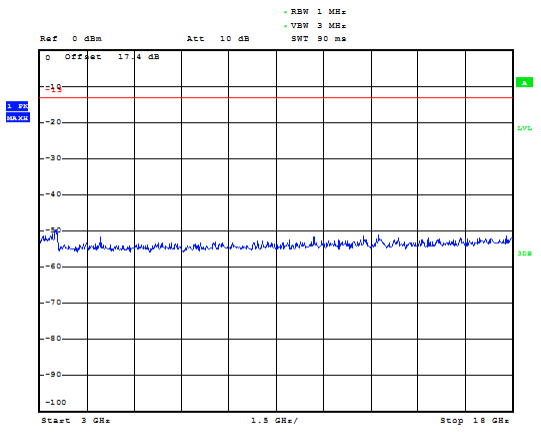

LTE Band 4 10MHz CH-Low 3GHz~18GHz

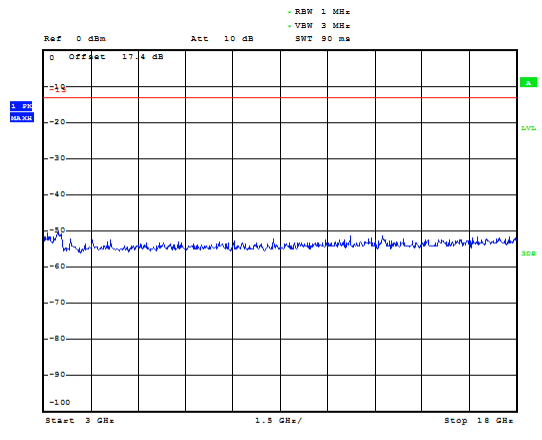

LTE Band 4 10MHz CH-Middle 30MHz~1GHz

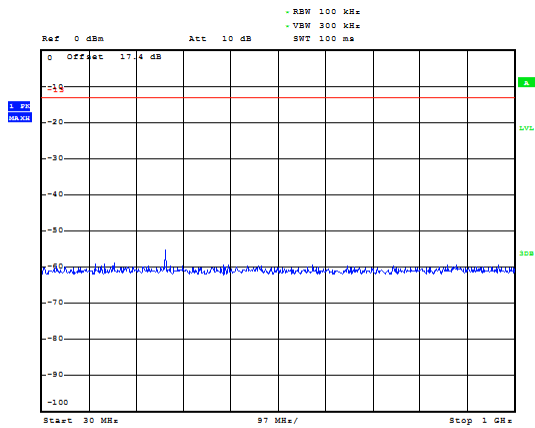

LTE Band 4 10MHz CH-High 30MHz~1GHz

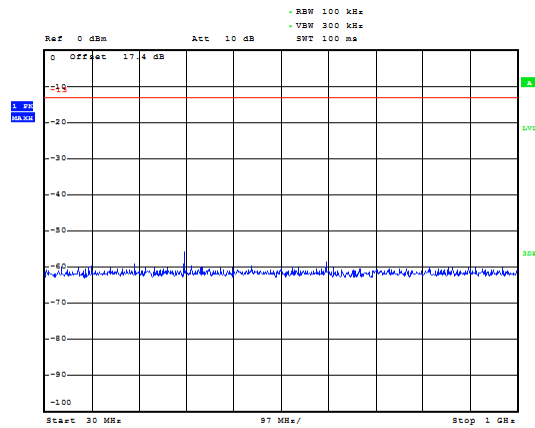

LTE Band 4 10MHz CH-Middle 1GHz~3GHz

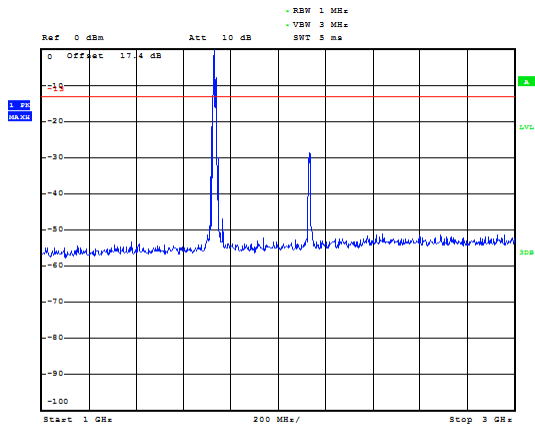

LTE Band 4 10MHz CH-High 1GHz~3GHz

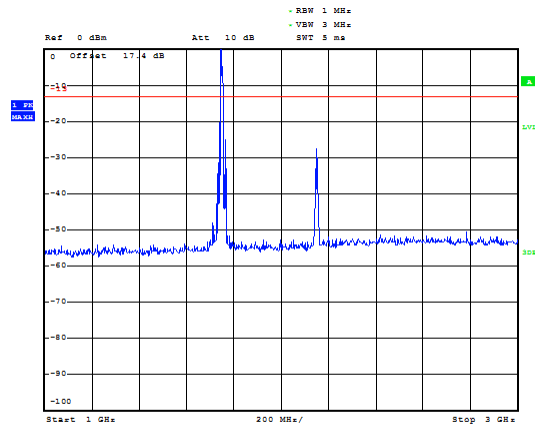

LTE Band 4 10MHz CH-Middle 3GHz~18GHz

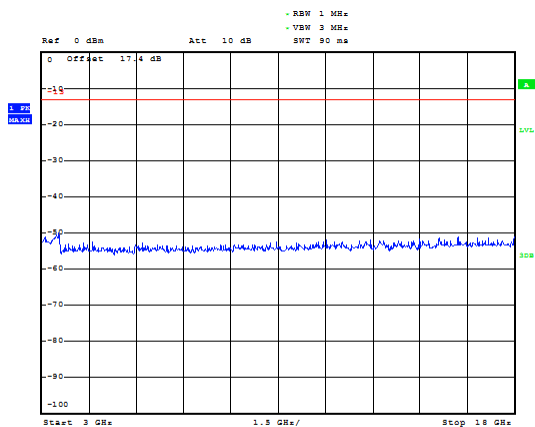

LTE Band 4 10MHz CH-High 3GHz~18GHz

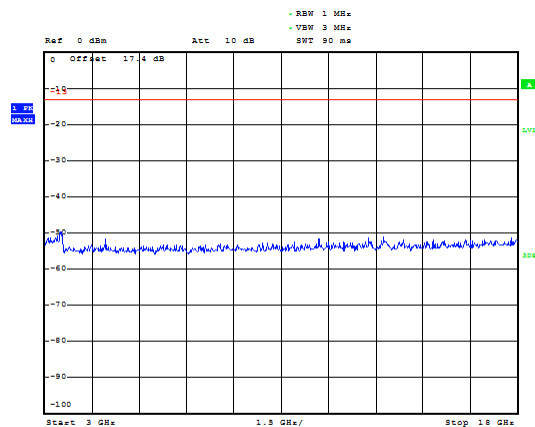



LTE Band 4 15MHz CH-Low 30MHz~1GHz

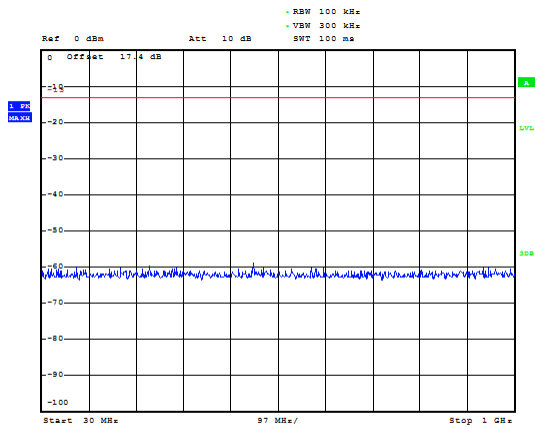

LTE Band 4 15MHz CH-Middle 30MHz~1GHz

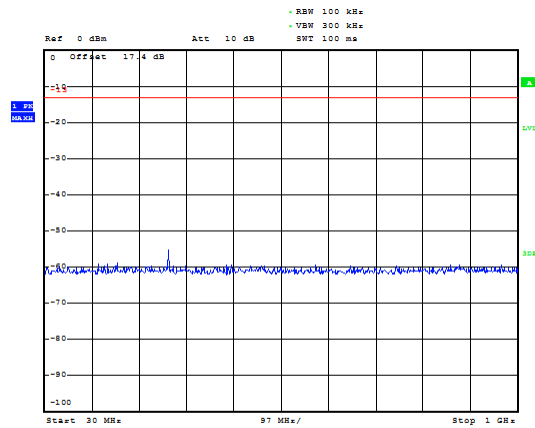

LTE Band 4 15MHz CH-Low 1GHz~3GHz

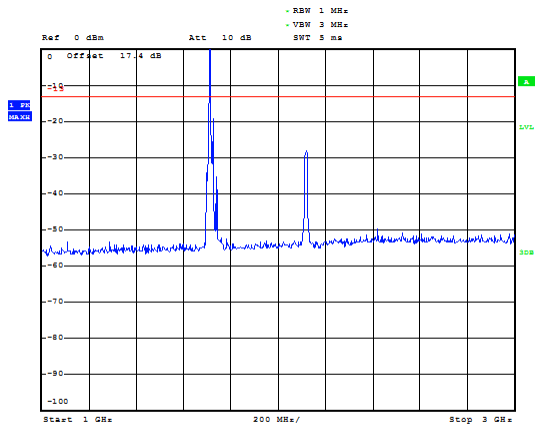

LTE Band 4 15MHz CH-Middle 1GHz~3GHz

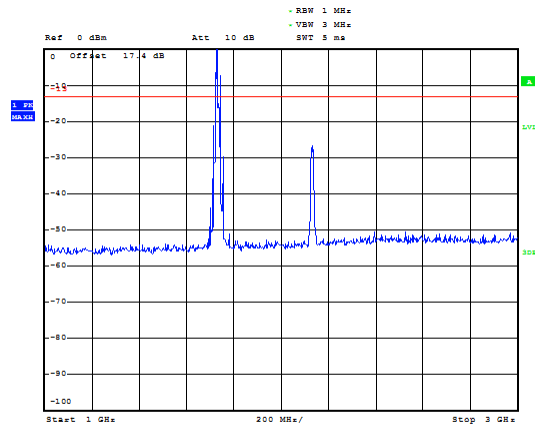

LTE Band 4 15MHz CH-Low 3GHz~18GHz

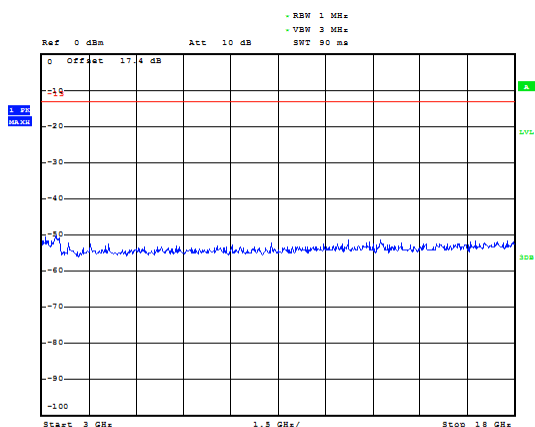

LTE Band 4 15MHz CH-Middle 3GHz~18GHz

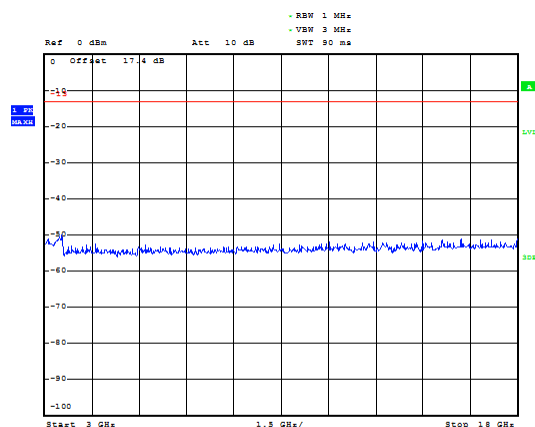



LTE Band 4 15MHz CH-High 30MHz~1GHz

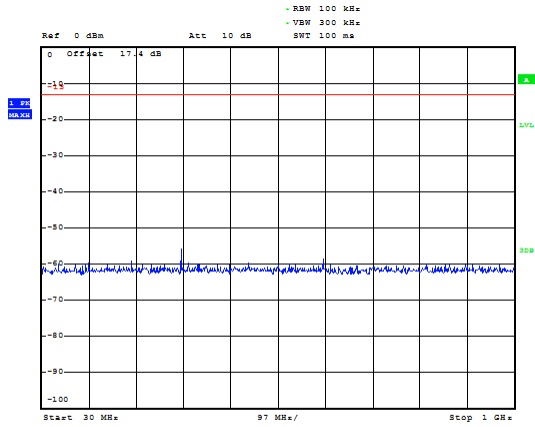

LTE Band 4 20MHz CH-Low 30MHz~1GHz

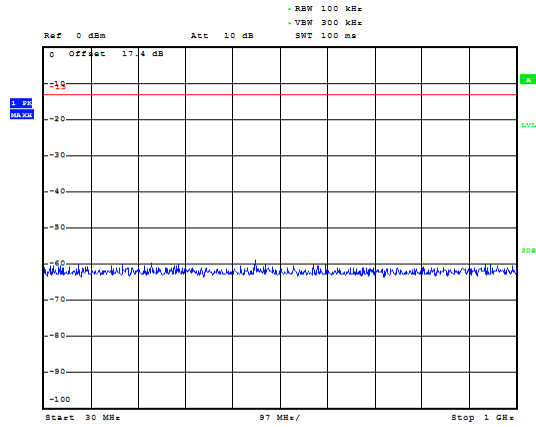

LTE Band 4 15MHz CH-High 1GHz~3GHz

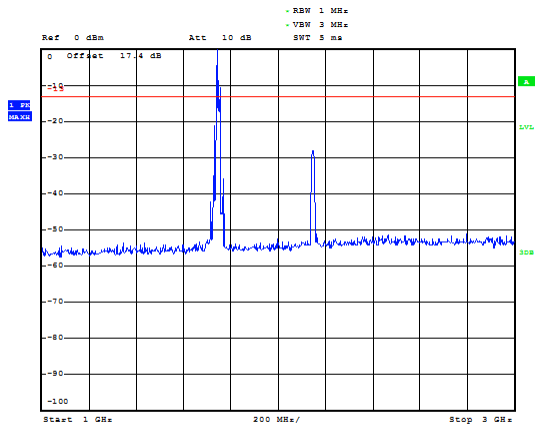

LTE Band 4 20MHz CH-Low 1GHz~3GHz

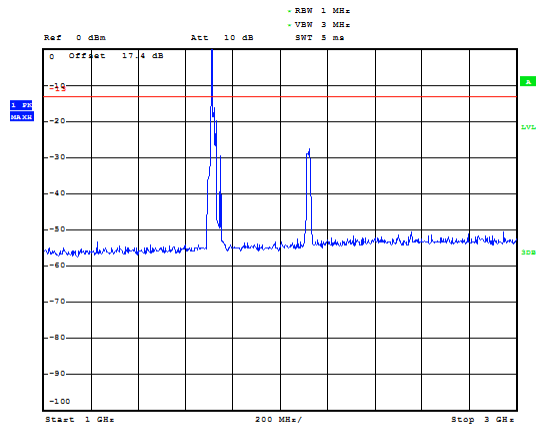

LTE Band 4 15MHz CH-High 3GHz~18GHz

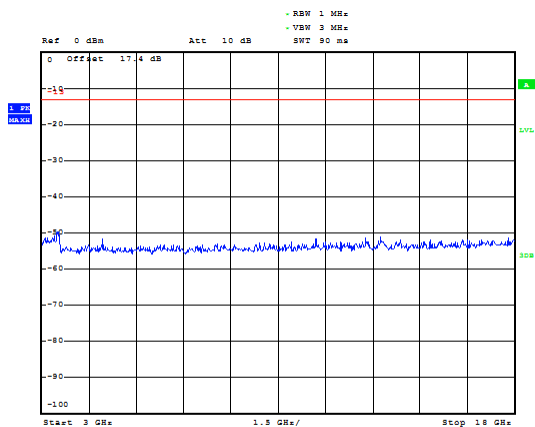

LTE Band 4 20MHz CH-Low 3GHz~18GHz

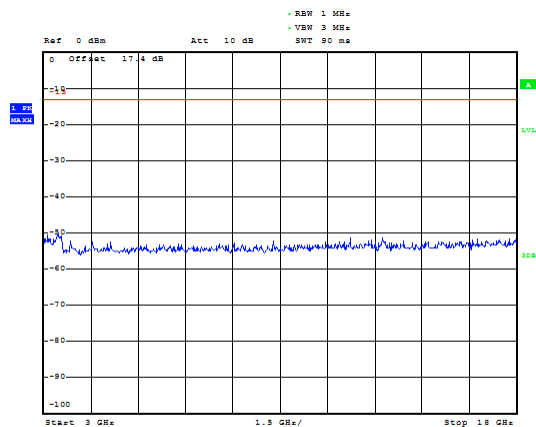



LTE Band 4 20MHz CH- Middle 30MHz~1GHz

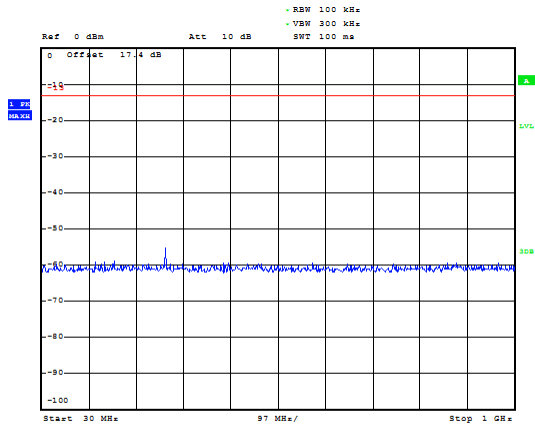

LTE Band 4 20MHz CH- High 30MHz~1GHz

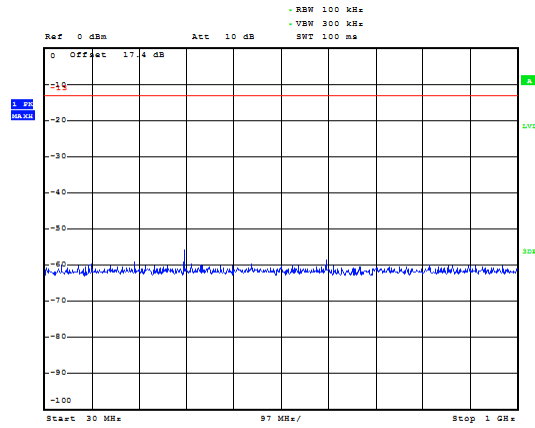

LTE Band 4 20MHz CH- Middle 1GHz~3GHz

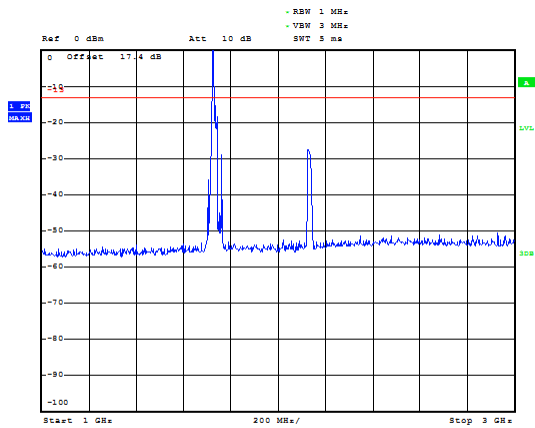

LTE Band 4 20MHz CH- High 1GHz~3GHz

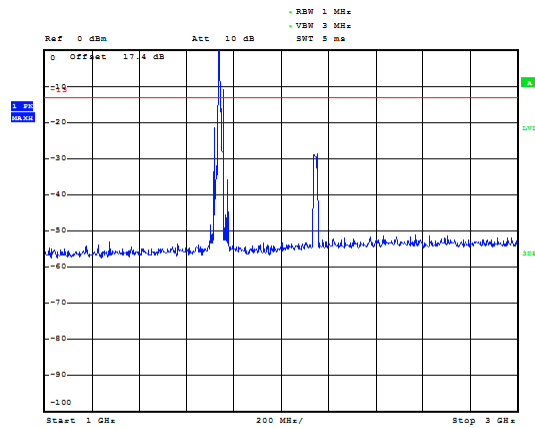

LTE Band 4 20MHz CH- Middle 3GHz~18GHz

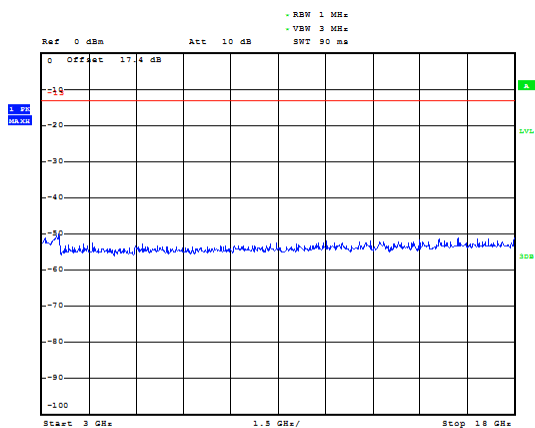

LTE Band 4 20MHz CH- High 3GHz~18GHz

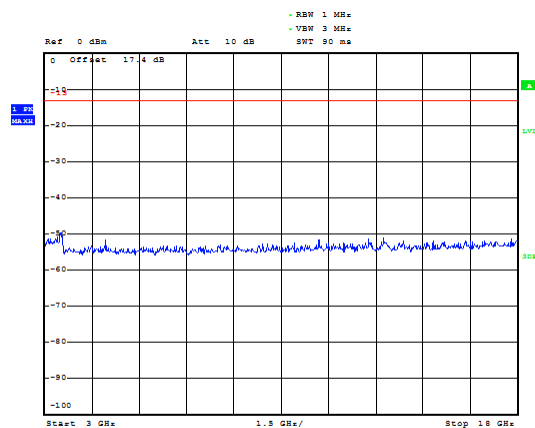



LTE Band 7 5MHz CH-Low 30MHz~1GHz

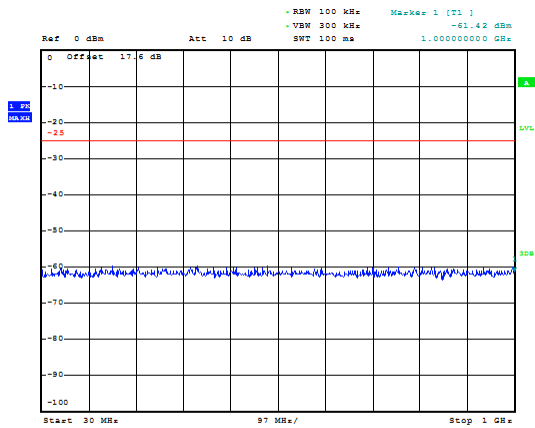

LTE Band 7 5MHz CH-Middle 30MHz~1GHz

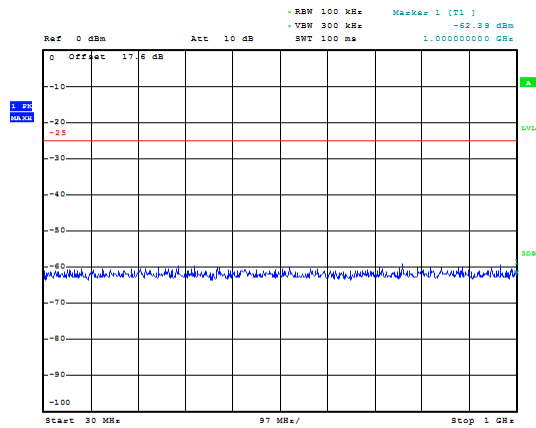

LTE Band 7 5MHz CH-Low 1GHz~3GHz

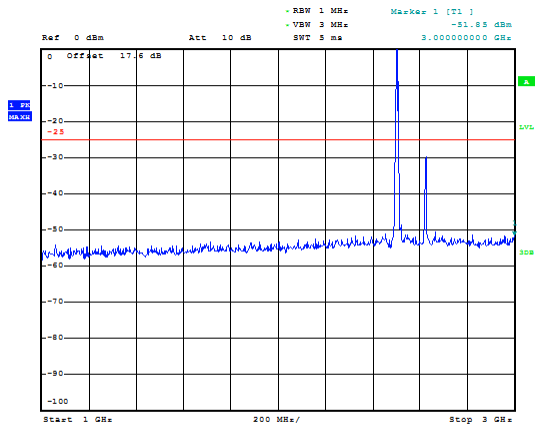

LTE Band 7 5MHz CH-Middle 1GHz~3GHz

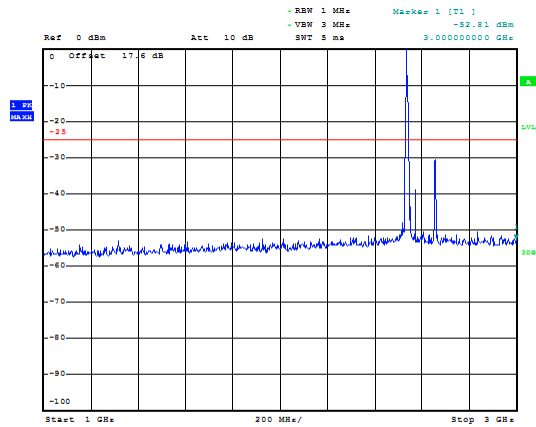

LTE Band 7 5MHz CH-Low 3GHz~26GHz

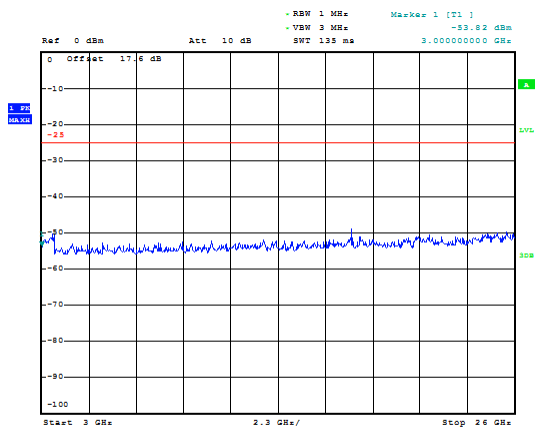

LTE Band 7 5MHz CH-Middle 3GHz~26GHz

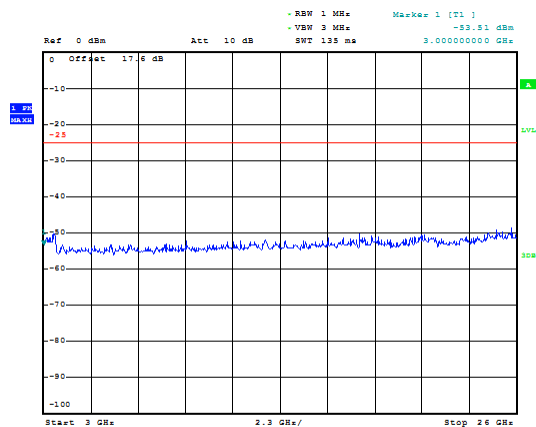



LTE Band 7 5MHz CH-High 30MHz~1GHz

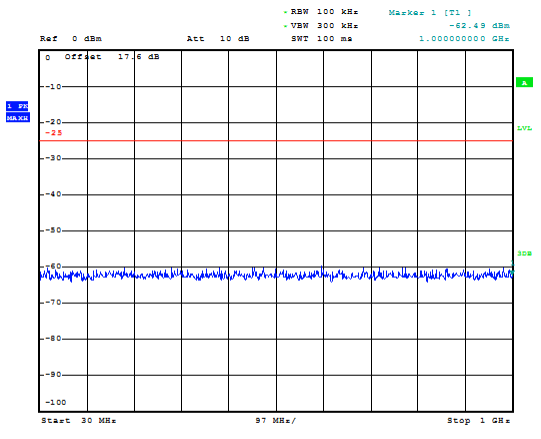

LTE Band 7 10MHz CH-Low 30MHz~1GHz

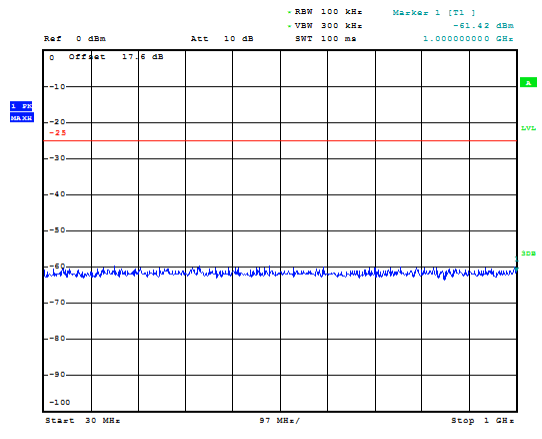

LTE Band 7 5MHz CH-High 1GHz~3GHz

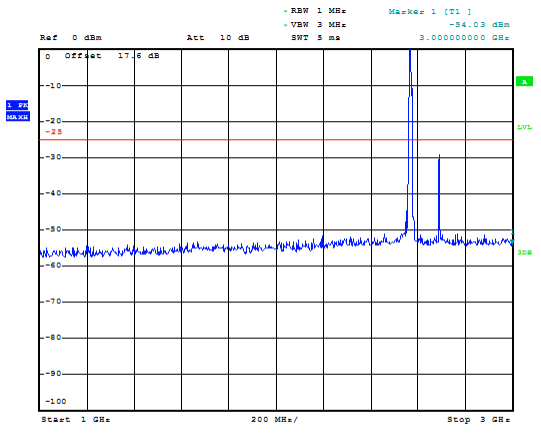

LTE Band 7 10MHz CH-Low 1GHz~3GHz

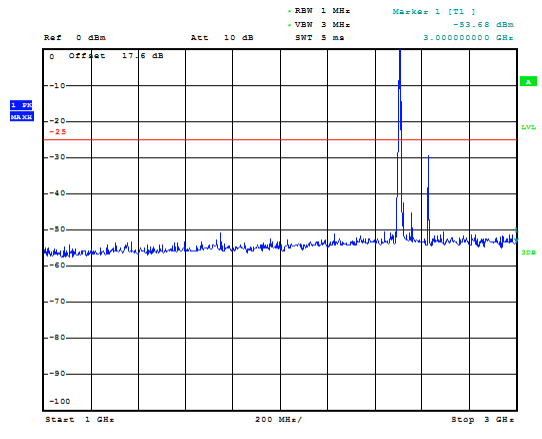

LTE Band 7 5MHz CH-High 3GHz~26GHz

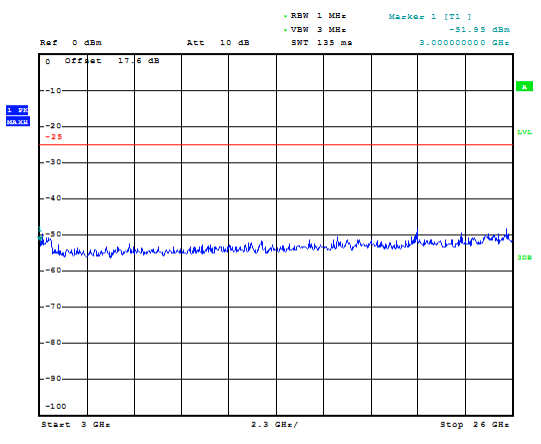

LTE Band 7 10MHz CH-Low 3GHz~26GHz

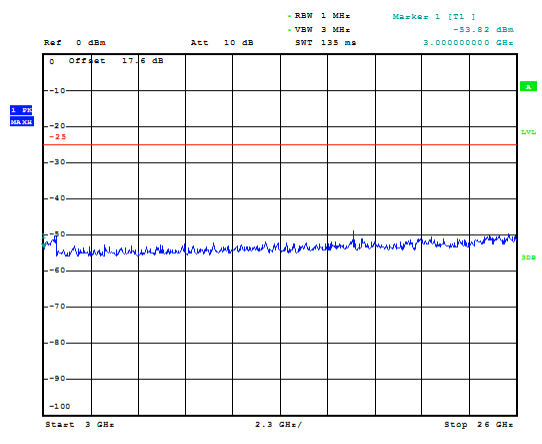



LTE Band 7 10MHz CH-Middle 30MHz~1GHz

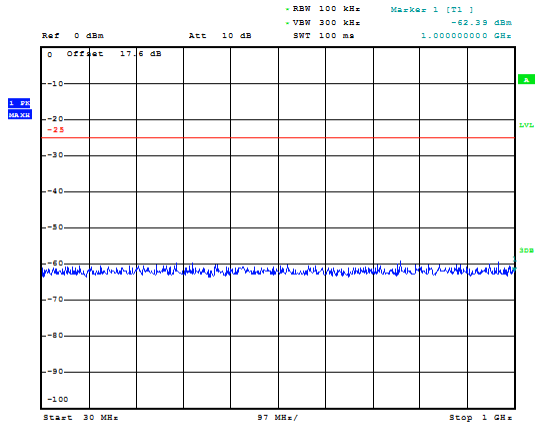

LTE Band 7 10MHz CH-High 30MHz~1GHz

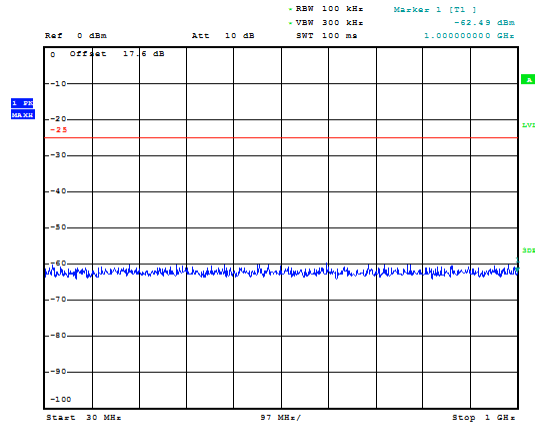

LTE Band 7 10MHz CH-Middle 1GHz~3GHz

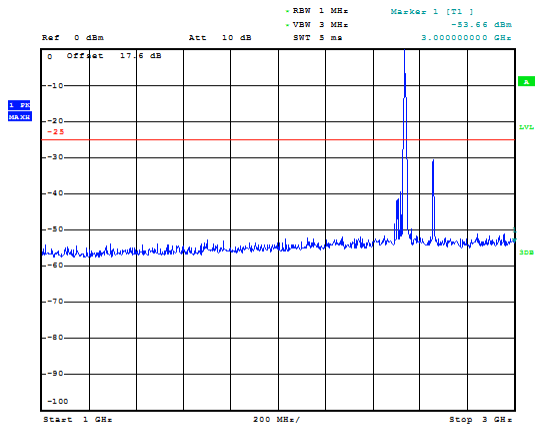

LTE Band 7 10MHz CH-High 1GHz~3GHz

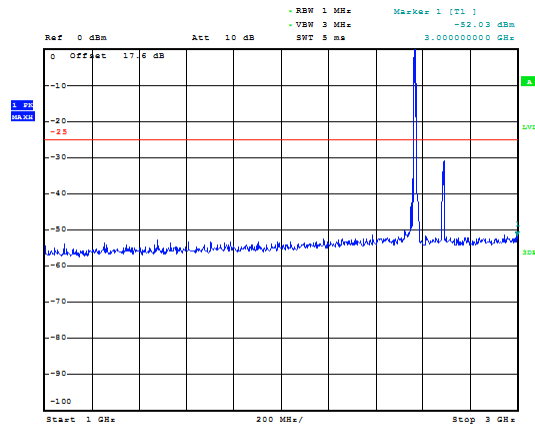

LTE Band 7 10MHz CH-Middle 3GHz~26GHz

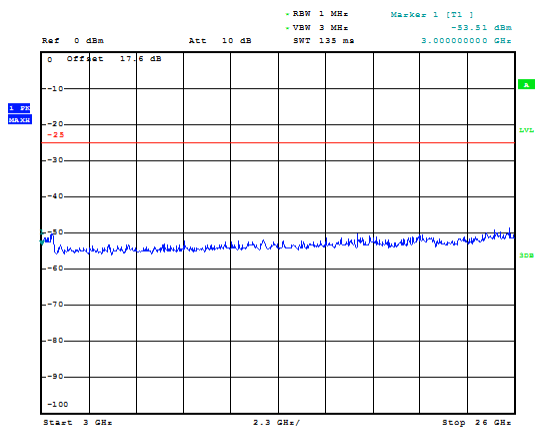

LTE Band 7 10MHz CH-High 3GHz~26GHz

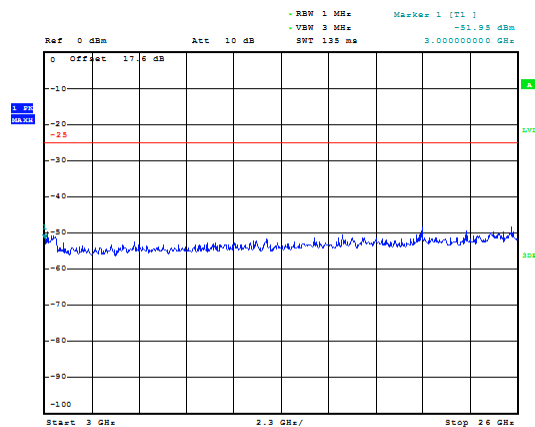



LTE Band 7 15MHz CH-Low 30MHz~1GHz

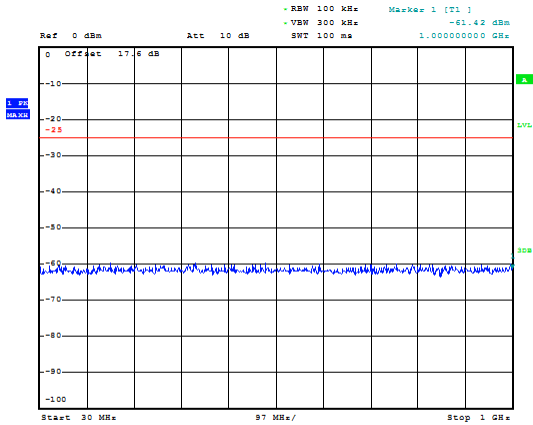

LTE Band 7 15MHz CH-Middle 30MHz~1GHz

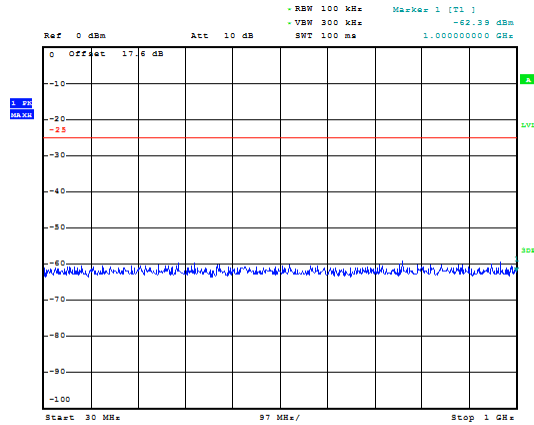

LTE Band 7 15MHz CH-Low 1GHz~3GHz

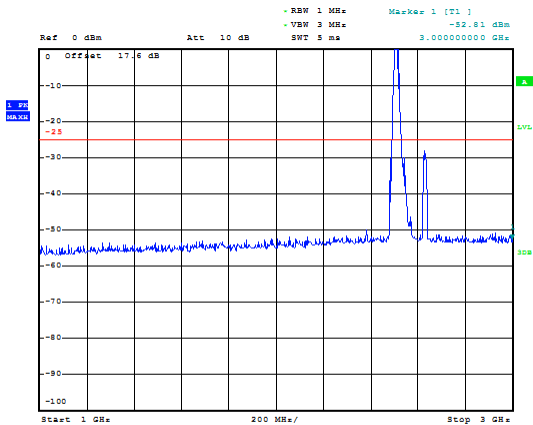

LTE Band 7 15MHz CH-Middle 1GHz~3GHz

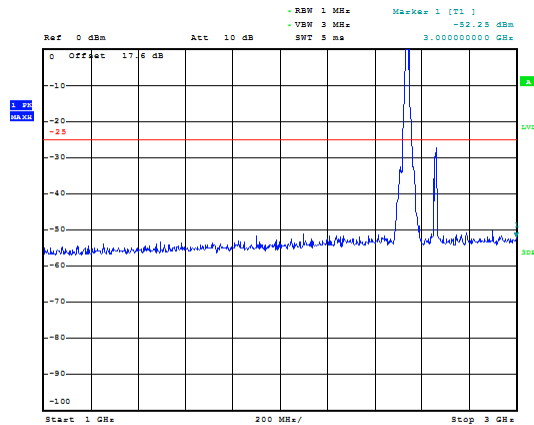

LTE Band 7 15MHz CH-Low 3GHz~26GHz

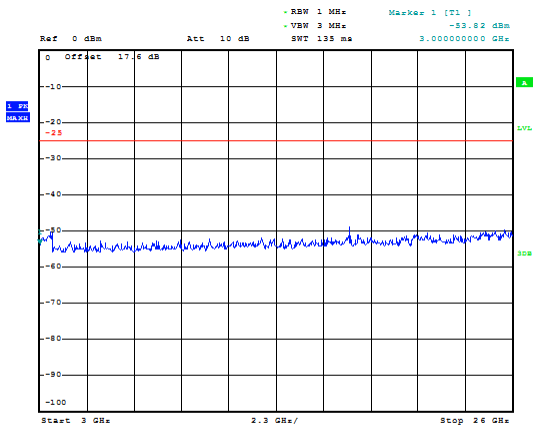

LTE Band 7 15MHz CH-Middle 3GHz~26GHz

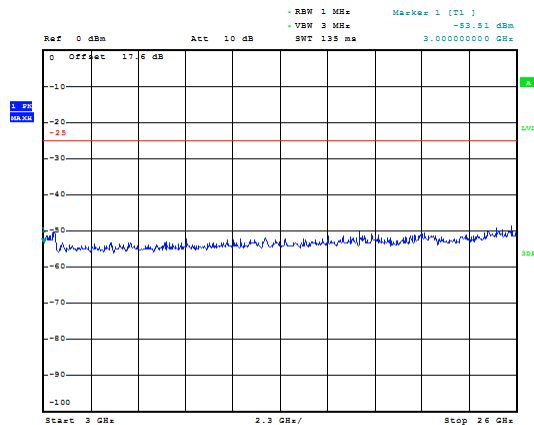



LTE Band 7 15MHz CH-High 30MHz~1GHz

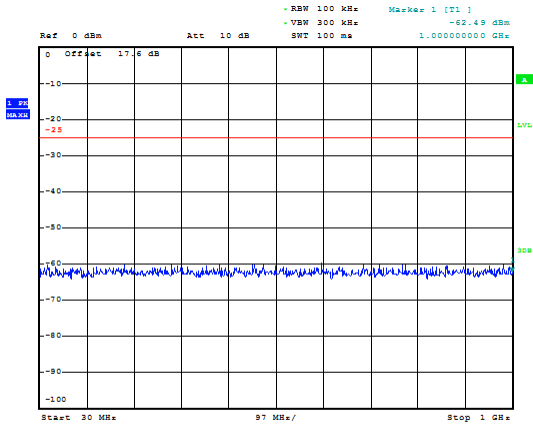

LTE Band 7 20MHz CH-Low 30MHz~1GHz

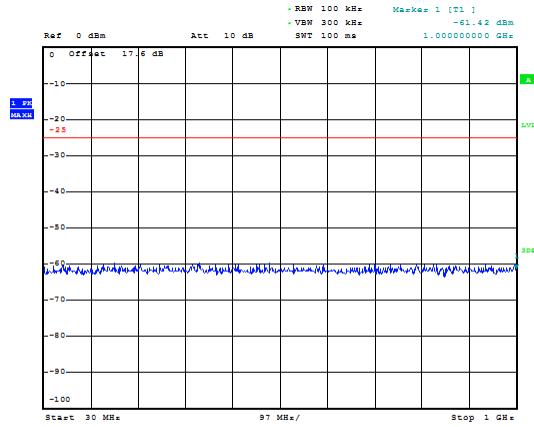

LTE Band 7 15MHz CH-High 1GHz~3GHz

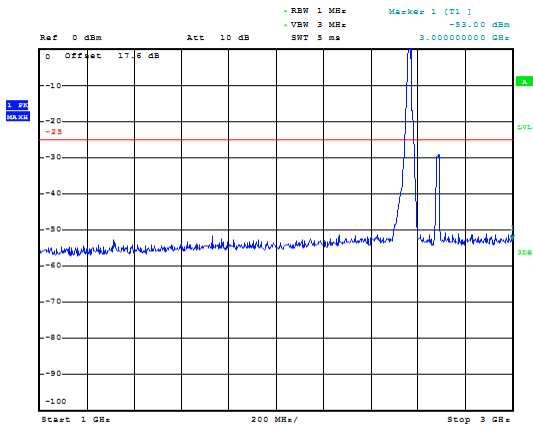

LTE Band 7 20MHz CH-Low 1GHz~3GHz

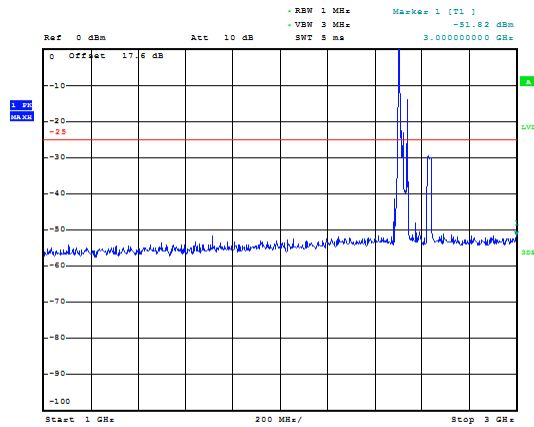

LTE Band 7 15MHz CH-High 3GHz~26GHz

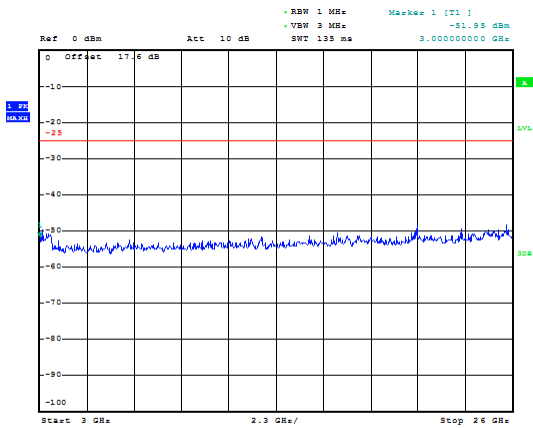

LTE Band 7 20MHz CH-Low 3GHz~26GHz

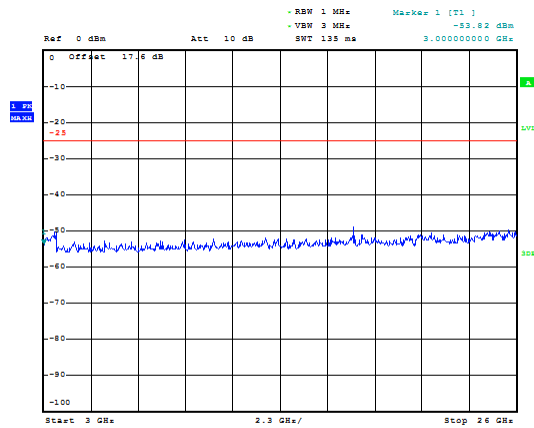



LTE Band 7 20MHz CH-Middle 30MHz~1GHz

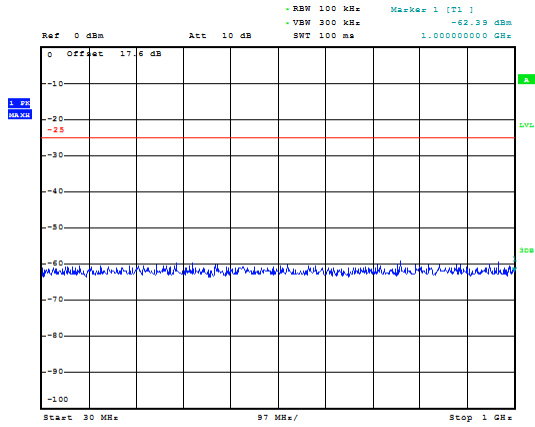

LTE Band 7 20MHz CH-High 30MHz~1GHz

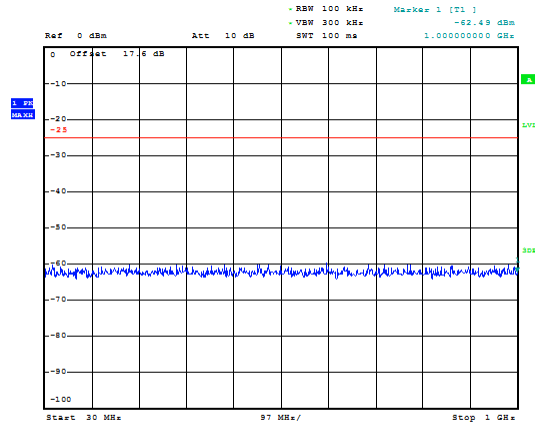

LTE Band 7 20MHz CH-Middle 1GHz~3GHz

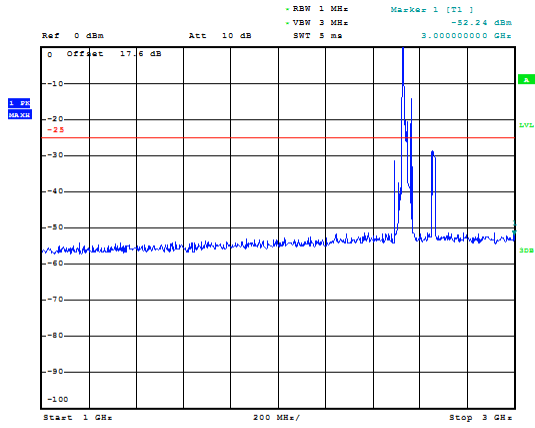

LTE Band 7 20MHz CH-High 1GHz~3GHz

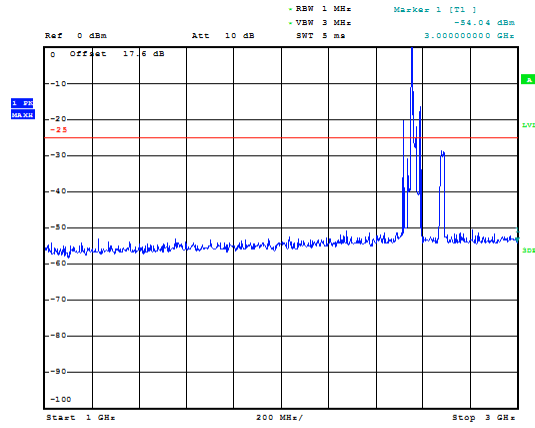

LTE Band 7 20MHz CH-Middle 3GHz~26GHz

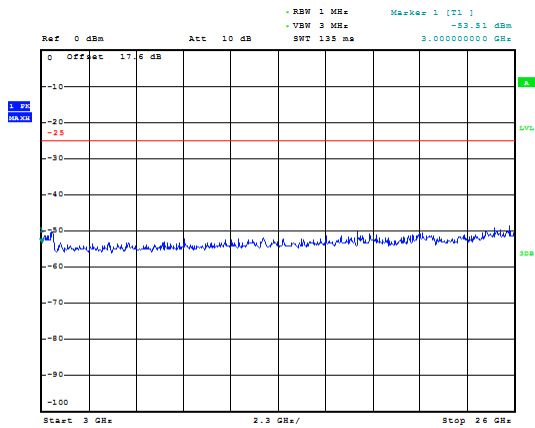

LTE Band 7 20MHz CH-High 3GHz~26GHz

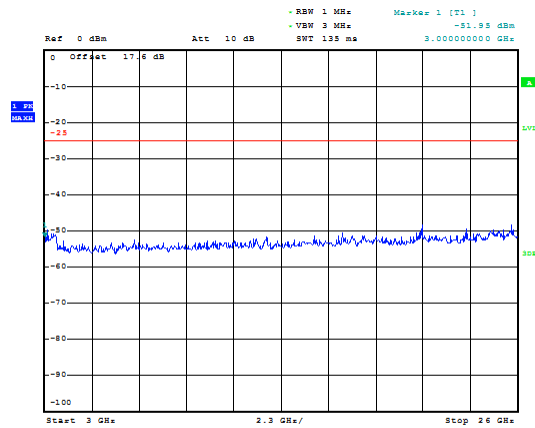

5.8 Radiates Spurious Emission

Ambient condition

Temperature	Relative humidity	Pressure
23°C ~25°C	45%~50%	101.5kPa

Method of Measurement

1. The testing follows FCC KDB 971168 D01 v03 Section 5.8 and ANSI/TIA-603-E (2016).
2. The EUT is placed on a turntable 0.8 meters above the ground in the chamber, 3 meter away from the antenna. The maximal emission value is acquired by adjusting the antenna height, polarisation and turntable azimuth. Normally, the height range of antenna is 1 m to 4 m, the azimuth range of turntable is 0° to 360°, and the receive antenna has two polarizations Vertical (V) and Horizontal (H).
3. A log-periodic antenna or double-ridged waveguide horn antenna shall be substituted in place of the EUT. The log-periodic antenna will be driven by a signal generator and the level will be adjusted till the same power value on the spectrum analyzer or receiver. The level of the spurious emissions can be calculated through the level of the signal generator, cable loss, the gain of the substitution antenna and the reading of the spectrum analyzer or receiver.
4. The EUT is then put into continuously transmitting mode at its maximum power level during the test. Set Test Receiver or Spectrum RBW=1MHz, VBW=3MHz, And the maximum value of the receiver should be recorded as (Pr).
5. The EUT shall be replaced by a substitution antenna. In the chamber, an substitution antenna for the frequency band of interest is placed at the reference point of the chamber. An RF Signal source for the frequency band of interest is connected to the substitution antenna with a cable that has been constructed to not interfere with the radiation pattern of the antenna. A power (PMea) is applied to the input of the substitution antenna, and adjust the level of the signal generator output until the value of the receiver reach the previously recorded (Pr). The power of signal source (PMea) is recorded. The test should be performed by rotating the test item and adjusting the receiving antenna polarization.
6. A amplifier should be connected to the Signal Source output port. And the cable should be connect between the Amplifier and the Substitution Antenna. The cable loss (Pcl) ,the Substitution Antenna Gain (Ga) and the Amplifier Gain (PAg) should be recorded after test.
7. The measurement results are obtained as described below:

$$\text{Power(EIRP)} = \text{PMea} - \text{PAg} - \text{Pcl} + \text{Ga}$$
 The measurement results are amend as described below:

$$\text{Power(EIRP)} = \text{PMea} - \text{Pcl} + \text{Ga}$$
8. This value is EIRP since the measurement is calibrated using an antenna of known gain (2.15 dBi) and known input power. ERP can be calculated from EIRP by subtracting the gain of the dipole, $\text{ERP} = \text{EIRP} - 2.15\text{dBi}$.

Test setup

30MHz~~~ 1GHz

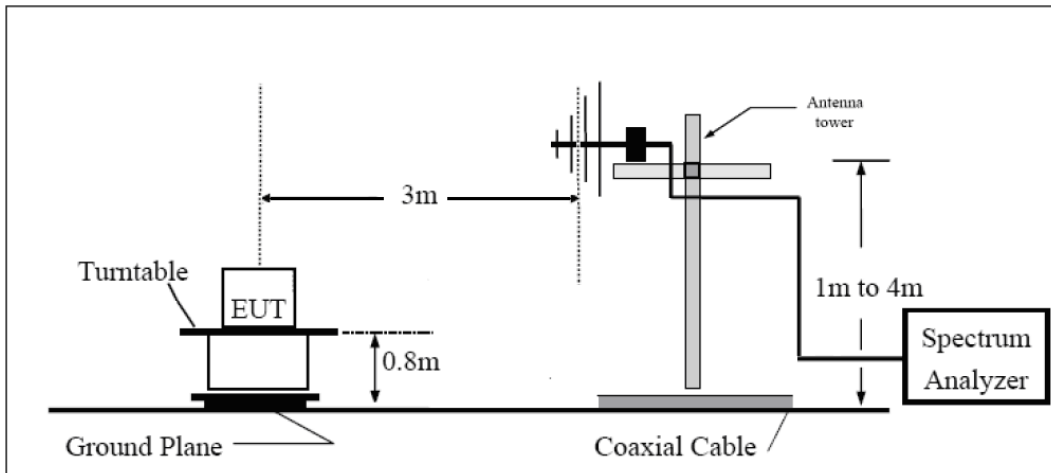

Above 1GHz

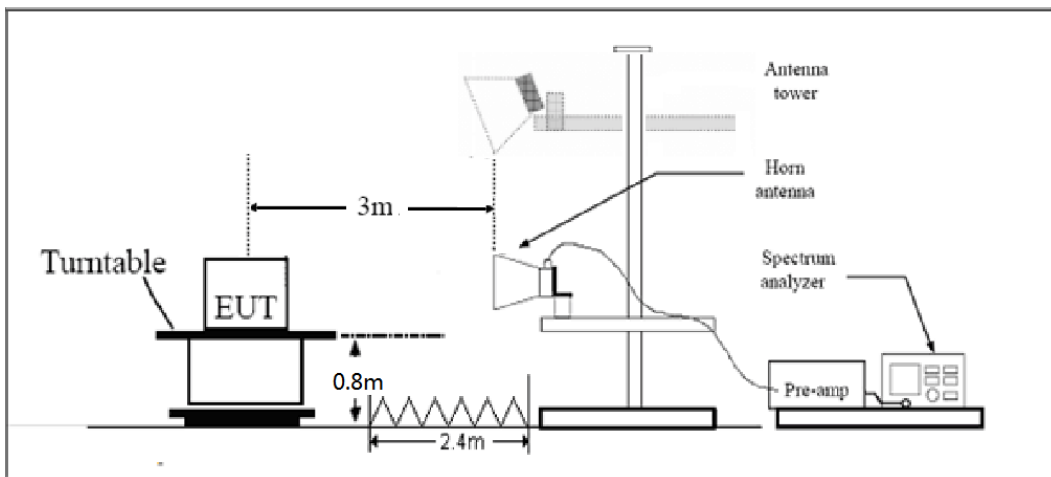

Note: Area side:2.4mX3.6m

The radiated emission was measured in the following position: EUT stand-up position (Z axis), lie-down position (X, Y axis). The worst emission was found in stand-up position (Z axis) and the worst case was recorded.

Limits

Rule Part 27.53(h) specifies that “for operations in the 1695-1710 MHz, 1710-1755 MHz, 1755-1780 MHz, 1915-1920 MHz, 1995-2000 MHz, 2000-2020 MHz, 2110-2155 MHz, 2155-2180 MHz, and 2180-2200 bands, the power of any emission outside a licensee's frequency block shall be attenuated below the transmitter power (P) in watts by at least $43 + 10 \log_{10} (P)$ dB..”

Rule Part 27.53(m) $55 + 10 \log (P)$ dB on all frequencies more than X megahertz from the channel edge, where X is the greater of 6 megahertz or the actual emission bandwidth as defined in paragraph (m)(4) of this section.

Rule Part 27.53(h) Limit	-13 dBm
Rule Part 27.53(m) Limit	-25 dBm



Measurement Uncertainty

The assessed measurement uncertainty to ensure 95% confidence level for the normal distribution is with the coverage factor $k = \pm 1.96$, $U = \pm 3.55$ dB.

Test Result

LTE Band 4 QPSK 1.4MHz CH-Low, RB 1

Harmonic	Frequency (MHz)	SG (dBm)	Cable Loss (dB)	Gain (dBi)	Antenna Polarization	EIRP Level (dBm)	Limit (dBm)	Margin (dB)	Azimuth (deg)
2	3421.4	-54.79	2.6	10.15	Vertical	-47.24	-13.00	34.24	270
3	5131.1	-49.32	2.4	11.35	Vertical	-40.37	-13.00	27.37	180
4	6842.8	-53.89	4.5	10.85	Vertical	-47.54	-13.00	34.54	135
5	8553.5	-45.77	5.1	11.35	Vertical	-39.52	-13.00	26.52	270
6	10264.2	-43.59	5.3	11.95	Vertical	-36.94	-13.00	23.94	180
7	11974.9	-47.69	5.5	13.55	Vertical	-39.64	-13.00	26.64	225
8	13685.6	-45.48	6.3	13.75	Vertical	-38.03	-13.00	25.03	45
9	15396.3	-47.52	6.7	13.85	Vertical	-40.37	-13.00	27.37	270
10	17107.0	-43.64	6.8	14.25	Vertical	-36.19	-13.00	23.19	180

Note: 1. The other Spurious RF Radiated emissions level is no more than noise floor.
 2. The worst emission was found in the antenna is Vertical position.

LTE Band 4 QPSK 1.4MHz CH-Middle, RB 1

Harmonic	Frequency (MHz)	SG (dBm)	Cable Loss (dB)	Gain (dBi)	Antenna Polarization	EIRP Level (dBm)	Limit (dBm)	Margin (dB)	Azimuth (deg)
2	3464.3	-52.96	2.6	10.75	Vertical	-44.81	-13.00	31.81	135
3	5197.5	-54.04	2.4	11.05	Vertical	-45.39	-13.00	32.39	270
4	6930.0	-51.54	4.5	11.15	Vertical	-44.89	-13.00	31.89	180
5	8662.5	-45.72	5.1	11.35	Vertical	-39.47	-13.00	26.47	225
6	10395.0	-41.80	5.3	11.95	Vertical	-35.15	-13.00	22.15	270
7	12127.5	-48.31	5.5	13.55	Vertical	-40.26	-13.00	27.26	180
8	13860.0	-44.79	6.3	13.75	Vertical	-37.34	-13.00	24.34	135
9	15592.5	-45.80	6.7	13.85	Vertical	-38.65	-13.00	25.65	270
10	17325.0	-43.25	6.8	14.25	Vertical	-35.80	-13.00	22.80	180

Note: 1. The other Spurious RF Radiated emissions level is no more than noise floor.
 2. The worst emission was found in the antenna is Vertical position.

LTE Band 4 QPSK 1.4MHz CH-High, RB 1

Harmonic	Frequency (MHz)	SG (dBm)	Cable Loss (dB)	Gain (dBi)	Antenna Polarization	EIRP Level (dBm)	Limit (dBm)	Margin (dB)	Azimuth (deg)
2	3507.8	-47.76	2.6	10.15	Vertical	-40.21	-13.00	27.21	225
3	5261.6	-50.42	2.4	11.05	Vertical	-41.77	-13.00	28.77	45
4	7017.2	-50.07	4.5	11.15	Vertical	-43.42	-13.00	30.42	270
5	8771.5	-45.11	5.1	11.35	Vertical	-38.86	-13.00	25.86	180
6	10525.8	-43.53	5.3	11.95	Vertical	-36.88	-13.00	23.88	135
7	12280.1	-47.69	5.5	13.55	Vertical	-39.64	-13.00	26.64	270
8	14034.4	-44.40	6.3	13.75	Vertical	-36.95	-13.00	23.95	180
9	15788.7	-45.28	6.7	13.85	Vertical	-38.13	-13.00	25.13	225
10	17543.0	-44.60	6.8	14.25	Vertical	-37.15	-13.00	24.15	45

Note: 1.The other Spurious RF Radiated emissions level is no more than noise floor.
2. The worst emission was found in the antenna is Vertical position.

LTE Band 4 QPSK 3MHz CH-Low, RB 1

Harmonic	Frequency (MHz)	SG (dBm)	Cable Loss (dB)	Gain (dBi)	Antenna Polarization	EIRP Level (dBm)	Limit (dBm)	Margin (dB)	Azimuth (deg)
2	3423.0	-54.10	2.6	10.15	Vertical	-46.55	-13.00	33.55	90
3	5134.5	-50.24	2.4	11.35	Vertical	-41.29	-13.00	28.29	270
4	6846.0	-52.07	4.5	10.85	Vertical	-45.72	-13.00	32.72	180
5	8557.5	-47.39	5.1	11.35	Vertical	-41.14	-13.00	28.14	135
6	10269.0	-43.49	5.3	11.95	Vertical	-36.84	-13.00	23.84	270
7	11980.5	-45.82	5.5	13.55	Vertical	-37.77	-13.00	24.77	180
8	13692.0	-45.47	6.3	13.75	Vertical	-38.02	-13.00	25.02	225
9	15403.5	-45.16	6.7	13.85	Vertical	-38.01	-13.00	25.01	45
10	17115.0	-43.45	6.8	14.25	Vertical	-36.00	-13.00	23.00	90

Note: 1.The other Spurious RF Radiated emissions level is no more than noise floor.
2. The worst emission was found in the antenna is Vertical position.

LTE Band 4 QPSK 3MHz CH-Middle, RB 1

Harmonic	Frequency (MHz)	SG (dBm)	Cable Loss (dB)	Gain (dBi)	Antenna Polarization	EIRP Level (dBm)	Limit (dBm)	Margin (dB)	Azimuth (deg)
2	3465.0	-52.49	2.6	10.75	Vertical	-44.34	-13.00	31.34	180
3	5197.5	-53.91	2.4	11.05	Vertical	-45.26	-13.00	32.26	270
4	6930.0	-50.61	4.5	11.15	Vertical	-43.96	-13.00	30.96	45
5	8662.5	-46.82	5.1	11.35	Vertical	-40.57	-13.00	27.57	90
6	10395.0	-43.75	5.3	11.95	Vertical	-37.10	-13.00	24.10	135
7	12127.5	-48.04	5.5	13.55	Vertical	-39.99	-13.00	26.99	225
8	13860.0	-44.66	6.3	13.75	Vertical	-37.21	-13.00	24.21	180
9	15592.5	-45.49	6.7	13.85	Vertical	-38.34	-13.00	25.34	270
10	17325.0	-42.22	6.8	14.25	Vertical	-34.77	-13.00	21.77	45

Note: 1. The other Spurious RF Radiated emissions level is no more than noise floor.
2. The worst emission was found in the antenna is Vertical position.

LTE Band 4 QPSK 3MHz CH-High, RB 1

Harmonic	Frequency (MHz)	SG (dBm)	Cable Loss (dB)	Gain (dBi)	Antenna Polarization	EIRP Level (dBm)	Limit (dBm)	Margin (dB)	Azimuth (deg)
2	3504.8	-47.20	2.6	10.15	Vertical	-39.65	-13.00	26.65	270
3	5256.8	-49.74	2.4	11.05	Vertical	-41.09	-13.00	28.09	180
4	7014.0	-48.75	4.5	11.15	Vertical	-42.10	-13.00	29.10	225
5	8767.5	-45.10	5.1	11.35	Vertical	-38.85	-13.00	25.85	45
6	10521.0	-43.87	5.3	11.95	Vertical	-37.22	-13.00	24.22	90
7	12274.5	-47.58	5.5	13.55	Vertical	-39.53	-13.00	26.53	180
8	14028.0	-44.56	6.3	13.75	Vertical	-37.11	-13.00	24.11	270
9	15781.5	-44.36	6.7	13.85	Vertical	-37.21	-13.00	24.21	135
10	17535.0	-44.31	6.8	14.25	Vertical	-36.86	-13.00	23.86	180

Note: 1. The other Spurious RF Radiated emissions level is no more than noise floor.
2. The worst emission was found in the antenna is Vertical position.

LTE Band 4 QPSK 5MHz CH-Low, RB 1

Harmonic	Frequency (MHz)	SG (dBm)	Cable Loss (dB)	Gain (dBi)	Antenna Polarization	EIRP Level (dBm)	Limit (dBm)	Margin (dB)	Azimuth (deg)
2	3425.0	-53.84	2.6	10.15	Vertical	-46.29	-13.00	33.29	225
3	5131.1	-50.35	2.4	11.35	Vertical	-41.40	-13.00	28.40	45
4	6850.0	-51.45	4.5	10.85	Vertical	-45.10	-13.00	32.10	90
5	8562.5	-47.65	5.1	11.35	Vertical	-41.40	-13.00	28.40	180
6	10275.0	-43.45	5.3	11.95	Vertical	-36.80	-13.00	23.80	270
7	11987.5	-48.45	5.5	13.55	Vertical	-40.40	-13.00	27.40	180
8	13700.0	-46.05	6.3	13.75	Vertical	-38.60	-13.00	25.60	225
9	15412.5	-45.65	6.7	13.85	Vertical	-38.50	-13.00	25.50	45
10	17125.0	-44.05	6.8	14.25	Vertical	-36.60	-13.00	23.60	90

Note: 1.The other Spurious RF Radiated emissions level is no more than noise floor.
2. The worst emission was found in the antenna is Vertical position.

LTE Band 4 QPSK 5MHz CH-Middle, RB 1

Harmonic	Frequency (MHz)	SG (dBm)	Cable Loss (dB)	Gain (dBi)	Antenna Polarization	EIRP Level (dBm)	Limit (dBm)	Margin (dB)	Azimuth (deg)
2	3460.5	-52.51	2.6	10.75	Vertical	-44.36	-13.00	31.36	180
3	5191.5	-52.50	2.4	11.05	Vertical	-43.85	-13.00	30.85	135
4	6930.0	-51.21	4.5	11.15	Vertical	-44.56	-13.00	31.56	270
5	8662.5	-50.56	5.1	11.35	Vertical	-44.31	-13.00	31.31	180
6	10395.0	-43.11	5.3	11.95	Vertical	-36.46	-13.00	23.46	225
7	12127.5	-45.46	5.5	13.55	Vertical	-37.41	-13.00	24.41	45
8	13860.0	-45.44	6.3	13.75	Vertical	-37.99	-13.00	24.99	90
9	15592.5	-46.00	6.7	13.85	Vertical	-38.85	-13.00	25.85	270
10	17325.0	-43.82	6.8	14.25	Vertical	-36.37	-13.00	23.37	180

Note: 1.The other Spurious RF Radiated emissions level is no more than noise floor.
2. The worst emission was found in the antenna is Vertical position.

LTE Band 4 QPSK 5MHz CH-High, RB 1

Harmonic	Frequency (MHz)	SG (dBm)	Cable Loss (dB)	Gain (dBi)	Antenna Polarization	EIRP Level (dBm)	Limit (dBm)	Margin (dB)	Azimuth (deg)
2	3500.6	-46.76	2.6	10.15	Vertical	-39.21	-13.00	26.21	90
3	5251.1	-50.69	2.4	11.05	Vertical	-42.04	-13.00	29.04	45
4	7010.0	-49.96	4.5	11.15	Vertical	-43.31	-13.00	30.31	135
5	8762.5	-46.35	5.1	11.35	Vertical	-40.10	-13.00	27.10	180
6	10515.0	-43.55	5.3	11.95	Vertical	-36.90	-13.00	23.90	225
7	12267.5	-48.37	5.5	13.55	Vertical	-40.32	-13.00	27.32	45
8	14020.0	-44.29	6.3	13.75	Vertical	-36.84	-13.00	23.84	90
9	15772.5	-43.37	6.7	13.85	Vertical	-36.22	-13.00	23.22	270
10	17525.0	-42.38	6.8	14.25	Vertical	-34.93	-13.00	21.93	180

Note: 1.The other Spurious RF Radiated emissions level is no more than noise floor.
2. The worst emission was found in the antenna is Vertical position.

LTE Band 4 QPSK 10MHz CH-Low, RB 1

Harmonic	Frequency (MHz)	SG (dBm)	Cable Loss (dB)	Gain (dBi)	Antenna Polarization	EIRP Level (dBm)	Limit (dBm)	Margin (dB)	Azimuth (deg)
2	3430.0	-53.69	2.6	10.15	Vertical	-46.14	-13.00	33.14	90
3	5131.9	-50.20	2.4	11.35	Vertical	-41.25	-13.00	28.25	45
4	6860.0	-51.03	4.5	10.85	Vertical	-44.68	-13.00	31.68	90
5	8575.0	-47.08	5.1	11.35	Vertical	-40.83	-13.00	27.83	180
6	10290.0	-43.15	5.3	11.95	Vertical	-36.50	-13.00	23.50	270
7	12005.0	-48.45	5.5	13.55	Vertical	-40.40	-13.00	27.40	135
8	13720.0	-45.16	6.3	13.75	Vertical	-37.71	-13.00	24.71	180
9	15435.0	-46.20	6.7	13.85	Vertical	-39.05	-13.00	26.05	225
10	17150.0	-43.83	6.8	14.25	Vertical	-36.38	-13.00	23.38	45

Note: 1.The other Spurious RF Radiated emissions level is no more than noise floor.
2. The worst emission was found in the antenna is Vertical position.



LTE Band 4 QPSK 10MHz CH-Middle, RB 1

Harmonic	Frequency (MHz)	SG (dBm)	Cable Loss (dB)	Gain (dBi)	Antenna Polarization	EIRP Level (dBm)	Limit (dBm)	Margin (dB)	Azimuth (deg)
2	3456.0	-52.40	2.6	10.75	Vertical	-44.25	-13.00	31.25	90
3	5184.4	-51.87	2.4	11.05	Vertical	-43.22	-13.00	30.22	180
4	6930.0	-50.97	4.5	11.15	Vertical	-44.32	-13.00	31.32	270
5	8662.5	-47.77	5.1	11.35	Vertical	-41.52	-13.00	28.52	180
6	10395.0	-43.31	5.3	11.95	Vertical	-36.66	-13.00	23.66	225
7	12127.5	-48.04	5.5	13.55	Vertical	-39.99	-13.00	26.99	45
8	13860.0	-45.07	6.3	13.75	Vertical	-37.62	-13.00	24.62	90
9	15592.5	-45.20	6.7	13.85	Vertical	-38.05	-13.00	25.05	180
10	17325.0	-42.82	6.8	14.25	Vertical	-35.37	-13.00	22.37	135

Note: 1.The other Spurious RF Radiated emissions level is no more than noise floor.
2. The worst emission was found in the antenna is Vertical position.

LTE Band 4 QPSK 10MHz CH-High, RB 1

Harmonic	Frequency (MHz)	SG (dBm)	Cable Loss (dB)	Gain (dBi)	Antenna Polarization	EIRP Level (dBm)	Limit (dBm)	Margin (dB)	Azimuth (deg)
2	3490.9	-49.14	2.6	10.15	Vertical	-41.59	-13.00	28.59	90
3	5236.9	-49.44	2.4	11.05	Vertical	-40.79	-13.00	27.79	180
4	7000.0	-49.95	4.5	11.15	Vertical	-43.30	-13.00	30.30	225
5	8750.0	-45.56	5.1	11.35	Vertical	-39.31	-13.00	26.31	45
6	10500.0	-43.79	5.3	11.95	Vertical	-37.14	-13.00	24.14	90
7	12250.0	-47.85	5.5	13.55	Vertical	-39.80	-13.00	26.80	180
8	14000.0	-45.28	6.3	13.75	Vertical	-37.83	-13.00	24.83	270
9	15750.0	-44.26	6.7	13.85	Vertical	-37.11	-13.00	24.11	45
10	17500.0	-42.95	6.8	14.25	Vertical	-35.50	-13.00	22.50	135

Note: 1.The other Spurious RF Radiated emissions level is no more than noise floor.
2. The worst emission was found in the antenna is Vertical position.

LTE Band 4 QPSK 15MHz CH Low, RB 1

Harmonic	Frequency (MHz)	SG (dBm)	Cable Loss (dB)	Gain (dBi)	Antenna Polarization	EIRP Level (dBm)	Limit (dBm)	Margin (dB)	Azimuth (deg)
2	3435.0	-54.53	2.6	10.15	Vertical	-46.98	-13.00	33.98	45
3	5152.5	-50.62	2.4	11.35	Vertical	-41.67	-13.00	28.67	90
4	6870.0	-50.55	4.5	10.85	Vertical	-44.20	-13.00	31.20	90
5	8587.5	-47.75	5.1	11.35	Vertical	-41.50	-13.00	28.50	45
6	10305.0	-43.85	5.3	11.95	Vertical	-37.20	-13.00	24.20	135
7	12022.5	-47.75	5.5	13.55	Vertical	-39.70	-13.00	26.70	225
8	13740.0	-45.55	6.3	13.75	Vertical	-38.10	-13.00	25.10	45
9	15457.5	-45.15	6.7	13.85	Vertical	-38.00	-13.00	25.00	90
10	17175.0	-43.65	6.8	14.25	Vertical	-36.20	-13.00	23.20	135

Note: 1.The other Spurious RF Radiated emissions level is no more than noise floor.
2. The worst emission was found in the antenna is Vertical position.

LTE Band 4 QPSK 15MHz CH-Middle, RB 1

Harmonic	Frequency (MHz)	SG (dBm)	Cable Loss (dB)	Gain (dBi)	Antenna Polarization	EIRP Level (dBm)	Limit (dBm)	Margin (dB)	Azimuth (deg)
2	3465.0	-53.70	2.6	10.75	Vertical	-45.55	-13.00	32.55	135
3	5197.5	-51.03	2.4	11.05	Vertical	-42.38	-13.00	29.38	45
4	6930.0	-51.56	4.5	11.15	Vertical	-44.91	-13.00	31.91	90
5	8662.5	-47.12	5.1	11.35	Vertical	-40.87	-13.00	27.87	180
6	10395.0	-44.04	5.3	11.95	Vertical	-37.39	-13.00	24.39	270
7	12127.5	-46.83	5.5	13.55	Vertical	-38.78	-13.00	25.78	225
8	13860.0	-45.31	6.3	13.75	Vertical	-37.86	-13.00	24.86	135
9	15592.5	-46.17	6.7	13.85	Vertical	-39.02	-13.00	26.02	225
10	17325.0	-43.95	6.8	14.25	Vertical	-36.50	-13.00	23.50	45

Note: 1.The other Spurious RF Radiated emissions level is no more than noise floor.
2. The worst emission was found in the antenna is Vertical position.



LTE Band 4 QPSK 15MHz CH-High, RB 1

Harmonic	Frequency (MHz)	SG (dBm)	Cable Loss (dB)	Gain (dBi)	Antenna Polarization	EIRP Level (dBm)	Limit (dBm)	Margin (dB)	Azimuth (deg)
2	3481.5	-51.85	2.6	10.15	Vertical	-44.30	-13.00	31.30	90
3	5222.3	-47.75	2.4	11.05	Vertical	-39.10	-13.00	26.10	135
4	6990.0	-50.85	4.5	11.15	Vertical	-44.20	-13.00	31.20	225
5	8737.5	-46.35	5.1	11.35	Vertical	-40.10	-13.00	27.10	45
6	10485.0	-43.15	5.3	11.95	Vertical	-36.50	-13.00	23.50	90
7	12232.5	-49.15	5.5	13.55	Vertical	-41.10	-13.00	28.10	135
8	13980.0	-44.65	6.3	13.75	Vertical	-37.20	-13.00	24.20	135
9	15727.5	-44.75	6.7	13.85	Vertical	-37.60	-13.00	24.60	90
10	17475.0	-43.95	6.8	14.25	Vertical	-36.50	-13.00	23.50	225

Note: 1.The other Spurious RF Radiated emissions level is no more than noise floor.
2. The worst emission was found in the antenna is Vertical position.

LTE Band 4 QPSK 20MHz CH-Low, RB 1

Harmonic	Frequency (MHz)	SG (dBm)	Cable Loss (dB)	Gain (dBi)	Antenna Polarization	EIRP Level (dBm)	Limit (dBm)	Margin (dB)	Azimuth (deg)
2	3440.0	-54.05	2.6	10.15	Vertical	-46.50	-13.00	33.50	135
3	5133.4	-50.05	2.4	11.35	Vertical	-41.10	-13.00	28.10	90
4	6880.0	-52.65	4.5	10.85	Vertical	-46.30	-13.00	33.30	45
5	8600.0	-46.55	5.1	11.35	Vertical	-40.30	-13.00	27.30	90
6	10320.0	-43.25	5.3	11.95	Vertical	-36.60	-13.00	23.60	90
7	12040.0	-48.05	5.5	13.55	Vertical	-40.00	-13.00	27.00	135
8	13760.0	-46.15	6.3	13.75	Vertical	-38.70	-13.00	25.70	225
9	15480.0	-45.55	6.7	13.85	Vertical	-38.40	-13.00	25.40	135
10	17200.0	-43.35	6.8	14.25	Vertical	-35.90	-13.00	22.90	90

Note: 1.The other Spurious RF Radiated emissions level is no more than noise floor.
2. The worst emission was found in the antenna is Vertical position.

LTE Band 4 QPSK 20MHz CH-Middle, RB 1

Harmonic	Frequency (MHz)	SG (dBm)	Cable Loss (dB)	Gain (dBi)	Antenna Polarization	EIRP Level (dBm)	Limit (dBm)	Margin (dB)	Azimuth (deg)
2	3465.0	-53.15	2.6	10.75	Vertical	-45.00	-13.00	32.00	90
3	5170.9	-50.25	2.4	11.05	Vertical	-41.60	-13.00	28.60	45
4	6930.0	-50.75	4.5	11.15	Vertical	-44.10	-13.00	31.10	45
5	8662.5	-46.55	5.1	11.35	Vertical	-40.30	-13.00	27.30	180
6	10395.0	-42.65	5.3	11.95	Vertical	-36.00	-13.00	23.00	270
7	12127.5	-47.85	5.5	13.55	Vertical	-39.80	-13.00	26.80	225
8	13860.0	-46.15	6.3	13.75	Vertical	-38.70	-13.00	25.70	135
9	15592.5	-45.45	6.7	13.85	Vertical	-38.30	-13.00	25.30	180
10	17325.0	-42.45	6.8	14.25	Vertical	-35.00	-13.00	22.00	225

Note: 1.The other Spurious RF Radiated emissions level is no more than noise floor.
2. The worst emission was found in the antenna is Vertical position.

LTE Band 4 QPSK 20MHz CH-High, RB 1

Harmonic	Frequency (MHz)	SG (dBm)	Cable Loss (dB)	Gain (dBi)	Antenna Polarization	EIRP Level (dBm)	Limit (dBm)	Margin (dB)	Azimuth (deg)
2	3490.0	-51.15	2.6	10.15	Vertical	-43.60	-13.00	30.60	45
3	5208.4	-52.65	2.4	11.05	Vertical	-44.00	-13.00	31.00	225
4	6980.0	-51.85	4.5	11.15	Vertical	-45.20	-13.00	32.20	135
5	8725.0	-45.75	5.1	11.35	Vertical	-39.50	-13.00	26.50	90
6	10470.0	-42.85	5.3	11.95	Vertical	-36.20	-13.00	23.20	45
7	12215.0	-47.85	5.5	13.55	Vertical	-39.80	-13.00	26.80	90
8	13960.0	-44.65	6.3	13.75	Vertical	-37.20	-13.00	24.20	45
9	15705.0	-44.95	6.7	13.85	Vertical	-37.80	-13.00	24.80	135
10	17450.0	-44.05	6.8	14.25	Vertical	-36.60	-13.00	23.60	90

Note: 1.The other Spurious RF Radiated emissions level is no more than noise floor.
2. The worst emission was found in the antenna is Vertical position.

LTE Band 7 QPSK 5MHz CH-Low, RB 1

Harmonic	Frequency (MHz)	SG (dBm)	Cable Loss (dB)	Gain (dBi)	Antenna Polarization	EIRP Level (dBm)	Limit (dBm)	Margin (dB)	Azimuth (deg)
2	5000.6	-51.93	2.00	9.15	Vertical	-44.78	-25.00	19.78	180
3	7501.1	-49.30	2.50	11.35	Vertical	-40.45	-25.00	15.45	225
4	10001.3	-46.23	4.20	12.05	Vertical	-38.38	-25.00	13.38	45
5	12512.5	-44.22	5.20	12.85	Vertical	-36.57	-25.00	11.57	180
6	15015.0	-47.59	5.50	14.23	Vertical	-38.86	-25.00	13.86	270
7	17517.5	-44.45	5.70	14.15	Vertical	-36.00	-25.00	11.00	135
8	20020.0	/	/	/	/	/	/	/	/
9	22522.5	/	/	/	/	/	/	/	/
10	25025.0	/	/	/	/	/	/	/	/

Note: 1.The other Spurious RF Radiated emissions level is no more than noise floor.
2. The worst emission was found in the antenna is Vertical position.

LTE Band 7 QPSK 5MHz CH-Middle, RB 1

Harmonic	Frequency (MHz)	SG (dBm)	Cable Loss (dB)	Gain (dBi)	Antenna Polarization	EIRP Level (dBm)	Limit (dBm)	Margin (dB)	Azimuth (deg)
2	5065.8	-49.21	2.00	9.15	Vertical	-42.06	-25.00	17.06	135
3	7598.6	-49.11	2.50	11.35	Vertical	-40.26	-25.00	15.26	180
4	10130.6	-43.65	4.20	12.05	Vertical	-35.80	-25.00	10.80	90
5	12675.0	-46.15	5.20	12.85	Vertical	-38.50	-25.00	13.50	45
6	15210.0	-46.83	5.50	14.23	Vertical	-38.10	-25.00	13.10	180
7	17745.0	-45.15	5.70	14.15	Vertical	-36.70	-25.00	11.70	270
8	20280.0	/	/	/	/	/	/	/	/
9	22815.0	/	/	/	/	/	/	/	/
10	25350.0	/	/	/	/	/	/	/	/

Note: 1.The other Spurious RF Radiated emissions level is no more than noise floor.
2. The worst emission was found in the antenna is Vertical position.

LTE Band 7 QPSK 5MHz CH-High, RB 1

Harmonic	Frequency (MHz)	SG (dBm)	Cable Loss (dB)	Gain (dBi)	Antenna Polarization	EIRP Level (dBm)	Limit (dBm)	Margin (dB)	Azimuth (deg)
2	5130.8	-48.08	2.00	9.15	Vertical	-40.93	-25.00	15.93	225
3	7696.1	-50.04	2.50	11.35	Vertical	-41.19	-25.00	16.19	45
4	10261.1	-43.16	4.20	12.05	Vertical	-35.31	-25.00	10.31	90
5	12837.5	-46.06	5.20	12.85	Vertical	-38.41	-25.00	13.41	180
6	15405.0	-46.69	5.50	14.23	Vertical	-37.96	-25.00	12.96	180
7	17972.5	-44.26	5.70	14.15	Vertical	-35.81	-25.00	10.81	270
8	20540.0	/	/	/	/	/	/	/	/
9	23107.5	/	/	/	/	/	/	/	/
10	25675.0	/	/	/	/	/	/	/	/

Note: 1.The other Spurious RF Radiated emissions level is no more than noise floor.
 2. The worst emission was found in the antenna is Vertical position.

LTE Band 7 QPSK 10MHz CH-Low, RB 1

Harmonic	Frequency (MHz)	SG (dBm)	Cable Loss (dB)	Gain (dBi)	Antenna Polarization	EIRP Level (dBm)	Limit (dBm)	Margin (dB)	Azimuth (deg)
2	5001.0	-51.69	2.00	9.15	Vertical	-44.54	-25.00	19.54	225
3	7515.0	-48.82	2.50	11.35	Vertical	-39.97	-25.00	14.97	45
4	10002.4	-45.04	4.20	12.05	Vertical	-37.19	-25.00	12.19	180
5	12525.0	-48.93	5.20	12.85	Vertical	-41.28	-25.00	16.28	270
6	15030.0	-45.90	5.50	14.23	Vertical	-37.17	-25.00	12.17	135
7	17535.0	-45.17	5.70	14.15	Vertical	-36.72	-25.00	11.72	180
8	20040.0	/	/	/	/	/	/	/	/
9	22545.0	/	/	/	/	/	/	/	/
10	25050.0	/	/	/	/	/	/	/	/

Note: 1.The other Spurious RF Radiated emissions level is no more than noise floor.
 2. The worst emission was found in the antenna is Vertical position.

LTE Band 7 QPSK 10MHz CH-Middle, RB 1

Harmonic	Frequency (MHz)	SG (dBm)	Cable Loss (dB)	Gain (dBi)	Antenna Polarization	EIRP Level (dBm)	Limit (dBm)	Margin (dB)	Azimuth (deg)
2	5061.9	-48.22	2.00	9.15	Vertical	-41.07	-25.00	16.07	45
3	7598.6	-49.47	2.50	11.35	Vertical	-40.62	-25.00	15.62	180
4	10130.6	-44.85	4.20	12.05	Vertical	-37.00	-25.00	12.00	270
5	12675.0	-46.91	5.20	12.85	Vertical	-39.26	-25.00	14.26	135
6	15210.0	-47.97	5.50	14.23	Vertical	-39.24	-25.00	14.24	180
7	17745.0	-44.16	5.70	14.15	Vertical	-35.71	-25.00	10.71	225
8	20280.0	/	/	/	/	/	/	/	/
9	22815.0	/	/	/	/	/	/	/	/
10	25350.0	/	/	/	/	/	/	/	/

Note: 1.The other Spurious RF Radiated emissions level is no more than noise floor.
2. The worst emission was found in the antenna is Vertical position.

LTE Band 7 QPSK 10MHz CH-High, RB 1

Harmonic	Frequency (MHz)	SG (dBm)	Cable Loss (dB)	Gain (dBi)	Antenna Polarization	EIRP Level (dBm)	Limit (dBm)	Margin (dB)	Azimuth (deg)
2	5121.4	-48.53	2.00	10.15	Vertical	-40.38	-25.00	15.38	45
3	7681.9	-49.68	2.50	11.35	Vertical	-40.83	-25.00	15.83	180
4	10242.0	-45.19	4.20	12.05	Vertical	-37.34	-25.00	12.34	225
5	12825.0	-49.80	5.20	14.85	Vertical	-40.15	-25.00	15.15	45
6	15390.0	-46.87	5.50	13.23	Vertical	-39.14	-25.00	14.14	90
7	17955.0	-43.00	5.70	12.15	Vertical	-36.55	-25.00	11.55	180
8	20520.0	/	/	/	/	/	/	/	/
9	23085.0	/	/	/	/	/	/	/	/
10	25650.0	/	/	/	/	/	/	/	/

Note: 1.The other Spurious RF Radiated emissions level is no more than noise floor.
2. The worst emission was found in the antenna is Vertical position.

LTE Band 7 QPSK 15MHz CH-Low, RB 1

Harmonic	Frequency (MHz)	SG (dBm)	Cable Loss (dB)	Gain (dBi)	Antenna Polarization	EIRP Level (dBm)	Limit (dBm)	Margin (dB)	Azimuth (deg)
2	5001.8	-51.04	2.00	10.15	Vertical	-42.89	-25.00	17.89	270
3	7502.6	-49.05	2.50	11.35	Vertical	-40.20	-25.00	15.20	135
4	1000.4	-45.63	4.20	12.05	Vertical	-37.78	-25.00	12.78	180
5	12537.5	-50.03	5.20	14.85	Vertical	-40.38	-25.00	15.38	225
6	15045.0	-47.24	5.50	13.23	Vertical	-39.51	-25.00	14.51	45
7	17552.5	-42.41	5.70	12.15	Vertical	-35.96	-25.00	10.96	90
8	20060.0	/	/	/	/	/	/	/	/
9	22567.5	/	/	/	/	/	/	/	/
10	25075.0	/	/	/	/	/	/	/	/

Note: 1.The other Spurious RF Radiated emissions level is no more than noise floor.
2. The worst emission was found in the antenna is Vertical position.

LTE Band 7 QPSK 15MHz CH-Middle, RB 1

Harmonic	Frequency (MHz)	SG (dBm)	Cable Loss (dB)	Gain (dBi)	Antenna Polarization	EIRP Level (dBm)	Limit (dBm)	Margin (dB)	Azimuth (deg)
2	5065.8	-50.40	2.00	10.15	Vertical	-42.25	-25.00	17.25	180
3	7598.6	-50.06	2.50	11.35	Vertical	-41.21	-25.00	16.21	270
4	10130.6	-44.54	4.20	12.05	Vertical	-36.69	-25.00	11.69	135
5	12675.0	-50.63	5.20	14.85	Vertical	-40.98	-25.00	15.98	180
6	15210.0	-46.35	5.50	13.23	Vertical	-38.62	-25.00	13.62	225
7	17745.0	-42.99	5.70	12.15	Vertical	-36.54	-25.00	11.54	45
8	20280.0	/	/	/	/	/	/	/	/
9	22815.0	/	/	/	/	/	/	/	/
10	25350.0	/	/	/	/	/	/	/	/

Note: 1.The other Spurious RF Radiated emissions level is no more than noise floor.
2. The worst emission was found in the antenna is Vertical position.

LTE Band 7 QPSK 15MHz CH-High, RB 1

Harmonic	Frequency (MHz)	SG (dBm)	Cable Loss (dB)	Gain (dBi)	Antenna Polarization	EIRP Level (dBm)	Limit (dBm)	Margin (dB)	Azimuth (deg)
2	5112.0	-50.29	2.00	10.15	Vertical	-42.14	-25.00	17.14	270
3	7667.3	-49.17	2.50	11.35	Vertical	-40.32	-25.00	15.32	135
4	10250.0	-45.06	4.20	12.05	Vertical	-37.21	-25.00	12.21	45
5	12812.5	-49.09	5.20	14.85	Vertical	-39.44	-25.00	14.44	270
6	15375.0	-45.02	5.50	13.23	Vertical	-37.29	-25.00	12.29	180
7	17937.5	-43.43	5.70	12.15	Vertical	-36.98	-25.00	11.98	270
8	20500.0	/	/	/	/	/	/	/	/
9	23062.5	/	/	/	/	/	/	/	/
10	25625.0	/	/	/	/	/	/	/	/

Note: 1.The other Spurious RF Radiated emissions level is no more than noise floor.
2. The worst emission was found in the antenna is Vertical position.

LTE Band 7 QPSK 20MHz CH-Low, RB 1

Harmonic	Frequency (MHz)	SG (dBm)	Cable Loss (dB)	Gain (dBi)	Antenna Polarization	EIRP Level (dBm)	Limit (dBm)	Margin (dB)	Azimuth (deg)
2	5002.1	-50.86	2.00	10.15	Vertical	-42.71	-25.00	17.71	270
3	7530.0	-48.39	2.50	11.35	Vertical	-39.54	-25.00	14.54	180
4	10040.0	-43.95	4.20	12.05	Vertical	-36.10	-25.00	11.10	270
5	12550.0	-51.21	5.20	14.85	Vertical	-41.56	-25.00	16.56	135
6	15060.0	-47.69	5.50	13.23	Vertical	-39.96	-25.00	14.96	180
7	17570.0	-41.60	5.70	12.15	Vertical	-35.15	-25.00	10.15	270
8	20080.0	/	/	/	/	/	/	/	/
9	22590.0	/	/	/	/	/	/	/	/
10	25100.0	/	/	/	/	/	/	/	/

Note: 1.The other Spurious RF Radiated emissions level is no more than noise floor.
2. The worst emission was found in the antenna is Vertical position.

LTE Band 7 QPSK 20MHz CH-Middle, RB 1

Harmonic	Frequency (MHz)	SG (dBm)	Cable Loss (dB)	Gain (dBi)	Antenna Polarization	EIRP Level (dBm)	Limit (dBm)	Margin (dB)	Azimuth (deg)
2	5052.4	-49.21	2.00	10.15	Vertical	-41.06	-25.00	16.06	270
3	7605.0	-50.28	2.50	11.35	Vertical	-41.43	-25.00	16.43	135
4	10140.0	-42.99	4.20	12.05	Vertical	-35.14	-25.00	10.14	45
5	12675.0	-48.72	5.20	14.85	Vertical	-39.07	-25.00	14.07	270
6	15210.0	-45.35	5.50	13.23	Vertical	-37.62	-25.00	12.62	180
7	17745.0	-42.26	5.70	12.15	Vertical	-35.81	-25.00	10.81	270
8	20280.0	/	/	/	/	/	/	/	/
9	22815.0	/	/	/	/	/	/	/	/
10	25350.0	/	/	/	/	/	/	/	/

Note: 1.The other Spurious RF Radiated emissions level is no more than noise floor.
2. The worst emission was found in the antenna is Vertical position.

LTE Band 7 QPSK 20MHz CH-High, RB 1

Harmonic	Frequency (MHz)	SG (dBm)	Cable Loss (dB)	Gain (dBi)	Antenna Polarization	EIRP Level (dBm)	Limit (dBm)	Margin (dB)	Azimuth (deg)
2	5102.3	-48.90	2.00	10.15	Vertical	-40.75	-25.00	15.75	45
3	7680.0	-48.35	2.50	11.35	Vertical	-39.50	-25.00	14.50	180
4	10240.0	-44.18	4.20	12.05	Vertical	-36.33	-25.00	11.33	270
5	12800.0	-49.11	5.20	14.85	Vertical	-39.46	-25.00	14.46	135
6	15360.0	-45.43	5.50	13.23	Vertical	-37.70	-25.00	12.70	45
7	17920.0	-42.23	5.70	12.15	Vertical	-35.78	-25.00	10.78	270
8	20480.0	/	/	/	/	/	/	/	/
9	23040.0	/	/	/	/	/	/	/	/
10	25600.0	/	/	/	/	/	/	/	/

Note: 1.The other Spurious RF Radiated emissions level is no more than noise floor.
2. The worst emission was found in the antenna is Vertical position.

6 Main Test Instruments

Name	Manufacturer	Type	Serial Number	Calibration Date	Expiration Date
Base Station Simulator	R&S	CMW500	113645	2017-05-14	2018-05-13
Universal Radio Communication Tester	Agilent	E5515C	MY48367192	2017-05-20	2018-05-19
Power Splitter	Hua Xiang	SHX-GF2-2-13	10120101	2017-05-14	2018-05-13
Spectrum Analyzer	Agilent	N9010A	MY47191109	2017-05-14	2018-05-13
Signal Analyzer	R&S	FSV30	100815	2017-12-17	2018-12-16
Signal generator	R&S	SMB 100A	102594	2017-05-14	2018-05-13
EMI Test Receiver	R&S	ESCI	100948	2017-05-20	2018-05-19
Trilog Antenna	SCHWARZBECK	VUBL 9163	9163-201	2017-11-18	2020-11-17
Horn Antenna	R&S	HF907	100126	2014-12-06	2019-12-05
Horn Antenna	ETS-Lindgren	3160-09	00102643	2015-01-30	2020-01-29
Climatic Chamber	Re Ce	PT-30B	20101891	2015-07-18	2018-07-17
RF Cable	Agilent	SMA 15cm	0001	NA	NA
Preamplifier	R&S	SCU18	102327	2017-06-18	2018-06-17
MOB COMMS DC SUPPLY	Keysight	66319D	MY43004105	2017-05-14	2018-05-13
Software	R&S	EMC32	V 8.52.0	NA	NA

*****END OF REPORT *****

ANNEX A: EUT Appearance and Test Setup

A.1 EUT Appearance

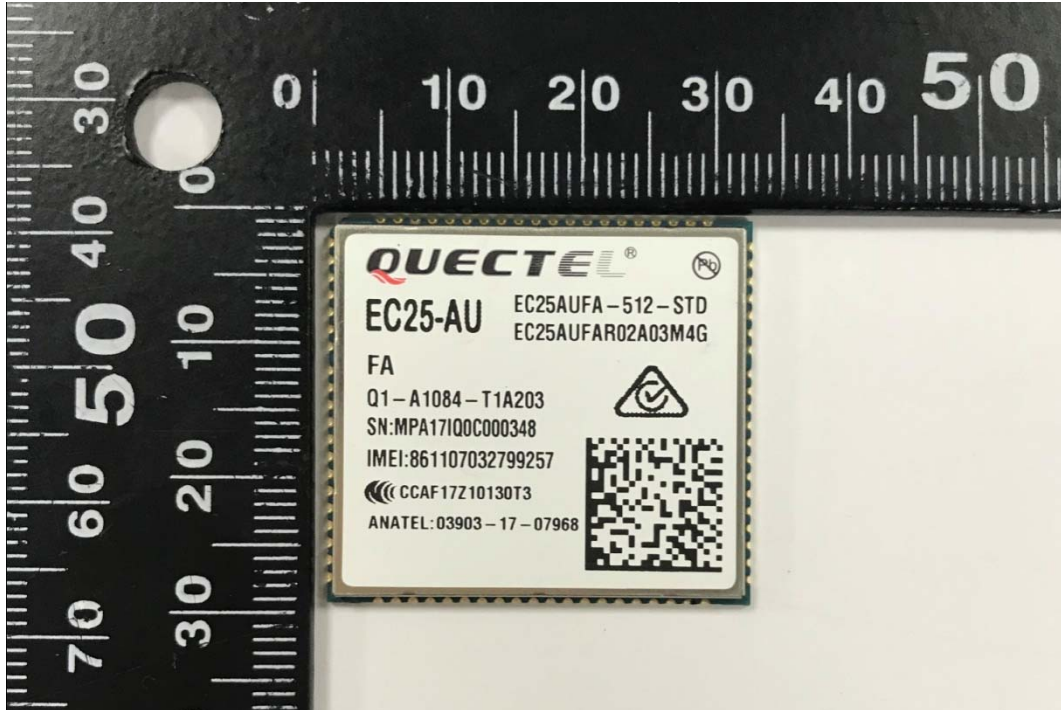

Front Side

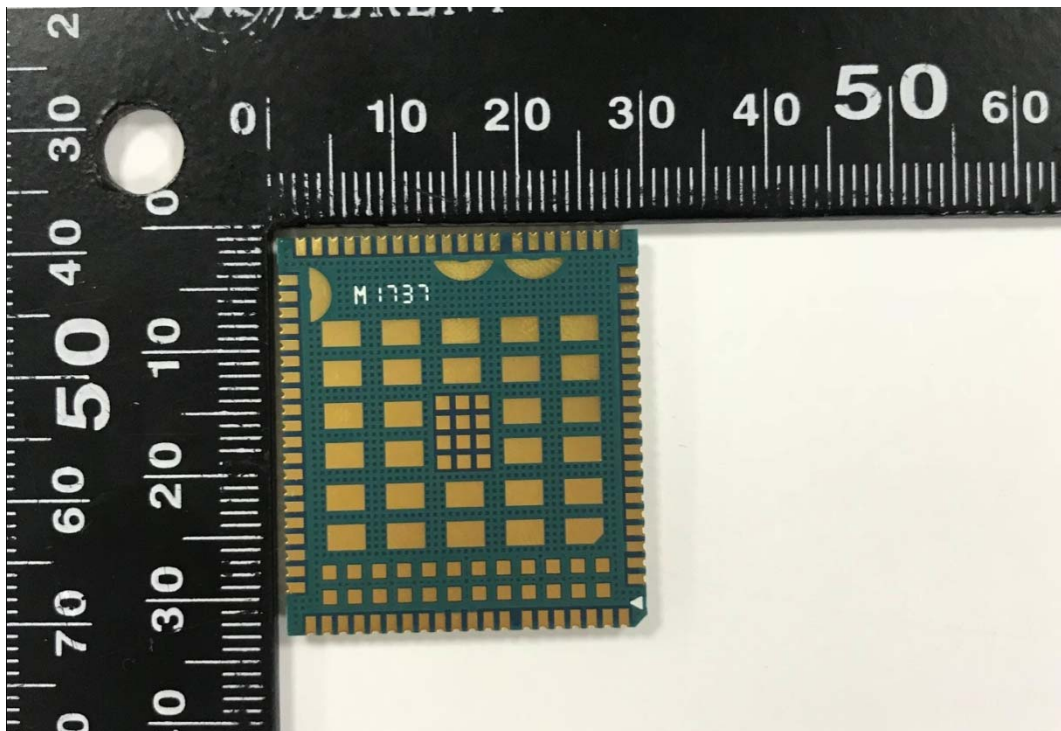

Back Side

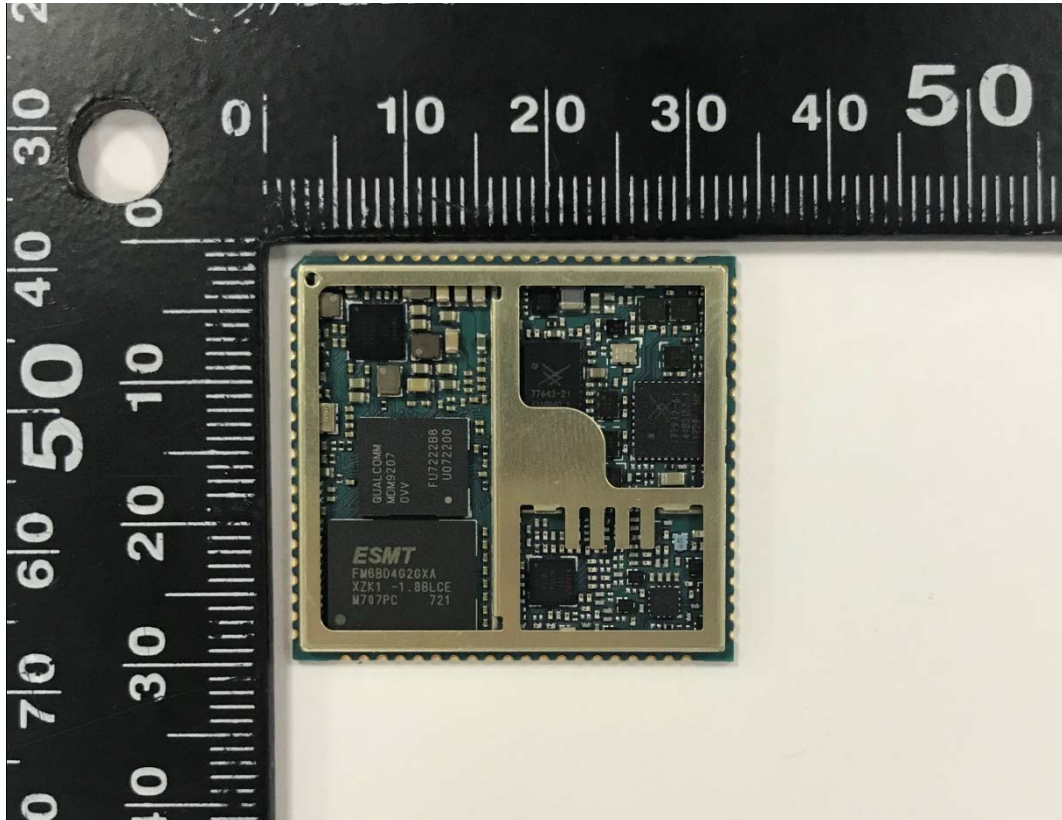

no shielding

a: EUT

Picture 1 EUT and Accessory

A.2 Test Setup

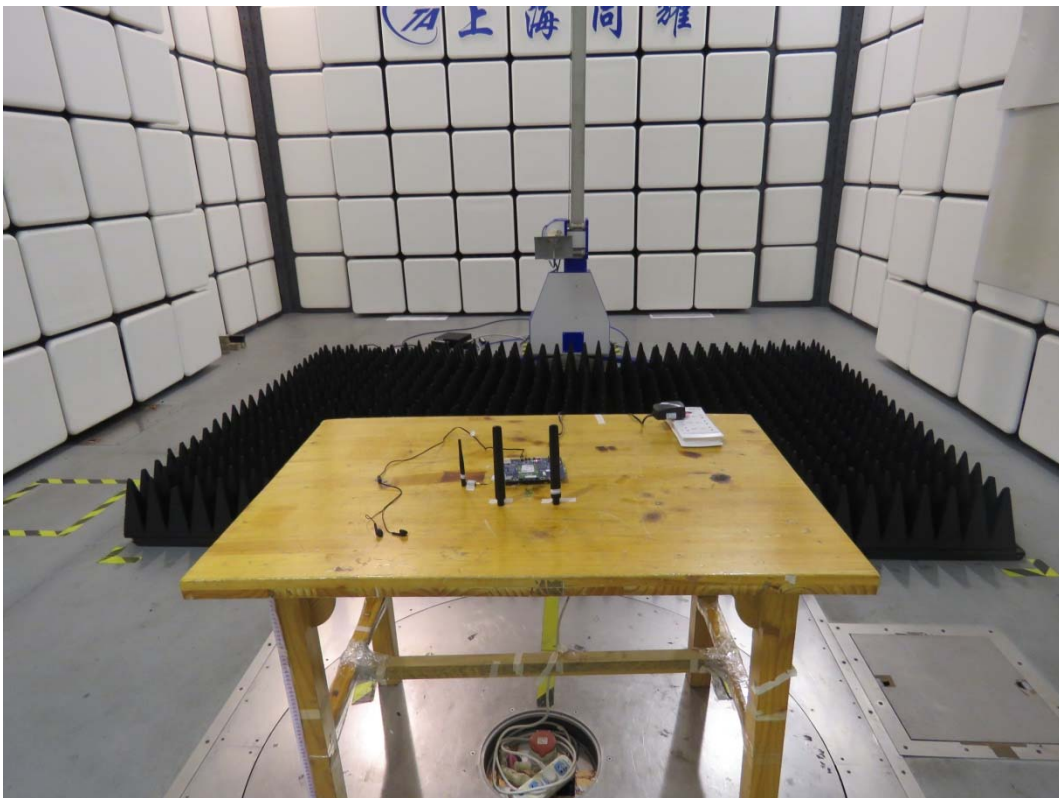

Picture 2: Radiated Spurious Emissions Test setup