



# RF TEST REPORT

**Applicant**      Quectel Wireless Solutions Co., Ltd.  
**FCC ID**            XMR201707BG96  
**Product**          Quectel BG96  
**Brand**             Quectel  
**Model**             BG96  
**Report No.**      R2003A0151-R3  
**Issue Date**      July 14, 2020

TA Technology (Shanghai) Co., Ltd. tested the above equipment in accordance with the requirements in **FCC CFR47 Part 2 (2019)/ FCC CFR47 Part 27C (2019)**. The test results show that the equipment tested is capable of demonstrating compliance with the requirements as documented in this report.

*Performed by: Peng Tao*

*Approved by: Kai Xu*

---

**TA Technology (Shanghai) Co., Ltd.**

*No.145, Jintang Rd, Tangzhen Industry Park, Pudong Shanghai, China*

*TEL: +86-021-50791141/2/3*

*FAX: +86-021-50791141/2/3-8000*

## Table of Contents

1	Test Laboratory.....	4
1.1	Notes of the Test Report.....	4
1.2	Test facility.....	4
1.3	Testing Location.....	5
2	General Description of Equipment under Test.....	6
3	Applied Standards.....	8
4	Test Configuration.....	9
5	Test Case Results.....	10
5.1	RF Power Output and Effective Isotropic Radiated Power.....	10
5.2	Occupied Bandwidth.....	15
5.3	Band Edge Compliance.....	25
5.4	Peak-to-Average Power Ratio (PAPR).....	35
5.5	Frequency Stability.....	37
5.6	Spurious Emissions at Antenna Terminals.....	42
5.7	Radiates Spurious Emission.....	48
6	Main Test Instruments.....	57

## Summary of Measurement Results

Number	Test Case	Clause in FCC rules	Verdict
1	RF Power Output and Effective Isotropic Radiated Power	2.1046 27.50(d)(4) /27.50(b)(10) /27.50(c)(10)	PASS
2	Occupied Bandwidth	2.1049	PASS
3	Band Edge Compliance	27.53(h) /27.53(g) /27.53(f) /27.53(c)	PASS
4	Peak-to-Average Power Ratio	27.50(d)/KDB971168 D01(5.7)	Only test NB-IOT Band 4
5	Frequency Stability	2.1055 / 27.54	PASS
6	Spurious Emissions at Antenna Terminals	2.1051 /27.53(h) /27.53(g) /27.53(f) /27.53(c)	PASS
7	Radiates Spurious Emission	2.1053 /27.53(h) /27.53(g) /27.53(f) /27.53(c)	Only test NB-IOT Band 4
Date of Testing: August 4, 2017 ~August 18, 2017 and April 2, 2020 ~ April 9, 2020 and May 30, 2020~July 13, 2020			
<p>Note: PASS: The EUT complies with the essential requirements in the standard.            FAIL: The EUT does not comply with the essential requirements in the standard.            All indications of Pass/Fail in this report are opinions expressed by TA Technology (Shanghai) Co., Ltd. based on interpretations and/or observations of test results. Measurement Uncertainties were not taken into account and are published for informational purposes only.</p>			

**BG96 (Report No.: R2003A0151-R3) is a variant model of BG96 (Report No.: RXA1706-0199RF07). Test values partial duplicated from original for variant. There is tested RF power output, Effective Radiated Power, Occupied Bandwidth, Band Edge Compliance , Peak-to-Average Power Ratio, Frequency Stability and Spurious Emissions at Antenna Terminals of other bands for variant in this report. For NB-IOT Band 4,there is tested all items. The detailed product change description please refers to the Statement letter\_BG96.**

# 1 Test Laboratory

## 1.1 Notes of the Test Report

This report shall not be reproduced in full or partial, without the written approval of **TA technology (shanghai) co., Ltd.** The results documented in this report apply only to the tested sample, under the conditions and modes of operation as described herein. Measurement Uncertainties were not taken into account and are published for informational purposes only. This report is written to support regulatory compliance of the applicable standards stated above. This report must not be used by the client to claim product certification, approval, or endorsement by any government agencies.

## 1.2 Test facility

### **FCC (Designation number: CN1179, Test Firm Registration Number: 446626)**

TA Technology (Shanghai) Co., Ltd. has been listed on the US Federal Communications Commission list of test facilities recognized to perform electromagnetic emissions measurements.

### **A2LA (Certificate Number: 3857.01)**

TA Technology (Shanghai) Co., Ltd. has been listed by American Association for Laboratory Accreditation to perform electromagnetic emission measurement.

### 1.3 Testing Location

Company: TA Technology (Shanghai) Co., Ltd.  
Address: No.145, Jintang Rd, Tangzhen Industry Park, Pudong Shanghai, China  
City: Shanghai  
Post code: 201201  
Country: P. R. China  
Contact: Xu Kai  
Telephone: +86-021-50791141/2/3  
Fax: +86-021-50791141/2/3-8000  
Website: <http://www.ta-shanghai.com>  
E-mail: [xukai@ta-shanghai.com](mailto:xukai@ta-shanghai.com)

## 2 General Description of Equipment under Test

### Client Information

<b>Applicant</b>	Quectel Wireless Solutions Co., Ltd.
<b>Applicant address</b>	7th Floor, Hongye Building, No. 1801 Hongmei Road, Xuhui District, Shanghai, China
<b>Manufacturer</b>	Quectel Wireless Solutions Co., Ltd.
<b>Manufacturer address</b>	7th Floor, Hongye Building, No. 1801 Hongmei Road, Xuhui District, Shanghai, China

### General information

EUT Description			
Model:	BG96		
Hardware Version:	R1.0		
Software Version:	BG96MAR02A09M1G		
Power Supply:	External power supply		
Antenna Type:	The EUT don't have standard Antenna, The Antenna used for testing in this report is the after-market accessory (Dipole Antenna)		
Antenna Gain	Frequency(MHz)	Gain (dBi)	
	700	1.66	
	710	3.26	
	720	3.95	
	780	4.45	
	790	3.63	
	1740	2.00	
1760	1.57		
Test Mode(s):	NB-IOT Band 4;NB-IOT Band 12; NB-IOT Band 13;		
Test Modulation	BPSK, QPSK		
Category	NB1		
Deployment	stand-alone		
Sub-carrier spacing	3.75KHz, 15KHz		
Ntones	single-tone, multi-tone		
Maximum E.I.R.P.	NB-IOT Band 4:	25.45 dBm	
Maximum E.R.P.	NB-IOT Band 12:	25.24 dBm	
	NB-IOT Band 13:	25.43 dBm	
Rated Power Supply Voltage:	3.8V		
Extreme Voltage:	Minimum: 3.3V Maximum: 4.3V		
Extreme Temperature:	Lowest: -40°C Highest: +85°C		
Frequency Range(s)	Mode	Tx (MHz)	Rx (MHz)
	NB-IOT Band 4	1710 ~1755	2110~2155



	NB-IOT Band 12	699 ~ 716	729 ~ 746
	NB-IOT Band 13	777 ~ 787	746 ~ 756
Note: 1. The EUT is sent from the applicant to TA and the information of the EUT is declared by the applicant.			

### 3 Applied Standards

According to the specifications of the manufacturer, it must comply with the requirements of the following standards:

**Test standards:**

**FCC CFR47 Part 27C(2019)**

**ANSI C63.26 (2015)**

**Reference standard:**

**FCC CFR47 Part 2 (2019)**

**KDB 971168 D01 Power Meas License Digital Systems v03r01**



## 4 Test Configuration

Radiated measurements are performed by rotating the EUT in three different orthogonal test planes. EUT lie-down stand-up position (X, Y axis), lie-down position (Z axis),. Receiver antenna polarization (horizontal and vertical), the worst emission was found in position (Z axis, vertical polarization) and the worst case was recorded.

All mode and data rates and positions and RB size and modulations were investigated.

Subsequently, only the worst case emissions are reported.

The following testing in NB-IOT is set based on the maximum RF Output Power.

The following testing in different Bandwidth is set to detail in the following table:

Test modes are chosen to be reported as the worst case configuration below for NB-IOT Band 4/12/13:

Test items	Mode	Deployment mode	Subcarrier Spacing (kHz)		Modulation		Test Channel		
		Stand-alone	3.75	15	BPSK	QPSK	L	M	H
RF Power Output and Effective Isotropic Radiated Power	NB-IOT B4	O	O	O	O	O	O	O	O
	NB-IOT B12	O	O	O	O	O	O	O	O
	NB-IOT B13	O	O	O	O	O	O	O	O
Occupied Bandwidth	NB-IOT B4	O	O	O	O	O	O	O	O
	NB-IOT B12	O	O	O	O	O	O	O	O
	NB-IOT B13	O	O	O	O	O	O	O	O
Band Edge Compliance	NB-IOT B4	O	O	O	O	O	O	-	O
	NB-IOT B12	O	O	O	O	O	O	-	O
	NB-IOT B13	O	O	O	O	O	O	-	O
Peak-to-Average Power Ratio	NB-IOT B4	O	O	O	O	O	-	O	-
	NB-IOT B12	O	O	O	O	O	-	O	-
	NB-IOT B13	O	O	O	O	O	-	O	-
Frequency Stability	NB-IOT B4	O	O	O	O	O	O	O	O
	NB-IOT B12	O	O	O	O	O	O	O	O
	NB-IOT B13	O	O	O	O	O	O	O	O
Conducted Spurious Emissions	NB-IOT B4	O	-	O	-	O	O	O	O
	NB-IOT B12	O	-	O	-	O	O	O	O
	NB-IOT B13	O	-	O	-	O	O	O	O
Radiates Spurious Emission	NB-IOT B4	O	-	O	-	O	O	O	O
	NB-IOT B12	O	-	O	-	O	O	O	O
	NB-IOT B13	O	-	O	-	O	O	O	O
<b>Note</b> 1. The mark "O" means that this configuration is chosen for testing. 2. The mark "-" means that this configuration is not testing.									

## 5 Test Case Results

### 5.1 RF Power Output and Effective Isotropic Radiated Power

#### Ambient condition

Temperature	Relative humidity	Pressure
23°C ~25°C	45%~50%	101.5kPa

#### Methods of Measurement

During the process of the testing, The EUT is controlled by the Base Station Simulator to ensure max power transmission and proper modulation.

1. The testing follows FCC KDB 971168 D01 v03r01 Section 5.8 and ANSI C63.26 (2015).

a) Connect the equipment as illustrated. Mount the equipment with the manufacturer specified antenna in a vertical orientation on a manufacturer specified mounting surface located on a non-conducting rotating platform of a RF anechoic chamber (preferred) or a standard radiation site.

b) Key the transmitter, then rotate the EUT 360° azimuthally and record spectrum analyzer power level (LVL) measurements at angular increments that are sufficiently small to permit resolution of all peaks. If a standard radiation test site is used, raise and lower the test antenna to obtain a maximum reading at each angular increment. (Note: several batteries may be needed to offset the effect of battery voltage droop, which should not exceed 5% of the manufactured specified battery voltage during transmission).

c) Replace the transmitter under test with a vertically polarized half-wavedipole (or an antenna whose gain is known relative to an ideal half-wavedipole). The center of the antenna should be at the same location as the center of the antenna under test.

d) Connect the antenna to a signal generator with a known output power and record the path loss (in dB) as LOSS. If a standard radiation test site is used, raise and lower the test antenna to obtain a maximum reading.  $LOSS = \text{Generator Output Power (dBm)} - \text{Analyzer reading (dBm)}$

e) Determine the effective radiated output power at each angular position from the readings in steps b) and d) using the following equation:  $ERP \text{ (dBm)} = \text{LVL (dBm)} + \text{LOSS (dB)}$

f) The maximum ERP is the maximum value determined in the preceding step.

g) When calculating ERP, in addition to knowing the antenna radiation and matching characteristics, it is necessary to know the loss values of all elements (e.g. transmission line attenuation, mismatches, filters, combiners) interposed between the point where transmitter output power is measured, and the point where power is applied to the antenna. ERP can then be calculated as follows:

$$EIRP \text{ (dBm)} = \text{Output Power (dBm)} - \text{Losses (dB)} + \text{Antenna Gain (dBi)}$$

where: dBd refers to gain relative to an ideal dipole.

$$EIRP \text{ (dBm)} = ERP \text{ (dBm)} + 2.15 \text{ (dB.)}$$

The RB allocation refers to section 5.1, using the maximum output power configuration.

**Test Setup**

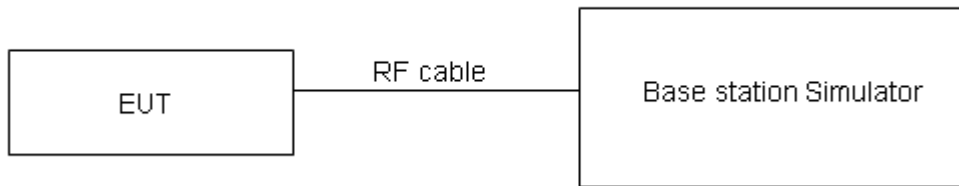

The loss between RF output port of the EUT and the input port of the tester has been taken into consideration.

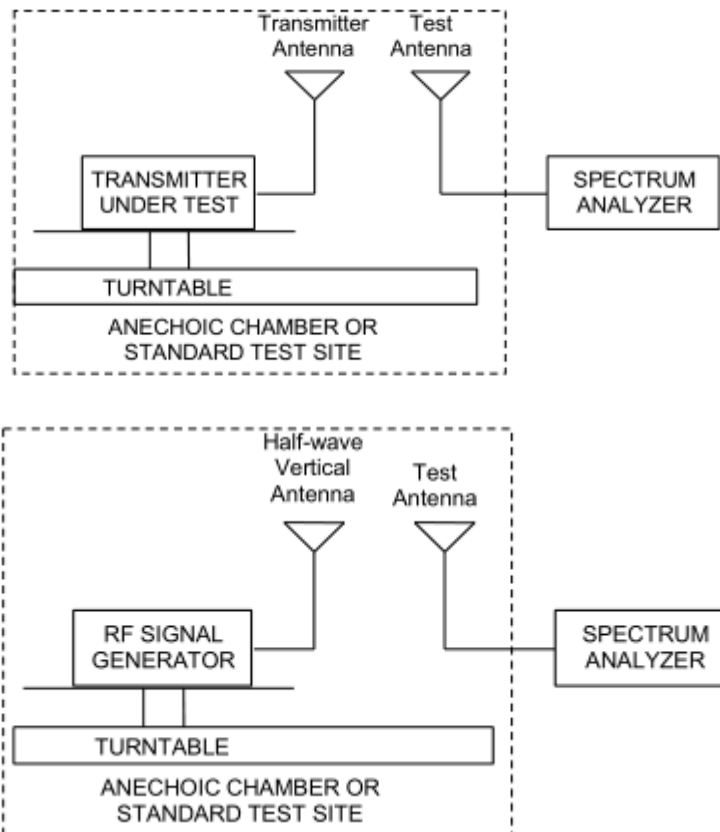

Note: Area side:2.4mX3.6m

The radiated emission was measured in the following position: EUT stand-up position (Z axis), lie-down position (X, Y axis). The worst emission was found in stand-up position (Z axis) and the worst case was recorded.

**Limits**

No specific RF power output requirements in part 2.1046.

Rule Part 27.50(b) (10) specifies that “Portable stations (hand-held devices) transmitting in the 746-757 MHz, 776-788 MHz, and 805-806 MHz bands are limited to 3 watts ERP”

Rule Part 27.50(c) (10) specifies that “Portable stations (hand-held devices) in the 600 MHz uplink band and the 698-746 MHz band, and fixed and mobile stations in the 600 MHz uplink band are limited to 3 watts ERP”



Rule Part 27.50(d) (4) specifies that “Fixed, mobile and portable (hand-held) stations operating in the 1710–1755 MHz band are limited to 1 watt EIRP”

Part 27.50(b)(10)Limit	$\leq 3 \text{ W}$ (34.77 dBm)
Part 27.50(c)(10)Limit	$\leq 3 \text{ W}$ (34.77 dBm)
Part 27.50(d)(4)Limit	$\leq 1 \text{ W}$ (30 dBm)

### Measurement Uncertainty

The assessed measurement uncertainty to ensure 95% confidence level for the normal distribution is with the coverage factor  $k = 2$ ,  $U=0.4$  dB for RF power output,  $k = 2$ ,  $U= 1.19$  dB for ERP/EIRP.

**Test Results**
**Variant**

Mode	Modulation	Sub-carrier spacing(kHz)	Ntones	Conducted Power (dBm) for low/mid/high channel			EIRP(dBm)		
				19952/1	20175/17	20398/1	19952/1	20175/1	20398/1
				710.2 MHz	32.5 MHz	754.8 MHz	710.2 MHz	732.5 MHz	754.8 MHz
NB-IOT Band 4 Standalone	BPSK	3.75	1@0	23.04	23.28	23.04	25.04	25.28	24.61
			1@47	23.00	23.24	23.07	25.00	25.24	24.64
		15	1@0	23.11	23.33	23.24	25.11	25.33	24.81
			1@11	23.07	23.35	23.19	25.07	25.35	24.76
	QPSK	3.75	1@0	22.99	23.21	23.09	24.99	25.21	24.66
			1@47	23.03	23.19	23.11	25.03	25.19	24.68
		15	1@0	23.07	23.35	23.18	25.07	25.35	24.75
			1@11	23.21	23.32	23.26	25.21	25.32	24.83
		15	12@0	23.36	23.45	23.46	25.36	25.45	25.03

Mode	Modulation	Sub-carrier spacing (kHz)	Ntones	Conducted Power (dBm) for low/mid/high channel			ERP(dBm)		
				23012/	23095/	23178/	23012/	23095/	23178
				699.2 MHz	707.5 MHz	715.8 MHz	699.2 MHz	707.5 MHz	715.8 MHz
NB-IOT Band 12 Standalone	BPSK	3.75	1@0	23.16	23.14	23.08	22.67	24.25	24.88
			1@47	23.12	23.08	23.07	22.63	24.19	24.87
		15	1@0	23.37	23.23	23.19	22.88	24.34	24.99
			1@11	23.34	23.20	23.28	22.85	24.31	25.08
	QPSK	3.75	1@0	23.21	23.05	23.06	22.72	24.16	24.86
			1@47	23.19	23.01	23.05	22.70	24.12	24.85
		15	1@0	23.36	23.25	23.21	22.87	24.36	25.01
			1@11	23.34	23.27	23.27	22.85	24.38	25.07
		15	12@0	23.56	23.45	23.44	23.07	24.56	25.24

Mode	Modulation	Sub-carrier spacing (kHz)	Ntones	Conducted Power (dBm) for low/mid/high channel			ERP(dBm)		
				23182/777.2 MHz	23230/782 MHz	23278/786.8 MHz	23182/777.2 MHz	23230/782 MHz	23278/786.8 MHz
				NB-IOT Band 13 Standalone	BPSK	3.75	1@0	22.81	22.83
1@47	22.67	22.79	22.83				24.97	25.09	24.31
15	1@0	23.07	23.12			23.11	25.37	25.42	24.59
	1@11	23.04	23.11			23.09	25.34	25.41	24.57
QPSK	3.75	1@0	22.78		22.80	22.84	25.08	25.10	24.32
		1@47	22.79		22.78	22.80	25.09	25.08	24.28
	15	1@0	23.06		23.08	23.08	25.36	25.38	24.56
		1@11	23.09		23.07	23.11	25.39	25.37	24.59
	15	12@0	23.13		23.12	23.13	25.43	25.42	24.61

## 5.2 Occupied Bandwidth

### Ambient condition

Temperature	Relative humidity	Pressure
23°C ~25°C	45%~50%	101.5kPa

### Method of Measurement

The EUT was connected to Spectrum Analyzer and Base Station Simulator via power Splitter. The occupied bandwidth is measured using spectrum analyzer.

RBW is set to 2kHz, VBW is set to 6.2kHz for NB-IOT Band 4/12/13.

99% power and -26dBc occupied bandwidths are recorded. Spectrum analyzer plots are included on the following pages.

### Test Setup

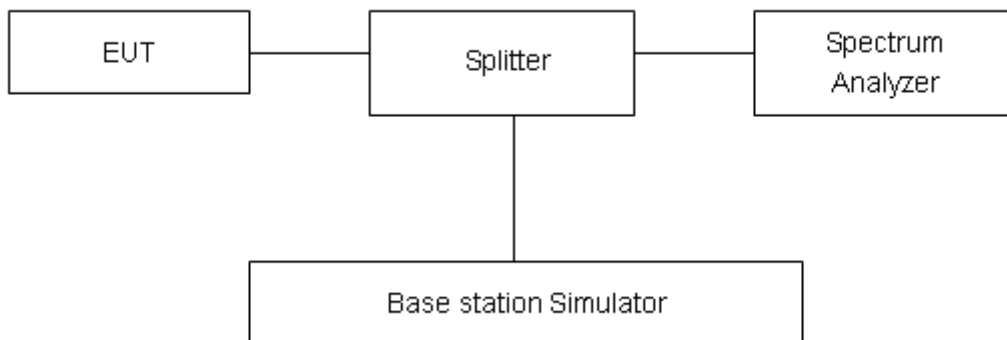

### Limits

No specific occupied bandwidth requirements in part 2.1049.

### Measurement Uncertainty

The assessed measurement uncertainty to ensure 95% confidence level for the normal distribution is with the coverage factor  $k = 2$ ,  $U=624\text{Hz}$ .

**Test Result**
**Variant**

Mode	Modulation	Sub-carrier spacing (KHz)	Ntones	Bandwidth(KHz) for low/mid/high channel					
				19952/1710.2 MHz		20175/1732.5 MHz		20398/1754.8 MHz	
				99% Power	-26dBc	99% Power	-26dBc	99% Power	-26dBc
NB-IOT Band 4 Standalone	BPSK	3.75	1@0	66.18	37.51	71.49	38.06	72.87	38.10
	QPSK	3.75	1@0	76.06	38.89	80.24	41.64	82.37	41.40
	BPSK	15	1@0	146.79	104.00	145.60	112.50	145.62	104.60
	QPSK	15	1@0	135.01	116.90	138.48	104.20	145.29	198.40
	QPSK	15	12@0	184.40	237.80	185.01	238.50	187.18	250.90
Mode	Modulation	Sub-carrier spacing (KHz)	Ntones	Bandwidth(KHz) for low/mid/high channel					
				23012/699.2 MHz		23095/707.5 MHz		23178/715.8 MHz	
				99% Power	-26dBc	99% Power	-26dBc	99% Power	-26dBc
NB-IOT Band 12 Standalone	BPSK	3.75	1@0	55.95	39.59	51.40	37.98	47.68	37.88
	QPSK	3.75	1@0	56.51	38.90	56.19	41.68	57.93	39.80
	BPSK	15	1@0	121.28	101.60	107.45	99.28	132.71	118.20
	QPSK	15	1@0	120.02	116.50	115.03	103.40	119.79	116.70
	QPSK	15	12@0	188.51	266.00	183.71	252.00	183.88	238.20
Mode	Modulation	Sub-carrier spacing (KHz)	Ntones	Bandwidth(KHz) for low/mid/high channel					
				23182/777.2MHz		23230/782MHz		23278/786.8MHz	
				99% Power	-26dBc	99% Power	-26dBc	99% Power	-26dBc
NB-IOT Band 13 Standalone	BPSK	3.75	1@0	50.05	37.54	49.15	37.50	51.47	38.09
	QPSK	3.75	1@0	60.44	39.47	58.31	41.05	59.39	41.00
	BPSK	15	1@0	131.10	104.20	133.21	118.60	132.05	118.50
	QPSK	15	1@0	117.73	115.70	120.22	104.10	120.71	116.50
	QPSK	15	12@0	183.50	235.80	185.09	240.00	184.26	240.30



NB-IOT Band 4 BPSK3.75KHz 1@0CH-Low



NB-IOT Band 4 BPSK15KHz 1@0CH-Low



NB-IOT Band 4 BPSK3.75KHz 1@0CH-Middle



NB-IOT Band 4 BPSK15KHz 1@0CH-Middle



NB-IOT Band 4 BPSK3.75KHz 1@0CH-High



NB-IOT Band 4 BPSK15KHz 1@0CH-High



NB-IOT Band 4 QPSK 3.75KHz 1@0CH-Low



NB-IOT Band 4 QPSK 15KHz 1@0CH-Low



NB-IOT Band 4 QPSK 3.75KHz 1@0CH-Middle



NB-IOT Band 4 QPSK 15KHz 1@0CH-Middle



NB-IOT Band 4 QPSK 3.75KHz 1@0CH-High



NB-IOT Band 4 QPSK 15KHz 1@0CH-High



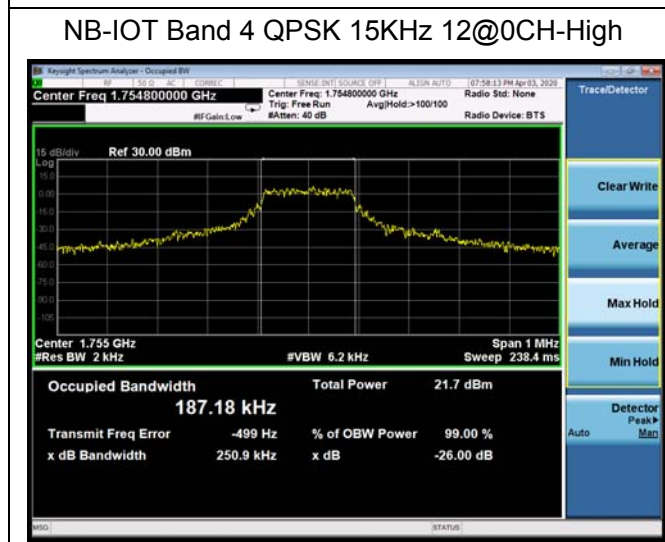
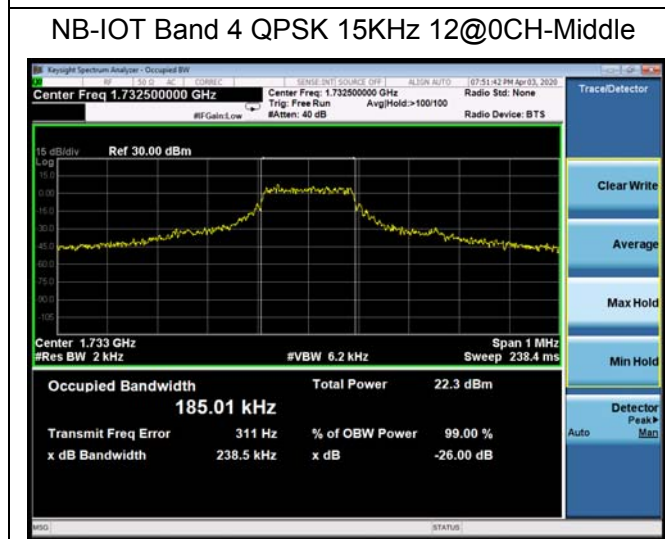
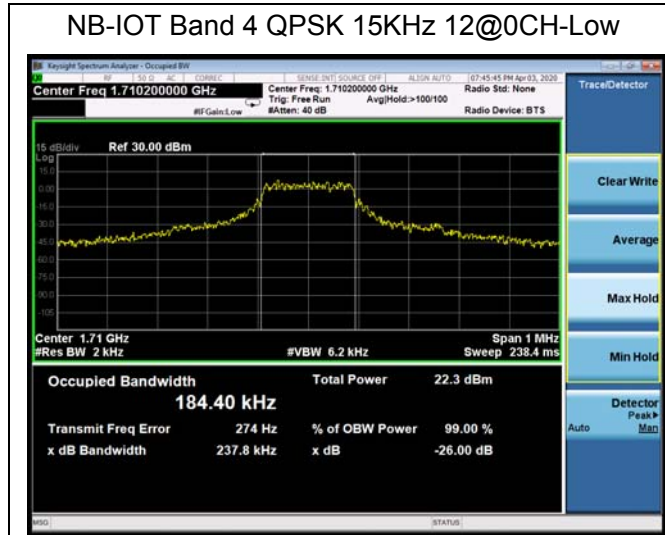



### NB-IOT Band 12 BPSK 3.75kHz 1@0CH-Low



### NB-IOT Band 12 BPSK 15kHz 1@0CH-Low



### NB-IOT Band 12 BPSK 3.75kHz 1@0CH-Middle



### NB-IOT Band 12 BPSK 15kHz 1@0CH-Middle



### NB-IOT Band 12 BPSK 3.75kHz 1@0CH-High



### NB-IOT Band 12 BPSK 15kHz 1@0CH-High







### NB-IOT Band 12 QPSK 3.75kHz 1@0CH-Low



### NB-IOT Band 12 QPSK 15kHz 1@0CH-Low



### NB-IOT Band 12 QPSK 3.75kHz 1@0CH-Middle



### NB-IOT Band 12 QPSK 15kHz 1@0CH-Middle

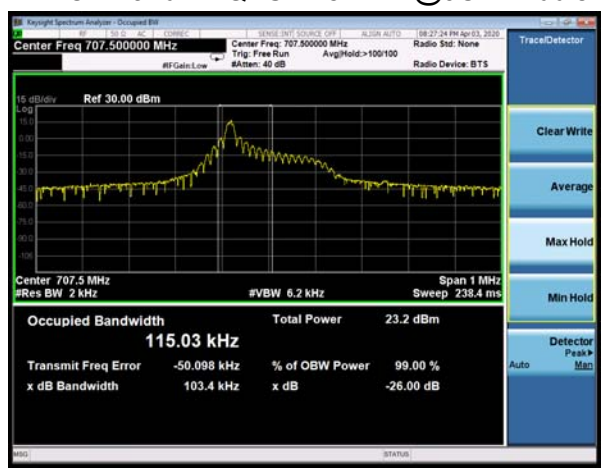

### NB-IOT Band 12 QPSK 3.75kHz 1@0CH-High

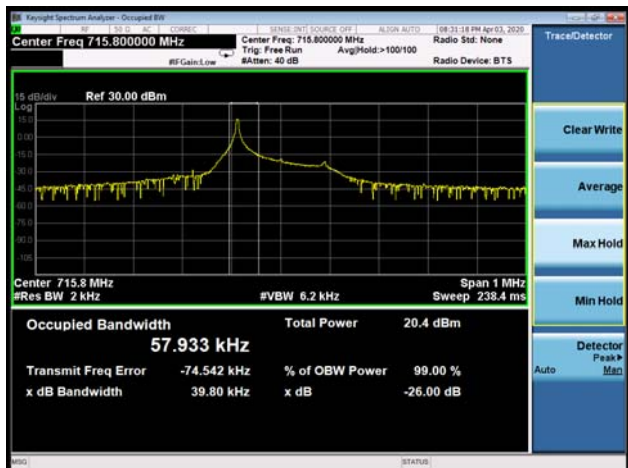

### NB-IOT Band 12 QPSK 15kHz 1@0CH-High





### NB-IOT Band 12 QPSK 15kHz 12@0CH-Low



### NB-IOT Band 13 BPSK 3.75kHz 1@0CH-Low

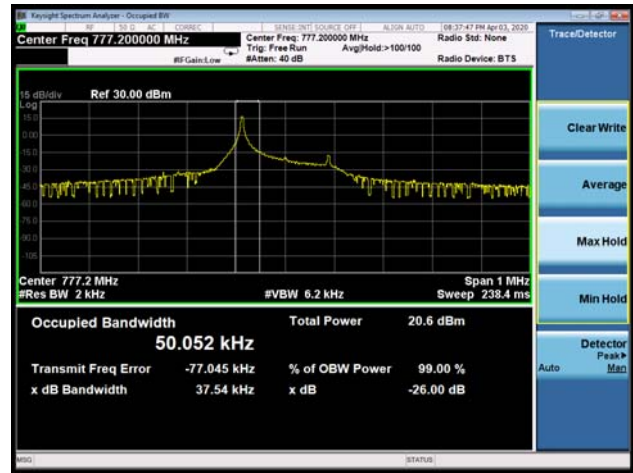

### NB-IOT Band 12 QPSK 15kHz 12@0CH-Middle



### NB-IOT Band 13 BPSK 3.75kHz 1@0CH-Middle



### NB-IOT Band 12 QPSK 15kHz 12@0CH-High



### NB-IOT Band 13 BPSK 3.75kHz 1@0CH-High



NB-IOT Band 13 BPSK 15kHz 1@0CH-Low



NB-IOT Band 13 QPSK 3.75kHz 1@0CH-Low

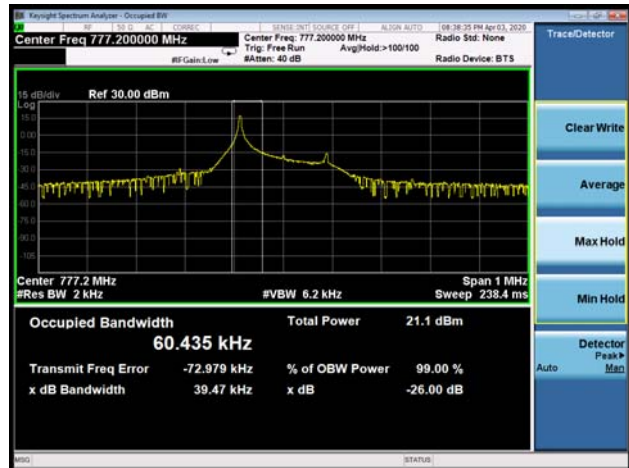

NB-IOT Band 13 BPSK 15kHz 1@0CH-Middle



NB-IOT Band 13 QPSK 3.75kHz 1@0CH-Middle

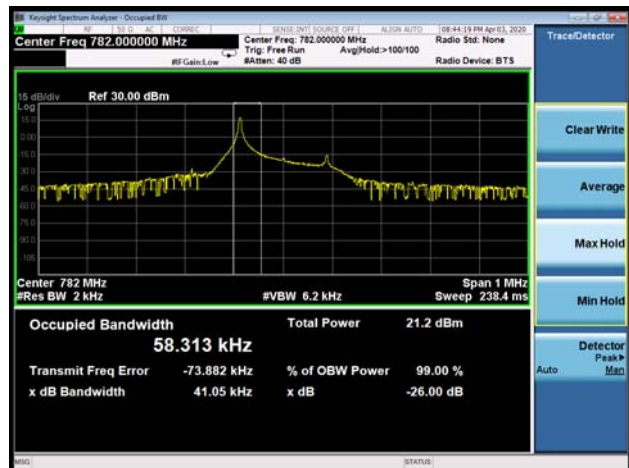

NB-IOT Band 13 BPSK 15kHz 1@0CH-High



NB-IOT Band 13 QPSK 3.75kHz 1@0CH-High

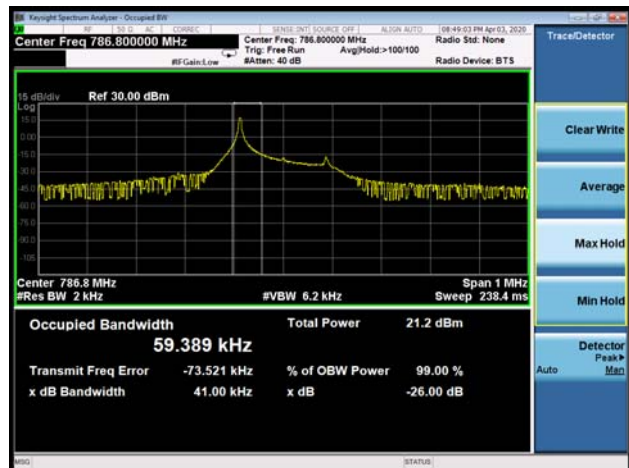



NB-IOT Band 13 QPSK 15kHz 1@0CH-Low



NB-IOT Band 13 QPSK 15kHz 12@0CH-Low



NB-IOT Band 13 QPSK 15kHz 1@0CH-Middle



NB-IOT Band 13 QPSK 15kHz 12@0CH-Middle



NB-IOT Band 13 QPSK 15kHz 1@0CH-High



NB-IOT Band 13 QPSK 15kHz 12@0CH-High





### 5.3 Band Edge Compliance

#### Ambient condition

Temperature	Relative humidity	Pressure
23°C ~25°C	45%~50%	101.5kPa

#### Method of Measurement

The EUT was connected to Spectrum Analyzer and Base Station Simulator via power Splitter. The band edge of the lowest and highest channels were measured.

The testing follows KDB 971168 D01v03r01 Section 6.0

The EUT was connected to spectrum analyzer and system simulator via a power divider.

The band edges of low and high channels for the highest RF powers were measured.

RBW is set to  $\geq 1\%EBW$ , VBW is set to 3x RBW.

Set spectrum analyzer with RMS detector.

The RF fundamental frequency should be excluded against the limit line in the operating frequency band.

Checked that all the results comply with the emission limit line.

#### Test Setup

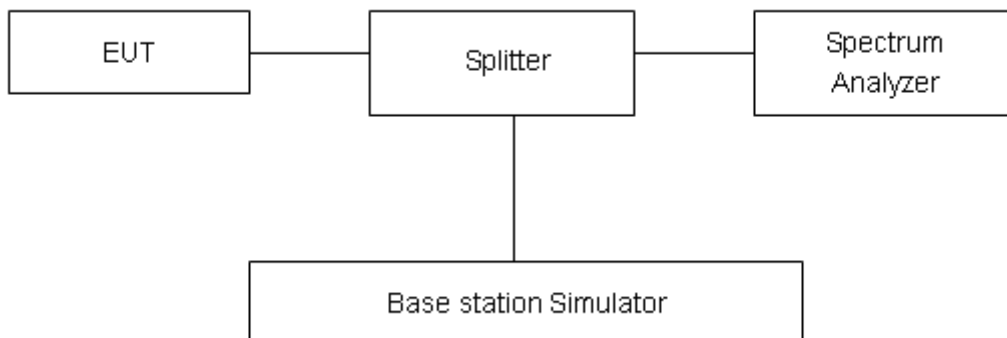

## Limits

Rule Part 27.53(h) specifies that “ for operations in the 1695-1710 MHz, 1710-1755 MHz, 1755-1780 MHz, 1915-1920 MHz, 1995-2000 MHz, 2000-2020 MHz, 2110-2155 MHz, 2155-2180 MHz, and 2180-2200 bands, the power of any emission outside a licensee's frequency block shall be attenuated below the transmitter power (P) in watts by at least  $43 + 10 \log_{10} (P)$  dB”

Rule Part 27.53(g) For operations in the 600 MHz band and the 698-746 MHz band, the power of any emission outside a licensee's frequency band(s) of operation shall be attenuated below the transmitter power (P) within the licensed band(s) of operation, measured in watts, by at least  $43 + 10 \log (P)$  dB. Compliance with this provision is based on the use of measurement instrumentation employing a resolution bandwidth of 100 kilohertz or greater. However, in the 100 kilohertz bands immediately outside and adjacent to a licensee's frequency block, a resolution bandwidth of at least 30 kHz may be employed.

Rule Part 27.53(f) For operations in the 746-758 MHz, 775-788 MHz, and 805-806 MHz bands, emissions in the band 1559-1610 MHz shall be limited to  $-70$  dBW/MHz equivalent isotropically radiated power (EIRP) for wideband signals, and  $-80$  dBW EIRP for discrete emissions of less than 700 Hz bandwidth. For the purpose of equipment authorization, a transmitter shall be tested with an antenna that is representative of the type that will be used with the equipment in normal operation.

Rule Part 27.53 (c) For operations in the 746-758 MHz band and the 776-788 MHz band, the power of any emission outside the licensee's frequency band(s) of operation shall be attenuated below the transmitter power (P) within the licensed band(s) of operation, measured in watts, in accordance with the following:

- (1) On any frequency outside the 746-758 MHz band, the power of any emission shall be attenuated outside the band below the transmitter power (P) by at least  $43 + 10 \log (P)$  dB;
- (2) On any frequency outside the 776-788 MHz band, the power of any emission shall be attenuated outside the band below the transmitter power (P) by at least  $43 + 10 \log (P)$  dB;
- (3) On all frequencies between 763-775 MHz and 793-805 MHz, by a factor not less than  $76 + 10 \log (P)$  dB in a 6.25 kHz band segment, for base and fixed stations;
- (4) On all frequencies between 763-775 MHz and 793-805 MHz, by a factor not less than  $65 + 10 \log (P)$  dB in a 6.25 kHz band segment, for mobile and portable stations;
- (5) Compliance with the provisions of paragraphs (c)(1) and (c)(2) of this section is based on the use of measurement instrumentation employing a resolution bandwidth of 100 kHz or greater. However, in the 100 kHz bands immediately outside and adjacent to the frequency block, a resolution bandwidth of at least 30 kHz may be employed;

## Measurement Uncertainty

The assessed measurement uncertainty to ensure 95% confidence level for the normal distribution is with the coverage factor  $k = 1.96$ ,  $U = 0.684$  dB.

Test Result  
Variant

NB-IOT Band 4 BPSK 3.75kHz 1@0CH-Low

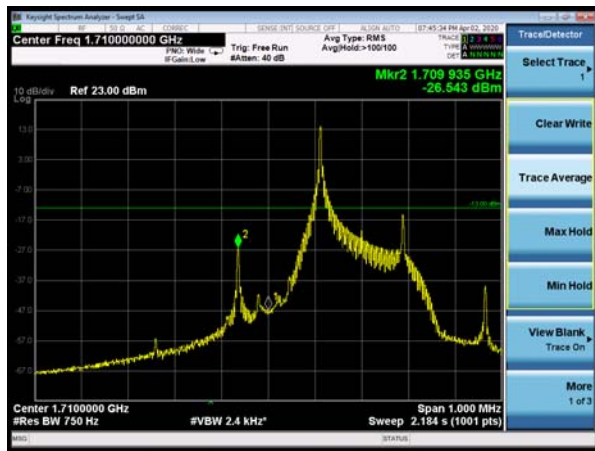

NB-IOT Band 4 BPSK 3.75kHz 1@47CH-High

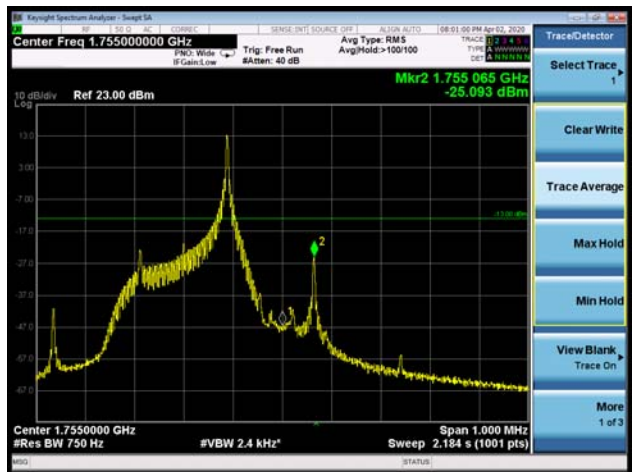

NB-IOT Band 4 BPSK 15kHz 1@0CH-Low

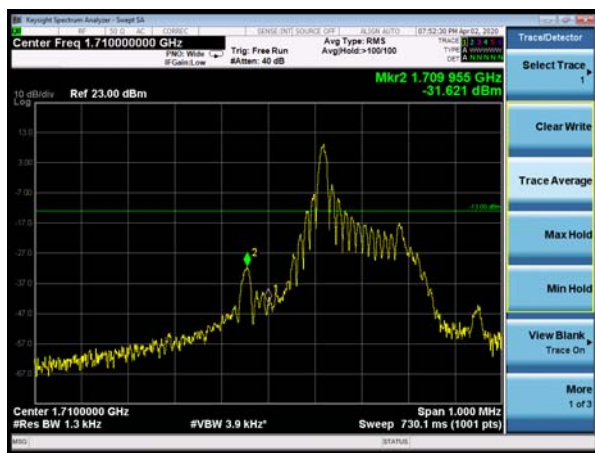

NB-IOT Band 4 BPSK 15kHz 1@11CH-High



NB-IOT Band 4 QPSK 3.75kHz 1@0CH-Low

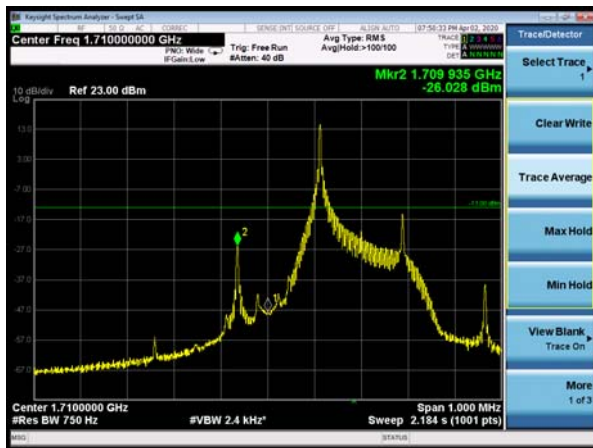

NB-IOT Band 4 QPSK 3.75kHz 1@47CH-High

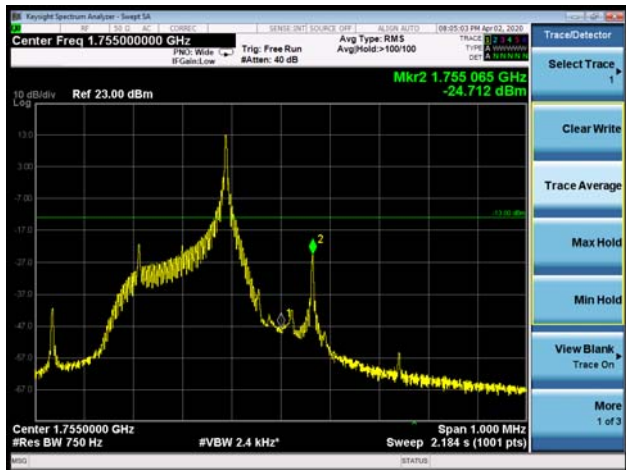

NB-IOT Band 4 QPSK 15kHz 1@0CH-Low

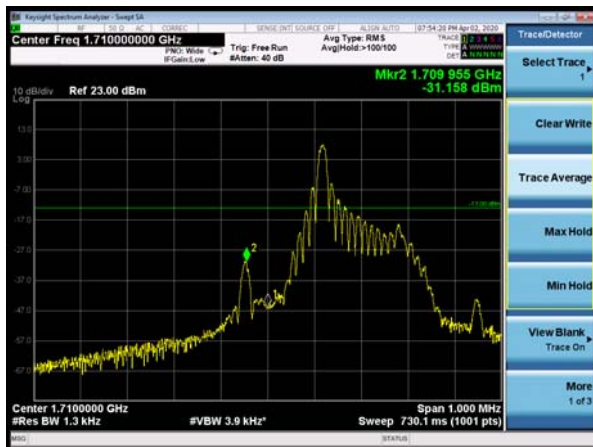

NB-IOT Band 4 QPSK 15kHz 1@11CH-High

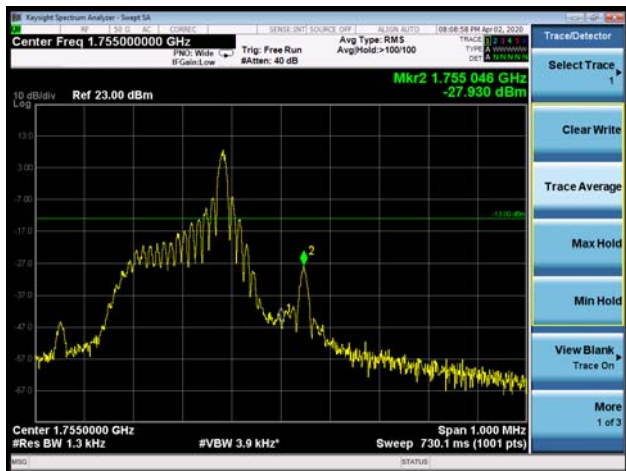

NB-IOT Band 4 QPSK 15kHz 12@0 CH-Low



NB-IOT Band 4 QPSK 15kHz 12@0CH-High



NB-IOT Band 12 BPSK 3.75kHz 1@0CH-Low



NB-IOT Band 12 BPSK 3.75kHz 1@47CH-High



NB-IOT Band 12 BPSK 15kHz 1@0CH-Low



NB-IOT Band 12 BPSK 15kHz 1@11CH-High





NB-IOT Band 12 QPSK 3.75kHz 1@0CH-Low



NB-IOT Band 12 QPSK 3.75kHz 1@47CH-High



NB-IOT Band 12 QPSK 15kHz 1@0CH-Low



NB-IOT Band 12 QPSK 15kHz 1@11CH-High



NB-IOT Band 12 QPSK 15kHz 12@0CH-Low



NB-IOT Band 12 QPSK 15kHz 12@0CH-High



NB-IOT Band 13 BPSK 3.75kHz 1@0CH-Low



NB-IOT Band 13 BPSK 3.75kHz 1@47CH-High



NB-IOT Band 13 BPSK 15kHz 1@0CH-Low



NB-IOT Band 13 BPSK 15kHz 1@11CH-High



NB-IOT Band 13 QPSK 3.75kHz 1@0CH-Low



NB-IOT Band 13 QPSK 3.75kHz 1@47CH-High



NB-IOT Band 13 QPSK 15kHz 1@0CH-Low



NB-IOT Band 13 QPSK 15kHz 1@11CH-High

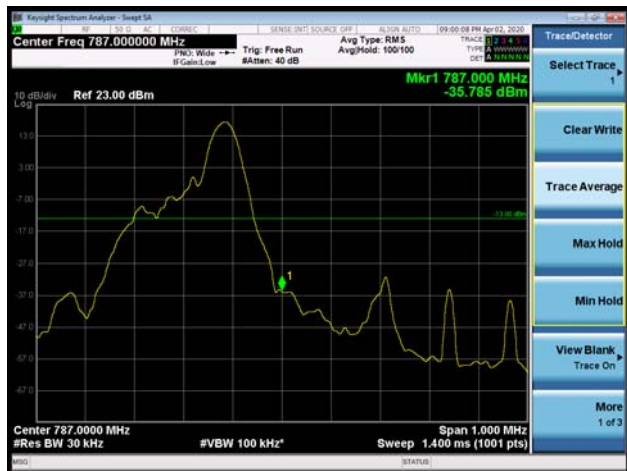

NB-IOT Band 13 QPSK 15kHz 12@0 CH-Low



NB-IOT Band 13 QPSK 15kHz 12@0CH-High







NB-IOT Band 13 BPSK 3.75kHz  
1@0763MHz-775MHz

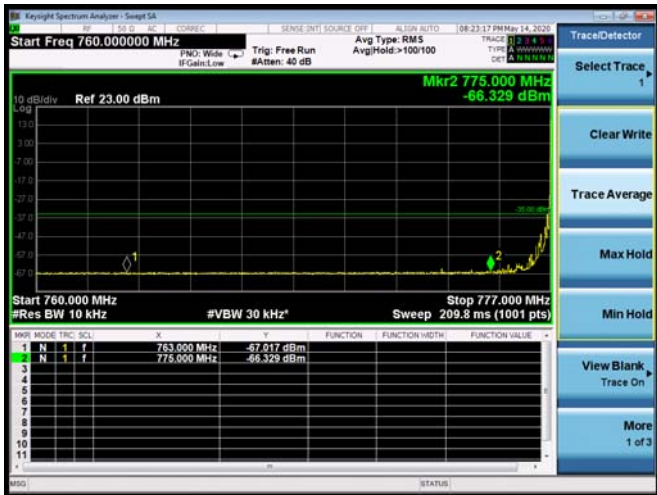

NB-IOT Band 13 BPSK 3.75kHz 1@47  
793MHz -805MHz

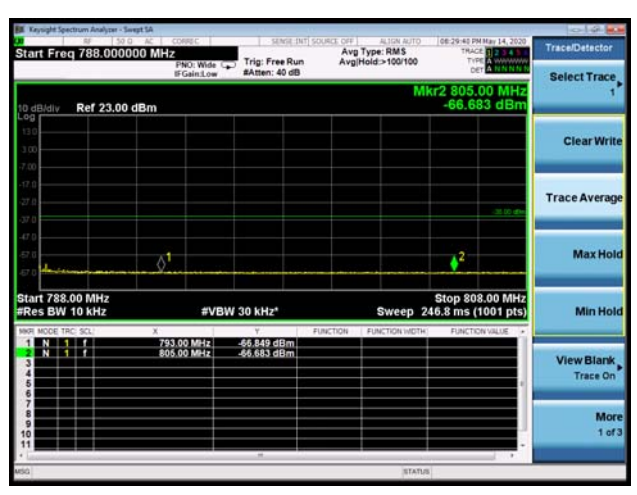

NB-IOT Band 13 BPSK 15kHz  
1@0763MHz-775MHz



NB-IOT Band 13 BPSK 15kHz 1@11  
793MHz -805MHz

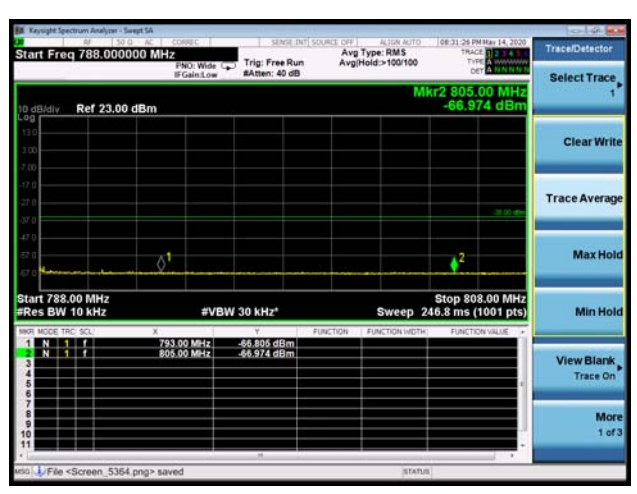

NB-IOT Band 13 QPSK 3.75kHz  
1@0763MHz-775MHz

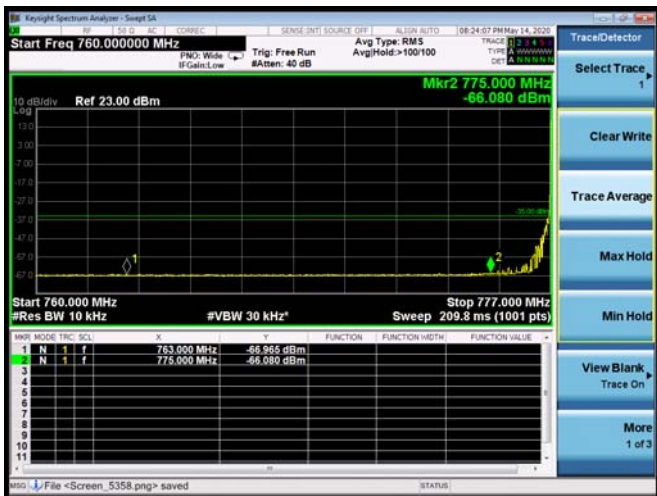

NB-IOT Band 13 QPSK 3.75kHz 1@47  
793MHz -805MHz

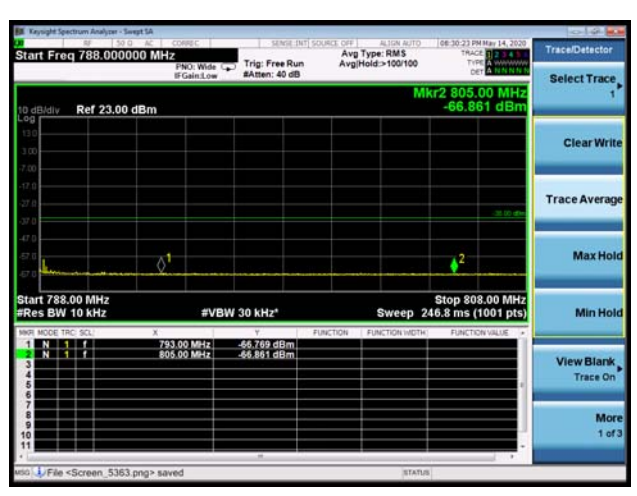

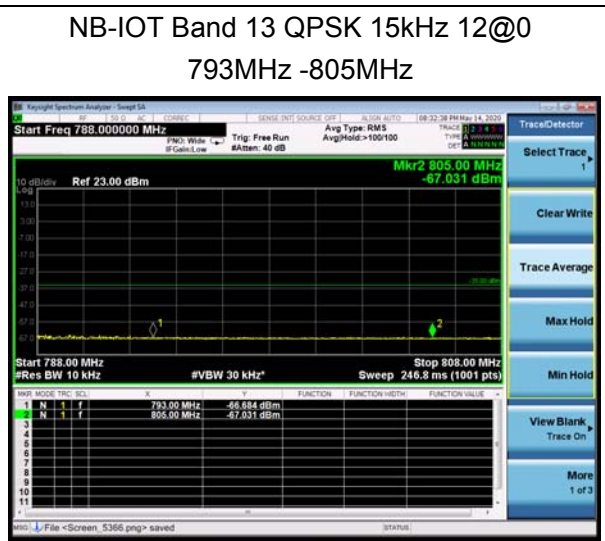
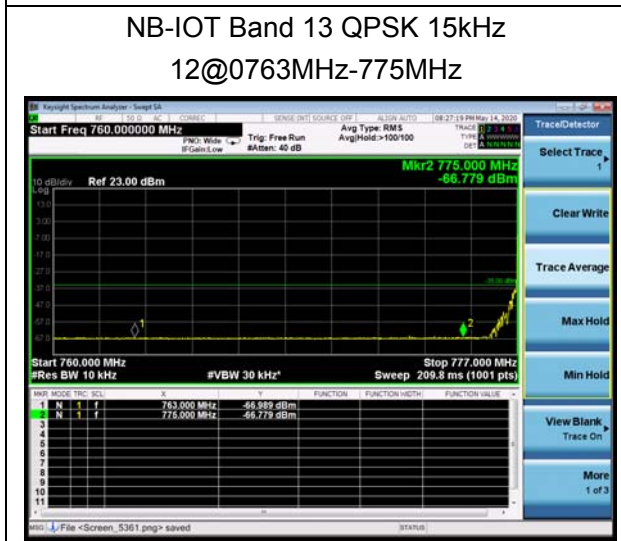
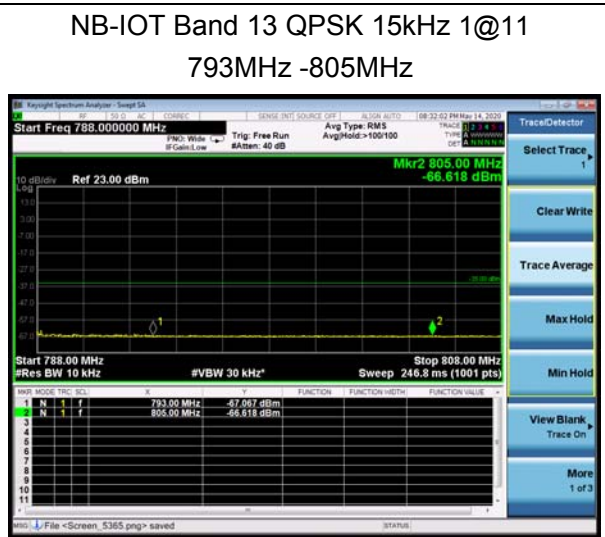
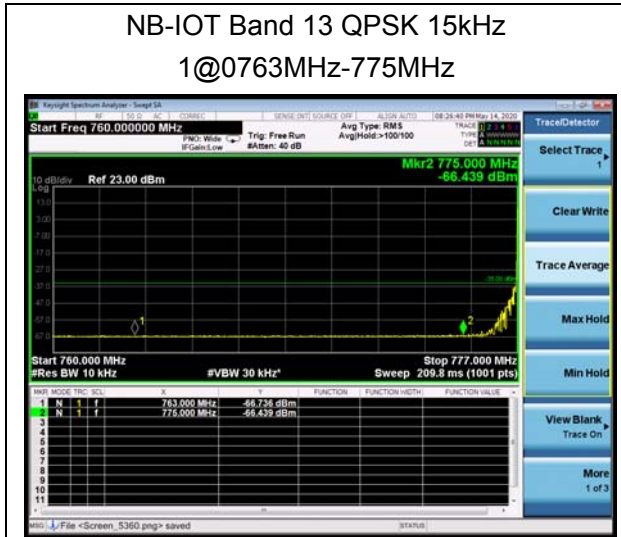

### 5.4 Peak-to-Average Power Ratio (PAPR)

#### Ambient condition

Temperature	Relative humidity	Pressure
23°C ~25°C	45%~50%	101.5kPa

#### Methods of Measurement

Measure the total peak power and record as PPK. And measure the total average power and record as PAvg. Both the peak and average power levels must be expressed in the same logarithmic units (e.g., dBm). Determine the PAPR from:

$$PAPR (dB) = PPK (dBm) - PAvg (dBm).$$

#### Test Setup

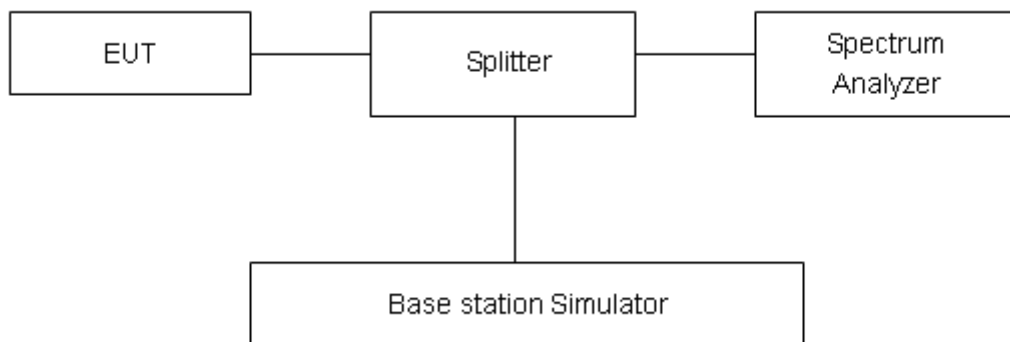

#### Limits

Rule Part 27.50(d)(5) Equipment employed must be authorized in accordance with the provisions of 24.51. Power measurements for transmissions by stations authorized under this section may be made either in accordance with a Commission-approved average power technique or in compliance with paragraph (d)(6) of this section. In measuring transmissions in this band using an average power technique, the peak-to-average ratio (PAR) of the transmission may not exceed 13 dB.

#### Measurement Uncertainty

The assessed measurement uncertainty to ensure 95% confidence level for the normal distribution is with the coverage factor k = 2, U= 0.4 dB.

**Test Results**
**Variant**

NB-IOT Band 4 Standalone							
Modulation	Sub-carrier spacing (KHz)	Channel/ Frequency (MHz)	Peak-to-Average Power Ratio (PAPR)			Limit (dB)	Conclusion
			Peak (dBm)	Avg (dBm)	PAPR (dB)		
BPSK	3.75	20175/1732.5	25.34	20.44	4.90	≤13	PASS
QPSK	3.75	20175/1732.5	24.67	20.48	4.19	≤13	PASS
BPSK	15	20175/1732.5	25.10	17.65	7.45	≤13	PASS
QPSK	15	20175/1732.5	24.63	17.64	6.99	≤13	PASS

**Original**

NB-IOT Band 12 Standalone							
Modulation	Sub-carrier spacing (kHz)	Channel/ Frequency(M Hz)	Peak (dBm)	Avg (dBm)	PAPR (dB)	Limit (dB)	Conclusion
BPSK	3.75	23095/707.5	26.39	22.85	3.54	≤13	PASS
QPSK	3.75	23095/707.5	29.56	22.92	6.64	≤13	PASS
BPSK	15	23095/707.5	26.48	22.89	3.59	≤13	PASS
QPSK	15	23095/707.5	29.99	23.33	6.66	≤13	PASS

NB-IOT Band 13 Standalone							
Modulation	Sub-carrier spacing (kHz)	Channel/ Frequency(M Hz)	Peak (dBm)	Avg (dBm)	PAPR (dB)	Limit (dB)	Conclusion
BPSK	3.75	23230/782	25.83	22.53	3.30	≤13	PASS
QPSK	3.75	23230/782	28.76	22.69	6.07	≤13	PASS
BPSK	15	23230/782	25.72	22.51	3.21	≤13	PASS
QPSK	15	23230/782	28.84	22.69	6.15	≤13	PASS

## 5.5 Frequency Stability

### Ambient condition

Temperature	Relative humidity	Pressure
23°C ~25°C	45%~50%	101.5kPa

### Method of Measurement

#### 1. Frequency Stability (Temperature Variation)

The temperature inside the climate chamber is varied from -40°C to +85°C in 10°C step size.

(1)With all power removed, the temperature was decreased to -10°C and permitted to stabilize for three hours.

(2)Measure the carrier frequency with the test equipment in a “call mode”. These measurements should be made within 1 minute of powering up the mobile station, to prevent significant self warming.

(3) Repeat the above measurements at 10°C increments from -40°C to +85°C. Allow at least 1.5 hours at each temperature, un-powered, before making measurements.

#### 2. Frequency Stability (Voltage Variation)

The frequency stability shall be measured with variation of primary supply voltage as follows:

(1) Vary primary supply voltage from 85 to 115 percent of the nominal value for other than hand carried battery equipment.

(2) For hand carried, battery powered equipment, reduce primary supply voltage to the battery-operating end point which shall be specified by the manufacturer.

This transceiver is specified to operate with an input voltage of between 3.3 V and 4.3 V, with a nominal voltage of 3.8V.

### Test setup

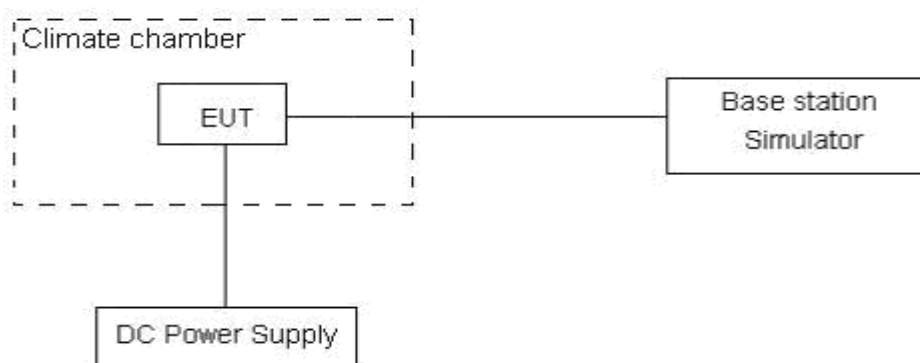

### Limits

No specific frequency stability requirements in part 27.54

### Measurement Uncertainty

The assessed measurement uncertainty to ensure 99.75% confidence level for the normal distribution is with the coverage factor  $k = 3, U=0.01\text{ppm}$ .



**Test Result**
**Variant**

NB-IOT Band 4						
Condition		Freq.Error (Hz)	Freq.Error (Hz)	Frequency Stability (ppm)	Frequency Stability (ppm)	Verdict
Sub-carrier spacing (kHz)	3.75					
Temperature	Voltage	BPSK	QPSK	BPSK	QPSK	
Normal (25°C)	Normal	9.85	4.14	0.00524	0.00220	PASS
Extreme (85°C)		5.98	12.76	0.00318	0.00679	PASS
Extreme (80°C)		13.11	5.74	0.00697	0.00305	PASS
Extreme (70°C)		15.96	16.79	0.00849	0.00893	PASS
Extreme (60°C)		4.01	4.03	0.00213	0.00214	PASS
Extreme (50°C)		7.40	12.34	0.00393	0.00656	PASS
Extreme (40°C)		5.46	1.83	0.00290	0.00097	PASS
Extreme (30°C)		5.20	3.69	0.00277	0.00196	PASS
Extreme (20°C)		9.79	14.75	0.00521	0.00784	PASS
Extreme (10°C)		15.20	2.92	0.00809	0.00156	PASS
Extreme (0°C)		17.53	1.80	0.00933	0.00096	PASS
Extreme (-10°C)		16.66	8.47	0.00886	0.00451	PASS
Extreme (-20°C)		6.14	15.59	0.00326	0.00829	PASS
Extreme (-30°C)		2.63	16.20	0.00140	0.00862	PASS
Extreme (-40°C)		12.81	14.41	0.00681	0.00766	PASS
25°C	LV	9.39	15.07	0.00499	0.00801	PASS
	HV	6.36	14.56	0.00339	0.00774	PASS
Condition		Freq.Error (Hz)	Freq.Error (Hz)	Frequency Stability (ppm)	Frequency Stability (ppm)	Verdict
Sub-carrier spacing (kHz)	15					
Temperature	Voltage	BPSK	QPSK	BPSK	QPSK	
Normal (25°C)	Normal	8.15	16.28	0.00434	0.00866	PASS
Extreme (85°C)		13.34	10.89	0.00710	0.00579	PASS
Extreme (80°C)		15.10	4.90	0.00803	0.00260	PASS
Extreme (70°C)		2.70	9.57	0.00144	0.00509	PASS
Extreme (60°C)		13.69	6.85	0.00728	0.00364	PASS
Extreme (50°C)		11.16	14.18	0.00594	0.00754	PASS
Extreme (40°C)		2.38	3.75	0.00126	0.00199	PASS
Extreme (30°C)		1.97	5.41	0.00105	0.00288	PASS
Extreme (20°C)		2.88	10.52	0.00153	0.00560	PASS
Extreme (10°C)		1.43	4.08	0.00076	0.00217	PASS
Extreme (0°C)		5.80	17.69	0.00308	0.00941	PASS
Extreme (-10°C)		1.01	11.76	0.00053	0.00626	PASS

Extreme (-20°C)		4.27	8.59	0.00227	0.00457	PASS
Extreme (-30°C)		8.59	8.11	0.00457	0.00431	PASS
Extreme (-40°C)		5.82	2.01	0.00309	0.00107	PASS
25°C	LV	12.39	2.99	0.00659	0.00159	PASS
	HV	17.13	3.29	0.00911	0.00175	PASS

NB-IOT Band 12						
Condition		Freq.Error (Hz)	Freq.Error (Hz)	Frequency Stability (ppm)	Frequency Stability (ppm)	Verdict
Sub-carrier spacing (kHz)	3.75					
Temperature	Voltage	BPSK	QPSK	BPSK	QPSK	
Normal (25°C)	Normal	2.17	3.87	0.00115	0.00206	PASS
Extreme (85°C)		9.10	7.24	0.00484	0.00385	PASS
Extreme (80°C)		5.45	7.95	0.00290	0.00423	PASS
Extreme (70°C)		1.36	7.32	0.00073	0.00389	PASS
Extreme (60°C)		10.13	9.88	0.00539	0.00526	PASS
Extreme (50°C)		16.74	8.38	0.00891	0.00446	PASS
Extreme (40°C)		7.49	14.04	0.00398	0.00747	PASS
Extreme (30°C)		5.51	2.01	0.00293	0.00107	PASS
Extreme (20°C)		1.03	16.82	0.00055	0.00895	PASS
Extreme (10°C)		7.33	11.24	0.00390	0.00598	PASS
Extreme (0°C)		11.83	7.01	0.00629	0.00373	PASS
Extreme (-10°C)		14.11	6.69	0.00751	0.00356	PASS
Extreme (-20°C)		4.31	1.44	0.00229	0.00076	PASS
Extreme (-30°C)		2.38	2.72	0.00127	0.00144	PASS
Extreme (-40°C)		12.97	9.77	0.00690	0.00520	PASS
25°C	LV	5.37	2.65	0.00286	0.00141	PASS
	HV	5.38	9.97	0.00286	0.00530	PASS
Condition		Freq.Error (Hz)	Freq.Error (Hz)	Frequency Stability (ppm)	Frequency Stability (ppm)	Verdict
Sub-carrier spacing (kHz)	15					
Temperature	Voltage	BPSK	QPSK	BPSK	QPSK	
Normal (25°C)	Normal	12.64	3.81	0.00672	0.00202	PASS
Extreme (85°C)		3.36	1.89	0.00179	0.00100	PASS
Extreme (80°C)		17.26	10.87	0.00918	0.00578	PASS
Extreme (70°C)		7.80	2.65	0.00415	0.00141	PASS
Extreme (60°C)		15.64	2.94	0.00832	0.00156	PASS
Extreme (50°C)		9.49	3.17	0.00505	0.00168	PASS
Extreme (40°C)		7.21	10.60	0.00383	0.00564	PASS
Extreme (30°C)		16.06	12.19	0.00855	0.00649	PASS



Extreme (20°C)		12.09	14.95	0.00643	0.00795	PASS
Extreme (10°C)		5.86	3.01	0.00312	0.00160	PASS
Extreme (0°C)		10.44	2.85	0.00555	0.00152	PASS
Extreme (-10°C)		17.83	9.13	0.00949	0.00486	PASS
Extreme (-20°C)		16.16	1.96	0.00860	0.00104	PASS
Extreme (-30°C)		13.75	5.36	0.00731	0.00285	PASS
Extreme (-40°C)		3.73	16.32	0.00198	0.00868	PASS
25°C	LV	9.09	10.19	0.00483	0.00542	PASS
	HV	17.18	8.18	0.00914	0.00435	PASS

NB-IOT Band 13						
Condition		Freq.Error (Hz)	Freq.Error (Hz)	Frequency Stability (ppm)	Frequency Stability (ppm)	Verdict
Sub-carrier spacing (kHz)	3.75					
Temperature	Voltage	BPSK	QPSK	BPSK	QPSK	
Normal (25°C)	Normal	15.55	5.99	0.00827	0.00319	PASS
Extreme (85°C)		7.80	7.99	0.00415	0.00425	PASS
Extreme (80°C)		8.53	17.96	0.00454	0.00955	PASS
Extreme (70°C)		2.71	12.08	0.00144	0.00642	PASS
Extreme (60°C)		12.82	1.63	0.00682	0.00087	PASS
Extreme (50°C)		17.12	16.07	0.00911	0.00855	PASS
Extreme (40°C)		14.56	6.26	0.00774	0.00333	PASS
Extreme (30°C)		13.99	17.05	0.00744	0.00907	PASS
Extreme (20°C)		1.13	7.74	0.00060	0.00412	PASS
Extreme (10°C)		15.69	9.54	0.00835	0.00507	PASS
Extreme (0°C)		13.83	4.20	0.00736	0.00223	PASS
Extreme (-10°C)		16.28	5.90	0.00866	0.00314	PASS
Extreme (-20°C)		5.26	15.04	0.00280	0.00800	PASS
Extreme (-30°C)		6.60	12.64	0.00351	0.00672	PASS
Extreme (-40°C)		17.40	1.25	0.00926	0.00066	PASS
25°C	LV	12.13	9.74	0.00645	0.00518	PASS
	HV	1.40	2.18	0.00074	0.00116	PASS
Condition		Freq.Error (Hz)	Freq.Error (Hz)	Frequency Stability (ppm)	Frequency Stability (ppm)	Verdict
Sub-carrier spacing (kHz)	15					
Temperature	Voltage	BPSK	QPSK	BPSK	QPSK	
Normal (25°C)	Normal	6.37	13.64	0.00339	0.00725	PASS
Extreme (85°C)		5.70	1.07	0.00303	0.00057	PASS
Extreme (80°C)		14.22	4.32	0.00757	0.00230	PASS
Extreme (70°C)		7.51	13.39	0.00399	0.00712	PASS





Extreme (60°C)		6.94	7.37	0.00369	0.00392	PASS
Extreme (50°C)		5.60	10.87	0.00298	0.00578	PASS
Extreme (40°C)		6.81	1.99	0.00362	0.00106	PASS
Extreme (30°C)		14.01	17.55	0.00745	0.00933	PASS
Extreme (20°C)		2.72	2.73	0.00145	0.00145	PASS
Extreme (10°C)		11.75	13.26	0.00625	0.00705	PASS
Extreme (0°C)		4.02	6.84	0.00214	0.00364	PASS
Extreme (-10°C)		10.02	17.24	0.00533	0.00917	PASS
Extreme (-20°C)		9.06	7.68	0.00482	0.00409	PASS
Extreme (-30°C)		2.65	5.49	0.00141	0.00292	PASS
Extreme (-40°C)		13.78	1.32	0.00733	0.00070	PASS
25°C	LV	11.58	6.43	0.00616	0.00342	PASS
	HV	2.54	3.90	0.00135	0.00207	PASS

## 5.6 Spurious Emissions at Antenna Terminals

### Ambient condition

Temperature	Relative humidity	Pressure
23°C ~25°C	45%~50%	101.5kPa

### Method of Measurement

The EUT was connected to Spectrum Analyzer and Base Station Simulator via power Splitter. The measurement is carried out using a spectrum analyzer. The spectrum analyzer scans from 30MHz to the 10th harmonic of the carrier. The peak detector is used.

RBW is set to 100kHz,VBW is set to 300kHz for 30MHz~1GHz

RBW is set to 1MHz,VBW is set to 3MHz for above1GHz,Sweep is set to ATUO.

Of those disturbances below (limit – 20 dB), the mark is not required for the EUT.

The modulation mode and RB allocation refer to section 5.1, using the maximum output power configuration.

### Test setup

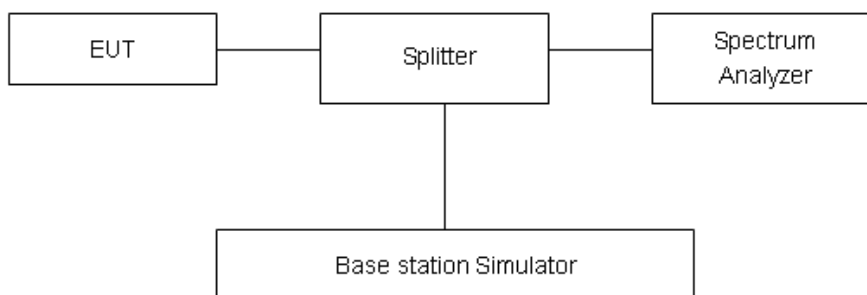

### Limits

Rule Part 27.53(h) specifies that “for operations in the 1695-1710 MHz, 1710-1755 MHz, 1755-1780 MHz, 1915-1920 MHz, 1995-2000 MHz, 2000-2020 MHz, 2110-2155 MHz, 2155-2180 MHz, and 2180-2200 bands, the power of any emission outside a licensee's frequency block shall be attenuated below the transmitter power (P) in watts by at least  $43 + 10 \log_{10} (P)$  dB..”

Rule Part 27.53 (g) For operations in the 600 MHz band and the 698-746 MHz band, the power of any emission outside a licensee's frequency band(s) of operation shall be attenuated below the transmitter power (P) within the licensed band(s) of operation, measured in watts, by at least  $43 + 10 \log (P)$  dB. Compliance with this provision is based on the use of measurement instrumentation employing a resolution bandwidth of 100 kilohertz or greater. However, in the 100 kilohertz bands immediately outside and adjacent to a licensee's frequency block, a resolution bandwidth of at least 30 kHz may be employed.

Rule Part 27.53(f) For operations in the 746-758 MHz, 775-788 MHz, and 805-806 MHz bands, emissions in the band 1559-1610 MHz shall be limited to  $-70$  dBW/MHz equivalent isotropically



radiated power (EIRP) for wideband signals, and  $-80$  dBW EIRP for discrete emissions of less than 700 Hz bandwidth. For the purpose of equipment authorization, a transmitter shall be tested with an antenna that is representative of the type that will be used with the equipment in normal operation.

Part 27.53 (c) For operations in the 746-758 MHz band and the 776-788 MHz band, the power of any emission outside the licensee's frequency band(s) of operation shall be attenuated below the transmitter power (P) within the licensed band(s) of operation, measured in watts, in accordance with the following:

- (1) On any frequency outside the 746-758 MHz band, the power of any emission shall be attenuated outside the band below the transmitter power (P) by at least  $43 + 10 \log (P)$  dB;
- (2) On any frequency outside the 776-788 MHz band, the power of any emission shall be attenuated outside the band below the transmitter power (P) by at least  $43 + 10 \log (P)$  dB;
- (3) On all frequencies between 763-775 MHz and 793-805 MHz, by a factor not less than  $76 + 10 \log (P)$  dB in a 6.25 kHz band segment, for base and fixed stations;
- (4) On all frequencies between 763-775 MHz and 793-805 MHz, by a factor not less than  $65 + 10 \log (P)$  dB in a 6.25 kHz band segment, for mobile and portable stations;
- (5) Compliance with the provisions of paragraphs (c)(1) and (c)(2) of this section is based on the use of measurement instrumentation employing a resolution bandwidth of 100 kHz or greater. However, in the 100 kHz bands immediately outside and adjacent to the frequency block, a resolution bandwidth of at least 30 kHz may be employed;

Part 27.53 (h)/(g)Limit		-13 dBm
Part 27.53(f) Limit	Limit out of the band 1559-1610 MHz	-13 dBm
	Limit in the band 1559-1610 MHz	-40 dBm

### Measurement Uncertainty

The assessed measurement uncertainty to ensure 99.75% confidence level for the normal distribution is with the coverage factor  $k = 1.96$ .

Frequency	Uncertainty
9kHz-1GHz	0.684 dB
1GHz-27GHz	1.407 dB

**Test Result**

Sweep the whole frequency band through the range from 9kHz to the 10th harmonic of the carrier, the emissions more than 20 dB below the limit are not reported.

The signal beyond the limit is carrier.

**Variant**

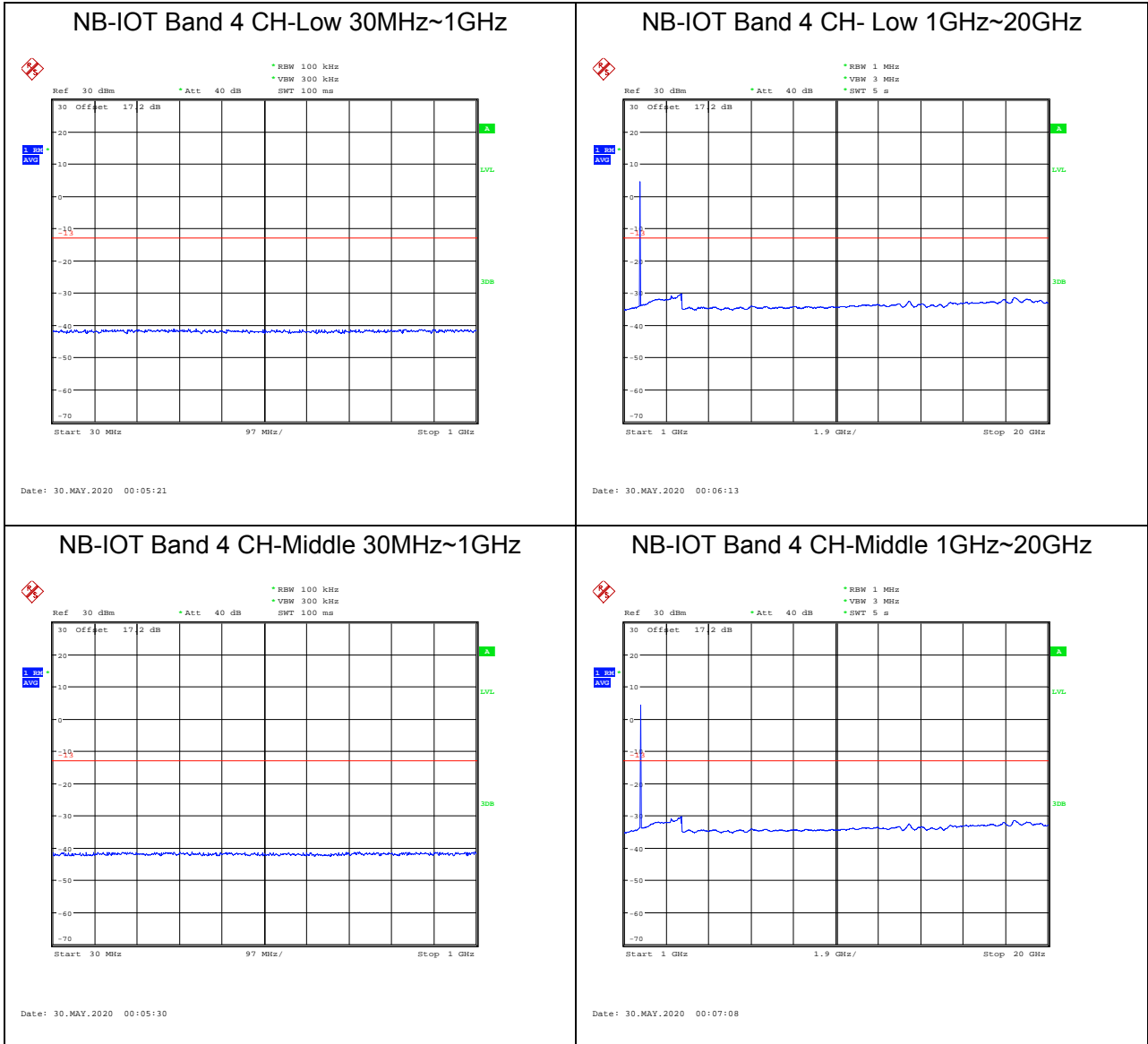

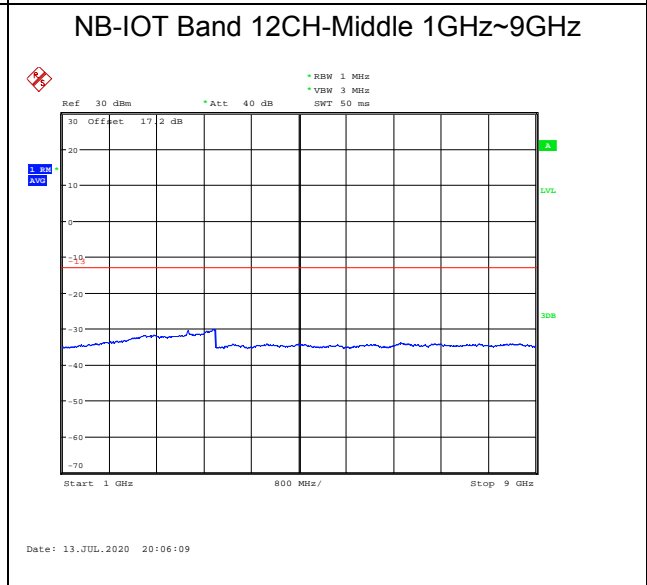
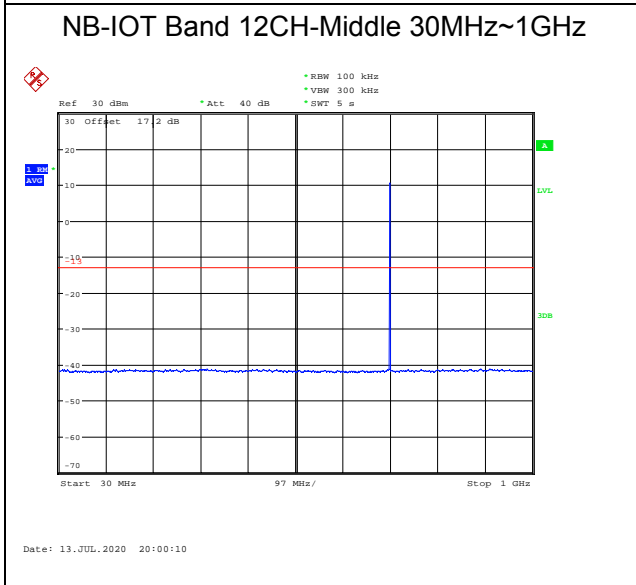
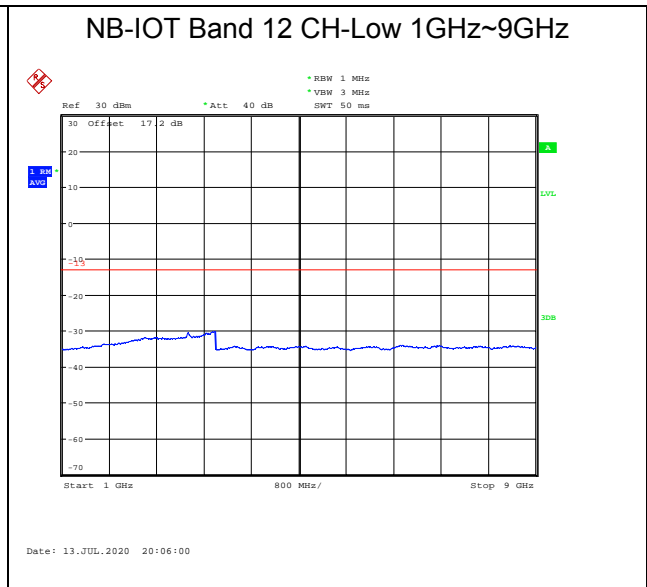
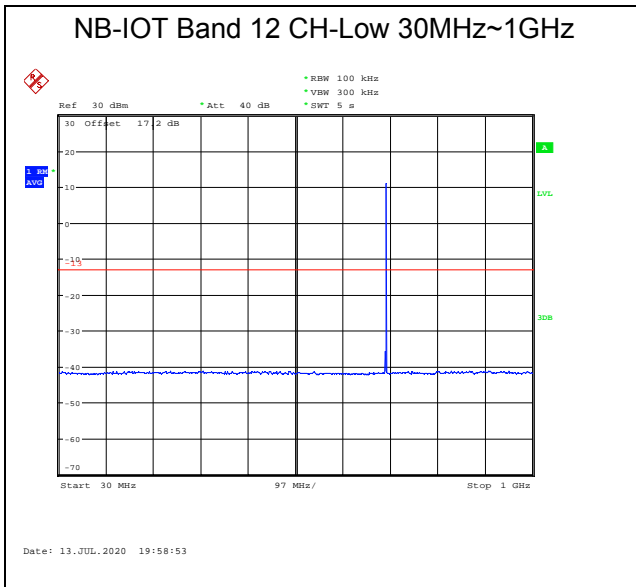
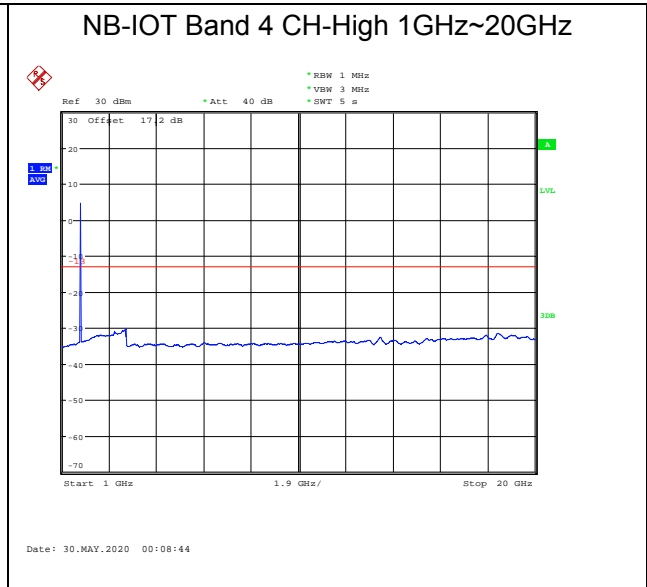
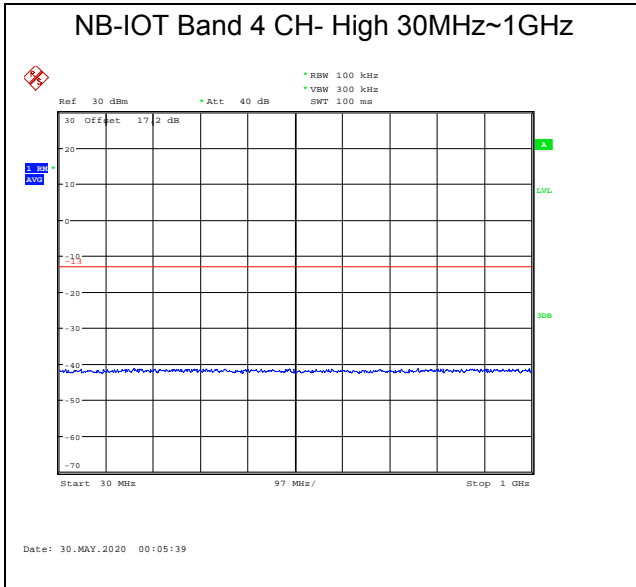

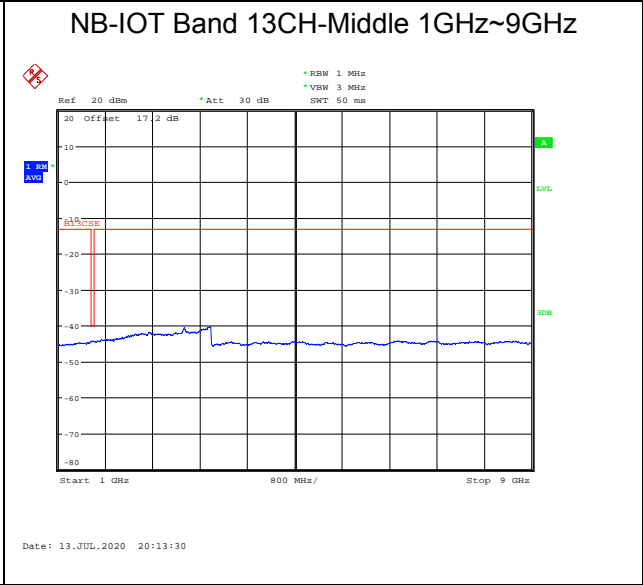
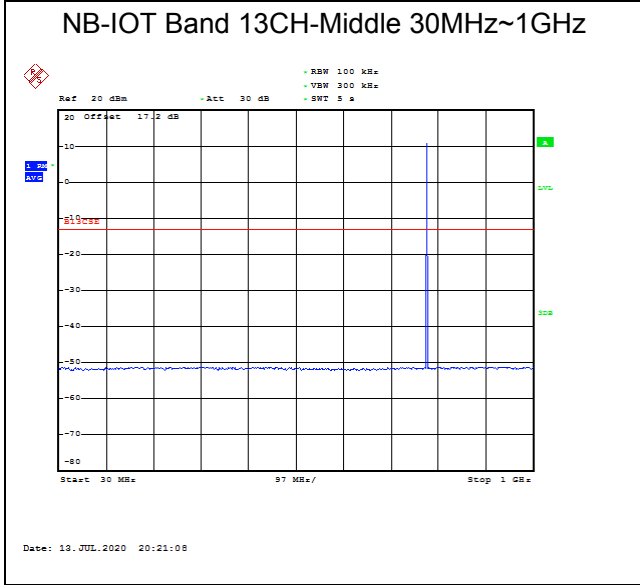
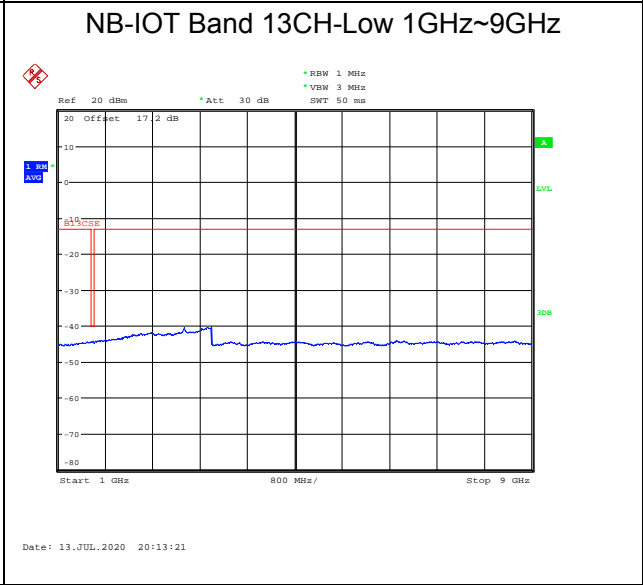
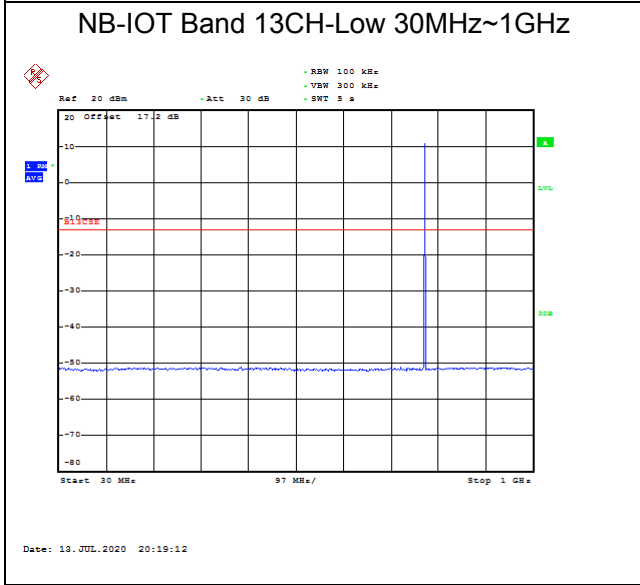
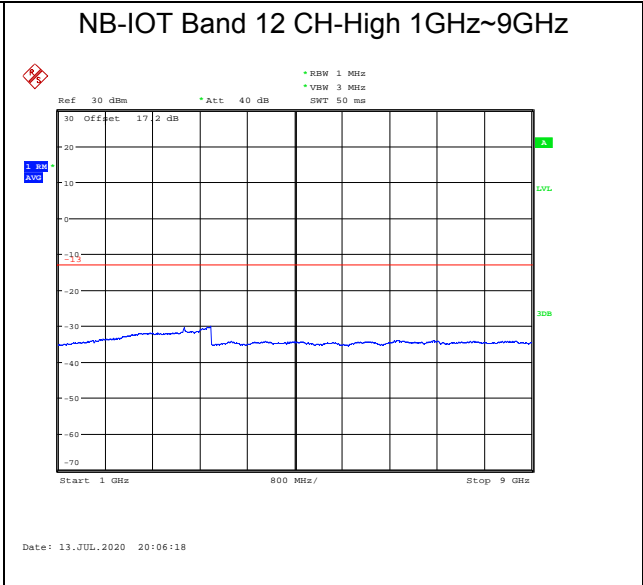
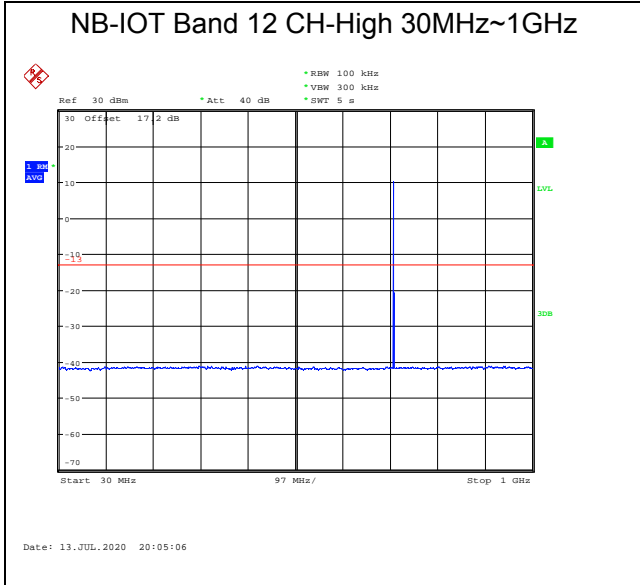



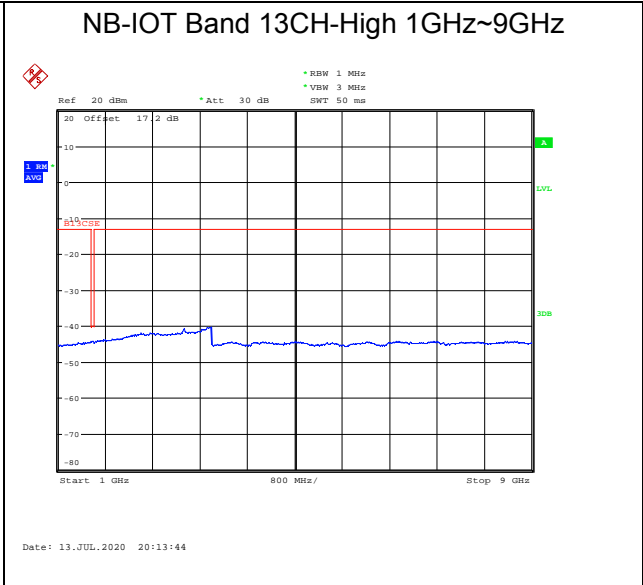
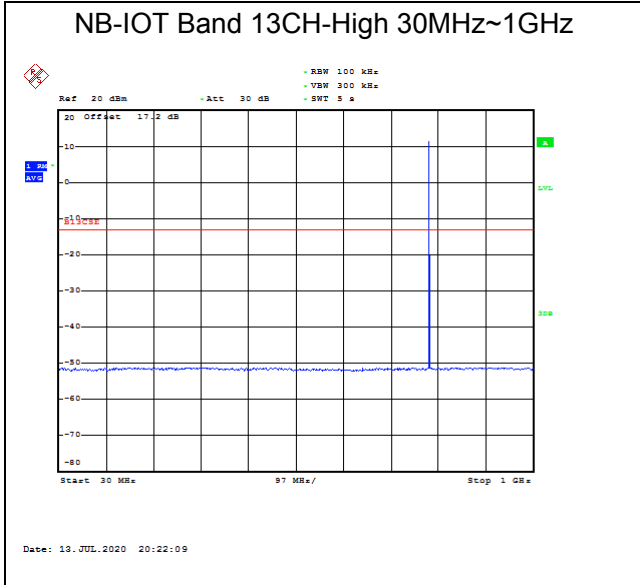

## 5.7 Radiates Spurious Emission

### Ambient condition

Temperature	Relative humidity	Pressure
23°C ~25°C	45%~50%	101.5kPa

### Method of Measurement

- The testing follows FCC KDB 971168 D01 v03r01 Section 5.8 and ANSI C63.26 (2015).
- Below 1GHz: The EUT is placed on a turntable 0.8 meters above the ground in the chamber, 3 meter away from the antenna. The maximal emission value is acquired by adjusting the antenna height, polarisation and turntable azimuth. Normally, the height range of antenna is 1 m to 4 m, the azimuth range of turntable is 0° to 360°, and the receive antenna has two polarizations Vertical (V) and Horizontal (H). Above 1GHz: (Note: the FCC's permission to use 1.5m as an alternative per TCBC Conf call of Dec. 2, 2014.) The EUT is placed on a turntable 1.5 meters above the ground in the chamber, 3 meter away from the antenna. The maximal emission value is acquired by adjusting the antenna height, polarisation and turntable azimuth. Normally, the height range of antenna is 1 m to 4 m, the azimuth range of turntable is 0° to 360°, and the receive antenna has two polarizations Vertical (V) and Horizontal (H).
- A loop antenna, A log-periodic antenna or horn antenna shall be substituted in place of the EUT. The log-periodic antenna will be driven by a signal generator and the level will be adjusted till the same power value on the spectrum analyzer or receiver. The level of the spurious emissions can be calculated through the level of the signal generator, cable loss, the gain of the substitution antenna and the reading of the spectrum analyzer or receiver.
- The EUT is then put into continuously transmitting mode at its maximum power level during the test. Set Test Receiver or Spectrum RBW=200Hz, VBW=600Hz for 9kHz-150kHz, RBW=10kHz, VBW=30kHz-30MHz, RBW=100kHz, VBW=300kHz for 30MHz to 1GHz and RBW=1MHz, VBW=3MHz for above 1GHz. And the maximum value of the receiver should be recorded as (Pr).
- The EUT shall be replaced by a substitution antenna. In the chamber, a substitution antenna for the frequency band of interest is placed at the reference point of the chamber. An RF Signal source for the frequency band of interest is connected to the substitution antenna with a cable that has been constructed to not interfere with the radiation pattern of the antenna. A power (P<sub>Mea</sub>) is applied to the input of the substitution antenna, and adjust the level of the signal generator output until the value of the receiver reach the previously recorded (Pr). The power of signal source (P<sub>Mea</sub>) is recorded. The test should be performed by rotating the test item and adjusting the receiving antenna polarization.
- An amplifier should be connected to the Signal Source output port. And the cable should be connect between the Amplifier and the Substitution Antenna. The cable loss (P<sub>cl</sub>), the Substitution Antenna Gain (G<sub>a</sub>) and the Amplifier Gain (P<sub>Ag</sub>) should be recorded after test.
- The measurement results are obtained as described below:

$$\text{Power(EIRP)} = P_{\text{Mea}} - P_{\text{Ag}} - P_{\text{cl}} + G_{\text{a}}$$

The measurement results are amend as described below:

$$\text{Power(EIRP)} = P_{\text{Mea}} - P_{\text{cl}} + G_{\text{a}}$$

- This value is EIRP since the measurement is calibrated using an antenna of known gain (2.15 dBi)

and known input power. ERP can be calculated from EIRP by subtracting the gain of the dipole,  $ERP = EIRP - 2.15\text{dBi}$ .

The modulation mode and RB allocation refer to section 5.1, using the maximum output power configuration.

**Test setup**

**9KHz~ 30MHz**

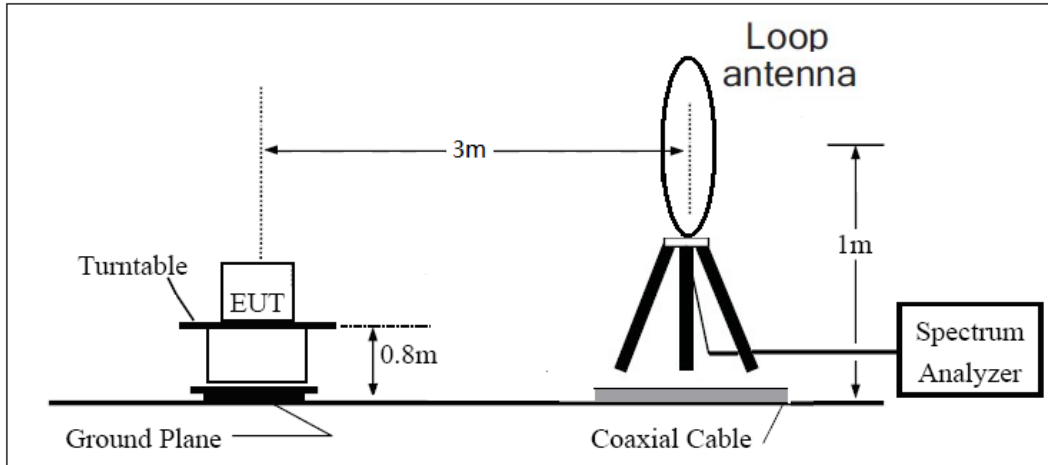

**30MHz~ 1GHz**

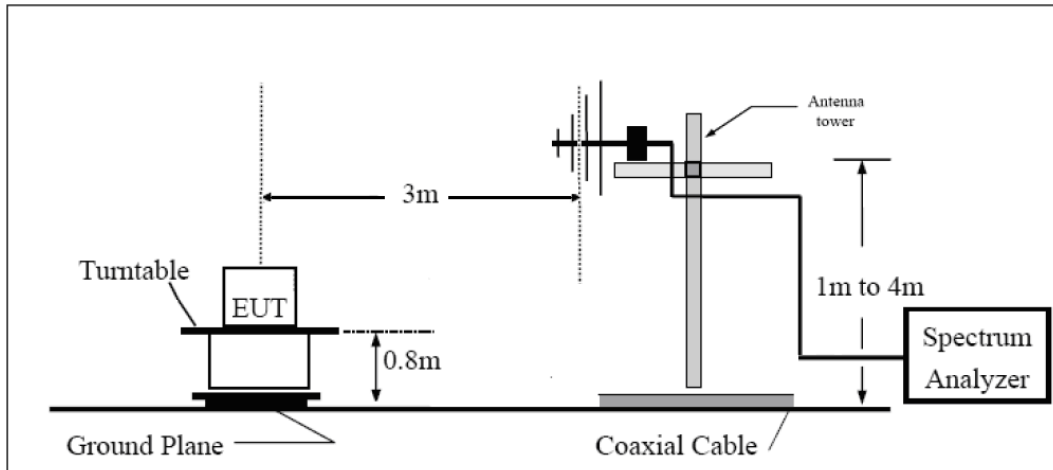

**Above 1GHz**

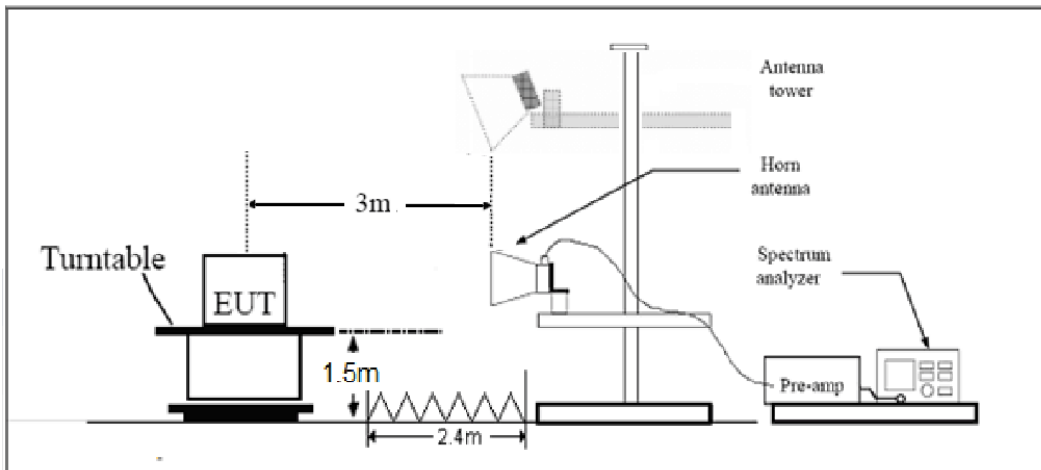

Note: Area side:2.4mX3.6m

### Limits

Rule Part 27.53(h) specifies that “for operations in the 1695-1710 MHz, 1710-1755 MHz, 1755-1780 MHz, 1915-1920 MHz, 1995-2000 MHz, 2000-2020 MHz, 2110-2155 MHz, 2155-2180 MHz, and 2180-2200 bands, the power of any emission outside a licensee's frequency block shall be attenuated below the transmitter power (P) in watts by at least  $43 + 10 \log_{10} (P)$  dB.”

Rule Part 27.53 (g) For operations in the 600 MHz band and the 698-746 MHz band, the power of any emission outside a licensee's frequency band(s) of operation shall be attenuated below the transmitter power (P) within the licensed band(s) of operation, measured in watts, by at least  $43 + 10 \log (P)$  dB. Compliance with this provision is based on the use of measurement instrumentation employing a resolution bandwidth of 100 kilohertz or greater. However, in the 100 kilohertz bands immediately outside and adjacent to a licensee's frequency block, a resolution bandwidth of at least 30 kHz may be employed.

Rule Part 27.53(f) For operations in the 746-758 MHz, 775-788 MHz, and 805-806 MHz bands, emissions in the band 1559-1610 MHz shall be limited to  $-70$  dBW/MHz equivalent isotropically radiated power (EIRP) for wideband signals, and  $-80$  dBW EIRP for discrete emissions of less than 700 Hz bandwidth. For the purpose of equipment authorization, a transmitter shall be tested with an antenna that is representative of the type that will be used with the equipment in normal operation.

Part 27.53 (c) For operations in the 746-758 MHz band and the 776-788 MHz band, the power of any emission outside the licensee's frequency band(s) of operation shall be attenuated below the transmitter power (P) within the licensed band(s) of operation, measured in watts, in accordance with the following:

- (1) On any frequency outside the 746-758 MHz band, the power of any emission shall be attenuated outside the band below the transmitter power (P) by at least  $43 + 10 \log (P)$  dB;
- (2) On any frequency outside the 776-788 MHz band, the power of any emission shall be attenuated outside the band below the transmitter power (P) by at least  $43 + 10 \log (P)$  dB;
- (3) On all frequencies between 763-775 MHz and 793-805 MHz, by a factor not less than  $76 + 10 \log (P)$  dB in a 6.25 kHz band segment, for base and fixed stations;
- (4) On all frequencies between 763-775 MHz and 793-805 MHz, by a factor not less than  $65 + 10 \log (P)$  dB in a 6.25 kHz band segment, for mobile and portable stations;
- (5) Compliance with the provisions of paragraphs (c)(1) and (c)(2) of this section is based on the use of measurement instrumentation employing a resolution bandwidth of 100 kHz or greater. However, in the 100 kHz bands immediately outside and adjacent to the frequency block, a resolution bandwidth of at least 30 kHz may be employed;

Part 27.53 (h)/(g) Limit		-13 dBm
Part 27.53(f) Limit	Limit out of the band 1559-1610 MHz	-13 dBm
	Limit in the band 1559-1610 MHz	-40 dBm



## Measurement Uncertainty

The assessed measurement uncertainty to ensure 95% confidence level for the normal distribution is with the coverage factor  $k = \pm 1.96$ ,  $U = \pm 3.55$  dB.

**Test Result**

The other Spurious RF Radiated emissions level is no more than noise floor.

The worst emission was found in the antenna is vertical position.

**Standalone deployment with 15 KHz subcarrier spacing and QPSK mode for CAT NB1:**

**Variant**

NB-IOT Band 4 CH-Low, RB 1

Harmonic	Frequency (MHz)	SG (dBm)	Cable Loss (dB)	Gain (dBi)	Antenna Polarization	EIRP Level (dBm)	Limit (dBm)	Margin (dB)	Azimuth (deg)
2	3420.2	-58.92	2.6	10.15	Vertical	-51.37	-13.00	38.37	45
3	5130.3	-59.46	2.4	11.35	Vertical	-50.51	-13.00	37.51	270
4	6840.4	-59.53	4.5	10.85	Vertical	-53.18	-13.00	40.18	0
5	8550.5	-55.17	5.1	11.35	Vertical	-48.92	-13.00	35.92	135
6	10260.6	-50.57	5.3	11.95	Vertical	-43.92	-13.00	30.92	45
7	11970.7	-52.63	5.5	13.55	Vertical	-44.58	-13.00	31.58	270
8	13680.8	-50.21	6.3	13.75	Vertical	-42.76	-13.00	29.76	0
9	15390.9	-49.45	6.7	13.85	Vertical	-42.30	-13.00	29.30	315
10	17101.0	-46.94	6.8	14.25	Vertical	-39.49	-13.00	26.49	90

Note: 1.The other Spurious RF Radiated emissions level is no more than noise floor.

2.The worst emission was found in the antenna is vertical position.

NB-IOT Band 4 CH-Middle, RB 1

Harmonic	Frequency (MHz)	SG (dBm)	Cable Loss (dB)	Gain (dBi)	Antenna Polarization	EIRP Level (dBm)	Limit (dBm)	Margin (dB)	Azimuth (deg)
2	3465.0	-55.47	2.6	10.15	Vertical	-47.92	-13.00	34.92	180
3	5197.5	-60.05	2.4	11.35	Vertical	-51.10	-13.00	38.10	45
4	6930.0	-59.50	4.5	10.85	Vertical	-53.15	-13.00	40.15	0
5	8662.5	-54.59	5.1	11.35	Vertical	-48.34	-13.00	35.34	135
6	10395.0	-50.26	5.3	11.95	Vertical	-43.61	-13.00	30.61	315
7	12127.5	-50.65	5.5	13.55	Vertical	-42.60	-13.00	29.60	45
8	13860.0	-49.54	6.3	13.75	Vertical	-42.09	-13.00	29.09	135
9	15592.5	-48.94	6.7	13.85	Vertical	-41.79	-13.00	28.79	45
10	17325.0	-47.67	6.8	14.25	Vertical	-40.22	-13.00	27.22	0

Note: 1.The other Spurious RF Radiated emissions level is no more than noise floor.

2.The worst emission was found in the antenna is vertical position.



**NB-IOT Band 4 CH-High, RB 1**

Harmonic	Frequency (MHz)	SG (dBm)	Cable Loss (dB)	Gain (dBi)	Antenna Polarization	EIRP Level (dBm)	Limit (dBm)	Margin (dB)	Azimuth (deg)
2	3509.8	-56.78	2.6	10.15	Vertical	-49.23	-13.00	36.23	90
3	5264.7	-59.84	2.4	11.35	Vertical	-50.89	-13.00	37.89	0
4	7019.6	-57.87	4.5	10.85	Vertical	-51.52	-13.00	38.52	45
5	8774.5	-54.57	5.1	11.35	Vertical	-48.32	-13.00	35.32	135
6	10529.4	-51.33	5.3	11.95	Vertical	-44.68	-13.00	31.68	315
7	12284.3	-50.32	5.5	13.55	Vertical	-42.27	-13.00	29.27	90
8	14039.2	-51.10	6.3	13.75	Vertical	-43.65	-13.00	30.65	45
9	15794.1	-49.15	6.7	13.85	Vertical	-42.00	-13.00	29.00	135
10	17549.0	-47.70	6.8	14.25	Vertical	-40.25	-13.00	27.25	90

Note: 1.The other Spurious RF Radiated emissions level is no more than noise floor.  
2.The worst emission was found in the antenna is vertical position.

**Original**
**NB-IOT Band 12 CH-Low, RB 1**

Harmonic	Frequency (MHz)	SG (dBm)	Cable Loss (dB)	Gain (dBi)	Antenna Polarization	ERP Level (dBm)	Limit (dBm)	Margin (dB)	Azimuth (deg)
2	1398.2	-50.31	2.00	10.15	Vertical	-44.31	-13.00	31.31	135
3	2097.3	-56.51	2.50	11.35	Vertical	-49.81	-13.00	36.81	225
4	2796.4	-54.04	4.20	10.85	Vertical	-49.54	-13.00	36.54	45
5	3495.5	-53.92	5.20	11.35	Vertical	-49.92	-13.00	36.92	180
6	4194.6	-52.38	5.50	11.95	Vertical	-48.08	-13.00	35.08	315
7	4893.7	-50.84	5.70	13.55	Vertical	-45.14	-13.00	32.14	45
8	5592.8	-49.93	6.30	13.75	Vertical	-44.63	-13.00	31.63	180
9	6291.9	-48.37	6.80	13.85	Vertical	-43.47	-13.00	30.47	315
10	6991.0	-46.90	6.90	14.25	Vertical	-41.70	-13.00	28.70	135

Note: 1.The other Spurious RF Radiated emissions level is no more than noise floor.  
2.The worst emission was found in the antenna is vertical position.

**NB-IOT Band 12 CH-Middle, RB 1**

Harmonic	Frequency (MHz)	SG (dBm)	Cable Loss (dB)	Gain (dBi)	Antenna Polarization	ERP Level (dBm)	Limit (dBm)	Margin (dB)	Azimuth (deg)
2	1415.0	-55.61	2.00	10.75	Vertical	-49.01	-13.00	36.01	225
3	2122.5	-56.87	2.51	11.05	Vertical	-50.48	-13.00	37.48	90
4	2830.0	-54.29	4.20	11.15	Vertical	-49.49	-13.00	36.49	180
5	3537.5	-54.30	5.20	11.15	Vertical	-50.50	-13.00	37.50	45
6	4245.0	-52.44	5.50	11.95	Vertical	-48.14	-13.00	35.14	180
7	4952.5	-49.98	5.70	13.55	Vertical	-44.28	-13.00	31.28	45
8	5660.0	-50.48	6.30	13.75	Vertical	-45.18	-13.00	32.18	0
9	6367.5	-48.06	6.80	13.85	Vertical	-43.16	-13.00	30.16	135
10	7075.0	-47.18	6.90	14.25	Vertical	-41.98	-13.00	28.98	225

Note: 1.The other Spurious RF Radiated emissions level is no more than noise floor.  
2.The worst emission was found in the antenna is vertical position.

**NB-IOT Band 12 CH-High, RB 1**

Harmonic	Frequency (MHz)	SG (dBm)	Cable Loss (dB)	Gain (dBi)	Antenna Polarization	ERP Level (dBm)	Limit (dBm)	Margin (dB)	Azimuth (deg)
2	1431.8	-58.45	2.00	10.15	Vertical	-52.45	-13.00	39.45	90
3	2147.7	-53.95	2.51	11.05	Vertical	-47.56	-13.00	34.56	225
4	2863.6	-55.13	4.20	11.15	Vertical	-50.33	-13.00	37.33	180
5	3579.5	-53.91	5.20	11.15	Vertical	-50.11	-13.00	37.11	270
6	4295.4	-52.74	5.50	11.95	Vertical	-48.44	-13.00	35.44	135
7	5011.3	-50.04	5.70	13.55	Vertical	-44.34	-13.00	31.34	45
8	5727.2	-50.21	6.30	13.75	Vertical	-44.91	-13.00	31.91	180
9	6443.1	-48.38	6.80	13.85	Vertical	-43.48	-13.00	30.48	315
10	7159.0	-47.32	6.90	14.25	Vertical	-42.12	-13.00	29.12	135

Note: 1.The other Spurious RF Radiated emissions level is no more than noise floor.  
2.The worst emission was found in the antenna is vertical position.

**NB-IOT Band 13 CH-Low, RB 1**

Harmonic	Frequency (MHz)	SG (dBm)	Cable Loss (dB)	Gain (dBi)	Antenna Polarization	ERP Level (dBm)	Limit (dBm)	Margin (dB)	Azimuth (deg)
2	1554.2	-59.12	2.00	10.15	Vertical	-53.12	-13.00	43.12	225
3	2331.3	-50.55	2.50	11.35	Vertical	-43.85	-13.00	30.85	90
4	3108.4	-55.25	4.20	10.85	Vertical	-50.75	-13.00	37.75	180
5	3885.5	-52.86	5.20	11.35	Vertical	-48.86	-13.00	35.86	45
6	4662.6	-51.24	5.50	11.95	Vertical	-46.94	-13.00	33.94	180
7	5439.7	-50.65	5.70	13.55	Vertical	-44.95	-13.00	31.95	45
8	6216.8	-50.18	6.30	13.75	Vertical	-44.88	-13.00	31.88	0
9	6993.9	-48.64	6.80	13.85	Vertical	-43.74	-13.00	30.74	135
10	7771.0	-46.08	6.90	14.25	Vertical	-40.88	-13.00	27.88	225

Note: 1.The other Spurious RF Radiated emissions level is no more than noise floor.  
2.The worst emission was found in the antenna is vertical position.

**NB-IOT Band 13 CH-Middle, RB 1**

Harmonic	Frequency (MHz)	SG (dBm)	Cable Loss (dB)	Gain (dBi)	Antenna Polarization	EIRP Level (dBm)	Limit (dBm)	Margin (dB)	Azimuth (deg)
2	1564.0	-59.31	2.00	10.75	Vertical	-52.71	-40.00	12.71	90
Harmonic	Frequency (MHz)	SG (dBm)	Cable Loss (dB)	Gain (dBi)	Antenna Polarization	ERP Level (dBm)	Limit (dBm)	Margin (dB)	Azimuth (deg)
3	2346.0	-50.01	2.51	11.05	Vertical	-43.62	-13.00	30.62	225
4	3128.0	-54.55	4.20	11.15	Vertical	-49.75	-13.00	36.75	180
5	3910.0	-52.16	5.20	11.15	Vertical	-48.36	-13.00	35.36	270
6	4692.0	-51.25	5.50	11.95	Vertical	-46.95	-13.00	33.95	135
7	5474.0	-50.56	5.70	13.55	Vertical	-44.86	-13.00	31.86	45
8	6256.0	-49.95	6.30	13.75	Vertical	-44.65	-13.00	31.65	180
9	7038.0	-48.28	6.80	13.85	Vertical	-43.38	-13.00	30.38	315
10	7820.0	-45.08	6.90	14.25	Vertical	-39.88	-13.00	26.88	135

Note: 1.The other Spurious RF Radiated emissions level is no more than noise floor.  
2.The worst emission was found in the antenna is vertical position.

**NB-IOT Band 13 CH-High, RB 1**

Harmonic	Frequency (MHz)	SG (dBm)	Cable Loss (dB)	Gain (dBi)	Antenna Polarization	EIRP Level (dBm)	Limit (dBm)	Margin (dB)	Azimuth (deg)
2	1573.8	-60.27	2.00	10.15	Vertical	-54.27	-40.00	14.27	225
Harmonic	Frequency (MHz)	SG (dBm)	Cable Loss (dB)	Gain (dBi)	Antenna Polarization	ERP Level (dBm)	Limit (dBm)	Margin (dB)	Azimuth (deg)
3	2360.7	-49.96	2.51	11.05	Vertical	-43.57	-13.00	30.57	90
4	3147.6	-54.03	4.20	11.15	Vertical	-49.23	-13.00	36.23	180
5	3934.5	-51.84	5.20	11.15	Vertical	-48.04	-13.00	35.04	45
6	4721.4	-51.17	5.50	11.95	Vertical	-46.87	-13.00	33.87	180
7	5508.3	-50.57	5.70	13.55	Vertical	-44.87	-13.00	31.87	45
8	6295.2	-49.67	6.30	13.75	Vertical	-44.37	-13.00	31.37	0
9	7082.1	-47.97	6.80	13.85	Vertical	-43.07	-13.00	30.07	135
10	7869.0	-44.89	6.90	14.25	Vertical	-39.69	-13.00	26.69	225

Note: 1.The other Spurious RF Radiated emissions level is no more than noise floor.  
2.The worst emission was found in the antenna is vertical position.

## 6 Main Test Instruments

Date of Testing: August 4, 2017 ~August 18, 2017

Name	Manufacturer	Type	Serial Number	Calibration Date	Expiration Time
Base Station Simulator	R&S	CMW500	150415	2017-05-14	2018-05-13
Power Splitter	Hua Xiang	SHX-GF2-2-13	10120101	2017-05-14	2018-05-13
Universal Radio Communication Tester	Agilent	E5515C	MY48367192	2017-05-14	2018-05-13
Spectrum Analyzer	Agilent	N9010A	MY47191109	2017-05-14	2018-05-13
Signal Analyzer	R&S	FSV30	100815	2016-12-16	2017-12-15
Signal generator	R&S	SMB 100A	102594	2017-05-14	2018-05-13
EMI Test Receiver	R&S	ESCI	100948	2017-05-20	2018-05-19
Loop Antenna	SCHWARZBECK	FMZB1519	1519-047	2014-09-27	2017-09-26
Trilog Antenna	SCHWARZBECK	VUBL 9163	9163-201	2014-12-06	2017-12-05
Horn Antenna	R&S	HF907	100126	2014-12-06	2017-12-05
Horn Antenna	ETS-Lindgren	3160-09	00102643	2015-01-30	2018-01-29
Climatic Chamber	Re Ce	PT-30B	20101891	2015-07-18	2018-07-17
RF Cable	Agilent	SMA 15cm	0001	2017-02-06	2017-08-05
Preamplifier	R&S	SCU18	102327	2017-06-18	2018-06-17



Date of Testing: April 2, 2020 ~ April 9, 2020

Name	Manufacturer	Type	Serial Number	Calibration Date	Expiration Date
Base Station Simulator	R&S	CMW500	113824	2019-05-19	2020-05-18
Power Splitter	Hua Xiang	SHX-GF2-2-13	10120101	/	/
Spectrum Analyzer	Key sight	N9010A	MY50210259	2019-05-19	2020-05-18
Signal Analyzer	R&S	FSV30	100815	2018-12-16	2019-12-15
Loop Antenna	SCHWARZBECK	FMZB1519	1519-047	2017-09-26	2020-09-25
Trilog Antenna	SCHWARZBECK	VUBL 9163	9163-201	2017-11-18	2020-11-17
Horn Antenna	R&S	HF907	100126	2018-07-07	2020-07-06
Horn Antenna	ETS-Lindgren	3160-09	00102643	2018-06-20	2020-06-19
Horn Antenna	STEATITE	QSH-SL-26-40-K-15	16779	2017-07-20	2020-07-19
Signal generator	R&S	SMB 100A	102594	2019-05-19	2020-05-18
Climatic Chamber	ESPEC	SU-242	93000506	2017-12-17	2020-12-16
Preamplifier	R&S	SCU18	102327	2019-05-19	2020-05-18
MOB COMMS DC SUPPLY	Keysight	66319D	MY43004105	2019-05-19	2020-05-18
RF Cable	Agilent	SMA 15cm	0001	2019-12-13	2020-6-12
Software	R&S	EMC32	9.26.0	/	/





Date of Testing: May 30, 2020~July 13, 2020

Name	Manufacturer	Type	Serial Number	Calibration Date	Expiration Date
Base Station Simulator	R&S	CMW500	113824	2020-05-18	2021-05-17
Power Splitter	Hua Xiang	SHX-GF2-2-13	10120101	/	/
Spectrum Analyzer	Key sight	N9010A	MY50210259	2020-05-18	2021-05-17
Signal Analyzer	R&S	FSV30	100815	2019-12-15	2020-12-14
Loop Antenna	SCHWARZBECK	FMZB1519	1519-047	2017-09-26	2020-09-25
Trilog Antenna	SCHWARZBECK	VUBL 9163	9163-201	2017-11-18	2020-11-17
Horn Antenna	R&S	HF907	102723	2018-08-11	2021-08-10
Horn Antenna	ETS-Lindgren	3160-09	00102643	2018-06-20	2021-06-19
Horn Antenna	STEATITE	QSH-SL-26-40-K-15	16779	2017-07-20	2021-07-19
Signal generator	R&S	SMB 100A	102594	2020-05-18	2021-05-17
Climatic Chamber	ESPEC	SU-242	93000506	2017-12-17	2020-12-16
Preamplifier	R&S	SCU18	102327	2020-05-18	2021-05-17
MOB COMMS DC SUPPLY	Keysight	66319D	MY43004105	2020-05-18	2021-05-17
RF Cable	Agilent	SMA 15cm	0001	2020-06-12	2020-12-11
Software	R&S	EMC32	9.26.0	/	/

\*\*\*\*\*END OF REPORT \*\*\*\*\*