



RF TEST REPORT

| | |
|-------------------|--------------------------------------|
| Applicant | Quectel Wireless Solutions Co., Ltd. |
| FCC ID | XMR201707BG96 |
| Product | LTE Cat M1 & Cat NB1 & EGPRS Module |
| Brand | Quectel |
| Model | BG96, BG96 MINIPCIE |
| Marketing | Quectel BG96, Quectel BG96 MINIPCIE |
| Report No. | R2007A0435-R2 |
| Issue Date | July 14, 2020 |

TA Technology (Shanghai) Co., Ltd. tested the above equipment in accordance with the requirements in **FCC CFR47 Part 2 (2019)/ FCC CFR 47 Part 24E (2019)**. The test results show that the equipment tested is capable of demonstrating compliance with the requirements as documented in this report.

Performed by: Peng Tao

Approved by: Kai Xu

TA Technology (Shanghai) Co., Ltd.

No.145, Jintang Rd, Tangzhen Industry Park, Pudong Shanghai, China

TEL: +86-021-50791141/2/3

FAX: +86-021-50791141/2/3-8000



TABLE OF CONTENT

| | |
|---|----|
| 1. Test Laboratory | 4 |
| 1.1. Notes of the test report..... | 4 |
| 1.2. Test facility..... | 4 |
| 1.3. Testing Location | 5 |
| 2. General Description of Equipment under Test..... | 6 |
| 3. Applied Standards..... | 7 |
| 4. Test Configuration..... | 8 |
| 5. Test Case Results..... | 9 |
| 5.1. RF Power Output and Effective Isotropic Radiated Power | 9 |
| 5.2. Occupied Bandwidth | 13 |
| 5.3. Band Edge Compliance..... | 20 |
| 5.4. Peak-to-Average Power Ratio (PAPR) | 25 |
| 5.5. Frequency Stability | 27 |
| 5.6. Spurious Emissions at Antenna Terminals | 32 |
| 5.7. Radiates Spurious Emission | 36 |
| 6. Main Test Instruments | 42 |
| ANNEX A: Product Change Description..... | 46 |

Summary of measurement results

| No. | Test Case | Clause in FCC rules | Verdict |
|-----|--|----------------------------|-----------------------|
| 1 | RF Power Output and Effective Isotropic Radiated Power | 2.1046 24.232(c) | PASS |
| 2 | Occupied Bandwidth | 2.1049 | PASS |
| 3 | Band Edge Compliance | 2.1051 /24.238(a) | PASS |
| 4 | Peak-to-Average Power Ratio | 24.232/KDB 971168 D01(5.7) | Refer to the Original |
| 5 | Frequency Stability | 2.1055 / 24.235 | PASS |
| 6 | Spurious Emissions at Antenna Terminals | 2.1051 / 24.238(a) | PASS |
| 7 | Radiates Spurious Emission | 2.1053 / 24.238(a) | Refer to the Original |

Date of Testing: August 4, 2017 ~ August 18, 2017 and December 20, 2018 ~ February 13, 2019 and April 2, 2020~ April 9, 2020 and July 13, 2020

Note: PASS: The EUT complies with the essential requirements in the standard.
 FAIL: The EUT does not comply with the essential requirements in the standard.
 All indications of Pass/Fail in this report are opinions expressed by TA Technology (Shanghai) Co., Ltd. based on interpretations and/or observations of test results. Measurement Uncertainties were not taken into account and are published for informational purposes only.

BG96, BG96 MINIPCIE (Report No.: R2007A0435-R2) is a variant model of BG96, BG96 MINIPCIE (Report No.: R1811A0536-R5). Test values partial duplicated from original for variant. There is only tested RF power output, Effective Radiated Power, Occupied Bandwidth, Band Edge Compliance ,Frequency Stability and Spurious Emissions at Antenna Terminals for variant in this report. The detailed product change description please refers to the Statement letter_BG96.

BG96, BG96 MINIPCIE (Report No: R1811A0536-R5) is a variant model of BG96 (Report No: RXA1706-0199RF06). Test items tested see the table below. The detailed product change description please refers to the ANNEX A.

| Band | Original (RXA1706-0199RF06) | Variant (R1811A0536-R5) |
|----------------|--------------------------------|----------------------------|
| NB-IOT Band 2 | Pass | Refer to the Original |
| NB-IOT Band 25 | NA | Pass |



1. Test Laboratory

1.1. Notes of the test report

This report shall not be reproduced in full or partial, without the written approval of **TA technology (shanghai) co., Ltd.** The results documented in this report apply only to the tested sample, under the conditions and modes of operation as described herein. Measurement Uncertainties were not taken into account and are published for informational purposes only. This report is written to support regulatory compliance of the applicable standards stated above. This report must not be used by the client to claim product certification, approval, or endorsement by any government agencies.

1.2. Test facility

FCC (Designation number: CN1179, Test Firm Registration Number: 446626)

TA Technology (Shanghai) Co., Ltd. has been listed on the US Federal Communications Commission list of test facilities recognized to perform electromagnetic emissions measurements.

A2LA (Certificate Number: 3857.01)

TA Technology (Shanghai) Co., Ltd. has been listed by American Association for Laboratory Accreditation to perform electromagnetic emission measurement.



1.3. Testing Location

Company: TA Technology (Shanghai) Co., Ltd.
Address: No.145, Jintang Rd, Tangzhen Industry Park, Pudong
City: Shanghai
Post code: 201201
Country: P. R. China
Contact: Xu Kai
Telephone: +86-021-50791141/2/3
Fax: +86-021-50791141/2/3-8000
Website: <http://www.ta-shanghai.com>
E-mail: xukai@ta-shanghai.com

2. General Description of Equipment under Test

Client Information

| | |
|----------------------|--|
| Applicant | Quectel Wireless Solutions Co., Ltd. |
| Applicant address | 7th Floor, Hongye Building, No. 1801 Hongmei Road, Xuhui District, Shanghai, China |
| Manufacturer | Quectel Wireless Solutions Co., Ltd. |
| Manufacturer address | 7th Floor, Hongye Building, No. 1801 Hongmei Road, Xuhui District, Shanghai, China |

General information

| EUT Description | | | |
|--|---|-------------|-------------|
| Model | BG96, BG96 MINIPCIE | | |
| IMEI | 866425038291656 | | |
| Hardware Version | R1.2 | | |
| Software Version | BG96MAR04A01M1G | | |
| Power Supply | External power supply | | |
| Antenna Type | The EUT don't have standard Antenna, The Antenna used for testing in this report is the after-market accessory (Dipole Antenna) | | |
| Antenna Gain | Frequency(MHz) | Gain (dBi) | |
| | 1860 | 1.25 | |
| | 1880 | 1.38 | |
| | 1900 | 1.59 | |
| Test Mode(s) | NB-IOT Band 2; NB-IOT Band 25; | | |
| Test Modulation | BPSK, QPSK | | |
| Category | NB1 | | |
| Deployment: | stand-alone | | |
| Sub-carrier spacing: | 3.75KHz, 15KHz | | |
| Ntones: | single-tone, multi-tone | | |
| Maximum E.I.R.P | NB-IOT Band 2: | 24.54 dBm | |
| | NB-IOT Band 25 | 24.95dBm | |
| Rated Power Supply Voltage | 3.8V | | |
| Extreme Voltage | Minimum: 3.3V Maximum: 4.3V | | |
| Extreme Temperature | Lowest: -40°C Highest: +85°C | | |
| Frequency Range(s) | Band | Tx (MHz) | Rx (MHz) |
| | NB-IOT Band 2 | 1850 ~ 1910 | 1930 ~ 1990 |
| | NB-IOT Band 25 | 1850 ~ 1915 | 1930 ~ 1995 |
| Note: 1. The EUT is sent from the applicant to TA and the information of the EUT is declared by the applicant. | | | |

3. Applied Standards

According to the specifications of the manufacturer, it must comply with the requirements of the following standards:

Test standards:

FCC CFR 47 Part 24E (2019)

ANSI C63.26 (2015)

Reference standard:

FCC CFR47 Part 2 (2019)

KDB 971168 D01 Power Meas License Digital Systems v03r01

4. Test Configuration

Radiated measurements are performed by rotating the EUT in three different orthogonal test planes. EUT stand-up position (X, Y axis), lie down position (Z axis). Receiver antenna polarization (horizontal and vertical), the worst emission was found in position (Z axis, vertical polarization) and the worst case was recorded.

All mode and data rates and positions and RB size and modulations were investigated.

Subsequently, only the worst case emissions are reported.

The following testing in NB-IOT is set based on the maximum RF Output Power.

Test modes are chosen to be reported as the worst case configuration below for NB-IOT Band 2/25

| Test items | Deployment mode | Subcarrier Spacing (kHz) | | Modulation | | Test Channel | | |
|--|-----------------|--------------------------|----|------------|------|--------------|---|---|
| | Stand-alone | 3.75 | 15 | BPSK | QPSK | L | M | H |
| RF Power Output and Effective Isotropic Radiated Power | O | O | O | O | O | O | O | O |
| Occupied Bandwidth | O | O | O | O | O | O | O | O |
| Band Edge Compliance | O | O | O | O | O | O | - | O |
| Peak-to-Average Power Ratio | O | O | O | O | O | - | O | - |
| Frequency Stability | O | O | O | O | O | O | O | O |
| Conducted Spurious Emissions | O | - | O | - | O | O | O | O |
| Radiates Spurious Emission | O | - | O | - | O | O | O | O |
| Note 1. The mark "O" means that this configuration is chosen for testing. 2. The mark "-" means that this configuration is not testing. | | | | | | | | |

5. Test Case Results

5.1.RF Power Output and Effective Isotropic Radiated Power

Ambient condition

| Temperature | Relative humidity | Pressure |
|-------------|-------------------|----------|
| 23°C ~25°C | 45%~50% | 101.5kPa |

Methods of Measurement

During the process of the testing, The EUT is controlled by the Base Station Simulator to ensure max power transmission and proper modulation.

The testing follows FCC KDB 971168 v03r01 Section 5.8 and ANSI C63.26 (2015).

- a) Connect the equipment as illustrated. Mount the equipment with the manufacturer specified antenna in a vertical orientation on a manufacturer specified mounting surface located on a non-conducting rotating platform of a RF anechoic chamber (preferred) or a standard radiation site.
- b) Key the transmitter, then rotate the EUT 360° azimuthally and record spectrum analyzer power level (LVL) measurements at angular increments that are sufficiently small to permit resolution of all peaks. If a standard radiation test site is used, raise and lower the test antenna to obtain a maximum reading at each angular increment. (Note: several batteries may be needed to offset the effect of battery voltage droop, which should not exceed 5% of the manufactured specified battery voltage during transmission).
- c) Replace the transmitter under test with a vertically polarized half-wave dipole (or an antenna whose gain is known relative to an ideal half-wave dipole). The center of the antenna should be at the same location as the center of the antenna under test.
- d) Connect the antenna to a signal generator with a known output power and record the path loss (in dB) as LOSS. If a standard radiation test site is used, raise and lower the test antenna to obtain a maximum reading. $LOSS = \text{Generator Output Power (dBm)} - \text{Analyzer reading (dBm)}$
- e) Determine the effective radiated output power at each angular position from the readings in steps b) and d) using the following equation: $ERP \text{ (dBm)} = \text{LVL (dBm)} + \text{LOSS (dB)}$
- f) The maximum ERP is the maximum value determined in the preceding step.
- g) When calculating ERP, in addition to knowing the antenna radiation and matching characteristics, it is necessary to know the loss values of all elements (e.g.transmission line attenuation, mismatches, filters, combiners) interposed between the point where transmitter output power is measured, and the point where power is applied to the antenna. ERP can then be calculated as follows:
 $EIRP \text{ (dBm)} = \text{Output Power (dBm)} - \text{Losses (dB)} + \text{Antenna Gain (dBi)}$
where:dBd refers to gain relative to an ideal dipole.
 $EIRP \text{ (dBm)} = ERP \text{ (dBm)} + 2.15 \text{ (dB.)}$

The RB allocation refers to section 5.1, using the maximum output power configuration.

Test Setup

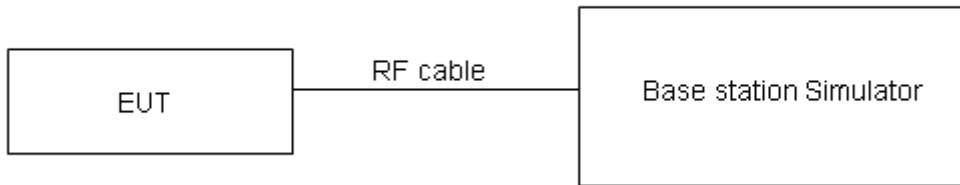

The loss between RF output port of the EUT and the input port of the tester has been taken into consideration.

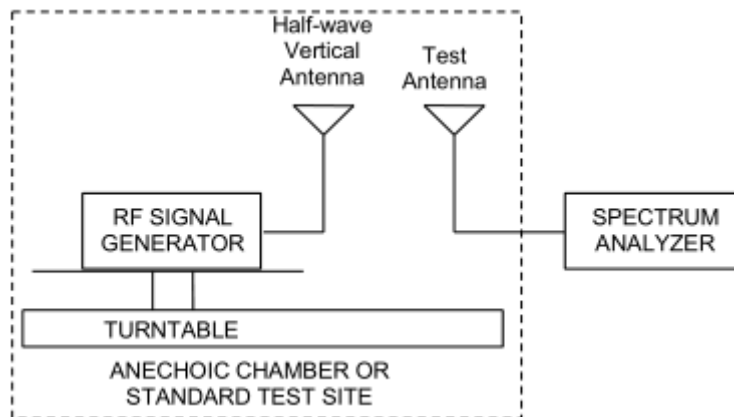
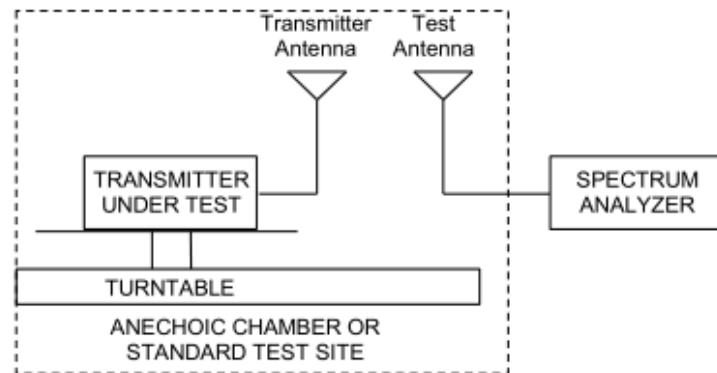

Limits

No specific RF power output requirements in part 2.1046.

Rule Part 24.232(c) Mobile and portable stations are limited to 2 watts EIRP.

Rule Part 24.232(e) Peak transmit power must be measured over any interval of continuous transmission using instrumentation calibrated in terms of an rms-equivalent voltage.

| | |
|-------|----------------------------|
| Limit | $\leq 2\text{ W}$ (33 dBm) |
|-------|----------------------------|

**Measurement Uncertainty**

The assessed measurement uncertainty to ensure 95% confidence level for the normal distribution is with the coverage factor $k = 2$, $U = 0.4$ dB for RF power output, $k = 2$, $U = 1.19$ dB for EIRP.



Test Results

Variant

| Mode | Modulation | Sub-carrier spacing (kHz) | Ntones | Conducted Power (dBm) for low/mid/high channel | | | EIRP(dBm) | | |
|--------------------------|------------|---------------------------|--------|--|------------------|------------------|------------------|------------------|------------------|
| | | | | 18602/1850.2 MHz | 18900/1880.0 MHz | 19198/1909.8 MHz | 18602/1850.2 MHz | 18900/1880.0 MHz | 19198/1909.8 MHz |
| | | | | | | | | | |
| NB-IOT Band 2 Standalone | BPSK | 3.75 | 1@0 | 22.76 | 22.77 | 22.72 | 24.01 | 24.15 | 24.31 |
| | | | 1@47 | 22.87 | 22.69 | 22.65 | 24.12 | 24.07 | 24.24 |
| | | 15 | 1@0 | 22.87 | 22.85 | 22.74 | 24.12 | 24.23 | 24.33 |
| | | | 1@11 | 22.81 | 22.86 | 22.76 | 24.06 | 24.24 | 24.35 |
| | QPSK | 3.75 | 1@0 | 22.83 | 22.65 | 22.68 | 24.08 | 24.03 | 24.27 |
| | | | 1@47 | 22.84 | 22.68 | 22.61 | 24.09 | 24.06 | 24.20 |
| | | 15 | 1@0 | 22.85 | 22.78 | 22.71 | 24.10 | 24.16 | 24.30 |
| | | | 1@11 | 22.76 | 22.81 | 22.70 | 24.01 | 24.19 | 24.29 |
| | | 15 | 12@0 | 22.97 | 22.98 | 22.95 | 24.22 | 24.36 | 24.54 |

| Mode | Modulation | Sub-carrier spacing (kHz) | Ntones | Conducted Power (dBm) for low/mid/high channel | | | EIRP(dBm) | | |
|---------------------------|------------|---------------------------|--------|--|------------------|------------------|------------------|------------------|------------------|
| | | | | 26042/1850.2 MHz | 26365/1882.5 MHz | 26688/1914.8 MHz | 26042/1850.2 MHz | 26365/1882.5 MHz | 26688/1914.8 MHz |
| | | | | | | | | | |
| NB-IOT Band 25 Standalone | BPSK | 3.75 | 1@0 | 23.02 | 23.14 | 23.31 | 24.27 | 24.52 | 24.67 |
| | | | 1@47 | 22.94 | 23.05 | 23.35 | 24.19 | 24.43 | 24.71 |
| | | 15 | 1@0 | 23.19 | 23.36 | 23.24 | 24.44 | 24.74 | 24.60 |
| | | | 1@11 | 23.17 | 23.30 | 23.23 | 24.42 | 24.68 | 24.59 |
| | QPSK | 3.75 | 1@0 | 22.93 | 23.12 | 23.37 | 24.18 | 24.50 | 24.73 |
| | | | 1@47 | 22.87 | 23.09 | 23.27 | 24.12 | 24.47 | 24.63 |
| | | 15 | 1@0 | 23.08 | 23.29 | 23.16 | 24.33 | 24.67 | 24.52 |
| | | | 1@11 | 23.16 | 23.34 | 23.20 | 24.41 | 24.72 | 24.56 |
| | | 15 | 12@0 | 23.34 | 23.57 | 23.41 | 24.59 | 24.95 | 24.77 |

5.2.Occupied Bandwidth

Ambient condition

| Temperature | Relative humidity | Pressure |
|-------------|-------------------|----------|
| 23°C ~25°C | 45%~50% | 101.5kPa |

Method of Measurement

The EUT was connected to Spectrum Analyzer and Base Station Simulator via power Splitter. The occupied bandwidth is measured using spectrum analyzer.

RBW is set to 2kHz, VBW is set to 6.2kHz for NB-IOT Band 2/25.

99% power and -26dBc occupied bandwidths are recorded. Spectrum analyzer plots are included on the following pages.

Test Setup

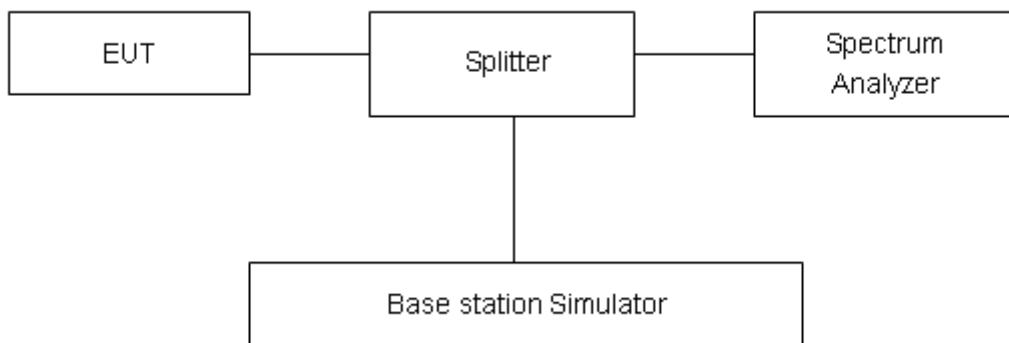

Limits

No specific occupied bandwidth requirements in part 2.1049.

Measurement Uncertainty

The assessed measurement uncertainty to ensure 95% confidence level for the normal distribution is with the coverage factor $k = 2$, $U = 624\text{Hz}$.

Test Result

Variant

| Mode | Modulation | Sub-carrier spacing (kHz) | Ntones | Bandwidth(KHz) for low/mid/high channel | | | | | |
|--------------------------------|------------|---------------------------|--------|---|--------|-----------------|--------|-----------------|--------|
| | | | | 18602/1850.2MHz | | 18900/1880.0MHz | | 19198/1909.8MHz | |
| | | | | 99% Power | -26dBc | 99% Power | -26dBc | 99% Power | -26dBc |
| NB-IOT Band 2 Standalone | BPSK | 3.75 | 1@0 | 55.36 | 38.10 | 54.62 | 38.00 | 52.90 | 37.27 |
| | QPSK | 3.75 | 1@0 | 62.81 | 39.72 | 62.36 | 41.56 | 60.94 | 39.51 |
| | BPSK | 15 | 1@0 | 130.98 | 104.20 | 142.05 | 116.70 | 131.50 | 102.10 |
| | QPSK | 15 | 1@0 | 125.22 | 117.30 | 128.84 | 116.60 | 126.64 | 115.90 |
| | QPSK | 15 | 12@0 | 183.24 | 237.50 | 182.36 | 232.90 | 182.46 | 250.20 |

| Mode | Modulation | Sub-carrier spacing (kHz) | Ntones | Bandwidth(KHz) for low/mid/high channel | | | | | |
|---------------------------------|------------|---------------------------|--------|---|--------|-----------------|--------|-----------------|--------|
| | | | | 26042/1850.2MHz | | 26365/1882.5MHz | | 26688/1914.8MHz | |
| | | | | 99% Power | -26dBc | 99% Power | -26dBc | 99% Power | -26dBc |
| NB-IOT Band 25 Standalone | BPSK | 3.75 | 1@0 | 66.62 | 38.21 | 72.64 | 38.14 | 67.09 | 37.90 |
| | QPSK | 3.75 | 1@0 | 73.83 | 41.25 | 78.70 | 39.53 | 72.56 | 39.44 |
| | BPSK | 15 | 1@0 | 133.26 | 117.10 | 134.88 | 119.60 | 133.28 | 103.80 |
| | QPSK | 15 | 1@0 | 122.22 | 117.40 | 126.96 | 103.2 | 132.24 | 117.00 |
| | QPSK | 15 | 12@0 | 185.88 | 255.20 | 183.35 | 256.80 | 184.13 | 239.10 |

NB-IOT Band 2 BPSK 3.75kHz 1@0 CH-Low

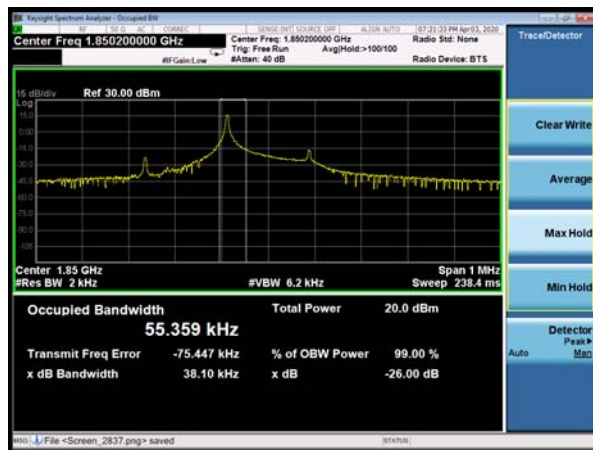

NB-IOT Band 2 BPSK 15kHz 1@0 CH-Low



NB-IOT Band 2 BPSK 3.75kHz 1@0 CH-Middle

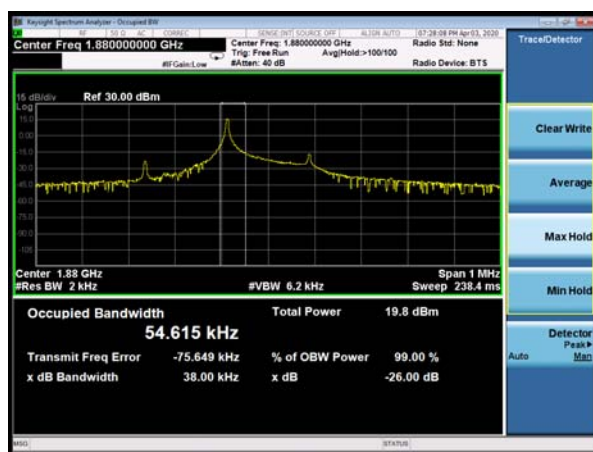

NB-IOT Band 2 BPSK 15kHz 1@0 CH-Middle



NB-IOT Band 2 BPSK 3.75kHz 1@0 CH-High

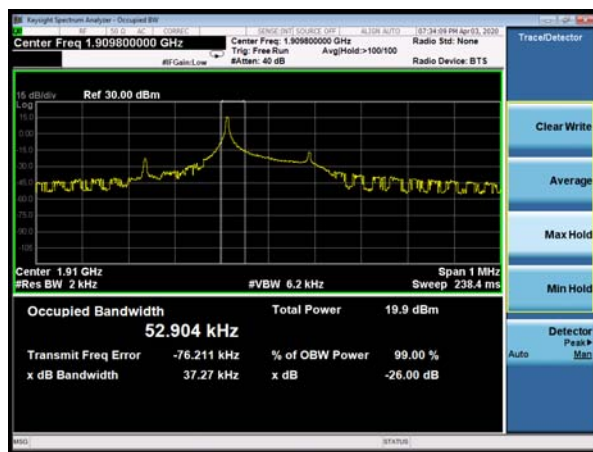

NB-IOT Band 2 BPSK 15kHz 1@0 CH-High





NB-IOT Band 2 QPSK 3.75kHz 1@0 CH-Low



NB-IOT Band 2 QPSK 15kHz 1@0 CH-Low



NB-IOT Band 2 QPSK 3.75kHz 1@0 CH-Middle

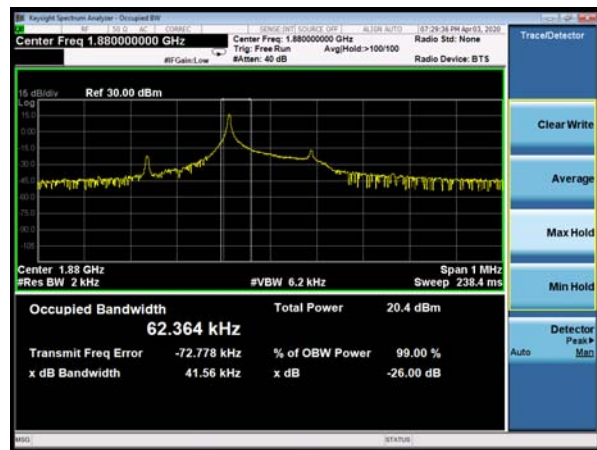

NB-IOT Band 2 QPSK 15kHz 1@0 CH-Middle



NB-IOT Band 2 QPSK 3.75kHz 1@0 CH-High



NB-IOT Band 2 QPSK 15kHz 1@0 CH-High



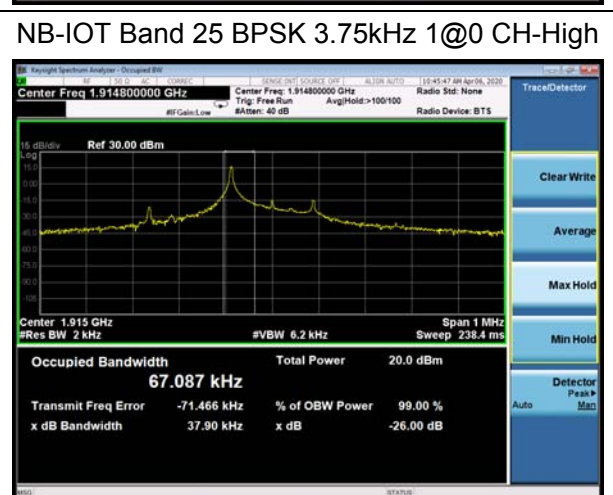
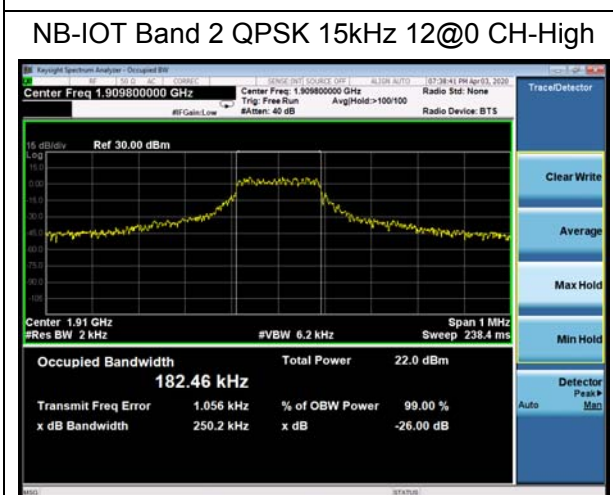
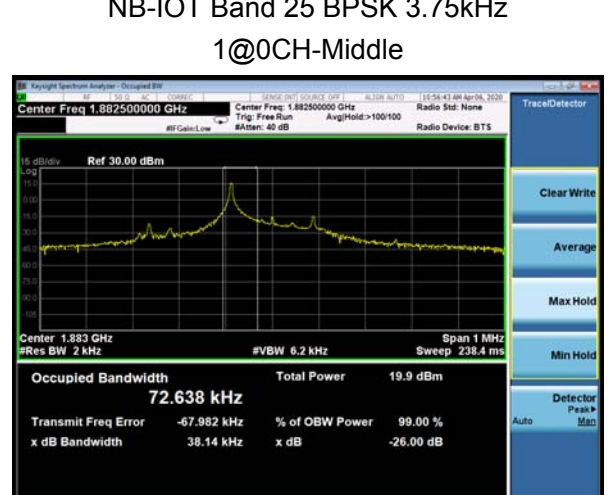
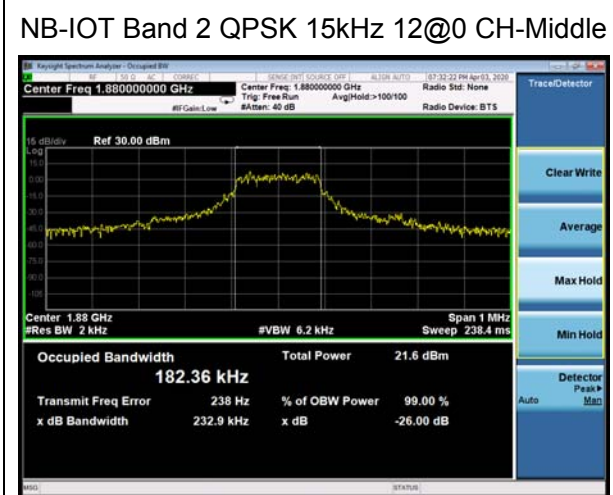
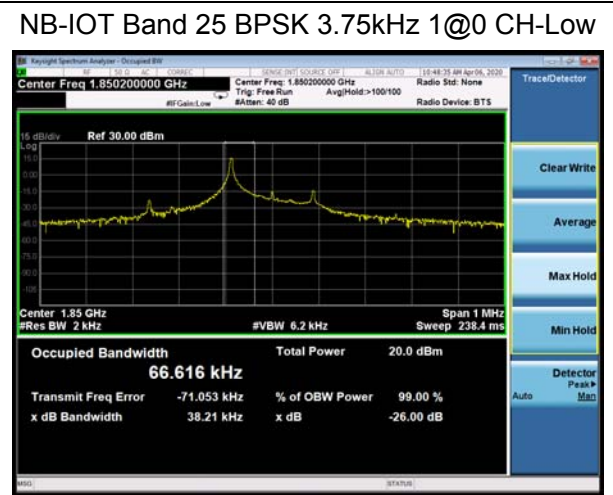
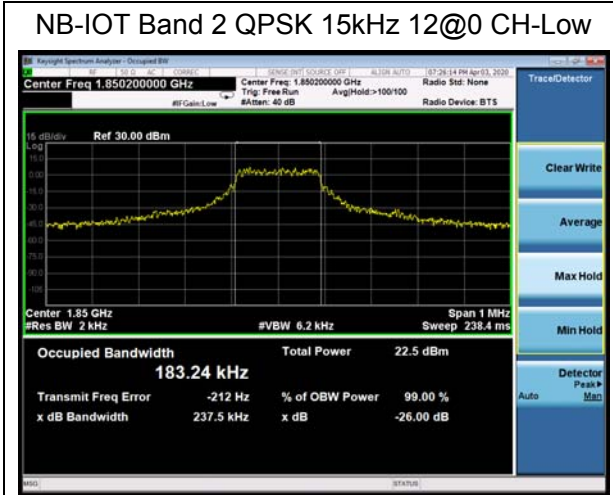

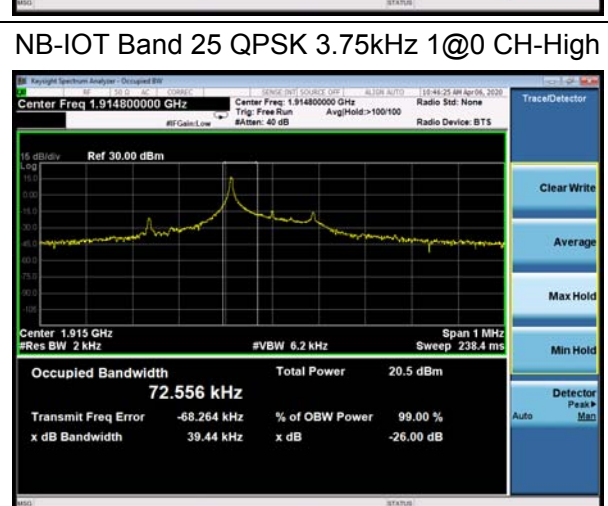
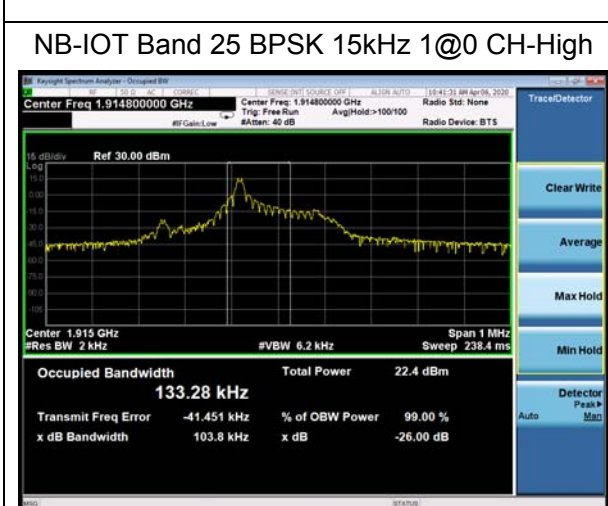
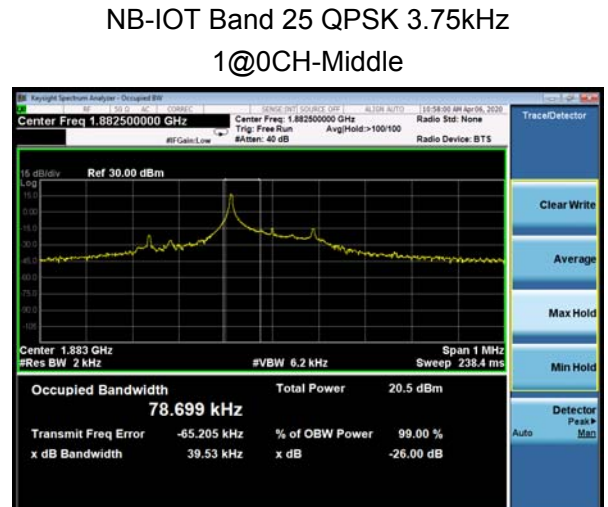
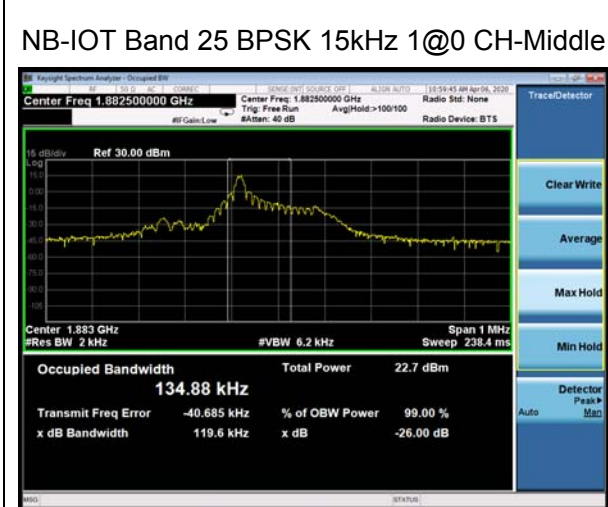
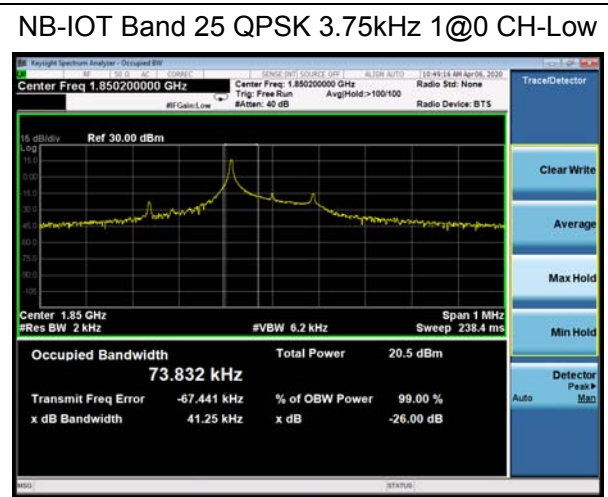
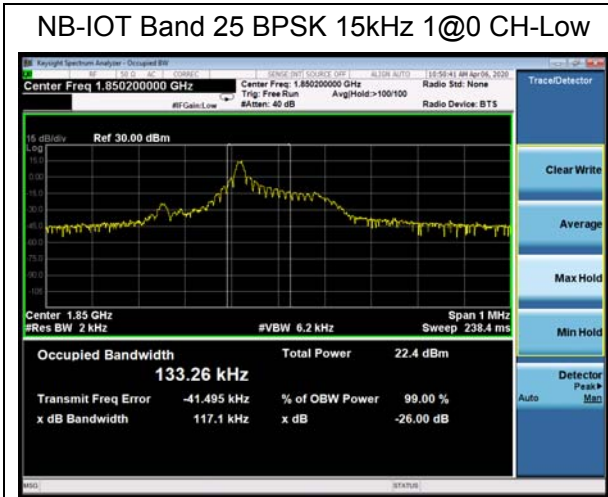

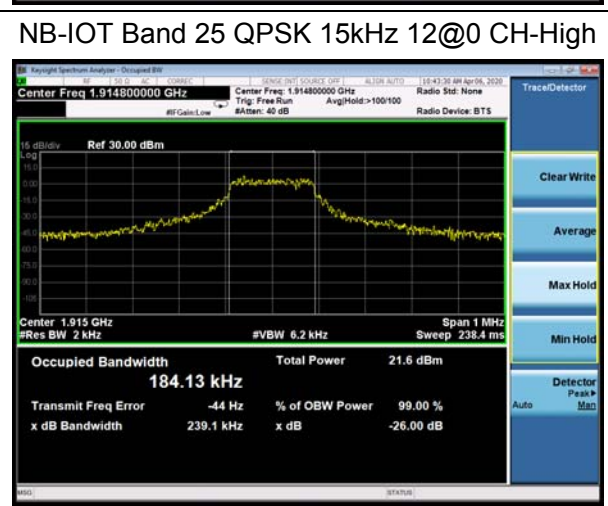
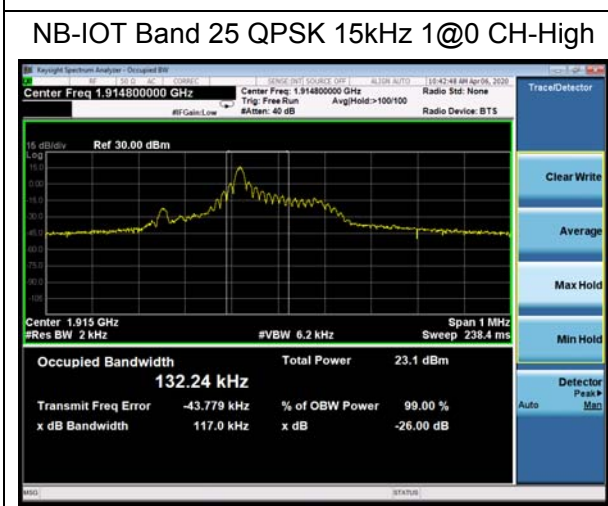
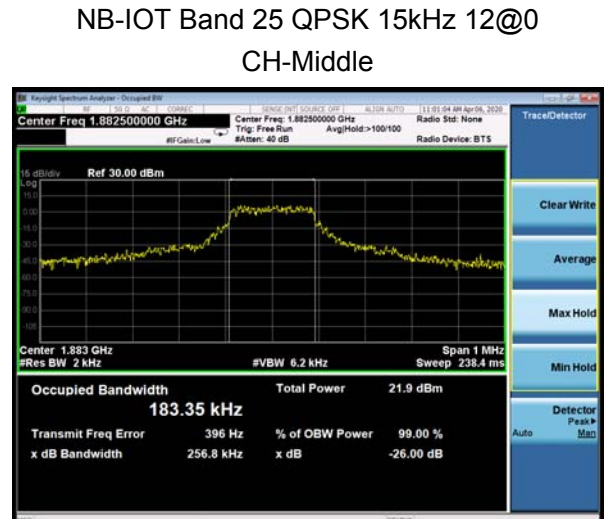
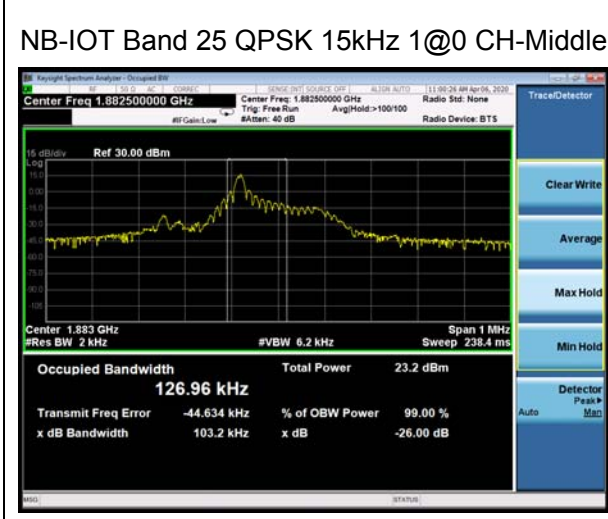
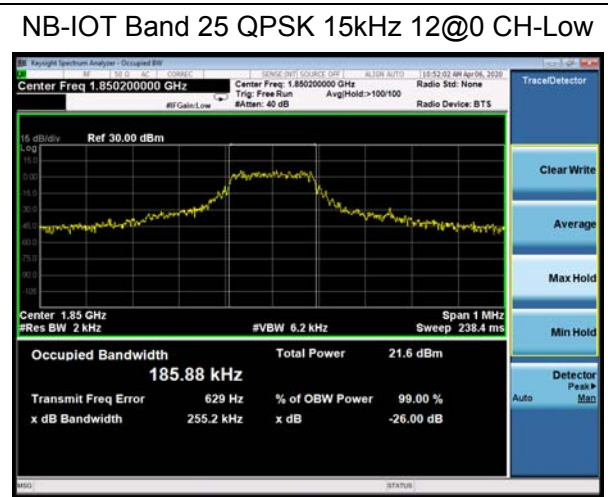
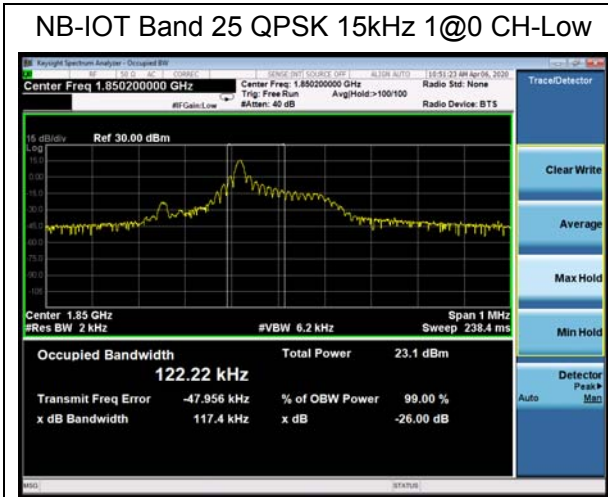

5.3. Band Edge Compliance

Ambient condition

| Temperature | Relative humidity | Pressure |
|-------------|-------------------|----------|
| 23°C ~25°C | 45%~50% | 101.5kPa |

Method of Measurement

The EUT was connected to Spectrum Analyzer and Base Station Simulator via power Splitter. The band edge of the lowest and highest channels were measured. The Average detector is used and RBW is set to $\geq 1\%EBW$, VBW is set to 3x RBW.

Spectrum analyzer plots are included on the following pages.

Test Setup

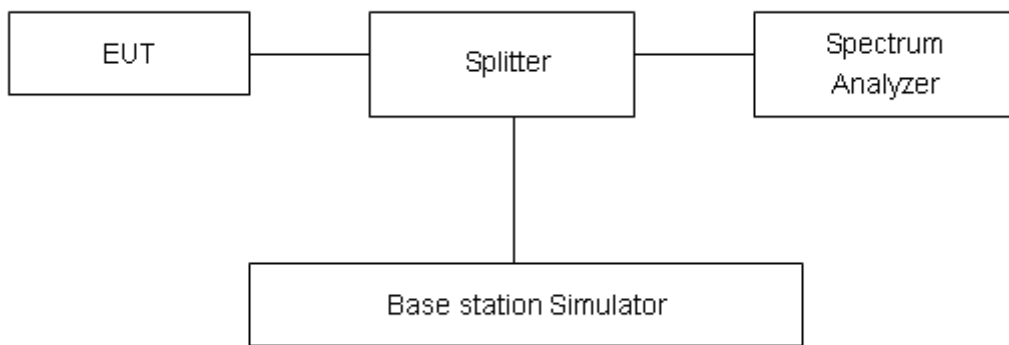

Limits

Rule Part 24.238(a) specifies that “on any frequency outside a licensee’s frequency block, the power of any emission shall be attenuated below the transmitter power (P) by at least $43 + 10 \log_{10} (P)$ dB.”

| | |
|-------|---------|
| Limit | -13 dBm |
|-------|---------|

Measurement Uncertainty

The assessed measurement uncertainty to ensure 95% confidence level for the normal distribution is with the coverage factor $k = 1.96$, $U=0.684dB$.

Test Result:

Variant

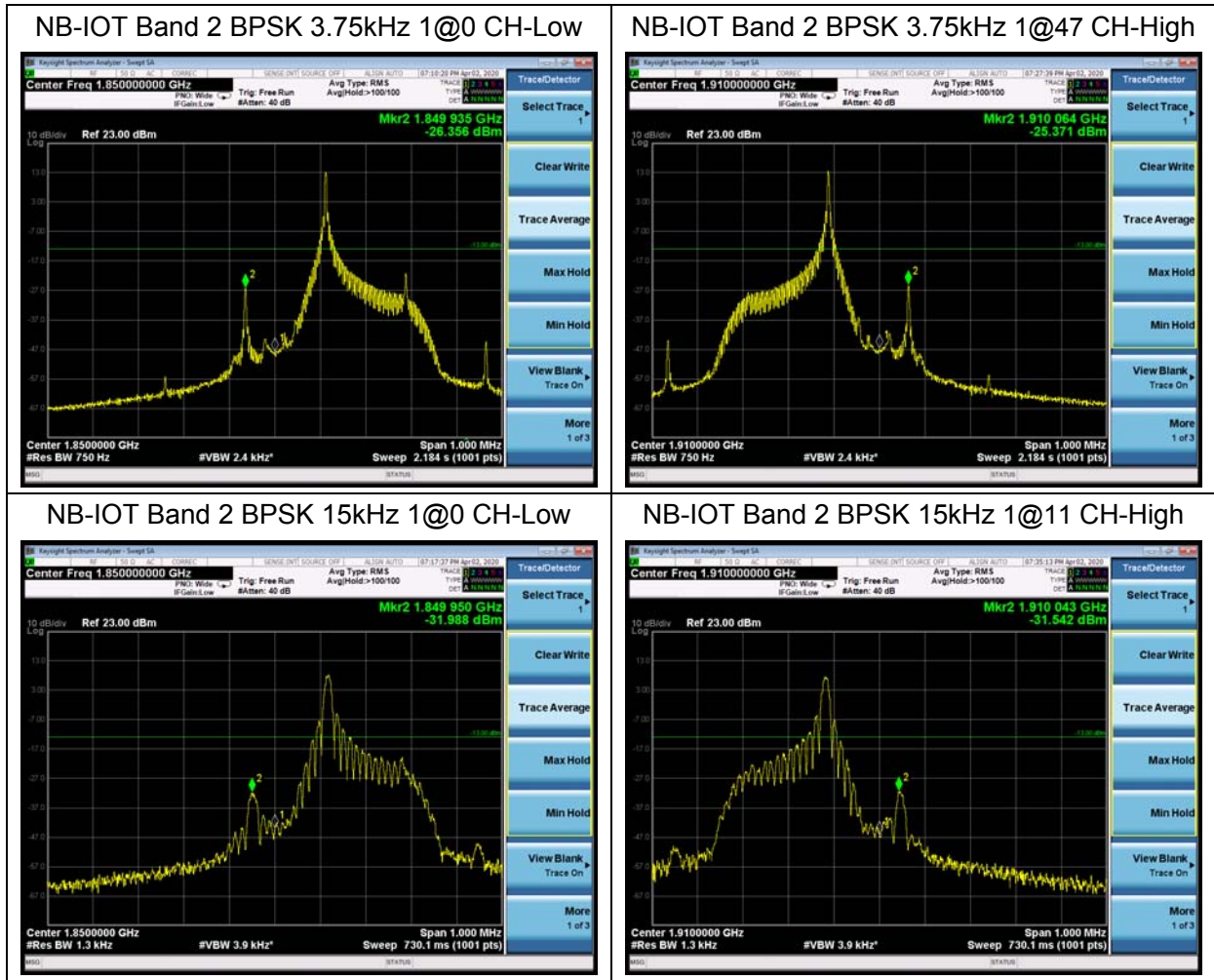

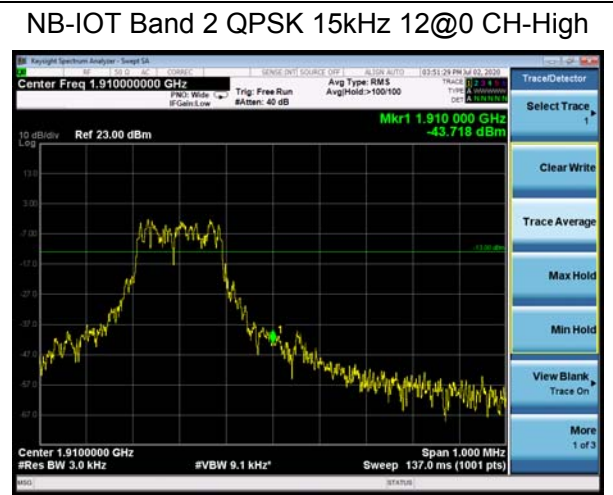
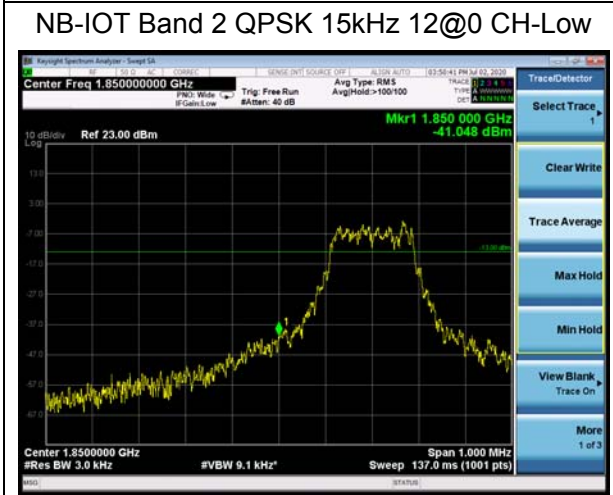
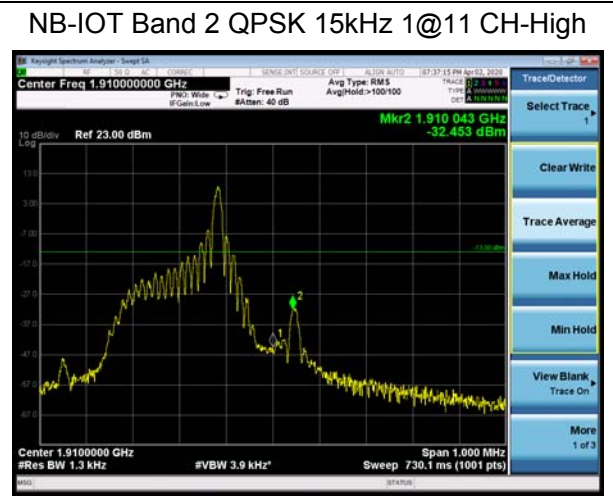
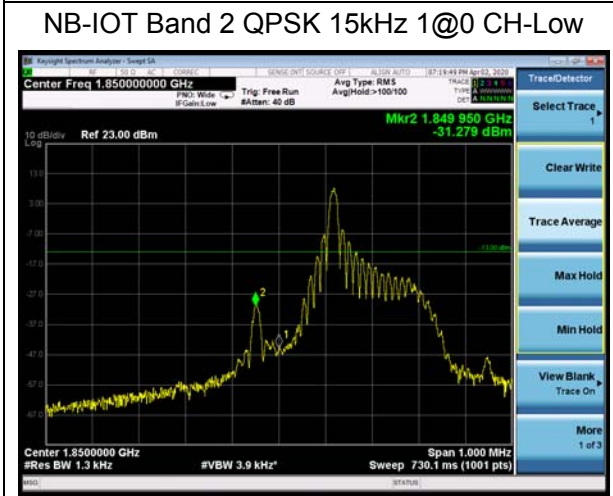
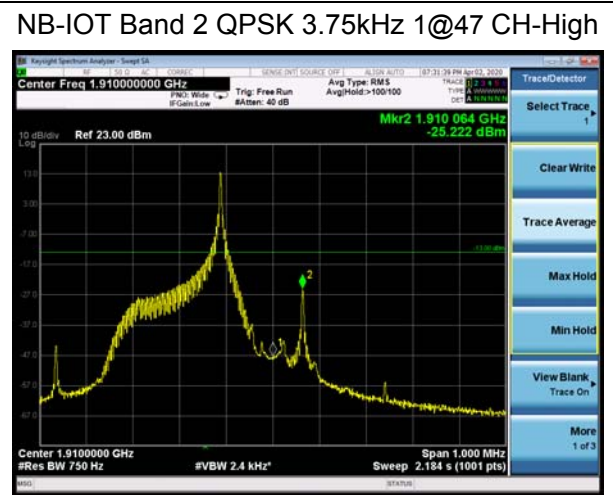
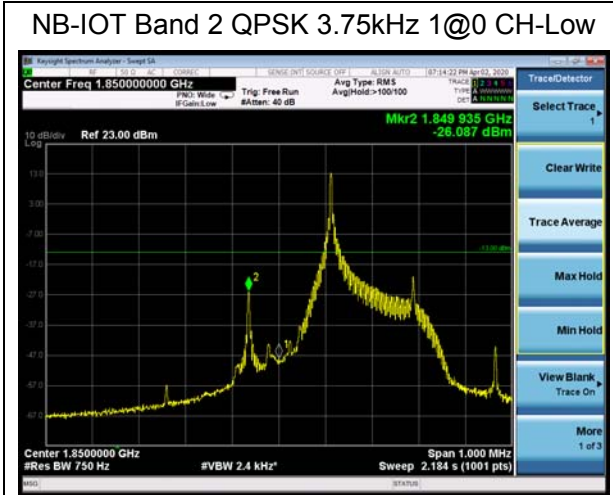

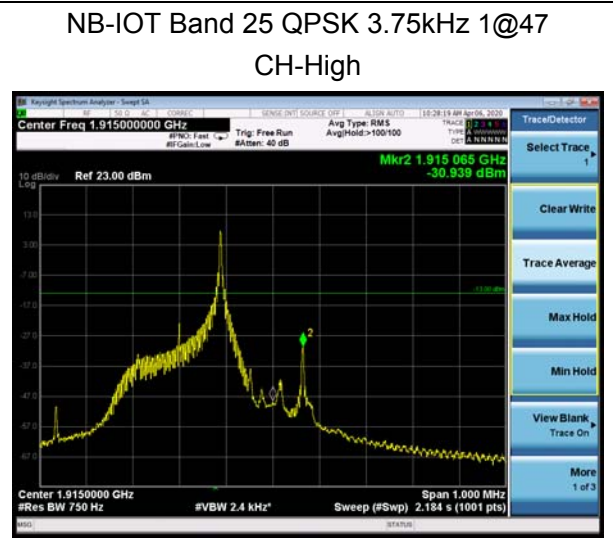
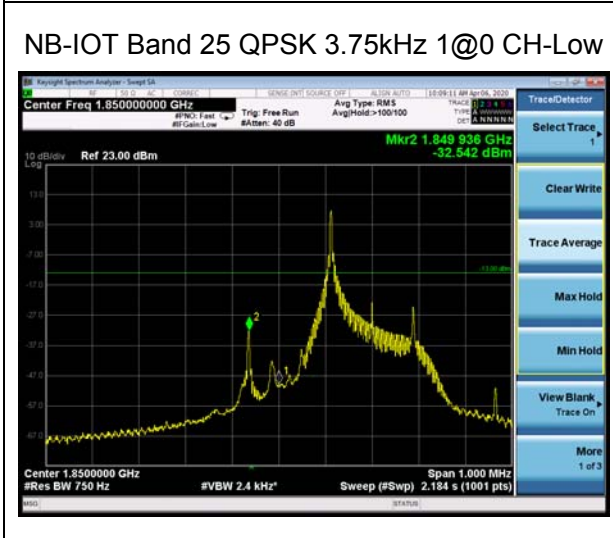
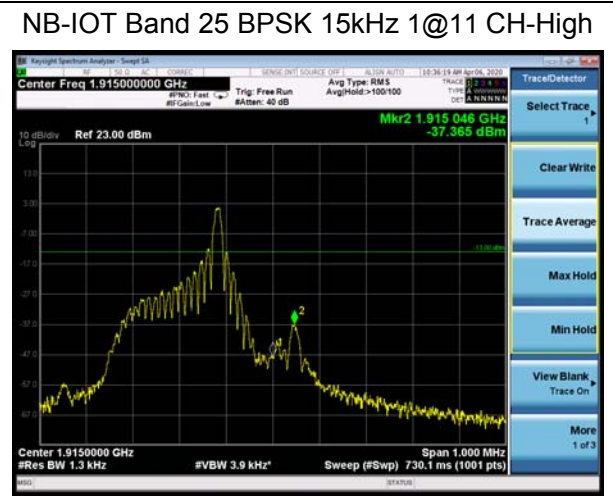
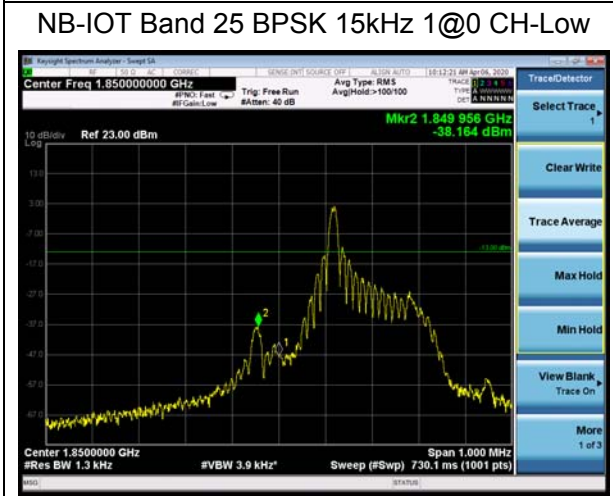
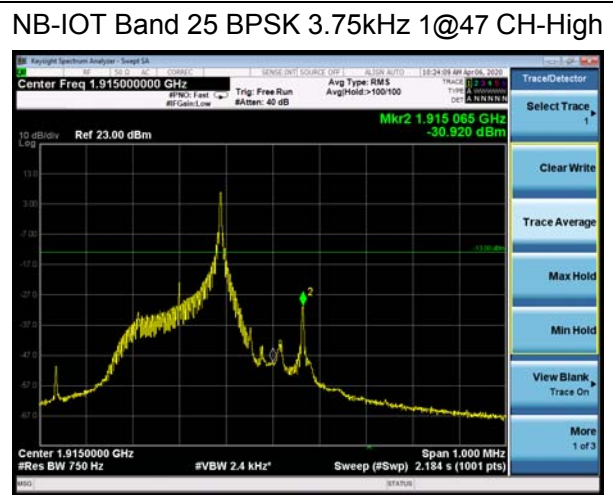
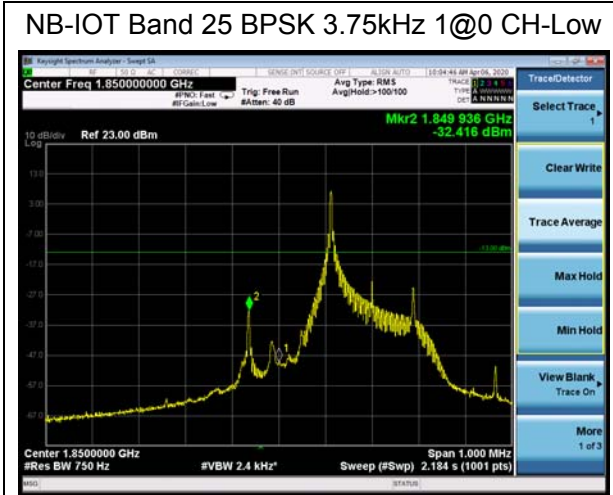

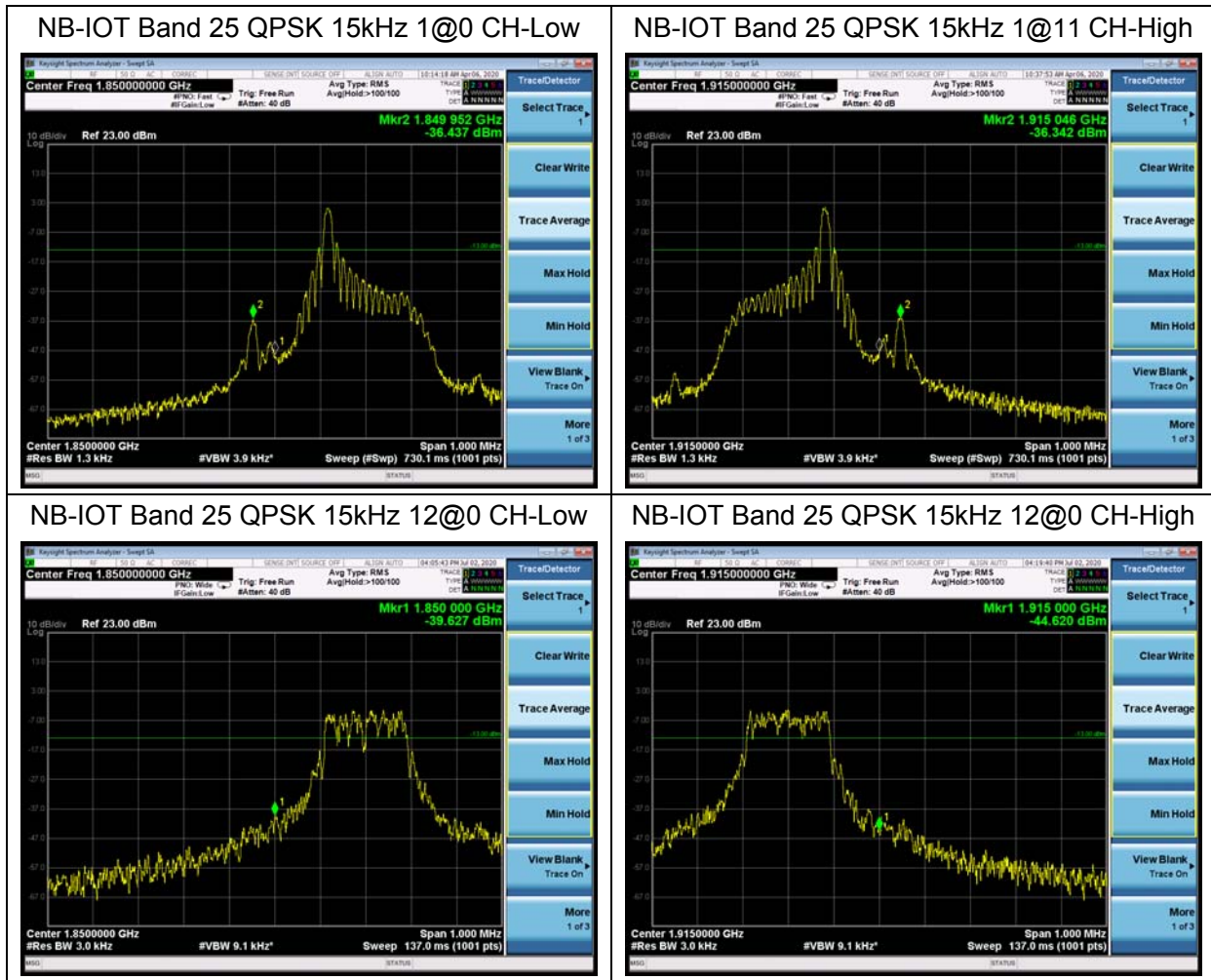

5.4. Peak-to-Average Power Ratio (PAPR)

Ambient condition

| Temperature | Relative humidity | Pressure |
|-------------|-------------------|----------|
| 23°C ~25°C | 45%~50% | 101.5kPa |

Methods of Measurement

Measure the total peak power and record as PPk. And measure the total average power and record as PAvg. Both the peak and average power levels must be expressed in the same logarithmic units (e.g., dBm). Determine the PAPR from:

$$PAPR (dB) = PPk (dBm) - PAvg (dBm).$$

Test Setup

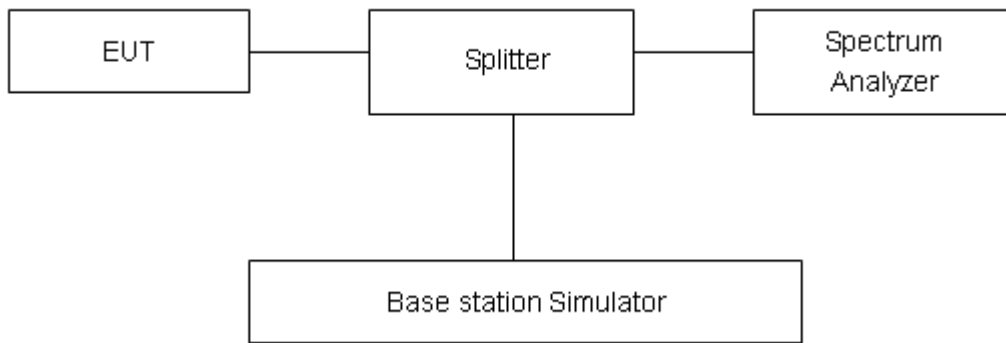

Limits

In measuring transmissions in this band using an average power technique, the peak-to-average ratio (PAR) of the transmission may not exceed 13 dB in 24.232(d).

Measurement Uncertainty

The assessed measurement uncertainty to ensure 95% confidence level for the normal distribution is with the coverage factor $k = 2$, $U = 0.4$ dB.

Test Results

Original

| NB-IOT Band 2 Standalone | | | | | | | |
|--------------------------|---------------------------|-------------------------|------------|-----------|-----------|------------|------------|
| Modulation | Sub-carrier spacing (kHz) | Channel/Frequency (MHz) | Peak (dBm) | Avg (dBm) | PAPR (dB) | Limit (dB) | Conclusion |
| BPSK | 3.75 | 18900/1880.0 | 25.61 | 22.34 | 3.27 | ≤13 | PASS |
| QPSK | 3.75 | 18900/1880.0 | 28.77 | 22.40 | 6.37 | ≤13 | PASS |
| BPSK | 15 | 18900/1880.0 | 25.72 | 22.45 | 3.27 | ≤13 | PASS |
| QPSK | 15 | 18900/1880.0 | 28.70 | 22.42 | 6.28 | ≤13 | PASS |

| NB-IOT Band 25 Standalone | | | | | | | |
|---------------------------|---------------------------|-------------------------|------------------------------------|----------|----------|------------|------------|
| Modulation | Sub-carrier spacing (kHz) | Channel/Frequency (MHz) | Peak-to-Average Power Ratio (PAPR) | | | Limit (dB) | Conclusion |
| | | | Peak(dBm) | Avg(dBm) | PAPR(dB) | | |
| BPSK | 3.75 | 26341/1880.1 | 24.17 | 20.38 | 3.79 | ≤13 | PASS |
| QPSK | 3.75 | 26341/1880.1 | 23.55 | 20.20 | 3.35 | ≤13 | PASS |
| BPSK | 15 | 26341/1880.1 | 23.87 | 17.48 | 6.39 | ≤13 | PASS |
| QPSK | 15 | 26341/1880.1 | 24.26 | 17.67 | 6.59 | ≤13 | PASS |

5.5. Frequency Stability

Ambient condition

| Temperature | Relative humidity | Pressure |
|-------------|-------------------|----------|
| 23°C ~25°C | 45%~50% | 101.5kPa |

Method of Measurement

1. Frequency Stability (Temperature Variation)

The temperature inside the climate chamber is varied from -40°C to +85°C in 10°C step size,

(1) With all power removed, the temperature was decreased to 0°C and permitted to stabilize for three hours.

(2) Measure the carrier frequency with the test equipment in a “call mode”. These measurements should be made within 1 minute of powering up the mobile station, to prevent significant self warming.

(3) Repeat the above measurements at 10°C increments from -40°C to +85°C. Allow at least 1.5 hours at each temperature, un-powered, before making measurements.

2. Frequency Stability (Voltage Variation)

The frequency stability shall be measured with variation of primary supply voltage as follows:

(1) Vary primary supply voltage from 85 to 115 percent of the nominal value for other than hand carried battery equipment.

(2) For hand carried, battery powered equipment, reduce primary supply voltage to the battery-operating end point which shall be specified by the manufacturer.

This transceiver is specified to operate with an input voltage of between 3.3 V and 4.3 V, with a nominal voltage of 3.8V.

Test setup

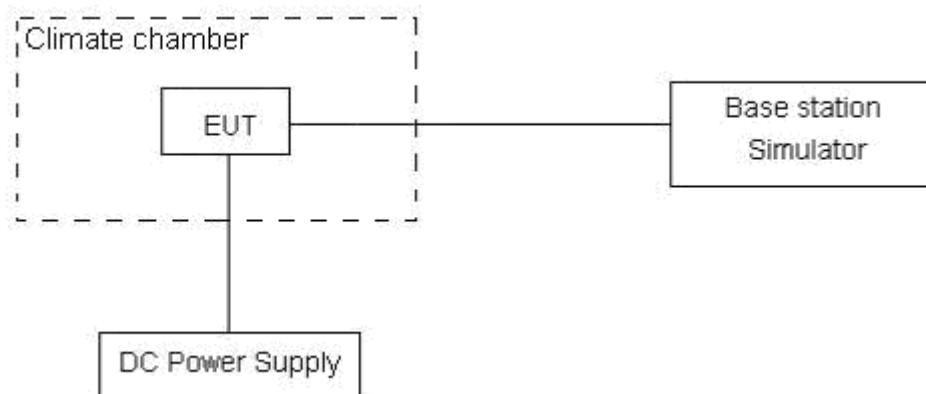



Limits

No specific frequency stability requirements in part 24.235

Measurement Uncertainty

The assessed measurement uncertainty to ensure 99.75% confidence level for the normal distribution is with the coverage factor $k = 3$, $U = 0.01\text{ppm}$.

Test Result

Variant

| NB-IOT Band 2 | | | | | | |
|---------------------------|---------|-----------------|-----------------|---------------------------|---------------------------|---------|
| Condition | | Freq.Error (Hz) | Freq.Error (Hz) | Frequency Stability (ppm) | Frequency Stability (ppm) | Verdict |
| Sub-carrier spacing (kHz) | 3.75 | BPSK | QPSK | BPSK | QPSK | |
| Temperature | Voltage | BPSK | QPSK | BPSK | QPSK | |
| Normal (25°C) | Normal | 16.55 | 4.77 | 0.00880 | 0.00254 | PASS |
| Extreme (85°C) | | 16.86 | 7.76 | 0.00897 | 0.00413 | PASS |
| Extreme (80°C) | | 14.64 | 9.15 | 0.00779 | 0.00487 | PASS |
| Extreme (70°C) | | 7.81 | 7.97 | 0.00415 | 0.00424 | PASS |
| Extreme (60°C) | | 12.76 | 2.06 | 0.00679 | 0.00110 | PASS |
| Extreme (50°C) | | 17.23 | 10.16 | 0.00916 | 0.00540 | PASS |
| Extreme (40°C) | | 14.22 | 13.03 | 0.00757 | 0.00693 | PASS |
| Extreme (30°C) | | 8.63 | 9.40 | 0.00459 | 0.00500 | PASS |
| Extreme (20°C) | | 7.87 | 10.54 | 0.00419 | 0.00560 | PASS |
| Extreme (10°C) | | 1.38 | 16.13 | 0.00073 | 0.00858 | PASS |
| Extreme (0°C) | | 17.30 | 16.68 | 0.00920 | 0.00887 | PASS |
| Extreme (-10°C) | | 11.78 | 15.75 | 0.00627 | 0.00838 | PASS |
| Extreme (-20°C) | | 10.65 | 5.50 | 0.00566 | 0.00292 | PASS |
| Extreme (-30°C) | | 7.74 | 1.06 | 0.00411 | 0.00056 | PASS |
| Extreme (-40°C) | | 4.83 | 16.65 | 0.00257 | 0.00886 | PASS |
| 25°C | LV | 10.79 | 11.64 | 0.00574 | 0.00619 | PASS |
| | HV | 7.61 | 15.45 | 0.00405 | 0.00822 | PASS |
| Condition | | Freq.Error (Hz) | Freq.Error (Hz) | Frequency Stability (ppm) | Frequency Stability (ppm) | Verdict |
| Sub-carrier spacing (kHz) | 15 | BPSK | QPSK | BPSK | QPSK | |
| Temperature | Voltage | BPSK | QPSK | BPSK | QPSK | |
| Normal (25°C) | Normal | 1.30 | 5.71 | 0.00069 | 0.00304 | PASS |
| Extreme (85°C) | | 16.40 | 16.23 | 0.00872 | 0.00863 | PASS |
| Extreme (80°C) | | 9.48 | 12.99 | 0.00504 | 0.00691 | PASS |
| Extreme (70°C) | | 1.67 | 13.14 | 0.00089 | 0.00699 | PASS |
| Extreme (60°C) | | 14.37 | 12.76 | 0.00764 | 0.00679 | PASS |
| Extreme (50°C) | | 8.89 | 2.93 | 0.00473 | 0.00156 | PASS |
| Extreme (40°C) | | 13.63 | 9.29 | 0.00725 | 0.00494 | PASS |
| Extreme (30°C) | | 14.55 | 5.86 | 0.00774 | 0.00311 | PASS |
| Extreme (20°C) | | 13.61 | 12.90 | 0.00724 | 0.00686 | PASS |
| Extreme (10°C) | | 2.83 | 9.31 | 0.00150 | 0.00495 | PASS |
| Extreme (0°C) | | 2.25 | 2.51 | 0.00120 | 0.00133 | PASS |



| | | | | | | |
|-----------------|----|-------|-------|---------|---------|------|
| Extreme (-10°C) | | 16.20 | 7.14 | 0.00862 | 0.00380 | PASS |
| Extreme (-20°C) | | 10.68 | 12.30 | 0.00568 | 0.00655 | PASS |
| Extreme (-30°C) | | 7.53 | 10.94 | 0.00400 | 0.00582 | PASS |
| Extreme (-40°C) | | 3.47 | 7.79 | 0.00184 | 0.00414 | PASS |
| 25°C | LV | 5.78 | 7.92 | 0.00307 | 0.00421 | PASS |
| | HV | 10.80 | 2.73 | 0.00575 | 0.00145 | PASS |

| NB-IOT Band 25 | | | | | | |
|---------------------------|---------|-----------------|-----------------|---------------------------|---------------------------|---------|
| Condition | | Freq.Error (Hz) | Freq.Error (Hz) | Frequency Stability (ppm) | Frequency Stability (ppm) | Verdict |
| Sub-carrier spacing (kHz) | 3.75 | BPSK | QPSK | BPSK | QPSK | |
| Temperature | Voltage | BPSK | QPSK | BPSK | QPSK | |
| Normal (25°C) | Normal | 12.12 | 3.13 | 0.00645 | 0.00167 | PASS |
| Extreme (85°C) | | 2.65 | 1.63 | 0.00141 | 0.00087 | PASS |
| Extreme (80°C) | | 6.03 | 7.78 | 0.00321 | 0.00414 | PASS |
| Extreme (70°C) | | 11.64 | 8.41 | 0.00619 | 0.00448 | PASS |
| Extreme (60°C) | | 14.51 | 11.32 | 0.00772 | 0.00602 | PASS |
| Extreme (50°C) | | 14.63 | 9.63 | 0.00778 | 0.00512 | PASS |
| Extreme (40°C) | | 17.19 | 13.94 | 0.00914 | 0.00742 | PASS |
| Extreme (30°C) | | 2.42 | 5.08 | 0.00129 | 0.00270 | PASS |
| Extreme (20°C) | | 11.10 | 10.37 | 0.00590 | 0.00551 | PASS |
| Extreme (10°C) | | 3.90 | 10.54 | 0.00207 | 0.00561 | PASS |
| Extreme (0°C) | | 1.19 | 9.32 | 0.00063 | 0.00496 | PASS |
| Extreme (-10°C) | | 17.12 | 14.38 | 0.00911 | 0.00765 | PASS |
| Extreme (-20°C) | | 12.59 | 2.13 | 0.00670 | 0.00113 | PASS |
| Extreme (-30°C) | | 14.78 | 17.68 | 0.00786 | 0.00940 | PASS |
| Extreme (-40°C) | | 5.19 | 10.00 | 0.00276 | 0.00532 | PASS |
| 25°C | LV | 9.05 | 12.33 | 0.00481 | 0.00656 | PASS |
| | HV | 4.69 | 7.55 | 0.00250 | 0.00402 | PASS |
| Condition | | Freq.Error (Hz) | Freq.Error (Hz) | Frequency Stability (ppm) | Frequency Stability (ppm) | Verdict |
| Sub-carrier spacing (kHz) | 15 | BPSK | QPSK | BPSK | QPSK | |
| Temperature | Voltage | BPSK | QPSK | BPSK | QPSK | |
| Normal (25°C) | Normal | 9.34 | 11.82 | 0.00497 | 0.00629 | PASS |
| Extreme (85°C) | | 4.71 | 9.73 | 0.00251 | 0.00518 | PASS |
| Extreme (80°C) | | 7.76 | 5.23 | 0.00413 | 0.00278 | PASS |
| Extreme (70°C) | | 6.05 | 12.45 | 0.00322 | 0.00662 | PASS |
| Extreme (60°C) | | 12.22 | 10.59 | 0.00650 | 0.00563 | PASS |
| Extreme (50°C) | | 12.48 | 12.07 | 0.00664 | 0.00642 | PASS |



| | | | | | | |
|-----------------|----|-------|-------|---------|---------|------|
| Extreme (40°C) | | 6.87 | 4.61 | 0.00365 | 0.00245 | PASS |
| Extreme (30°C) | | 13.23 | 12.41 | 0.00704 | 0.00660 | PASS |
| Extreme (20°C) | | 4.75 | 3.51 | 0.00253 | 0.00187 | PASS |
| Extreme (10°C) | | 15.18 | 9.96 | 0.00807 | 0.00530 | PASS |
| Extreme (0°C) | | 5.28 | 12.54 | 0.00281 | 0.00667 | PASS |
| Extreme (-10°C) | | 10.44 | 1.92 | 0.00555 | 0.00102 | PASS |
| Extreme (-20°C) | | 9.49 | 9.55 | 0.00505 | 0.00508 | PASS |
| Extreme (-30°C) | | 16.33 | 17.52 | 0.00869 | 0.00932 | PASS |
| Extreme (-40°C) | | 13.29 | 14.47 | 0.00707 | 0.00769 | PASS |
| 25°C | LV | 16.51 | 16.08 | 0.00878 | 0.00855 | PASS |
| | HV | 4.01 | 15.96 | 0.00214 | 0.00849 | PASS |

5.6. Spurious Emissions at Antenna Terminals

Ambient condition

| Temperature | Relative humidity | Pressure |
|-------------|-------------------|----------|
| 23°C ~25°C | 45%~50% | 101.5kPa |

Method of Measurement

The EUT was connected to Spectrum Analyzer and Base Station Simulator via power Splitter. The measurement is carried out using a spectrum analyzer. The spectrum analyzer scans from 9kHz to the 10th harmonic of the carrier. The peak detector is used.

RBW is set to 100kHz, VBW is set to 300kHz for 30MHz~1GHz

RBW is set to 1MHz, VBW is set to 3MHz for above 1GHz, Sweep is set to ATUO.

The modulation mode and RB allocation refer to section 5.1, using the maximum output power configuration.

Test setup

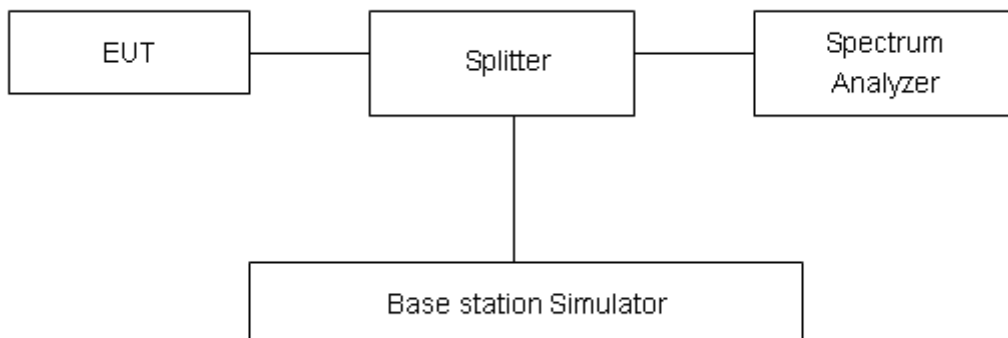

Limits

Rule Part 24.238(a) specifies that “on any frequency outside a licensee's frequency block, the power of any emission shall be attenuated below the transmitter power (P) by at least 43 + 10 log₁₀ (P) dB.”

| | |
|-------|---------|
| Limit | -13 dBm |
|-------|---------|

Measurement Uncertainty

The assessed measurement uncertainty to ensure 99.75% confidence level for the normal distribution is with the coverage factor $k = 1.96$.

| Frequency | Uncertainty |
|------------|-------------|
| 9kHz-1GHz | 0.684 dB |
| 1GHz-20GHz | 1.407 dB |

Test Result

Sweep the whole frequency band through the range from 9kHz to the 10th harmonic of the carrier, the emissions more than 20 dB below the limit are not reported.

The signal beyond the limit is carrier.

Variant

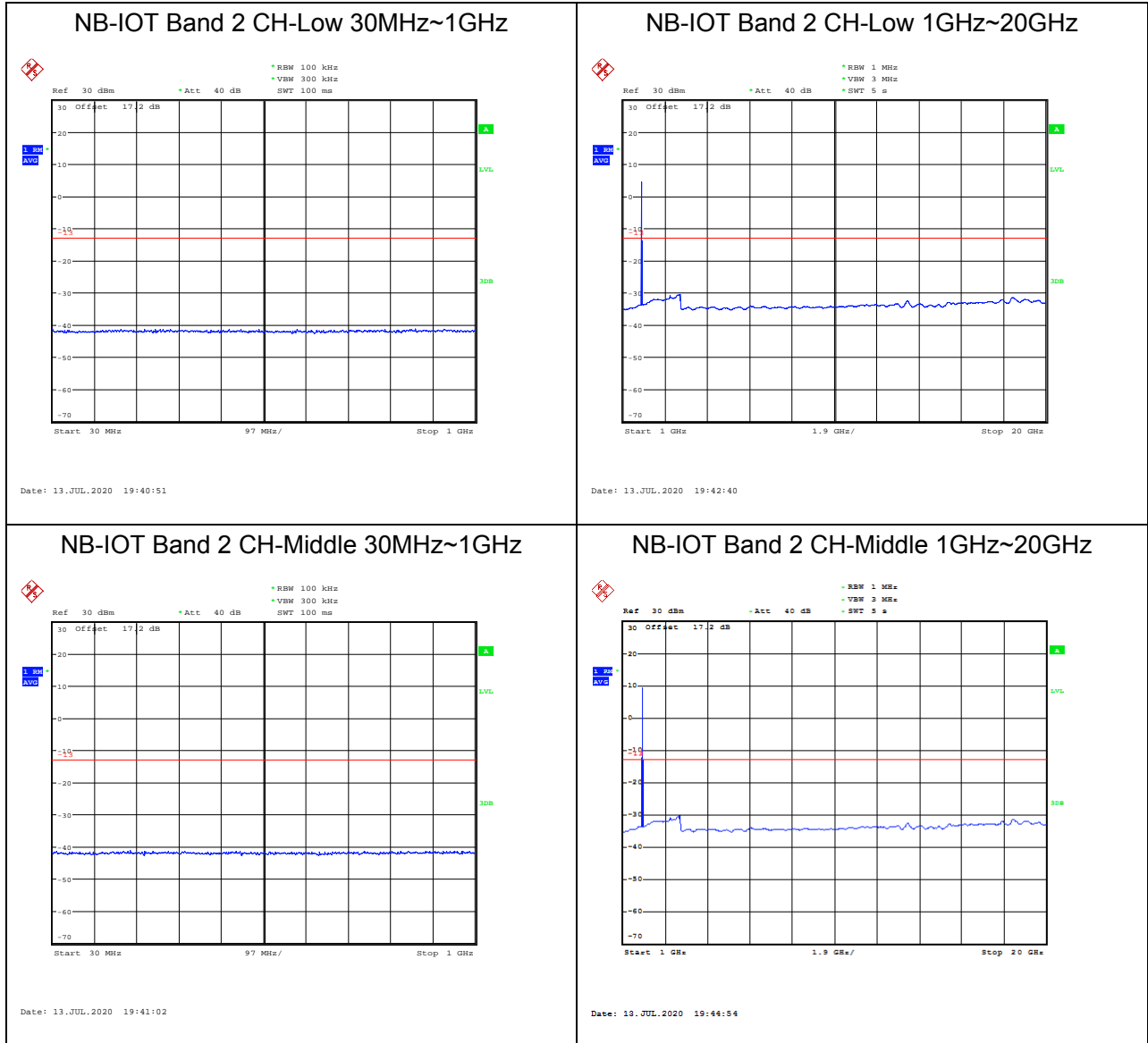



NB-IOT Band 2 CH-High 30MHz~1GHz

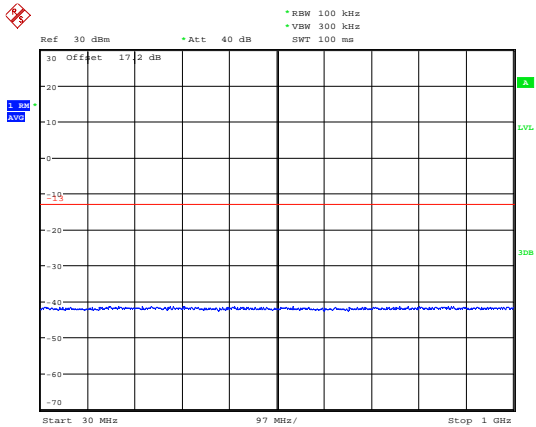

Date: 13.JUL.2020 19:41:31

NB-IOT Band 2 CH-High 1GHz~20GHz

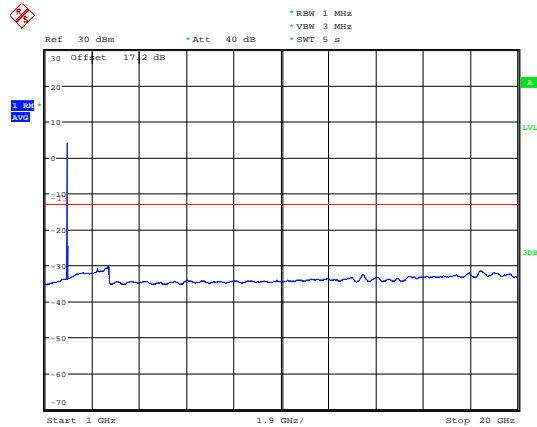

Date: 13.JUL.2020 19:45:44

NB-IOT Band 25 CH-Low 30MHz~1GHz

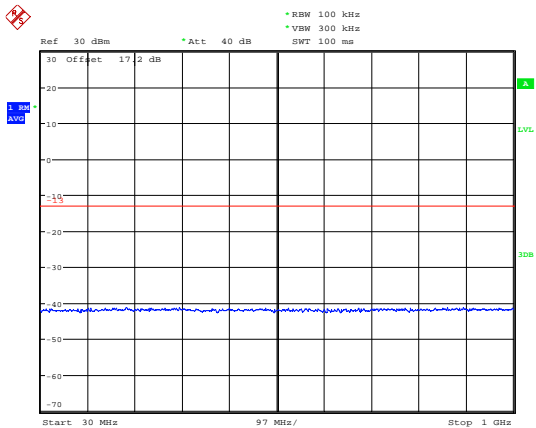

Date: 13.JUL.2020 21:04:25

NB-IOT Band 25 CH-Low 1GHz~20GHz

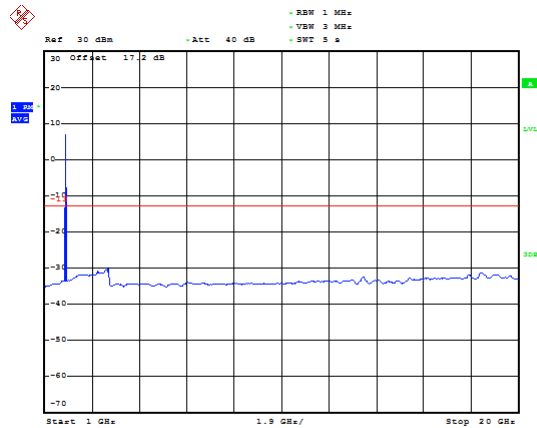

Date: 13.JUL.2020 21:06:13

NB-IOT Band 25 CH-Middle 30MHz~1GHz

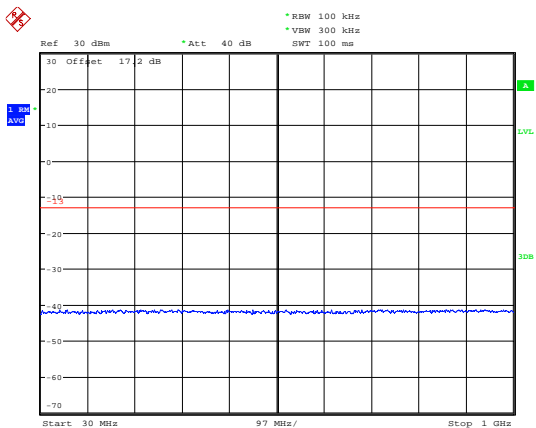

Date: 13.JUL.2020 21:04:35

NB-IOT Band 25 CH-Middle 1GHz~20GHz

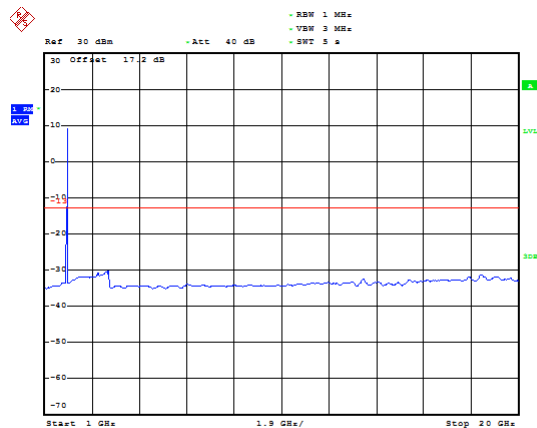

Date: 13.JUL.2020 21:09:37



NB-IOT Band 25 CH-High 30MHz~1GHz

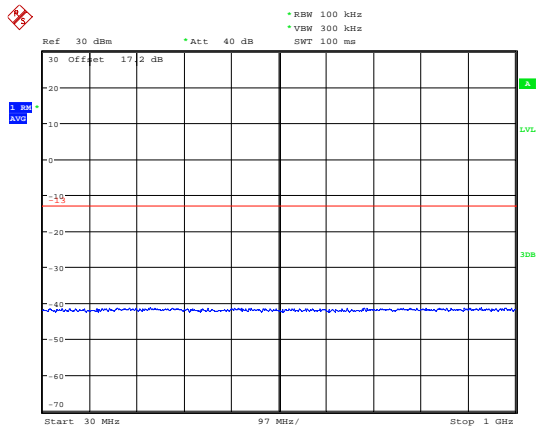

Date: 13.JUL.2020 21:04:45

NB-IOT Band 25 CH-High 1GHz~20GHz

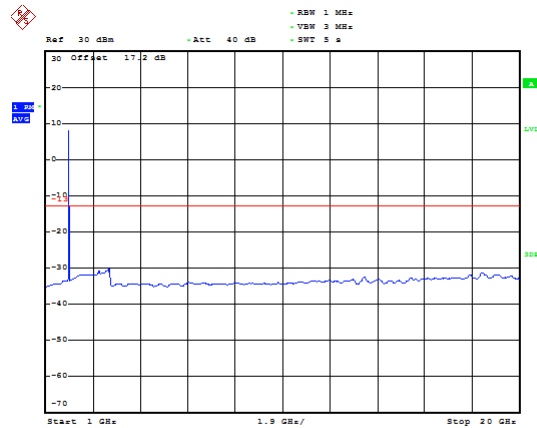

Date: 13.JUL.2020 21:11:11

5.7. Radiates Spurious Emission

Ambient condition

| Temperature | Relative humidity | Pressure |
|-------------|-------------------|----------|
| 23°C ~25°C | 45%~50% | 101.5kPa |

Method of Measurement

1. The testing follows FCC KDB 971168 v03r01 Section 5.8 and ANSI C63.26 (2015).
2. Below 1GHz: The EUT is placed on a turntable 0.8 meters above the ground in the chamber, 3 meter away from the antenna. The maximal emission value is acquired by adjusting the antenna height, polarisation and turntable azimuth. Normally, the height range of antenna is 1 m to 4 m, the azimuth range of turntable is 0° to 360°, and the receive antenna has two polarizations Vertical (V) and Horizontal (H). Above 1GHz: (Note: the FCC's permission to use 1.5m as an alternative per TCBC Conf call of Dec. 2, 2014.) The EUT is placed on a turntable 1.5 meters above the ground in the chamber, 3 meter away from the antenna. The maximal emission value is acquired by adjusting the antenna height, polarisation and turntable azimuth. Normally, the height range of antenna is 1 m to 4 m, the azimuth range of turntable is 0° to 360°, and the receive antenna has two polarizations Vertical (V) and Horizontal (H).
3. A loop antenna, A log-periodic antenna or horn antenna shall be substituted in place of the EUT. The log-periodic antenna will be driven by a signal generator and the level will be adjusted till the same power value on the spectrum analyzer or receiver. The level of the spurious emissions can be calculated through the level of the signal generator, cable loss, the gain of the substitution antenna and the reading of the spectrum analyzer or receiver.
4. The EUT is then put into continuously transmitting mode at its maximum power level during the test. Set Test Receiver or Spectrum RBW=200Hz,VBW=600Hz for 9kHz150kHz , RBW=10kHz, VBW=30kHz 150kHz-30MHz , RBW=100kHz,VBW=300kHz for 30MHz to 1GHz and RBW=1MHz, VBW=3MHz for above 1GHz, And the maximum value of the receiver should be recorded as (Pr).
5. The EUT shall be replaced by a substitution antenna. In the chamber, an substitution antenna for the frequency band of interest is placed at the reference point of the chamber. An RF Signal source for the frequency band of interest is connected to the substitution antenna with a cable that has been constructed to not interfere with the radiation pattern of the antenna. A power (PMea) is applied to the input of the substitution antenna, and adjust the level of the signal generator output until the value of the receiver reach the previously recorded (Pr). The power of signal source (PMea) is recorded. The test should be performed by rotating the test item and adjusting the receiving antenna polarization.
6. A amplifier should be connected to the Signal Source output port. And the cable should be connect between the Amplifier and the Substitution Antenna. The cable loss (Pcl) ,the Substitution Antenna Gain (Ga) and the Amplifier Gain (PAg) should be recorded after test.
7. The measurement results are obtained as described below:
Power(EIRP)=PMea- PAg - Pcl + Ga
The measurement results are amend as described below:
Power(EIRP)=PMea- Pcl + Ga
8. This value is EIRP since the measurement is calibrated using an antenna of known gain (2.15 dBi)

and known input power. ERP can be calculated from EIRP by subtracting the gain of the dipole, $ERP = EIRP - 2.15\text{dBi}$.

The modulation mode and RB allocation refer to section 5.1, using the maximum output power configuration.

Test setup

9KHz ~ 30MHz

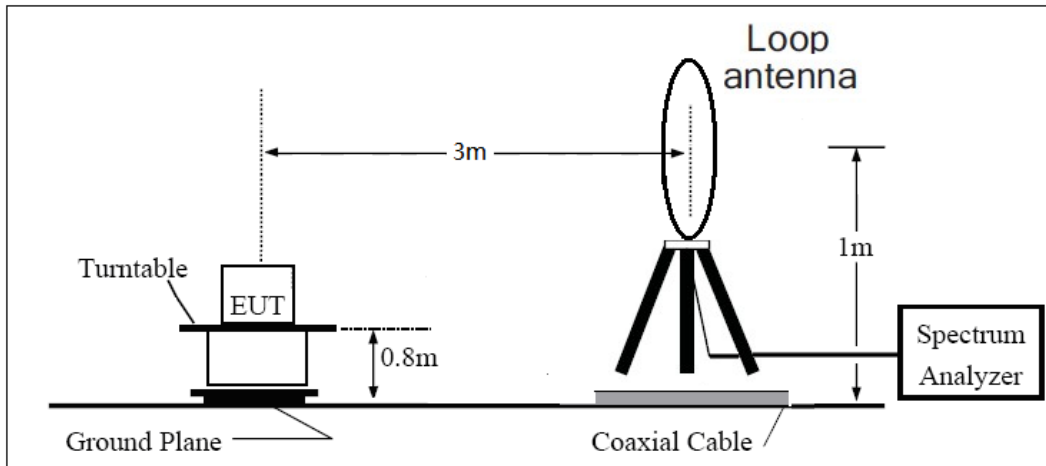

30MHz ~ 1GHz

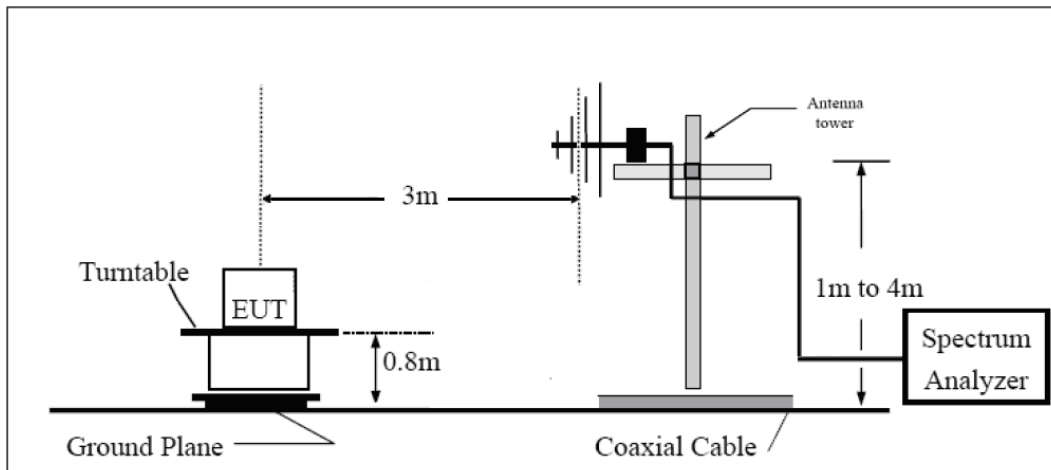

Above 1GHz

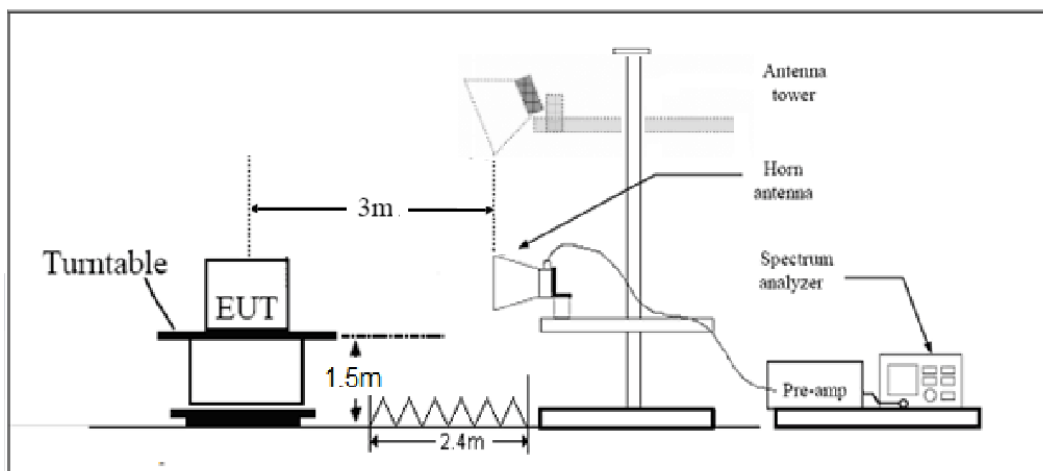



Note: Area side: 2.4mX3.6m

Limits

Rule Part 24.238(a) specifies that “on any frequency outside a licensee's frequency block, the power of any emission shall be attenuated below the transmitter power (P) by at least $43 + 10 \log_{10} (P)$ dB.”

| | |
|-------|---------|
| Limit | -13 dBm |
|-------|---------|

Measurement Uncertainty

The assessed measurement uncertainty to ensure 95% confidence level for the normal distribution is with the coverage factor $k = 1.96$, $U = 3.55$ dB.

Test Result

The other Spurious RF Radiated emissions level is no more than noise floor.

The worst emission was found in the antenna is vertical position.

Standalone deployment with 15 KHz subcarrier spacing and QPSK mode for CAT NB1:

Original

NB-IOT Band 2 CH-Low

| Harmonic | Frequency (MHz) | SG (dBm) | Cable Loss (dB) | Gain (dBi) | Antenna Polarization | EIRP Level (dBm) | Limit (dBm) | Margin (dB) | Azimuth (deg) |
|----------|-----------------|----------|-----------------|------------|----------------------|------------------|-------------|-------------|---------------|
| 2 | 3700.2 | -54.68 | 5.1 | 11.05 | vertical | -48.73 | -13.00 | 35.73 | 180 |
| 3 | 5550.3 | -53.31 | 5.42 | 12.65 | vertical | -46.08 | -13.00 | 33.08 | 315 |
| 4 | 7400.4 | -49.53 | 6.7 | 13.85 | vertical | -42.38 | -13.00 | 29.38 | 135 |
| 5 | 9250.5 | -49.27 | 7.01 | 14.75 | vertical | -41.53 | -13.00 | 28.53 | 225 |
| 6 | 11100.6 | -46.55 | 7.48 | 15.95 | vertical | -38.08 | -13.00 | 25.08 | 90 |
| 7 | 12950.7 | -45.39 | 7.51 | 16.55 | vertical | -36.35 | -13.00 | 23.35 | 180 |
| 8 | 14800.8 | -41.69 | 8.24 | 15.35 | vertical | -34.58 | -13.00 | 21.58 | 45 |
| 9 | 16650.9 | -42.73 | 8.41 | 14.95 | vertical | -36.19 | -13.00 | 23.19 | 180 |
| 10 | 18501.0 | -41.05 | 8.54 | 15.45 | vertical | -34.14 | -13.00 | 21.14 | 45 |

Note: 1.The other Spurious RF Radiated emissions level is no more than noise floor.
 2.The worst emission was found in the antenna is vertical position.

NB-IOT Band 2 CH-Middle

| Harmonic | Frequency (MHz) | SG (dBm) | Cable Loss (dB) | Gain (dBi) | Antenna Polarization | EIRP Level (dBm) | Limit (dBm) | Margin (dB) | Azimuth (deg) |
|----------|-----------------|----------|-----------------|------------|----------------------|------------------|-------------|-------------|---------------|
| 2 | 3760.0 | -55.92 | 5.10 | 11.05 | vertical | -49.97 | -13.00 | 36.97 | 0 |
| 3 | 5640.0 | -52.50 | 5.42 | 12.65 | vertical | -45.27 | -13.00 | 32.27 | 135 |
| 4 | 7520.0 | -48.64 | 6.70 | 13.85 | vertical | -41.49 | -13.00 | 28.49 | 225 |
| 5 | 9400.0 | -47.74 | 7.01 | 14.75 | vertical | -40.00 | -13.00 | 27.00 | 90 |
| 6 | 11280.0 | -45.18 | 7.48 | 15.95 | vertical | -36.71 | -13.00 | 23.71 | 225 |
| 7 | 13160.0 | -45.78 | 7.51 | 16.55 | vertical | -36.74 | -13.00 | 23.74 | 180 |
| 8 | 15040.0 | -43.85 | 8.24 | 15.35 | vertical | -36.74 | -13.00 | 23.74 | 270 |
| 9 | 16920.0 | -41.46 | 8.41 | 14.95 | vertical | -34.92 | -13.00 | 21.92 | 135 |
| 10 | 18800.0 | -41.56 | 8.54 | 15.45 | vertical | -34.65 | -13.00 | 21.65 | 225 |

Note: 1.The other Spurious RF Radiated emissions level is no more than noise floor.
 2.The worst emission was found in the antenna is vertical position.

NB-IOT Band 2 CH-High

| Harmonic | Frequency (MHz) | SG (dBm) | Cable Loss (dB) | Gain (dBi) | Antenna Polarization | EIRP Level (dBm) | Limit (dBm) | Margin (dB) | Azimuth (deg) |
|----------|-----------------|----------|-----------------|------------|----------------------|------------------|-------------|-------------|---------------|
| 2 | 3819.8 | -56.35 | 5.10 | 11.05 | vertical | -50.40 | -13.00 | 37.40 | 135 |
| 3 | 5729.7 | -55.98 | 5.42 | 12.65 | vertical | -48.75 | -13.00 | 35.75 | 90 |
| 4 | 7639.6 | -48.76 | 6.70 | 13.85 | vertical | -41.61 | -13.00 | 28.61 | 45 |
| 5 | 9549.5 | -50.14 | 7.01 | 14.75 | vertical | -42.40 | -13.00 | 29.40 | 180 |
| 6 | 11459.4 | -45.01 | 7.48 | 15.95 | vertical | -36.54 | -13.00 | 23.54 | 45 |
| 7 | 13369.3 | -45.26 | 7.51 | 16.55 | vertical | -36.22 | -13.00 | 23.22 | 0 |
| 8 | 15279.2 | -43.74 | 8.24 | 15.35 | vertical | -36.63 | -13.00 | 23.63 | 135 |
| 9 | 17189.1 | -41.16 | 8.41 | 14.95 | vertical | -34.62 | -13.00 | 21.62 | 225 |
| 10 | 19099.0 | -41.44 | 8.54 | 15.45 | vertical | -34.53 | -13.00 | 21.53 | 90 |

Note: 1.The other Spurious RF Radiated emissions level is no more than noise floor.
2.The worst emission was found in the antenna is vertical position.

NB-IOT Band 25 CH-Low

| Harmonic | Frequency (MHz) | SG (dBm) | Cable Loss (dB) | Gain (dBi) | Antenna Polarization | EIRP Level (dBm) | Limit (dBm) | Margin (dB) | Azimuth (deg) |
|----------|-----------------|----------|-----------------|------------|----------------------|------------------|-------------|-------------|---------------|
| 2 | 3700.2 | -58.88 | 5.10 | 11.05 | vertical | -52.93 | -13.00 | 39.93 | 45 |
| 3 | 5550.3 | -56.76 | 5.42 | 12.65 | vertical | -49.53 | -13.00 | 36.53 | 0 |
| 4 | 7400.4 | -58.43 | 6.70 | 13.85 | vertical | -51.28 | -13.00 | 38.28 | 0 |
| 5 | 9250.5 | -57.64 | 7.01 | 14.75 | vertical | -49.90 | -13.00 | 36.90 | 315 |
| 6 | 11100.6 | -58.03 | 7.48 | 15.95 | vertical | -49.56 | -13.00 | 36.56 | 225 |
| 7 | 12950.7 | -56.96 | 7.51 | 16.55 | vertical | -47.92 | -13.00 | 34.92 | 90 |
| 8 | 14800.8 | -52.23 | 8.24 | 15.35 | vertical | -45.12 | -13.00 | 32.12 | 90 |
| 9 | 16650.9 | -46.76 | 8.41 | 14.95 | vertical | -40.22 | -13.00 | 27.22 | 0 |
| 10 | 18501.0 | - | - | - | - | - | - | - | - |

Note: 1.The other Spurious RF Radiated emissions level is no more than noise floor.
2. The worst emission was found in the antenna is vertical position.

NB-IOT Band 25 CH-Middle

| Harmonic | Frequency (MHz) | SG (dBm) | Cable Loss (dB) | Gain (dBi) | Antenna Polarization | EIRP Level (dBm) | Limit (dBm) | Margin (dB) | Azimuth (deg) |
|----------|-----------------|----------|-----------------|------------|----------------------|------------------|-------------|-------------|---------------|
| 2 | 3765.0 | -56.73 | 5.10 | 11.05 | vertical | -50.78 | -13.00 | 37.78 | 135 |
| 3 | 5647.5 | -57.58 | 5.42 | 12.65 | vertical | -50.35 | -13.00 | 37.35 | 135 |
| 4 | 7530.0 | -57.68 | 6.70 | 13.85 | vertical | -50.53 | -13.00 | 37.53 | 45 |
| 5 | 9412.5 | -62.08 | 7.01 | 14.75 | vertical | -54.34 | -13.00 | 41.34 | 270 |
| 6 | 11295.0 | -56.59 | 7.48 | 15.95 | vertical | -48.12 | -13.00 | 35.12 | 225 |
| 7 | 13177.5 | -56.40 | 7.51 | 16.55 | vertical | -47.36 | -13.00 | 34.36 | 0 |
| 8 | 15060.0 | -50.37 | 8.24 | 15.35 | vertical | -43.26 | -13.00 | 30.26 | 90 |
| 9 | 16942.5 | -47.58 | 8.41 | 14.95 | vertical | -41.04 | -13.00 | 28.04 | 45 |
| 10 | 18825.0 | - | - | - | - | - | - | - | - |

Note: 1.The other Spurious RF Radiated emissions level is no more than noise floor.
2. The worst emission was found in the antenna is vertical position.

NB-IOT Band 25 CH-High

| Harmonic | Frequency (MHz) | SG (dBm) | Cable Loss (dB) | Gain (dBi) | Antenna Polarization | EIRP Level (dBm) | Limit (dBm) | Margin (dB) | Azimuth (deg) |
|----------|-----------------|----------|-----------------|------------|----------------------|------------------|-------------|-------------|---------------|
| 2 | 3829.8 | -56.02 | 5.10 | 11.05 | vertical | -50.07 | -13.00 | 37.07 | 0 |
| 3 | 5744.7 | -57.49 | 5.42 | 12.65 | vertical | -50.26 | -13.00 | 37.26 | 0 |
| 4 | 7659.6 | -57.97 | 6.70 | 13.85 | vertical | -50.82 | -13.00 | 37.82 | 135 |
| 5 | 9574.5 | -58.18 | 7.01 | 14.75 | vertical | -50.44 | -13.00 | 37.44 | 135 |
| 6 | 11489.4 | -57.31 | 7.48 | 15.95 | vertical | -48.84 | -13.00 | 35.84 | 45 |
| 7 | 13404.3 | -57.33 | 7.51 | 16.55 | vertical | -48.29 | -13.00 | 35.29 | 90 |
| 8 | 15319.2 | -48.77 | 8.24 | 15.35 | vertical | -41.66 | -13.00 | 28.66 | 135 |
| 9 | 17234.1 | -47.91 | 8.41 | 14.95 | vertical | -41.37 | -13.00 | 28.37 | 270 |
| 10 | 19149.0 | - | - | - | - | - | - | - | - |

Note: 1.The other Spurious RF Radiated emissions level is no more than noise floor.
2. The worst emission was found in the antenna is vertical position.

6. Main Test Instruments

Date of Testing: August 4, 2017 ~ August 18, 2017

| Name | Manufacturer | Type | Serial Number | Calibration Date | Expiration Time |
|--------------------------------------|--------------|--------------|---------------|------------------|-----------------|
| Base Station Simulator | R&S | CMW500 | 150415 | 2017-05-14 | 2018-05-13 |
| Power Splitter | Hua Xiang | SHX-GF2-2-13 | 10120101 | 2017-05-14 | 2018-05-13 |
| Spectrum Analyzer | Agilent | N9010A | MY47191109 | 2017-05-20 | 2018-05-19 |
| Universal Radio Communication Tester | Agilent | E5515C | MY48367192 | 2017-05-20 | 2018-05-19 |
| Signal Analyzer | R&S | FSV30 | 100815 | 2016-12-16 | 2017-12-15 |
| EMI Test Receiver | R&S | ESCI | 100948 | 2017-05-20 | 2018-05-19 |
| Signal generator | R&S | SMB 100A | 102594 | 2017-05-14 | 2018-05-13 |
| Signal generator | R&S | SMR27 | 100365 | 2017-05-14 | 2018-05-13 |
| Trilog Antenna | SCHWARZBECK | VUBL 9163 | 9163-201 | 2014-12-06 | 2017-12-05 |
| Horn Antenna | R&S | HF907 | 100126 | 2014-12-06 | 2017-12-05 |
| Climatic Chamber | Re Ce | PT-30B | 20101891 | 2015-07-18 | 2018-07-17 |
| Horn Antenna | ETS-Lindgren | 3160-09 | 00102644 | 2015-01-30 | 2018-01-29 |
| RF Cable | Agilent | SMA 15cm | 0001 | 2017-02-06 | 2017-08-05 |
| Preampflier | R&S | SCU18 | 102327 | 2017-06-18 | 2018-06-17 |



Date of Testing: December 20, 2018 ~ February 13, 2019

| Name | Manufacturer | Type | Serial Number | Calibration Date | Expiration Date |
|--------------------------------------|--------------|--------------|---------------|------------------|-----------------|
| Base Station Simulator | R&S | CMU200 | 118133 | 2018-05-13 | 2019-05-12 |
| Base Station Simulator | R&S | CMW500 | 113824 | 2018-05-20 | 2019-05-19 |
| Power Splitter | Hua Xiang | SHX-GF2-2-13 | 10120101 | / | / |
| Spectrum Analyzer | Key sight | N9010A | MY50210259 | 2018-05-20 | 2019-05-19 |
| Universal Radio Communication Tester | Key sight | E5515C | MY48367192 | 2018-05-20 | 2019-05-19 |
| Signal Analyzer | R&S | FSV30 | 100815 | 2018-12-16 | 2019-12-15 |
| Loop Antenna | SCHWARZBECK | FMZB1519 | 1519-047 | 2017-09-26 | 2019-09-25 |
| Trilog Antenna | SCHWARZBECK | VUBL 9163 | 9163-201 | 2017-11-18 | 2019-11-17 |
| Horn Antenna | R&S | HF907 | 100126 | 2018-07-07 | 2020-07-06 |
| Horn Antenna | ETS-Lindgren | 3160-09 | 00102643 | 2018-06-20 | 2020-06-19 |
| Signal generator | R&S | SMB 100A | 102594 | 2018-05-20 | 2019-05-19 |
| Climatic Chamber | ESPEC | SU-242 | 93000506 | 2017-12-17 | 2020-12-16 |
| Preamplifier | R&S | SCU18 | 102327 | 2018-05-20 | 2019-05-19 |
| MOB COMMS DC SUPPLY | Keysight | 66319D | MY43004105 | 2018-05-07 | 2019-05-06 |
| RF Cable | Agilent | SMA 15cm | 0001 | / | / |
| Software | R&S | EMC32 | 9.26.0 | / | / |



Date of Testing: April 2, 2020~ April 9, 2020

| Name | Manufacturer | Type | Serial Number | Calibration Date | Expiration Date |
|--------------------------------------|--------------|--------------|---------------|------------------|-----------------|
| Base Station Simulator | R&S | CMU200 | 118133 | 2019-05-19 | 2020-05-18 |
| Base Station Simulator | R&S | CMW500 | 113824 | 2019-05-19 | 2020-05-18 |
| Power Splitter | Hua Xiang | SHX-GF2-2-13 | 10120101 | / | / |
| Spectrum Analyzer | Key sight | N9010A | MY50210259 | 2019-05-19 | 2020-05-18 |
| Universal Radio Communication Tester | Key sight | E5515C | MY48367192 | 2019-05-19 | 2020-05-18 |
| Signal Analyzer | R&S | FSV30 | 100815 | 2019-12-15 | 2020-12-14 |
| Loop Antenna | SCHWARZBECK | FMZB1519 | 1519-047 | 2017-09-26 | 2020-09-25 |
| Trilog Antenna | SCHWARZBECK | VUBL 9163 | 9163-201 | 2017-11-18 | 2020-11-17 |
| Horn Antenna | R&S | HF907 | 100126 | 2018-07-07 | 2020-07-06 |
| Horn Antenna | ETS-Lindgren | 3160-09 | 00102643 | 2018-06-20 | 2020-06-19 |
| Signal generator | R&S | SMB 100A | 102594 | 2019-05-19 | 2020-05-18 |
| Climatic Chamber | ESPEC | SU-242 | 93000506 | 2017-12-17 | 2020-12-16 |
| Preamplifier | R&S | SCU18 | 102327 | 2019-05-19 | 2020-05-18 |
| MOB COMMS DC SUPPLY | Keysight | 66319D | MY43004105 | 2019-05-19 | 2020-05-18 |
| RF Cable | Agilent | SMA 15cm | 0001 | 2019-12-13 | 2020-6-12 |
| Software | R&S | EMC32 | 9.26.0 | / | / |



Date of Testing: July 13, 2020

| Name | Manufacturer | Type | Serial Number | Calibration Date | Expiration Date |
|--------------------------------------|--------------|--------------|---------------|------------------|-----------------|
| Base Station Simulator | R&S | CMU200 | 118133 | 2020-05-17 | 2021-05-16 |
| Base Station Simulator | R&S | CMW500 | 113824 | 2020-05-18 | 2021-05-17 |
| Power Splitter | Hua Xiang | SHX-GF2-2-13 | 10120101 | / | / |
| Spectrum Analyzer | Key sight | N9010A | MY50210259 | 2020-05-18 | 2021-05-17 |
| Universal Radio Communication Tester | Key sight | E5515C | MY48367192 | 2020-05-27 | 2021-05-26 |
| Signal Analyzer | R&S | FSV30 | 100815 | 2019-12-15 | 2020-12-14 |
| Loop Antenna | SCHWARZBECK | FMZB1519 | 1519-047 | 2017-09-26 | 2020-09-25 |
| Trilog Antenna | SCHWARZBECK | VUBL 9163 | 9163-201 | 2017-11-18 | 2020-11-17 |
| Horn Antenna | R&S | HF907 | 102723 | 2018-08-11 | 2021-08-10 |
| Horn Antenna | ETS-Lindgren | 3160-09 | 00102643 | 2018-06-20 | 2021-06-19 |
| Signal generator | R&S | SMB 100A | 102594 | 2020-05-18 | 2021-05-17 |
| Climatic Chamber | ESPEC | SU-242 | 93000506 | 2017-12-17 | 2020-12-16 |
| Preamplifier | R&S | SCU18 | 102327 | 2020-05-18 | 2021-05-17 |
| MOB COMMS DC SUPPLY | Keysight | 66319D | MY43004105 | 2020-05-18 | 2021-05-17 |
| RF Cable | Agilent | SMA 15cm | 0001 | 2020-06-12 | 2020-12-11 |
| Software | R&S | EMC32 | 9.26.0 | / | / |

ANNEX A: Product Change Description



BG96 R1.1 & BG96 R1.2 Differences Statement

LTE Module Series

PCB Rev.: R1.2

Date: 2018-10-08



www.quectel.com

Build a Smarter World



Based on BG96 R1.1, BG96 R1.2 has enabled VDD_QFPROM_PRG hardware interface, which is connected to ground directly in BG96 R1.1, so as to support secure boot feature.

Some points are highlighted as below:

- BG96 R1.1 and R1.2 versions share the same hardware architecture and key components.
- BG96 R1.1 and R1.2 versions share the same pinout placements.
- Secure boot is enabled through a set of hardware fuses in BG96 R1.2. For the code to be executed, it must be signed by the trusted entity identified in the hardware fuses, so we have to enable VDD_QFPROM_PRG hardware interface.
- The new hardware will be used with the new software baseline TX3.0, and the software version is R04Axx.

The details are illustrated as below:

1. What's Secure Boot

Secure boot refers to the bootup sequence that establishes a trusted platform for secure applications. It starts as an immutable sequence that validates the origin of the code using cryptographic authentication so only authorized software can be executed. The bootup sequence places the device in a known security state and protects against binary manipulation of software and reflashing attacks.

A secure boot system adds cryptographic checks to each stage of the boot up process. This process asserts the authenticity of all secure software images that are executed by the device. This additional check prevents any unauthorized or maliciously modified software from running on the device. Secure boot is enabled through a set of hardware fuses. For the code to be executed, it must be signed by the trusted entity identified in the hardware fuses.

In simple terms, secure boot ensures running of signed/authorized software on the module, and unsigned/unauthorized software will not be allowed to run.

2. Enabled VDD_QFPROM_PRG Hardware Interface

A. BG96 R1.1 does not support secure boot function

The VDD_QFPROM_PRG (N19) pin of baseband chip is for secure boot function. In BG96 R1.1, this pin is connected to ground directly, which means secure boot function is disabled.

B. BG96 R1.2 supports secure boot function

According to Qualcomm's suggestion and our customers' requirements, the VDD_QFPROM_PRG pin is connected to VREG_L3_1P8(1.8V) in BG96 R1.2 so as to enable secure boot function.

The following pictures show the schematic and PCB designs of BG96 R1.1 and R1.2.

Build a Smarter World



Figure 1: Schematic Designs of BG96 R1.1 and R1.2

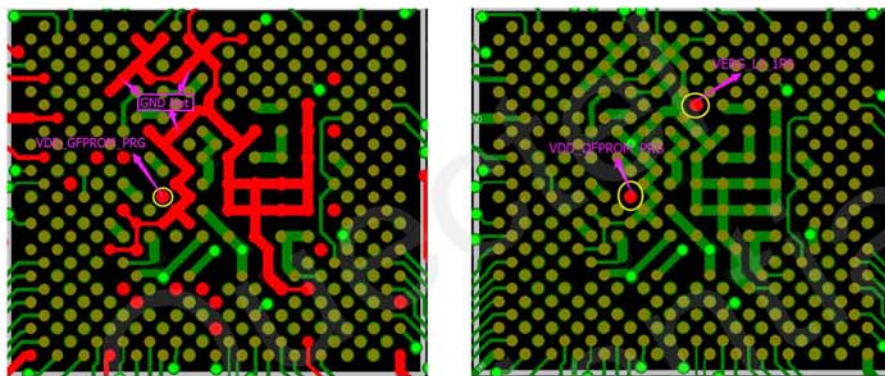

Figure 2: PCB Designs of BG96 R1.1 and R1.2

3. TX2.0 vs TX3.0

The biggest difference of TX3.0 as compared with TX2.0 lies in the adding of VoLTE and handover features. Since VoLTE environment has not been built so maturely yet, the main concern of customers is the handover function.

For TX2.0, re-selection is supported, while handover is not supported.

BG96 supports re-selection mechanism, which means when disconnection happens during cell handover, the module will reconnect automatically. This process lasts for about 1 (or 2) seconds, and the data transmitted (may happen by coincidence) will be buffered and resent once the reconnection established. So, the disconnection is generally imperceptible to customers.

- If the data transmission occurs at the moment that cell handover occurs coincidentally, the connection is kept with handover function; the connection is broken and re-connection established in about 1 (or 2) seconds with re-selection. This causes nearly no difference for data telematics because users even cannot feel this disconnection, whereas VoLTE might be affected because of the short time disconnection.



Build a Smarter World



- If the data transmission occurs in the period that no cell alternates, then no any influence will be caused.

Quectel
Confidential

*****END OF REPORT *****