



	40°C/Normal Voltage	-0.00229	-0.00064
	50°C/Normal Voltage	-0.00021	-0.00010
	60°C/Normal Voltage	-0.00154	-0.00259
	70°C/Normal Voltage	-0.00208	-0.00229
	80°C/Normal Voltage	-0.00301	-0.00195
	85°C/Normal Voltage	-0.00432	-0.00187
	20°C/Min Voltage	-0.00530	-0.00226
	20°C/Max Voltage	-0.00360	-0.00285
15MHz	-40°C/Normal Voltage	-0.00485	-0.00018
	-30°C/Normal Voltage	-0.00390	0.00080
	-20°C/Normal Voltage	-0.00460	-0.00331
	-10°C/Normal Voltage	-0.00395	-0.00046
	0°C/Normal Voltage	-0.00290	-0.00040
	10°C/Normal Voltage	-0.00181	0.00346
	20°C/Normal Voltage	-0.00136	0.00049
	30°C/Normal Voltage	-0.00043	-0.00009
	40°C/Normal Voltage	-0.00198	0.00215
	50°C/Normal Voltage	-0.00343	0.00212
	60°C/Normal Voltage	-0.00082	0.00301
	70°C/Normal Voltage	-0.00200	0.00572
	80°C/Normal Voltage	-0.00182	0.00515
	85°C/Normal Voltage	-0.00277	-0.00396
	20°C/Min Voltage	-0.00148	-0.00195
	20°C/Max Voltage	-0.00359	-0.00301
20MHz	-40°C/Normal Voltage	0.00114	0.00435
	-30°C/Normal Voltage	-0.00106	0.00396
	-20°C/Normal Voltage	-0.00316	0.00235
	-10°C/Normal Voltage	0.00012	0.00256
	0°C/Normal Voltage	0.00135	0.00223
	10°C/Normal Voltage	0.00097	0.00421
	20°C/Normal Voltage	0.00222	0.00327
	30°C/Normal Voltage	-0.00184	0.00301
	40°C/Normal Voltage	-0.00004	0.00408
	50°C/Normal Voltage	-0.00102	0.00639
	60°C/Normal Voltage	-0.00186	0.00576
	70°C/Normal Voltage	0.00230	0.00338
	80°C/Normal Voltage	-0.00037	0.00271
	85°C/Normal Voltage	-0.00040	0.00432
	20°C/Min Voltage	-0.00101	0.00422
	20°C/Max Voltage	-0.00295	0.00636



LTE Band 25					
(QPSK, 20MHz BANDWIDTH)					
Condition		1850	1915	Delta(Hz)	Frequency Stability(ppm)
Temperature	Voltage	F low@-13dBm(MHz)	F high@-13dBm(MHz)		
Normal (25°C)	Normal	1851.1788	1914.8258	7.71	0.00410
Extreme (85°C)		1851.1791	1914.8255	2.64	0.00140
Extreme (80°C)		1851.1794	1914.8252	17.23	0.00916
Extreme (70°C)		1851.1789	1914.8257	-7.62	-0.00405
Extreme (60°C)		1851.1783	1914.8253	1.43	0.00076
Extreme (50°C)		1851.1868	1914.8338	5.81	0.00309
Extreme (40°C)		1851.1822	1914.8292	-12.33	-0.00656
Extreme (30°C)		1851.1829	1914.8299	6.42	0.00341
Extreme (20°C)		1851.1832	1914.8302	2.39	0.00127
Extreme (10C)		1851.1797	1914.8267	17.45	0.00928
Extreme (0°C)		1851.1856	1914.8326	8.46	0.00450
Extreme (-10°C)		1851.1793	1914.8263	-13.02	-0.00693
Extreme (-20°C)		1851.1834	1914.8304	12.35	0.00657
Extreme (-30°C)		1851.1781	1914.8252	9.76	0.00519
Extreme (-40°C)		1851.1788	1914.8258	5.25	0.00279
25°C	LV	1851.1832	1914.8302	-2.64	-0.00140
	HV	1851.1781	1914.8251	9.16	0.00487
(16QAM, 20MHz BANDWIDTH)					
Condition		1850	1915	Delta(Hz)	Frequency Stability(ppm)
Temperature	Voltage	F low@-13dBm(MHz)	F high@-13dBm(MHz)		
Normal (25°C)	Normal	1851.1742	1914.8212	-5.48	-0.00291
Extreme (85°C)		1851.1745	1914.8209	3.14	0.00167
Extreme (80°C)		1851.1748	1914.8206	7.68	0.00409
Extreme (70°C)		1851.1743	1914.8211	9.24	0.00491
Extreme (60°C)		1851.1747	1914.8217	-15.33	-0.00815
Extreme (50°C)		1851.1662	1914.8132	4.25	0.00226
Extreme (40°C)		1851.1708	1914.8178	8.13	0.00432
Extreme (30°C)		1851.1701	1914.8171	-2.54	-0.00135
Extreme (20°C)		1851.1698	1914.8168	14.10	0.00750
Extreme (10C)		1851.1733	1914.8203	6.10	0.00324
Extreme (0°C)		1851.1674	1914.8144	2.84	0.00151
Extreme (-10°C)		1851.1737	1914.8207	13.64	0.00726
Extreme (-20°C)		1851.1696	1914.8166	-6.49	-0.00345
Extreme (-30°C)		1851.1753	1914.8222	2.01	0.00107



Extreme (-40°C)		1851.1742	1914.8212	7.38	0.00393
25°C	LV	1851.1698	1914.8168	4.32	0.00230
	HV	1851.1749	1914.8219	3.96	0.00211

### 5.7. Spurious Emissions at Antenna Terminals

#### Ambient condition

Temperature	Relative humidity	Pressure
23°C ~25°C	45%~50%	101.5kPa

#### Method of Measurement

The EUT was connected to Spectrum Analyzer and Base Station Simulator via power Splitter. The measurement is carried out using a spectrum analyzer. The spectrum analyzer scans from 9kHz to the 10th harmonic of the carrier. The peak detector is used.

RBW is set to 100kHz, VBW is set to 300kHz for 30MHz~1GHz

RBW is set to 1MHz, VBW is set to 3MHz for above 1GHz, Sweep is set to ATUO.

The modulation mode and RB allocation refer to section 5.1, using the maximum output power configuration.

#### Test setup

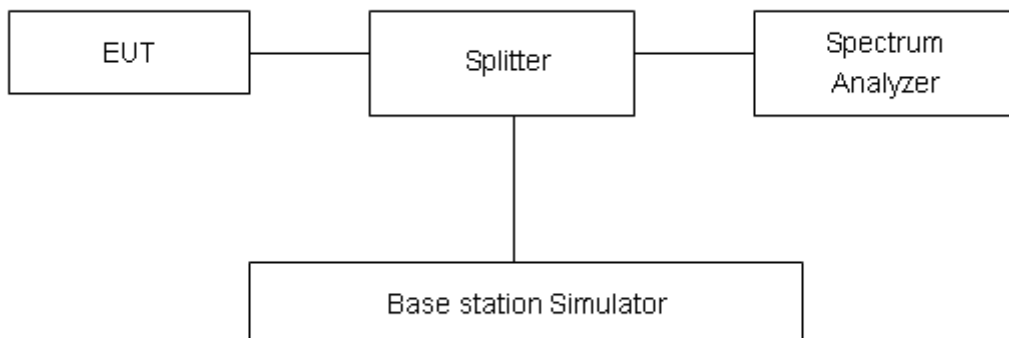

#### Limits

Rule Part 24.238(a) specifies that “on any frequency outside a licensee’s frequency block, the power of any emission shall be attenuated below the transmitter power (P) by at least  $43 + 10 \log_{10} (P)$  dB.”

Limit	-13 dBm

#### Measurement Uncertainty

The assessed measurement uncertainty to ensure 99.75% confidence level for the normal distribution is with the coverage factor  $k = 1.96$ .

Frequency	Uncertainty
9kHz-1GHz	0.684 dB
1GHz-20GHz	1.407 dB

## Test Result

Sweep the whole frequency band through the range from 9kHz to the 10th harmonic of the carrier, the emissions more than 20 dB below the limit are not reported.

The signal beyond the limit is carrier.

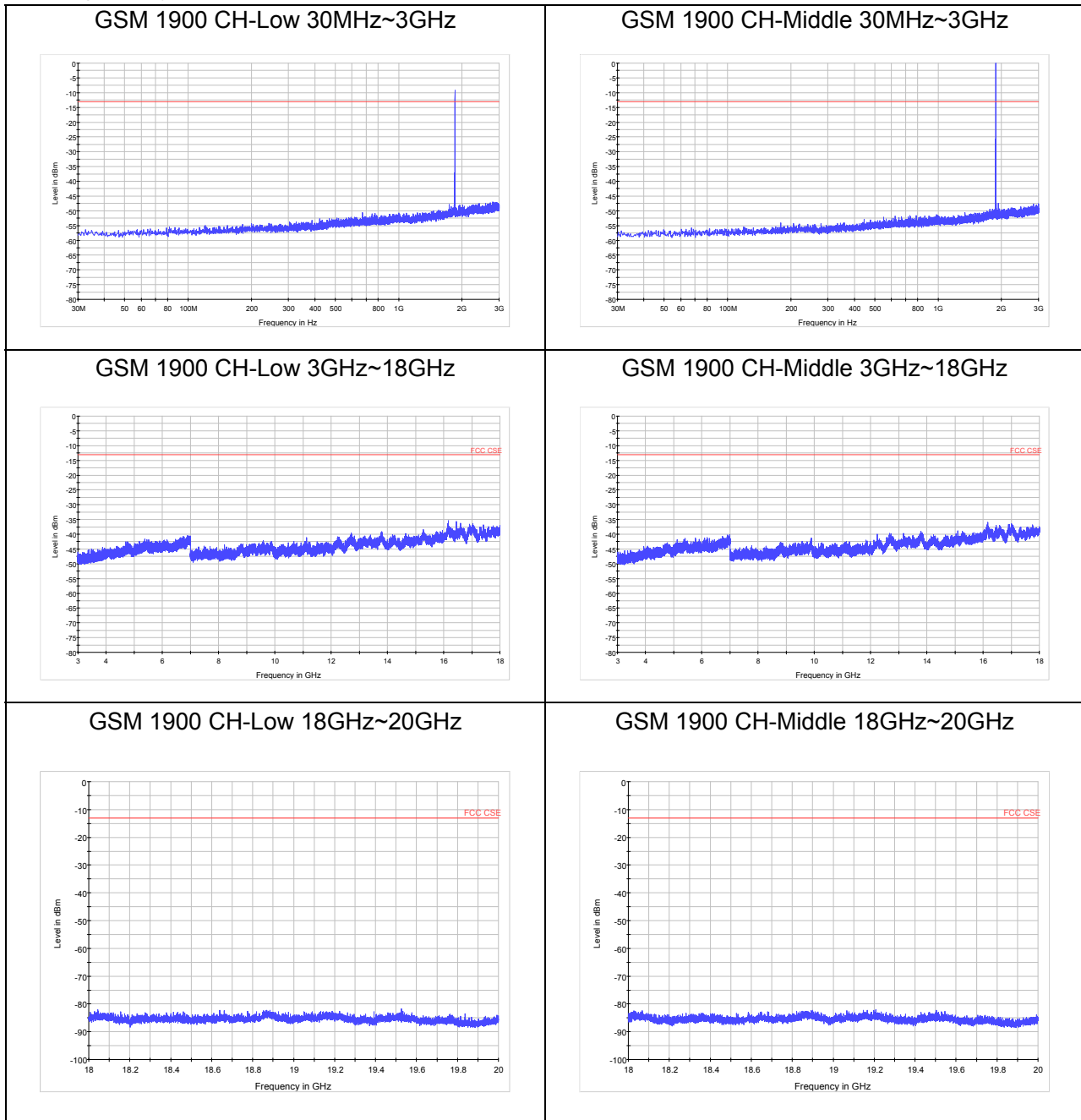



GSM 1900 CH-High 30MHz~3GHz

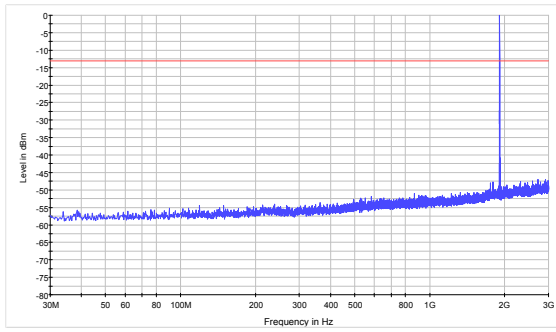

LTE Band 2 1.4MHz CH-Low 30MHz~3GHz

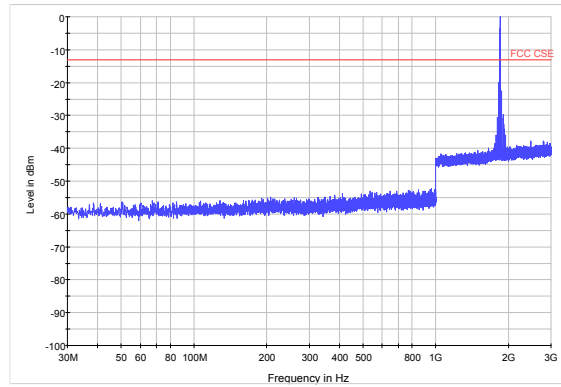

GSM 1900 CH-High 3GHz~18GHz

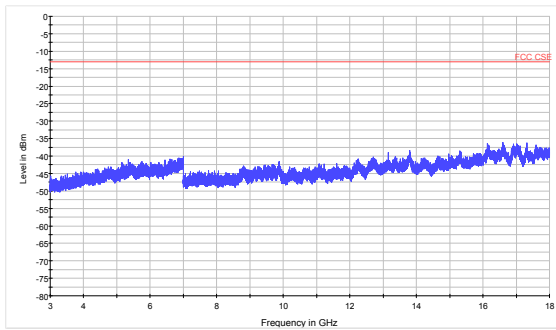

LTE Band 2 1.4MHz CH-Low 3GHz~18GHz

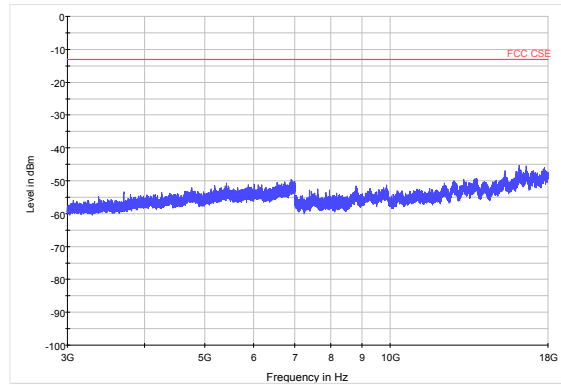

GSM 1900 CH-High 18GHz~20GHz

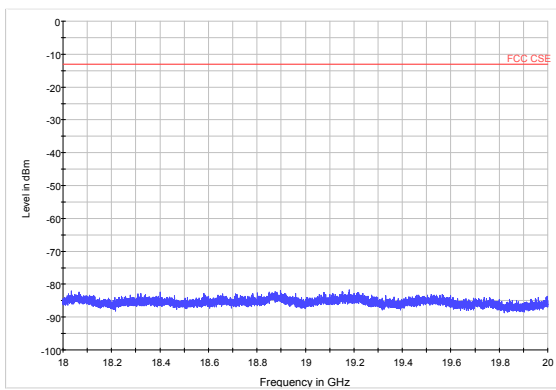

LTE Band 2 1.4MHz CH-Low 18GHz~20GHz

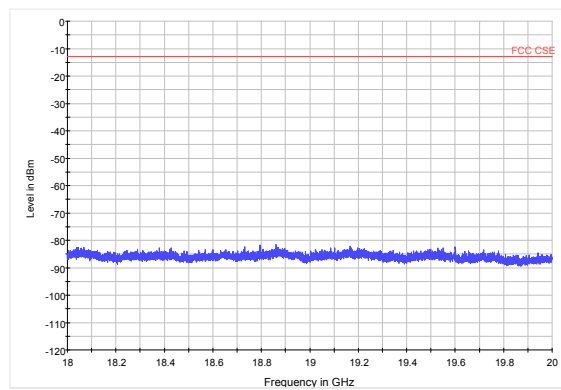



LTE Band 2 1.4MHz CH-Middle 30MHz~3GHz

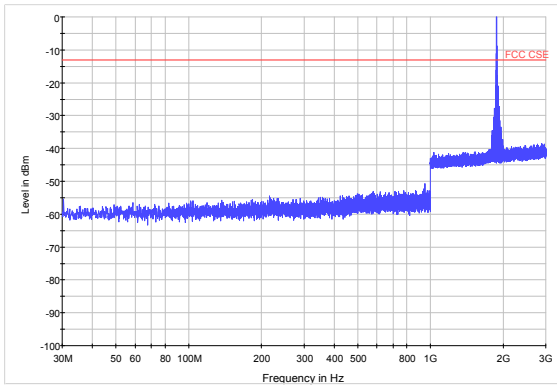

LTE Band 2 1.4MHz CH-High 30MHz~3GHz

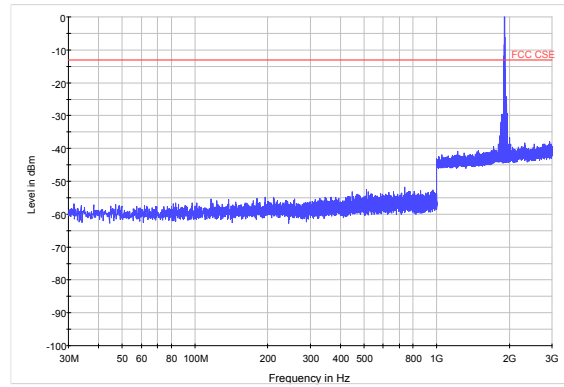

LTE Band 2 1.4MHz CH-Middle 3GHz~18GHz

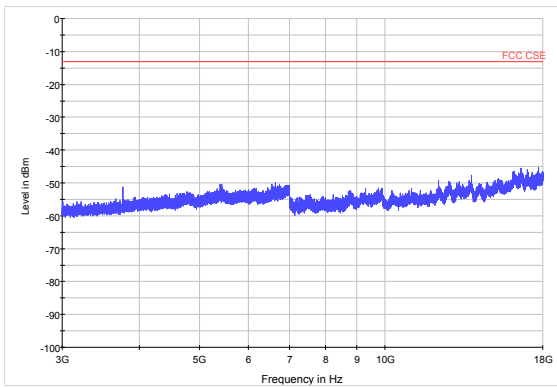

LTE Band 2 1.4MHz CH-High 3GHz~18GHz

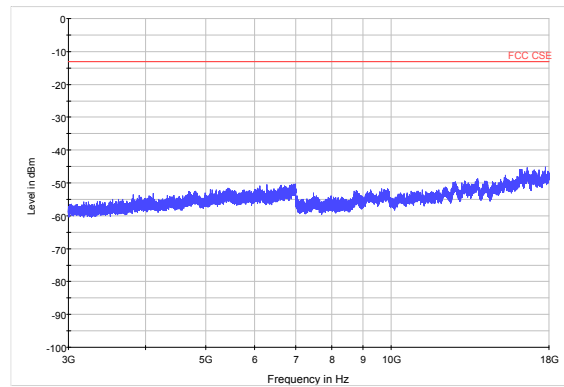

LTE Band 2 1.4MHz CH-Middle 18GHz~20GHz

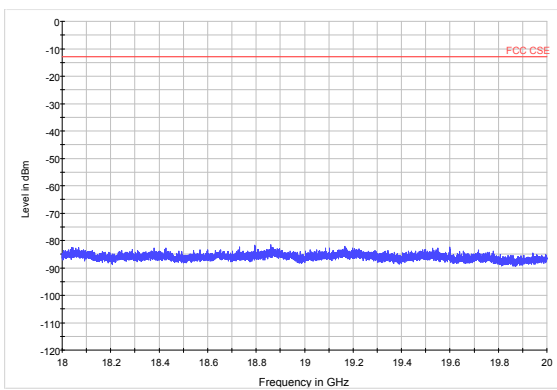

LTE Band 2 1.4MHz CH-High 18GHz~20GHz

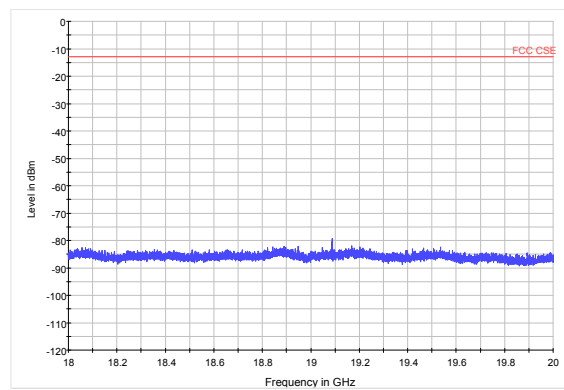



LTE Band 2 3MHz CH-Low 30MHz~3GHz

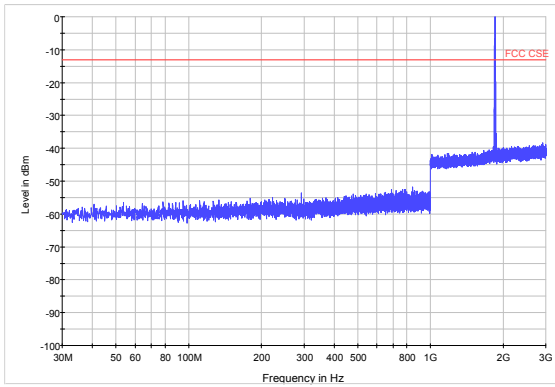

LTE Band 2 3MHz CH-Middle 30MHz~3GHz

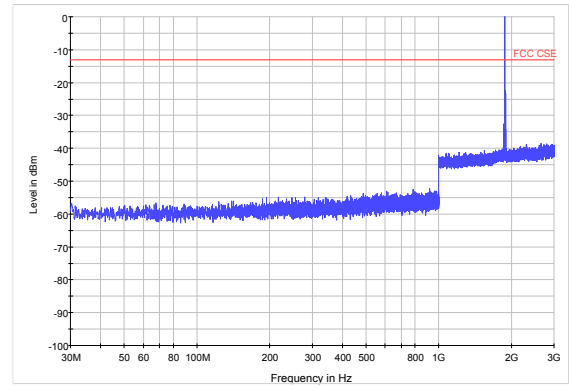

LTE Band 2 3MHz CH-Low 3GHz~18GHz

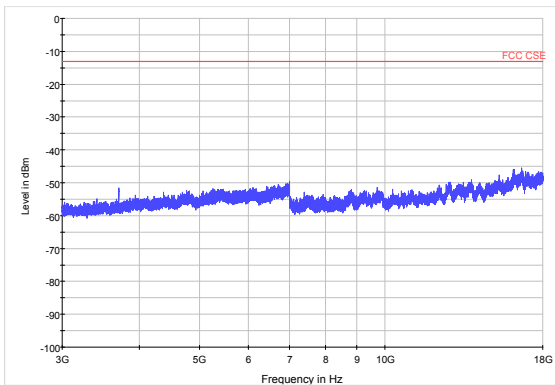

LTE Band 2 3MHz CH-Middle 3GHz~18GHz

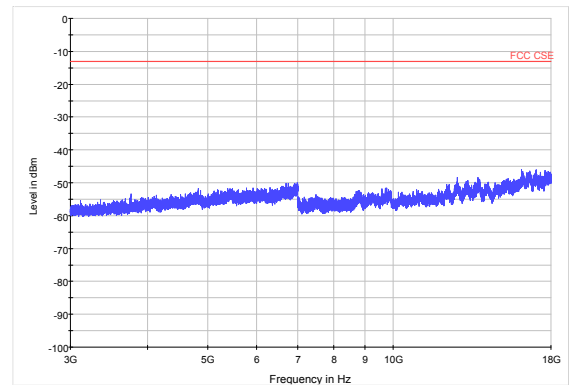

LTE Band 2 3MHz CH-Low 18GHz~20GHz

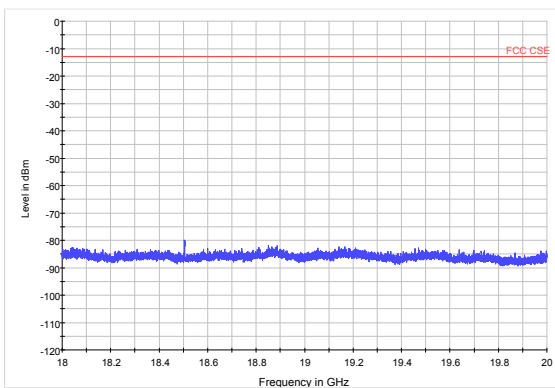

LTE Band 2 3MHz CH-Middle 18GHz~20GHz

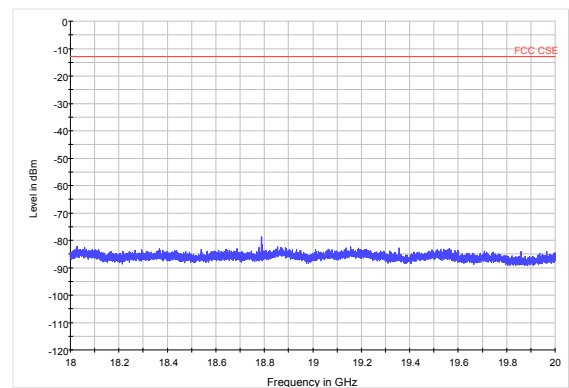





LTE Band 2 3MHz CH-High 30MHz~3GHz

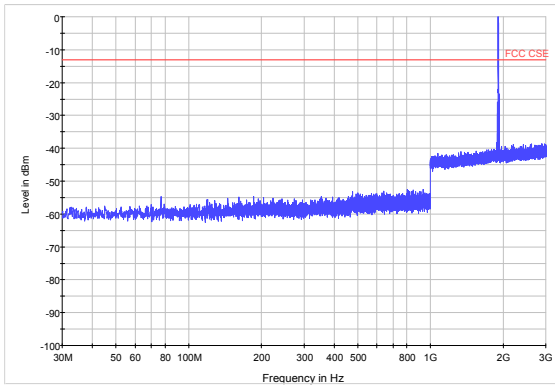

LTE Band 2 5MHz CH-Low 30MHz~3GHz

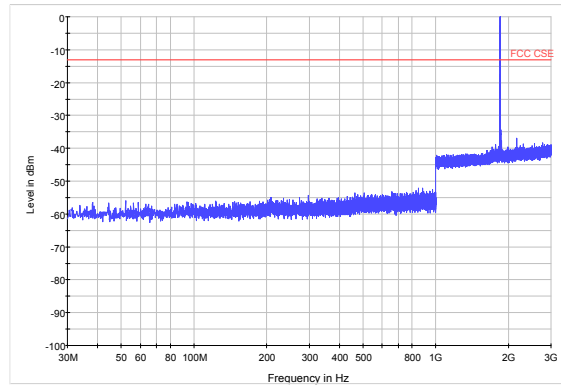

LTE Band 2 3MHz CH-High 3GHz~18GHz

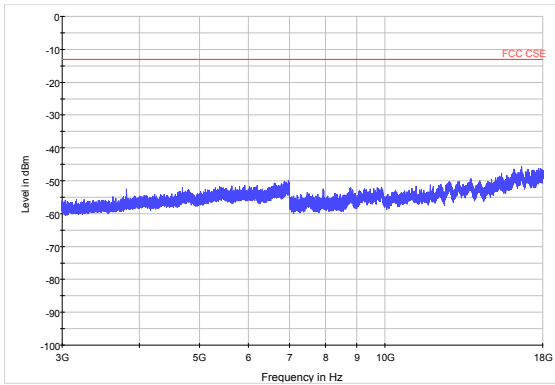

LTE Band 2 5MHz CH-Low 3GHz~18GHz

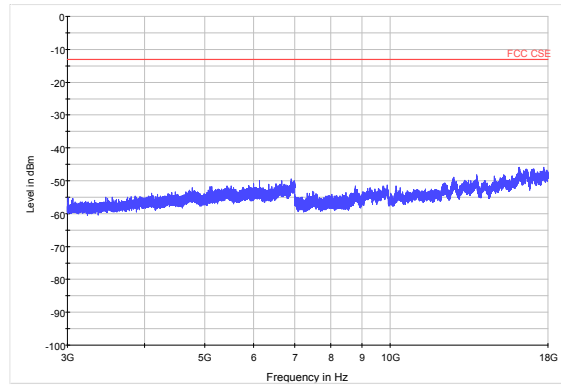

LTE Band 2 3MHz CH-High 18GHz~20GHz

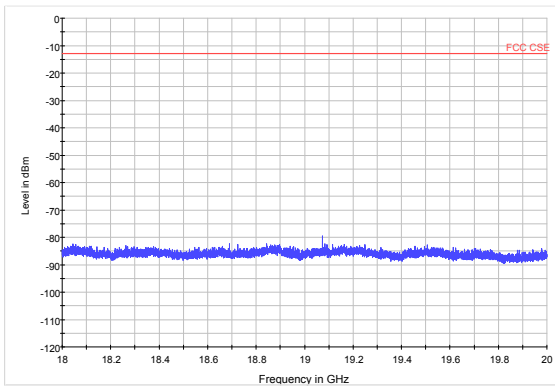

LTE Band 2 5MHz CH-Low 18GHz~20GHz

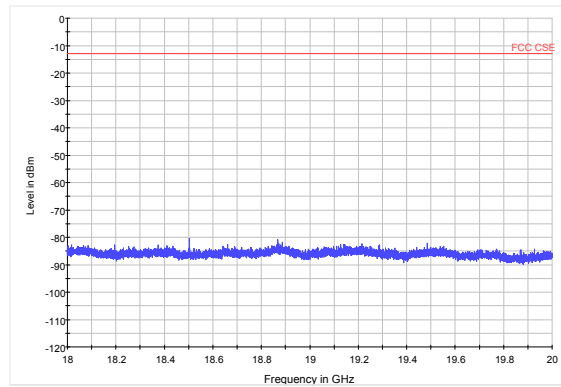



LTE Band 2 5MHz CH-Middle 30MHz~3GHz

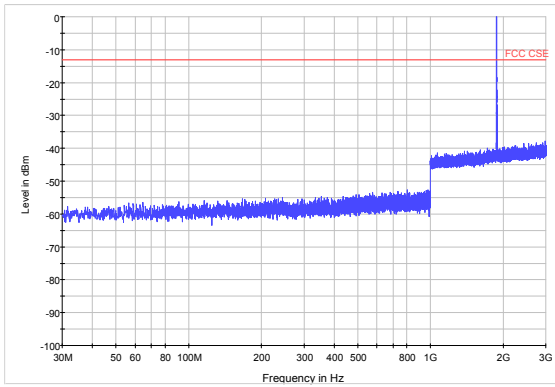

LTE Band 2 5MHz CH-High 30MHz~3GHz

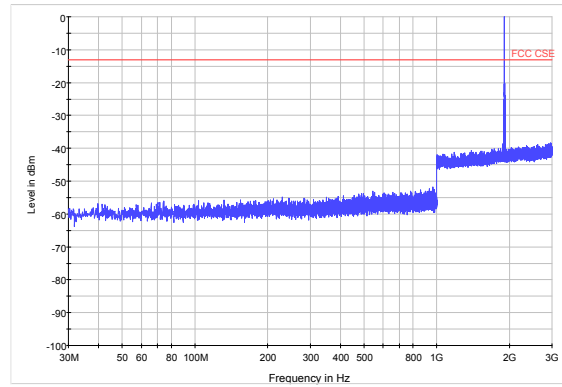

LTE Band 2 5MHz CH-Middle 3GHz~18GHz

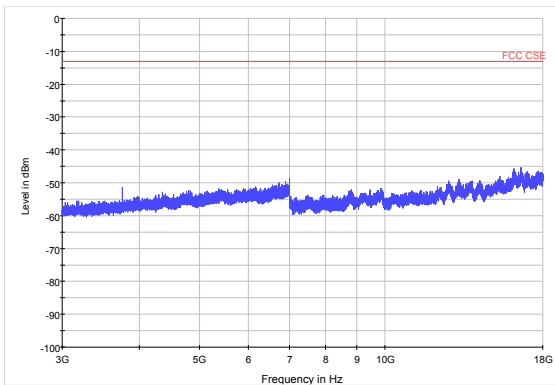

LTE Band 2 5MHz CH-High 3GHz~18GHz

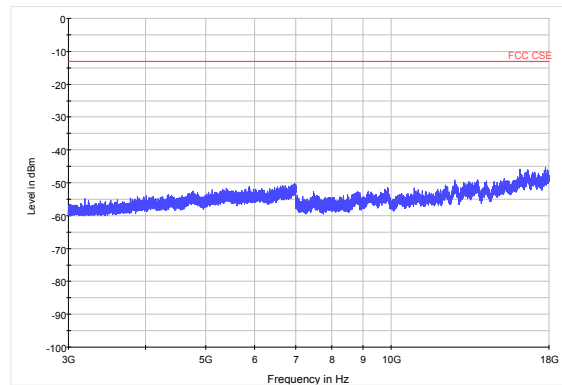

LTE Band 2 5MHz CH-Middle 18GHz~20GHz

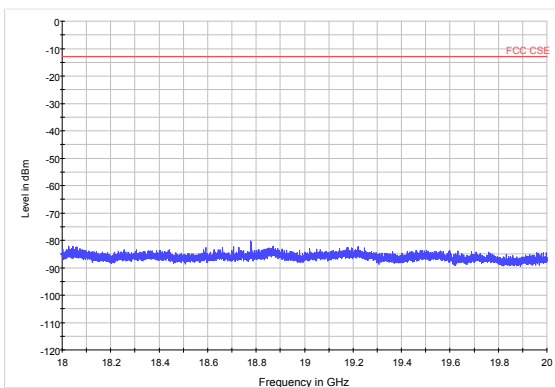

LTE Band 2 5MHz CH-High 18GHz~20GHz

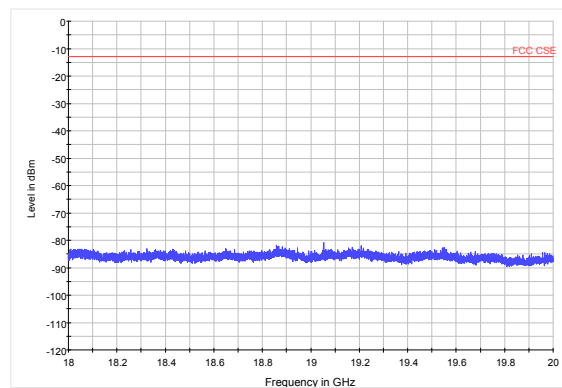



LTE Band 2 10MHz CH-Low 30MHz~3GHz

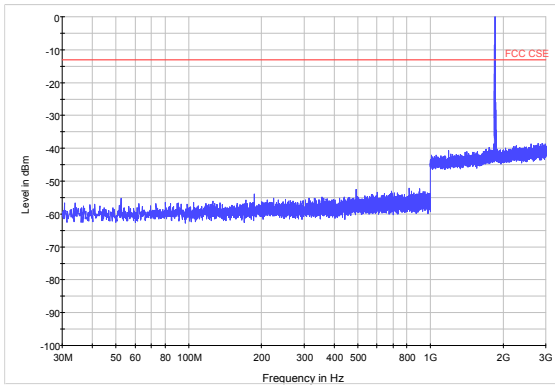

LTE Band 2 10MHz CH-Middle 30MHz~3GHz

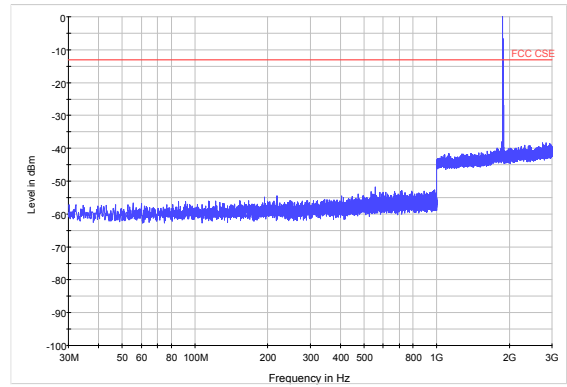

LTE Band 2 10MHz CH-Low 3GHz~18GHz

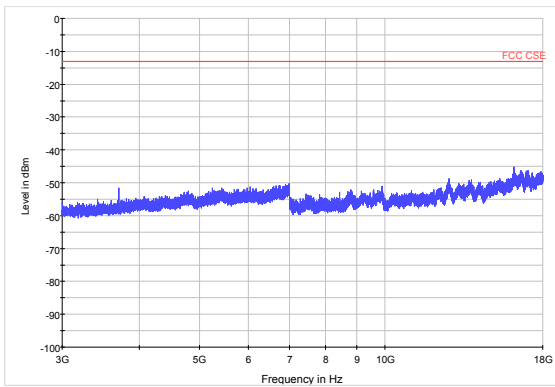

LTE Band 2 10MHz CH-Middle 3GHz~18GHz

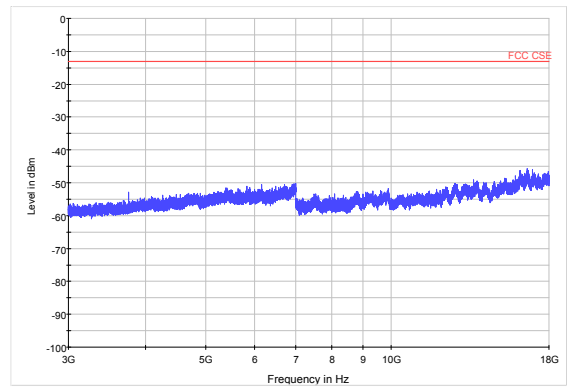

LTE Band 2 10MHz CH-Low 18GHz~20GHz

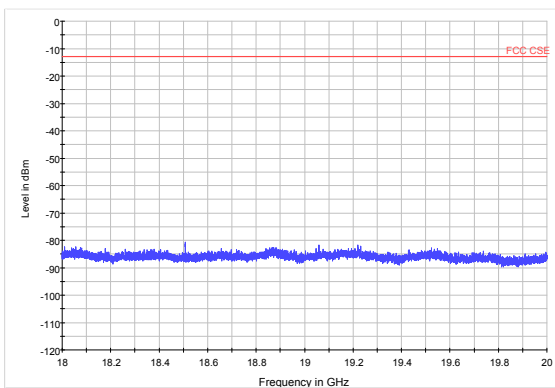

LTE Band 2 10MHz CH-Middle 18GHz~20GHz

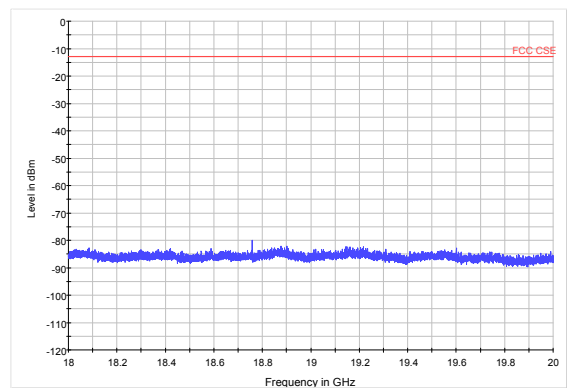



LTE Band 2 10MHz CH-High 30MHz~3GHz

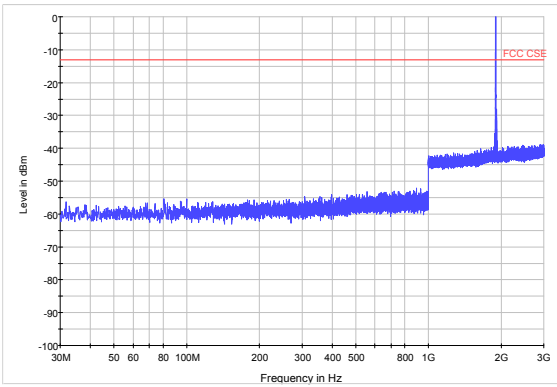

LTE Band 2 15MHz CH-Low 30MHz~3GHz

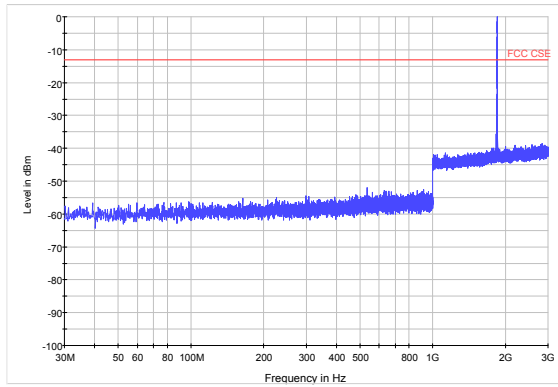

LTE Band 2 10MHz CH-High 3GHz~18GHz

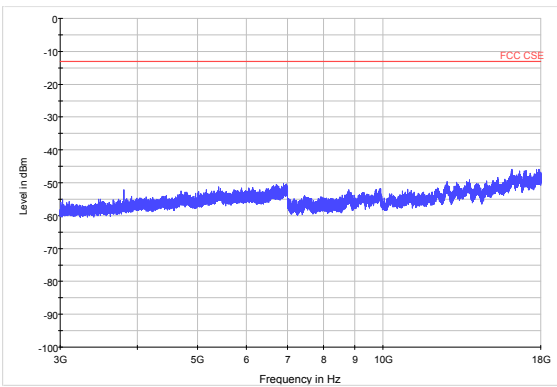

LTE Band 2 15MHz CH-Low 3GHz~18GHz

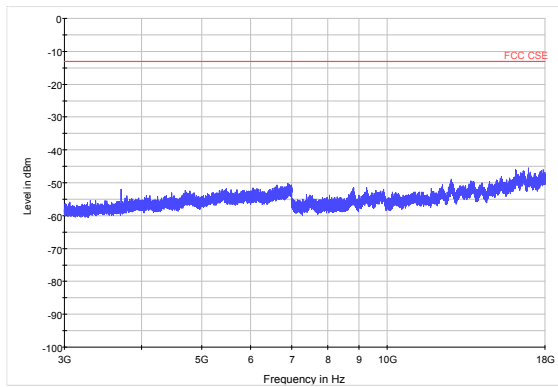

LTE Band 2 10MHz CH-High 18GHz~20GHz

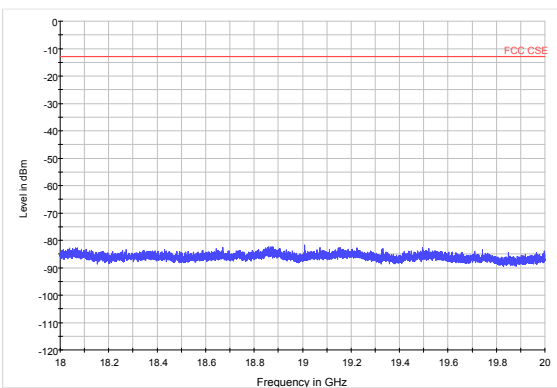

LTE Band 2 15MHz CH-Low 18GHz~20GHz

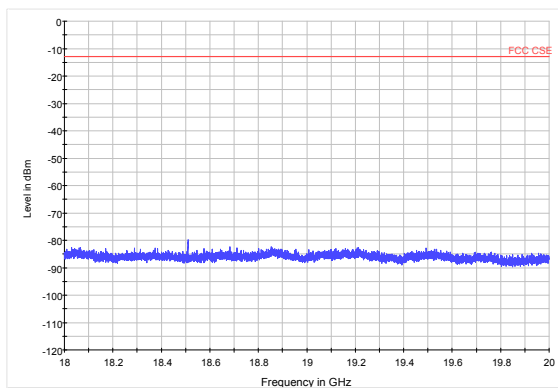



LTE Band 2 15MHz CH-Middle 30MHz~3GHz

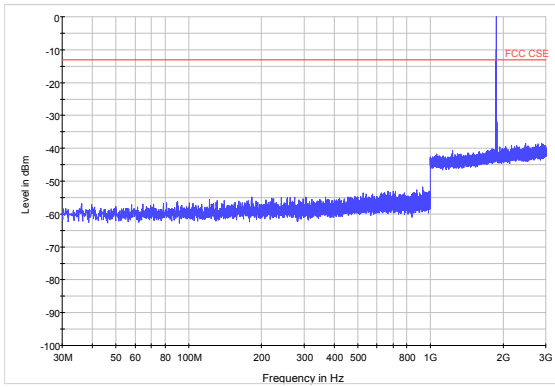

LTE Band 2 15MHz CH-High 30MHz~3GHz

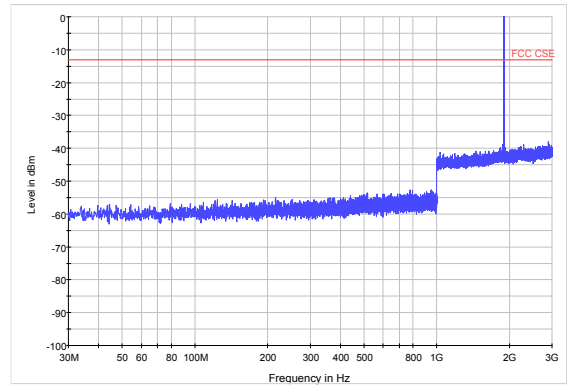

LTE Band 2 15MHz CH-Middle 3GHz~18GHz

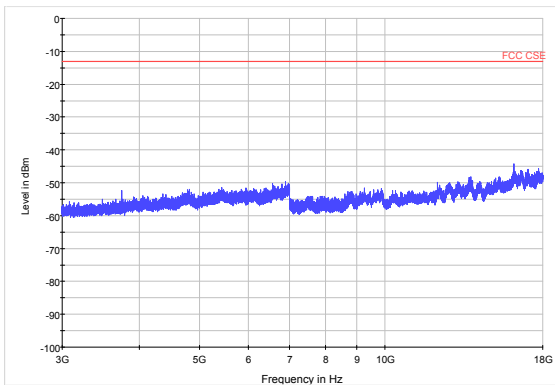

LTE Band 2 15MHz CH-High 3GHz~18GHz

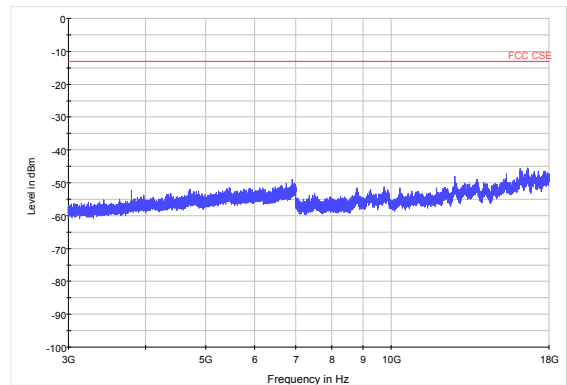

LTE Band 2 15MHz CH-Middle 18GHz~20GHz

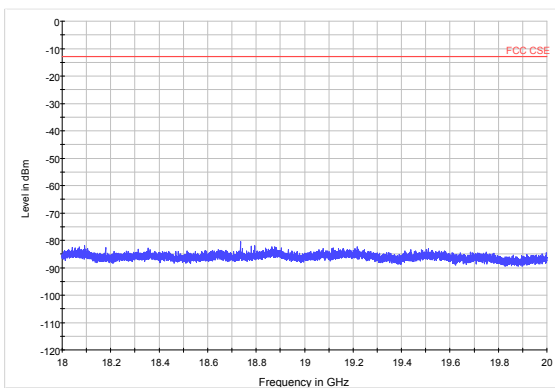

LTE Band 2 15MHz CH-High 18GHz~20GHz

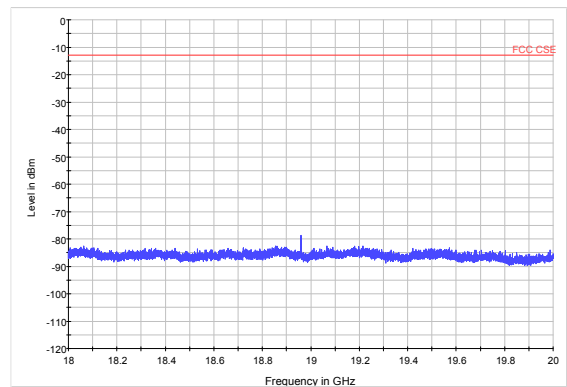



LTE Band 2 20MHz CH-Low 30MHz~3GHz

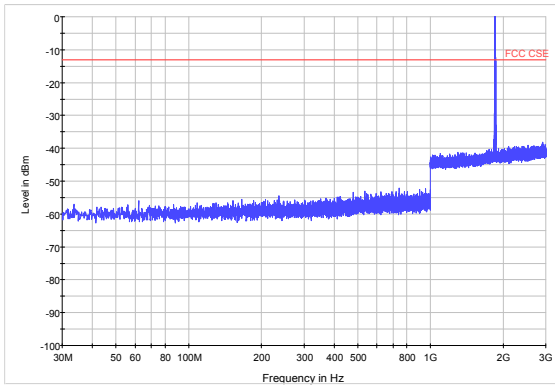

LTE Band 2 20MHz CH-Middle 30MHz~3GHz

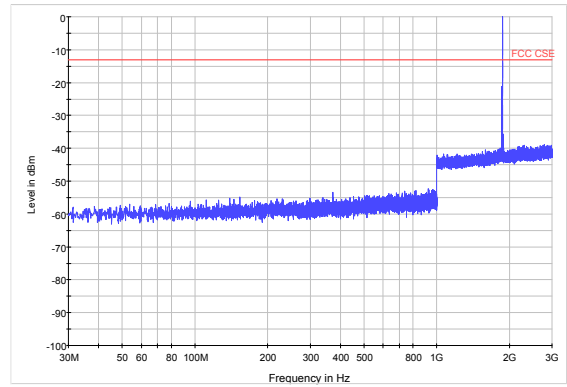

LTE Band 2 20MHz CH-Low 3GHz~18GHz

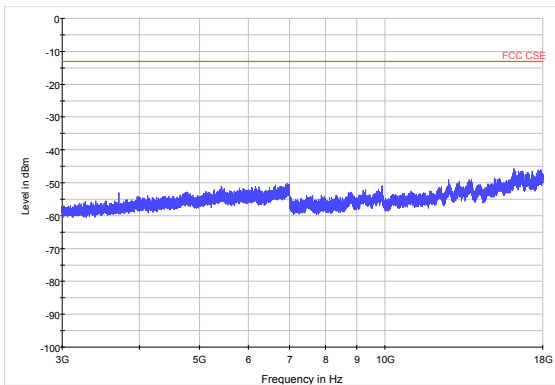

LTE Band 2 20MHz CH-Middle 3GHz~18GHz

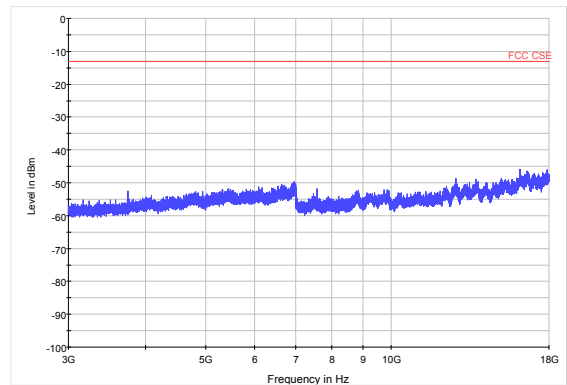

LTE Band 2 20MHz CH-Low 18GHz~20GHz

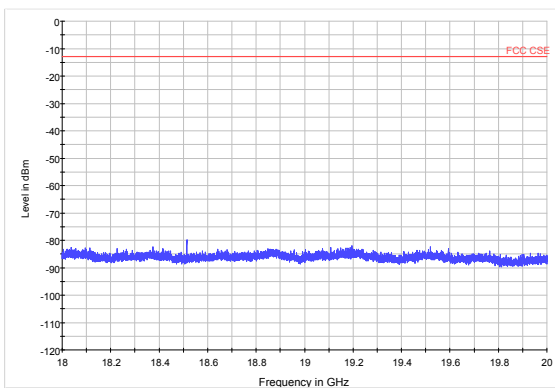

LTE Band 2 20MHz CH-Middle 18GHz~20GHz

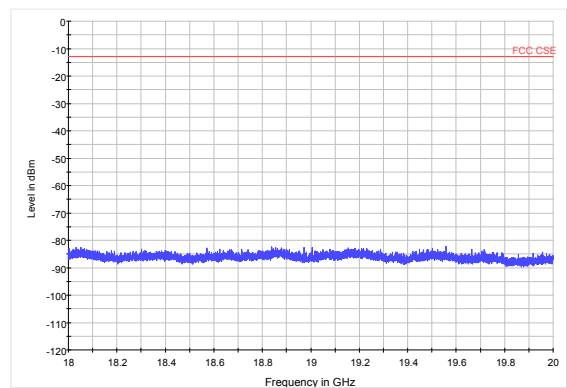



LTE Band 2 20MHz CH-High 30MHz~3GHz

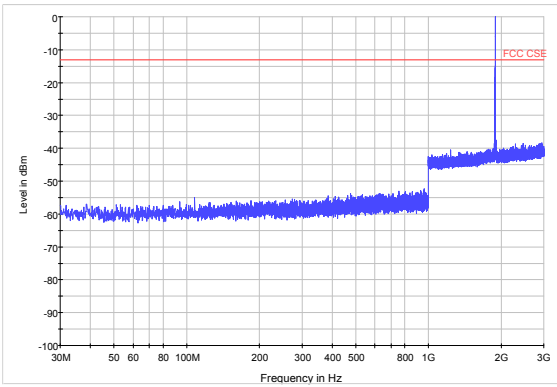

LTE Band 2 20MHz CH-High 3GHz~18GHz

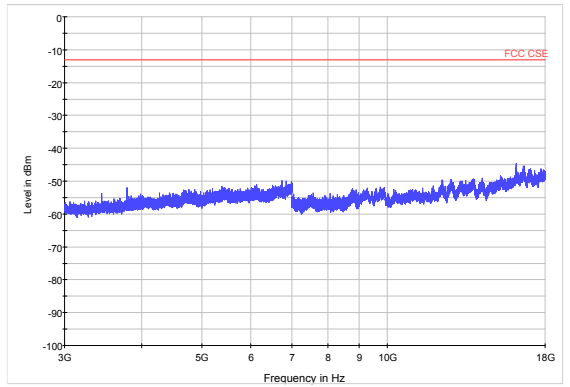

LTE Band 2 20MHz CH-High 18GHz~20GHz

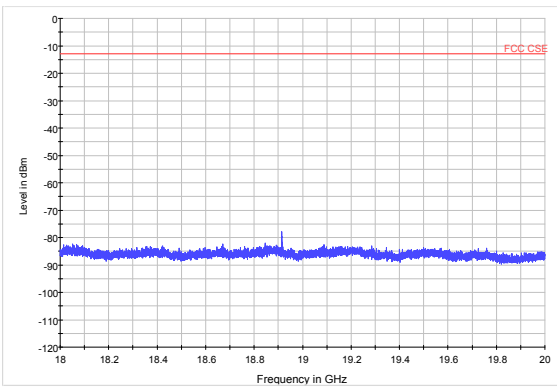



### LTE Band 25 1.4MHz CH-Low 30MHz~1GHz

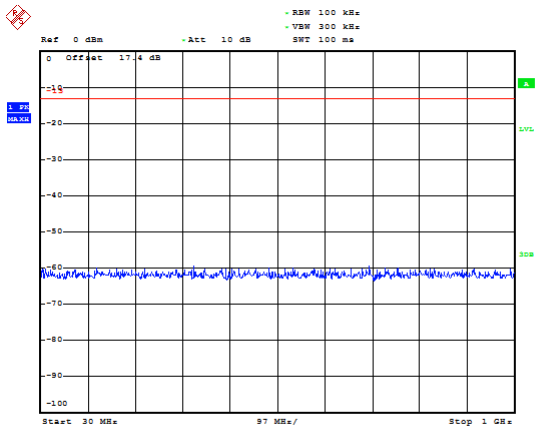

Date: 8.DEC.2018 10:24:49

### LTE Band 25 1.4MHz CH-Middle 30MHz~1GHz

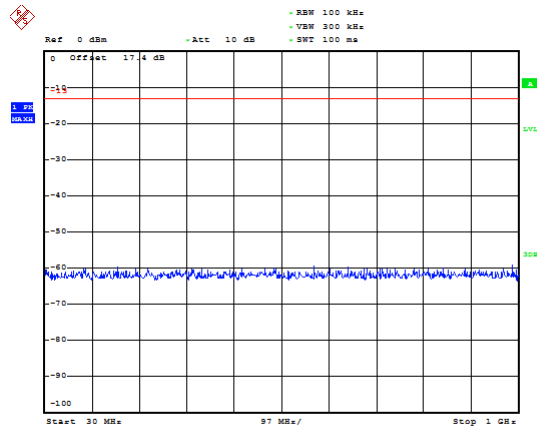

Date: 8.DEC.2018 10:35:27

### LTE Band 25 1.4MHz CH-Low 1GHz~3GHz

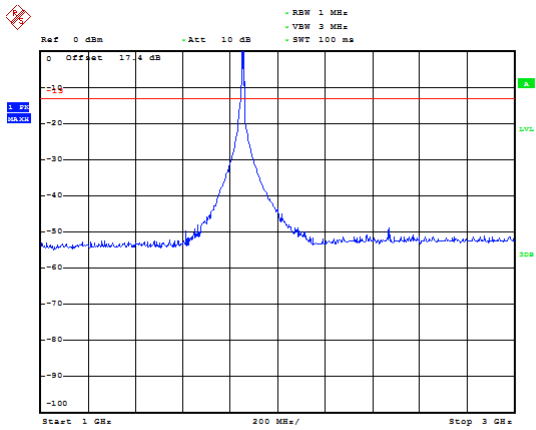

Date: 8.DEC.2018 10:32:21

### LTE Band 25 1.4MHz CH-Middle 1GHz~3GHz

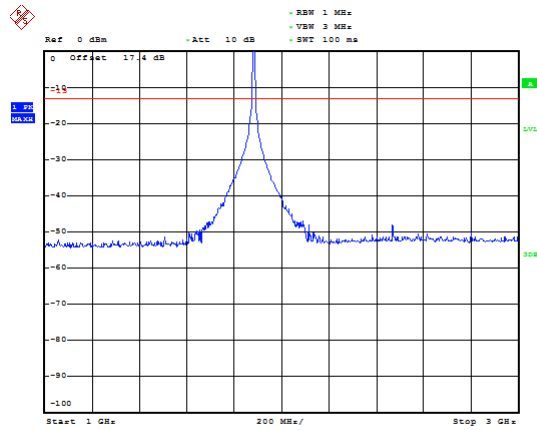

Date: 8.DEC.2018 10:39:35

### LTE Band 25 1.4MHz CH-Low 3GHz~20GHz

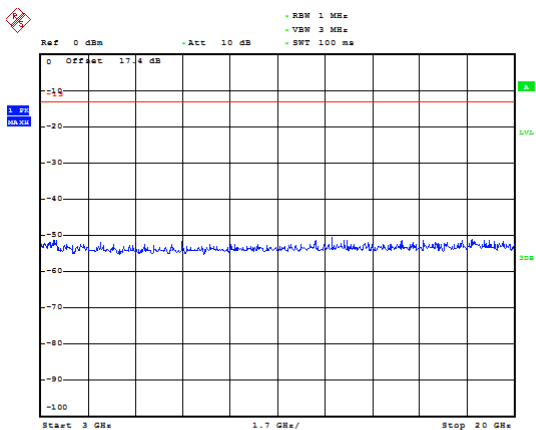

Date: 8.DEC.2018 10:32:43

### LTE Band 25 1.4MHz CH-Middle 3GHz~20GHz

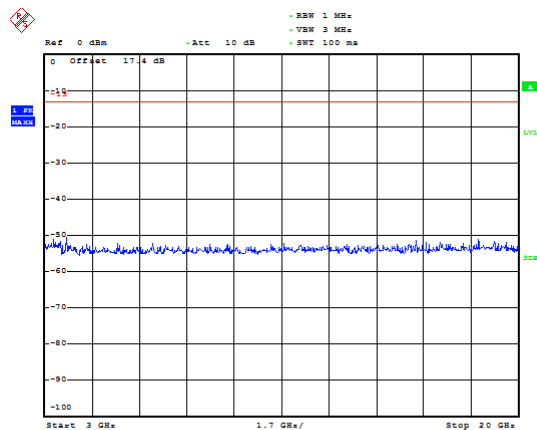

Date: 8.DEC.2018 10:48:26





### LTE Band 25 1.4MHz CH-High 30MHz~1GHz

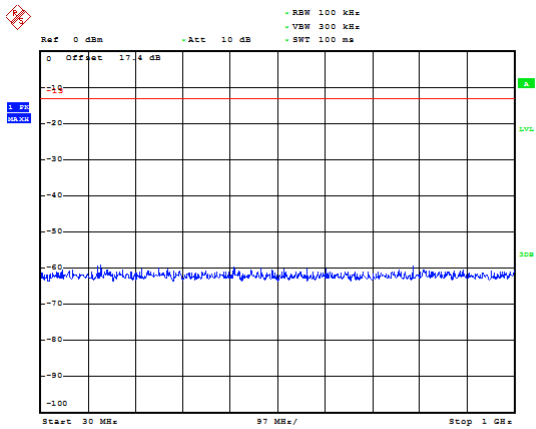

Date: 8.DEC.2018 10:52:08

### LTE Band 25 3MHz CH-Low 30MHz~1GHz

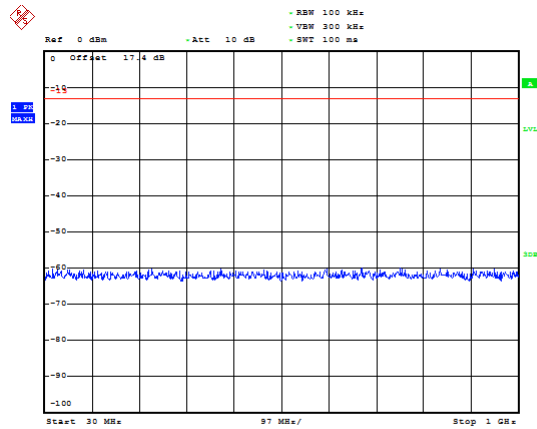

Date: 8.DEC.2018 10:53:21

### LTE Band 25 1.4MHz CH-High 1GHz~3GHz

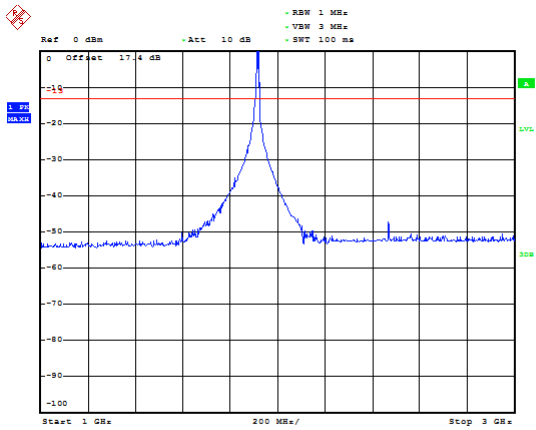

Date: 8.DEC.2018 10:51:51

### LTE Band 25 3MHz CH-Low 1GHz~3GHz

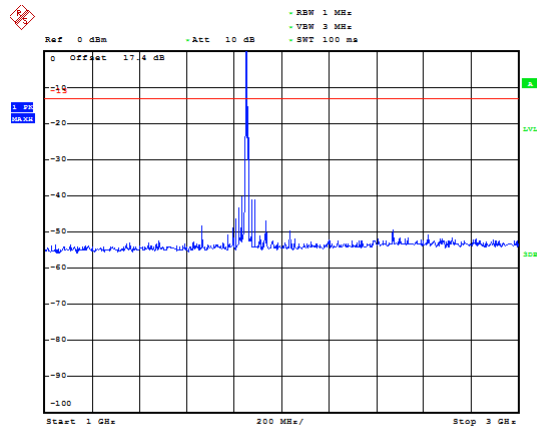

Date: 8.DEC.2018 10:53:39

### LTE Band 25 1.4MHz CH-High 3GHz~20GHz

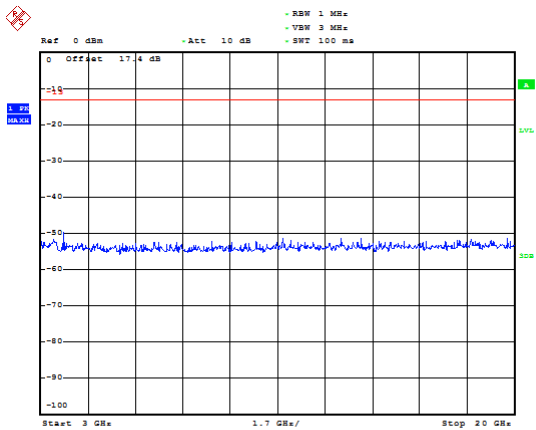

Date: 8.DEC.2018 10:50:28

### LTE Band 25 3MHz CH-Low 3GHz~20GHz

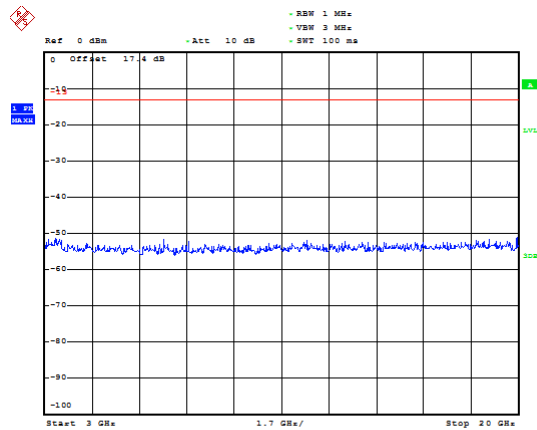

Date: 8.DEC.2018 10:53:54



### LTE Band 25 3MHz CH-Middle 30MHz~1GHz

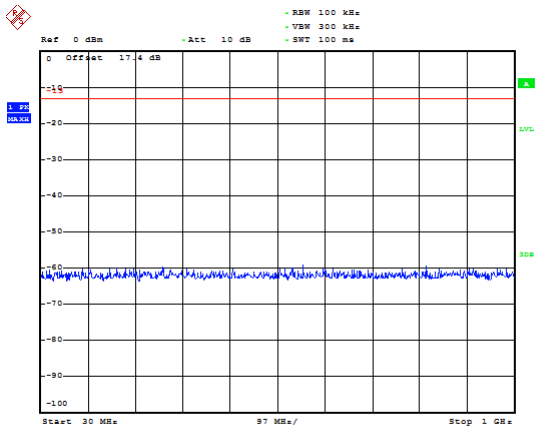

Date: 8.DEC.2018 10:36:14

### LTE Band 25 3MHz CH-High 30MHz~1GHz

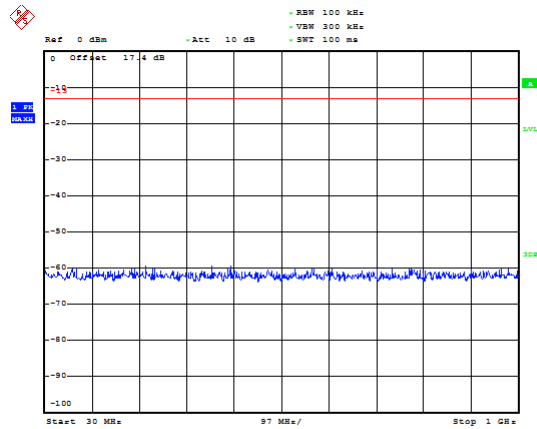

Date: 8.DEC.2018 10:54:59

### LTE Band 25 3MHz CH-Middle 1GHz~3GHz

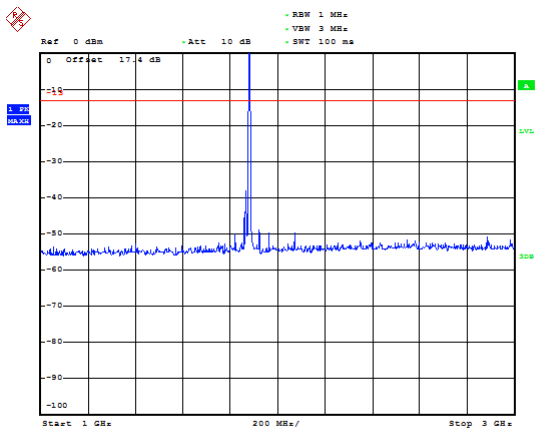

Date: 8.DEC.2018 10:44:10

### LTE Band 25 3MHz CH-High 1GHz~3GHz

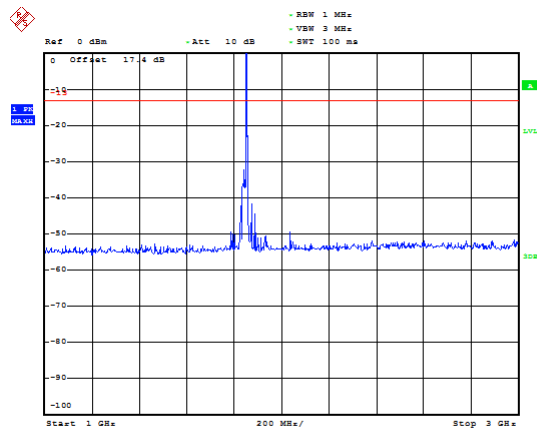

Date: 8.DEC.2018 10:54:38

### LTE Band 25 3MHz CH-Middle 3GHz~20GHz

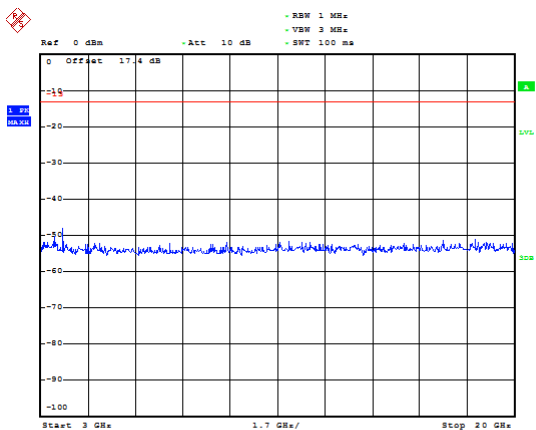

Date: 8.DEC.2018 10:48:07

### LTE Band 25 3MHz CH-High 3GHz~20GHz

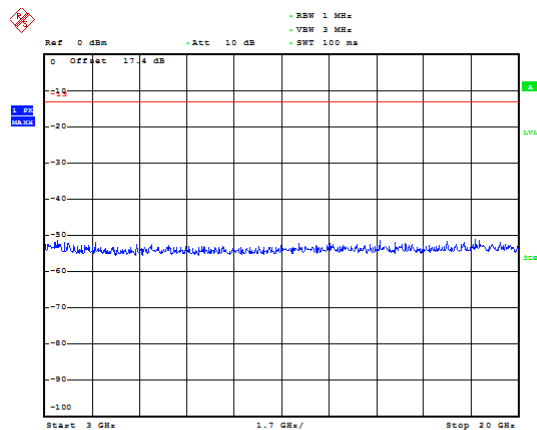

Date: 8.DEC.2018 10:54:21



### LTE Band 25 5MHz CH-Low 30MHz~1GHz

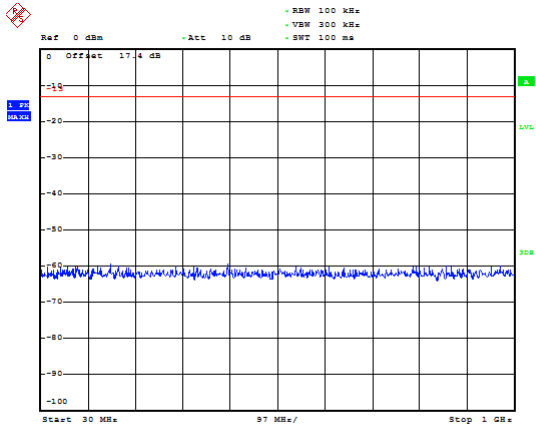

Date: 8.DEC.2018 10:56:34

### LTE Band 25 5MHz CH-Middle 30MHz~1GHz

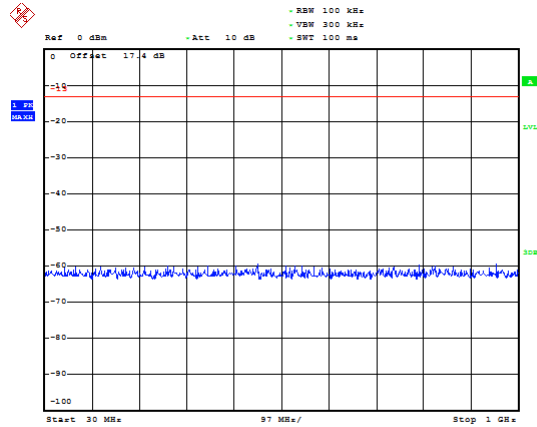

Date: 8.DEC.2018 10:56:32

### LTE Band 25 5MHz CH-Low 1GHz~3GHz

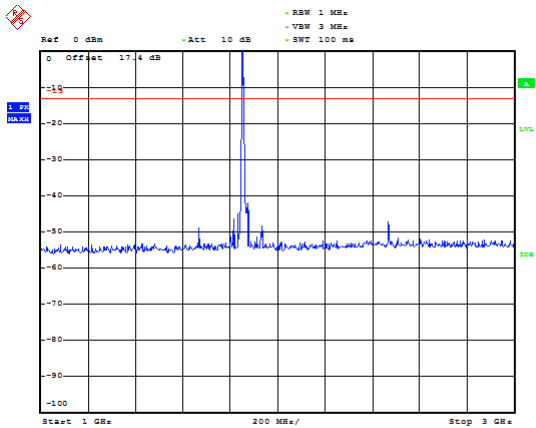

Date: 8.DEC.2018 10:56:52

### LTE Band 25 5MHz CH-Middle 1GHz~3GHz

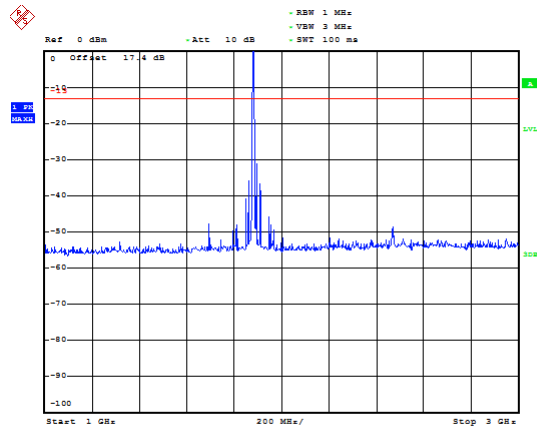

Date: 8.DEC.2018 10:44:31

### LTE Band 25 5MHz CH-Low 3GHz~20GHz

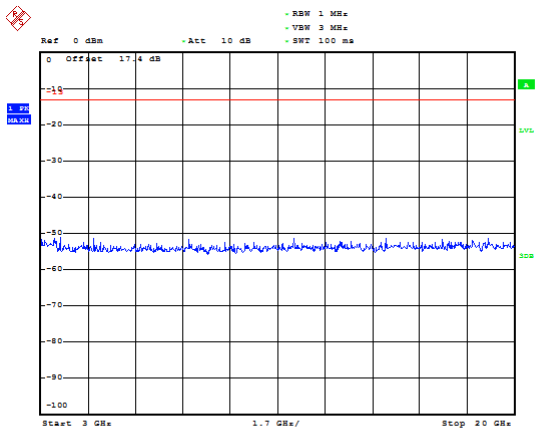

Date: 8.DEC.2018 10:57:07

### LTE Band 25 5MHz CH-Middle 3GHz~20GHz

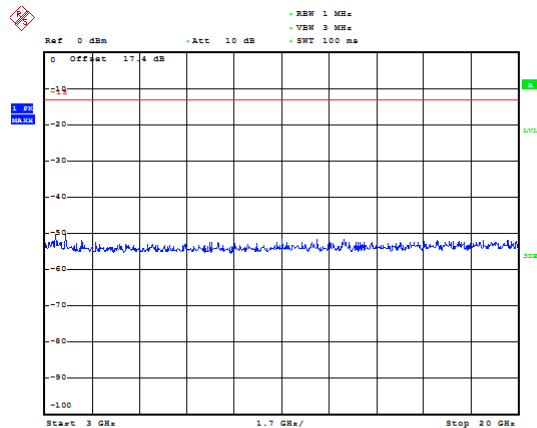

Date: 8.DEC.2018 10:47:54



### LTE Band 25 5MHz CH-High 30MHz~1GHz

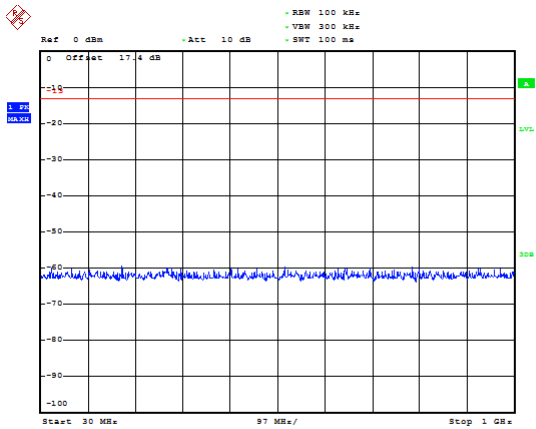

Date: 8.DEC.2018 10:59:30

### LTE Band 25 10MHz CH-Low 30MHz~1GHz

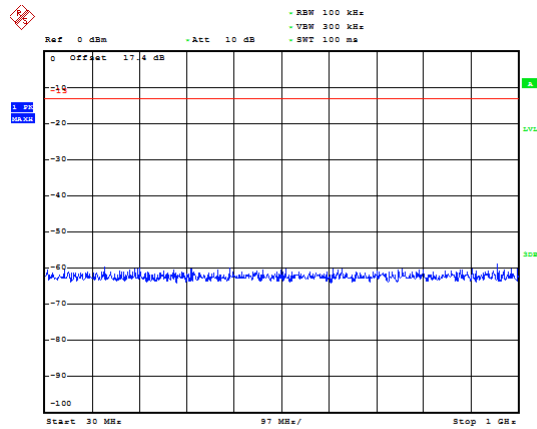

Date: 8.DEC.2018 11:00:06

### LTE Band 25 5MHz CH-High 1GHz~3GHz

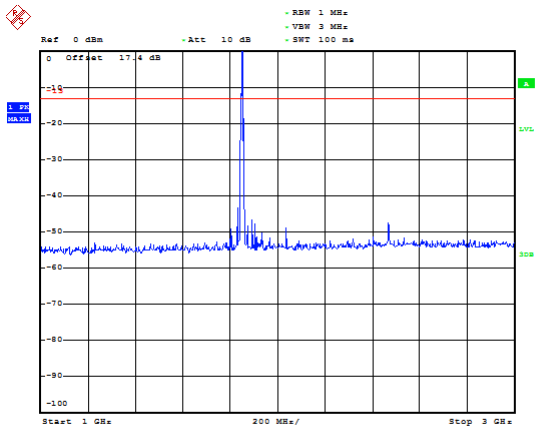

Date: 8.DEC.2018 10:58:20

### LTE Band 25 10MHz CH-Low 1GHz~3GHz

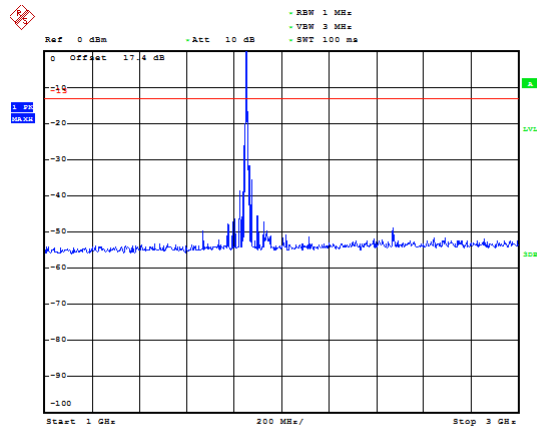

Date: 8.DEC.2018 11:00:20

### LTE Band 25 5MHz CH-High 3GHz~20GHz

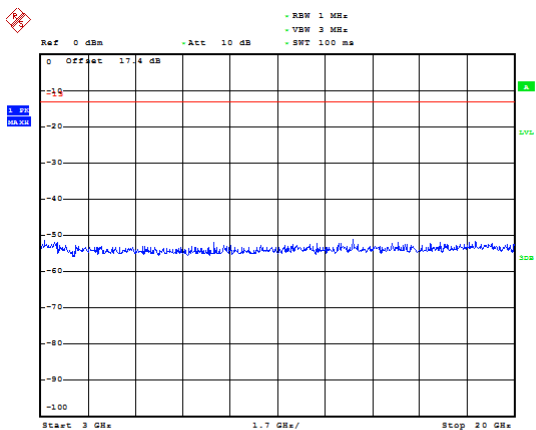

Date: 8.DEC.2018 10:58:05

### LTE Band 25 10MHz CH-Low 3GHz~20GHz

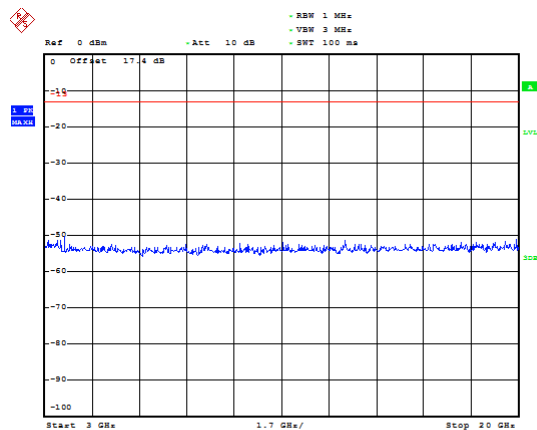

Date: 8.DEC.2018 11:00:32



### LTE Band 25 10MHz CH-Middle 30MHz~1GHz

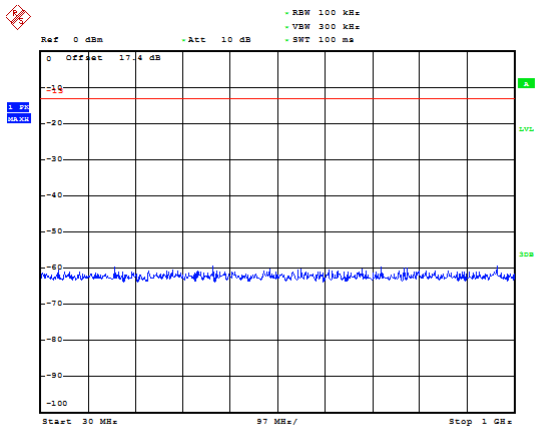

Date: 8.DEC.2018 10:36:55

### LTE Band 25 10MHz CH-High 30MHz~1GHz

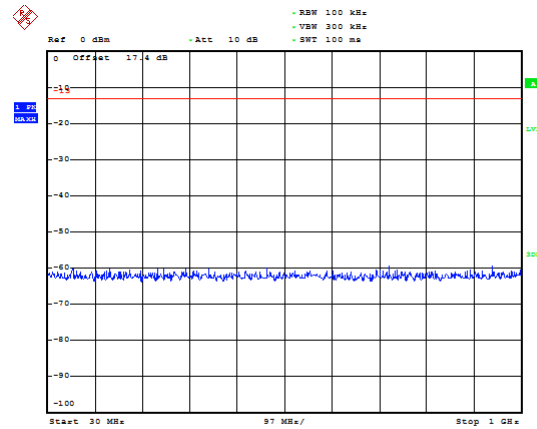

Date: 8.DEC.2018 11:01:51

### LTE Band 25 10MHz CH-Middle 1GHz~3GHz

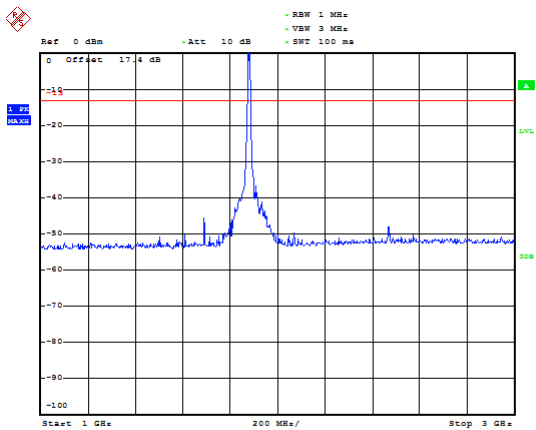

Date: 8.DEC.2018 10:45:56

### LTE Band 25 10MHz CH-High 1GHz~3GHz

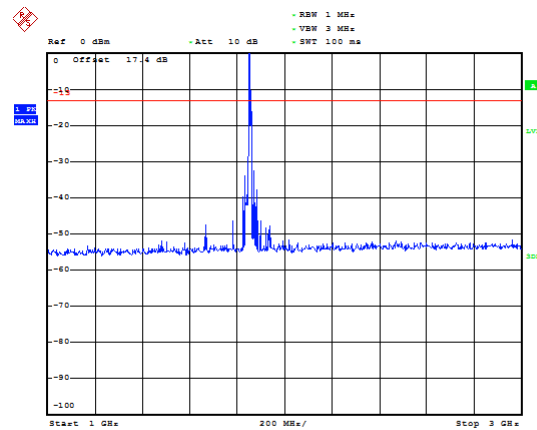

Date: 8.DEC.2018 11:01:16

### LTE Band 25 10MHz CH-Middle 3GHz~20GHz

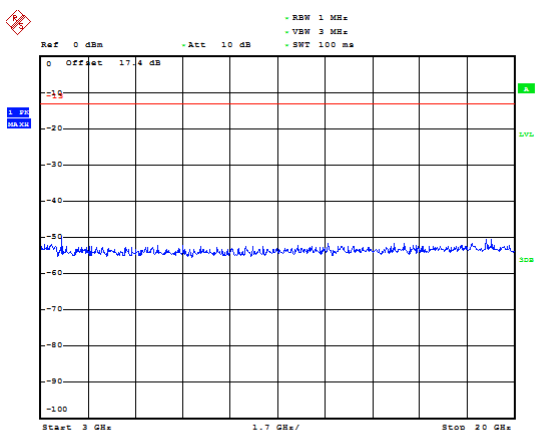

Date: 8.DEC.2018 10:47:09

### LTE Band 25 10MHz CH-High 3GHz~20GHz

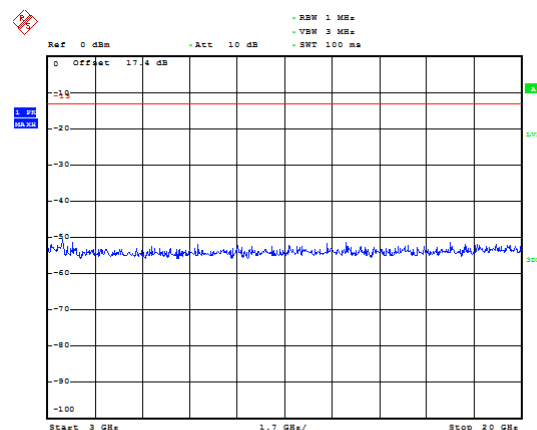

Date: 8.DEC.2018 11:01:02



### LTE Band 25 15MHz CH-Low 30MHz~1GHz

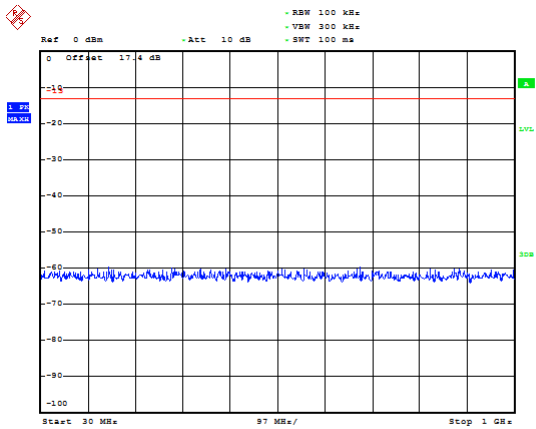

Date: 8.DEC.2018 11:02:42

### LTE Band 25 15MHz CH-Middle 30MHz~1GHz

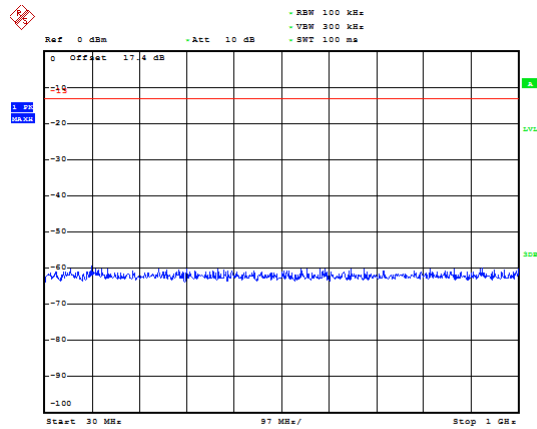

Date: 8.DEC.2018 10:37:08

### LTE Band 25 15MHz CH-Low 1GHz~3GHz

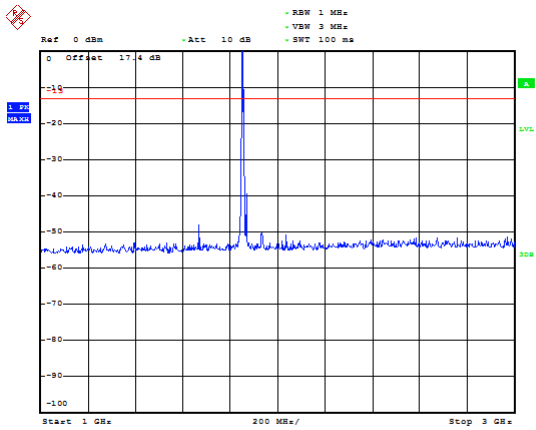

Date: 8.DEC.2018 11:03:07

### LTE Band 25 15MHz CH-Middle 1GHz~3GHz

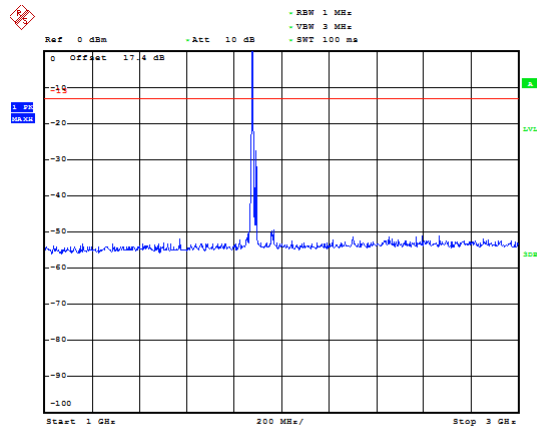

Date: 8.DEC.2018 10:46:11

### LTE Band 25 15MHz CH-Low 3GHz~20GHz

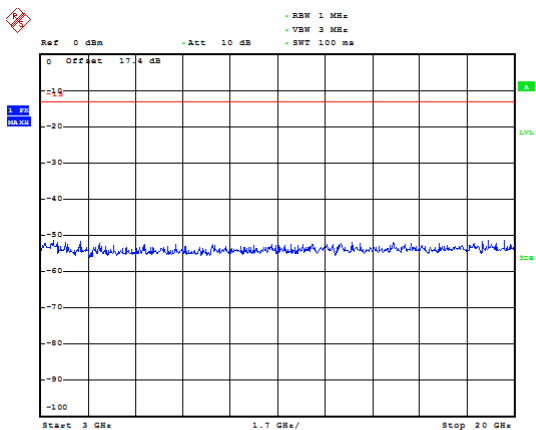

Date: 8.DEC.2018 11:03:19

### LTE Band 25 15MHz CH-Middle 3GHz~20GHz

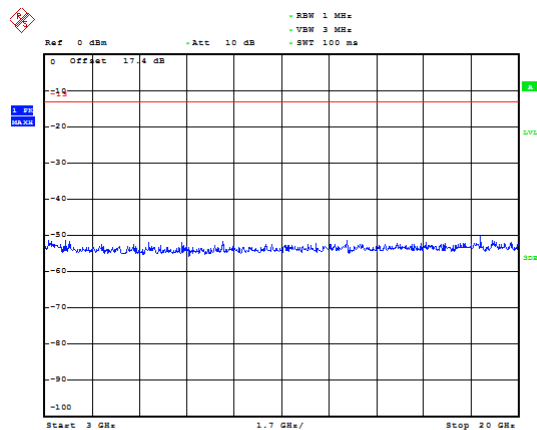

Date: 8.DEC.2018 10:46:49



### LTE Band 25 15MHz CH-High 30MHz~1GHz

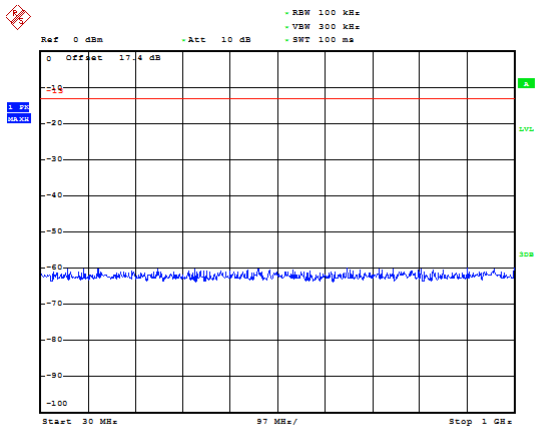

Date: 8.DEC.2018 11:04:20

### LTE Band 25 20MHz CH-Low 30MHz~1GHz

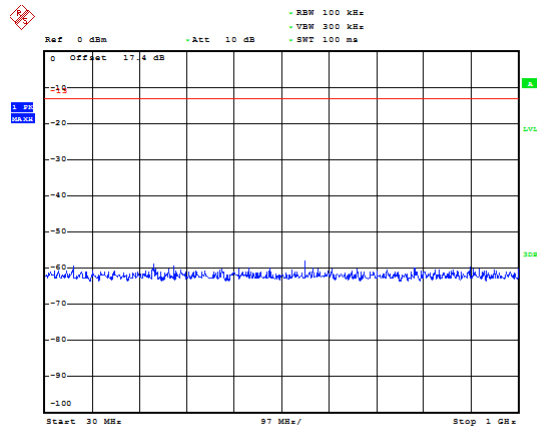

Date: 8.DEC.2018 11:06:14

### LTE Band 25 15MHz CH-High 1GHz~3GHz

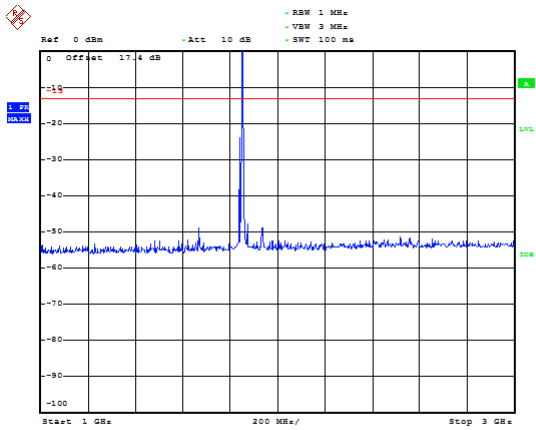

Date: 8.DEC.2018 11:09:59

### LTE Band 25 20MHz CH-Low 1GHz~3GHz

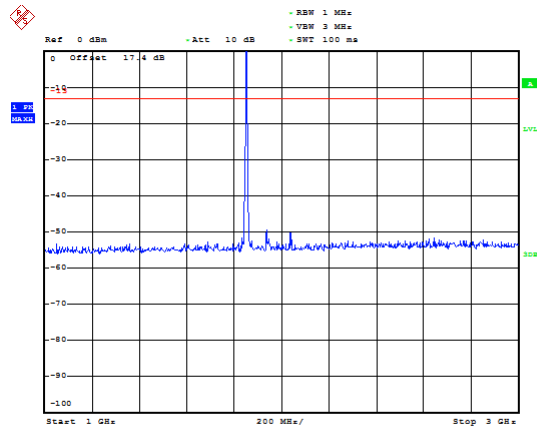

Date: 8.DEC.2018 11:06:36

### LTE Band 25 15MHz CH-High 3GHz~20GHz

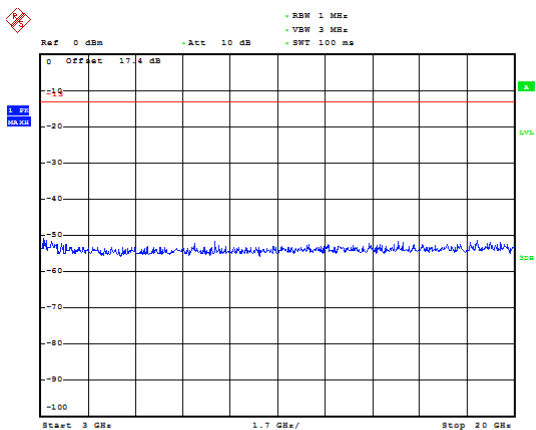

Date: 8.DEC.2018 11:09:46

### LTE Band 25 20MHz CH-Low 3GHz~20GHz

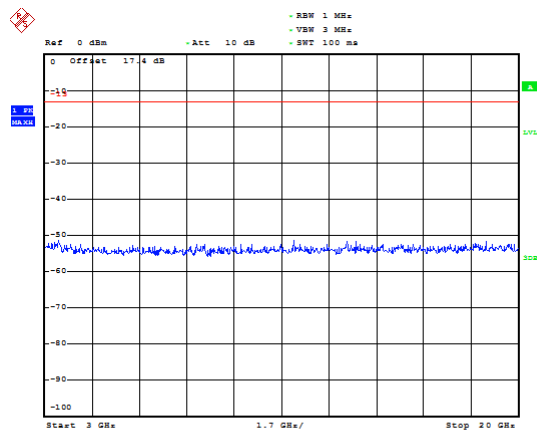

Date: 8.DEC.2018 11:06:46



### LTE Band 25 20MHz CH-Middle 30MHz~1GHz

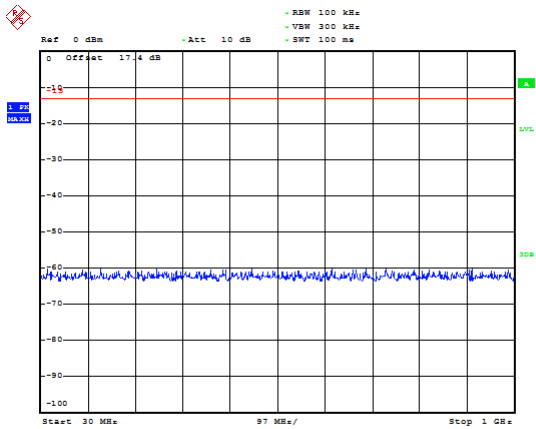

Date: 8.DEC.2018 10:37:22

### LTE Band 25 20MHz CH-High 30MHz~1GHz

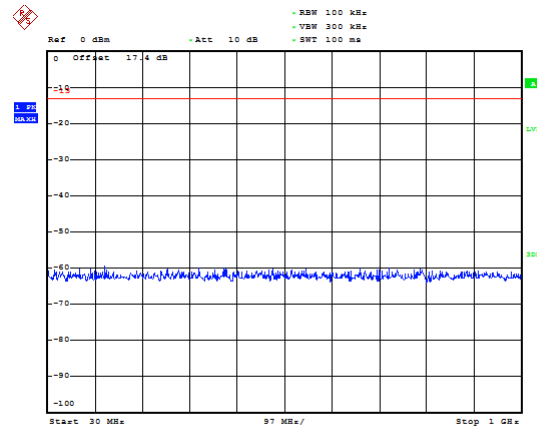

Date: 8.DEC.2018 11:07:52

### LTE Band 25 20MHz CH-Middle 1GHz~3GHz

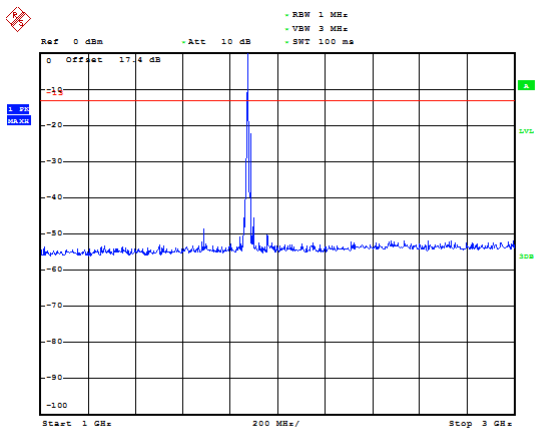

Date: 8.DEC.2018 10:37:57

### LTE Band 25 20MHz CH-High 1GHz~3GHz

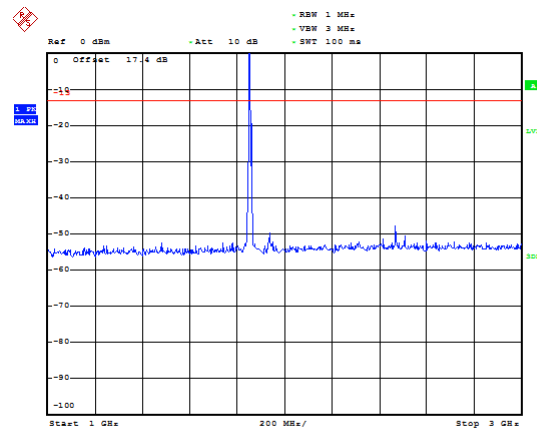

Date: 8.DEC.2018 11:07:26

### LTE Band 25 20MHz CH-Middle 3GHz~20GHz

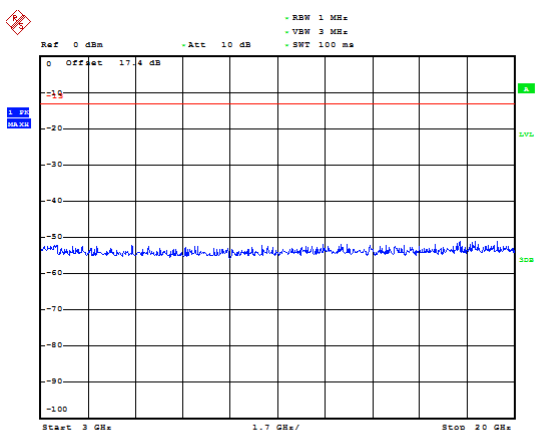

Date: 8.DEC.2018 10:47:23

### LTE Band 25 20MHz CH-High 3GHz~20GHz

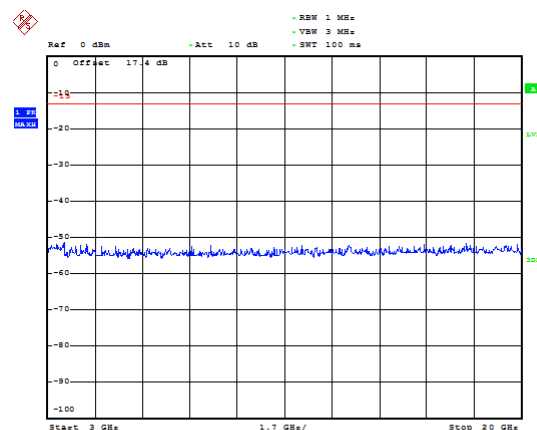

Date: 8.DEC.2018 11:07:16



## 5.8. Radiates Spurious Emission

### Ambient condition

Temperature	Relative humidity	Pressure
23°C ~25°C	45%~50%	101.5kPa

### Method of Measurement

1. The testing follows FCC KDB 971168 v03r01 Section 5.8 and ANSI C63.26 (2015).
2. Below 1GHz: The EUT is placed on a turntable 0.8 meters above the ground in the chamber, 3 meter away from the antenna. The maximal emission value is acquired by adjusting the antenna height, polarisation and turntable azimuth. Normally, the height range of antenna is 1 m to 4 m, the azimuth range of turntable is 0° to 360°, and the receive antenna has two polarizations Vertical (V) and Horizontal (H). Above 1GHz: (Note: the FCC's permission to use 1.5m as an alternative per TCBC Conf call of Dec. 2, 2014.) The EUT is placed on a turntable 1.5 meters above the ground in the chamber, 3 meter away from the antenna. The maximal emission value is acquired by adjusting the antenna height, polarisation and turntable azimuth. Normally, the height range of antenna is 1 m to 4 m, the azimuth range of turntable is 0° to 360°, and the receive antenna has two polarizations Vertical (V) and Horizontal (H).
3. A loop antenna, A log-periodic antenna or horn antenna shall be substituted in place of the EUT. The log-periodic antenna will be driven by a signal generator and the level will be adjusted till the same power value on the spectrum analyzer or receiver. The level of the spurious emissions can be calculated through the level of the signal generator, cable loss, the gain of the substitution antenna and the reading of the spectrum analyzer or receiver.
4. The EUT is then put into continuously transmitting mode at its maximum power level during the test. Set Test Receiver or Spectrum RBW=200Hz,VBW=600Hz for 9kHz150kHz , RBW=10kHz, VBW=30kHz 150kHz-30MHz , RBW=100kHz,VBW=300kHz for 30MHz to 1GHz and RBW=1MHz, VBW=3MHz for above 1GHz, And the maximum value of the receiver should be recorded as (Pr).
5. The EUT shall be replaced by a substitution antenna. In the chamber, an substitution antenna for the frequency band of interest is placed at the reference point of the chamber. An RF Signal source for the frequency band of interest is connected to the substitution antenna with a cable that has been constructed to not interfere with the radiation pattern of the antenna. A power (PMea) is applied to the input of the substitution antenna, and adjust the level of the signal generator output until the value of the receiver reach the previously recorded (Pr). The power of signal source (PMea) is recorded. The test should be performed by rotating the test item and adjusting the receiving antenna polarization.
6. A amplifier should be connected to the Signal Source output port. And the cable should be connect between the Amplifier and the Substitution Antenna. The cable loss (Pcl) ,the Substitution Antenna Gain (Ga) and the Amplifier Gain (PAg) should be recorded after test.
7. The measurement results are obtained as described below:  
$$\text{Power(EIRP)} = \text{PMea} - \text{PAg} - \text{Pcl} + \text{Ga}$$
  
The measurement results are amend as described below:  
$$\text{Power(EIRP)} = \text{PMea} - \text{Pcl} + \text{Ga}$$
8. This value is EIRP since the measurement is calibrated using an antenna of known gain (2.15 dBi)

and known input power. ERP can be calculated from EIRP by subtracting the gain of the dipole,  $ERP = EIRP - 2.15\text{dBi}$ .

The modulation mode and RB allocation refer to section 5.1, using the maximum output power configuration.

**Test setup**

**9KHz ~ 30MHz**

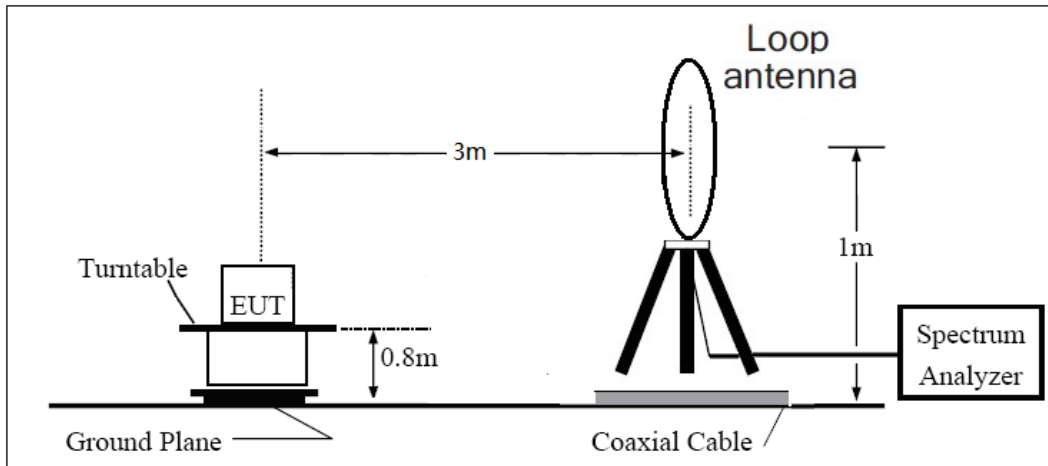

**30MHz ~ 1GHz**

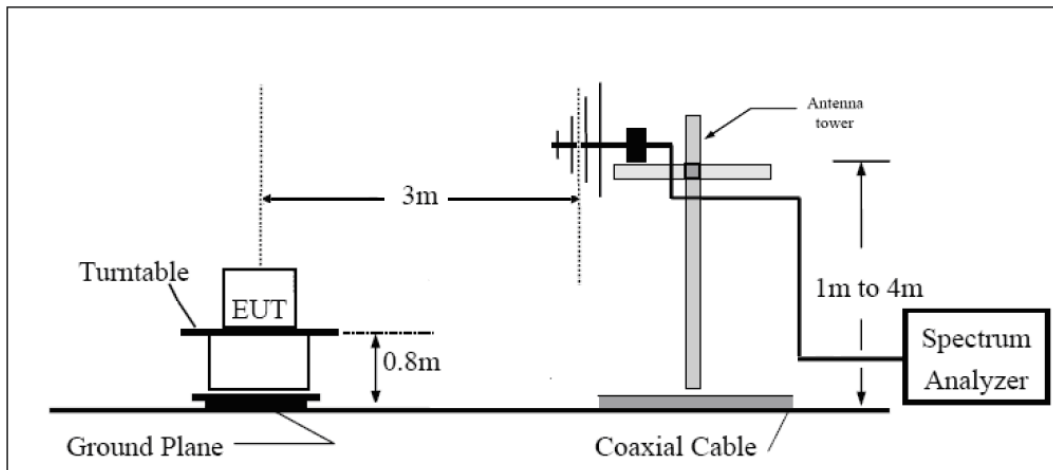

**Above 1GHz**

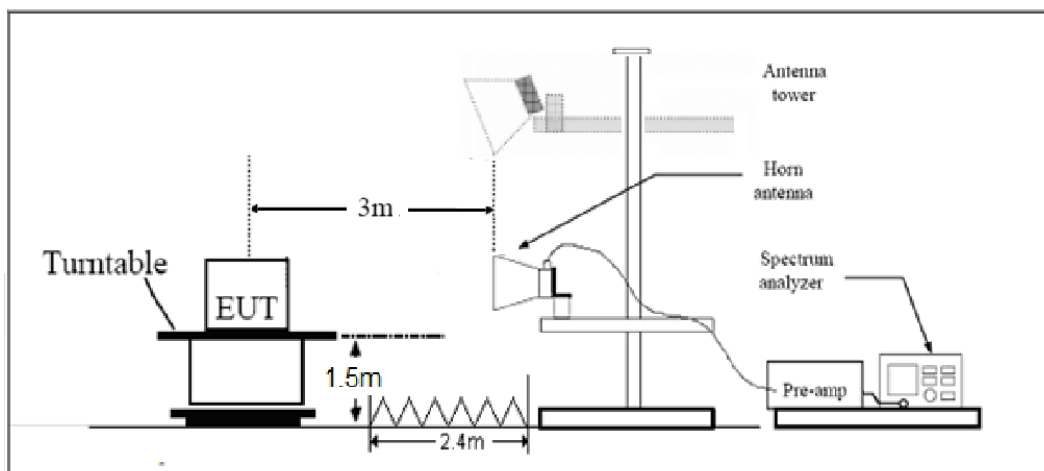



Note: Area side: 2.4mX3.6m

### Limits

Rule Part 24.238(a) specifies that “on any frequency outside a licensee's frequency block, the power of any emission shall be attenuated below the transmitter power (P) by at least  $43 + 10 \log_{10}(P)$  dB.”

Limit	-13 dBm
-------	---------

### Measurement Uncertainty

The assessed measurement uncertainty to ensure 95% confidence level for the normal distribution is with the coverage factor  $k = 1.96$ ,  $U = 3.55$  dB.

**Test Result**

Sweep the whole frequency band through the range from 9kHz to the 10th harmonic of the carrier, the emissions below the noise floor will not be recorded in the report.

**GSM 1900 CH-Low**

Harmonic	Frequency (MHz)	SG (dBm)	Cable Loss (dB)	Gain (dBi)	Antenna Polarization	EIRP Level (dBm)	Limit (dBm)	Margin (dB)	Azimuth (deg)
2	3700	-53.75	5.1	11.05	vertical	-47.8	-13.0	34.8	135
3	5551	-53.93	5.42	12.65	vertical	-46.7	-13.0	33.7	45
4	7401	-49.75	6.7	13.85	vertical	-42.6	-13.0	29.6	180
5	9251	-48.94	7.01	14.75	vertical	-41.2	-13.0	28.2	270
6	11101	-46.07	7.48	15.95	vertical	-37.6	-13.0	24.6	135
7	12951	-45.64	7.51	16.55	vertical	-36.6	-13.0	23.6	45
8	14802	-43.31	8.24	15.35	vertical	-36.2	-13.0	23.2	270
9	16652	-40.64	8.41	14.95	vertical	-34.1	-13.0	21.1	180
10	18502	-40.31	8.54	15.45	vertical	-33.4	-13.0	20.4	270

Note: 1.The other Spurious RF Radiated emissions level is no more than noise floor.  
2.The worst emission was found in the antenna is vertical position.

**GSM 1900 CH-Middle**

Harmonic	Frequency (MHz)	SG (dBm)	Cable Loss (dB)	Gain (dBi)	Antenna Polarization	EIRP Level (dBm)	Limit (dBm)	Margin (dB)	Azimuth (deg)
2	3760	-53.25	5.1	11.05	vertical	-47.3	-13.0	34.3	135
3	5640	-53.43	5.42	12.65	vertical	-46.2	-13.0	33.2	45
4	7520	-49.25	6.7	13.85	vertical	-42.1	-13.0	29.1	180
5	9400	-47.94	7.01	14.75	vertical	-40.2	-13.0	27.2	270
6	11280	-45.47	7.48	15.95	vertical	-37.0	-13.0	24.0	135
7	13160	-45.34	7.51	16.55	vertical	-36.3	-13.0	23.3	45
8	15040	-43.11	8.24	15.35	vertical	-36.0	-13.0	23.0	270
9	16920	-40.64	8.41	14.95	vertical	-34.1	-13.0	21.1	180
10	18800	-40.21	8.54	15.45	vertical	-33.3	-13.0	20.3	270

Note: 1.The other Spurious RF Radiated emissions level is no more than noise floor.  
2. The worst emission was found in the antenna is vertical position.

GSM 1900 CH-High

Harmonic	Frequency (MHz)	SG (dBm)	Cable Loss (dB)	Gain (dBi)	Antenna Polarization	EIRP Level (dBm)	Limit (dBm)	Margin (dB)	Azimuth (deg)
2	3819	-53.15	5.1	11.05	vertical	-47.2	-13.0	34.2	135
3	5730	-52.43	5.42	12.65	vertical	-45.2	-13.0	32.2	45
4	7639	-49.25	6.7	13.85	vertical	-42.1	-13.0	29.1	180
5	9549	-47.94	7.01	14.75	vertical	-40.2	-13.0	27.2	270
6	11459	-45.47	7.48	15.95	vertical	-37.0	-13.0	24.0	135
7	13369	-45.24	7.51	16.55	vertical	-36.2	-13.0	23.2	45
8	15278	-42.81	8.24	15.35	vertical	-35.7	-13.0	22.7	180
9	17188	-40.64	8.41	14.95	vertical	-34.1	-13.0	21.1	225
10	19098	-40.61	8.54	15.45	vertical	-33.7	-13.0	20.7	135

Note: 1.The other Spurious RF Radiated emissions level is no more than noise floor.  
 2. The worst emission was found in the antenna is vertical position.

LTE Band 2 20MHz CH-Low

Harmonic	Frequency (MHz)	SG (dBm)	Cable Loss (dB)	Gain (dBi)	Antenna Polarization	EIRP Level (dBm)	Limit (dBm)	Margin (dB)	Azimuth (deg)
2	3720.0	-55.25	5.10	11.05	vertical	-49.3	-13.0	36.3	90
3	5580.0	-56.03	5.42	12.65	vertical	-48.8	-13.0	35.8	225
4	7440.0	-48.15	6.70	13.85	vertical	-41.0	-13.0	28.0	45
5	9300.0	-46.44	7.01	14.75	vertical	-38.7	-13.0	25.7	135
6	11160.0	-46.57	7.48	15.95	vertical	-38.1	-13.0	25.1	45
7	13020.0	-45.14	7.51	16.55	vertical	-36.1	-13.0	23.1	90
8	14880.0	-41.11	8.24	15.35	vertical	-34.0	-13.0	21.0	225
9	16740.0	-41.94	8.41	14.95	vertical	-35.4	-13.0	22.4	45
10	18600.0	-41.41	8.54	15.45	vertical	-34.5	-13.0	21.5	90

Note: 1.The other Spurious RF Radiated emissions level is no more than noise floor.  
 2.The worst emission was found in the antenna is vertical position.

LTE Band 2 20MHz CH-Middle

Harmonic	Frequency (MHz)	SG (dBm)	Cable Loss (dB)	Gain (dBi)	Antenna Polarization	EIRP Level (dBm)	Limit (dBm)	Margin (dB)	Azimuth (deg)
2	3760.0	-55.25	5.10	11.05	vertical	-49.3	-13.0	36.3	135
3	5640.0	-55.43	5.42	12.65	vertical	-48.2	-13.0	35.2	270
4	7520.0	-49.85	6.70	13.85	vertical	-42.7	-13.0	29.7	225
5	9400.0	-48.74	7.01	14.75	vertical	-41.0	-13.0	28.0	225
6	11280.0	-46.17	7.48	15.95	vertical	-37.7	-13.0	24.7	135
7	13160.0	-46.24	7.51	16.55	vertical	-37.2	-13.0	24.2	90
8	15040.0	-42.31	8.24	15.35	vertical	-35.2	-13.0	22.2	225
9	16920.0	-40.24	8.41	14.95	vertical	-33.7	-13.0	20.7	45
10	18800.0	-40.21	8.54	15.45	vertical	-33.3	-13.0	20.3	135

Note: 1.The other Spurious RF Radiated emissions level is no more than noise floor.  
 2.The worst emission was found in the antenna is vertical position.

LTE Band 2 20MHz CH-High

Harmonic	Frequency (MHz)	SG (dBm)	Cable Loss (dB)	Gain (dBi)	Antenna Polarization	EIRP Level (dBm)	Limit (dBm)	Margin (dB)	Azimuth (deg)
2	3800.0	-55.15	5.10	11.05	vertical	-49.2	-13.0	36.2	45
3	5700.0	-55.93	5.42	12.65	vertical	-48.7	-13.0	35.7	180
4	7600.0	-48.45	6.70	13.85	vertical	-41.3	-13.0	28.3	225
5	9500.0	-49.24	7.01	14.75	vertical	-41.5	-13.0	28.5	135
6	11400.0	-44.47	7.48	15.95	vertical	-36.0	-13.0	23.0	225
7	13300.0	-46.04	7.51	16.55	vertical	-37.0	-13.0	24.0	90
8	15200.0	-44.11	8.24	15.35	vertical	-37.0	-13.0	24.0	90
9	17100.0	-41.54	8.41	14.95	vertical	-35.0	-13.0	22.0	45
10	19000.0	-40.81	8.54	15.45	vertical	-33.9	-13.0	20.9	180

Note: 1.The other Spurious RF Radiated emissions level is no more than noise floor.  
 2.The worst emission was found in the antenna is vertical position.



## LTE Band 25 20MHz CH-Low

Harmonic	Frequency (MHz)	SG (dBm)	Cable Loss (dB)	Gain (dBi)	Antenna Polarization	EIRP Level (dBm)	Limit (dBm)	Margin (dB)	Azimuth (deg)
2	3765.0	-55.15	5.10	11.05	Horizontal	-49.20	-13.00	36.20	315
3	5647.5	-60.94	5.42	12.65	Horizontal	-53.71	-13.00	40.71	45
4	7530.0	-56.73	6.70	13.85	Horizontal	-49.58	-13.00	36.58	90
5	9412.5	-55.94	7.01	14.75	Horizontal	-48.20	-13.00	35.20	270
6	11295.0	-54.45	7.48	15.95	Horizontal	-45.98	-13.00	32.98	225
7	13177.5	-55.27	7.51	16.55	Horizontal	-46.23	-13.00	33.23	135
8	15060.0	-52.91	8.24	15.35	Horizontal	-45.80	-13.00	32.80	90
9	16942.5	-50.31	8.41	14.95	Horizontal	-43.77	-13.00	30.77	45
10	18825.0	-	-	-	-	-	-	-	-

Note: 1. The other Spurious RF Radiated emissions level is no more than noise floor.  
2. The worst emission was found in the antenna is Horizontal position.

## LTE Band 25 20MHz CH-Middle

Harmonic	Frequency (MHz)	SG (dBm)	Cable Loss (dB)	Gain (dBi)	Antenna Polarization	EIRP Level (dBm)	Limit (dBm)	Margin (dB)	Azimuth (deg)
2	3720.0	-50.91	5.10	11.05	Horizontal	-44.96	-13.00	31.96	270
3	5580.0	-61.43	5.42	12.65	Horizontal	-54.20	-13.00	41.20	135
4	7440.0	-56.15	6.70	13.85	Horizontal	-49.00	-13.00	36.00	45
5	9300.0	-56.13	7.01	14.75	Horizontal	-48.39	-13.00	35.39	90
6	11160.0	-54.31	7.48	15.95	Horizontal	-45.84	-13.00	32.84	225
7	13020.0	-54.86	7.51	16.55	Horizontal	-45.82	-13.00	32.82	0
8	14880.0	-51.57	8.24	15.35	Horizontal	-44.46	-13.00	31.46	45
9	16740.0	-50.81	8.41	14.95	Horizontal	-44.27	-13.00	31.27	135
10	18600.0	-	-	-	-	-	-	-	-

Note: 1. The other Spurious RF Radiated emissions level is no more than noise floor.  
2. The worst emission was found in the antenna is Horizontal position.



## LTE Band 25 20MHz CH-High

Harmonic	Frequency (MHz)	SG (dBm)	Cable Loss (dB)	Gain (dBi)	Antenna Polarization	EIRP Level (dBm)	Limit (dBm)	Margin (dB)	Azimuth (deg)
2	3810.0	-52.37	5.10	11.05	Horizontal	-46.42	-13.00	33.42	45
3	5715.0	-61.11	5.42	12.65	Horizontal	-53.88	-13.00	40.88	135
4	7620.0	-56.40	6.70	13.85	Horizontal	-49.25	-13.00	36.25	90
5	9525.0	-56.03	7.01	14.75	Horizontal	-48.29	-13.00	35.29	225
6	11430.0	-53.86	7.48	15.95	Horizontal	-45.39	-13.00	32.39	45
7	13335.0	-53.87	7.51	16.55	Horizontal	-44.83	-13.00	31.83	90
8	15240.0	-53.62	8.24	15.35	Horizontal	-46.51	-13.00	33.51	135
9	17145.0	-50.64	8.41	14.95	Horizontal	-44.10	-13.00	31.10	315
10	19050.0	-	-	-	-	-	-	-	-

Note: 1. The other Spurious RF Radiated emissions level is no more than noise floor.

2. The worst emission was found in the antenna is Horizontal position.



## 6. Main Test Instruments

Name	Manufacturer	Type	Serial Number	Calibration Date	Expiration Date
Base Station Simulator	R&S	CMU200	118133	2018-05-13	2019-05-12
Base Station Simulator	R&S	CMW500	113824	2018-05-20	2019-05-19
Power Splitter	Hua Xiang	SHX-GF2-2-13	10120101	/	/
Spectrum Analyzer	Key sight	N9010A	MY50210259	2018-05-20	2019-05-19
Universal Radio Communication Tester	Key sight	E5515C	MY48367192	2018-05-20	2019-05-19
Signal Analyzer	R&S	FSV30	100815	2018-12-16	2019-12-15
Loop Antenna	SCHWARZBECK	FMZB1519	1519-047	2017-09-26	2019-09-25
Trilog Antenna	SCHWARZBECK	VUBL 9163	9163-201	2017-11-18	2019-11-17
Horn Antenna	R&S	HF907	100126	2018-07-07	2020-07-06
Horn Antenna	ETS-Lindgren	3160-09	00102643	2018-06-20	2020-06-19
Signal generator	R&S	SMB 100A	102594	2018-05-20	2019-05-19
Climatic Chamber	ESPEC	SU-242	93000506	2017-12-17	2020-12-16
Preamplifier	R&S	SCU18	102327	2018-05-20	2019-05-19
MOB COMMS DC SUPPLY	Keysight	66319D	MY43004105	2018-05-07	2019-05-06
RF Cable	Agilent	SMA 15cm	0001	/	/
Software	R&S	EMC32	9.26.0	/	/

\*\*\*\*\*END OF REPORT \*\*\*\*\*

## ANNEX A: EUT Appearance and Test Setup

### A.1 EUT Appearance



shielding



No shielding  
Front Side

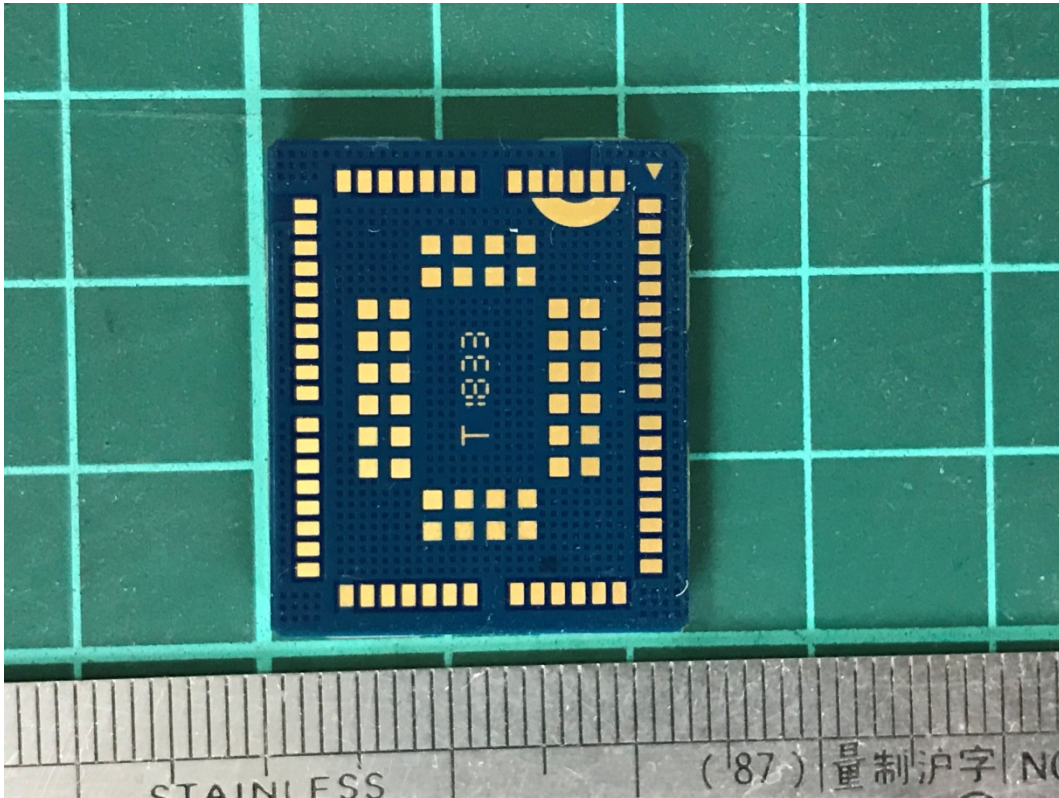

Back Side

a: EUT

Picture 1 EUT

## A.2 Test Setup

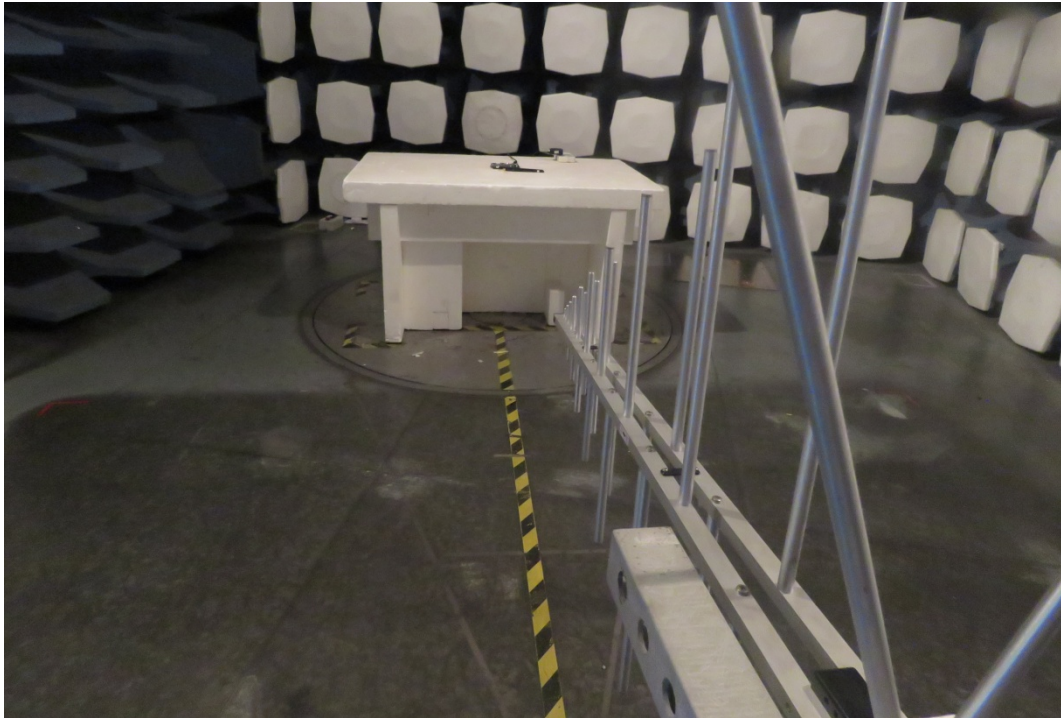

Below 1G

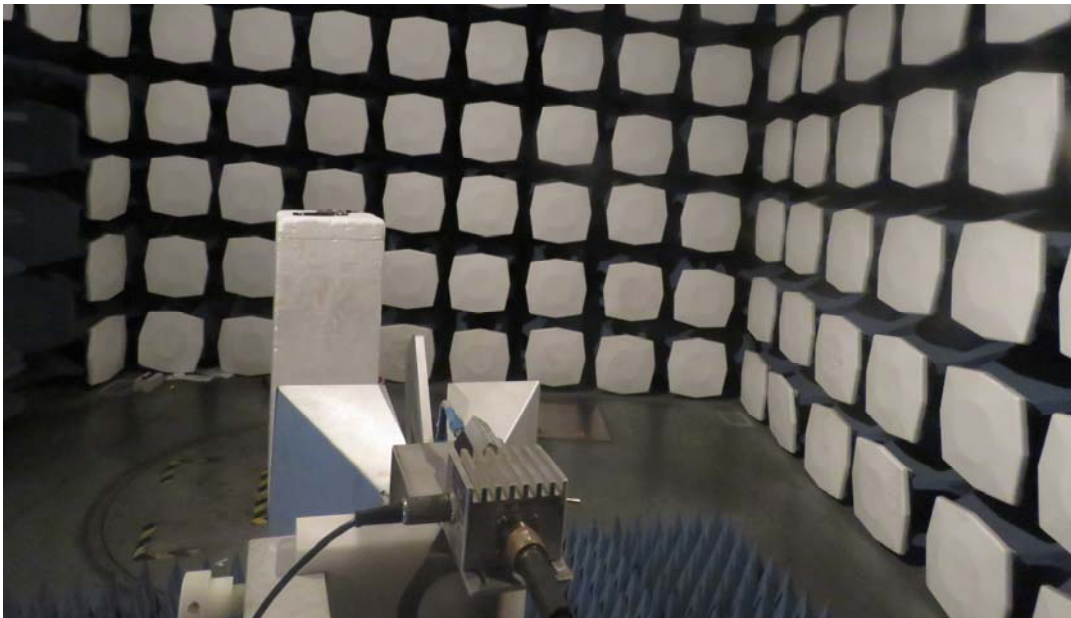

Above 1G

**Picture 2 Radiated Spurious Emissions Test setup**

## ANNEX B: Product Change Description



# BG96 R1.1 & BG96 R1.2 Differences Statement

LTE Module Series

PCB Rev.: R1.2

Date: 2018-10-08



[www.quectel.com](http://www.quectel.com)

Build a Smarter World



Based on BG96 R1.1, BG96 R1.2 has enabled VDD\_QFPROM\_PRG hardware interface, which is connected to ground directly in BG96 R1.1, so as to support secure boot feature.

Some points are highlighted as below:

- BG96 R1.1 and R1.2 versions share the same hardware architecture and key components.
- BG96 R1.1 and R1.2 versions share the same pinout placements.
- Secure boot is enabled through a set of hardware fuses in BG96 R1.2. For the code to be executed, it must be signed by the trusted entity identified in the hardware fuses, so we have to enable VDD\_QFPROM\_PRG hardware interface.
- The new hardware will be used with the new software baseline TX3.0, and the software version is R04Axx.

The details are illustrated as below:

### 1. What's Secure Boot

Secure boot refers to the bootup sequence that establishes a trusted platform for secure applications. It starts as an immutable sequence that validates the origin of the code using cryptographic authentication so only authorized software can be executed. The bootup sequence places the device in a known security state and protects against binary manipulation of software and reflashing attacks.

A secure boot system adds cryptographic checks to each stage of the boot up process. This process asserts the authenticity of all secure software images that are executed by the device. This additional check prevents any unauthorized or maliciously modified software from running on the device. Secure boot is enabled through a set of hardware fuses. For the code to be executed, it must be signed by the trusted entity identified in the hardware fuses.

In simple terms, secure boot ensures running of signed/authorized software on the module, and unsigned/unauthorized software will not be allowed to run.

### 2. Enabled VDD\_QFPROM\_PRG Hardware Interface

#### A. BG96 R1.1 does not support secure boot function

The VDD\_QFPROM\_PRG (N19) pin of baseband chip is for secure boot function. In BG96 R1.1, this pin is connected to ground directly, which means secure boot function is disabled.

#### B. BG96 R1.2 supports secure boot function

According to Qualcomm's suggestion and our customers' requirements, the VDD\_QFPROM\_PRG pin is connected to VREG\_L3\_1P8(1.8V) in BG96 R1.2 so as to enable secure boot function.

The following pictures show the schematic and PCB designs of BG96 R1.1 and R1.2.

Build a Smarter World



Figure 1: Schematic Designs of BG96 R1.1 and R1.2

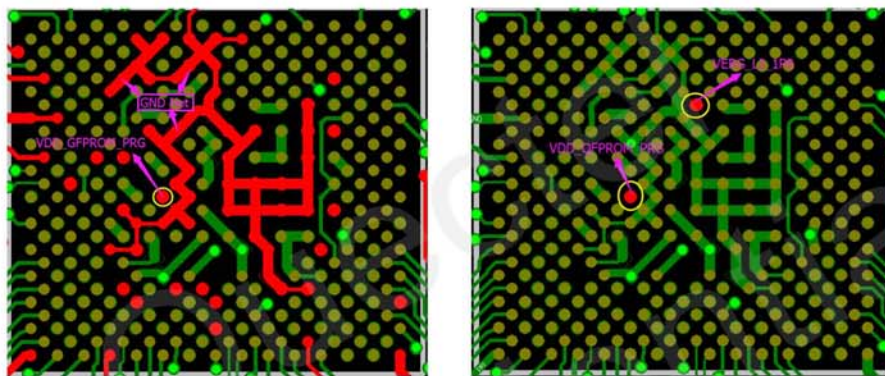

Figure 2: PCB Designs of BG96 R1.1 and R1.2

### 3. TX2.0 vs TX3.0

The biggest difference of TX3.0 as compared with TX2.0 lies in the adding of VoLTE and handover features. Since VoLTE environment has not been built so maturely yet, the main concern of customers is the handover function.

For TX2.0, re-selection is supported, while handover is not supported.

BG96 supports re-selection mechanism, which means when disconnection happens during cell handover, the module will reconnect automatically. This process lasts for about 1 (or 2) seconds, and the data transmitted (may happen by coincidence) will be buffered and resent once the reconnection established. So, the disconnection is generally imperceptible to customers.

- If the data transmission occurs at the moment that cell handover occurs coincidentally, the connection is kept with handover function; the connection is broken and re-connection established in about 1 (or 2) seconds with re-selection. This causes nearly no difference for data telematics because users even cannot feel this disconnection, whereas VoLTE might be affected because of the short time disconnection.



Build a Smarter World



- If the data transmission occurs in the period that no cell alternates, then no any influence will be caused.

Quectel  
Confidential