



RF TEST REPORT

Applicant Quetel Wireless Solutions Co., Ltd.
FCC ID XMR201707BG96
Product LTE Cat M1 & Cat NB1 & EGPRS Module
Brand Quetel
Model BG96, BG96 MINIPCIE
Marketing Quetel BG96, Quetel BG96 MINIPCIE
Report No. R1811A0536-R5
Issue Date February 26, 2019

TA Technology (Shanghai) Co., Ltd. tested the above equipment in accordance with the requirements in **FCC CFR47 Part 2 (2018)/ FCC CFR 47 Part 24E (2018)**. The test results show that the equipment tested is capable of demonstrating compliance with the requirements as documented in this report.

Performed by: Peng Tao

Approved by: Kai Xu

TA Technology (Shanghai) Co., Ltd.

No.145, Jintang Rd, Tangzhen Industry Park, Pudong Shanghai, China

TEL: +86-021-50791141/2/3

FAX: +86-021-50791141/2/3-8000



TABLE OF CONTENT

1. Test Laboratory	4
1.1. Notes of the test report.....	4
1.2. Test facility.....	4
1.3. Testing Location	5
2. General Description of Equipment under Test.....	6
3. Applied Standards.....	7
4. Test Configuration.....	8
5. Test Case Results.....	9
5.1. RF Power Output.....	9
5.2. Effective Isotropic Radiated Power	11
5.3. Occupied Bandwidth	14
5.4. Band Edge Compliance.....	22
5.5. Peak-to-Average Power Ratio (PAPR)	27
5.6. Frequency Stability	29
5.7. Spurious Emissions at Antenna Terminals	33
5.8. Radiates Spurious Emission	37
6. Main Test Instruments	43
ANNEX A: EUT Appearance and Test Setup.....	44
A.1 EUT Appearance	44
A.2 Test Setup.....	46
ANNEX B: Product Change Description.....	47

Summary of measurement results

No.	Test Case	Clause in FCC rules	Verdict
1	RF power output	2.1046	PASS
2	Effective Isotropic Radiated power	24.232(c)	PASS
3	Occupied Bandwidth	2.1049	PASS
4	Band Edge Compliance	2.1051 /24.238(a)	PASS
5	Peak-to-Average Power Ratio	24.232/KDB 971168 D01(5.7)	PASS
6	Frequency Stability	2.1055 / 24.235	PASS
7	Spurious Emissions at Antenna Terminals	2.1051 / 24.238(a)	PASS
8	Radiates Spurious Emission	2.1053 / 24.238(a)	PASS
Date of Testing: August 4, 2017 ~ August 18, 2017 and December 20, 2018 ~ February 13, 2019			
Note: PASS: The EUT complies with the essential requirements in the standard. FAIL: The EUT does not comply with the essential requirements in the standard.			

BG96, BG96 MINIPCIE (Report No: R1811A0536-R5) is a variant model of BG96 (Report No: RXA1706-0199RF06). Test items tested see the table below. The detailed product change description please refers to the ANNEX B.

Band	Original (RXA1706-0199RF06)	Variant (R1811A0536-R5)
NB-IOT Band 2	Pass	Refer to the Original
NB-IOT Band 25	NA	Pass

1. Test Laboratory

1.1. Notes of the test report

This report shall not be reproduced in full or partial, without the written approval of **TA technology (shanghai) co., Ltd.** The results documented in this report apply only to the tested sample, under the conditions and modes of operation as described herein. Measurement Uncertainties were not taken into account and are published for informational purposes only. This report is written to support regulatory compliance of the applicable standards stated above.

1.2. Test facility

CNAS (accreditation number: L2264)

TA Technology (Shanghai) Co., Ltd. has obtained the accreditation of China National Accreditation Service for Conformity Assessment (CNAS).

FCC (Designation number: CN1179, Test Firm Registration Number: 446626)

TA Technology (Shanghai) Co., Ltd. has been listed on the US Federal Communications Commission list of test facilities recognized to perform electromagnetic emissions measurements.

IC (recognition number is 8510A)

TA Technology (Shanghai) Co., Ltd. has been listed by industry Canada to perform electromagnetic emission measurement.

VCCI (recognition number is C-4595, T-2154, R-4113, G-10766)

TA Technology (Shanghai) Co., Ltd. has been listed by industry Japan to perform electromagnetic emission measurement.

A2LA (Certificate Number: 3857.01)

TA Technology (Shanghai) Co., Ltd. has been listed by American Association for Laboratory Accreditation to perform electromagnetic emission measurement.



1.3. Testing Location

Company: TA Technology (Shanghai) Co., Ltd.
Address: No.145, Jintang Rd, Tangzhen Industry Park, Pudong
City: Shanghai
Post code: 201201
Country: P. R. China
Contact: Xu Kai
Telephone: +86-021-50791141/2/3
Fax: +86-021-50791141/2/3-8000
Website: <http://www.ta-shanghai.com>
E-mail: xukai@ta-shanghai.com

2. General Description of Equipment under Test

Client Information

Applicant	Quectel Wireless Solutions Co., Ltd.
Applicant address	7th Floor, Hongye Building, No. 1801 Hongmei Road, Xuhui District, Shanghai, China
Manufacturer	Quectel Wireless Solutions Co., Ltd.
Manufacturer address	7th Floor, Hongye Building, No. 1801 Hongmei Road, Xuhui District, Shanghai, China

General information

EUT Description			
Model	BG96, BG96 MINIPCIE		
IMEI	866425038291656		
Hardware Version	R1.2		
Software Version	BG96MAR04A01M1G		
Power Supply	External power supply		
Antenna Type	The EUT don't have standard Antenna, The Antenna used for testing in this report is the after-market accessory (Dipole Antenna)		
Antenna Gain	4dBi		
Test Mode(s)	NB-IOT Band 2; NB-IOT Band 25;		
Test Modulation	BPSK, QPSK		
NB-IOT Category	NB1		
Deployment:	stand-alone		
Sub-carrier spacing:	3.75KHz, 15KHz		
Ntones:	single, multi-tone		
Maximum E.I.R.P	NB-IOT Band 2	27.88dBm	
	NB-IOT Band 25	22.70dBm	
Rated Power Supply Voltage	3.8V		
Extreme Voltage	Minimum: 3.3V Maximum: 4.3V		
Extreme Temperature	Lowest: -40°C Highest: +85°C		
Operating Frequency Range(s)	Band	Tx (MHz)	Rx (MHz)
	NB-IOT Band 2	1850 ~ 1910	1930 ~ 1990
	NB-IOT Band 25	1850 ~ 1915	1930 ~ 1995
Note: 1. The information of the EUT is declared by the manufacturer.			

The series model number is: BG96 MINIPCIE. The difference of these models are have different marketing requirement.

Accessory equipment	
Evaluation Board	RF Cable
RS232-to-USB Cable	Antenna: Dipole Antenna
Headset	USB Cable



3. Applied Standards

According to the specifications of the manufacturer, it must comply with the requirements of the following standards:

FCC CFR47 Part 2 (2018)

FCC CFR 47 Part 24E (2018)

ANSI C63.26 (2015)

KDB 971168 D01 Power Meas License Digital Systems v03r01

4. Test Configuration

Radiated measurements are performed by rotating the EUT in three different orthogonal test planes. EUT stand-up position (Z axis), lie-down position (X, Y axis). Receiver antenna polarization (horizontal and vertical), the worst emission was found in position (X axis, horizontal polarization) and the worst case was recorded.

All modes as Subcarrier Spacing, modulations, Channel were investigated.

Subsequently, only the worst case emissions are reported.

The following testing in NB-IOT is set based on the maximum RF Output Power.

Test modes are chosen to be reported as the worst case configuration below for NB-IOT Band 2/25

Test items	Deployment mode	Subcarrier Spacing (kHz)		Modulation		Test Channel		
	Stand-alone	3.75	15	BPSK	QPSK	L	M	H
RF power output	O	O	O	O	O	O	O	O
Effective Isotropic Radiated power	O	O	O	O	O	O	O	O
Occupied Bandwidth	O	O	O	O	O	O	O	O
Band Edge Compliance	O	O	O	O	O	O	-	O
Peak-to-Average Power Ratio	O	O	O	O	O	-	O	-
Frequency Stability	O	O	O	O	O	-	O	-
Conducted Spurious Emissions	O	-	O	-	O	O	O	O
Radiates Spurious Emission	O	-	O	-	O	O	O	O
<p>Note</p> <p>1. The mark "O" means that this configuration is chosen for testing.</p> <p>2. The mark "-" means that this configuration is not testing.</p>								

5. Test Case Results

5.1.RF Power Output

Ambient condition

Temperature	Relative humidity	Pressure
23°C ~25°C	45%~50%	101.5kPa

Methods of Measurement

During the process of the testing, The EUT is controlled by the Base Station Simulator to ensure max power transmission and proper modulation.

Test Setup

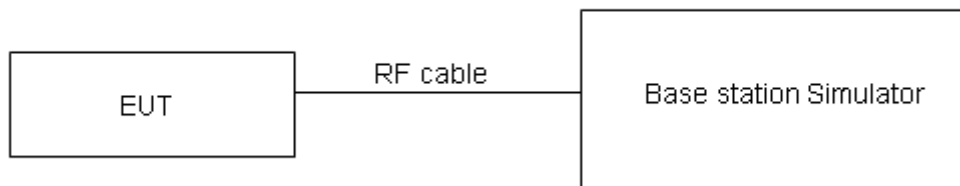

The loss between RF output port of the EUT and the input port of the tester has been taken into consideration.

Limits

No specific RF power output requirements in part 2.1046.

Measurement Uncertainty

The assessed measurement uncertainty to ensure 95% confidence level for the normal distribution is with the coverage factor $k = 2$, $U = 0.4$ dB.

**Test Results**

NB-IOT Band 2				Conducted Power(dBm)		
Deployment mode	Sub-carrier spacing (kHz)	Modulation	Ntones	Channel/Frequency(MHz)		
				18601/1850.1	18900/1880	19199/1909.9
Stand-alone	3.75	BPSK	1@0	22.11	22.34	22.07
		BPSK	1@47	22.09	22.33	22.08
	15	BPSK	1@0	22.49	22.40	22.86
		BPSK	1@11	22.83	22.69	22.97
	3.75	QPSK	1@0	22.17	22.45	22.49
		QPSK	1@47	22.15	22.39	22.64
	15	QPSK	1@0	22.58	22.42	22.92
		QPSK	1@11	22.84	22.72	22.96
		QPSK	12@0	22.75	22.55	22.98

Mode	Modulation	Sub-carrier spacing (KHz)	Ntones	Conducted Power (dBm) for low/mid/high channel		
				26041/1850.1	26341/1880.1	26689/1914.9
Band 25 Standalone	BPSK	3.75	1@0	24.17	24.21	23.95
			1@47	24.06	24.17	23.90
		15	1@0	23.95	24.09	23.79
			1@11	23.97	24.05	23.92
	QPSK	3.75	1@0	24.12	24.08	23.93
			1@47	24.13	24.19	23.84
		15	1@0	23.99	24.10	23.80
			1@11	23.94	24.01	23.77
		15	12@0	21.82	22.08	21.62

5.2. Effective Isotropic Radiated Power

Ambient condition

Temperature	Relative humidity	Pressure
23°C ~25°C	45%~50%	101.5kPa

Methods of Measurement

The testing follows FCC KDB 971168 v03r01 Section 5.8 and ANSI C63.26 (2015).

- a) Connect the equipment as illustrated. Mount the equipment with the manufacturer specified antenna in a vertical orientation on a manufacturer specified mounting surface located on a non-conducting rotating platform of a RF anechoic chamber (preferred) or a standard radiation site.
- b) Key the transmitter, then rotate the EUT 360° azimuthally and record spectrum analyzer power level (LVL) measurements at angular increments that are sufficiently small to permit resolution of all peaks. If a standard radiation test site is used, raise and lower the test antenna to obtain a maximum reading at each angular increment. (Note: several batteries may be needed to offset the effect of battery voltage droop, which should not exceed 5% of the manufactured specified battery voltage during transmission).
- c) Replace the transmitter under test with a vertically polarized half-wave dipole (or an antenna whose gain is known relative to an ideal half-wave dipole). The center of the antenna should be at the same location as the center of the antenna under test.
- d) Connect the antenna to a signal generator with a known output power and record the path loss (in dB) as LOSS. If a standard radiation test site is used, raise and lower the test antenna to obtain a maximum reading. $LOSS = \text{Generator Output Power (dBm)} - \text{Analyzer reading (dBm)}$
- e) Determine the effective radiated output power at each angular position from the readings in steps b) and d) using the following equation: $ERP \text{ (dBm)} = \text{LVL (dBm)} + \text{LOSS (dB)}$
- f) The maximum ERP is the maximum value determined in the preceding step.
- g) When calculating ERP, in addition to knowing the antenna radiation and matching characteristics, it is necessary to know the loss values of all elements (e.g. transmission line attenuation, mismatches, filters, combiners) interposed between the point where transmitter output power is measured, and the point where power is applied to the antenna. ERP can then be calculated as follows:
 $EIRP \text{ (dBm)} = \text{Output Power (dBm)} - \text{Losses (dB)} + \text{Antenna Gain (dBi)}$
where: dBd refers to gain relative to an ideal dipole.
 $EIRP \text{ (dBm)} = ERP \text{ (dBm)} + 2.15 \text{ (dB)}$

The RB allocation refers to section 5.1, using the maximum output power configuration.

Test setup

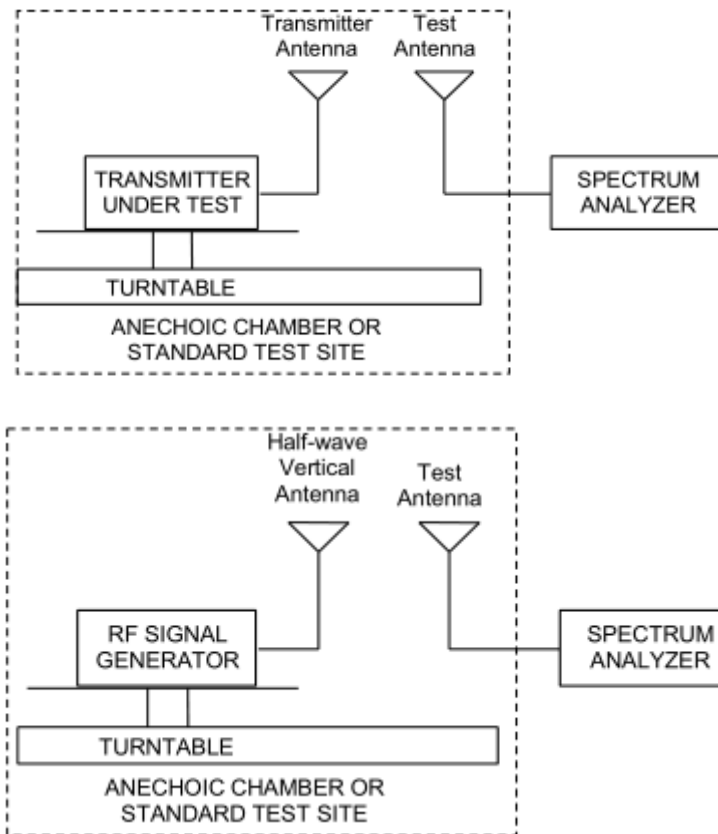

Limits

Rule Part 24.232(c) Mobile and portable stations are limited to 2 watts EIRP.

Rule Part 24.232(e) Peak transmit power must be measured over any interval of continuous transmission using instrumentation calibrated in terms of an rms-equivalent voltage.

Limit	$\leq 2\text{ W}$ (33 dBm)
-------	----------------------------

Measurement Uncertainty

The assessed measurement uncertainty to ensure 95% confidence level for the normal distribution is with the coverage factor $k = 2$, $U = 1.19\text{ dB}$

Test Results:

The measurement is performed for both of horizontal and vertical antenna Polarization, and only the data of worst mode is recorded in this report.

NB-IOT Band 2 Standalone						
Frequency (MHz)	Modulation	Polarization	Sub-carrier spacing (kHz)	EIRP (dBm)	Limit (dBm)	Conclusion
1850.1	BPSK	Horizontal	3.75	27.73	33	Pass
	QPSK	Horizontal	3.75	27.69	33	Pass
	BPSK	Horizontal	15	27.88	33	Pass
	QPSK	Horizontal	15	27.44	33	Pass
1880	BPSK	Horizontal	3.75	26.34	33	Pass
	QPSK	Horizontal	3.75	26.45	33	Pass
	BPSK	Horizontal	15	27.31	33	Pass
	QPSK	Horizontal	15	26.83	33	Pass
1909.9	BPSK	Horizontal	3.75	26.64	33	Pass
	QPSK	Horizontal	3.75	26.49	33	Pass
	BPSK	Horizontal	15	26.86	33	Pass
	QPSK	Horizontal	15	26.68	33	Pass

NB-IOT Band 25 Standalone							
Frequency (MHz)	Modulation	Polarization	Sub-carrier spacing (KHz)	Ntones	EIRP (dBm)	Limit (dBm)	Conclusion
1850.1	BPSK	Horizontal	3.75	1@0	21.86	33	Pass
	QPSK	Horizontal	3.75	1@0	21.98	33	Pass
	BPSK	Horizontal	15	1@0	22.61	33	Pass
	QPSK	Horizontal	15	1@0	22.70	33	Pass
1880.1	BPSK	Horizontal	3.75	1@0	22.11	33	Pass
	QPSK	Horizontal	3.75	1@0	22.06	33	Pass
	BPSK	Horizontal	15	1@0	22.59	33	Pass
	QPSK	Horizontal	15	1@0	22.68	33	Pass
1914.9	BPSK	Horizontal	3.75	1@0	21.53	33	Pass
	QPSK	Horizontal	3.75	1@0	21.83	33	Pass
	BPSK	Horizontal	15	1@0	21.33	33	Pass
	QPSK	Horizontal	15	1@0	21.42	33	Pass

5.3.Occupied Bandwidth

Ambient condition

Temperature	Relative humidity	Pressure
23°C ~25°C	45%~50%	101.5kPa

Method of Measurement

The EUT was connected to Spectrum Analyzer and Base Station Simulator via power Splitter. The occupied bandwidth is measured using spectrum analyzer.

RBW is set to 2kHz, VBW is set to 6.2kHz for NB-IOT Band 2/25

99% power and -26dBc occupied bandwidths are recorded. Spectrum analyzer plots are included on the following pages.

Test Setup

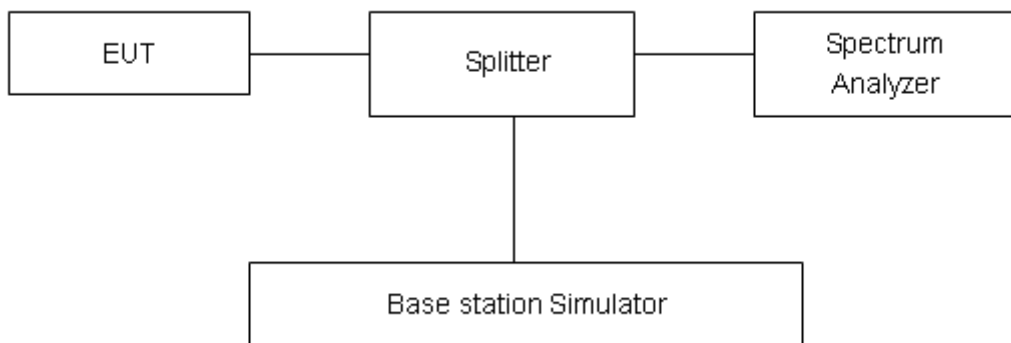

Limits

No specific occupied bandwidth requirements in part 2.1049.

Measurement Uncertainty

The assessed measurement uncertainty to ensure 95% confidence level for the normal distribution is with the coverage factor $k = 2$, $U = 624\text{Hz}$.



Test Result

NB-IOT Band 2 Standalone					
Channel/ Frequency (MHz)	Modulation	Sub-carrier spacing (kHz)	Ntones	99% Power Bandwidth(kHz)	-26dBc Bandwidth(kHz)
18601/ 1850.1	BPSK	3.75	1@0	55.190	37.680
	QPSK	3.75	1@0	142.370	118.200
	BPSK	15	1@0	67.957	43.310
	QPSK	15	1@0	142.400	130.800
	QPSK	15	12@0	197.110	304.100
18900/ 1880	BPSK	3.75	1@0	56.083	38.050
	QPSK	3.75	1@0	147.700	108.300
	BPSK	15	1@0	65.719	41.270
	QPSK	15	1@0	139.700	127.600
	QPSK	15	12@0	198.740	289.700
19199/ 1909.9	BPSK	3.75	1@0	52.007	37.670
	QPSK	3.75	1@0	162.770	124.400
	BPSK	15	1@0	66.258	43.950
	QPSK	15	1@0	148.430	130.400
	QPSK	15	12@0	199.180	273.500

Mode	Modulation	Sub-carrier spacing (KHz)	Ntones	Bandwidth(KHz) for low/mid/high channel					
				26041/1850.1		26341/1880.1		26689/1914.9	
				99% Power	-26dBc	99% Power	-26dBc	99% Power	-26dBc
Band 25 Standalone	BPSK	3.75	1@0	59.25	38.25	60.51	38.36	58.26	36.03
	QPSK	3.75	1@0	65.56	39.90	68.38	42.43	69.49	38.56
	BPSK	15	1@0	131.10	103.50	132.73	126.60	133.13	103.90
	QPSK	15	1@0	118.50	115.60	117.46	103.50	132.95	115.40
	QPSK	15	12@0	187.93	253.60	187.24	262.50	193.78	266.00

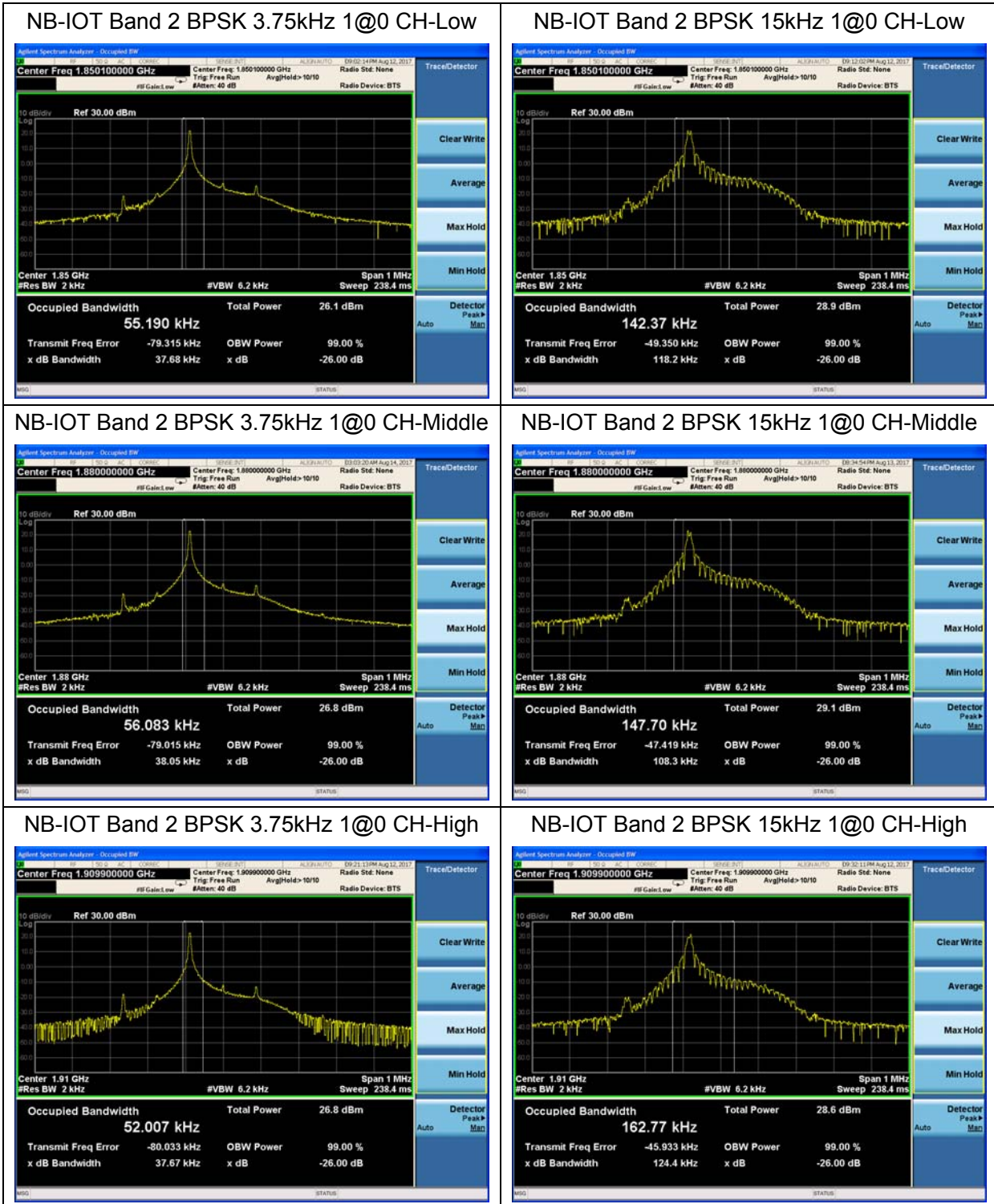

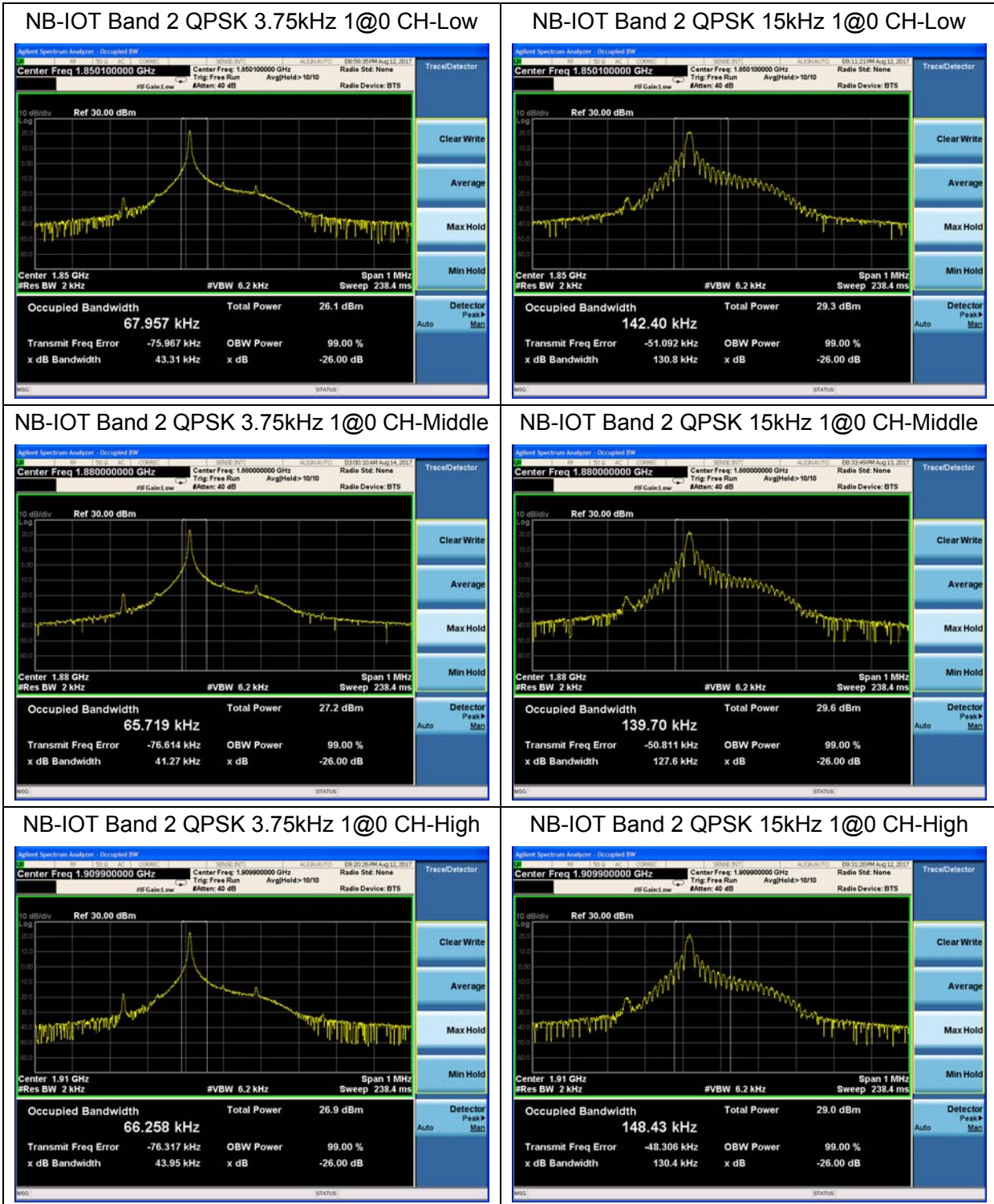

NB-IOT Band 2 QPSK 15kHz 12@0 CH-Low



NB-IOT Band 2 QPSK 15kHz 12@0 CH-Middle

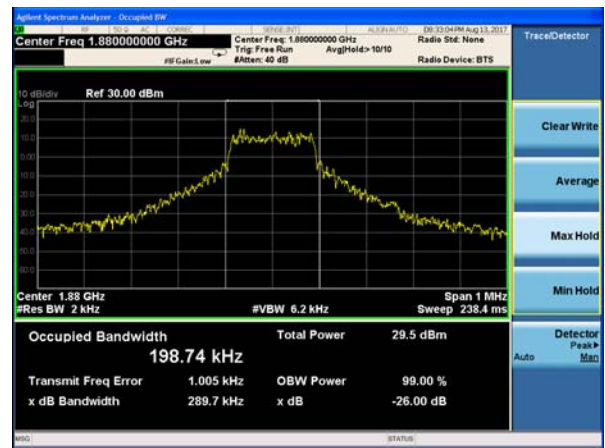

NB-IOT Band 2 QPSK 15kHz 12@0 CH-High

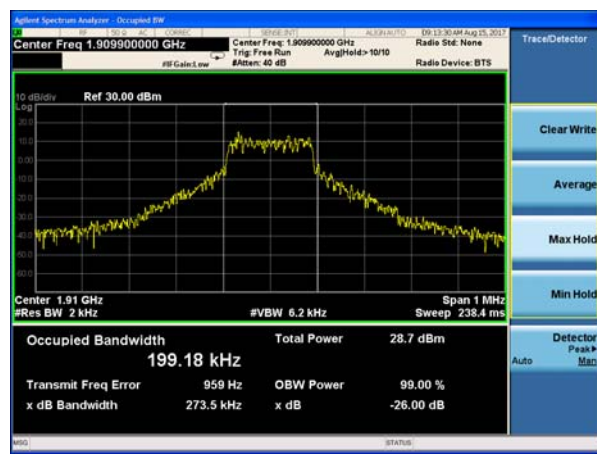

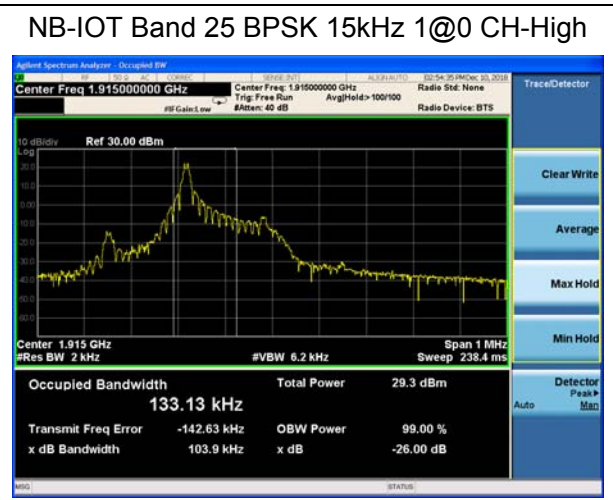
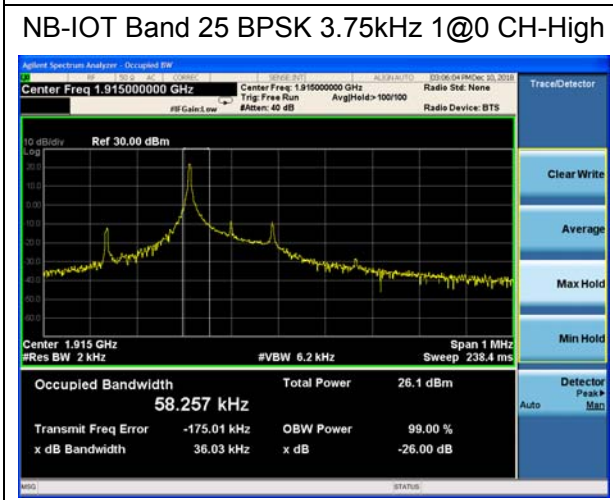
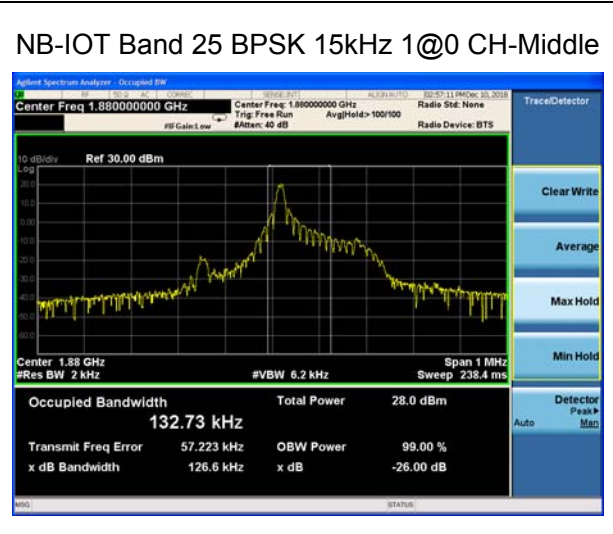
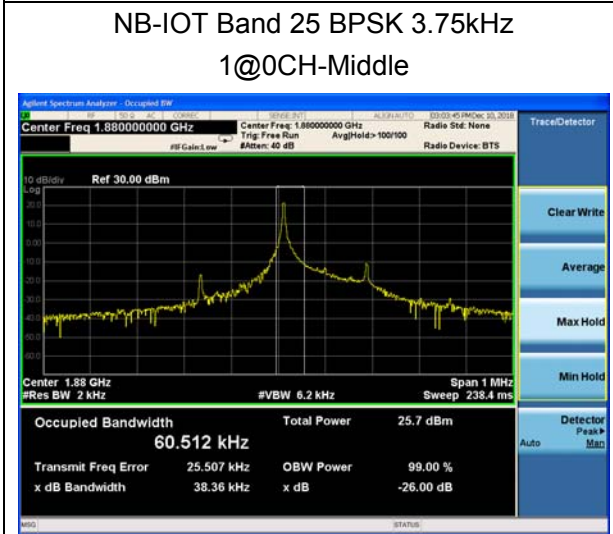
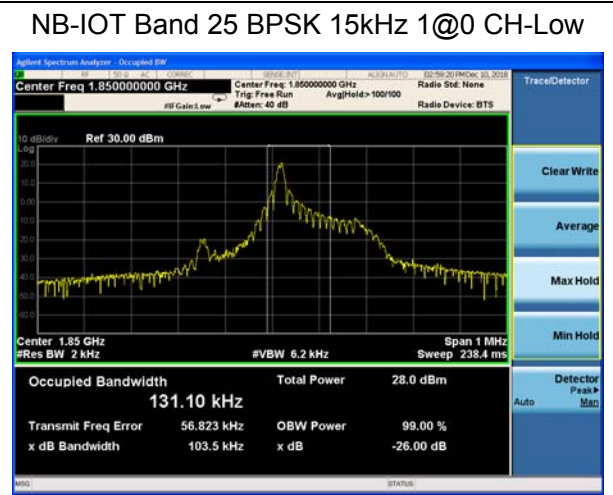
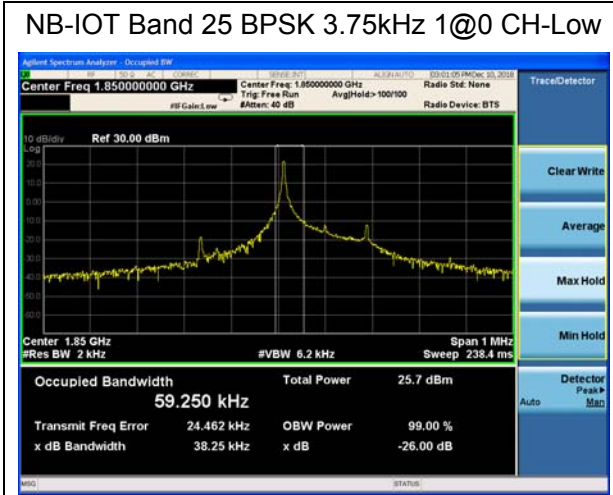

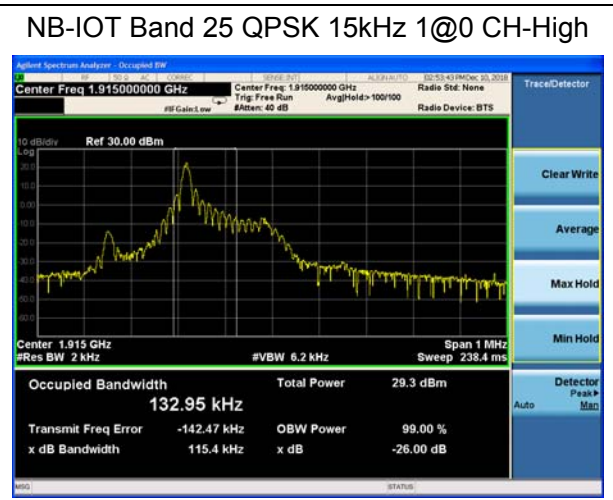
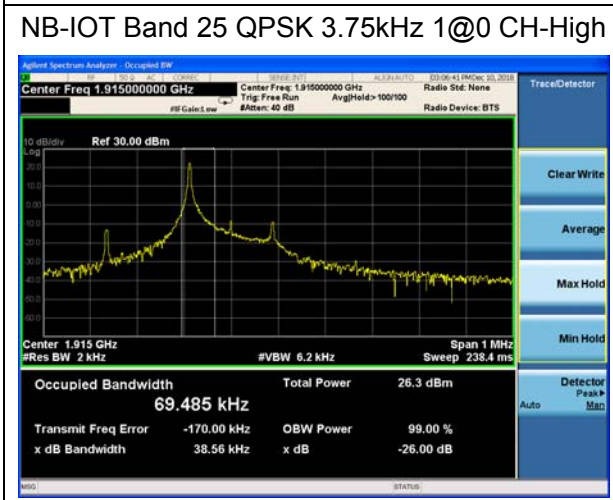
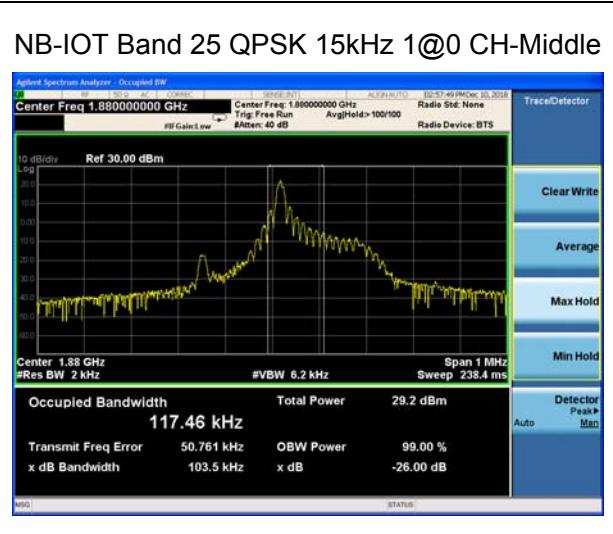
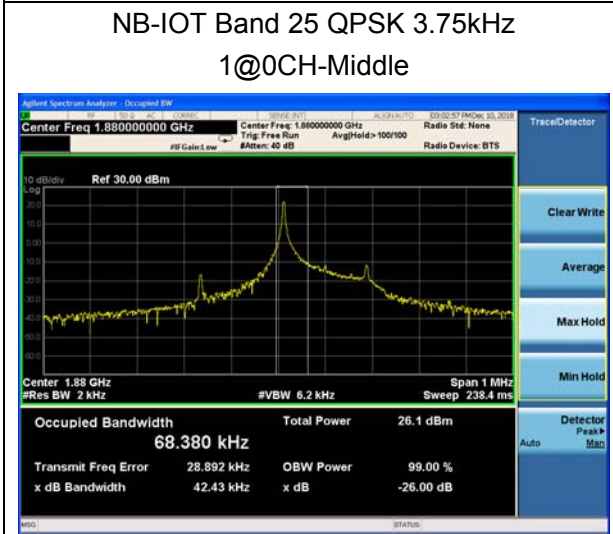
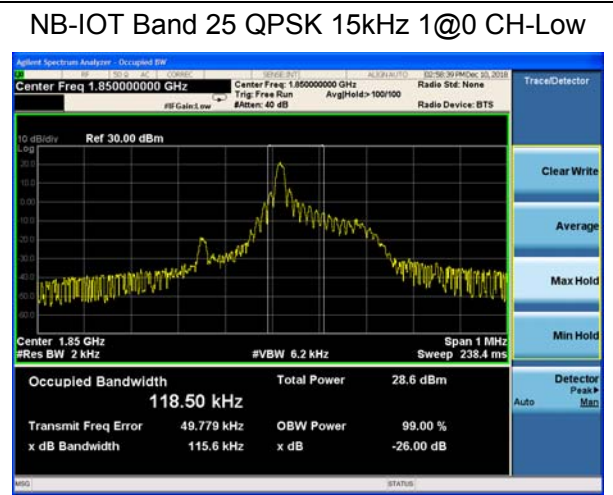
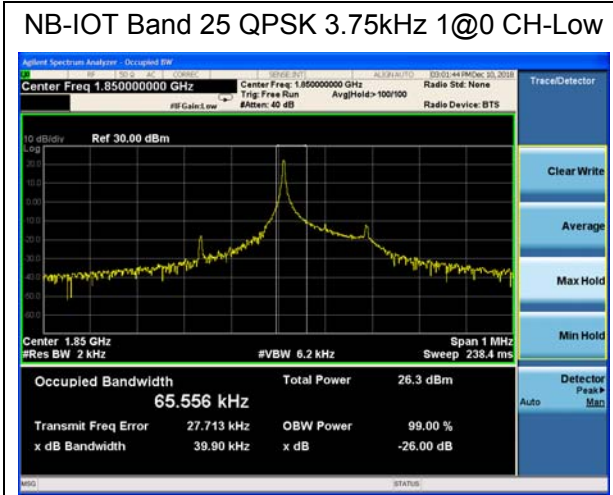

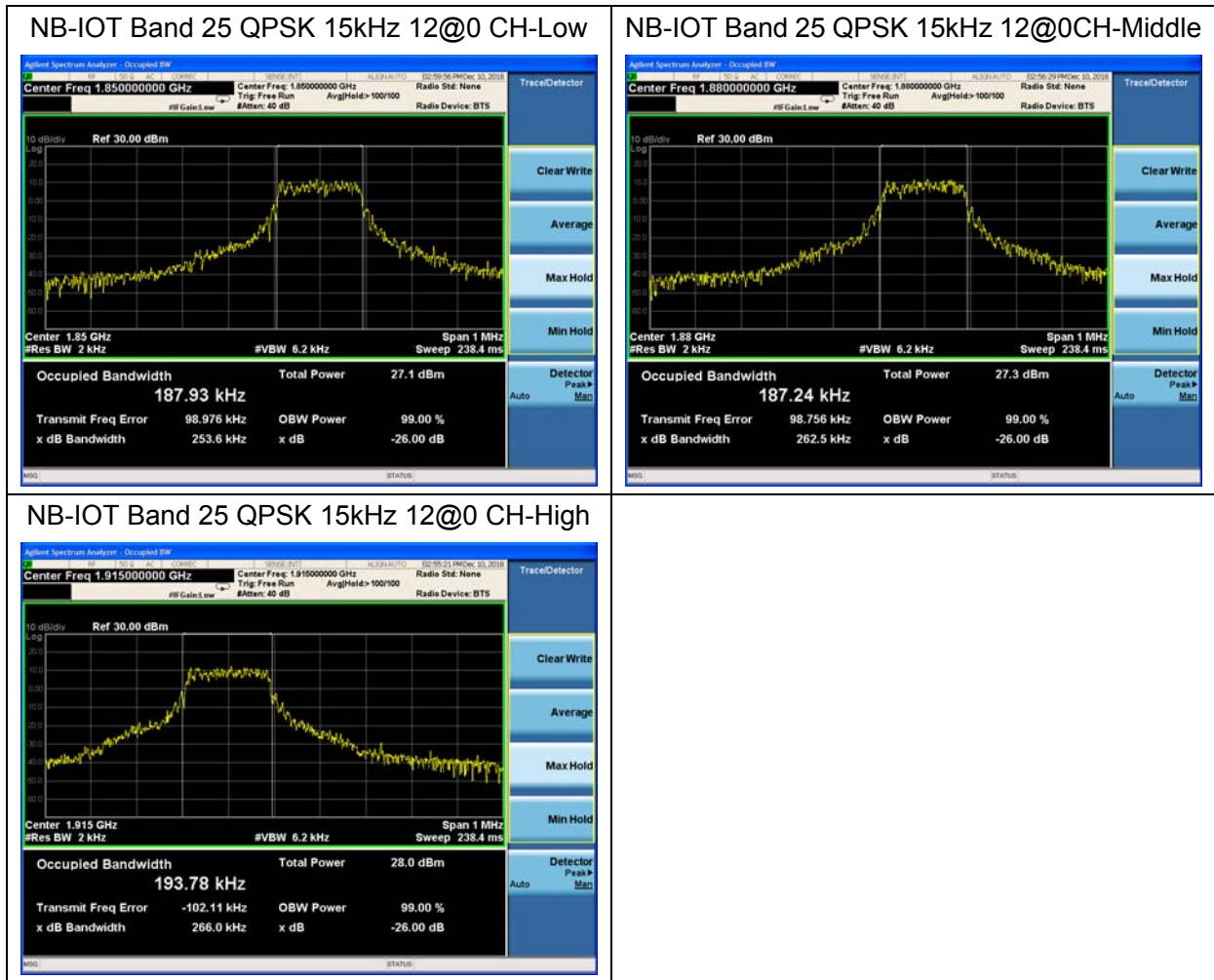

5.4. Band Edge Compliance

Ambient condition

Temperature	Relative humidity	Pressure
23°C ~25°C	45%~50%	101.5kPa

Method of Measurement

The EUT was connected to Spectrum Analyzer and Base Station Simulator via power Splitter. The band edge of the lowest and highest channels were measured. The Average detector is used and RBW is set to 51Hz, VBW is set to 160Hz for 3.75KHz single carrier, RBW is set to 200Hz, VBW is set to 620Hz for 15KHz single carrier, RBW is set to 2kHz, VBW is set to 6.2KHz for 15KHz full carrier.

Spectrum analyzer plots are included on the following pages.

Test Setup

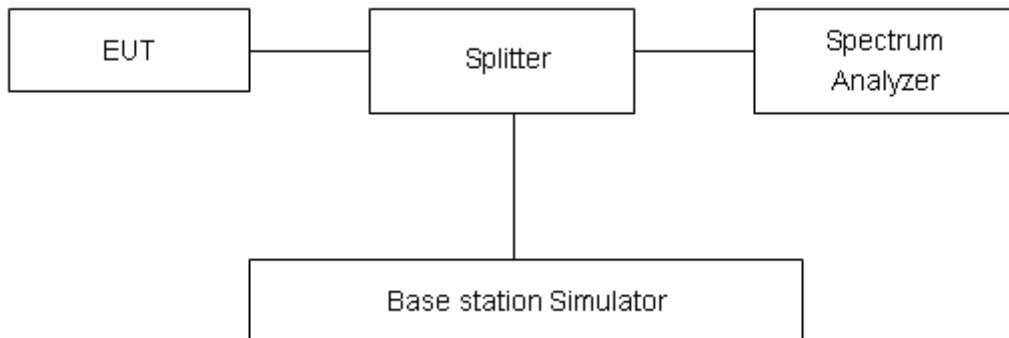

Limits

Rule Part 24.238(a) specifies that “on any frequency outside a licensee’s frequency block, the power of any emission shall be attenuated below the transmitter power (P) by at least 43 + 10 log₁₀ (P) dB.”

Limit	-13 dBm
-------	---------

Measurement Uncertainty

The assessed measurement uncertainty to ensure 95% confidence level for the normal distribution is with the coverage factor $k = 1.96$, $U=0.684$ dB.

Test Result:

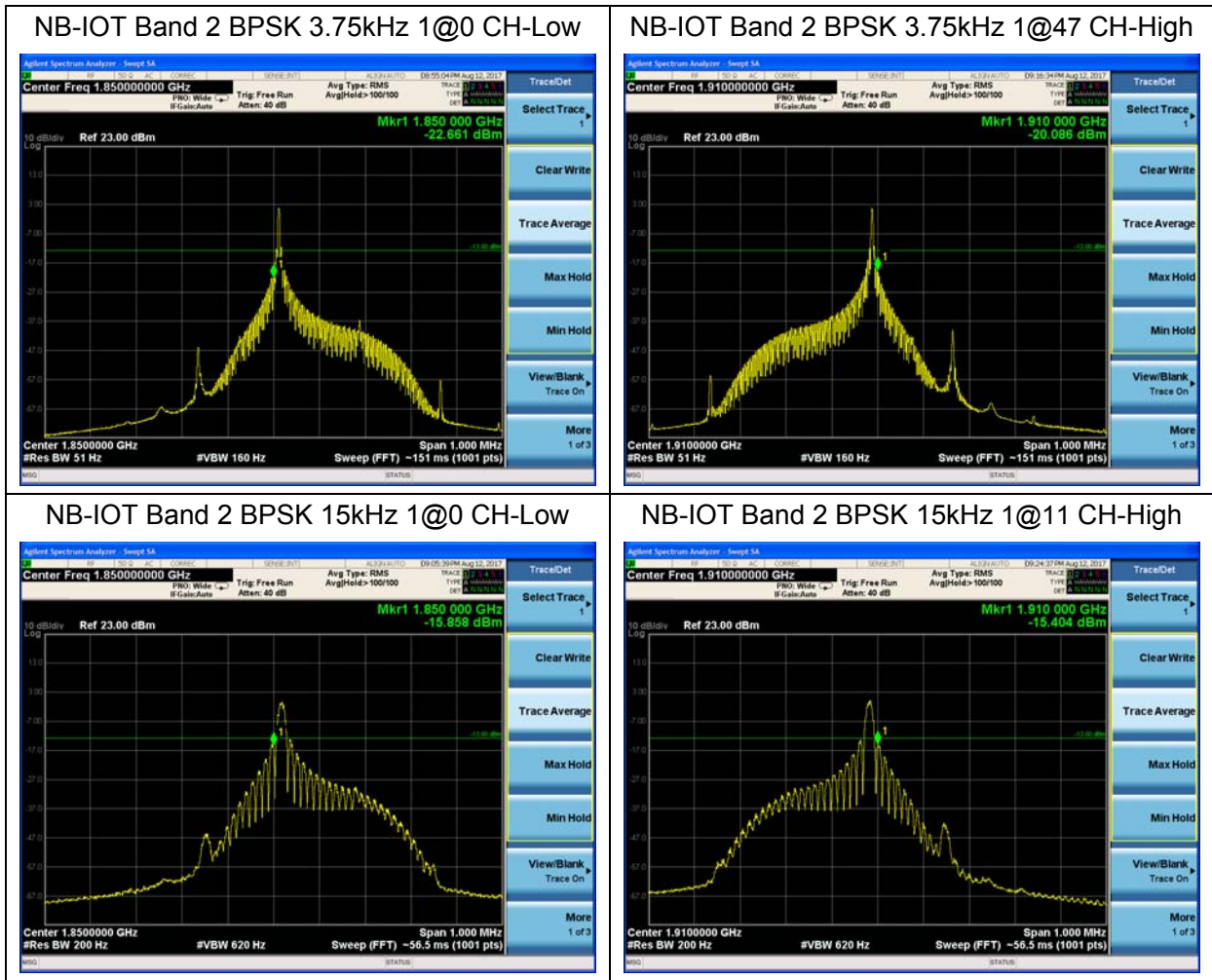

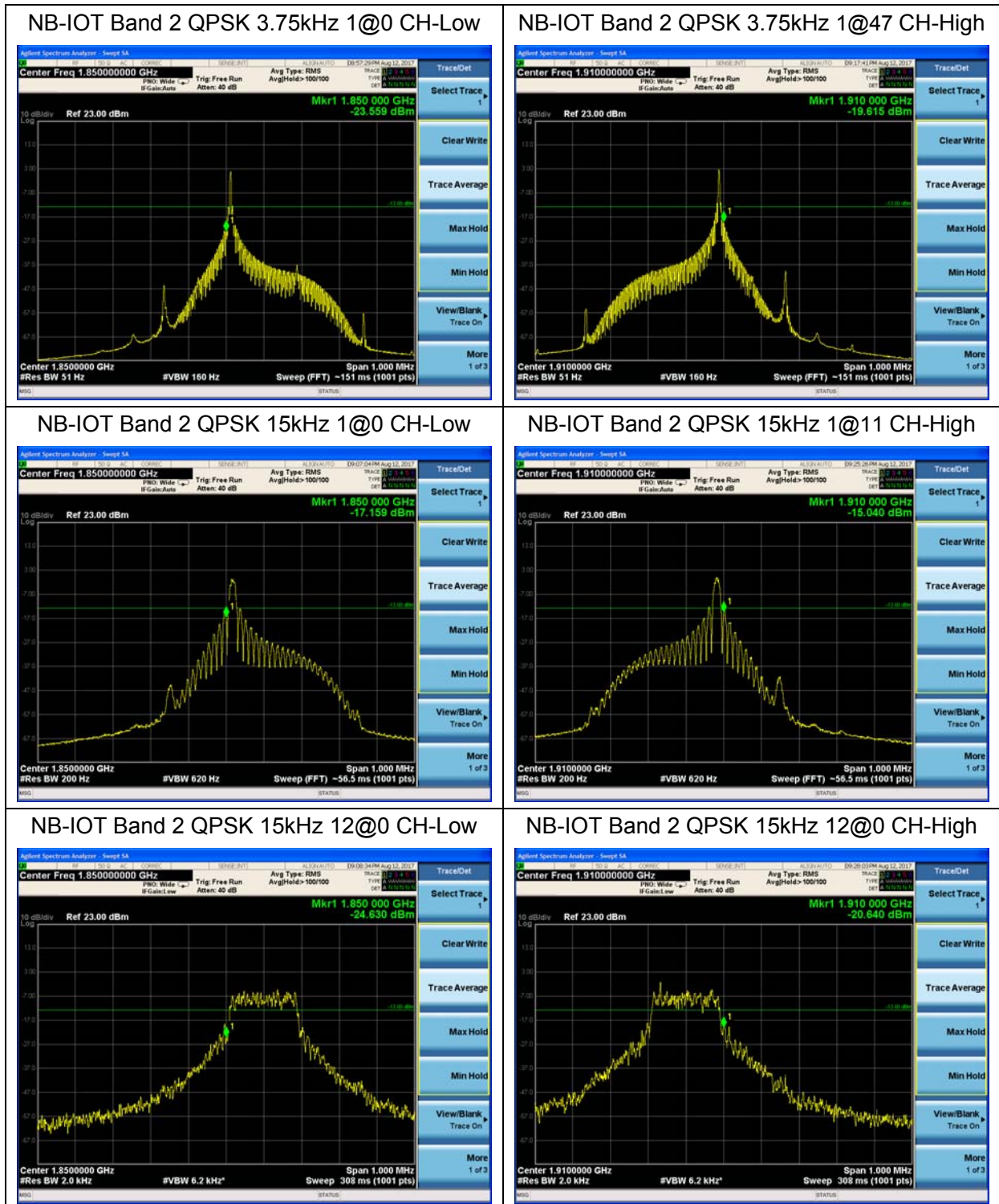

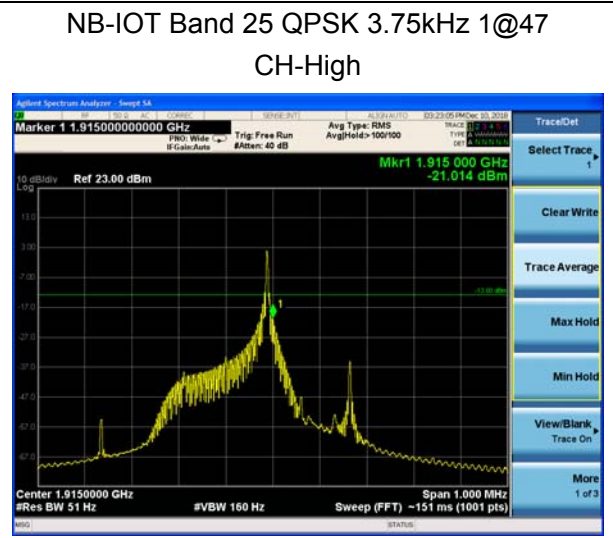
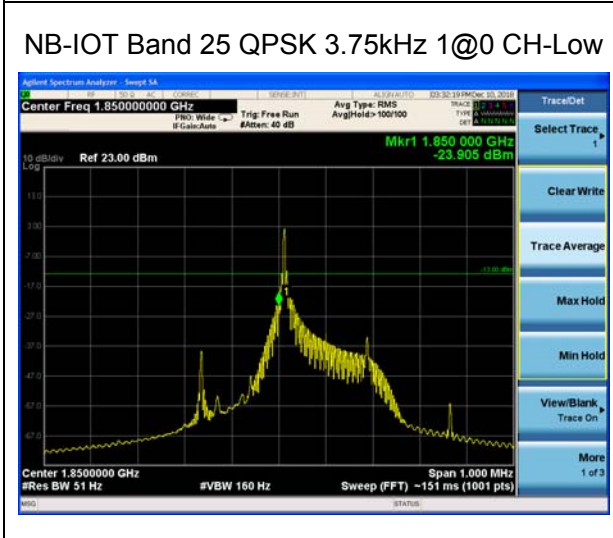
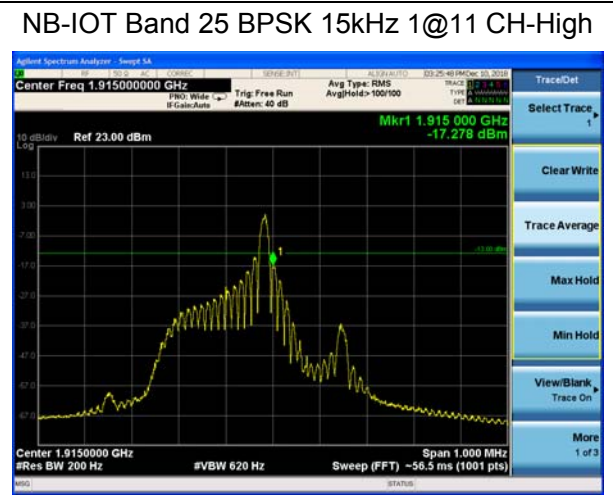
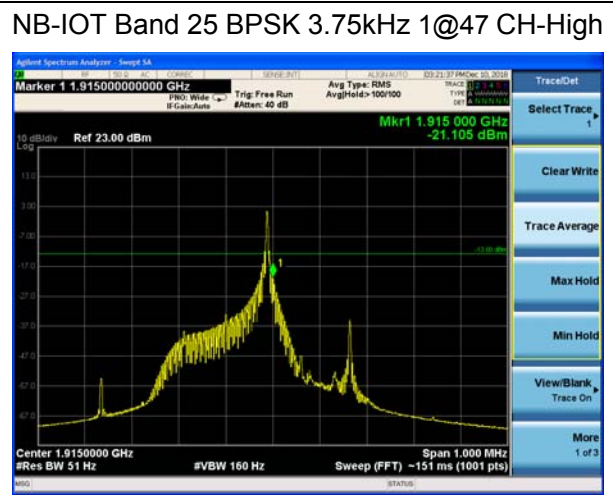
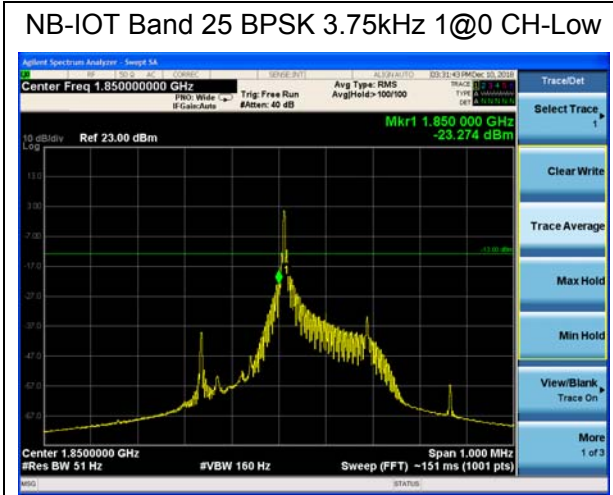

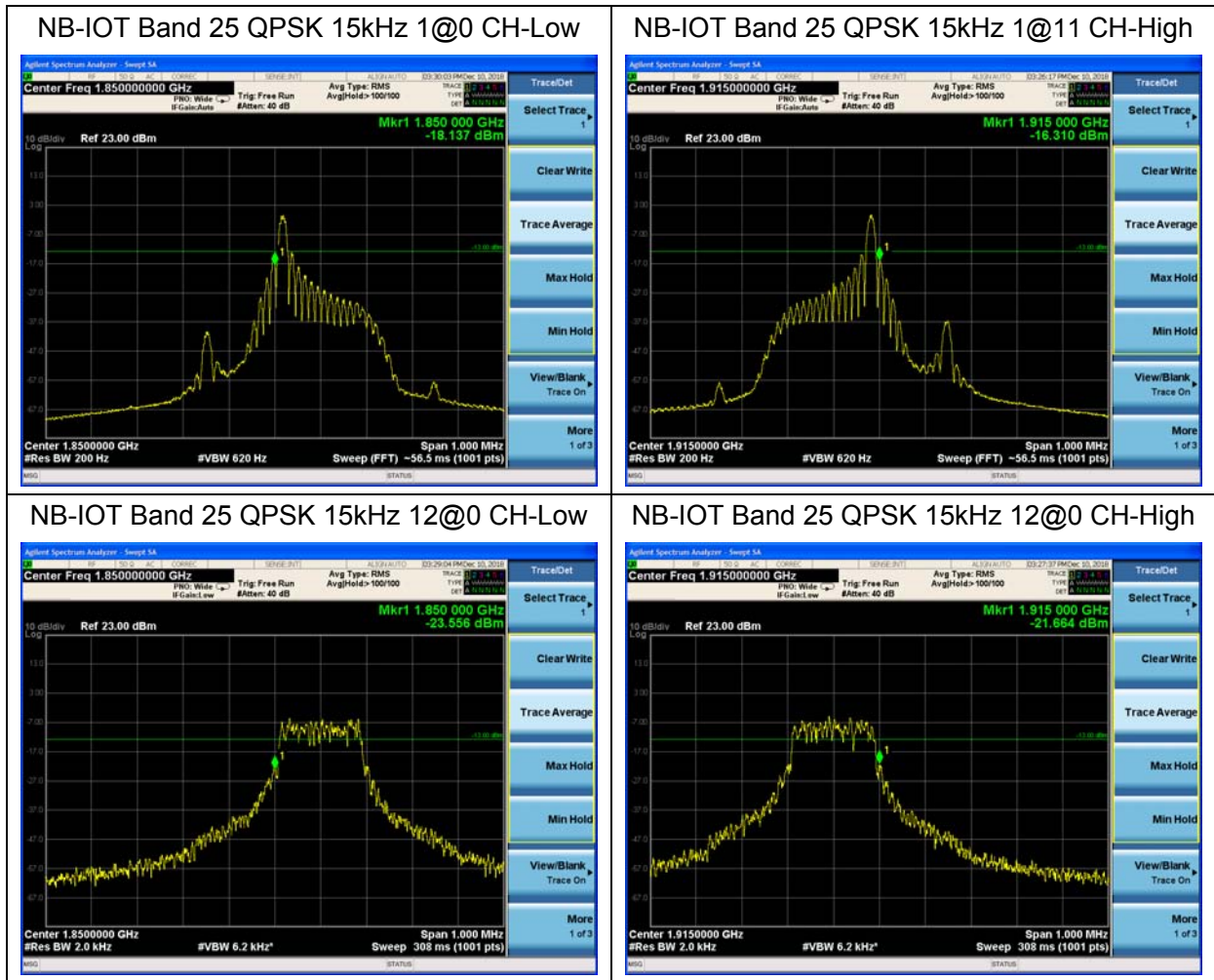

5.5. Peak-to-Average Power Ratio (PAPR)

Ambient condition

Temperature	Relative humidity	Pressure
23°C ~25°C	45%~50%	101.5kPa

Methods of Measurement

Measure the total peak power and record as PPk. And measure the total average power and record as PAvg. Both the peak and average power levels must be expressed in the same logarithmic units (e.g., dBm). Determine the PAPR from:

$$PAPR (dB) = PPk (dBm) - PAvg (dBm).$$

Test Setup

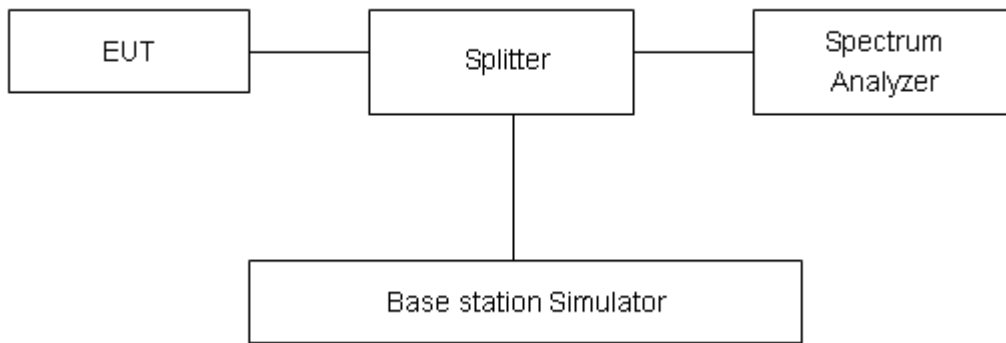

Limits

In measuring transmissions in this band using an average power technique, the peak-to-average ratio (PAR) of the transmission may not exceed 13 dB in 24.232(d).

Measurement Uncertainty

The assessed measurement uncertainty to ensure 95% confidence level for the normal distribution is with the coverage factor $k = 2$, $U = 0.4$ dB.

Test Results

NB-IOT Band 2 Standalone							
Modulation	Sub-carrier spacing (KHz)	Channel/Frequency (MHz)	Peak (dBm)	Avg (dBm)	PAPR (dB)	Limit (dB)	Conclusion
BPSK	3.75	18900/1880.0	25.61	22.34	3.27	≤13	PASS
QPSK	3.75	18900/1880.0	28.77	22.40	6.37	≤13	PASS
BPSK	15	18900/1880.0	25.72	22.45	3.27	≤13	PASS
QPSK	15	18900/1880.0	28.70	22.42	6.28	≤13	PASS

Mode	Modulation	Sub-carrier spacing (KHz)	Channel/Frequency(MHz)	Peak-to-Average Power Ratio (PAPR)		
				Peak(dBm)	Avg(dBm)	PAPR(dB)
Band 25 Standalone	BPSK	3.75	26341/1880.1	24.17	20.38	3.79
	QPSK	3.75	26341/1880.1	23.55	20.20	3.35
	BPSK	15	26341/1880.1	23.87	17.48	6.39
	QPSK	15	26341/1880.1	24.26	17.67	6.59

5.6. Frequency Stability

Ambient condition

Temperature	Relative humidity	Pressure
23°C ~25°C	45%~50%	101.5kPa

Method of Measurement

Frequency Stability (Temperature Variation)

The temperature inside the climate chamber is varied from -40°C to +85°C in 10°C step size,

(1) With all power removed, the temperature was decreased to 0°C and permitted to stabilize for three hours.

(2) Measure the carrier frequency with the test equipment in a “call mode”. These measurements should be made within 1 minute of powering up the mobile station, to prevent significant self warming.

(3) Repeat the above measurements at 10°C increments from -40°C to +85°C. Allow at least 1.5 hours at each temperature, un-powered, before making measurements.

Frequency Stability (Voltage Variation)

The frequency stability shall be measured with variation of primary supply voltage as follows:

(1) Vary primary supply voltage from 85 to 115 percent of the nominal value for other than hand carried battery equipment.

(2) For hand carried, battery powered equipment, reduce primary supply voltage to the battery-operating end point which shall be specified by the manufacturer.

This transceiver is specified to operate with an input voltage of between 3.3 V and 4.3 V, with a nominal voltage of 3.8V.

Test setup

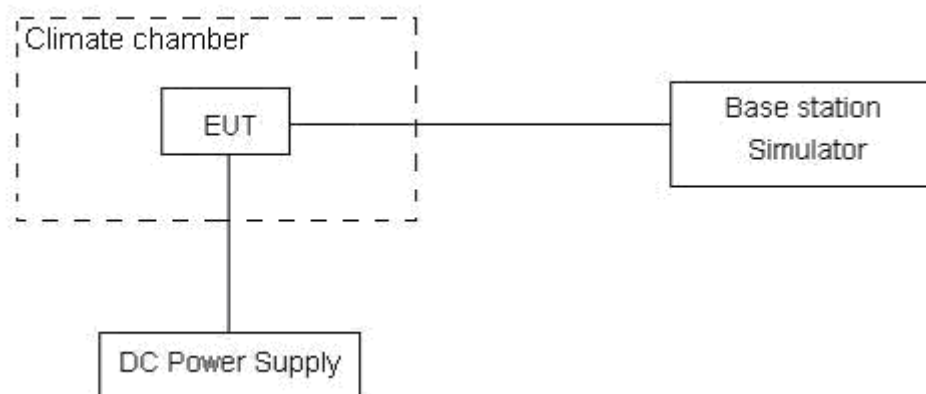

**Limits**

The frequency stability shall be sufficient to ensure that the fundamental emission stays within the authorized frequency block

Measurement Uncertainty

The assessed measurement uncertainty to ensure 99.75% confidence level for the normal distribution is with the coverage factor $k = 3$, $U = 0.01\text{ppm}$.

Test Result

NB-IOT Band 2 Standalone CH18900 Test Results (ppm)				
Sub-carrier spacing (kHz)	Test status	BPSK	QPSK	
3.75	-40°C/Normal Voltage	-0.00126	-0.00052	
	-30°C/Normal Voltage	-0.00159	-0.00098	
	-20°C/Normal Voltage	-0.00203	-0.00179	
	-10°C/Normal Voltage	-0.00208	-0.00111	
	0°C/Normal Voltage	-0.00132	0.00006	
	10°C/Normal Voltage	-0.00111	-0.00044	
	20°C/Normal Voltage	-0.00188	0.00014	
	30°C/Normal Voltage	-0.00099	-0.00024	
	40°C/Normal Voltage	-0.00087	-0.00224	
	50°C/Normal Voltage	-0.00203	-0.00024	
	60°C/Normal Voltage	-0.00132	-0.00092	
	70°C/Normal Voltage	-0.00173	-0.00031	
	80°C/Normal Voltage	-0.00069	-0.00103	
	85°C/Normal Voltage	-0.00187	-0.00052	
	20°C/Minimum Voltage	-0.00126	-0.00080	
	20°C/Maximum Voltage	-0.00058	-0.00059	
	15	-40°C/Normal Voltage	-0.00092	-0.00089
		-30°C/Normal Voltage	-0.00097	-0.00207
-20°C/Normal Voltage		-0.00154	-0.00223	
-10°C/Normal Voltage		-0.00209	-0.00198	
0°C/Normal Voltage		-0.00094	-0.00185	
10°C/Normal Voltage		-0.00126	-0.00245	
20°C/Normal Voltage		-0.00219	-0.00159	
30°C/Normal Voltage		-0.00086	-0.00104	
40°C/Normal Voltage		-0.00074	-0.00147	
50°C/Normal Voltage		-0.00114	-0.00081	
60°C/Normal Voltage		-0.00069	-0.00014	
70°C/Normal Voltage		-0.00110	-0.00068	
80°C/Normal Voltage		-0.00165	-0.00124	
85°C/Normal Voltage		-0.00084	-0.00110	
20°C/Minimum Voltage		-0.00200	-0.00164	
20°C/Maximum Voltage		-0.00165	-0.00115	



NB-IOT Band 25					
(QPSK, 20MHz BANDWIDTH)					
Condition		1850	1915	Delta(Hz)	Frequency Stability(ppm)
Temperature	Voltage	F low@-13dBm(MHz)	F high@-13dBm(MHz)		
Normal (25°C)	Normal	1850.6271	1914.6583	12.85	0.01816
Extreme (85°C)		1850.6284	1914.6526	16.46	0.02327
Extreme (80°C)		1850.6241	1914.6547	16.21	0.02291
Extreme (70°C)		1850.6248	1914.6564	19.68	0.02782
Extreme (60°C)		1850.6250	1914.6526	25.93	0.03665
Extreme (50°C)		1850.6285	1914.6537	20.17	0.02851
Extreme (40°C)		1850.6247	1914.6592	15.49	0.02189
Extreme (30°C)		1850.6285	1914.6575	14.54	0.02055
Extreme (20°C)		1850.6259	1914.6547	13.61	0.01924
Extreme (10C)		1850.6264	1914.6525	16.47	0.02328
Extreme (0°C)		1850.6268	1914.6571	13.86	0.01959
Extreme (-10°C)		1850.6275	1914.6558	19.03	0.02690
Extreme (-20°C)		1850.6273	1914.659	12.33	0.01743
Extreme (-30°C)		1850.6295	1914.6542	20.48	0.02895
Extreme (-40°C)		1850.6281	1914.6576	15.64	0.02211
25°C		LV	1850.6296	1914.6584	13.20
	HV	1850.6248	1914.6561	12.18	0.01722
(BPSK, 20MHz BANDWIDTH)					
Condition		1850	1915	Delta(Hz)	Frequency Stability(ppm)
Temperature	Voltage	F low@-13dBm(MHz)	F high@-13dBm(MHz)		
Normal (25°C)	Normal	1850.6264	1914.6529	10.84	0.01532
Extreme (85°C)		1850.6297	1914.6584	11.45	0.01618
Extreme (80°C)		1850.6254	1914.6546	21.34	0.03016
Extreme (70°C)		1850.6265	1914.6573	23.56	0.03330
Extreme (60°C)		1850.6920	1914.6557	15.67	0.02215
Extreme (50°C)		1850.6246	1914.6541	15.91	0.02249
Extreme (40°C)		1850.6282	1914.6527	17.68	0.02499
Extreme (30°C)		1850.6259	1914.6584	19.35	0.02735
Extreme (20°C)		1850.6245	1914.6598	22.57	0.03190
Extreme (10C)		1850.6272	1914.6554	24.65	0.03484
Extreme (0°C)		1850.6291	1914.6582	14.72	0.02081
Extreme (-10°C)		1850.6228	1914.6569	9.85	0.01392
Extreme (-20°C)		1850.6237	1914.6545	16.59	0.02345
Extreme (-30°C)		1850.6259	1914.6538	17.26	0.02440
Extreme (-40°C)		1850.6265	1914.6562	20.14	0.02847
25°C		LV	1850.6268	1914.6587	18.28
	HV	1850.6254	1914.6569	13.21	0.01867

5.7. Spurious Emissions at Antenna Terminals

Ambient condition

Temperature	Relative humidity	Pressure
23°C ~25°C	45%~50%	101.5kPa

Method of Measurement

The EUT was connected to Spectrum Analyzer and Base Station Simulator via power Splitter. The measurement is carried out using a spectrum analyzer. The spectrum analyzer scans from 9kHz to the 10th harmonic of the carrier. The peak detector is used.

RBW is set to 100kHz, VBW is set to 300kHz for 30MHz~1GHz

RBW is set to 1MHz, VBW is set to 3MHz for above 1GHz, Sweep is set to ATUO.

The modulation mode and RB allocation refer to section 5.1, using the maximum output power configuration.

Test setup

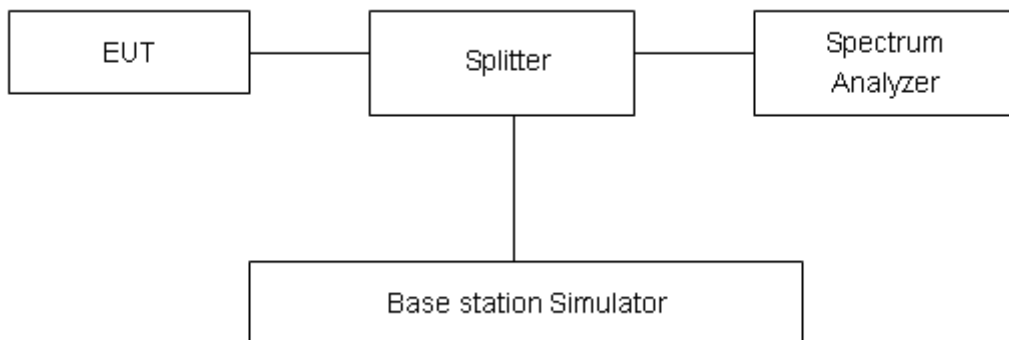

Limits

Rule Part 24.238(a) specifies that “on any frequency outside a licensee’s frequency block, the power of any emission shall be attenuated below the transmitter power (P) by at least $43 + 10 \log_{10} (P)$ dB.”

Limit	-13 dBm

Measurement Uncertainty

The assessed measurement uncertainty to ensure 99.75% confidence level for the normal distribution is with the coverage factor $k = 1.96$.

Frequency	Uncertainty
9kHz-1GHz	0.684 dB
1GHz-20GHz	1.407 dB

Test Result

Sweep the whole frequency band through the range from 9kHz to the 10th harmonic of the carrier, the emissions more than 20 dB below the limit are not reported.

The signal beyond the limit is carrier.

Standalone deployment with 15 KHz subcarrier spacing and QPSK mode for CAT NB1:

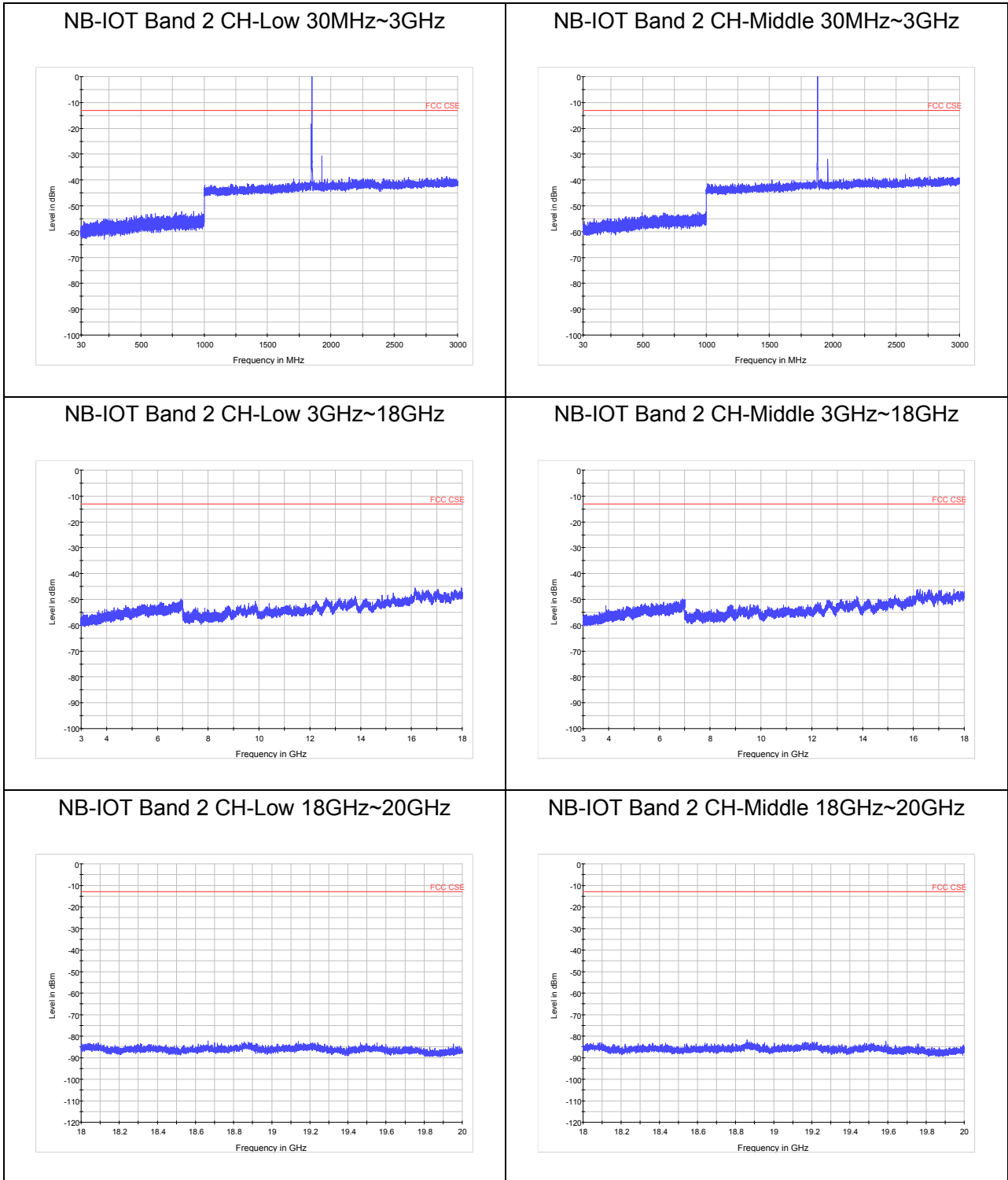



NB-IOT Band 2 CH-High 30MHz~3GHz

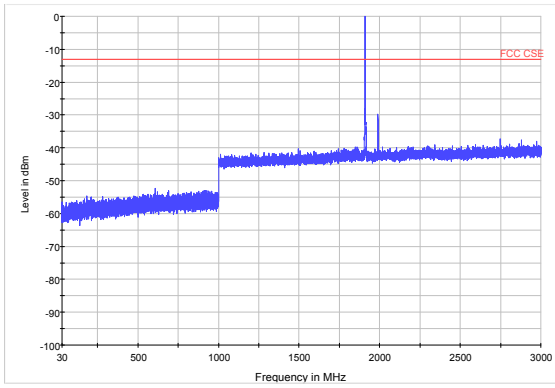

NB-IOT Band 25 CH-Low 30MHz~1GHz

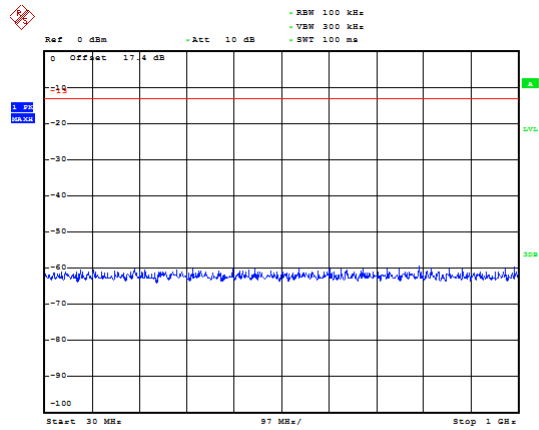

Date: 10. DEC. 2018 15:54:10

NB-IOT Band 2 CH-High 3GHz~18GHz

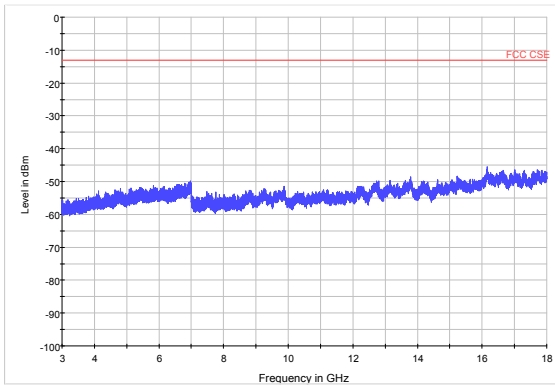

NB-IOT Band 25 CH-Low 1GHz~3GHz

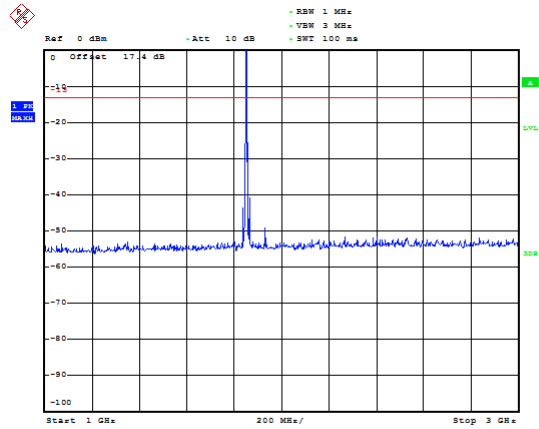

Date: 10. DEC. 2018 15:54:28

NB-IOT Band 2 CH-High 18GHz~20GHz

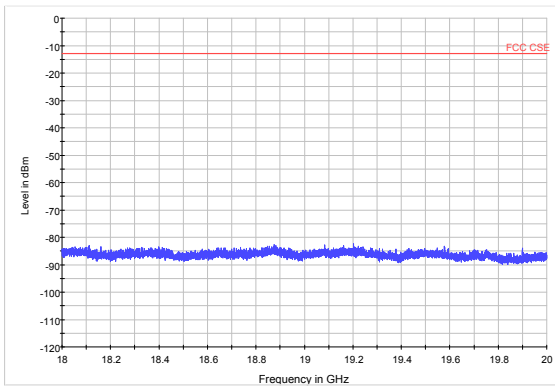

NB-IOT Band 25 CH-Low 3GHz~20GHz

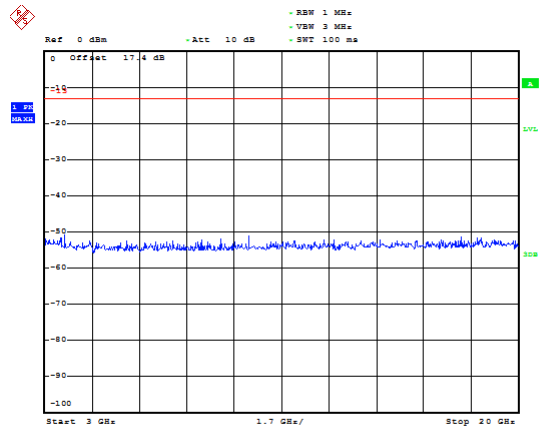

Date: 10. DEC. 2018 15:54:44



NB-IOT Band 25 CH- Middle 30MHz~1GHz

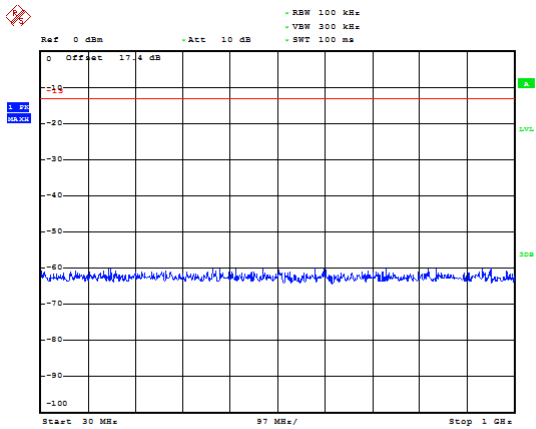

Date: 10. DEC. 2018 15:56:25

NB-IOT Band 25 CH- High 30MHz~1GHz

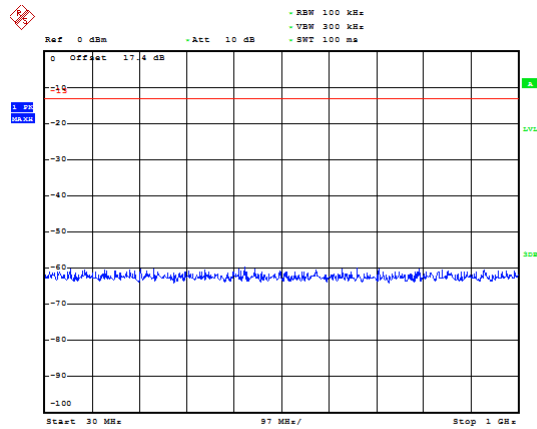

Date: 10. DEC. 2018 15:57:02

NB-IOT Band 25 CH- Middle 1GHz~3GHz

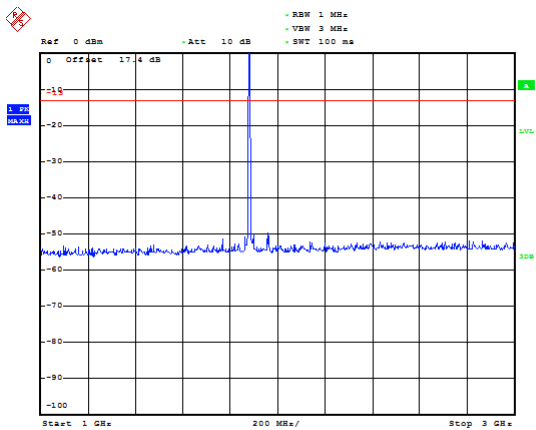

Date: 10. DEC. 2018 15:56:11

NB-IOT Band 25 CH- High 1GHz~3GHz

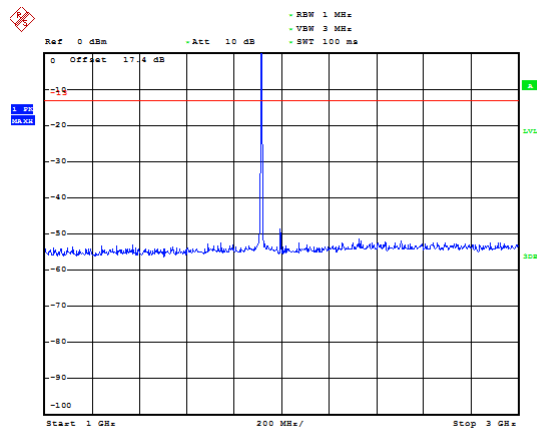

Date: 10. DEC. 2018 15:57:26

NB-IOT Band 25 CH- Middle 3GHz~20GHz

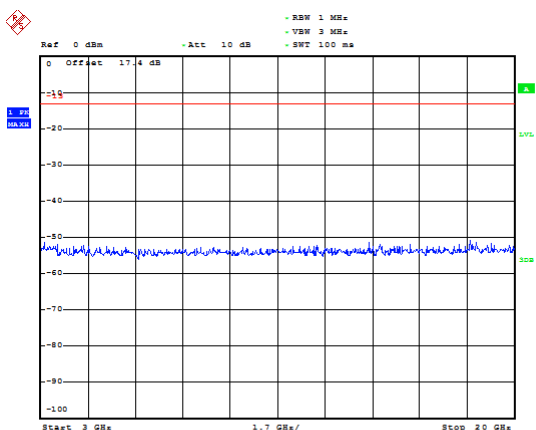

Date: 10. DEC. 2018 15:55:59

NB-IOT Band 25 CH- High 3GHz~20GHz

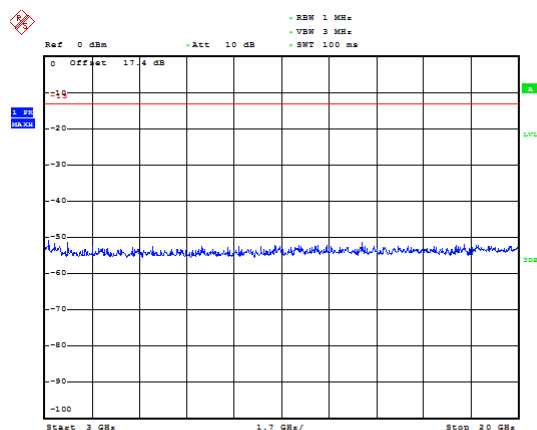

Date: 10. DEC. 2018 15:57:38

5.8. Radiates Spurious Emission

Ambient condition

Temperature	Relative humidity	Pressure
23°C ~25°C	45%~50%	101.5kPa

Method of Measurement

- The testing follows FCC KDB 971168 v03r01 Section 5.8 and ANSI C63.26 (2015).
- Below 1GHz: The EUT is placed on a turntable 0.8 meters above the ground in the chamber, 3 meter away from the antenna. The maximal emission value is acquired by adjusting the antenna height, polarisation and turntable azimuth. Normally, the height range of antenna is 1 m to 4 m, the azimuth range of turntable is 0° to 360°, and the receive antenna has two polarizations Vertical (V) and Horizontal (H). Above 1GHz: (Note: the FCC's permission to use 1.5m as an alternative per TCBC Conf call of Dec. 2, 2014.) The EUT is placed on a turntable 1.5 meters above the ground in the chamber, 3 meter away from the antenna. The maximal emission value is acquired by adjusting the antenna height, polarisation and turntable azimuth. Normally, the height range of antenna is 1 m to 4 m, the azimuth range of turntable is 0° to 360°, and the receive antenna has two polarizations Vertical (V) and Horizontal (H).
- A loop antenna, A log-periodic antenna or horn antenna shall be substituted in place of the EUT. The log-periodic antenna will be driven by a signal generator and the level will be adjusted till the same power value on the spectrum analyzer or receiver. The level of the spurious emissions can be calculated through the level of the signal generator, cable loss, the gain of the substitution antenna and the reading of the spectrum analyzer or receiver.
- The EUT is then put into continuously transmitting mode at its maximum power level during the test. Set Test Receiver or Spectrum RBW=200Hz,VBW=600Hz for 9kHz150kHz , RBW=10kHz, VBW=30kHz 150kHz-30MHz , RBW=100kHz,VBW=300kHz for 30MHz to 1GHz and RBW=1MHz, VBW=3MHz for above 1GHz, And the maximum value of the receiver should be recorded as (Pr).
- The EUT shall be replaced by a substitution antenna. In the chamber, an substitution antenna for the frequency band of interest is placed at the reference point of the chamber. An RF Signal source for the frequency band of interest is connected to the substitution antenna with a cable that has been constructed to not interfere with the radiation pattern of the antenna. A power (PMea) is applied to the input of the substitution antenna, and adjust the level of the signal generator output until the value of the receiver reach the previously recorded (Pr). The power of signal source (PMea) is recorded. The test should be performed by rotating the test item and adjusting the receiving antenna polarization.
- A amplifier should be connected to the Signal Source output port. And the cable should be connect between the Amplifier and the Substitution Antenna. The cable loss (Pcl) ,the Substitution Antenna Gain (Ga) and the Amplifier Gain (PAg) should be recorded after test.
- The measurement results are obtained as described below:

$$\text{Power(EIRP)} = \text{PMea} - \text{PAg} - \text{Pcl} + \text{Ga}$$
 The measurement results are amend as described below:

$$\text{Power(EIRP)} = \text{PMea} - \text{Pcl} + \text{Ga}$$
- This value is EIRP since the measurement is calibrated using an antenna of known gain (2.15 dBi)

and known input power. ERP can be calculated from EIRP by subtracting the gain of the dipole, $ERP = EIRP - 2.15\text{dBi}$.

The modulation mode and RB allocation refer to section 5.1, using the maximum output power configuration.

Test setup

9KHz ~ 30MHz

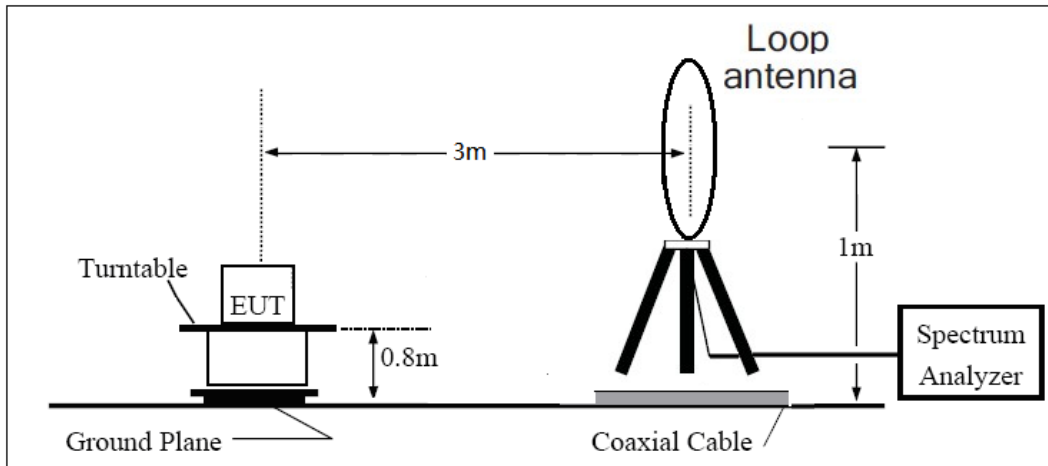

30MHz ~ 1GHz

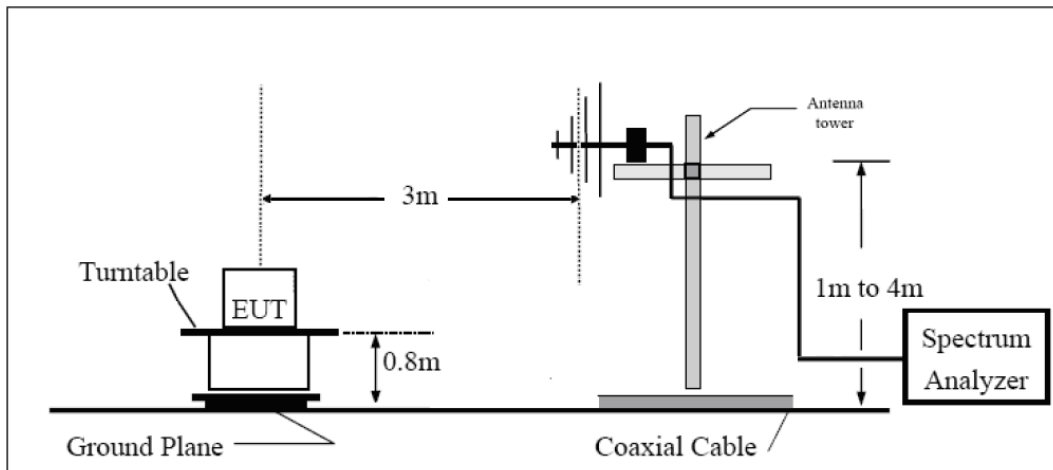

Above 1GHz

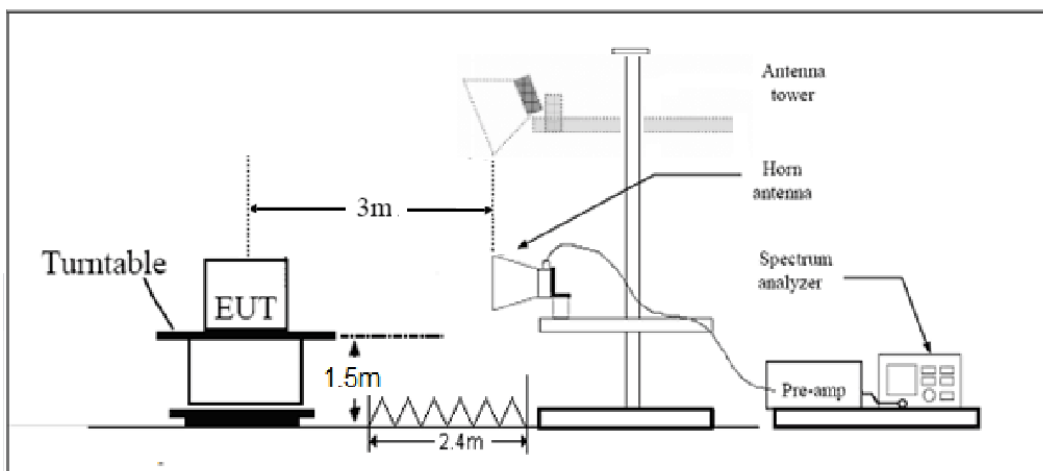



Note: Area side: 2.4mX3.6m

Limits

Rule Part 24.238(a) specifies that “on any frequency outside a licensee's frequency block, the power of any emission shall be attenuated below the transmitter power (P) by at least $43 + 10 \log_{10} (P)$ dB.”

Limit	-13 dBm
-------	---------

Measurement Uncertainty

The assessed measurement uncertainty to ensure 95% confidence level for the normal distribution is with the coverage factor $k = 1.96$, $U = 3.55$ dB.

Test Result

Sweep the whole frequency band through the range from 9kHz to the 10th harmonic of the carrier, the emissions below the noise floor will not be recorded in the report.

Standalone deployment with 15 KHz subcarrier spacing and QPSK mode for CAT NB1:

NB-IOT Band 2 CH-Low

Harmonic	Frequency (MHz)	SG (dBm)	Cable Loss (dB)	Gain (dBi)	Antenna Polarization	EIRP Level (dBm)	Limit (dBm)	Margin (dB)	Azimuth (deg)
2	3700.2	-54.68	5.1	11.05	vertical	-48.73	-13.00	35.73	180
3	5550.3	-53.31	5.42	12.65	vertical	-46.08	-13.00	33.08	315
4	7400.4	-49.53	6.7	13.85	vertical	-42.38	-13.00	29.38	135
5	9250.5	-49.27	7.01	14.75	vertical	-41.53	-13.00	28.53	225
6	11100.6	-46.55	7.48	15.95	vertical	-38.08	-13.00	25.08	90
7	12950.7	-45.39	7.51	16.55	vertical	-36.35	-13.00	23.35	180
8	14800.8	-41.69	8.24	15.35	vertical	-34.58	-13.00	21.58	45
9	16650.9	-42.73	8.41	14.95	vertical	-36.19	-13.00	23.19	180
10	18501.0	-41.05	8.54	15.45	vertical	-34.14	-13.00	21.14	45

Note: 1. The other Spurious RF Radiated emissions level is no more than noise floor.
2. The worst emission was found in the antenna is Horizontal position.

NB-IOT Band 2 CH-Middle

Harmonic	Frequency (MHz)	SG (dBm)	Cable Loss (dB)	Gain (dBi)	Antenna Polarization	EIRP Level (dBm)	Limit (dBm)	Margin (dB)	Azimuth (deg)
2	3760.0	-55.92	5.10	11.05	vertical	-49.97	-13.00	36.97	0
3	5640.0	-52.50	5.42	12.65	vertical	-45.27	-13.00	32.27	135
4	7520.0	-48.64	6.70	13.85	vertical	-41.49	-13.00	28.49	225
5	9400.0	-47.74	7.01	14.75	vertical	-40.00	-13.00	27.00	90
6	11280.0	-45.18	7.48	15.95	vertical	-36.71	-13.00	23.71	225
7	13160.0	-45.78	7.51	16.55	vertical	-36.74	-13.00	23.74	180
8	15040.0	-43.85	8.24	15.35	vertical	-36.74	-13.00	23.74	270
9	16920.0	-41.46	8.41	14.95	vertical	-34.92	-13.00	21.92	135
10	18800.0	-41.56	8.54	15.45	vertical	-34.65	-13.00	21.65	225

Note: 1. The other Spurious RF Radiated emissions level is no more than noise floor.
2. The worst emission was found in the antenna is Horizontal position.

NB-IOT Band 2 CH-High

Harmonic	Frequency (MHz)	SG (dBm)	Cable Loss (dB)	Gain (dBi)	Antenna Polarization	EIRP Level (dBm)	Limit (dBm)	Margin (dB)	Azimuth (deg)
2	3819.8	-56.35	5.10	11.05	vertical	-50.40	-13.00	37.40	135
3	5729.7	-55.98	5.42	12.65	vertical	-48.75	-13.00	35.75	90
4	7639.6	-48.76	6.70	13.85	vertical	-41.61	-13.00	28.61	45
5	9549.5	-50.14	7.01	14.75	vertical	-42.40	-13.00	29.40	180
6	11459.4	-45.01	7.48	15.95	vertical	-36.54	-13.00	23.54	45
7	13369.3	-45.26	7.51	16.55	vertical	-36.22	-13.00	23.22	0
8	15279.2	-43.74	8.24	15.35	vertical	-36.63	-13.00	23.63	135
9	17189.1	-41.16	8.41	14.95	vertical	-34.62	-13.00	21.62	225
10	19099.0	-41.44	8.54	15.45	vertical	-34.53	-13.00	21.53	90

Note: 1.The other Spurious RF Radiated emissions level is no more than noise floor.
 2. The worst emission was found in the antenna is Horizontal position.

NB-IOT Band 25 CH-Low

Harmonic	Frequency (MHz)	SG (dBm)	Cable Loss (dB)	Gain (dBi)	Antenna Polarization	EIRP Level (dBm)	Limit (dBm)	Margin (dB)	Azimuth (deg)
2	3700.2	-58.88	5.10	11.05	Horizontal	-52.93	-13.00	39.93	45
3	5550.3	-56.76	5.42	12.65	Horizontal	-49.53	-13.00	36.53	0
4	7400.4	-58.43	6.70	13.85	Horizontal	-51.28	-13.00	38.28	0
5	9250.5	-57.64	7.01	14.75	Horizontal	-49.90	-13.00	36.90	315
6	11100.6	-58.03	7.48	15.95	Horizontal	-49.56	-13.00	36.56	225
7	12950.7	-56.96	7.51	16.55	Horizontal	-47.92	-13.00	34.92	90
8	14800.8	-52.23	8.24	15.35	Horizontal	-45.12	-13.00	32.12	90
9	16650.9	-46.76	8.41	14.95	Horizontal	-40.22	-13.00	27.22	0
10	18501.0	-	-	-	-	-	-	-	-

Note: 1.The other Spurious RF Radiated emissions level is no more than noise floor.
 2. The worst emission was found in the antenna is Horizontal position.

NB-IOT Band 25 CH-Middle

Harmonic	Frequency (MHz)	SG (dBm)	Cable Loss (dB)	Gain (dBi)	Antenna Polarization	EIRP Level (dBm)	Limit (dBm)	Margin (dB)	Azimuth (deg)
2	3765.0	-56.73	5.10	11.05	Horizontal	-50.78	-13.00	37.78	135
3	5647.5	-57.58	5.42	12.65	Horizontal	-50.35	-13.00	37.35	135
4	7530.0	-57.68	6.70	13.85	Horizontal	-50.53	-13.00	37.53	45
5	9412.5	-62.08	7.01	14.75	Horizontal	-54.34	-13.00	41.34	270
6	11295.0	-56.59	7.48	15.95	Horizontal	-48.12	-13.00	35.12	225
7	13177.5	-56.40	7.51	16.55	Horizontal	-47.36	-13.00	34.36	0
8	15060.0	-50.37	8.24	15.35	Horizontal	-43.26	-13.00	30.26	90
9	16942.5	-47.58	8.41	14.95	Horizontal	-41.04	-13.00	28.04	45
10	18825.0	-	-	-	-	-	-	-	-

Note: 1.The other Spurious RF Radiated emissions level is no more than noise floor.
2. The worst emission was found in the antenna is Horizontal position.

NB-IOT Band 25 CH-High

Harmonic	Frequency (MHz)	SG (dBm)	Cable Loss (dB)	Gain (dBi)	Antenna Polarization	EIRP Level (dBm)	Limit (dBm)	Margin (dB)	Azimuth (deg)
2	3829.8	-56.02	5.10	11.05	Horizontal	-50.07	-13.00	37.07	0
3	5744.7	-57.49	5.42	12.65	Horizontal	-50.26	-13.00	37.26	0
4	7659.6	-57.97	6.70	13.85	Horizontal	-50.82	-13.00	37.82	135
5	9574.5	-58.18	7.01	14.75	Horizontal	-50.44	-13.00	37.44	135
6	11489.4	-57.31	7.48	15.95	Horizontal	-48.84	-13.00	35.84	45
7	13404.3	-57.33	7.51	16.55	Horizontal	-48.29	-13.00	35.29	90
8	15319.2	-48.77	8.24	15.35	Horizontal	-41.66	-13.00	28.66	135
9	17234.1	-47.91	8.41	14.95	Horizontal	-41.37	-13.00	28.37	270
10	19149.0	-	-	-	-	-	-	-	-

Note: 1.The other Spurious RF Radiated emissions level is no more than noise floor.
2. The worst emission was found in the antenna is Horizontal position.

6. Main Test Instruments

Name	Manufacturer	Type	Serial Number	Calibration Date	Expiration Date
Base Station Simulator	R&S	CMU200	118133	2018-05-13	2019-05-12
Base Station Simulator	R&S	CMW500	113824	2018-05-20	2019-05-19
Power Splitter	Hua Xiang	SHX-GF2-2-13	10120101	/	/
Spectrum Analyzer	Key sight	N9010A	MY50210259	2018-05-20	2019-05-19
Universal Radio Communication Tester	Key sight	E5515C	MY48367192	2018-05-20	2019-05-19
Signal Analyzer	R&S	FSV30	100815	2018-12-16	2019-12-15
Loop Antenna	SCHWARZBECK	FMZB1519	1519-047	2017-09-26	2019-09-25
Trilog Antenna	SCHWARZBECK	VUBL 9163	9163-201	2017-11-18	2019-11-17
Horn Antenna	R&S	HF907	100126	2018-07-07	2020-07-06
Horn Antenna	ETS-Lindgren	3160-09	00102643	2018-06-20	2020-06-19
Signal generator	R&S	SMB 100A	102594	2018-05-20	2019-05-19
Climatic Chamber	ESPEC	SU-242	93000506	2017-12-17	2020-12-16
Preamplifier	R&S	SCU18	102327	2018-05-20	2019-05-19
MOB COMMS DC SUPPLY	Keysight	66319D	MY43004105	2018-05-07	2019-05-06
RF Cable	Agilent	SMA 15cm	0001	/	/
Software	R&S	EMC32	9.26.0	/	/

*****END OF REPORT *****

ANNEX A: EUT Appearance and Test Setup

A.1 EUT Appearance



shielding



No shielding
Front Side

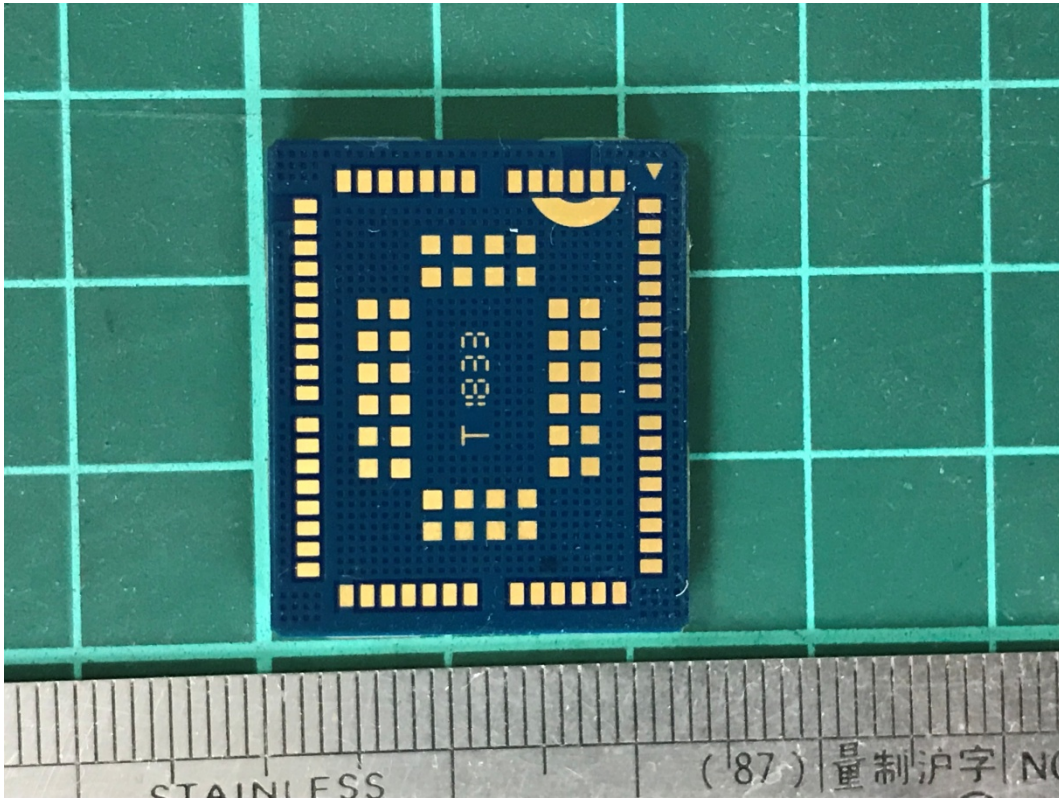

Back Side
a: EUT
Picture 1 EUT

A.2 Test Setup



Picture 2 Radiated Spurious Emissions Test setup

ANNEX B: Product Change Description



BG96 R1.1 & BG96 R1.2 Differences Statement

LTE Module Series

PCB Rev.: R1.2

Date: 2018-10-08



www.quectel.com

Build a Smarter World



Based on BG96 R1.1, BG96 R1.2 has enabled VDD_QFPROM_PRG hardware interface, which is connected to ground directly in BG96 R1.1, so as to support secure boot feature.

Some points are highlighted as below:

- BG96 R1.1 and R1.2 versions share the same hardware architecture and key components.
- BG96 R1.1 and R1.2 versions share the same pinout placements.
- Secure boot is enabled through a set of hardware fuses in BG96 R1.2. For the code to be executed, it must be signed by the trusted entity identified in the hardware fuses, so we have to enable VDD_QFPROM_PRG hardware interface.
- The new hardware will be used with the new software baseline TX3.0, and the software version is R04Axx.

The details are illustrated as below:

1. What's Secure Boot

Secure boot refers to the bootup sequence that establishes a trusted platform for secure applications. It starts as an immutable sequence that validates the origin of the code using cryptographic authentication so only authorized software can be executed. The bootup sequence places the device in a known security state and protects against binary manipulation of software and reflashing attacks.

A secure boot system adds cryptographic checks to each stage of the boot up process. This process asserts the authenticity of all secure software images that are executed by the device. This additional check prevents any unauthorized or maliciously modified software from running on the device. Secure boot is enabled through a set of hardware fuses. For the code to be executed, it must be signed by the trusted entity identified in the hardware fuses.

In simple terms, secure boot ensures running of signed/authorized software on the module, and unsigned/unauthorized software will not be allowed to run.

2. Enabled VDD_QFPROM_PRG Hardware Interface

A. BG96 R1.1 does not support secure boot function

The VDD_QFPROM_PRG (N19) pin of baseband chip is for secure boot function. In BG96 R1.1, this pin is connected to ground directly, which means secure boot function is disabled.

B. BG96 R1.2 supports secure boot function

According to Qualcomm's suggestion and our customers' requirements, the VDD_QFPROM_PRG pin is connected to VREG_L3_1P8(1.8V) in BG96 R1.2 so as to enable secure boot function.

The following pictures show the schematic and PCB designs of BG96 R1.1 and R1.2.

Build a Smarter World



Figure 1: Schematic Designs of BG96 R1.1 and R1.2

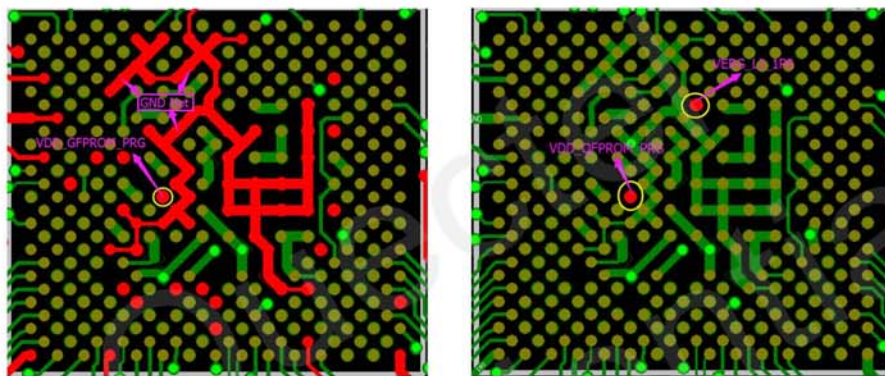

Figure 2: PCB Designs of BG96 R1.1 and R1.2

3. TX2.0 vs TX3.0

The biggest difference of TX3.0 as compared with TX2.0 lies in the adding of VoLTE and handover features. Since VoLTE environment has not been built so maturely yet, the main concern of customers is the handover function.

For TX2.0, re-selection is supported, while handover is not supported.

BG96 supports re-selection mechanism, which means when disconnection happens during cell handover, the module will reconnect automatically. This process lasts for about 1 (or 2) seconds, and the data transmitted (may happen by coincidence) will be buffered and resent once the reconnection established. So, the disconnection is generally imperceptible to customers.

- If the data transmission occurs at the moment that cell handover occurs coincidentally, the connection is kept with handover function; the connection is broken and re-connection established in about 1 (or 2) seconds with re-selection. This causes nearly no difference for data telematics because users even cannot feel this disconnection, whereas VoLTE might be affected because of the short time disconnection.



Build a Smarter World



- If the data transmission occurs in the period that no cell alternates, then no any influence will be caused.

Quectel
Confidential