



RF TEST REPORT

Applicant Quectel Wireless Solutions Co., Ltd.

FCC ID XMR201707BG96

Product LTE Cat M1 & Cat NB1 & EGPRS Module

Brand Quectel

Model BG96, BG96 MINIPCIE

Marketing Quectel BG96, Quectel BG96 MINIPCIE

Report No. R1811A0536-R1

Issue Date February 25, 2019

TA Technology (Shanghai) Co., Ltd. tested the above equipment in accordance with the requirements in **FCC CFR47 Part 2 (2018)/ FCC CFR 47 Part 22H (2018)**. The test results show that the equipment tested is capable of demonstrating compliance with the requirements as documented in this report.

Performed by: Peng Tao

Approved by: Kai Xu

TA Technology (Shanghai) Co., Ltd.

No.145, Jintang Rd, Tangzhen Industry Park, Pudong Shanghai, China

TEL: +86-021-50791141/2/3

FAX: +86-021-50791141/2/3-8000



TABLE OF CONTENT

1. Test Laboratory	4
1.1. Notes of the Test Report	4
1.2. Test facility	4
1.3. Testing Location	5
2. General Description of Equipment under Test.....	6
3. Applied Standards.....	7
4. Test Configuration.....	8
5. Test Case Results.....	10
5.1. RF Power Output.....	10
5.2. Effective Radiated Power	13
5.3. Occupied Bandwidth	16
5.4. Band Edge Compliance.....	21
5.5. Peak-to-Average Power Ratio (PAPR)	28
5.6. Frequency Stability	30
5.7. Spurious Emissions at Antenna Terminals	35
5.8. Radiates Spurious Emission	41
6. Main Test Instruments	48
ANNEX A: EUT Appearance and Test Setup.....	49
A.1 EUT Appearance	49
A.2 Test Setup.....	51
ANNEX B: Product Change Description.....	52

Summary of measurement results

No.	Test Type	Clause in FCC rules	Verdict
1	RF power output	2.1046	PASS
2	Effective Radiated Power	22.913(a)(2)	PASS
3	Occupied Bandwidth	2.1049	PASS
4	Band Edge Compliance	2.1051 / 22.917(a)	PASS
5	Peak-to-Average Power Ratio	22.913(d)/ KDB 971168 D01(5.7)	PASS
6	Frequency Stability	2.1055 / 22.355	PASS
7	Spurious Emissions at Antenna Terminals	2.1051 / 22.917(a)	PASS
8	Radiates Spurious Emission	2.1053 / 22.917 (a)	PASS
Date of Testing: June 24, 2017~July 3, 2017			
Note: PASS: The EUT complies with the essential requirements in the standard. FAIL: The EUT does not comply with the essential requirements in the standard.			

BG96, BG96 MINIPCIE (Report No: R1811A0536-R1) is a variant model of BG96 (Report No: RXA1706-0199RF01R1). Test values duplicated from Original for variant. There is no test for variant in this report. The detailed product change description please refers to the ANNEX B.



1. Test Laboratory

1.1. Notes of the Test Report

This report shall not be reproduced in full or partial, without the written approval of **TA technology (shanghai) co., Ltd.** The results documented in this report apply only to the tested sample, under the conditions and modes of operation as described herein .Measurement Uncertainties were not taken into account and are published for informational purposes only. This report is written to support regulatory compliance of the applicable standards stated above. This report must not be used by the client to claim product certification, approval, or endorsement by any government agencies.

1.2. Test facility

CNAS (accreditation number: L2264)

TA Technology (Shanghai) Co., Ltd. has obtained the accreditation of China National Accreditation Service for Conformity Assessment (CNAS).

FCC (recognition number is 428261)

TA Technology (Shanghai) Co., Ltd. has been listed on the US Federal Communications Commission list of test facilities recognized to perform electromagnetic emissions measurements.

IC (recognition number is 8510A)

TA Technology (Shanghai) Co., Ltd. has been listed by industry Canada to perform electromagnetic emission measurement.

VCCI (recognition number is C-4595, T-2154, R-4113, G-10766)

TA Technology (Shanghai) Co., Ltd. has been listed by industry Japan to perform electromagnetic emission measurement.

A2LA (Certificate Number: 3857.01)

TA Technology (Shanghai) Co., Ltd. has been listed by American Association for Laboratory Accreditation to perform electromagnetic emission measurement.



1.3. Testing Location

Company: TA Technology (Shanghai) Co., Ltd.
Address: No.145, Jintang Rd, Tangzhen Industry Park, Pudong
City: Shanghai
Post code: 201201
Country: P. R. China
Contact: Xu Kai
Telephone: +86-021-50791141/2/3
Fax: +86-021-50791141/2/3-8000
Website: <http://www.ta-shanghai.com>
E-mail: xukai@ta-shanghai.com

2. General Description of Equipment under Test

Client Information

Applicant	Quectel Wireless Solutions Co., Ltd.
Applicant address	7th Floor, Hongye Building, No. 1801 Hongmei Road, Xuhui District, Shanghai, China
Manufacturer	Quectel Wireless Solutions Co., Ltd.
Manufacturer address	7th Floor, Hongye Building, No. 1801 Hongmei Road, Xuhui District, Shanghai, China

General Information

EUT Description			
Model	BG96, BG96 MINIPCIE		
IMEI	866425038291656		
Hardware Version	R1.2		
Software Version	BG96MAR04A01M1G		
Power Supply	External power supply		
Antenna Type	The EUT don't have standard Antenna, The Antenna used for testing in this report is the after-market accessory (Dipole Antenna)		
Antenna Gain	4 dBi		
Test Mode(s)	GSM 850: LTE Band 5;		
Test Modulation	(GSM)GMSK,8PSK; (LTE)QPSK 16QAM;		
LTE Category	M1		
Maximum E.R.P.	GSM 850:	32.13 dBm	
	LTE Band 5:	27.65 dBm	
Rated Power Supply Voltage	3.8V		
Extreme Voltage	Minimum: 3.3V Maximum: 4.3V		
Extreme Temperature	Lowest: -40°C Highest: +85°C		
Operating Frequency Range(s)	Band	Tx (MHz)	Rx (MHz)
	GSM850	824 ~ 849	869 ~ 894
	LTE Band 5	824 ~ 849	869 ~ 894
Note: The information of the EUT is declared by the manufacturer.			

The series model number is: BG96 MINIPCIE. The difference of these models are have different marketing requirement.

Accessory equipment	
Evaluation Board	RF Cable
RS232-to-USB Cable	Antenna: Dipole Antenna
Headset	USB Cable



3. Applied Standards

According to the specifications of the manufacturer, it must comply with the requirements of the following standards:

FCC CFR47 Part 2 (2018)

FCC CFR 47 Part 22H (2018)

ANSI C63.26 (2015)

KDB 971168 D01 Power Meas License Digital Systems v03r01

4. Test Configuration

Radiated measurements are performed by rotating the EUT in three different orthogonal test planes. EUT stand-up position (X, Y axis), lie-down position (Z axis). Receiver antenna polarization (horizontal and vertical), the worst emission was found in position (Z axis, vertical polarization) and the worst case was recorded.

All mode and data rates and positions were investigated. Subsequently, only the worst case emissions are reported.

The following testing in GSM/LTE is set based on the maximum RF Output Power.

Test modes are chosen to be reported as the worst case configuration below:

	Test items	Modes/Modulation
		GSM 850
Conducted Test cases	RF power output	GPRS EGPRS
	Occupied Bandwidth	GPRS(1Tx slot) EGPRS(1Tx slot)
	Band Edge Compliance	GPRS(1Tx slot) EGPRS(1Tx slot)
	Peak-to-Average Power Ratio	GPRS(1Tx slot) EGPRS(1Tx slot)
	Frequency Stability	GPRS(1Tx slot) EGPRS(1Tx slot)
	Spurious Emissions at Antenna Terminals	GPRS(1Tx slot)
Radiated Test cases	Effective Radiated Power	GPRS(1Tx slot) EGPRS(1Tx slot)
	Radiates Spurious Emission	GPRS(1Tx slot)



Test modes are chosen as the worst case configuration below for LTE Band 5

Test items	Bandwidth (MHz)				Modulation		RB			Test Channel		
	1.4	3	5	10	QPSK	16QAM	1	50%	100%	L	M	H
RF power output	○	○	○	○	○	○	○	○	○	○	○	○
Effective Isotropic Radiated power	○	○	○	○	○	○	-	-	○	○	○	○
Occupied Bandwidth	○	○	○	○	○	○	-	-	○	-	○	-
Band Edge Compliance	○	○	○	○	○	○	○	-	○	○	-	○
Peak-to-Average Power Ratio	○	○	○	○	○	○	-	-	○	-	○	-
Frequency Stability	○	○	○	○	○	○	-	-	○	-	○	-
Spurious Emissions at Antenna Terminals	○	○	○	○	○	-	○	-	-	○	○	○
Radiates Spurious Emission	-	-	-	○	○	-	○	-	-	○	○	○
Note	1. The mark "○" means that this configuration is chosen for testing. 2. The mark "-" means that this configuration is not testing.											

5. Test Case Results

5.1. RF Power Output

Ambient condition

Temperature	Relative humidity	Pressure
23°C ~25°C	45%~50%	101.5kPa

Methods of Measurement

During the process of the testing, The EUT is controlled by the Base Station Simulator to ensure max power transmission and proper modulation.

Test Setup

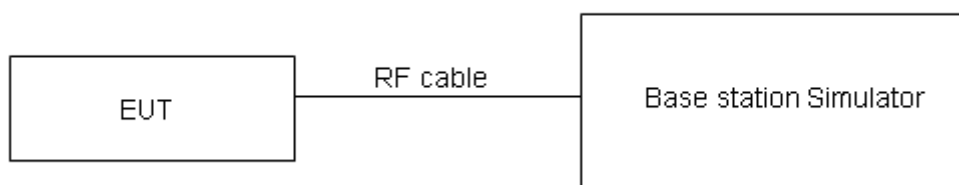

The loss between RF output port of the EUT and the input port of the tester has been taken into consideration.

Limits

No specific RF power output requirements in part 2.1046.

Measurement Uncertainty

The assessed measurement uncertainty to ensure 95% confidence level for the normal distribution is with the coverage factor $k = 2$, $U = 0.4$ dB.

Test Results

GSM 850		Conducted Power(dBm)		
		Channel 128	Channel 190	Channel 251
		824.2 (MHz)	836.6 (MHz)	848.8 (MHz)
GPRS (GMSK)	1TXslot	32.25	32.28	32.31
	2TXslots	32.11	32.05	32.10
	3TXslots	31.21	31.26	31.31
	4TXslots	30.01	30.11	30.28
EGPRS (8PSK)	1TXslot	26.58	26.65	26.78
	2TXslots	26.51	26.48	26.61
	3TXslots	26.27	26.28	26.42
	4TXslots	26.05	26.06	26.19



Mode	Bandwidth	Channel/ Frequency(MHz)	RB# RBstart	Index	Conducted Power (dBm)	
					QPSK	16QAM
Band5	1.4MHz	20407/824.7	1#0	0	22.66	23.79
			6#0	0	22.62	22.67
		20525/836.5	1#0	0	23.15	22.63
			6#0	0	22.71	23.20
		20643/848.3	1#5	0	23.21	23.14
			6#0	0	22.86	23.00
	3MHz	20415/825.5	1#0	0	22.68	23.81
			6#0	0	22.70	22.70
		20525/836.5	1#0	0	23.16	22.66
			6#0	0	22.73	23.25
		20635/847.5	1#5	1	23.24	23.16
			6#0	1	22.90	23.04
	5MHz	20425/826.5	1#0	0	22.67	23.76
			6#0	0	22.68	22.67
		20525/836.5	1#0	0	23.12	22.64
			6#0	0	22.69	23.20
		20625/846.5	1#5	3	23.22	23.14
			6#0	3	22.85	23.00
	10MHz	20450/829	1#0	0	22.64	23.74
			4#0	0	22.65	22.65
		20525/836.5	1#0	0	23.08	22.60
			4#0	0	22.64	23.16
		20600/844	1#5	7	23.19	23.09
			4#2	7	22.81	22.97

5.2. Effective Radiated Power

Ambient condition

Temperature	Relative humidity	Pressure
23°C ~25°C	45%~50%	101.5kPa

Methods of Measurement

The testing follows FCC KDB 971168 v03r01 Section 5.8 and ANSI C63.26 (2015).

- Connect the equipment as illustrated. Mount the equipment with the manufacturer specified antenna in a vertical orientation on a manufacturer specified mounting surface located on a non-conducting rotating platform of a RF anechoic chamber (preferred) or a standard radiation site.
- Key the transmitter, then rotate the EUT 360° azimuthally and record spectrum analyzer power level (LVL) measurements at angular increments that are sufficiently small to permit resolution of all peaks. If a standard radiation test site is used, raise and lower the test antenna to obtain a maximum reading at each angular increment. (Note: several batteries may be needed to offset the effect of battery voltage droop, which should not exceed 5% of the manufactured specified battery voltage during transmission).
- Replace the transmitter under test with a vertically polarized half-wave dipole (or an antenna whose gain is known relative to an ideal half-wave dipole). The center of the antenna should be at the same location as the center of the antenna under test.
- Connect the antenna to a signal generator with a known output power and record the path loss (in dB) as LOSS. If a standard radiation test site is used, raise and lower the test antenna to obtain a maximum reading. $LOSS = \text{Generator Output Power (dBm)} - \text{Analyzer reading (dBm)}$
- Determine the effective radiated output power at each angular position from the readings in steps b) and d) using the following equation: $ERP \text{ (dBm)} = \text{LVL (dBm)} + \text{LOSS (dB)}$
- The maximum ERP is the maximum value determined in the preceding step.
- When calculating ERP, in addition to knowing the antenna radiation and matching characteristics, it is necessary to know the loss values of all elements (e.g. transmission line attenuation, mismatches, filters, combiners) interposed between the point where transmitter output power is measured, and the point where power is applied to the antenna. ERP can then be calculated as follows:
 $EIRP \text{ (dBm)} = \text{Output Power (dBm)} - \text{Losses (dB)} + \text{Antenna Gain (dBi)}$
where: dBd refers to gain relative to an ideal dipole.
 $EIRP \text{ (dBm)} = ERP \text{ (dBm)} + 2.15 \text{ (dB.)}$

The RB allocation refers to section 5.1, using the maximum output power configuration.

Test setup

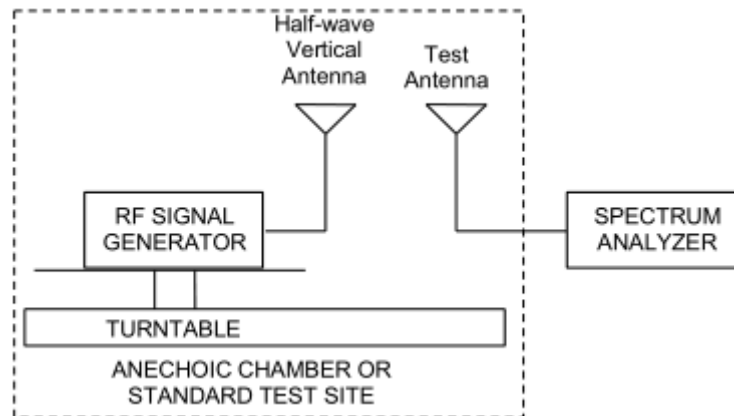
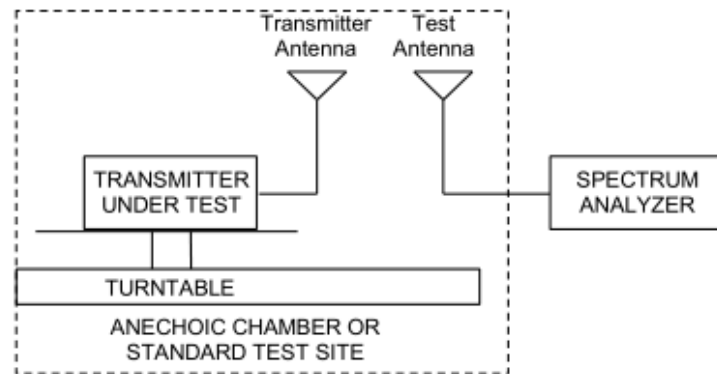

Limits

Rule Part 22.913(a)(5) specifies that "Mobile/portable stations are limited to 7 watts ERP".

Limit	$\leq 7 \text{ W}$ (38.45 dBm)
-------	--------------------------------

Measurement Uncertainty

The assessed measurement uncertainty to ensure 95% confidence level for the normal distribution is with the coverage factor $k = 2$, $U = 1.19 \text{ dB}$

**Test Results:**

The measurement is performed for both of horizontal and vertical antenna Polarization, and only the data of worst mode is recorded in this report.

Mode	Frequency (MHz)	Polarization	ERP (dBm)	Limit (dBm)	Conclusion
GPRS 850	824.2	Horizontal	32.13	38.45	Pass
	836.6	Horizontal	31.80	38.45	Pass
	848.8	Horizontal	31.09	38.45	Pass
EGPRS 850	824.2	Horizontal	26.43	38.45	Pass
	836.6	Horizontal	26.50	38.45	Pass
	848.8	Horizontal	26.63	38.45	Pass

LTE Band 5							
bandwidth	Channel/ Frequency (MHz)	Polarization	RB	Index	ERP (dBm)	Limit (dBm)	Conclusion
1.4 MHz (QPSK)	20407/824.7	Horizontal	1#0	0	26.04	38.45	Pass
	20525/836.5	Horizontal	1#2	0	26.98	38.45	Pass
	20643/848.3	Horizontal	1#5	0	27.29	38.45	Pass
3 MHz (QPSK)	20415/825.5	Horizontal	1#0	0	25.72	38.45	Pass
	20525/836.5	Horizontal	1#5	0	27.17	38.45	Pass
	20635/847.5	Horizontal	1#5	1	26.95	38.45	Pass
5 MHz (QPSK)	20425/826.5	Horizontal	1#0	0	25.49	38.45	Pass
	20525/836.5	Horizontal	1#5	1	26.73	38.45	Pass
	20625/846.5	Horizontal	1#5	3	27.53	38.45	Pass
10 MHz (QPSK)	20450/829	Horizontal	4#0	0	24.43	38.45	Pass
	20525/836.5	Horizontal	4#2	3	26.06	38.45	Pass
	20600/844	Horizontal	4#2	7	26.22	38.45	Pass
1.4 MHz (16QAM)	20407/824.7	Horizontal	1#0	0	25.70	38.45	Pass
	20525/836.5	Horizontal	1#2	0	26.66	38.45	Pass
	20643/848.3	Horizontal	1#5	0	26.95	38.45	Pass
3 MHz (16QAM)	20415/825.5	Horizontal	1#0	0	25.40	38.45	Pass
	20525/836.5	Horizontal	1#5	0	26.85	38.45	Pass
	20635/847.5	Horizontal	1#5	1	27.65	38.45	Pass
5 MHz (16QAM)	20425/826.5	Horizontal	1#0	0	25.17	38.45	Pass
	20525/836.5	Horizontal	1#5	1	26.40	38.45	Pass
	20625/846.5	Horizontal	1#5	3	27.20	38.45	Pass
10 MHz (16QAM)	20450/829	Horizontal	4#0	0	24.10	38.45	Pass
	20525/836.5	Horizontal	4#2	3	25.75	38.45	Pass
	20600/844	Horizontal	4#2	7	25.90	38.45	Pass

5.3. Occupied Bandwidth

Ambient condition

Temperature	Relative humidity	Pressure
23°C ~25°C	45%~50%	101.5kPa

Method of Measurement

The EUT was connected to Spectrum Analyzer and Base Station Simulator via power Splitter. The occupied bandwidth is measured using spectrum analyzer.

RBW is set to 3kHz, VBW is set to 10kHz for GSM 850,

RBW is set to 51 kHz, VBW is set to 160 kHz for LTE Band 5,

99% power and -26dBc occupied bandwidths are recorded. Spectrum analyzer plots are included on the following pages.

Test Setup

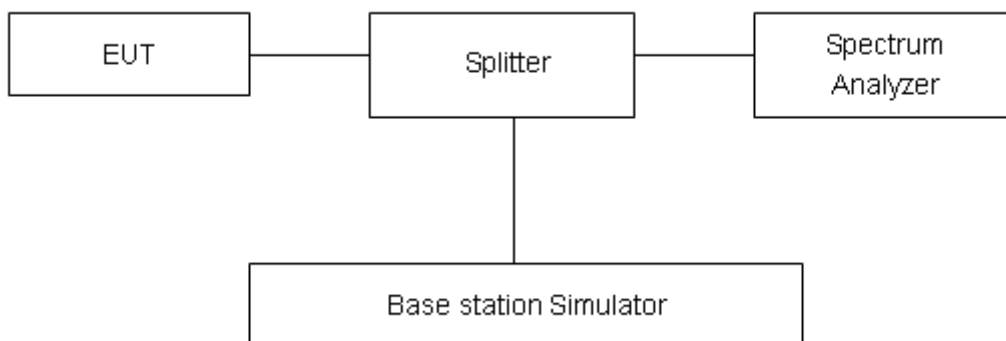

Limits

No specific occupied bandwidth requirements in part 2.1049.

Measurement Uncertainty

The assessed measurement uncertainty to ensure 95% confidence level for the normal distribution is with the coverage factor $k = 2$, $U = 624\text{Hz}$.

Test Result

Mode	Channel	Frequency (MHz)	99% Power Bandwidth (MHz)	-26dBc Bandwidth(MHz)
GPRS 850 (GMSK)	128	824.2	0.24584	0.3134
	190	836.6	0.24471	0.3148
	251	848.8	0.24419	0.3039
EGPRS 850 (8-PSK)	128	824.2	0.24858	0.2973
	190	836.6	0.24438	0.3111
	251	848.8	0.24744	0.3130

Mode	Bandwidth	Modulation	Channel/ Frequency(MHz)	RB	Index	Bandwidth(MHz)	
						99% Power	-26dBc
Band5	1.4MHz	QPSK	20525/836.5	6#0	0	1.1074	1.329
		16QAM	20525/836.5	6#0	0	0.94726	1.198
	3MHz	QPSK	20525/836.5	6#0	0	1.1561	1.848
		16QAM	20525/836.5	6#0	0	0.98345	1.345
	5MHz	QPSK	20525/836.5	6#0	0	1.1536	1.866
		16QAM	20525/836.5	6#0	0	1.0072	1.453
	10MHz	QPSK	20525/836.5	6#0	0	1.1952	1.92
		16QAM	20525/836.5	6#0	0	1.0457	1.661

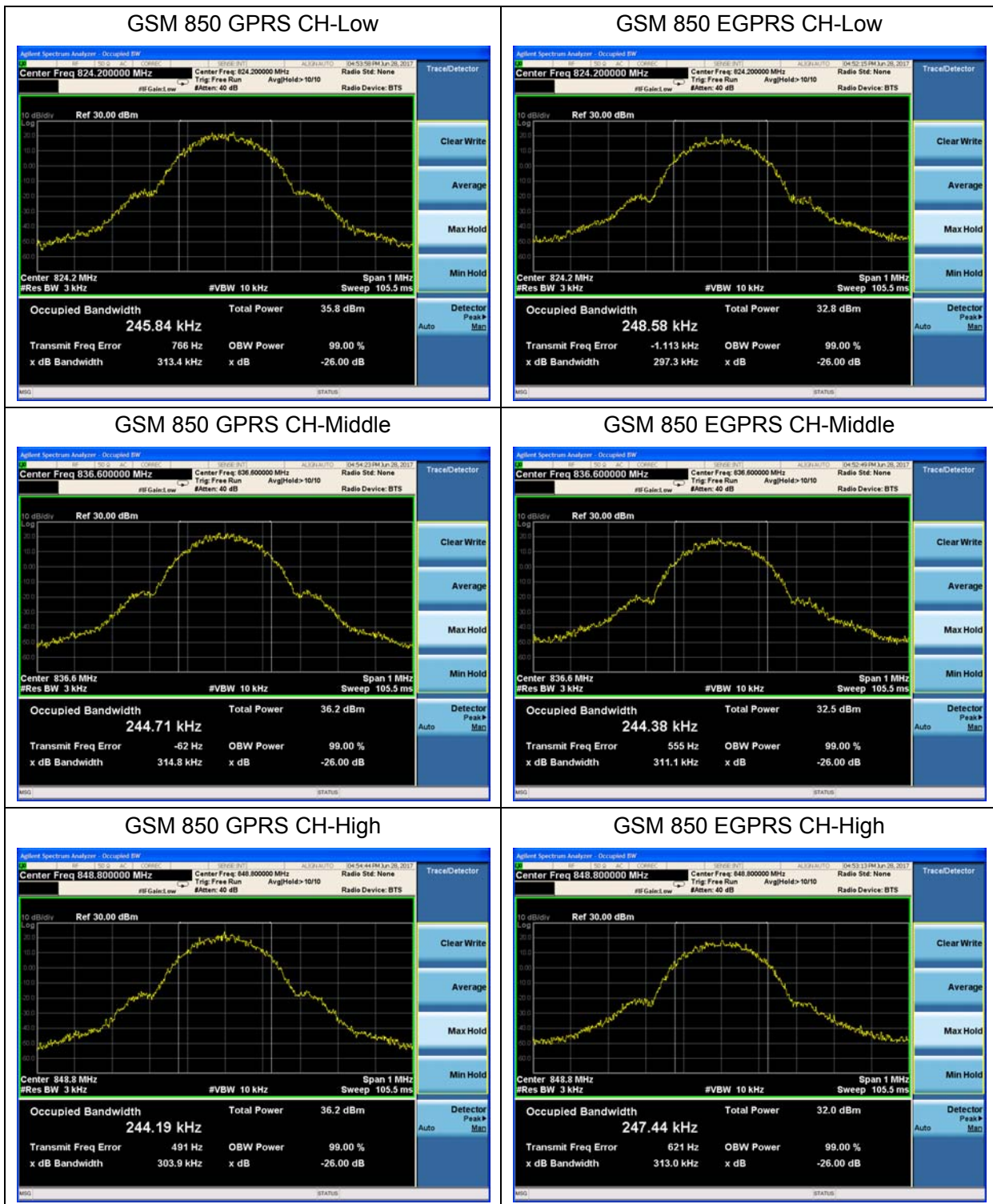

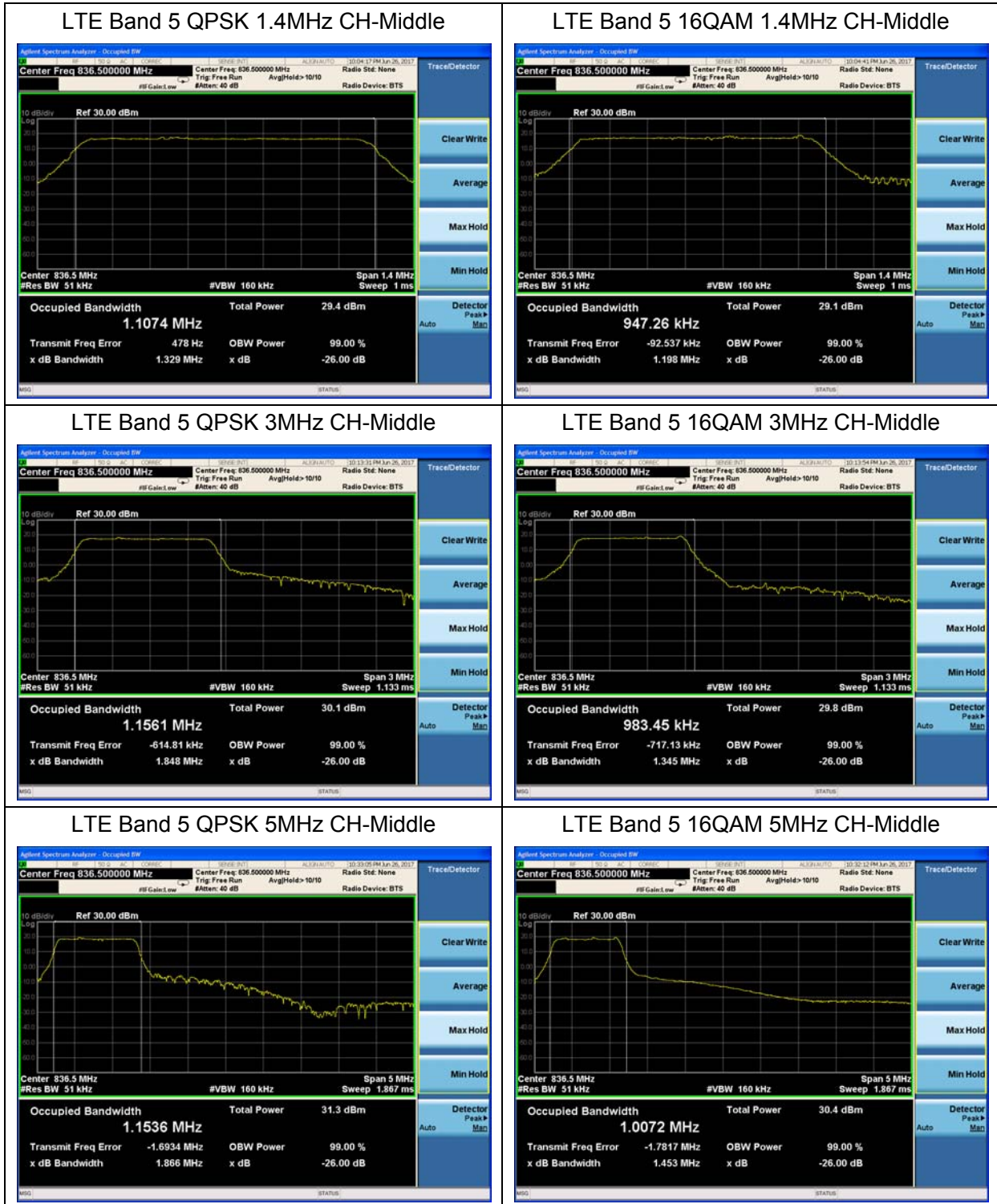

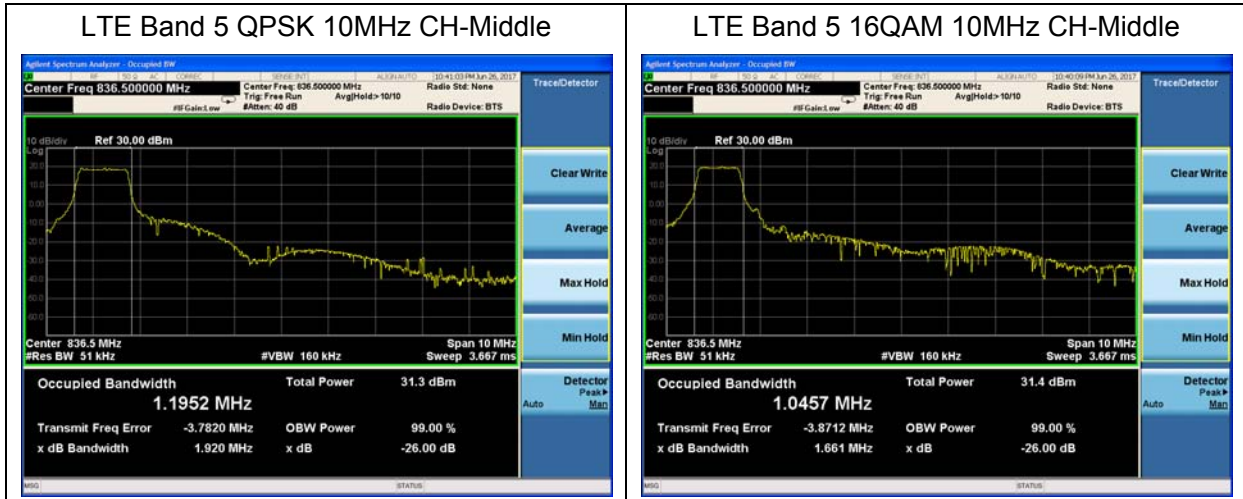

5.4. Band Edge Compliance

Ambient condition

Temperature	Relative humidity	Pressure
23°C ~25°C	45%~50%	101.5kPa

Method of Measurement

The EUT was connected to Spectrum Analyzer and Base Station Simulator via power Splitter. The band edge of the lowest and highest channels were measured. The average detector is used. RBW is set to 3kHz,VBW is set to 10kHz for GSM 850, RBW is set to 51kHz, VBW is set to 160kHz for LTE Band 5. Spectrum analyzer plots are included on the following pages.

Test Setup

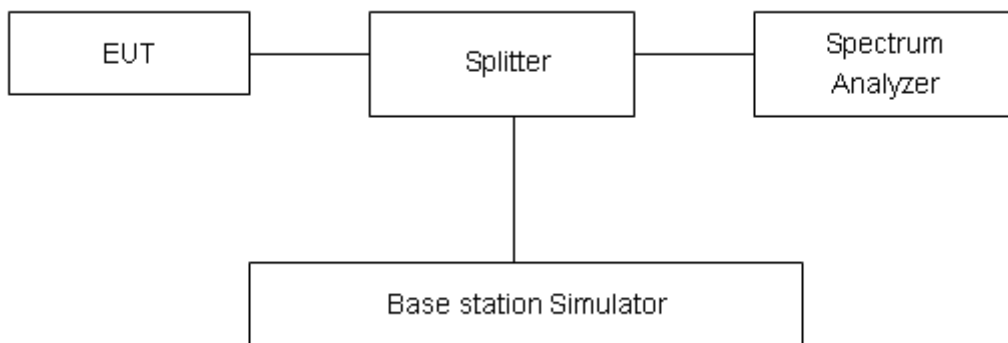

Limits

Rule Part 22.917(a) specifies that “The power of any emission outside of the authorized operating frequency ranges must be attenuated below the transmitting power (P) by a factor of at least 43 + 10 log(P) dB.”

Limit	-13 dBm
-------	---------

Measurement Uncertainty

The assessed measurement uncertainty to ensure 95% confidence level for the normal distribution is with the coverage factor $k = 1.96$, $U=0.684$ dB.

Test Result:

GSM 850 GPRS CH-Low



GSM 850 GPRS CH-High

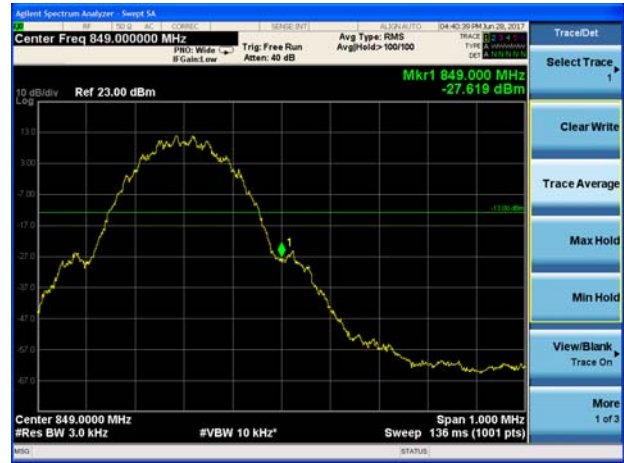

GSM 850 EGPRS CH-Low



GSM 850 EGPRS CH-High



LTE Band 5 QPSK 1.4MHz CH-Low 1RB

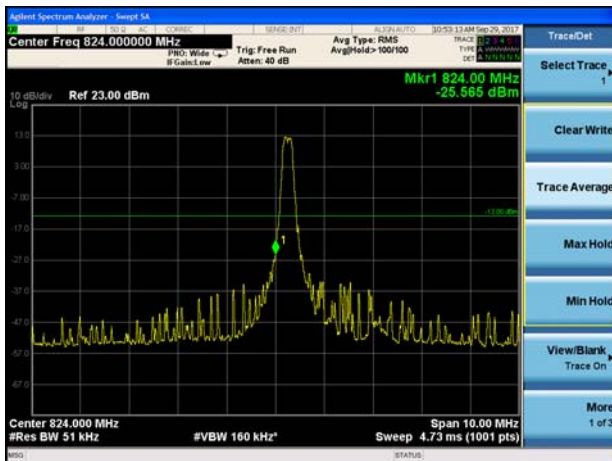

LTE Band 5 QPSK 1.4MHz CH-High 1RB

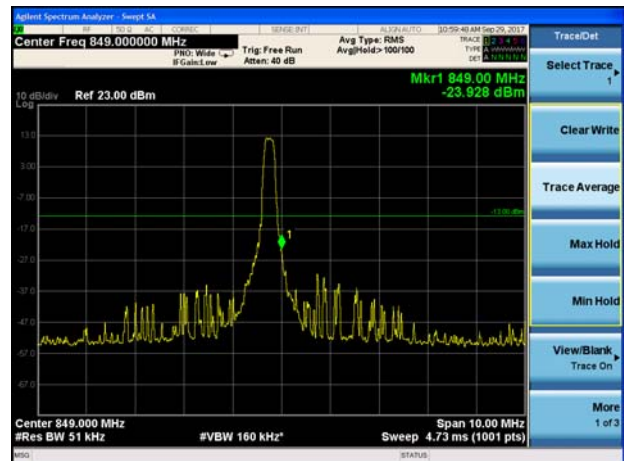

LTE Band 5 QPSK 1.4MHz CH-Low 100%RB

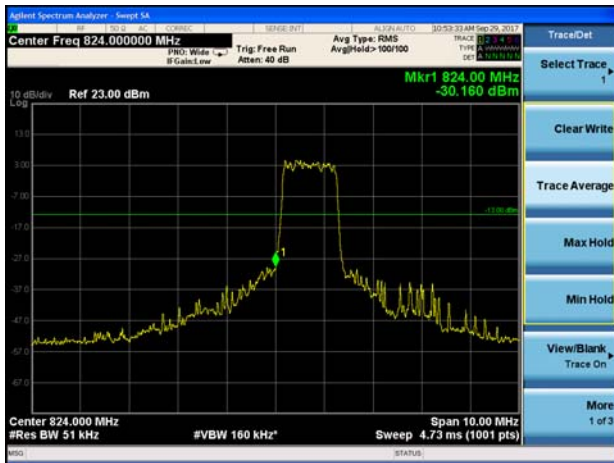

LTE Band 5 QPSK 1.4MHz CH-High 100%RB

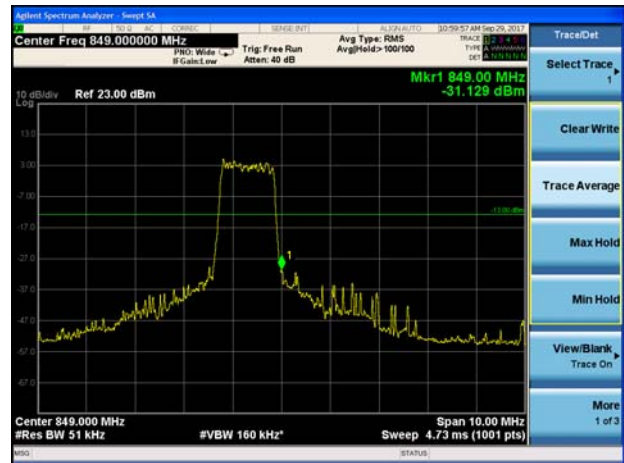

LTE Band 5 QPSK 3MHz CH-Low 1RB

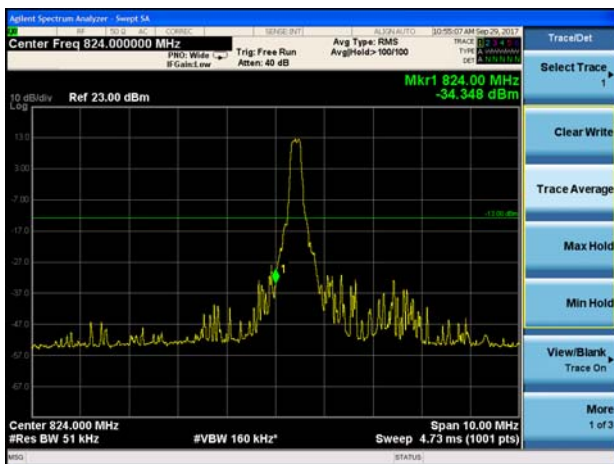

LTE Band 5 QPSK 3MHz CH-High 1RB

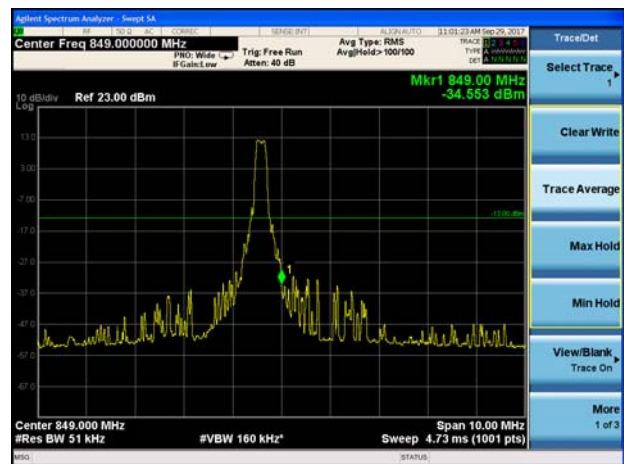

LTE Band 5 QPSK 3MHz CH-Low 100%RB

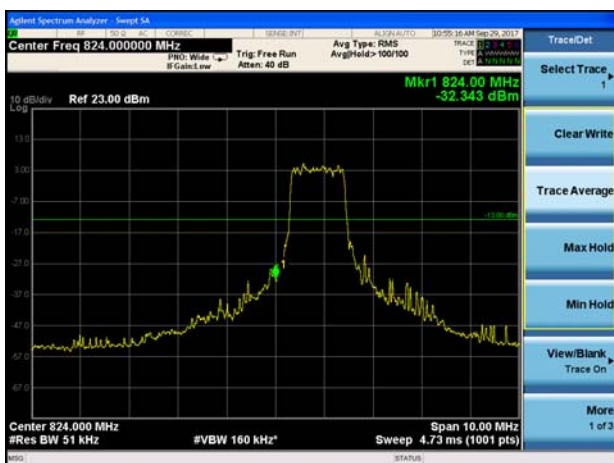

LTE Band 5 QPSK 3MHz CH-High 100%RB

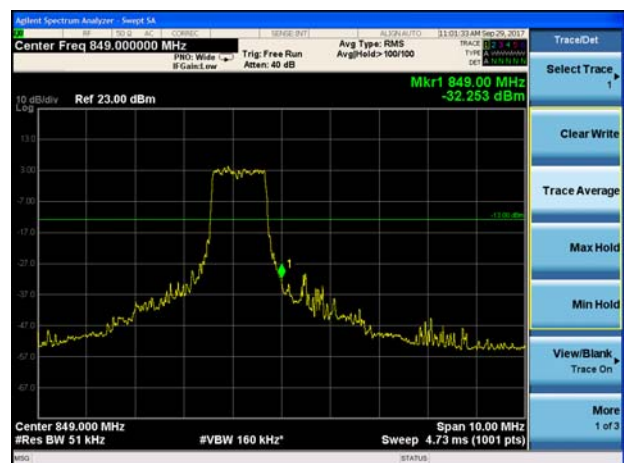

LTE Band 5 QPSK 5MHz CH-Low 1RB

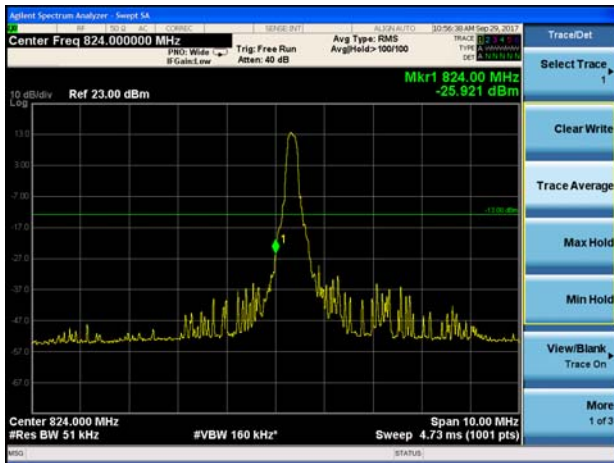

LTE Band 5 QPSK 5MHz CH-High 1RB

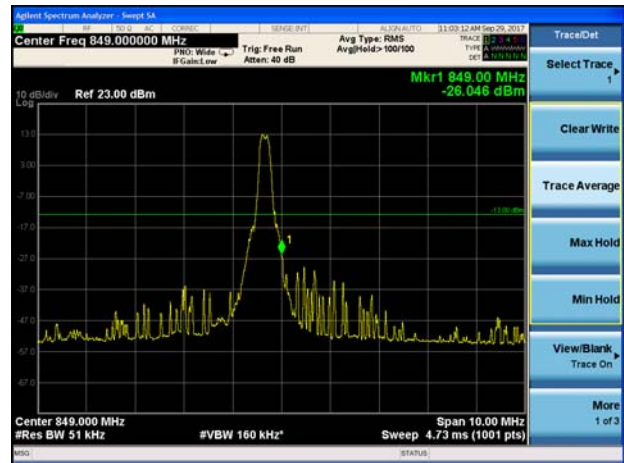

LTE Band 5 QPSK 5MHz CH-Low 100%RB

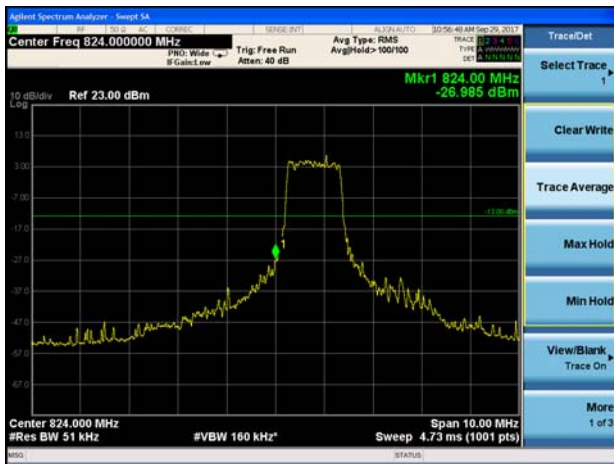

LTE Band 5 QPSK 5MHz CH-High 100%RB

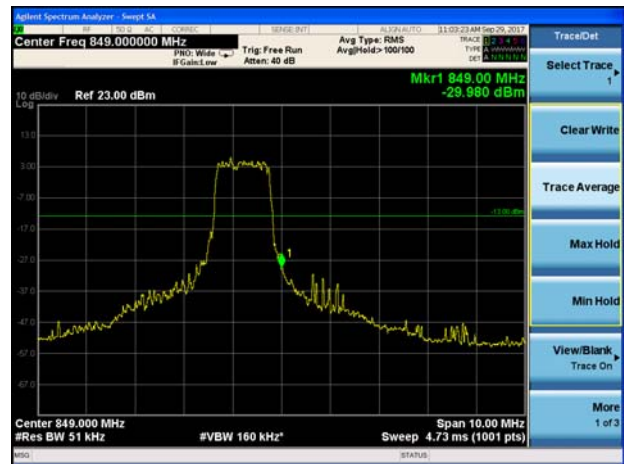

LTE Band 5 QPSK 10MHz CH-Low 1RB

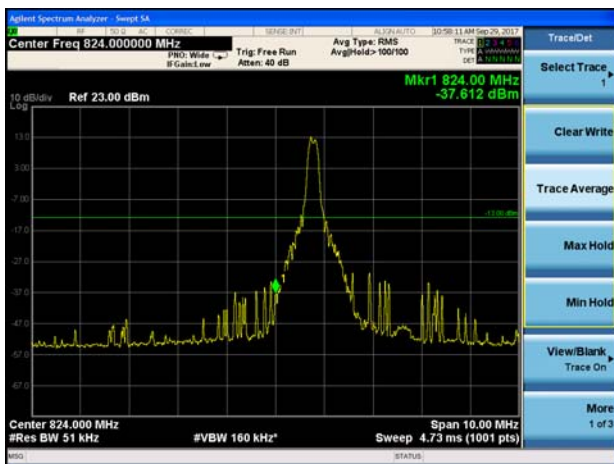

LTE Band 5 QPSK 10MHz CH-High 1RB

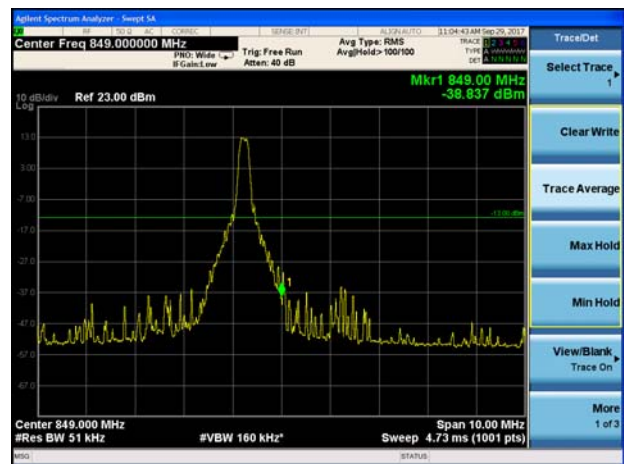



LTE Band 5 QPSK 10MHz CH-Low 100%RB

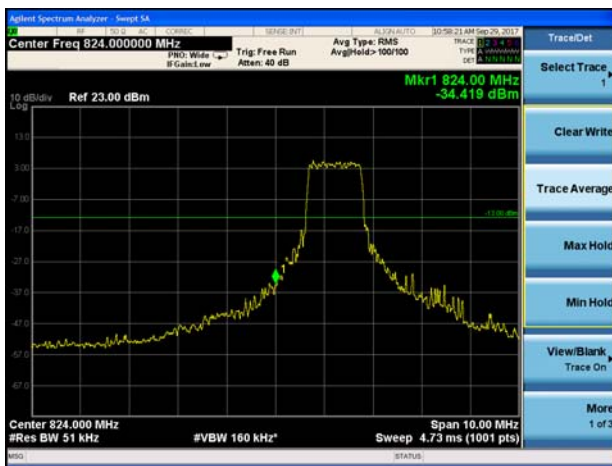

LTE Band 5 QPSK 10MHz CH-High 100%RB



LTE Band 5 16QAM 1.4MHz CH-Low 1RB

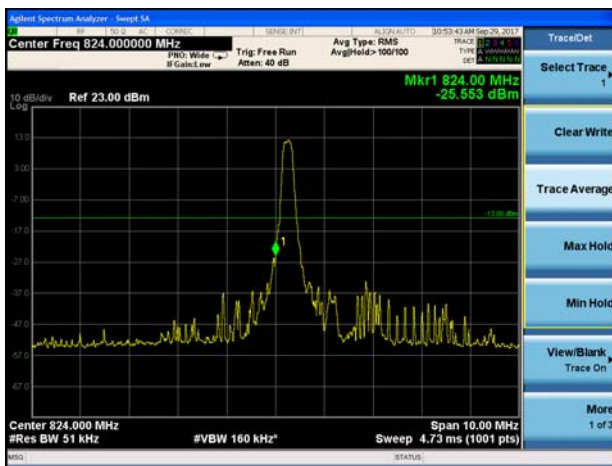

LTE Band 5 16QAM 1.4MHz CH-High 1RB

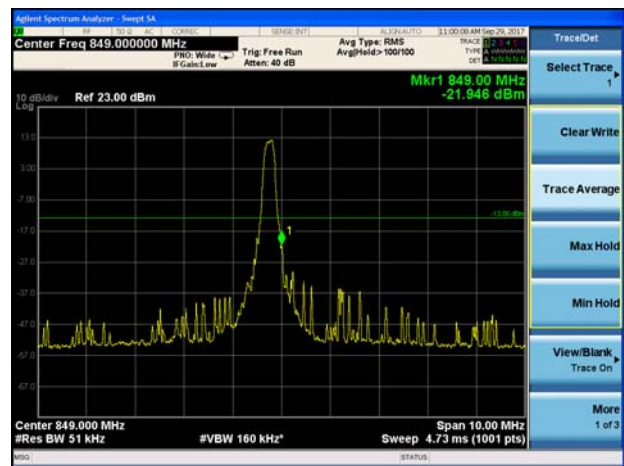

LTE Band 5 16QAM 1.4MHz CH-Low 100%RB

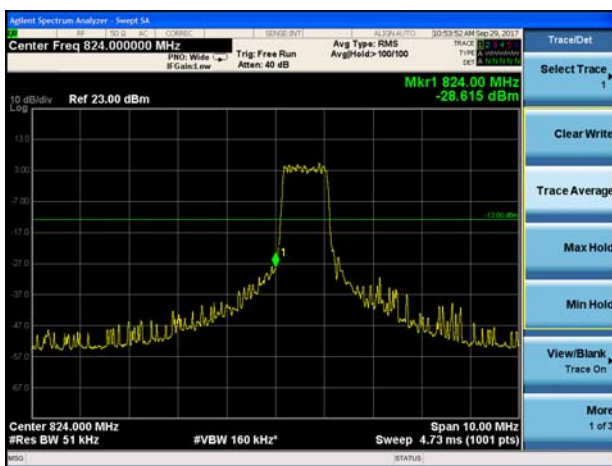

LTE Band 5 16QAM 1.4MHz CH-High 100%RB

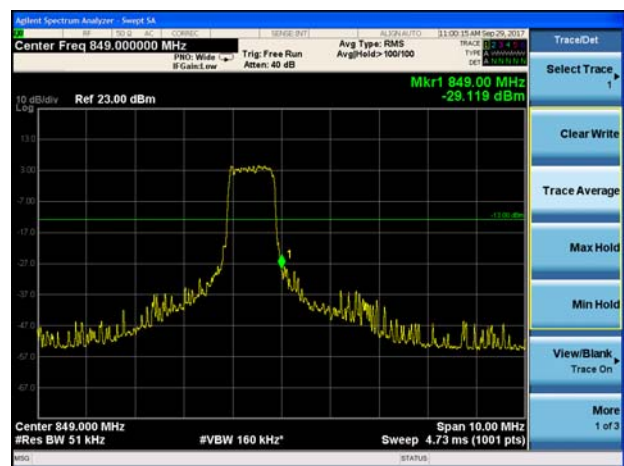



LTE Band 5 16QAM 3MHz CH-Low 1RB

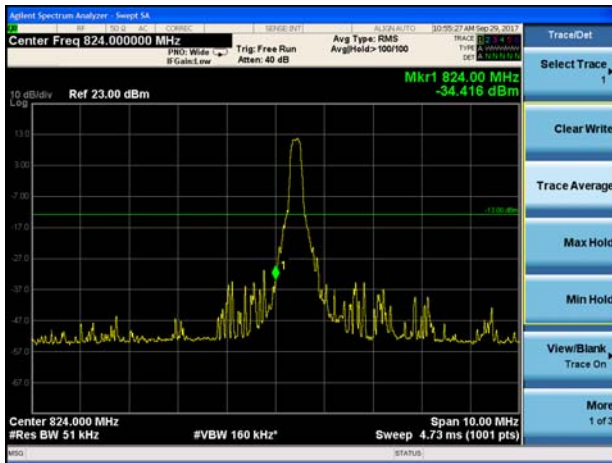

LTE Band 5 16QAM 3MHz CH-High 1RB

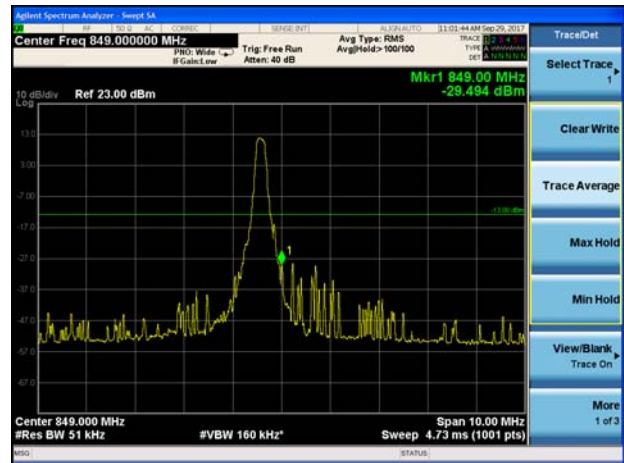

LTE Band 5 16QAM 3MHz CH-Low 100%RB

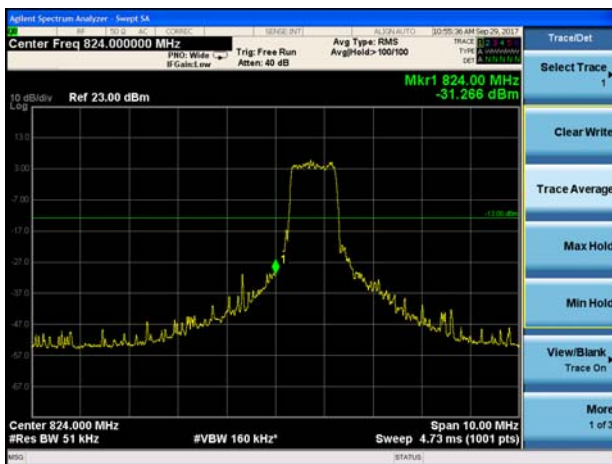

LTE Band 5 16QAM 3MHz CH-High 100%RB

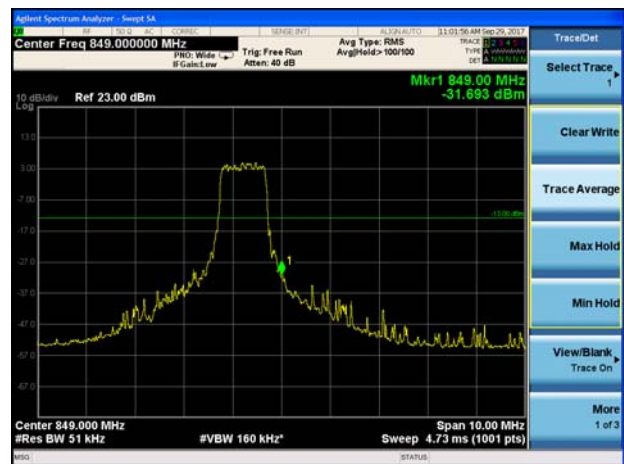

LTE Band 5 16QAM 5MHz CH-Low 1RB

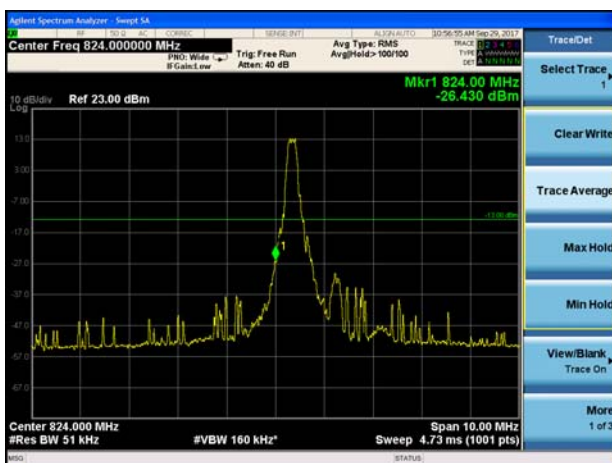

LTE Band 5 16QAM 5MHz CH-High 1RB

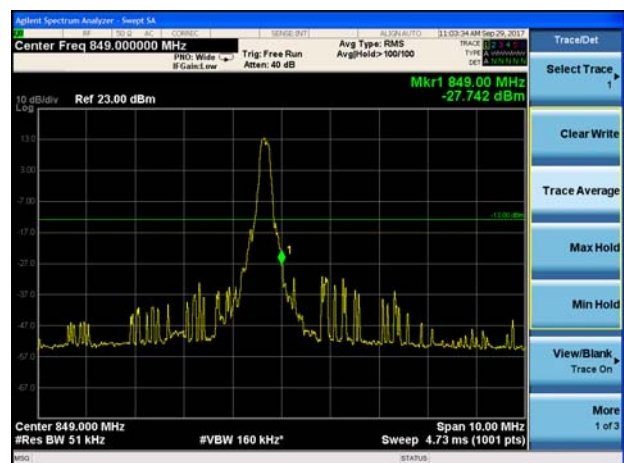



LTE Band 5 16QAM 5MHz CH-Low 100%RB

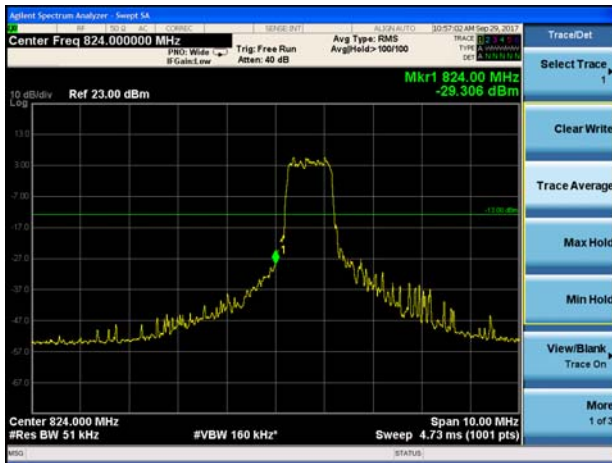

LTE Band 5 16QAM 5MHz CH-High 100%RB

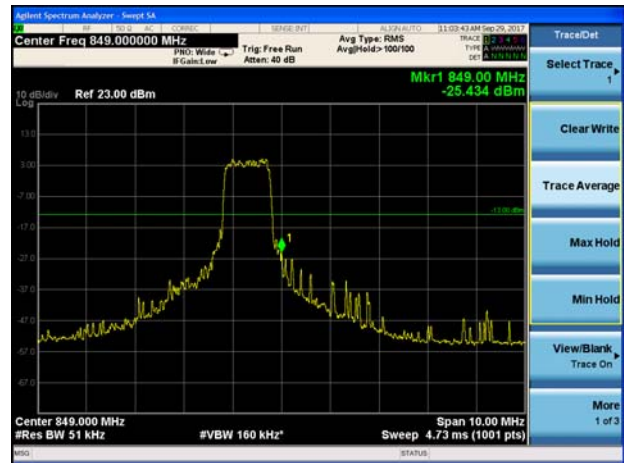

LTE Band 5 16QAM 10MHz CH-Low 1RB

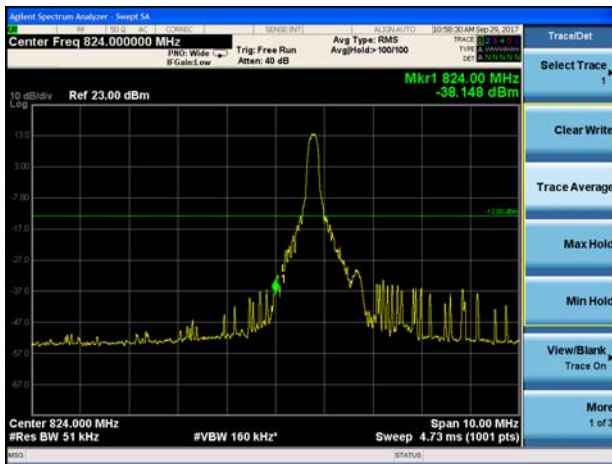

LTE Band 5 16QAM 10MHz CH-High 1RB

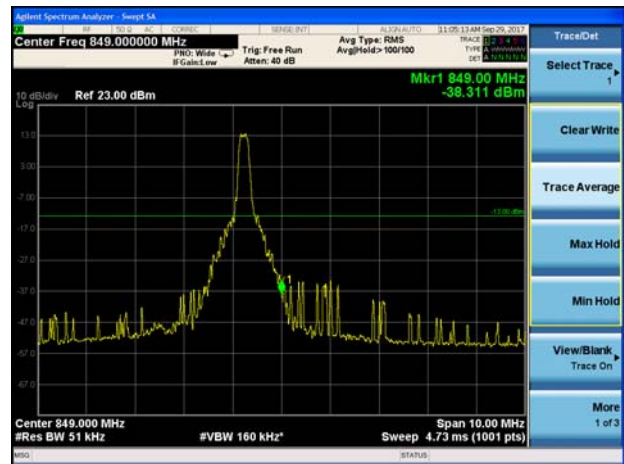

LTE Band 5 16QAM 10MHz CH-Low 100%RB

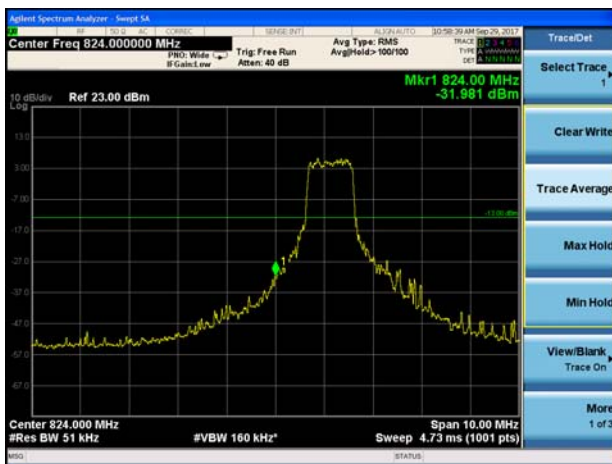

LTE Band 5 16QAM 10MHz CH-High 100%RB

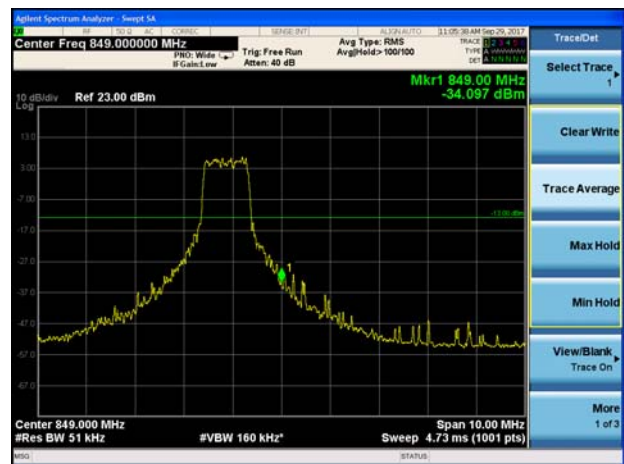

5.5. Peak-to-Average Power Ratio (PAPR)

Ambient condition

Temperature	Relative humidity	Pressure
23°C ~25°C	45%~50%	101.5kPa

Methods of Measurement

Measure the total peak power and record as P_{Pk} . And measure the total average power and record as P_{Avg} . Both the peak and average power levels must be expressed in the same logarithmic units (e.g., dBm). Determine the PAPR from:

$$PAPR (dB) = P_{Pk} (dBm) - P_{Avg} (dBm).$$

Test Setup

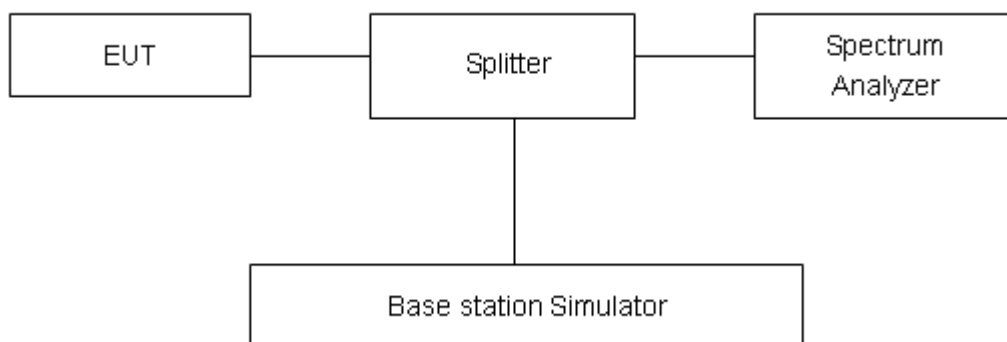

Limits

According to the Sec. 22.913(d), The peak-to-average ratio (PAR) of the transmission must not exceed 13 dB.

Measurement Uncertainty

The assessed measurement uncertainty to ensure 95% confidence level for the normal distribution is with the coverage factor $k = 2$, $U = 0.4$ dB.

Test Results

Mode	Channel	Frequency (MHz)	Peak (dBm)	Avg (dBm)	PAPR (dB)	Limit (dB)	Conclusion
GPRS 850 (GMSK)	128	824.2	30.69	30.01	0.68	≤13	PASS
	190	836.6	30.82	30.11	0.71	≤13	PASS
	251	848.8	30.92	30.28	0.64	≤13	PASS
EGPRS 850 (8-PSK)	128	824.2	26.84	26.05	0.79	≤13	PASS
	190	836.6	26.97	26.06	0.91	≤13	PASS
	251	848.8	27.00	26.19	0.81	≤13	PASS

Mode	Bandwidth	Modulation	Channel/ Frequency(MHz)	Peak-to-Average Power Ratio (PAPR)		
				Peak(dBm)	Avg(dBm)	PAPR(dB)
Band5	1.4MHz	QPSK	20525/836.5	32.98	22.71	10.27
		16QAM	20525/836.5	34.24	23.20	11.04
	3MHz	QPSK	20525/836.5	32.95	22.73	10.22
		16QAM	20525/836.5	34.24	23.25	10.99
	5MHz	QPSK	20525/836.5	33.21	22.69	10.52
		16QAM	20525/836.5	34.41	23.20	11.21
	10MHz	QPSK	20525/836.5	32.60	22.64	9.96
		16QAM	20525/836.5	33.28	23.16	10.12

5.6. Frequency Stability

Ambient condition

Temperature	Relative humidity	Pressure
23°C ~25°C	45%~50%	101.5kPa

Method of Measurement

1. Frequency Stability (Temperature Variation)

The temperature inside the climate chamber is varied from -40°C to +85°C in 10°C step size,

(1) With all power removed, the temperature was decreased to 0°C and permitted to stabilize for three hours.

(2) Measure the carrier frequency with the test equipment in a “call mode”. These measurements should be made within 1 minute of powering up the mobile station, to prevent significant self warming.

(3) Repeat the above measurements at 10°C increments from -40°C to +85°C. Allow at least 1.5 hours at each temperature, un-powered, before making measurements. Frequency Stability (Voltage Variation)

The frequency stability shall be measured with variation of primary supply voltage as follows:

(1) Vary primary supply voltage from 85 to 115 percent of the nominal value for other than hand carried battery equipment.

(2) For hand carried, battery powered equipment, reduce primary supply voltage to the battery-operating end point which shall be specified by the manufacturer.

This transceiver is specified to operate with an input voltage of between 3.3 V and 4.3 V, with a nominal voltage of 3.8V.

Test setup

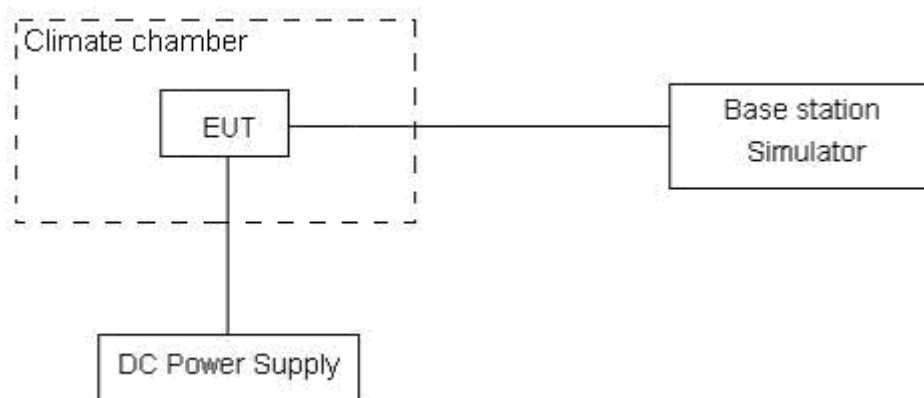

**Limits**

According to the Sec. 22.355, the frequency stability of the carrier shall be accurate to within 2.5 ppm of the received frequency for mobile stations.

Limits	≤ 2.5 ppm
--------	----------------

Measurement Uncertainty

The assessed measurement uncertainty to ensure 99.75% confidence level for the normal distribution is with the coverage factor $k = 3$, $U = 0.01$ ppm.



Test Result

Mode	Test status	Test Results (ppm)	
		GPRS(GMSK)	EGPRS(8PSK)
GSM 850 Middle Channel	-40°C/Normal Voltage	0.0211	0.0202
	-30°C/Normal Voltage	0.0294	0.0242
	-20°C/Normal Voltage	0.0297	0.0257
	-10°C/Normal Voltage	0.0292	0.0253
	0°C/Normal Voltage	0.0301	0.0250
	10°C/Normal Voltage	0.0333	0.0241
	20°C/Normal Voltage	0.0395	0.0317
	30°C/Normal Voltage	0.0312	0.0262
	40°C/Normal Voltage	0.0343	0.0248
	50°C/Normal Voltage	0.0355	0.0288
	60°C/Normal Voltage	0.0325	0.0302
	70°C/Normal Voltage	0.0349	0.0273
	80°C/Normal Voltage	0.0350	0.0266
	85°C/Normal Voltage	0.0338	0.0279
	20°C/Minimum Voltage	0.0273	0.0234
20°C/Maximum Voltage	0.0217	0.0208	

Bandwidth	Test status	LTE Band 5 Middle Channel Test Results (ppm)	
		QPSK	16QAM
1.4MHz	-40°C/Normal Voltage	-0.00147	-0.01488
	-30°C/Normal Voltage	-0.00025	-0.01676
	-20°C/Normal Voltage	-0.00142	-0.01840
	-10°C/Normal Voltage	-0.00279	-0.01732
	0°C/Normal Voltage	-0.00198	-0.02276
	10°C/Normal Voltage	-0.00053	-0.02736
	20°C/Normal Voltage	-0.00059	-0.01711
	30°C/Normal Voltage	0.00234	-0.01736
	40°C/Normal Voltage	0.00104	-0.02404
	50°C/Normal Voltage	0.00429	-0.01883
	60°C/Normal Voltage	0.00430	-0.02723
	70°C/Normal Voltage	-0.00128	-0.02343
	80°C/Normal Voltage	-0.00143	-0.01695
	85°C/Normal Voltage	0.00212	-0.01592
	20°C/Minimum Voltage	-0.00146	-0.01522
20°C/Maximum Voltage	0.00099	-0.02527	



3MHz	-40°C/Normal Voltage	-0.00178	-0.01886
	-30°C/Normal Voltage	-0.00259	-0.01704
	-20°C/Normal Voltage	-0.00334	-0.01677
	-10°C/Normal Voltage	-0.00158	-0.02166
	0°C/Normal Voltage	-0.00031	-0.01933
	10°C/Normal Voltage	-0.00438	-0.01900
	20°C/Normal Voltage	-0.00491	-0.01522
	30°C/Normal Voltage	-0.00392	-0.00512
	40°C/Normal Voltage	-0.00197	-0.00279
	50°C/Normal Voltage	-0.00160	0.00207
	60°C/Normal Voltage	-0.00361	0.00385
	70°C/Normal Voltage	-0.00209	-0.00123
	80°C/Normal Voltage	-0.00061	0.00393
	85°C/Normal Voltage	-0.00164	0.00286
	20°C/Minimum Voltage	-0.00197	0.00123
	20°C/Maximum Voltage	0.00099	0.00146
	5MHz	-40°C/Normal Voltage	-0.00219
-30°C/Normal Voltage		-0.00092	-0.01994
-20°C/Normal Voltage		-0.00499	-0.01961
-10°C/Normal Voltage		-0.00552	-0.01583
0°C/Normal Voltage		-0.00453	-0.00573
10°C/Normal Voltage		-0.00258	-0.00340
20°C/Normal Voltage		-0.00221	0.00146
30°C/Normal Voltage		-0.00422	0.00324
40°C/Normal Voltage		-0.00056	-0.01977
50°C/Normal Voltage		-0.00463	-0.01600
60°C/Normal Voltage		-0.00516	-0.00589
70°C/Normal Voltage		-0.00417	-0.00356
80°C/Normal Voltage		-0.00222	0.00129
85°C/Normal Voltage		-0.00185	0.00307
20°C/Minimum Voltage		-0.00386	-0.02244
20°C/Maximum Voltage		-0.00183	-0.02011
10MHz		-40°C/Normal Voltage	-0.00252
	-30°C/Normal Voltage	-0.00126	0.00426
	-20°C/Normal Voltage	-0.00532	-0.00082
	-10°C/Normal Voltage	-0.00586	0.01753
	0°C/Normal Voltage	-0.00487	0.00326
	10°C/Normal Voltage	-0.00292	0.00164
	20°C/Normal Voltage	-0.00255	0.00186
	30°C/Normal Voltage	-0.00455	-0.01739



	40°C/Normal Voltage	-0.00090	-0.01339
	50°C/Normal Voltage	-0.00496	-0.01176
	60°C/Normal Voltage	-0.00550	-0.01542
	70°C/Normal Voltage	-0.00243	-0.00532
	80°C/Normal Voltage	-0.00094	-0.00299
	85°C/Normal Voltage	-0.00197	0.00186
	20°C/Minimum Voltage	-0.00231	0.00365
	20°C/Maximum Voltage	0.00066	-0.01578

5.7. Spurious Emissions at Antenna Terminals

Ambient condition

Temperature	Relative humidity	Pressure
23°C ~25°C	45%~50%	101.5kPa

Method of Measurement

The EUT was connected to Spectrum Analyzer and Base Station Simulator via power Splitter. The measurement is carried out using a spectrum analyzer. The spectrum analyzer scans from 9kHz to the 10th harmonic of the carrier.

The peak detector is used. RBW are set to 100 kHz and VBW are set to 300 kHz for below 1G, RBW are set to 1MHz and VBW are set to 3MHz for above 1G, Sweep is set to ATUO.

Test setup

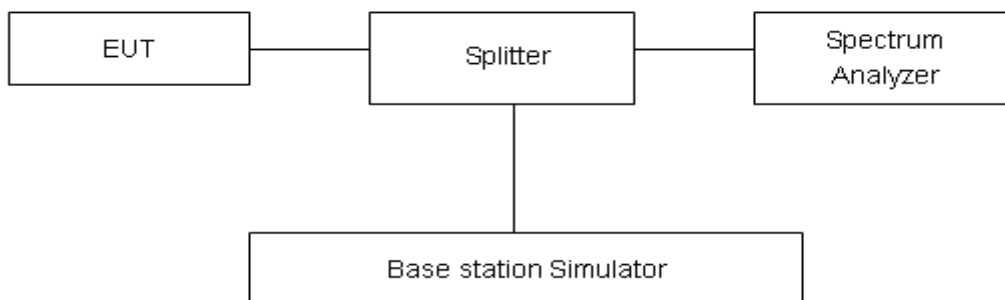

Limits

Rule Part 22.917(a) specifies that “The power of any emission outside of the authorized operating frequency ranges must be attenuated below the transmitting power (P) by a factor of at least 43 + 10 log (P) dB.”

Limit	-13 dBm
-------	---------

Measurement Uncertainty

The assessed measurement uncertainty to ensure 99.75% confidence level for the normal distribution is with the coverage factor $k = 1.96$.

Frequency	Uncertainty
100kHz-2GHz	0.684 dB
2GHz-12.75GHz	1.407 dB

Test Result

Sweep from 9 kHz to 30MHz, and the emissions more than 20 dB below the permissible value are not reported.

If disturbances were found more than 20dB below limit line, the mark is not required for the EUT. The signal beyond the limit is carrier.

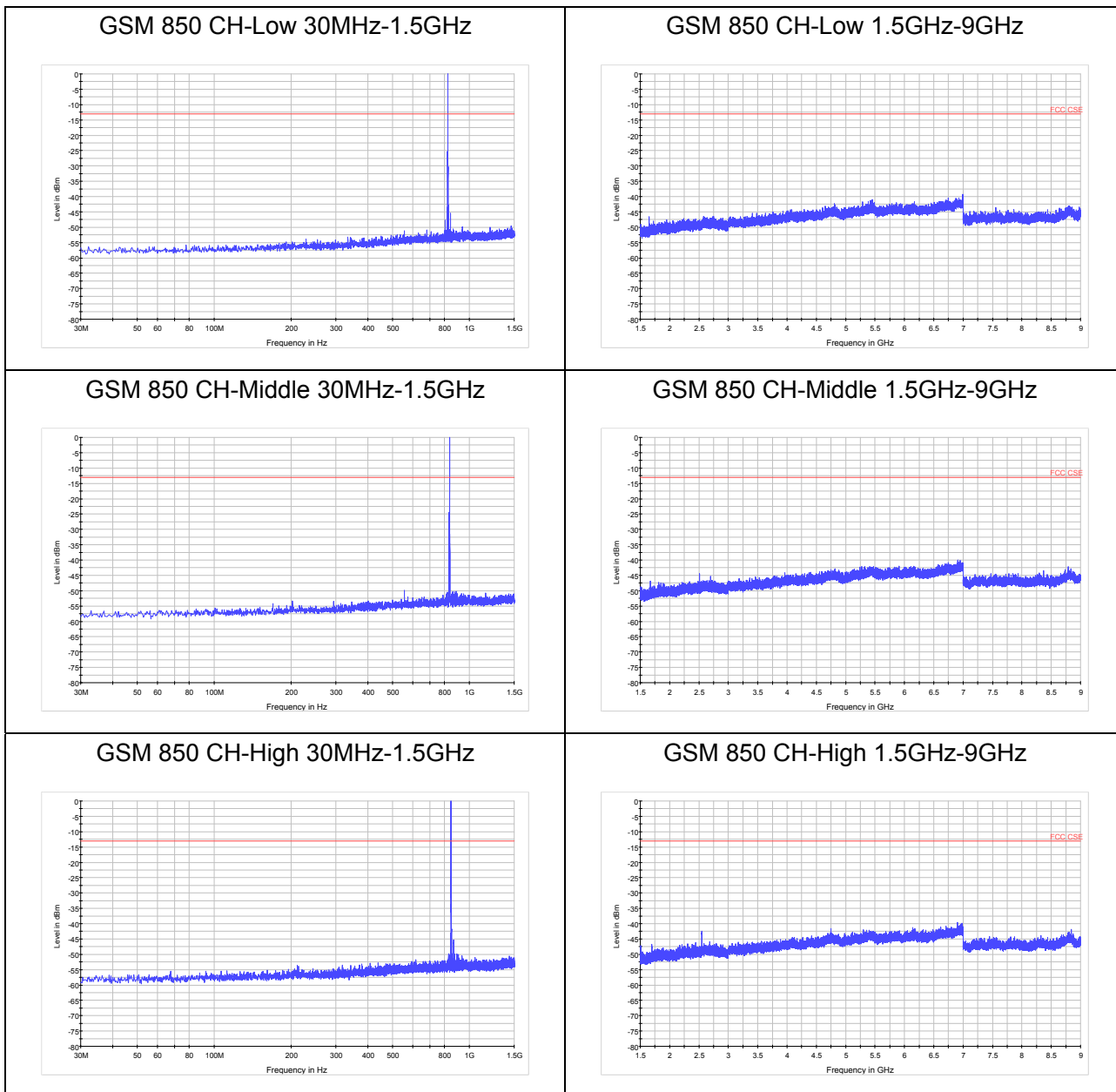



LTE Band 5 1.4MHz CH-Low 30MHz-1.5GHz

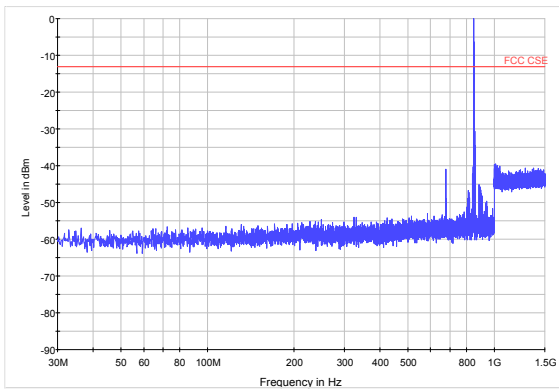

LTE Band 5 1.4MHz CH-Low 1.5GHz-9GHz

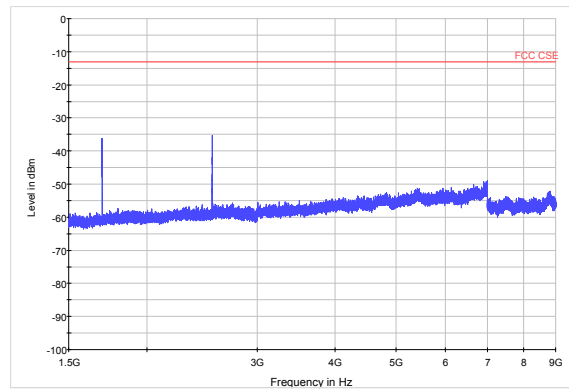

LTE Band 5 1.4MHz CH-Middle 30MHz-1.5GHz

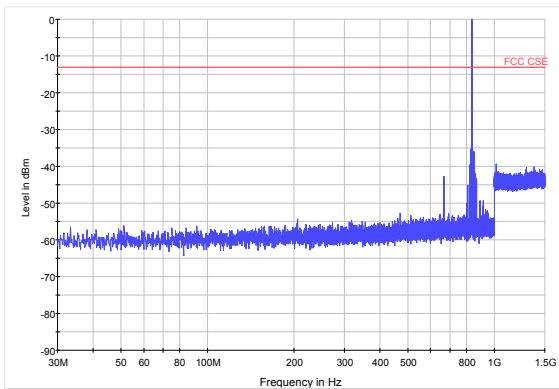

LTE Band 5 1.4MHz CH-Middle 1.5GHz-9GHz

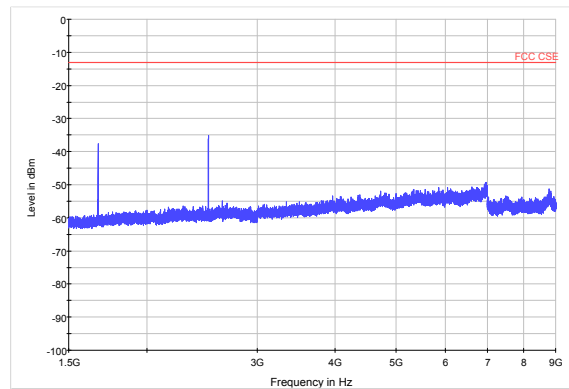

LTE Band 5 1.4MHz CH-High 30MHz-1.5GHz

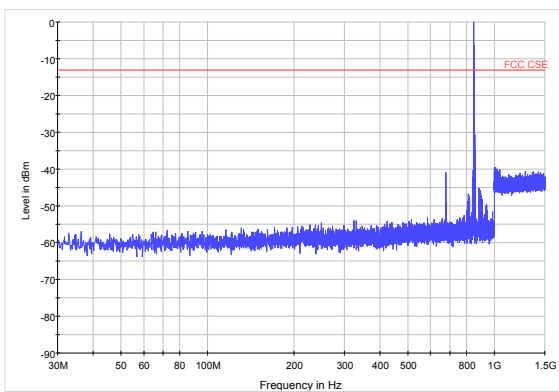

LTE Band 5 1.4MHz CH-High 1.5GHz-9GHz z

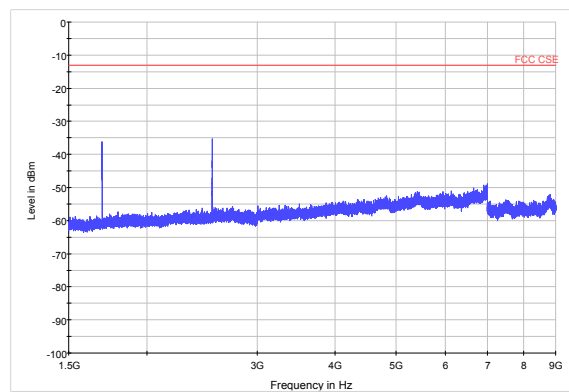



LTE Band 5 3MHz CH-Low 30MHz-1.5GHz

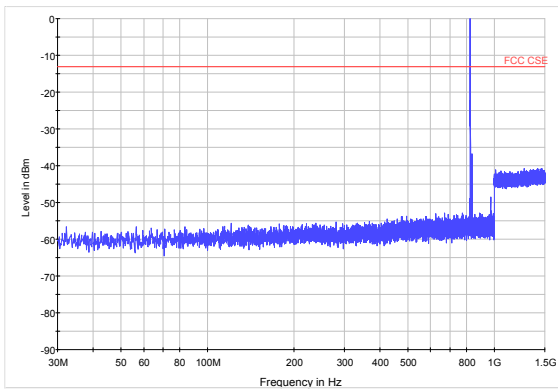

LTE Band 5 3MHz CH-Low 1.5GHz-9GHz z

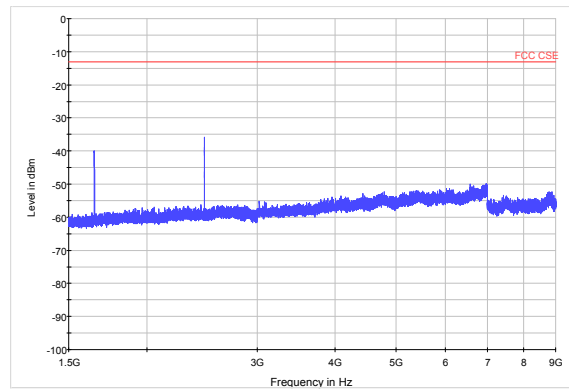

LTE Band 5 3MHz CH-Middle 30MHz-1.5GHz

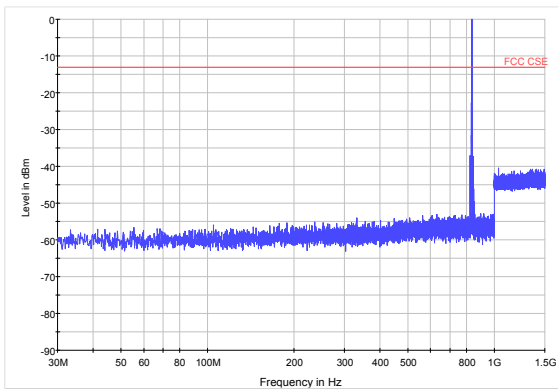

LTE Band 5 3MHz CH-Middle 1.5GHz-9GHz

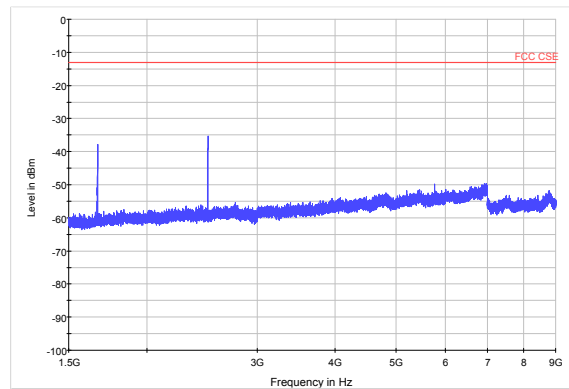

LTE Band 5 3MHz CH-High 30MHz-1.5GHz

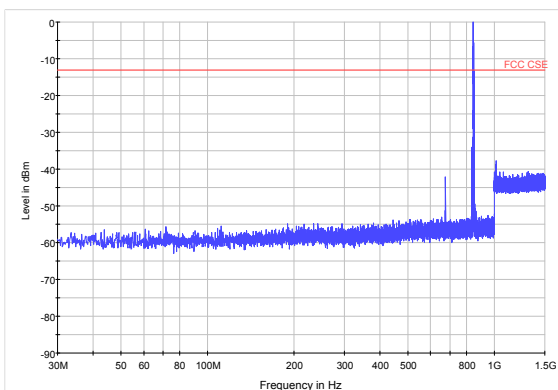

LTE Band 5 3MHz CH-High 1.5GHz-9GHz

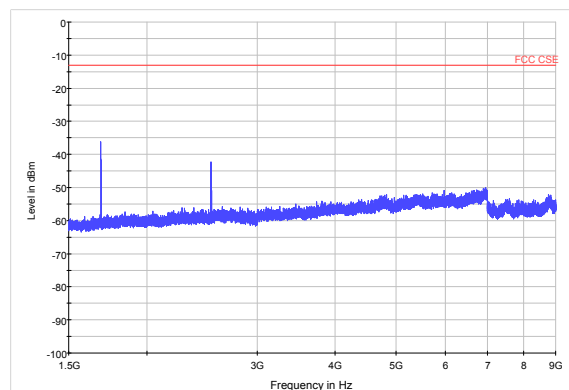



LTE Band 5 5MHz CH-Low 30MHz-1.5GHz

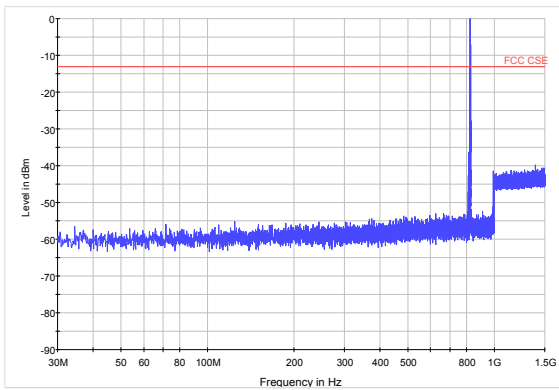

LTE Band 5 5MHz CH-Low 1.5GHz-9GHz

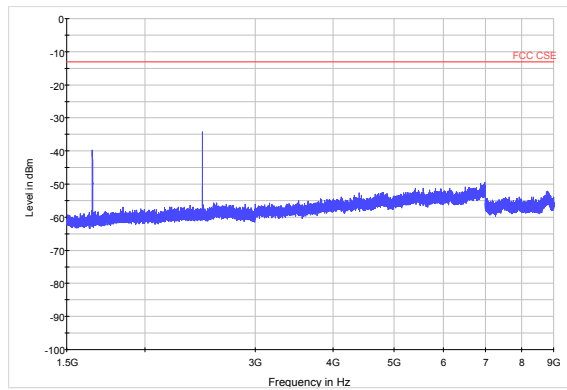

LTE Band 5 5MHz CH-Middle 30MHz-1.5GHz

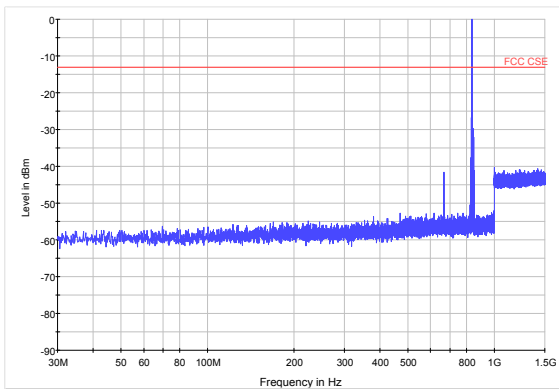

LTE Band 5 5MHz CH-Middle 1.5GHz-9GHz

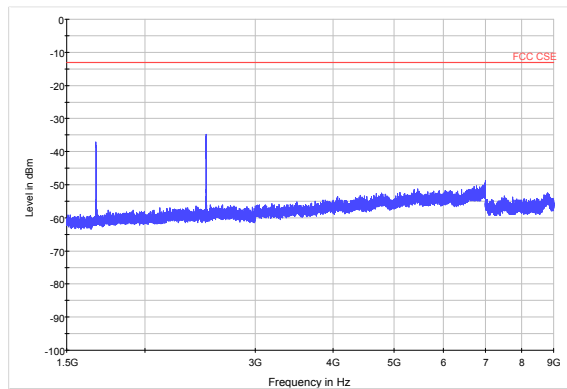

LTE Band 5 5MHz CH-High 30MHz-1.5GHz

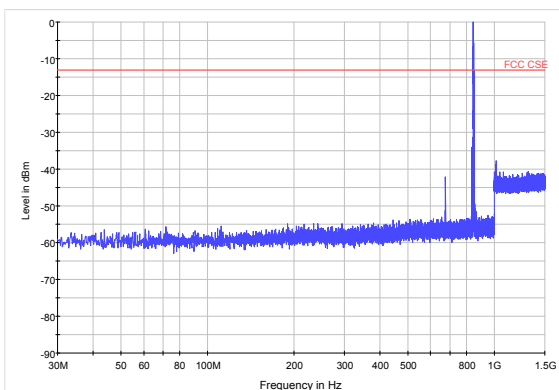

LTE Band 5 5MHz CH-High 1.5GHz-9GHz

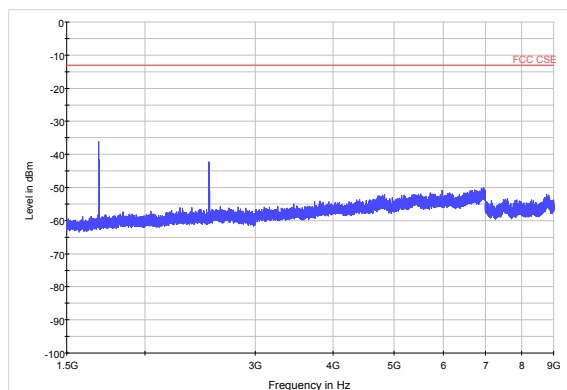



LTE Band 5 10MHz CH-Low 30MHz-1.5GHz

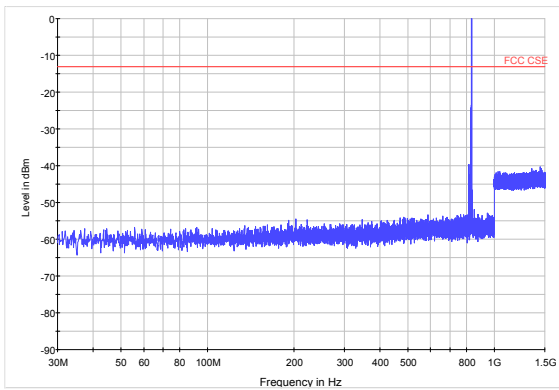

LTE Band 5 10MHz CH-Low 1.5GHz-9GHz

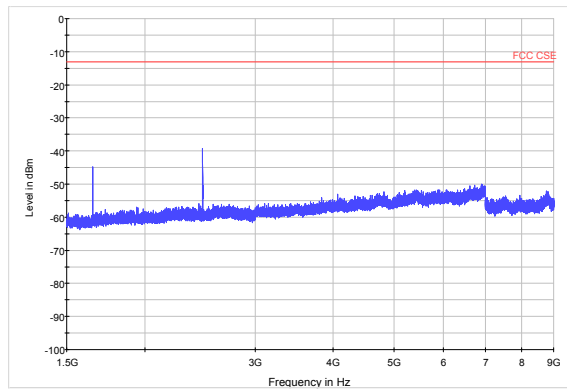

LTE Band 5 10MHz CH-Middle 30MHz-1.5GHz

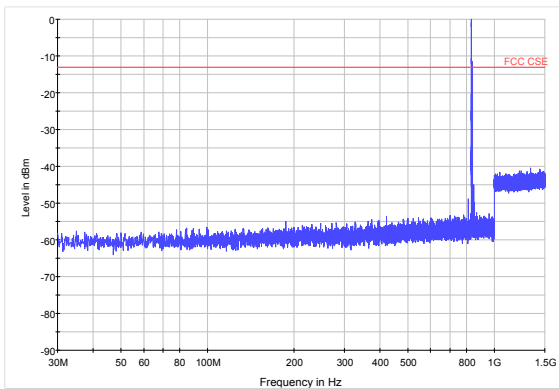

LTE Band 5 10MHz CH-Middle 1.5GHz-9GHz

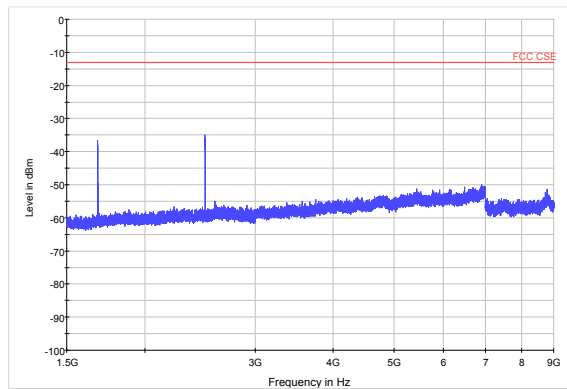

LTE Band 5 10MHz CH-High 30MHz-1.5GHz

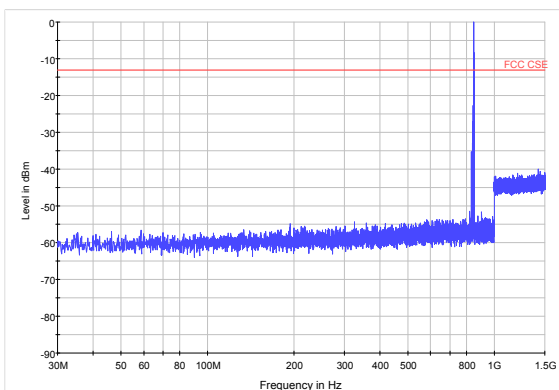

LTE Band 5 10MHz CH-High 1.5GHz-9GHz

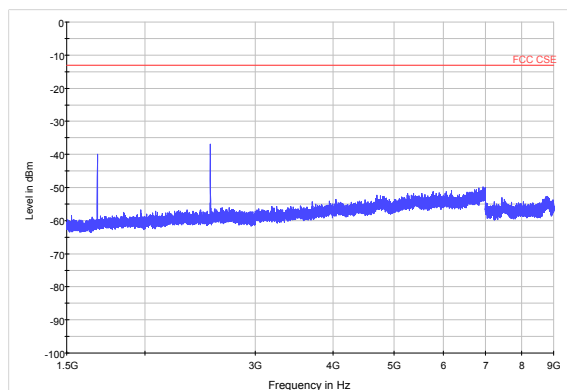

5.8. Radiates Spurious Emission

Ambient condition

Temperature	Relative humidity	Pressure
23°C ~25°C	45%~50%	101.5kPa

Method of Measurement

1. The testing follows FCC KDB 971168 v03r01 Section 5.8 and ANSI C63.26 (2015).
2. Below 1GHz: The EUT is placed on a turntable 0.8 meters above the ground in the chamber, 3 meter away from the antenna. The maximal emission value is acquired by adjusting the antenna height, polarisation and turntable azimuth. Normally, the height range of antenna is 1 m to 4 m, the azimuth range of turntable is 0° to 360°, and the receive antenna has two polarizations Vertical (V) and Horizontal (H). Above 1GHz: (Note: the FCC's permission to use 1.5m as an alternative per TCBC Conf call of Dec. 2, 2014.) The EUT is placed on a turntable 1.5 meters above the ground in the chamber, 3 meter away from the antenna. The maximal emission value is acquired by adjusting the antenna height, polarisation and turntable azimuth. Normally, the height range of antenna is 1 m to 4 m, the azimuth range of turntable is 0° to 360°, and the receive antenna has two polarizations Vertical (V) and Horizontal (H).
3. A loop antenna, A log-periodic antenna or horn antenna shall be substituted in place of the EUT. The log-periodic antenna will be driven by a signal generator and the level will be adjusted till the same power value on the spectrum analyzer or receiver. The level of the spurious emissions can be calculated through the level of the signal generator, cable loss, the gain of the substitution antenna and the reading of the spectrum analyzer or receiver.
4. The EUT is then put into continuously transmitting mode at its maximum power level during the test. Set Test Receiver or Spectrum RBW=200Hz,VBW=600Hz for 9kHz150kHz , RBW=10kHz, VBW=30kHz 150kHz-30MHz , RBW=100kHz,VBW=300kHz for 30MHz to 1GHz and RBW=1MHz, VBW=3MHz for above 1GHz, And the maximum value of the receiver should be recorded as (Pr).
5. The EUT shall be replaced by a substitution antenna. In the chamber, an substitution antenna for the frequency band of interest is placed at the reference point of the chamber. An RF Signal source for the frequency band of interest is connected to the substitution antenna with a cable that has been constructed to not interfere with the radiation pattern of the antenna. A power (PMea) is applied to the input of the substitution antenna, and adjust the level of the signal generator output until the value of the receiver reach the previously recorded (Pr). The power of signal source (PMea) is recorded. The test should be performed by rotating the test item and adjusting the receiving antenna polarization.
6. A amplifier should be connected to the Signal Source output port. And the cable should be connect between the Amplifier and the Substitution Antenna. The cable loss (Pcl) ,the Substitution Antenna Gain (Ga) and the Amplifier Gain (PAg) should be recorded after test.
7. The measurement results are obtained as described below:
Power(EIRP)=PMea- PAg - Pcl + Ga
The measurement results are amend as described below:
Power(EIRP)=PMea- Pcl + Ga
8. This value is EIRP since the measurement is calibrated using an antenna of known gain (2.15 dBi)

and known input power. ERP can be calculated from EIRP by subtracting the gain of the dipole, $ERP = EIRP - 2.15\text{dBi}$.

The modulation mode and RB allocation refer to section 5.1, using the maximum output power configuration.

Test setup

9KHz ~ 30MHz

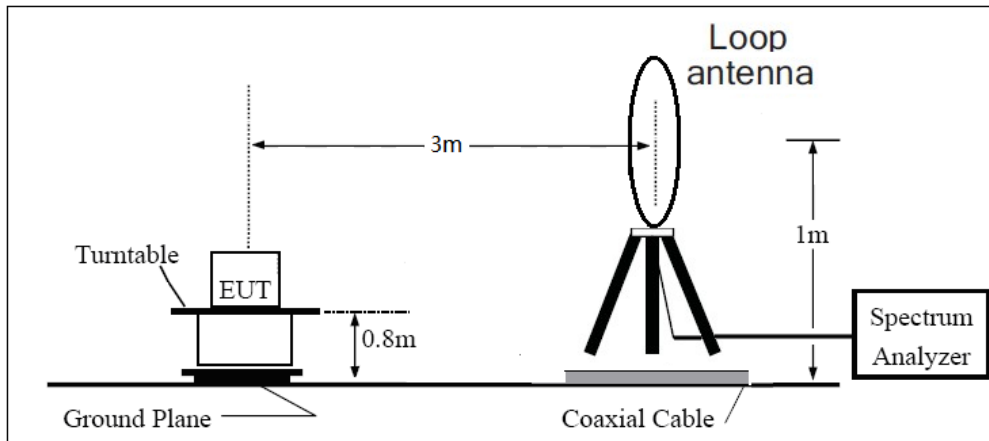

30MHz ~ 1GHz

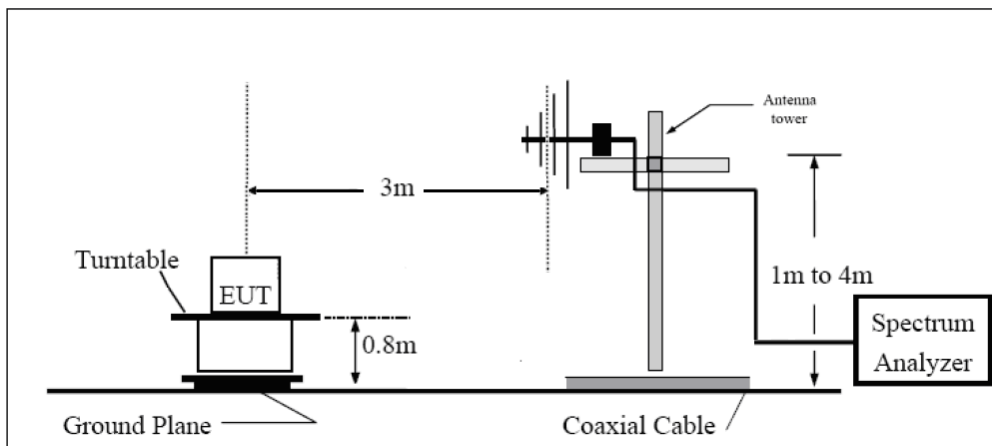

Above 1GHz

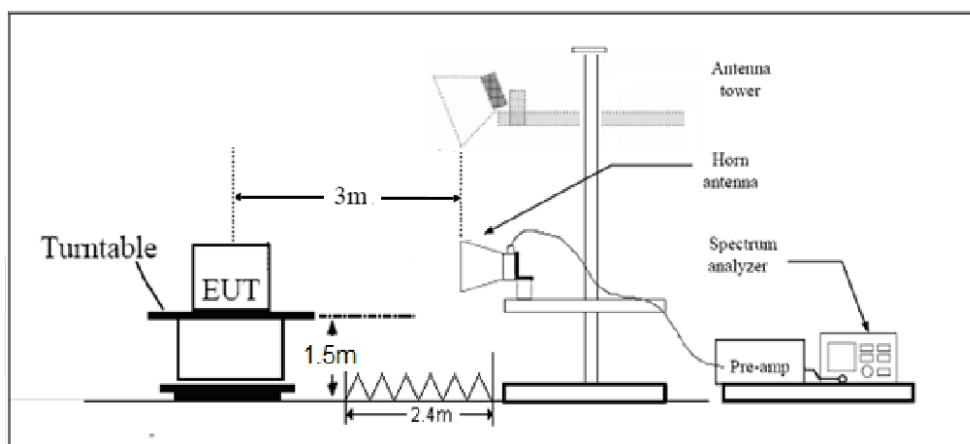

Note: Area side: 2.4mX3.6m

**Limits**

Rule Part 22.917(a) specifies that “The power of any emission outside of the authorized operating frequency ranges must be attenuated below the transmitting power (P) by a factor of at least $43 + 10 \log (P)$ dB.”

Limit	-13 dBm
-------	---------

Measurement Uncertainty

The assessed measurement uncertainty to ensure 95% confidence level for the normal distribution is with the coverage factor $k = 1.96$, $U = 3.55$ dB.

**Test Result**

GSM 850 CH-Low

Harmonic	Frequency (MHz)	SG (dBm)	Cable Loss (dB)	Gain (dBi)	Antenna Polarization	ERP Level (dBm)	Limit (dBm)	Margin (dB)	Azimuth (deg)
2	1648	-56.00	2	10.15	Vertical	-50.0	-13.0	37.0	45
3	2473	-56.69	2.51	11.35	Vertical	-50.0	-13.0	37.0	180
4	3297	-54.60	4.2	10.85	Vertical	-50.1	-13.0	37.1	180
5	4121	-53.30	5.2	11.35	Vertical	-49.3	-13.0	36.3	225
6	4945	-52.00	5.5	11.95	Vertical	-47.7	-13.0	34.7	135
7	5769	-52.30	5.7	13.55	Vertical	-46.6	-13.0	33.6	135
8	6594	-48.40	6.3	13.75	Vertical	-43.1	-13.0	30.1	45
9	7418	-46.30	6.8	13.85	Vertical	-41.4	-13.0	28.4	180
10	8242	-46.40	6.9	14.25	Vertical	-41.2	-13.0	28.2	270

Note: 1.The other Spurious RF Radiated emissions level is no more than noise floor.
2.The worst emission was found in the antenna is vertical position.

GSM 850 CH-Middle

Harmonic	Frequency (MHz)	SG (dBm)	Cable Loss (dB)	Gain (dBi)	Antenna Polarization	ERP Level (dBm)	Limit (dBm)	Margin (dB)	Azimuth (deg)
2	1673	-53.6	2	10.75	Vertical	-47.0	-13.0	34.0	225
3	2498	-55.49	2.51	11.05	Vertical	-49.1	-13.0	36.1	135
4	3346	-56.6	4.2	11.15	Vertical	-51.8	-13.0	38.8	135
5	4183	-53	5.2	11.15	Vertical	-49.2	-13.0	36.2	45
6	5020	-50.4	5.5	11.95	Vertical	-46.1	-13.0	33.1	270
7	5856	-51	5.7	13.55	Vertical	-45.3	-13.0	32.3	180
8	6693	-49.6	6.3	13.75	Vertical	-44.3	-13.0	31.3	270
9	7529	-46.9	6.8	13.85	Vertical	-42.0	-13.0	29.0	135
10	8366	-47	6.9	14.25	Vertical	-41.8	-13.0	28.8	45

Note: 1.The other Spurious RF Radiated emissions level is no more than noise floor.
2.The worst emission was found in the antenna is vertical position.



GSM 850 CH-High

Harmonic	Frequency (MHz)	SG (dBm)	Cable Loss (dB)	Gain (dBi)	Antenna Polarization	ERP Level (dBm)	Limit (dBm)	Margin (dB)	Azimuth (deg)
2	1698	-58.4	2	10.15	Vertical	-52.4	-13.0	39.4	90
3	2546	-57.49	2.51	11.05	Vertical	-51.1	-13.0	38.1	45
4	3395	-57.7	4.2	11.15	Vertical	-52.9	-13.0	39.9	180
5	4244	-53.7	5.2	11.15	Vertical	-49.9	-13.0	36.9	270
6	5093	-50.7	5.5	11.95	Vertical	-46.4	-13.0	33.4	135
7	5942	-51.6	5.7	13.55	Vertical	-45.9	-13.0	32.9	45
8	6790	-49.6	6.3	13.75	Vertical	-44.3	-13.0	31.3	270
9	7639	-46.9	6.8	13.85	Vertical	-42.0	-13.0	29.0	180
10	8488	-46.4	6.9	14.25	Vertical	-41.2	-13.0	28.2	270

Note: 1.The other Spurious RF Radiated emissions level is no more than noise floor.

2.The worst emission was found in the antenna is vertical position.

LTE Band 5 10MHz CH-Low

Harmonic	Frequency (MHz)	SG (dBm)	Cable Loss (dB)	Gain (dBi)	Antenna Polarization	ERP Level (dBm)	Limit (dBm)	Margin (dB)	Azimuth (deg)
2	1658.0	-51.4	2.00	10.75	vertical	-44.8	-13.0	31.8	135
3	2487.0	-50.89	2.51	11.05	vertical	-44.5	-13.0	31.5	225
4	3316.0	-53.7	4.20	11.15	vertical	-48.9	-13.0	35.9	90
5	4145.0	-52.7	5.20	11.15	vertical	-48.9	-13.0	35.9	45
6	4974.0	-51.9	5.50	11.95	vertical	-47.6	-13.0	34.6	180
7	5803.0	-50.2	5.70	13.55	vertical	-44.5	-13.0	31.5	45
8	6632.0	-48.9	6.30	13.75	vertical	-43.6	-13.0	30.6	0
9	7461.0	-47.3	6.80	13.85	vertical	-42.4	-13.0	29.4	135
10	8290.0	-47.8	6.90	14.25	vertical	-42.6	-13.0	29.6	45

Note: 1.The other Spurious RF Radiated emissions level is no more than noise floor.

2.The worst emission was found in the antenna is vertical position.



LTE Band 5 10MHz CH-Middle

Harmonic	Frequency (MHz)	SG (dBm)	Cable Loss (dB)	Gain (dBi)	Antenna Polarization	ERP Level (dBm)	Limit (dBm)	Margin (dB)	Azimuth (deg)
2	1673.0	-51.1	2.00	10.75	vertical	-44.5	-13.0	31.5	0
3	2509.5	-54.39	2.51	11.05	vertical	-48.0	-13.0	35.0	135
4	3346.0	-53.8	4.20	11.15	vertical	-49.0	-13.0	36.0	225
5	4182.5	-52.4	5.20	11.15	vertical	-48.6	-13.0	35.6	90
6	5019.0	-49.7	5.50	11.95	vertical	-45.4	-13.0	32.4	45
7	5855.5	-51.3	5.70	13.55	vertical	-45.6	-13.0	32.6	180
8	6692.0	-48.5	6.30	13.75	vertical	-43.2	-13.0	30.2	45
9	7528.5	-46.4	6.80	13.85	vertical	-41.5	-13.0	28.5	0
10	8365.0	-48	6.90	14.25	vertical	-42.8	-13.0	29.8	45

Note: 1.The other Spurious RF Radiated emissions level is no more than noise floor.

2.The worst emission was found in the antenna is vertical position.



LTE Band 5 10MHz CH-High

Harmonic	Frequency (MHz)	SG (dBm)	Cable Loss (dB)	Gain (dBi)	Antenna Polarization	ERP Level (dBm)	Limit (dBm)	Margin (dB)	Azimuth (deg)
2	1688.0	-47.7	2.00	10.75	vertical	-41.1	-13.0	28.1	0
3	2532.0	-52.79	2.51	11.05	vertical	-46.4	-13.0	33.4	135
4	3376.0	-52.4	4.20	11.15	vertical	-47.6	-13.0	34.6	225
5	4220.0	-52.1	5.20	11.15	vertical	-48.3	-13.0	35.3	90
6	5064.0	-49.9	5.50	11.95	vertical	-45.6	-13.0	32.6	45
7	5908.0	-51.5	5.70	13.55	vertical	-45.8	-13.0	32.8	180
8	6752.0	-49.2	6.30	13.75	vertical	-43.9	-13.0	30.9	45
9	7596.0	-46.9	6.80	13.85	vertical	-42.0	-13.0	29.0	0
10	8440.0	-48.2	6.90	14.25	vertical	-43.0	-13.0	30.0	135

Note: 1.The other Spurious RF Radiated emissions level is no more than noise floor.

2.The worst emission was found in the antenna is vertical position.

6. Main Test Instruments

Name	Manufacturer	Type	Serial Number	Calibration Date	Expiration Time
Base Station Simulator	R&S	CMW500	150415	2017-05-14	2018-05-13
Power Splitter	Hua Xiang	SHX-GF2-2-13	10120101	2017-05-14	2018-05-13
Spectrum Analyzer	Agilent	N9010A	MY47191109	2017-05-20	2018-05-19
Universal Radio Communication Tester	Agilent	E5515C	MY48367192	2017-05-20	2018-05-19
Signal Analyzer	R&S	FSV30	100815	2016-12-16	2017-12-15
EMI Test Receiver	R&S	ESCI	100948	2017-05-20	2018-05-19
Signal generator	R&S	SMB 100A	102594	2017-05-14	2018-05-13
Signal generator	R&S	SMR27	100365	2017-05-14	2018-05-13
Trilog Antenna	SCHWARZBECK	VUBL 9163	9163-201	2014-12-06	2017-12-05
Horn Antenna	R&S	HF907	100126	2014-12-06	2017-12-05
Horn Antenna	ETS-Lindgren	3160-09	00102644	2015-01-30	2018-01-29
Climatic Chamber	Re Ce	PT-30B	20101891	2015-07-18	2018-07-17
RF Cable	Agilent	SMA 15cm	0001	2017-02-06	2017-08-05
Preamplifier	R&S	SCU18	102327	2017-06-18	2018-06-17

*****END OF REPORT *****

ANNEX A: EUT Appearance and Test Setup

A.1 EUT Appearance



shielding



No shielding
Front Side

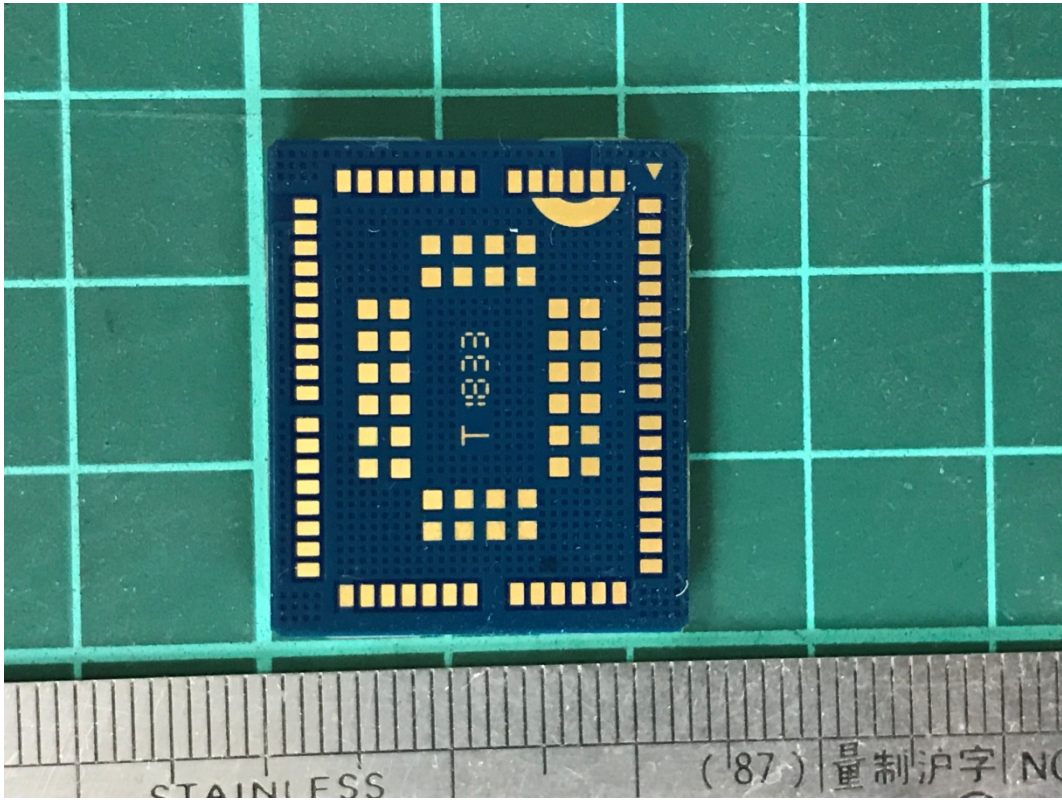

Back Side
a: EUT
Picture 1 EUT

A.2 Test Setup

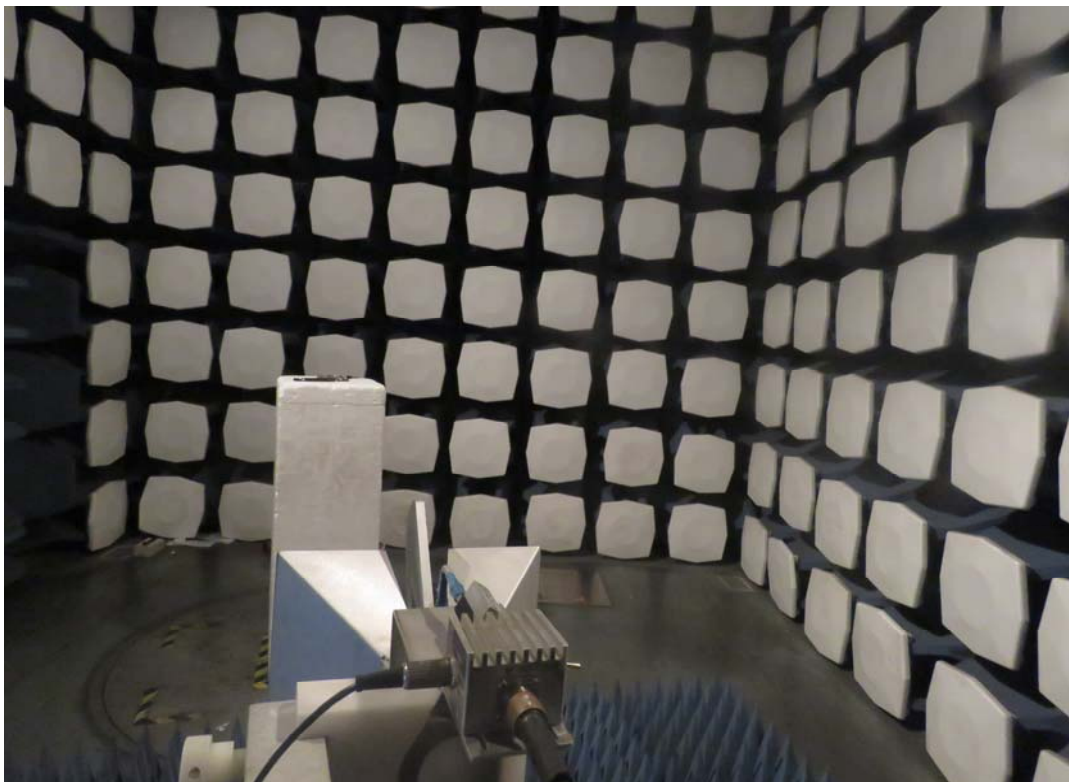
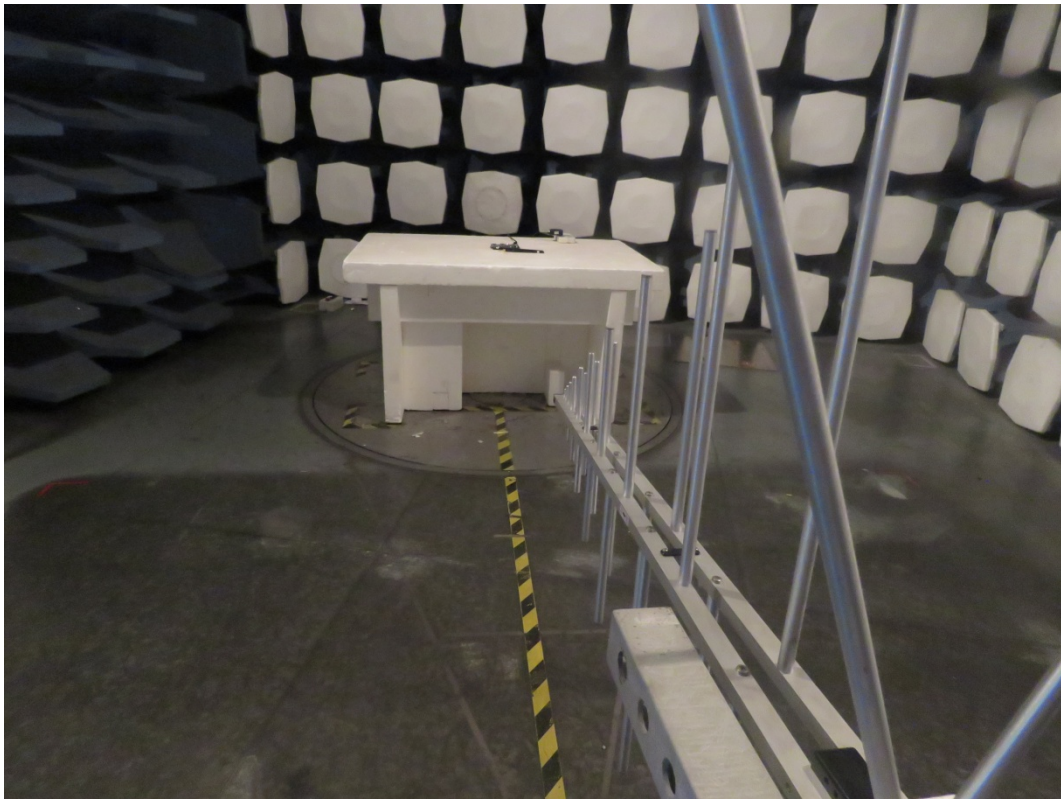

Picture 2: Radiated Spurious Emissions Test setup

ANNEX B: Product Change Description



BG96 R1.1 & BG96 R1.2 Differences Statement

LTE Module Series

PCB Rev.: R1.2

Date: 2018-10-08



www.quectel.com

Build a Smarter World



Based on BG96 R1.1, BG96 R1.2 has enabled VDD_QFPROM_PRG hardware interface, which is connected to ground directly in BG96 R1.1, so as to support secure boot feature.

Some points are highlighted as below:

- BG96 R1.1 and R1.2 versions share the same hardware architecture and key components.
- BG96 R1.1 and R1.2 versions share the same pinout placements.
- Secure boot is enabled through a set of hardware fuses in BG96 R1.2. For the code to be executed, it must be signed by the trusted entity identified in the hardware fuses, so we have to enable VDD_QFPROM_PRG hardware interface.
- The new hardware will be used with the new software baseline TX3.0, and the software version is R04Axx.

The details are illustrated as below:

1. What's Secure Boot

Secure boot refers to the bootup sequence that establishes a trusted platform for secure applications. It starts as an immutable sequence that validates the origin of the code using cryptographic authentication so only authorized software can be executed. The bootup sequence places the device in a known security state and protects against binary manipulation of software and reflashing attacks.

A secure boot system adds cryptographic checks to each stage of the boot up process. This process asserts the authenticity of all secure software images that are executed by the device. This additional check prevents any unauthorized or maliciously modified software from running on the device. Secure boot is enabled through a set of hardware fuses. For the code to be executed, it must be signed by the trusted entity identified in the hardware fuses.

In simple terms, secure boot ensures running of signed/authorized software on the module, and unsigned/unauthorized software will not be allowed to run.

2. Enabled VDD_QFPROM_PRG Hardware Interface

A. BG96 R1.1 does not support secure boot function

The VDD_QFPROM_PRG (N19) pin of baseband chip is for secure boot function. In BG96 R1.1, this pin is connected to ground directly, which means secure boot function is disabled.

B. BG96 R1.2 supports secure boot function

According to Qualcomm's suggestion and our customers' requirements, the VDD_QFPROM_PRG pin is connected to VREG_L3_1P8(1.8V) in BG96 R1.2 so as to enable secure boot function.

The following pictures show the schematic and PCB designs of BG96 R1.1 and R1.2.

Build a Smarter World



Figure 1: Schematic Designs of BG96 R1.1 and R1.2

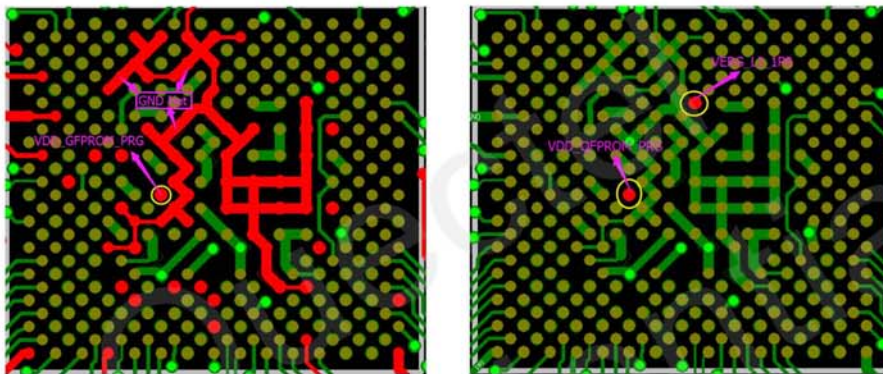

Figure 2: PCB Designs of BG96 R1.1 and R1.2

3. TX2.0 vs TX3.0

The biggest difference of TX3.0 as compared with TX2.0 lies in the adding of VoLTE and handover features. Since VoLTE environment has not been built so maturely yet, the main concern of customers is the handover function.

For TX2.0, re-selection is supported, while handover is not supported.

BG96 supports re-selection mechanism, which means when disconnection happens during cell handover, the module will reconnect automatically. This process lasts for about 1 (or 2) seconds, and the data transmitted (may happen by coincidence) will be buffered and resent once the reconnection established. So, the disconnection is generally imperceptible to customers.

- If the data transmission occurs at the moment that cell handover occurs coincidentally, the connection is kept with handover function; the connection is broken and re-connection established in about 1 (or 2) seconds with re-selection. This causes nearly no difference for data telematics because users even cannot feel this disconnection, whereas VoLTE might be affected because of the short time disconnection.



Build a Smarter World



- If the data transmission occurs in the period that no cell alternates, then no any influence will be caused.

Quectel
Confidential