



# RF TEST REPORT

<b>Applicant</b>	Quectel Wireless Solutions Co., Ltd.
<b>FCC ID</b>	XMR201707BG96
<b>Product</b>	Quectel BG96
<b>Brand</b>	Quectel
<b>Model</b>	BG96
<b>Report No.</b>	RXA1706-0199RF06
<b>Issue Date</b>	August 29, 2017

TA Technology (Shanghai) Co., Ltd. tested the above equipment in accordance with the requirements in **FCC CFR47 Part 2 (2017)/ FCC CFR 47 Part 24E (2017)**. The test results show that the equipment tested is capable of demonstrating compliance with the requirements as documented in this report.

*Jiang peng Lan*

*Performed by: Jiangpeng Lan*

*Kai Xu*

*Approved by: Kai Xu*

---

**TA Technology (Shanghai) Co., Ltd.**

*No.145, Jintang Rd, Tangzhen Industry Park, Pudong Shanghai, China*

*TEL: +86-021-50791141/2/3*

*FAX: +86-021-50791141/2/3-8000*



## TABLE OF CONTENT

1. Test Laboratory .....	4
1.1. Notes of the test report.....	4
1.2. Test facility.....	4
1.3. Testing Location .....	5
2. General Description of Equipment under Test.....	6
3. Applied Standards.....	7
4. Test Configuration.....	8
5. Test Case Results.....	9
5.1. RF Power Output.....	9
5.2. Effective Isotropic Radiated Power .....	11
5.3. Occupied Bandwidth .....	14
5.4. Band Edge Compliance.....	19
5.5. Peak-to-Average Power Ratio (PAPR) .....	22
5.6. Frequency Stability.....	24
5.7. Spurious Emissions at Antenna Terminals .....	27
5.8. Radiates Spurious Emission .....	30
6. Main Test Instruments .....	34
ANNEX A: EUT Appearance and Test Setup.....	35
A.1 EUT Appearance .....	35
A.2 Test Setup.....	37

## Summary of measurement results

No.	Test Case	Clause in FCC rules	Verdict
1	RF power output	2.1046	PASS
2	Effective Isotropic Radiated power	24.232(c)	PASS
3	Occupied Bandwidth	2.1049	PASS
4	Band Edge Compliance	2.1051 /24.238(a)	PASS
5	Peak-to-Average Power Ratio	24.232/KDB 971168 D01(5.7)	PASS
6	Frequency Stability	2.1055 / 24.235	PASS
7	Spurious Emissions at Antenna Terminals	2.1051 / 24.238(a)	PASS
8	Radiates Spurious Emission	2.1053 / 24.238(a)	PASS
Date of Testing: August 4, 2017 ~ August 18, 2017			
Note: PASS: The EUT complies with the essential requirements in the standard. FAIL: The EUT does not comply with the essential requirements in the standard.			



## 1. Test Laboratory

### 1.1. Notes of the test report

This report shall not be reproduced in full or partial, without the written approval of **TA technology (shanghai) co., Ltd.** The results documented in this report apply only to the tested sample, under the conditions and modes of operation as described herein. Measurement Uncertainties were not taken into account and are published for informational purposes only. This report is written to support regulatory compliance of the applicable standards stated above. This report must not be used by the client to claim product certification, approval, or endorsement by any government agencies.

### 1.2. Test facility

#### **CNAS (accreditation number: L2264)**

TA Technology (Shanghai) Co., Ltd. has obtained the accreditation of China National Accreditation Service for Conformity Assessment (CNAS).

#### **FCC (Designation number: CN1179, Test Firm Registration Number: 446626)**

TA Technology (Shanghai) Co., Ltd. has been listed on the US Federal Communications Commission list of test facilities recognized to perform electromagnetic emissions measurements.

#### **IC (recognition number is 8510A)**

TA Technology (Shanghai) Co., Ltd. has been listed by industry Canada to perform electromagnetic emission measurement.

#### **VCCI (recognition number is C-4595, T-2154, R-4113, G-10766)**

TA Technology (Shanghai) Co., Ltd. has been listed by industry Japan to perform electromagnetic emission measurement.

#### **A2LA (Certificate Number: 3857.01)**

TA Technology (Shanghai) Co., Ltd. has been listed by American Association for Laboratory Accreditation to perform electromagnetic emission measurement.



### 1.3. Testing Location

Company: TA Technology (Shanghai) Co., Ltd.  
Address: No.145, Jintang Rd, Tangzhen Industry Park, Pudong  
City: Shanghai  
Post code: 201201  
Country: P. R. China  
Contact: Xu Kai  
Telephone: +86-021-50791141/2/3  
Fax: +86-021-50791141/2/3-8000  
Website: <http://www.ta-shanghai.com>  
E-mail: [xukai@ta-shanghai.com](mailto:xukai@ta-shanghai.com)

## 2. General Description of Equipment under Test

### Client Information

Applicant	Quectel Wireless Solutions Co., Ltd.
Applicant address	7th Floor, Hongye Building, No. 1801 Hongmei Road, Xuhui District, Shanghai, China
Manufacturer	Quectel Wireless Solutions Co., Ltd.
Manufacturer address	7th Floor, Hongye Building, No. 1801 Hongmei Road, Xuhui District, Shanghai, China

### General information

EUT Description			
Model	BG96		
IMEI	864508030012063		
Hardware Version	R1.0		
Software Version	BG96MAR02A02M1G		
Power Supply	External power supply		
Antenna Type	The EUT don't have standard Antenna, The Antenna used for testing in this report is the after-market accessory (Dipole Antenna)		
Test Mode(s)	NB-IOT Band 2;		
Test Modulation	BPSK, QPSK		
NB-IOT Category	NB1		
Maximum E.I.R.P	NB-IOT Band 2:	27.88 dBm	
Rated Power Supply Voltage	3.8V		
Extreme Voltage	Minimum: 3.3V    Maximum: 4.3V		
Extreme Temperature	Lowest: -40°C    Highest: +85°C		
Operating Frequency Range(s)	Band	Tx (MHz)	Rx (MHz)
	NB-IOT Band 2	1850 ~ 1910	1930 ~ 1990
Note: The information of the EUT is declared by the manufacturer.			

Accessory equipment	
Evaluation Board	RF Cable
RS232-to-USB Cable	Antenna: Dipole Antenna
Headset	USB Cable



### **3. Applied Standards**

According to the specifications of the manufacturer, it must comply with the requirements of the following standards:

**FCC CFR47 Part 2 (2017)**

**FCC CFR 47 Part 24E (2017)**

**ANSI/TIA-603-D (2010)**

**KDB 971168 D01 Power Meas License Digital Systems v02r02**

## 4. Test Configuration

Radiated measurements are performed by rotating the EUT in three different orthogonal test planes. EUT stand-up position (X, Y axis), lie down position (Z axis). Receiver antenna polarization (horizontal and vertical), the worst emission was found in position (Z axis, vertical polarization) and the worst case was recorded.

All mode and data rates and positions and RB size and modulations were investigated.

Subsequently, only the worst case emissions are reported.

The following testing in NB-IOT is set based on the maximum RF Output Power.

Test modes are chosen to be reported as the worst case configuration below for NB-IOT Band 2

Test items	Deployment mode	Subcarrier Spacing (kHz)		Modulation		Test Channel		
	Stand-alone	3	15	BPSK	QPSK	L	M	H
RF power output	O	O	O	O	O	O	O	O
Effective Isotropic Radiated power	O	O	O	O	O	O	O	O
Occupied Bandwidth	O	O	O	O	O	O	O	O
Band Edge Compliance	O	O	O	O	O	O	-	O
Peak-to-Average Power Ratio	O	O	O	O	O	-	O	-
Frequency Stability	O	O	O	O	O	-	O	-
Conducted Spurious Emissions	O	-	O	-	O	O	O	O
Radiates Spurious Emission	O	-	O	-	O	O	O	O
Note 1. The mark "O" means that this configuration is chosen for testing. 2. The mark "-" means that this configuration is not testing.								



## 5. Test Case Results

### 5.1. RF Power Output

#### Ambient condition

Temperature	Relative humidity	Pressure
23°C ~25°C	45%~50%	101.5kPa

#### Methods of Measurement

During the process of the testing, The EUT is controlled by the Base Station Simulator to ensure max power transmission and proper modulation.

#### Test Setup

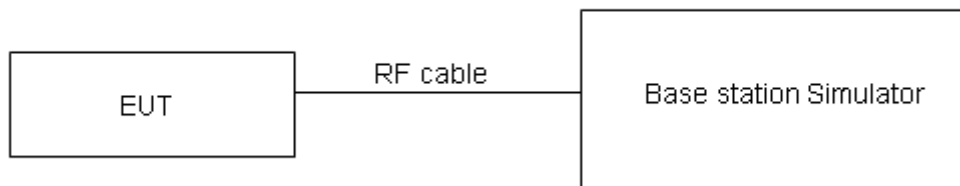

The loss between RF output port of the EUT and the input port of the tester has been taken into consideration.

#### Limits

No specific RF power output requirements in part 2.1046.

#### Measurement Uncertainty

The assessed measurement uncertainty to ensure 95% confidence level for the normal distribution is with the coverage factor  $k = 2$ ,  $U = 0.4$  dB.

**Test Results**

NB-IOT Band 2				Conducted Power(dBm)		
Deployment mode	Sub-carrier spacing (kHz)	Modulation	Ntones	Channel/Frequency(MHz)		
				18601/1850.1	18900/1880	19199/1909.9
Stand-alone	3.75	BPSK	1@0	22.11	22.34	22.07
		BPSK	1@47	22.09	22.33	22.08
	15	BPSK	1@0	22.49	22.40	22.86
		BPSK	1@11	22.83	22.69	22.97
	3.75	QPSK	1@0	22.17	22.45	22.49
		QPSK	1@47	22.15	22.39	22.64
	15	QPSK	1@0	22.58	22.42	22.92
		QPSK	1@11	22.84	22.72	22.96
		QPSK	12@0	22.75	22.55	22.98

## 5.2. Effective Isotropic Radiated Power

### Ambient condition

Temperature	Relative humidity	Pressure
23°C ~25°C	45%~50%	101.5kPa

### Methods of Measurement

- The testing follows FCC KDB 971168 v02r02 Section 5.8 and ANSI / TIA-603-D-2010 Section 2.2.12.
- EUT was placed on a 0.8 meter high non-conductive stand at a 3 meter test distance from the receive antenna. A receiving antenna was placed on the antenna mast 3 meters from the EUT for emission measurements. The height of receiving antenna between 1.0m and 4.0m. Detected emissions were maximized at each frequency by rotating the EUT through 360° and adjusting the receiving antenna polarization. The radiated emission measurements of all transmit frequencies in three channels (High, Middle, Low) were measured with peak detector.
- A log-periodic antenna or double-ridged waveguide horn antenna shall be substituted in place of the EUT. The log-periodic antenna will be driven by a signal generator and the level will be adjusted till the same power value on the spectrum analyzer or receiver. The level of the spurious emissions can be calculated through the level of the signal generator, cable loss, the gain of the substitution antenna and the reading of the spectrum analyzer or receiver.
- The EUT is then put into continuously transmitting mode at its maximum power level during the test. Set Test Receiver or Spectrum RBW=1MHz, VBW=3MHz for above 1GHz and RBW=100kHz, VBW=300kHz for 30MHz to 1GHz,, And the maximum value of the receiver should be recorded as (Pr).
- The EUT shall be replaced by a substitution antenna. In the chamber, an substitution antenna for the frequency band of interest is placed at the reference point of the chamber. An RF Signal source for the frequency band of interest is connected to the substitution antenna with a cable that has been constructed to not interfere with the radiation pattern of the antenna. A power (PMea) is applied to the input of the substitution antenna, and adjust the level of the signal generator output until the value of the receiver reach the previously recorded (Pr). The power of signal source (PMea) is recorded. The test should be performed by rotating the test item and adjusting the receiving antenna polarization.
- A amplifier should be connected to the Signal Source output port. And the cable should be connect between the Amplifier and the Substitution Antenna. The cable loss (Pcl) ,the Substitution Antenna Gain (Ga) and the Amplifier Gain (PAg) should be recorded after test.
- The measurement results are obtained as described below:  

$$\text{Power(EIRP)} = \text{PMea} - \text{PAg} - \text{Pcl} + \text{Ga}$$
 The measurement results are amend as described below:  

$$\text{Power(EIRP)} = \text{PMea} - \text{Pcl} + \text{Ga}$$
- This value is EIRP since the measurement is calibrated using an antenna of known gain (2.15 dBi) and known input power. ERP can be calculated from EIRP by subtracting the gain of the dipole,  $\text{ERP} = \text{EIRP} - 2.15\text{dBi}$ .

**Test configuration**

**Below 1GHz:**

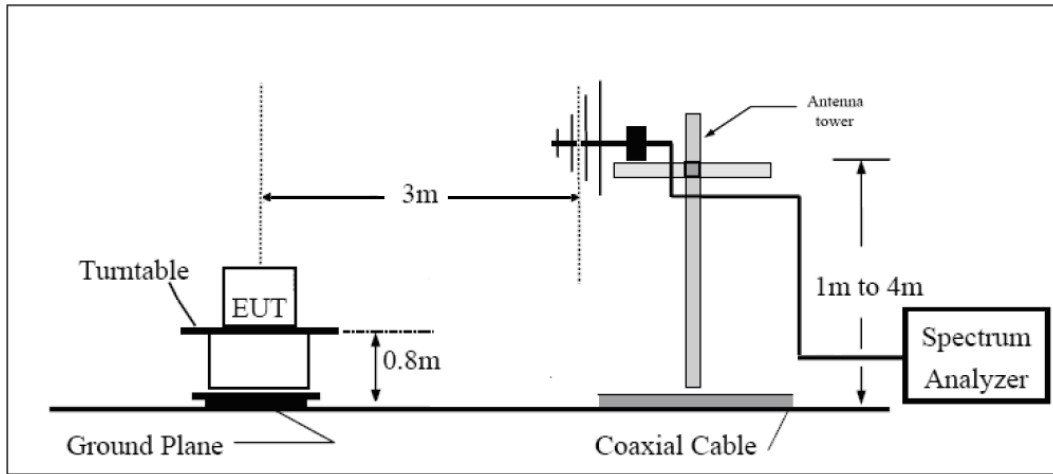

**Above 1GHz:**

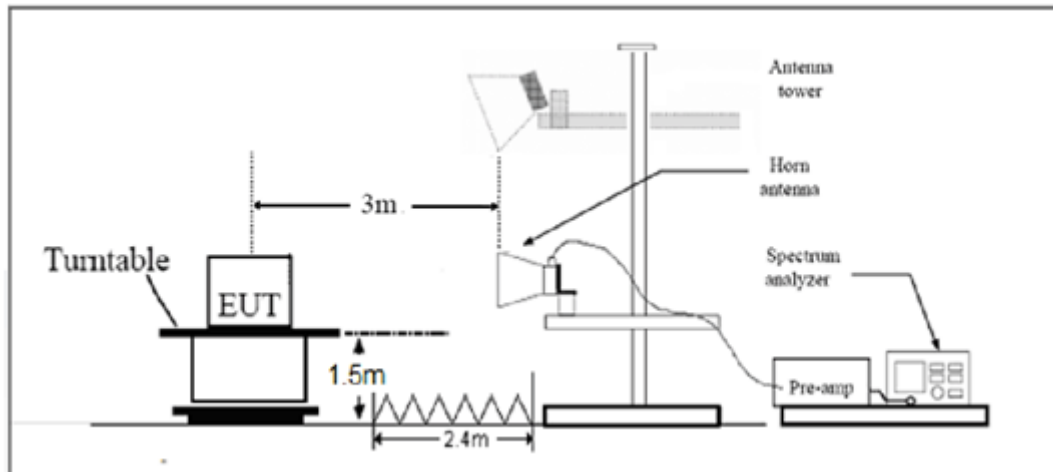

**Limits**

Rule Part 24.232(c) Mobile and portable stations are limited to 2 watts EIRP.

Rule Part 24.232(e) Peak transmit power must be measured over any interval of continuous transmission using instrumentation calibrated in terms of an rms-equivalent voltage.

Limit (EIRP)	$\leq 2\text{ W}$ (33 dBm)
--------------	----------------------------

**Measurement Uncertainty**

The assessed measurement uncertainty to ensure 95% confidence level for the normal distribution is with the coverage factor  $k = 2$ ,  $U = 1.19\text{ dB}$



## Test Results:

NB-IOT Band 2 Standalone									
Frequency (MHz)	Modulation	Sub-carrier spacing (kHz)	Rt (dBm)	Rs (dBm)	Ps (dBm)	Gs (dBd)	EIRP (dBm)	Limit (dBm)	Conclusion
1850.1	BPSK	3.75	-56.60	-54.68	0.00	1.92	27.73	33	Pass
	QPSK	3.75	-55.60	-54.68	0.00	1.92	27.69	33	Pass
	BPSK	15	-57.15	-55.23	0.00	1.92	27.88	33	Pass
	QPSK	15	-57.15	-55.23	0.00	1.92	27.44	33	Pass
1880	BPSK	3.75	-58.34	-56.40	0.00	1.94	26.34	33	Pass
	QPSK	3.75	-58.34	-56.40	0.00	1.94	26.45	33	Pass
	BPSK	15	-58.87	-56.93	0.00	1.94	27.31	33	Pass
	QPSK	15	-58.87	-56.93	0.00	1.94	26.83	33	Pass
1909.9	BPSK	3.75	-59.88	-57.98	0.00	1.90	26.64	33	Pass
	QPSK	3.75	-59.88	-57.98	0.00	1.90	26.49	33	Pass
	BPSK	15	-60.62	-58.72	0.00	1.90	26.86	33	Pass
	QPSK	15	-60.62	-58.72	0.00	1.90	26.68	33	Pass

### 5.3.Occupied Bandwidth

#### Ambient condition

Temperature	Relative humidity	Pressure
23°C ~25°C	45%~50%	101.5kPa

#### Method of Measurement

The EUT was connected to Spectrum Analyzer and Base Station Simulator via power Splitter. The occupied bandwidth is measured using spectrum analyzer.

RBW is set to 2kHz, VBW is set to 6.2kHz for NB-IOT Band 2.

99% power and -26dBc occupied bandwidths are recorded. Spectrum analyzer plots are included on the following pages.

#### Test Setup

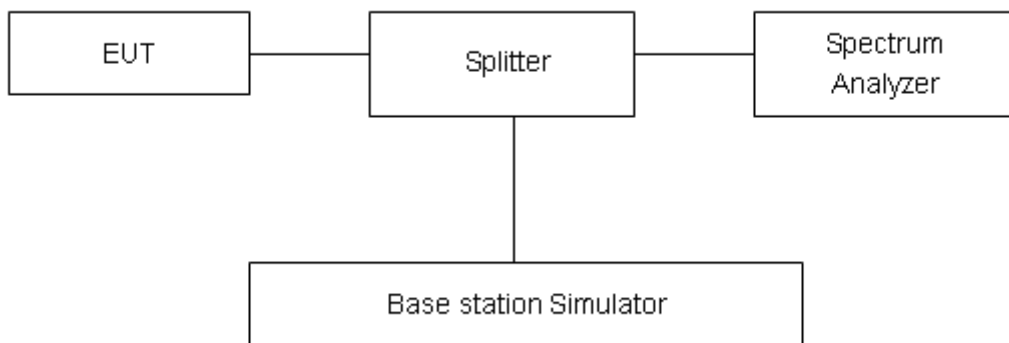

#### Limits

No specific occupied bandwidth requirements in part 2.1049.

#### Measurement Uncertainty

The assessed measurement uncertainty to ensure 95% confidence level for the normal distribution is with the coverage factor  $k = 2$ ,  $U = 624\text{Hz}$ .

**Test Result**

NB-IOT Band 2 Standalone					
Channel/ Frequency (MHz)	Modulation	Sub-carrier spacing (kHz)	Ntones	99% Power Bandwidth(kHz)	-26dBc Bandwidth(kHz)
18601/ 1850.1	BPSK	3.75	1@0	55.190	37.680
	QPSK	3.75	1@0	142.370	118.200
	BPSK	15	1@0	67.957	43.310
	QPSK	15	1@0	142.400	130.800
	QPSK	15	12@0	197.110	304.100
18900/ 1880	BPSK	3.75	1@0	56.083	38.050
	QPSK	3.75	1@0	147.700	108.300
	BPSK	15	1@0	65.719	41.270
	QPSK	15	1@0	139.700	127.600
	QPSK	15	12@0	198.740	289.700
19199/ 1909.9	BPSK	3.75	1@0	52.007	37.670
	QPSK	3.75	1@0	162.770	124.400
	BPSK	15	1@0	66.258	43.950
	QPSK	15	1@0	148.430	130.400
	QPSK	15	12@0	199.180	273.500

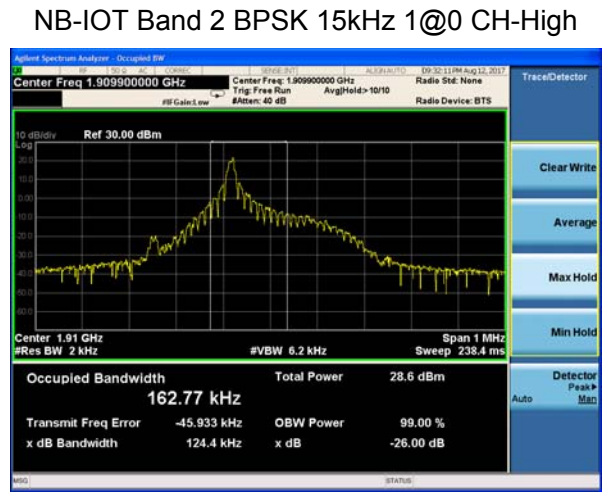
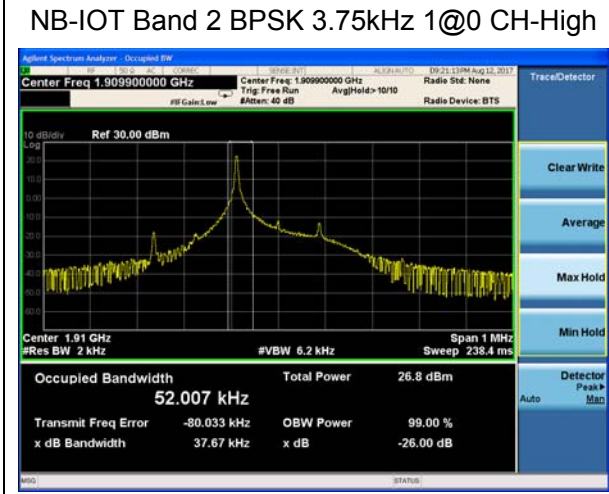
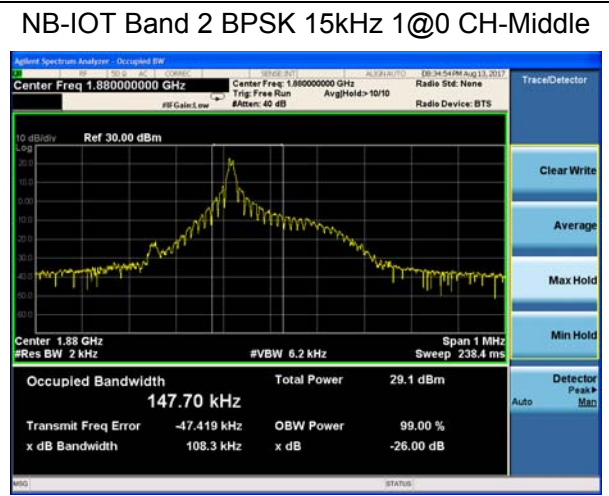
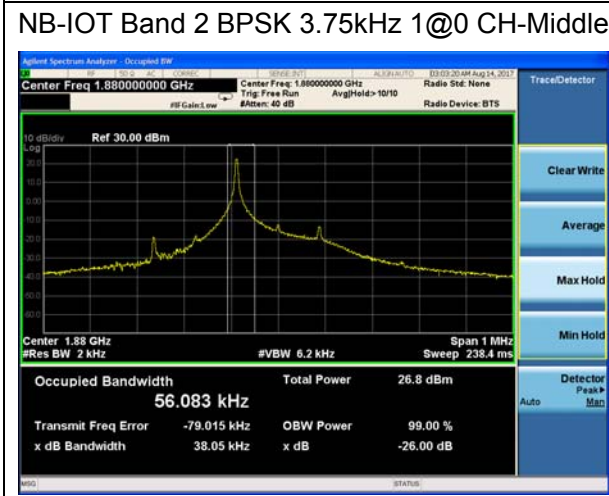
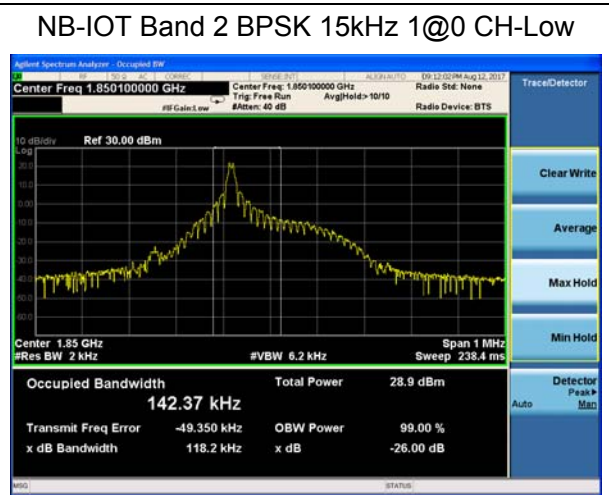
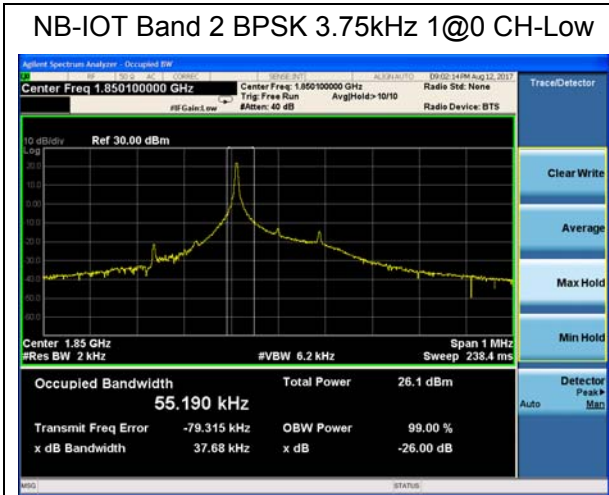



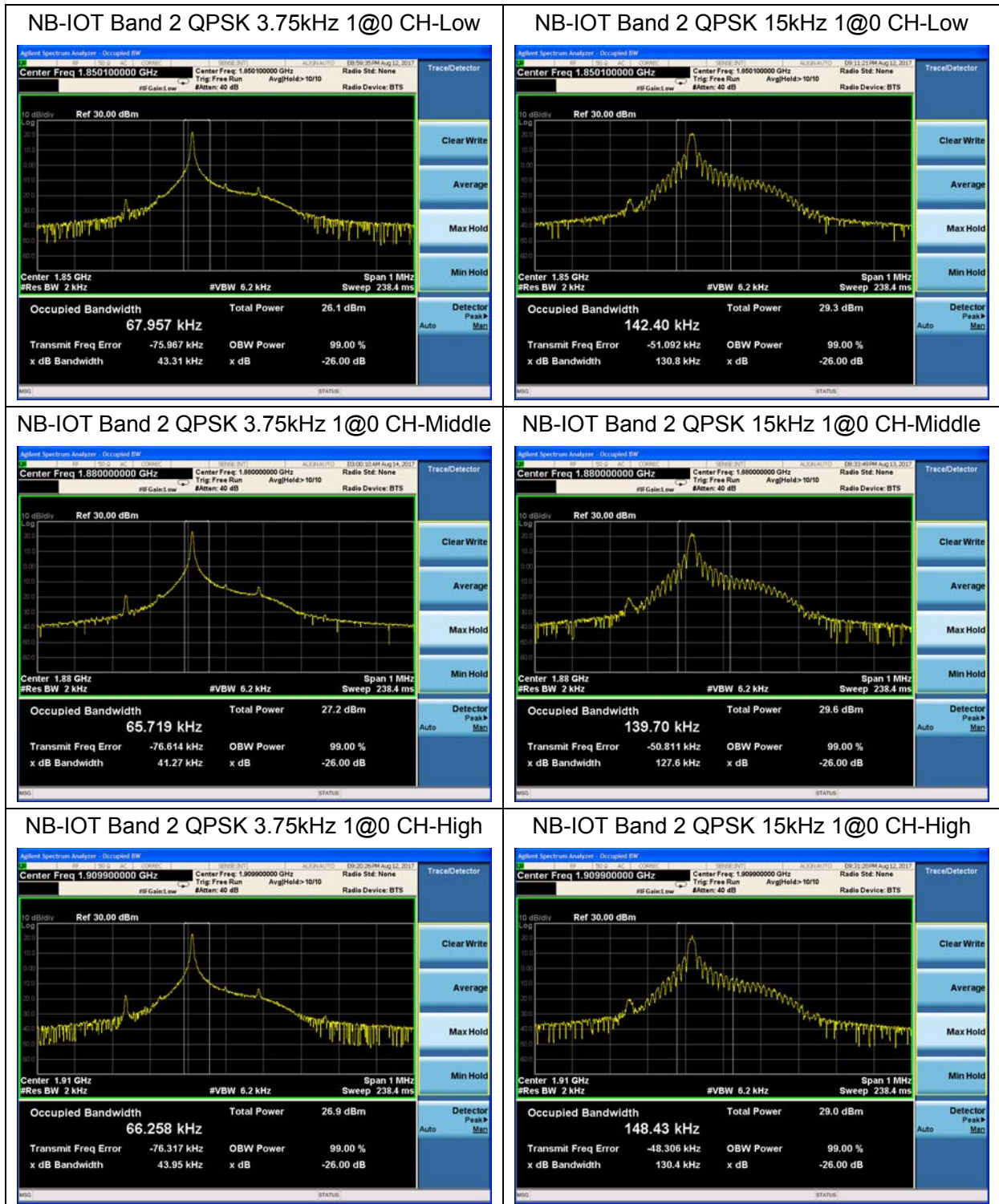

### NB-IOT Band 2 QPSK 15kHz 12@0 CH-Low

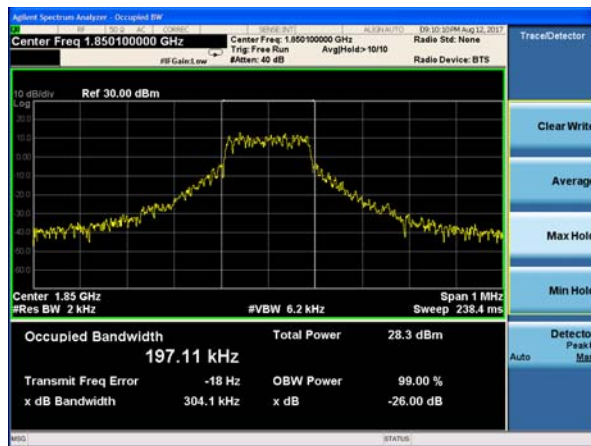

### NB-IOT Band 2 QPSK 15kHz 12@0 CH-Middle

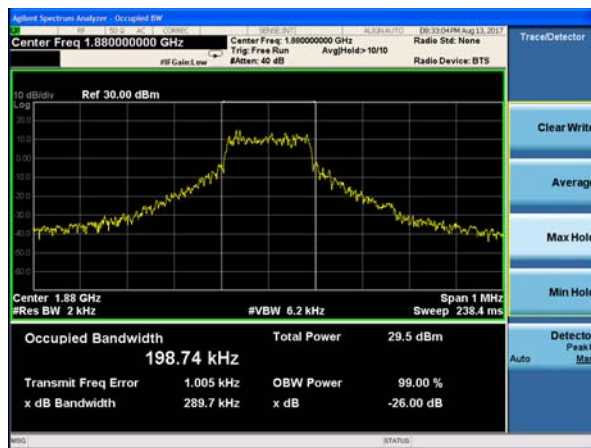

### NB-IOT Band 2 QPSK 15kHz 12@0 CH-High

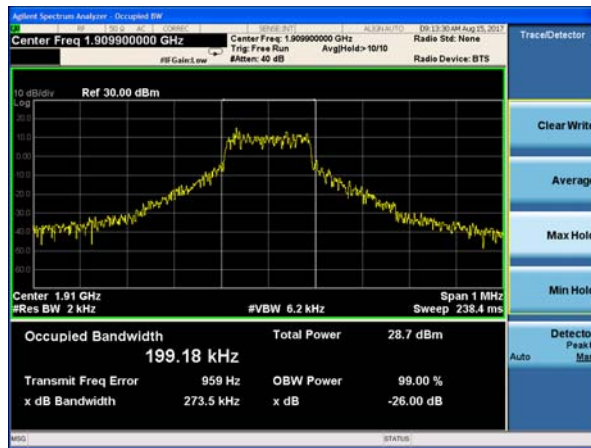

### 5.4. Band Edge Compliance

**Ambient condition**

Temperature	Relative humidity	Pressure
23°C ~25°C	45%~50%	101.5kPa

**Method of Measurement**

The EUT was connected to Spectrum Analyzer and Base Station Simulator via power Splitter. The band edge of the lowest and highest channels were measured. The Average detector is used and RBW is set to 51Hz, VBW is set to 160Hz for 3.75KHz single carrier, RBW is set to 200Hz, VBW is set to 620Hz for 15KHz single carrier, RBW is set to 2kHz, VBW is set to 6.2KHz for 15KHz full carrier, Spectrum analyzer plots are included on the following pages.

**Test Setup**

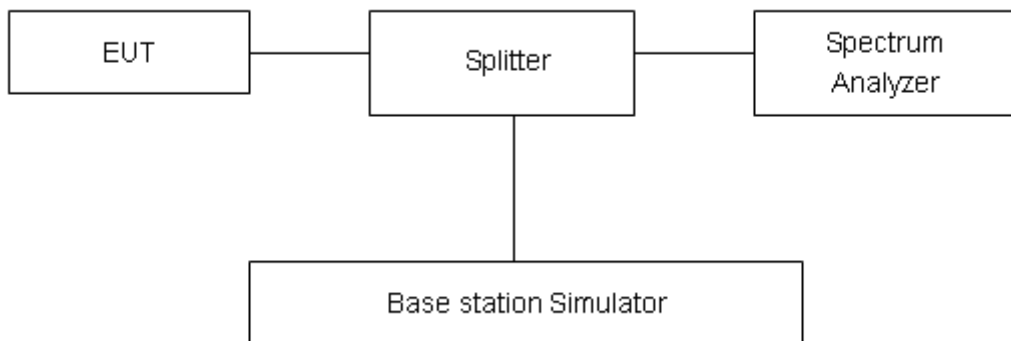

**Limits**

Rule Part 24.238(a) specifies that “on any frequency outside a licensee's frequency block, the power of any emission shall be attenuated below the transmitter power (P) by at least 43 + 10 log10 (P) dB.”

Limit	-13 dBm
-------	---------

**Measurement Uncertainty**

The assessed measurement uncertainty to ensure 95% confidence level for the normal distribution is with the coverage factor  $k = 1.96$ ,  $U=0.684$ dB.

Test Result:

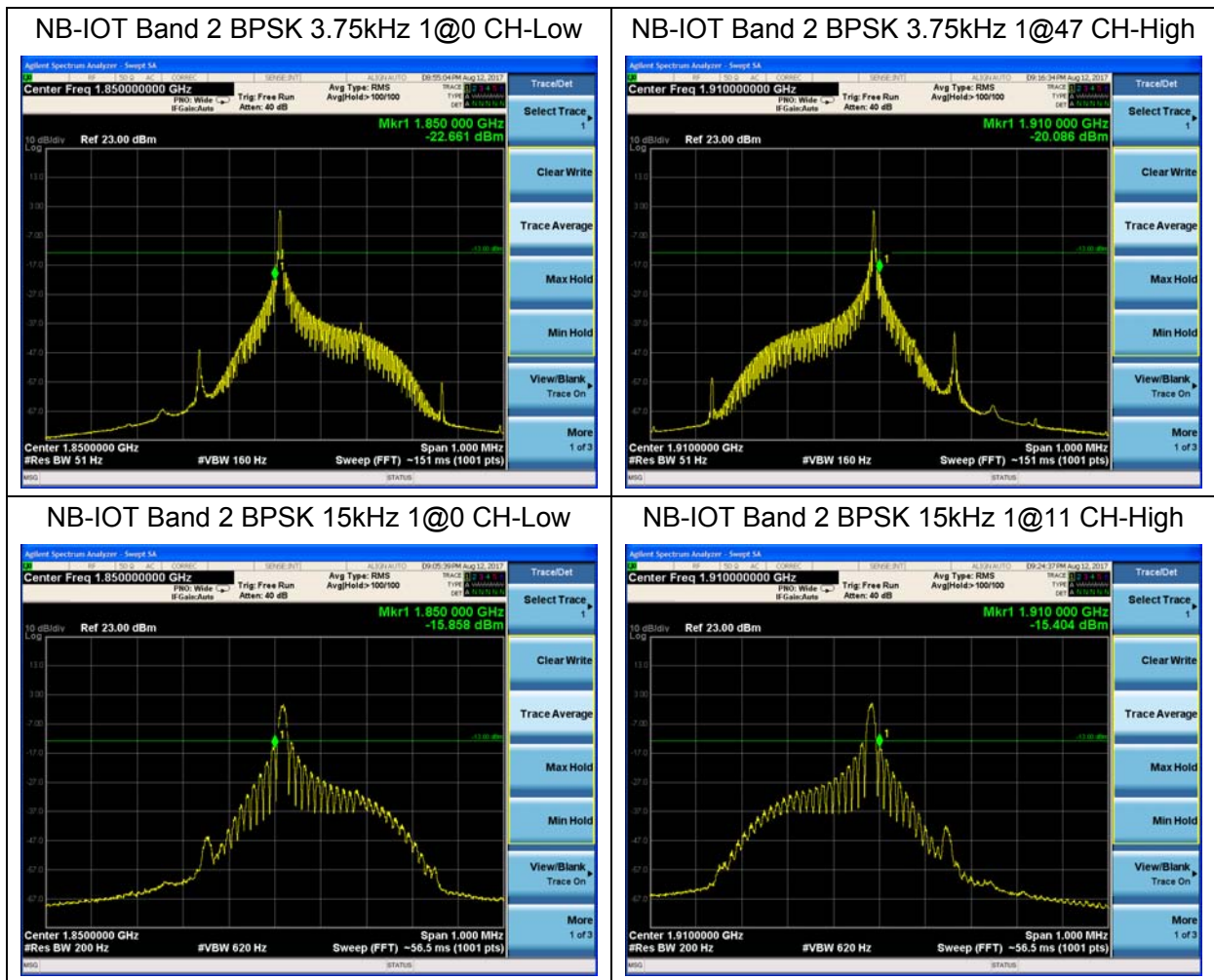

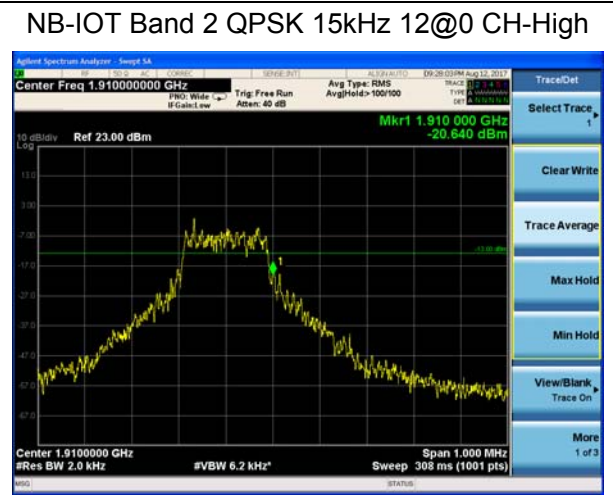
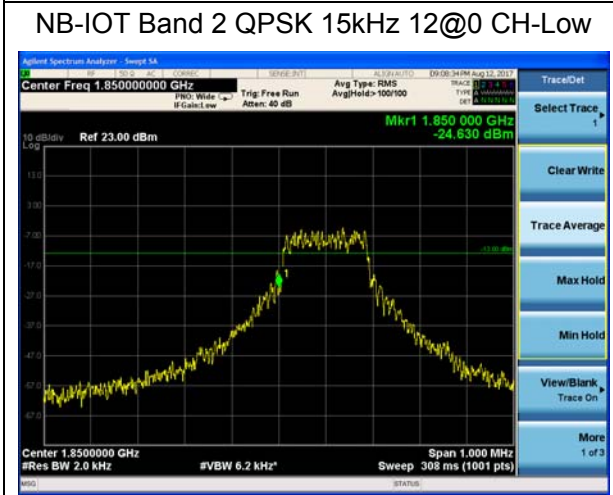
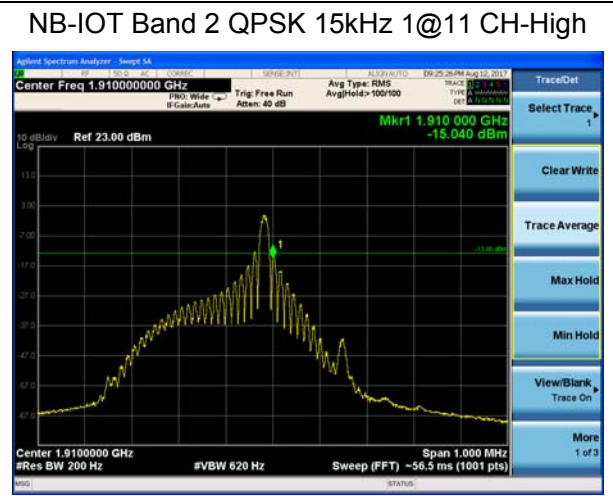
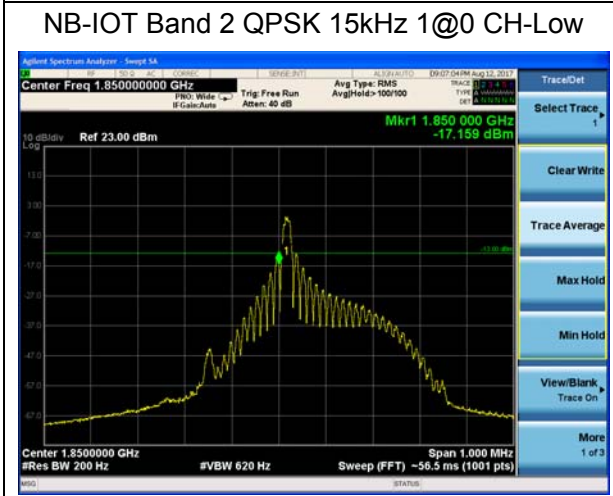
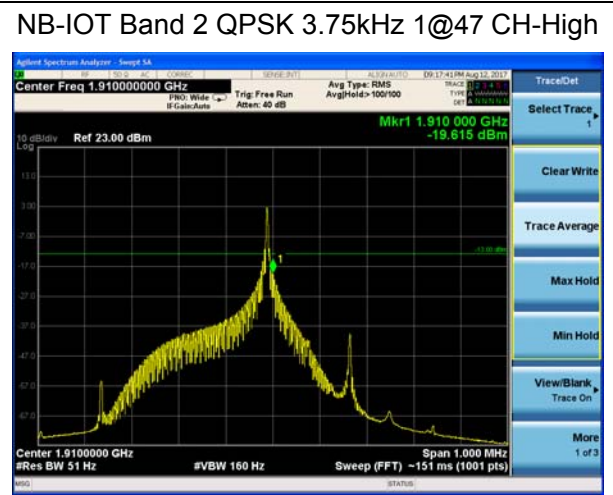
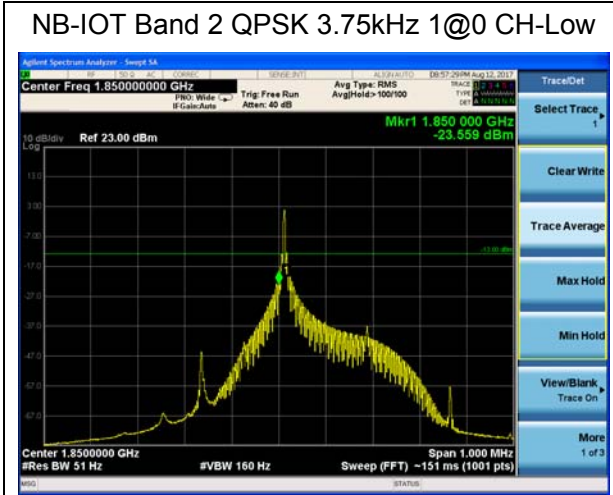

### 5.5. Peak-to-Average Power Ratio (PAPR)

#### Ambient condition

Temperature	Relative humidity	Pressure
23°C ~25°C	45%~50%	101.5kPa

#### Methods of Measurement

Measure the total peak power and record as PPk. And measure the total average power and record as PAvg. Both the peak and average power levels must be expressed in the same logarithmic units (e.g., dBm). Determine the PAPR from:

$$PAPR (dB) = PPk (dBm) - PAvg (dBm).$$

#### Test Setup

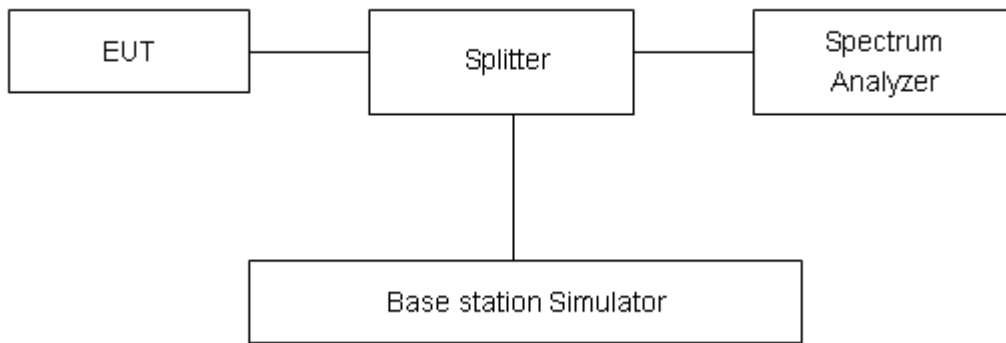

#### Limits

In measuring transmissions in this band using an average power technique, the peak-to-average ratio (PAR) of the transmission may not exceed 13 dB in 24.232(d).

#### Measurement Uncertainty

The assessed measurement uncertainty to ensure 95% confidence level for the normal distribution is with the coverage factor  $k = 2$ ,  $U = 0.4$  dB.

**Test Results**

NB-IOT Band 2 Standalone							
Modulation	Sub-carrier spacing (KHz)	Channel/ Frequency (MHz)	Peak (dBm)	Avg (dBm)	PAPR (dB)	Limit (dB)	Conclusion
BPSK	3.75	18900/1880.0	25.61	22.34	3.27	≤13	PASS
QPSK	3.75	18900/1880.0	28.77	22.40	6.37	≤13	PASS
BPSK	15	18900/1880.0	25.72	22.45	3.27	≤13	PASS
QPSK	15	18900/1880.0	28.70	22.42	6.28	≤13	PASS



## 5.6. Frequency Stability

### Ambient condition

Temperature	Relative humidity	Pressure
23°C ~25°C	45%~50%	101.5kPa

### Method of Measurement

#### 1. Frequency Stability (Temperature Variation)

The temperature inside the climate chamber is varied from -40°C to +85°C in 10°C step size,

(1) With all power removed, the temperature was decreased to 0°C and permitted to stabilize for three hours.

(2) Measure the carrier frequency with the test equipment in a “call mode”. These measurements should be made within 1 minute of powering up the mobile station, to prevent significant self warming.

(3) Repeat the above measurements at 10°C increments from -40°C to +85°C. Allow at least 1.5 hours at each temperature, un-powered, before making measurements.

#### 2. Frequency Stability (Voltage Variation)

The frequency stability shall be measured with variation of primary supply voltage as follows:

(1) Vary primary supply voltage from 85 to 115 percent of the nominal value for other than hand carried battery equipment.

(2) For hand carried, battery powered equipment, reduce primary supply voltage to the battery-operating end point which shall be specified by the manufacturer.

This transceiver is specified to operate with an input voltage of between 3.3 V and 4.3 V, with a nominal voltage of 3.8V.

### Test setup

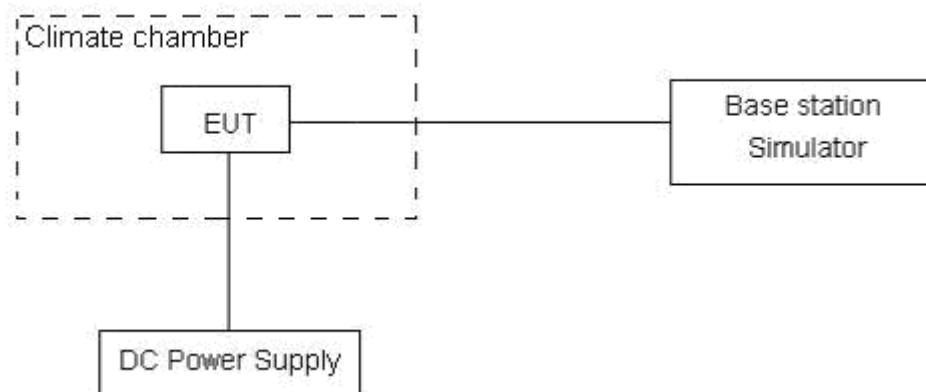





### **Limits**

No specific frequency stability requirements in part 24.235

### **Measurement Uncertainty**

The assessed measurement uncertainty to ensure 99.75% confidence level for the normal distribution is with the coverage factor  $k = 3$ ,  $U = 0.01\text{ppm}$ .

**Test Result**

NB-IOT Band 2 Standalone CH18900 Test Results (ppm)				
Sub-carrier spacing (kHz)	Test status	BPSK	QPSK	
3.75	-40°C/Normal Voltage	-0.00126	-0.00052	
	-30°C/Normal Voltage	-0.00159	-0.00098	
	-20°C/Normal Voltage	-0.00203	-0.00179	
	-10°C/Normal Voltage	-0.00208	-0.00111	
	0°C/Normal Voltage	-0.00132	0.00006	
	10°C/Normal Voltage	-0.00111	-0.00044	
	20°C/Normal Voltage	-0.00188	0.00014	
	30°C/Normal Voltage	-0.00099	-0.00024	
	40°C/Normal Voltage	-0.00087	-0.00224	
	50°C/Normal Voltage	-0.00203	-0.00024	
	60°C/Normal Voltage	-0.00132	-0.00092	
	70°C/Normal Voltage	-0.00173	-0.00031	
	80°C/Normal Voltage	-0.00069	-0.00103	
	85°C/Normal Voltage	-0.00187	-0.00052	
	20°C/Minimum Voltage	-0.00126	-0.00080	
	20°C/Maximum Voltage	-0.00058	-0.00059	
	15	-40°C/Normal Voltage	-0.00092	-0.00089
		-30°C/Normal Voltage	-0.00097	-0.00207
-20°C/Normal Voltage		-0.00154	-0.00223	
-10°C/Normal Voltage		-0.00209	-0.00198	
0°C/Normal Voltage		-0.00094	-0.00185	
10°C/Normal Voltage		-0.00126	-0.00245	
20°C/Normal Voltage		-0.00219	-0.00159	
30°C/Normal Voltage		-0.00086	-0.00104	
40°C/Normal Voltage		-0.00074	-0.00147	
50°C/Normal Voltage		-0.00114	-0.00081	
60°C/Normal Voltage		-0.00069	-0.00014	
70°C/Normal Voltage		-0.00110	-0.00068	
80°C/Normal Voltage		-0.00165	-0.00124	
85°C/Normal Voltage		-0.00084	-0.00110	
20°C/Minimum Voltage		-0.00200	-0.00164	
20°C/Maximum Voltage		-0.00165	-0.00115	

### 5.7. Spurious Emissions at Antenna Terminals

#### Ambient condition

Temperature	Relative humidity	Pressure
23°C ~25°C	45%~50%	101.5kPa

#### Method of Measurement

The EUT was connected to Spectrum Analyzer and Base Station Simulator via power Splitter. The measurement is carried out using a spectrum analyzer. The spectrum analyzer scans from 9kHz to the 10th harmonic of the carrier. The peak detector is used.set RBW 1MHz and VBW is 3MHz, Sweep is set to ATUO.

#### Test setup

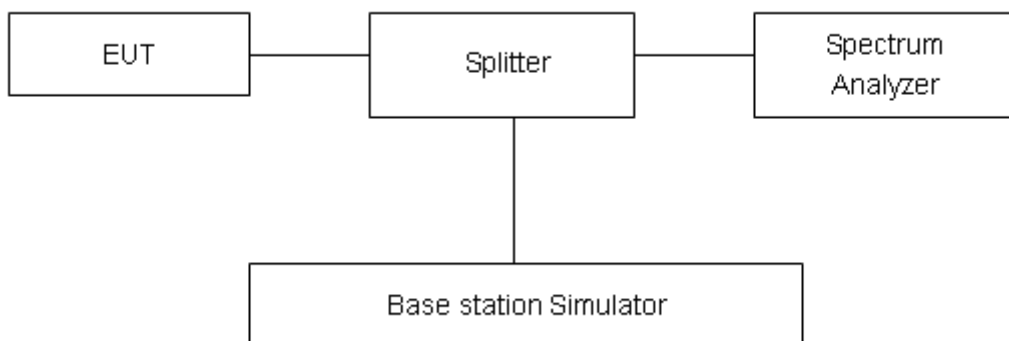

#### Limits

Rule Part 24.238(a) specifies that “on any frequency outside a licensee’s frequency block, the power of any emission shall be attenuated below the transmitter power (P) by at least 43 + 10 log<sub>10</sub> (P) dB.”

Limit	-13 dBm
-------	---------

#### Measurement Uncertainty

The assessed measurement uncertainty to ensure 99.75% confidence level for the normal distribution is with the coverage factor  $k = 1.96$ .

Frequency	Uncertainty
100kHz-2GHz	0.684 dB
2GHz-18GHz	1.407 dB

### Test Result

Sweep from 9 kHz to 30MHz, and the emissions more than 20 dB below the permissible value are not reported.

If disturbances were found more than 20dB below limit line, the mark is not required for the EUT.

The signal beyond the limit is carrier.

#### Standalone deployment with 15 KHz subcarrier spacing and QPSK mode for CAT NB1:

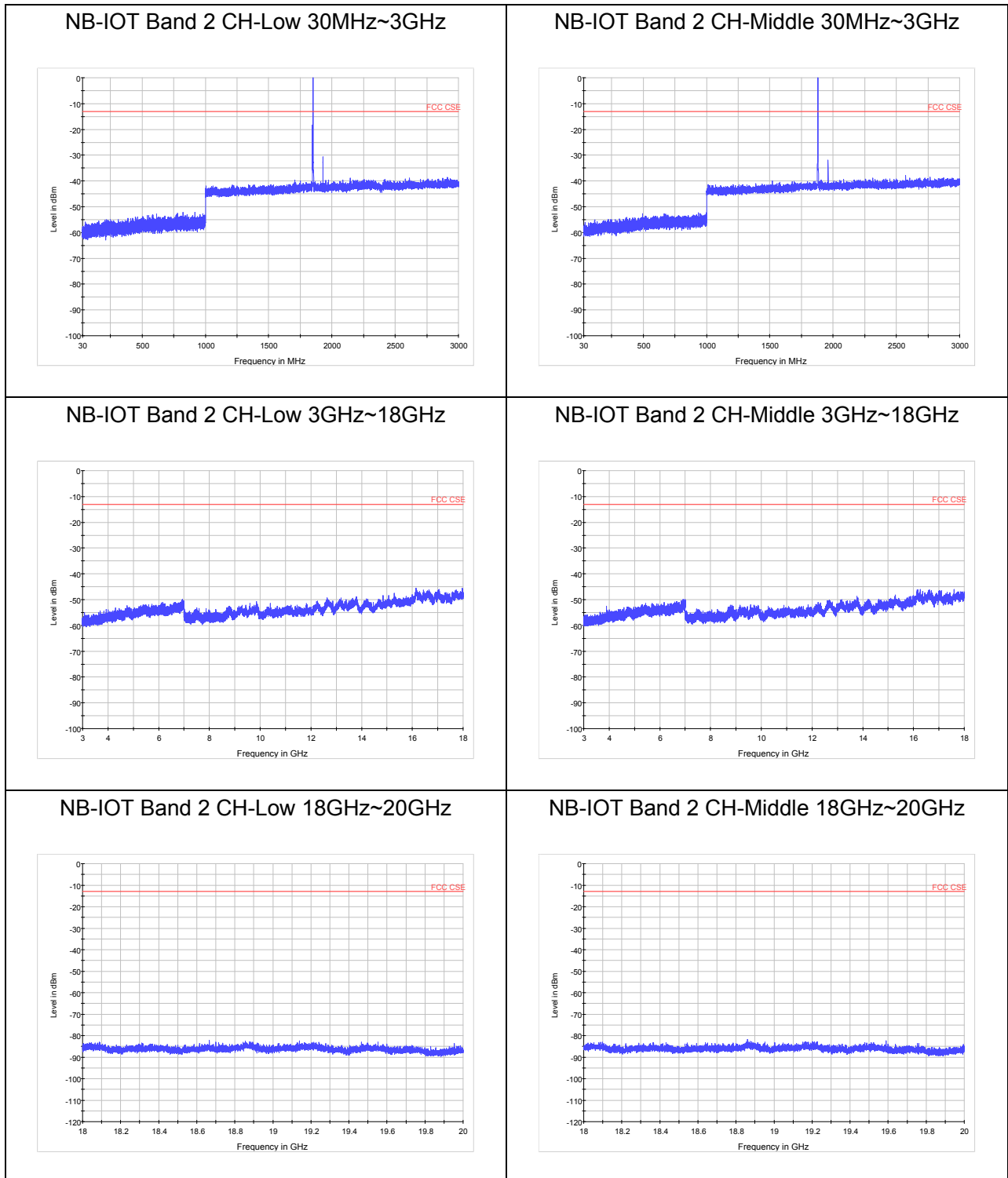



NB-IOT Band 2 CH-High 30MHz~3GHz

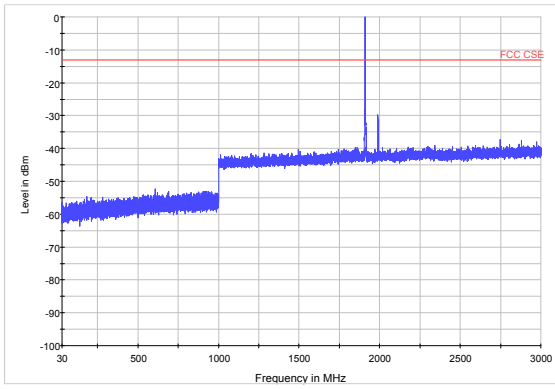

NB-IOT Band 2 CH-High 3GHz~18GHz

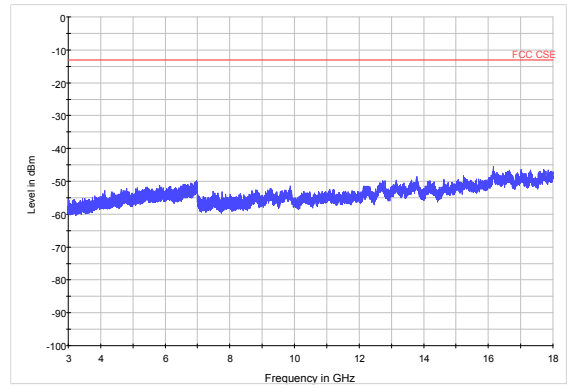

NB-IOT Band 2 CH-High 18GHz~20GHz

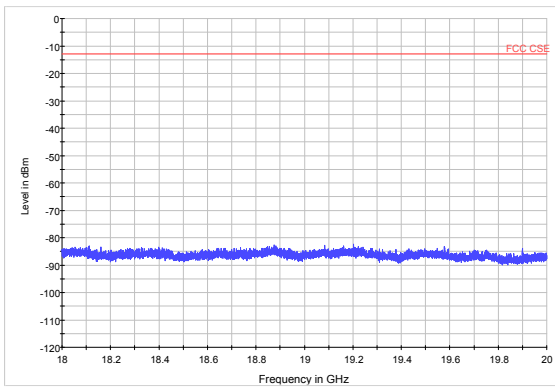

## 5.8. Radiates Spurious Emission

### Ambient condition

Temperature	Relative humidity	Pressure
23°C ~25°C	45%~50%	101.5kPa

### Method of Measurement

1. The testing follows FCC KDB 971168 v02r02 Section 5.8 and ANSI / TIA-603-D-2010 Section 2.2.12.
2. Above 30MHz: The EUT is placed on a turntable 0.8 meters above the ground in the chamber, 3 meter away from the antenna. The maximal emission value is acquired by adjusting the antenna height, polarisation and turntable azimuth. Normally, the height range of antenna is 1 m to 4 m, the azimuth range of turntable is 0° to 360°, and the receive antenna has two polarizations Vertical (V) and Horizontal (H). Above 1GHz: (Note: the FCC's permission to use 1.5m as an aNB-LoTrnative per TCBC Conf call of Dec. 2, 2014.) The EUT is placed on a turntable 1.5 meters above the ground in the chamber, 3 meter away from the antenna. The maximal emission value is acquired by adjusting the antenna height, polarisation and turntable azimuth. Normally, the height range of antenna is 1 m to 4 m, the azimuth range of turntable is 0° to 360°, and the receive antenna has two polarizations Vertical (V) and Horizontal (H).
3. A log-periodic antenna or double-ridged waveguide horn antenna shall be substituted in place of the EUT. The log-periodic antenna will be driven by a signal generator and the level will be adjusted till the same power value on the spectrum analyzer or receiver. The level of the spurious emissions can be calculated through the level of the signal generator, cable loss, the gain of the substitution antenna and the reading of the spectrum analyzer or receiver.
4. The EUT is then put into continuously transmitting mode at its maximum power level during the test. Set Test Receiver or Spectrum RBW=1MHz, VBW=3MHz, And the maximum value of the receiver should be recorded as (Pr).
5. The EUT shall be replaced by a substitution antenna. In the chamber, an substitution antenna for the frequency band of interest is placed at the reference point of the chamber. An RF Signal source for the frequency band of interest is connected to the substitution antenna with a cable that has been constructed to not interfere with the radiation pattern of the antenna. A power (PMea) is applied to the input of the substitution antenna, and adjust the level of the signal generator output until the value of the receiver reach the previously recorded (Pr). The power of signal source (PMea) is recorded. The test should be performed by rotating the test item and adjusting the receiving antenna polarization.
6. A amplifier should be connected to the Signal Source output port. And the cable should be connect between the Amplifier and the Substitution Antenna. The cable loss (Pcl) ,the Substitution Antenna Gain (Ga) and the Amplifier Gain (PAg) should be recorded after test.
7. The measurement results are obtained as described below:  
$$\text{Power(EIRP)} = \text{PMea} - \text{PAg} - \text{Pcl} + \text{Ga}$$
  
The measurement results are amend as described below:  
$$\text{Power(EIRP)} = \text{PMea} - \text{Pcl} + \text{Ga}$$
8. This value is EIRP since the measurement is calibrated using an antenna of known gain (2.15 dBi)

and known input power. ERP can be calculated from EIRP by subtracting the gain of the dipole,  $ERP = EIRP - 2.15\text{dB}$ .

**Test setup**

**30MHz~~~ 1GHz**

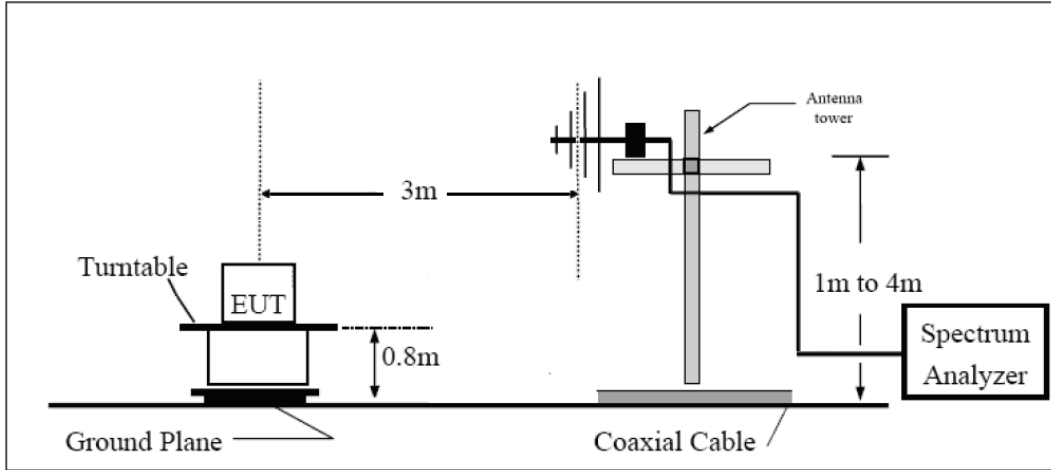

**Above 1GHz**

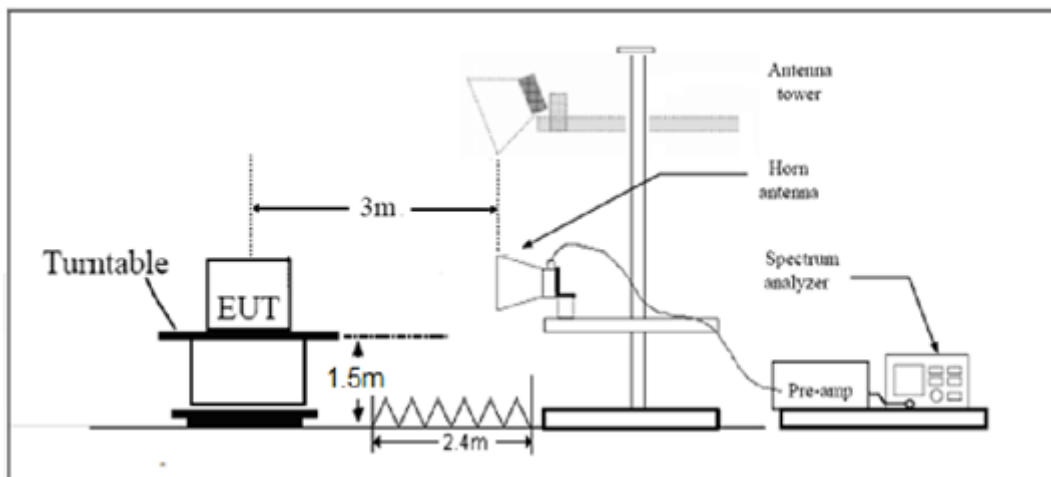

Note: Area side: 2.4mX3.6m

The radiated emission was measured in the following position: EUT lie-down position (Z axis), stand-up position (X, Y axis). The worst emission was found in lie-down position (Z axis) and the worst case was recorded.

**Limits**

Rule Part 24.238(a) specifies that “on any frequency outside a licensee's frequency block, the power of any emission shall be attenuated below the transmitter power (P) by at least  $43 + 10 \log_{10}(P)$  dB.”

Limit	-13 dBm
-------	---------

**Measurement Uncertainty**

The assessed measurement uncertainty to ensure 95% confidence level for the normal distribution is with the coverage factor  $k = 1.96$ ,  $U = 3.55$  dB.

**Test Result**

The other Spurious RF Radiated emissions level is no more than noise floor.

The worst emission was found in the antenna is vertical position.

**Standalone deployment with 15 KHz subcarrier spacing and QPSK mode for CAT NB1:**

NB-IOT Band 2 CH-Low

Harmonic	Frequency (MHz)	SG (dBm)	Cable Loss (dB)	Gain (dBi)	Antenna Polarization	EIRP Level (dBm)	Limit (dBm)	Margin (dB)	Azimuth (deg)
2	3700.2	-54.68	5.1	11.05	vertical	-48.73	-13.00	35.73	180
3	5550.3	-53.31	5.42	12.65	vertical	-46.08	-13.00	33.08	315
4	7400.4	-49.53	6.7	13.85	vertical	-42.38	-13.00	29.38	135
5	9250.5	-49.27	7.01	14.75	vertical	-41.53	-13.00	28.53	225
6	11100.6	-46.55	7.48	15.95	vertical	-38.08	-13.00	25.08	90
7	12950.7	-45.39	7.51	16.55	vertical	-36.35	-13.00	23.35	180
8	14800.8	-41.69	8.24	15.35	vertical	-34.58	-13.00	21.58	45
9	16650.9	-42.73	8.41	14.95	vertical	-36.19	-13.00	23.19	180
10	18501.0	-41.05	8.54	15.45	vertical	-34.14	-13.00	21.14	45

NB-IOT Band 2 CH-Middle

Harmonic	Frequency (MHz)	SG (dBm)	Cable Loss (dB)	Gain (dBi)	Antenna Polarization	EIRP Level (dBm)	Limit (dBm)	Margin (dB)	Azimuth (deg)
2	3760.0	-55.92	5.10	11.05	vertical	-49.97	-13.00	36.97	0
3	5640.0	-52.50	5.42	12.65	vertical	-45.27	-13.00	32.27	135
4	7520.0	-48.64	6.70	13.85	vertical	-41.49	-13.00	28.49	225
5	9400.0	-47.74	7.01	14.75	vertical	-40.00	-13.00	27.00	90
6	11280.0	-45.18	7.48	15.95	vertical	-36.71	-13.00	23.71	225
7	13160.0	-45.78	7.51	16.55	vertical	-36.74	-13.00	23.74	180
8	15040.0	-43.85	8.24	15.35	vertical	-36.74	-13.00	23.74	270
9	16920.0	-41.46	8.41	14.95	vertical	-34.92	-13.00	21.92	135
10	18800.0	-41.56	8.54	15.45	vertical	-34.65	-13.00	21.65	225





## NB-IOT Band 2 CH-High

Harmonic	Frequency (MHz)	SG (dBm)	Cable Loss (dB)	Gain (dBi)	Antenna Polarization	EIRP Level (dBm)	Limit (dBm)	Margin (dB)	Azimuth (deg)
2	3819.8	-56.35	5.10	11.05	vertical	-50.40	-13.00	37.40	135
3	5729.7	-55.98	5.42	12.65	vertical	-48.75	-13.00	35.75	90
4	7639.6	-48.76	6.70	13.85	vertical	-41.61	-13.00	28.61	45
5	9549.5	-50.14	7.01	14.75	vertical	-42.40	-13.00	29.40	180
6	11459.4	-45.01	7.48	15.95	vertical	-36.54	-13.00	23.54	45
7	13369.3	-45.26	7.51	16.55	vertical	-36.22	-13.00	23.22	0
8	15279.2	-43.74	8.24	15.35	vertical	-36.63	-13.00	23.63	135
9	17189.1	-41.16	8.41	14.95	vertical	-34.62	-13.00	21.62	225
10	19099.0	-41.44	8.54	15.45	vertical	-34.53	-13.00	21.53	90

## 6. Main Test Instruments

Name	Manufacturer	Type	Serial Number	Calibration Date	Expiration Time
Base Station Simulator	R&S	CMW500	150415	2017-05-14	2018-05-13
Power Splitter	Hua Xiang	SHX-GF2-2-13	10120101	2017-05-14	2018-05-13
Spectrum Analyzer	Agilent	N9010A	MY47191109	2017-05-20	2018-05-19
Universal Radio Communication Tester	Agilent	E5515C	MY48367192	2017-05-20	2018-05-19
Signal Analyzer	R&S	FSV30	100815	2016-12-16	2017-12-15
EMI Test Receiver	R&S	ESCI	100948	2017-05-20	2018-05-19
Signal generator	R&S	SMB 100A	102594	2017-05-14	2018-05-13
Signal generator	R&S	SMR27	100365	2017-05-14	2018-05-13
Trilog Antenna	SCHWARZBECK	VUBL 9163	9163-201	2014-12-06	2017-12-05
Horn Antenna	R&S	HF907	100126	2014-12-06	2017-12-05
Climatic Chamber	Re Ce	PT-30B	20101891	2015-07-18	2018-07-17
Horn Antenna	ETS-Lindgren	3160-09	00102644	2015-01-30	2018-01-29
RF Cable	Agilent	SMA 15cm	0001	2017-02-06	2017-08-05
Preampflier	R&S	SCU18	102327	2017-06-18	2018-06-17

\*\*\*\*\*END OF REPORT \*\*\*\*\*

## ANNEX A: EUT Appearance and Test Setup

### A.1 EUT Appearance



shielding

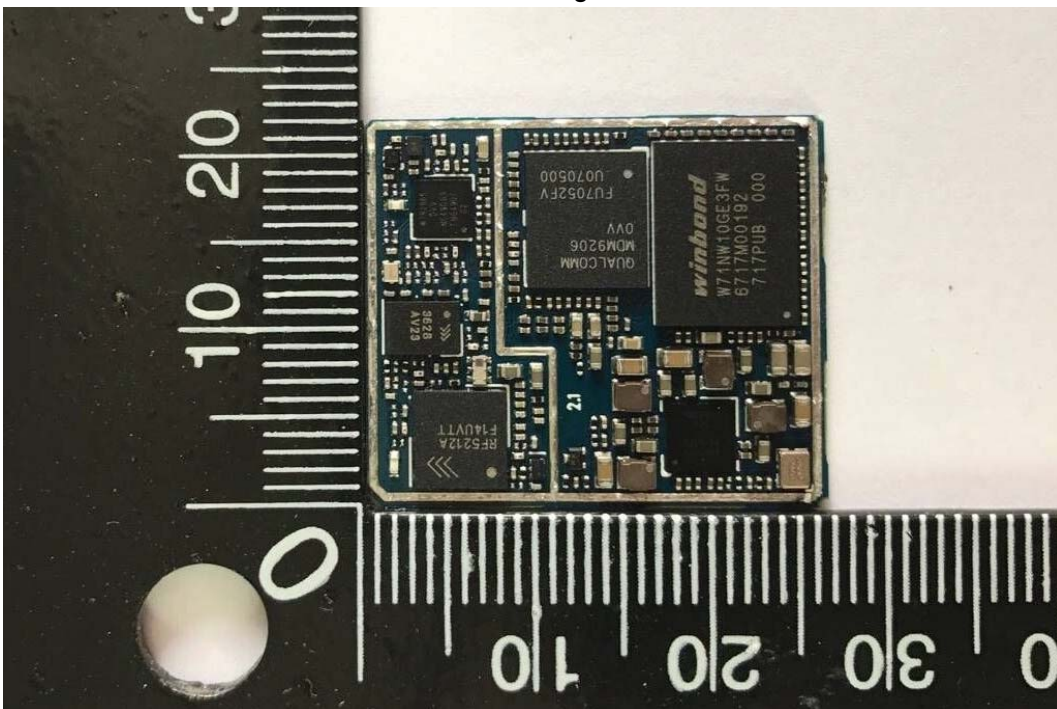

No shielding  
Front Side

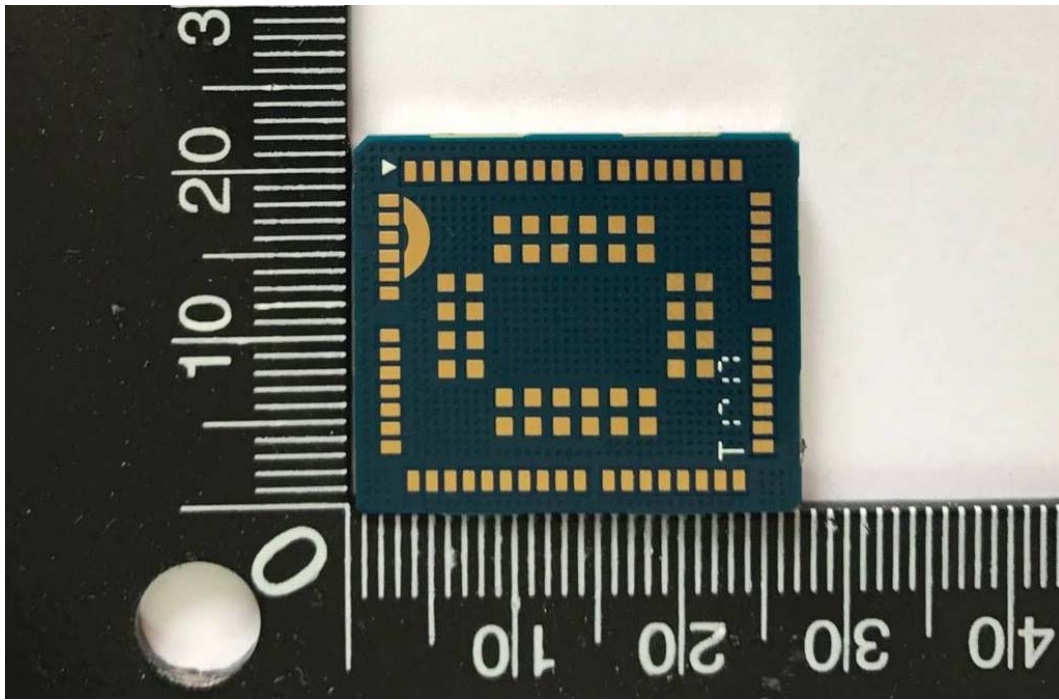

Back Side  
a: EUT



## A.2 Test Setup

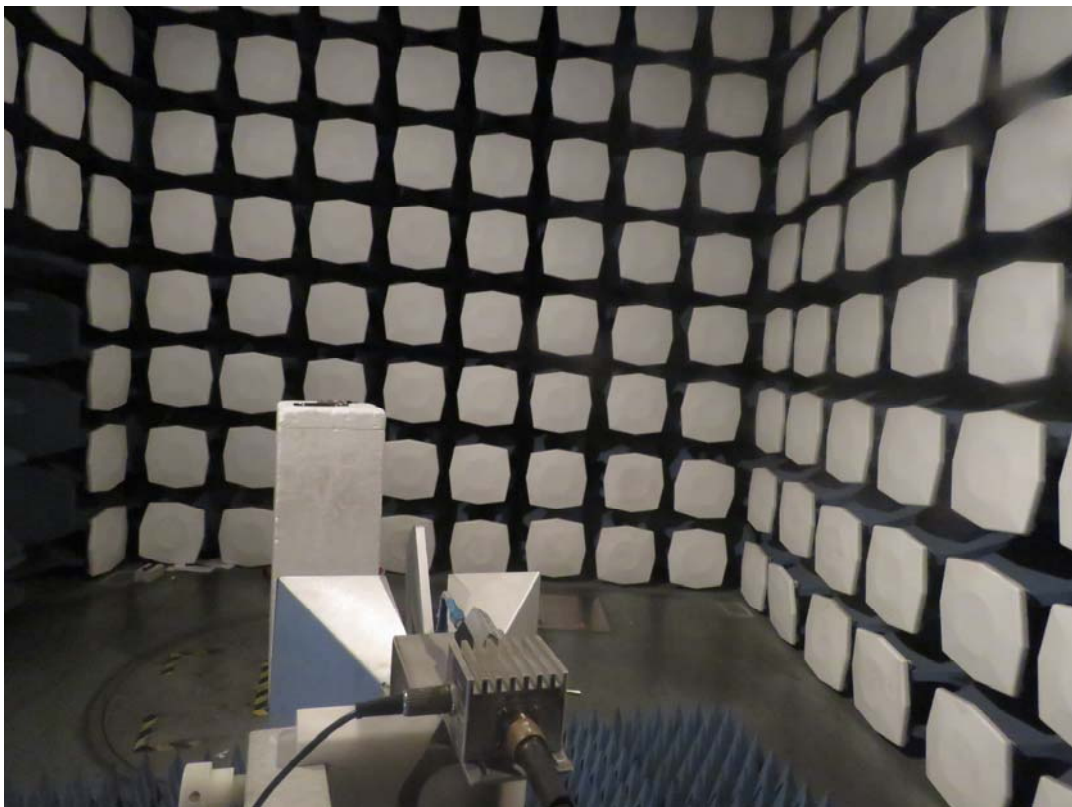
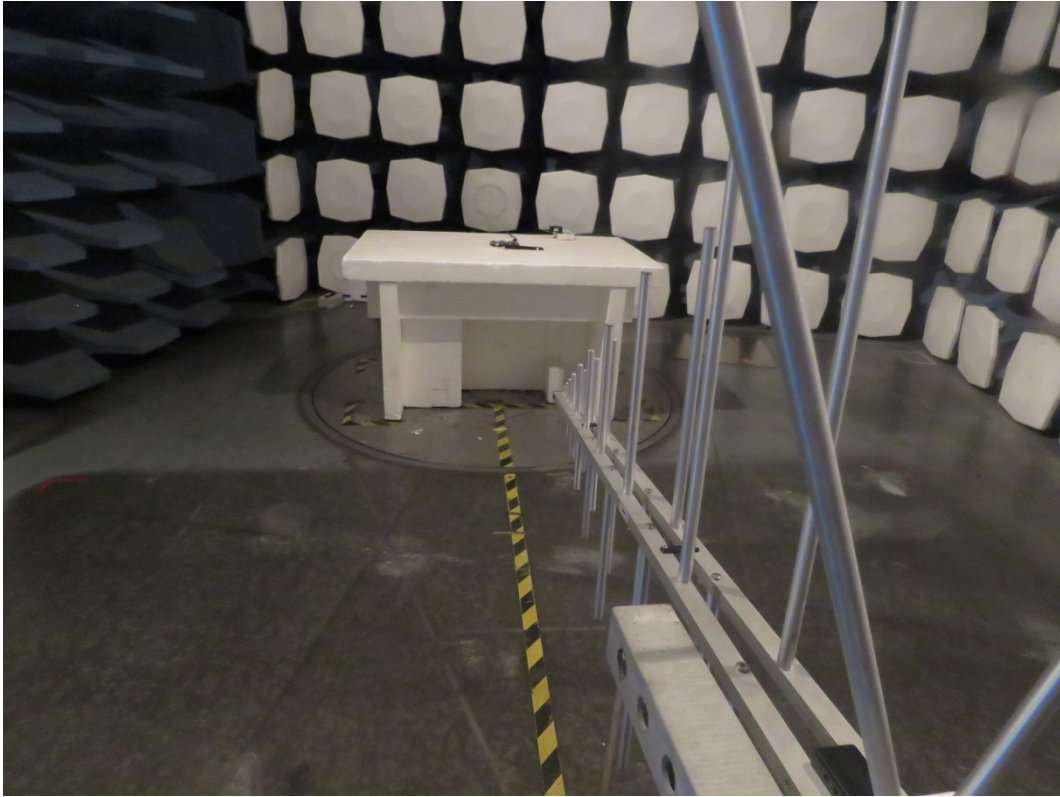

**Picture 2: Radiated Spurious Emissions Test setup**