



# FCC 47 CFR PART 22 SUBPART H AND PART 24 SUBPART E TEST REPORT

For

**Product Name: GSM/GPRS Module**

**Brand Name: Quectel**

**Model No.: GC65**

**Series Model: N/A**

**Test Report Number:  
C140331R02-RP1**

Issued for

**Quectel Wireless Solutions Co., Ltd.**

**Room 501, Building 13, No.99 TianZhouRoad,Xuhui District, Shanghai**

Issued by

**Compliance Certification Services Inc.**

**Kun shan Laboratory**

**No.10 Weiye Rd., Innovation park, Eco&Tec,  
Development Zone, Kunshan City, Jiangsu, China**

**TEL: 86-512-57355888**

**FAX: 86-512-57370818**



TESTING CERT #2541.01

**Note:** This report shall not be reproduced except in full, without the written approval of Compliance Certification Services Inc. This document may be altered or revised by Compliance Certification Services Inc. personnel only, and shall be noted in the revision section of the document. The client should not use it to claim product endorsement by A2LA or any government agencies. The test results in the report only apply to the tested sample.



# Compliance Certification Services Inc.

Reference No.: C140328R01-RP1

Report No: C140331R02-RP1

FCC ID: XMR201403GC65

Date of Issue :April 23, 2014

## REVISION HISTORY

Rev.	Issue Date	Report NO.	Effect Page	Contents
00	April 21, 2014	C140328R01-RP1	ALL	N/A
01	April 23, 2014	C140331R02-RP1	Page 1, page 4 and page 5	only different model



## TABLE OF CONTENTS

<b>1</b>	<b>TEST RESULT CERTIFICATION .....</b>	<b>4</b>
<b>2</b>	<b>EUT DESCRIPTION .....</b>	<b>5</b>
<b>3</b>	<b>TEST METHODOLOGY .....</b>	<b>6</b>
	3.1. EUT CONFIGURATION .....	6
	3.2. EUT EXERCISE.....	6
	3.3. GENERAL TEST PROCEDURES.....	6
	3.4. DESCRIPTION OF TEST MODES.....	6
<b>4</b>	<b>INSTRUMENT CALIBRATION .....</b>	<b>7</b>
	4.1. MEASURING INSTRUMENT CALIBRATION .....	7
	4.2. MEASUREMENT EQUIPMENT USED .....	7
	4.3. MEASUREMENT UNCERTAINTY .....	8
<b>5</b>	<b>FACILITIES AND ACCREDITATIONS .....</b>	<b>9</b>
	5.1. FACILITIES .....	9
	5.2. EQUIPMENT.....	9
	5.3. ACCREDITATIONS .....	9
<b>6</b>	<b>SETUP OF EQUIPMENT UNDER TEST .....</b>	<b>10</b>
	6.1. SETUP CONFIGURATION OF EUT .....	10
	6.2. SUPPORT EQUIPMENT .....	10
<b>7</b>	<b>FCC PART 22 &amp; 24 REQUIREMENTS.....</b>	<b>11</b>
	7.1. PEAK POWER.....	11
	7.2. AVERAGE POWER.....	13
	7.3. ERP & EIRP MEASUREMENT.....	15
	7.4. OCCUPIED BANDWIDTH MEASUREMENT .....	19
	7.5. OUT OF BAND EMISSION AT ANTENNA TERMINALS .....	32
	7.6. FIELD STRENGTH OF SPURIOUS RADIATION MEASUREMENT .....	45
	7.7. FREQUENCY STABILITY V.S. TEMPERATURE MEASUREMENT .....	71
	7.8. REQUENCY STABILITY V.S. VOLTAGE MEASUREMENT .....	74
	7.9. POWERLINE CONDUCTED EMISSIONS .....	76
	<b>APPENDIX I: PHOTOS OF EUT .....</b>	<b>79</b>



# Compliance Certification Services Inc.

Reference No.: C140328R01-RP1

Report No: C140331R02-RP1

FCC ID: XMR201403GC65

Date of Issue :April 23, 2014

## 1 TEST RESULT CERTIFICATION

<b>Product Name:</b>	GSM/GPRS Module
<b>Trade Name:</b>	Quectel
<b>Model Name.:</b>	GC65
<b>Series Model:</b>	N/A
<b>Description Test Modes(worst case):</b>	SIM1 is a chipset unit and tested as single chipset.
<b>Device Category:</b>	Production unit
<b>Date of Test:</b>	April 18, 2014
<b>Applicant:</b>	<b>Quectel Wireless Solutions Co., Ltd.</b> Room 501, Building 13, No.99 TianZhouRoad,Xuhui District, Shanghai
<b>Manufacturer:</b>	<b>Quectel Wireless Solutions Co., Ltd.</b> Room 501, Building 13, No.99 TianZhouRoad,Xuhui District, Shanghai
<b>Application Type:</b>	Certification

APPLICABLE STANDARDS	
STANDARD	TEST RESULT
FCC 47 CFR Part 22 Subpart H & Part 24 Subpart E	No non-compliance noted

The above equipment was tested by Compliance Certification Services Inc. The test data, data evaluation, test procedures, and equipment configurations shown in this report were made in accordance with the procedures given in ANSI C63.4: 2003 and the energy emitted by the sample EUT tested as described in this report is in compliance with conducted and radiated emission limits of FCC Rule FCC PART 22 Subpart H and PART 24 Subpart E.

The test results of this report relate only to the tested sample identified in this report.

**Approved by:**

**Tested by:**

Jeff.Fang  
RF Manager  
Compliance Certification Service Inc.

Blent.Wang  
Test Engineer  
Compliance Certification Service Inc.



## 2 EUT DESCRIPTION

<b>Product Name:</b>	GSM/GPRS Module
<b>Brand Name:</b>	Quectel
<b>Model Name:</b>	GC65
<b>Series Model:</b>	N/A
<b>Model Discrepancy:</b>	N/A
<b>Power Adapter Power Rating :</b>	DC 4.0V
<b>Frequency Range:</b>	GSM/GPRS 850: 824.20 ~ 848.80 MHz GSM/GPRS 1900: 1850.20 ~ 1909.80 MHz
<b>Transmit Power:</b>	GSM 850: 32.19 dBm GPRS 850: 32.13 dBm GSM 1900: 29.10 dBm GPRS 1900: 29.00 dBm
<b>Modulation Technique:</b>	GMSK
<b>Devices supporting GPRS:</b>	Class B
<b>GPRS Level:</b>	10
<b>Multi-slot Class:</b>	2 Uplink +3 Downlink
<b>Antenna Gain:</b>	1.0 dBi
<b>Antenna Type:</b>	dipole Antenna

### Remark:

1. The sample selected for test was engineering sample that approximated to production product and was provided by manufacturer.
2. This submittal(s) (test report) is intended for **FCC ID: XMR201403GC65** filing to comply with Part 22 and Part 24 of the FCC 47 CFR Rules.



## 3 TEST METHODOLOGY

Both conducted and radiated testing were performed according to the procedures document on chapter 13 of ANSI C63.4: 2003, TIA/EIA-603-C: 2004 and FCC CFR 47, Part 2, PART 22 SUBPART H AND PART 24 SUBPART E

### 3.1. EUT CONFIGURATION

The EUT configuration for testing is installed on RF field strength measurement to meet the Commissions requirement and operating in a manner that intends to maximize its emission characteristics in a continuous normal application.

### 3.2. EUT EXERCISE

The EUT was operated in the engineering mode to fix the TX frequency that was for the purpose of the measurements.

### 3.3. GENERAL TEST PROCEDURES

#### Conducted Emissions

The EUT is placed on the turntable, which is 0.8 m above ground plane. According to the requirements in Section 13.1.4.1 of ANSI C63.4: 2003. Conducted emissions from the EUT measured in the frequency range between 0.15 MHz and 30MHz using CISPR Quasi-peak and average detector modes.

#### RADIATED EMISSIONS

The EUT is placed on a turn table, which is 0.8 m above ground plane. The turntable shall rotate 360 degrees to determine the position of maximum emission level. EUT is set 3m away from the receiving antenna, which varied from 1m to 4m to find out the highest emission. And also, each emission was to be maximized by changing the polarization of receiving antenna both horizontal and vertical. In order to find out the maximum emissions, exploratory radiated emission measurements were made according to the requirements in Section 13.1.4.1 of ANSI C63.4: 2003.

### 3.4. DESCRIPTION OF TEST MODES

The EUT (model:D205) had been tested under operating condition.

After verification, all tests were carried out with the worst case test modes as shown below except radiated spurious emission below 1GHz and power line conducted emissions below 30MHz, which worst case was in normal link mode only.

EUT staying in continuous transmitting mode was programmed.

GSM/GPRS / 850:

Channel Low (CH128), Channel Mid (CH190) and Channel High (CH251) were chosen for full testing.

GSM/GPRS / 1900:

Channel Low (CH512), Channel Mid (CH661) and Channel High (CH810) were chosen for full testing.



## 4 INSTRUMENT CALIBRATION

### 4.1. MEASURING INSTRUMENT CALIBRATION

The measuring equipment, which was utilized in performing the tests documented herein, has been calibrated in accordance with the manufacturer's recommendations for utilizing calibration equipment, which is traceable to recognized national standards.

### 4.2. MEASUREMENT EQUIPMENT USED

Conducted Emissions Test Site				
Name of Equipment	Manufacturer	Model	Serial Number	Calibration Due
Spectrum Analyzer	RS	FSU26	200789	2014-8-19
Detector Negative	Agilent	8473B	MY42240176	2014-5-12
Oscilloscope	Agilent	DSO6104A	MY44002585	2015-3-16
Power Sensor	Agilent	E9327A	US40441788	2015-3-17
Power Meter	Agilent	E4416A	QB41292714	2015-3-17
Power SPLITTER	Mini-Circuits	ZN2PD-9G	SF078500430	N.C.R
DC Power Supply	AGILENT	E3632A	MY50340053	N.C.R
Temp. / Humidity Chamber	TERCHY	MHK-120AK	X30109	2015-1-22
Test Software	EZ-EMC			

977 Chamber				
Name of Equipment	Manufacturer	Model	Serial Number	Calibration Due
Spectrum Analyzer	RS	FSU26	200789	2014-8-19
EMI Test Receiver	R&S	ESPI3	101378	2015-1-22
Pre-Amplifier	MINI	ZFL-1000VH2	070306	2015-1-22
Pre-Amplifier	Miteq	NSP400-NF	N/A	N.C.R
Bilog Antenna	Sunol	JB1	A110204-1	2015-3-7
Horn-antenna	SCHWARZBECK	BBHA9120D	D:267	2015-3-7
TRILOG SUPER BROADBAND TEST ANTENNA	SCHWARZBECK	VULB9160	9160-3342	2015-3-7
TRILOG SUPER BROADBAND TEST ANTENNA	SCHWARZBECK	VULB9160	9160-3343	2015-3-6
Turn Table	CT	CT123	4165	N.C.R
Antenna Tower	CT	CTERG23	3256	N.C.R
Controller	CT	CT100	95637	N.C.R
Test Software	EZ-EMC			



# Compliance Certification Services Inc.

Reference No.: C140328R01-RP1

Report No: C140331R02-RP1

FCC ID: XMR201403GC65

Date of Issue :April 23, 2014

Conducted Emission				
Name of Equipment	Manufacturer	Model	Serial Number	Calibration Due
EMI TEST RECEIVER	R&S	ESCI	100781	2015-3-16
V (V-LISN)	Schwarzbeck	NNLK 8129	8129-143	2014-8-19
LISN (EUT)	FCC	FCC-LISN-50/250-50-2-02	SN:05012	2015-3-16
10dB Attenuation	SCHAFFNER	CFL9206	1710	N.C.R
Test Software	EZ-EMC			

**Remark:** Each piece of equipment is scheduled for calibration once a year.

## 4.3. MEASUREMENT UNCERTAINTY

Where relevant, the following measurement uncertainty levels have been estimated for tests performed on the EUT as specified in CISPR 16-4-2:

Measurement	Frequency		Uncertainty
Conducted emissions	0.15MHz~30MHz		± 3.43 dB
Measurement	Polarity	Frequency	Uncertainty
Radiated emissions (below 1GHz)	H	30MHz ~ 200MHz	+/- 4.72dB
		200MHz ~1000MHz	+/- 4.72dB
	V	30MHz ~ 200MHz	+/- 4.83dB
		200MHz ~1000MHz	+/- 4.70dB
Radiated emissions (above 1GHz)	H	1000MHz ~5000MHz	+/- 3.94dB
		5000MHz ~6000MHz	+/- 3.94dB
	V	1000MHz ~5000MHz	+/- 3.94dB
		5000MHz ~6000MHz	+/- 3.94dB

This uncertainty represents an expanded uncertainty expressed at approximately the 95% confidence level using a coverage factor of k=2.





## 5 FACILITIES AND ACCREDITATIONS

### 5.1. FACILITIES

No.10Weiye Rd, Innovation park, Eco&Tec, Development Zone, Kunshan City, Jiangsu, China.

The sites are constructed in conformance with the requirements of ANSI C63.4 and CISPR Publication 22.

### 5.2. EQUIPMENT

Radiated emissions are measured with one or more of the following types of linearly polarized antennas: tuned dipole, biconical, log periodic, bi-log, and/or ridged waveguide, horn. Spectrum analyzers with pre-selectors and quasi-peak detectors are used to perform radiated measurements.

Conducted emissions are measured with Line Impedance Stabilization Networks and EMI Test Receivers.

Calibrated wideband preamplifiers, coaxial cables, and coaxial attenuators are also used for making measurements.

All receiving equipment conforms to CISPR Publication 16-1, "Radio Interference Measuring Apparatus and Measurement Methods."

### 5.3. ACCREDITATIONS

Our laboratories are accredited and approved by the following accreditation body according to ISO/IEC 17025.

<b>USA</b>	A2LA
<b>China</b>	CNAS

FCC registration number is 238958.

The measuring facility of laboratories has been authorized or registered by the following approval agencies.

<b>Canada</b>	Industry Canada
<b>Japan</b>	VCCI
<b>Taiwan</b>	BSMI
<b>USA</b>	FCC

Copies of granted accreditation certificates are available for downloading from our web site, <http://www.ccsrf.com>



## 6 SETUP OF EQUIPMENT UNDER TEST

### 6.1. SETUP CONFIGURATION OF EUT

See test photographs attached in Appendix I for the actual connections between EUT and support equipment.

### 6.2. SUPPORT EQUIPMENT

No.	Device Type	Brand	Model	FCC ID	Series No.	Data Cable	Power Cord
1	EVB	Quectel	GC65-EVB	N/A	N/A	N/A	N/A

**Remark:**

1. *All the equipment/cables were placed in the worst-case configuration to maximize the emission during the test.*
2. *Grounding was established in accordance with the manufacturer's requirements and conditions for the intended use.*



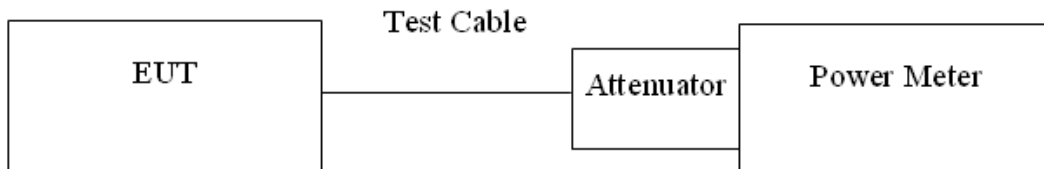
## 7 FCC PART 22 & 24 REQUIREMENTS

### 7.1. PEAK POWER

#### LIMIT

According to FCC §2.1046.

#### Test Configuration



**Remark:** Measurement setup for testing on Antenna connector

#### TEST PROCEDURE

The transmitter output was connected to a calibrated attenuator, the other end of which was connected to a power meter. Transmitter output was read off the power meter in dBm. The power output at the transmitter antenna port was determined by adding the value of the attenuator to the power meter reading.

#### TEST RESULTS

*No non-compliance noted.*

#### Test Data

Test Mode	CH	Frequency (MHz)	Peak Power (dBm)
GSM 850	128	824.40	<b>32.19</b>
	190	836.60	32.17
	251	848.80	32.16
GSM 1900	512	1850.20	28.50
	661	1880.00	28.80
	810	1909.80	<b>29.10</b>



# Compliance Certification Services Inc.

Reference No.: C140328R01-RP1

Report No: C140331R02-RP1

FCC ID: XMR201403GC65

Date of Issue :April 23, 2014

Test Mode		CH	Frequency (MHz)	Peak Power (dBm)
GSM850 (Class10)	1 Uplink +4 Downlink	128	824.40	<b>32.13</b>
		190	836.60	32.11
		251	848.80	32.10
	2 Uplink +3 Downlink	128	824.40	32.06
		190	836.60	32.08
		251	848.80	<b>32.09</b>

Test Mode		CH	Frequency (MHz)	Peak Power (dBm)
GSM19000 (Class10)	1 Uplink +4 Downlink	512	1850.20	28.50
		661	1880.00	28.70
		810	1909.80	<b>29.00</b>
	2 Uplink +3 Downlink	512	1850.20	28.40
		661	1880.00	28.70
		810	1909.80	<b>28.90</b>

**Remark:** The value of factor includes both the loss of cable and external attenuato

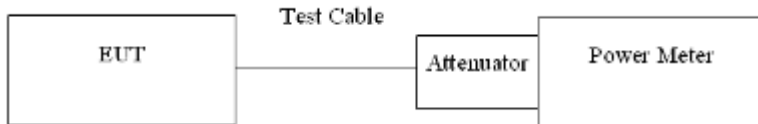


## 7.2. AVERAGE POWER

### LIMIT

For reporting purposes only.

### TEST CONFIGURATION



**Remark:** Measurement setup for testing on Antenna connector

### TEST PROCEDURE

The transmitter output was connected to a calibrated attenuator, the other end of which was connected to a power meter. Transmitter output was read off the power meter in dBm. The power output at the transmitter antenna port was determined by adding the value of the attenuator to the power meter reading.

### TEST RESULTS

*No non-compliance noted.*

#### Test Data

Test Mode	CH	Frequency (MHz)	Average Power (dBm)
GSM 850	128	824.40	<b>32.15</b>
	190	836.60	32.14
	251	848.80	32.13
GSM 1900	512	1850.20	28.30
	661	1880.00	28.60
	810	1909.80	<b>28.90</b>



# Compliance Certification Services Inc.

Reference No.: C140328R01-RP1

Report No: C140331R02-RP1

FCC ID: XMR201403GC65

Date of Issue :April 23, 2014

Test Mode		CH	Frequency (MHz)	Average Power (dBm)
GSM850 (Class10)	1 Uplink +4 Downlink	128	824.40	<b>32.09</b>
		190	836.60	32.07
		251	848.80	32.08
	2 Uplink +3 Downlink	128	824.40	32.03
		190	836.60	32.04
		251	848.80	<b>32.07</b>

Test Mode		CH	Frequency (MHz)	Average Power (dBm)
GSM19000 (Class10)	1 Uplink +4 Downlink	512	1850.20	28.30
		661	1880.00	28.60
		810	1909.80	<b>28.80</b>
	2 Uplink +3 Downlink	512	1850.20	28.30
		661	1880.00	28.50
		810	1909.80	<b>28.70</b>

**Remark:** The value of factor includes both the loss of cable and external attenuator



## 7.3. ERP & EIRP MEASUREMENT

### LIMIT

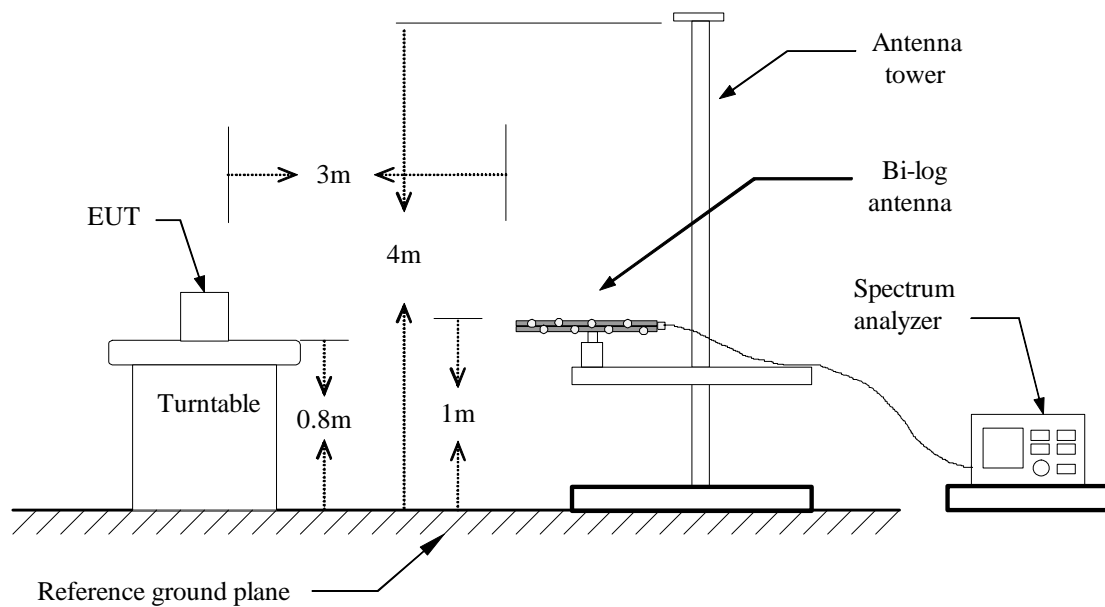
According to FCC §2.1046

FCC 22.913(a): The Effective Radiated Power (ERP) of mobile transmitters must not exceed 7 Watts.

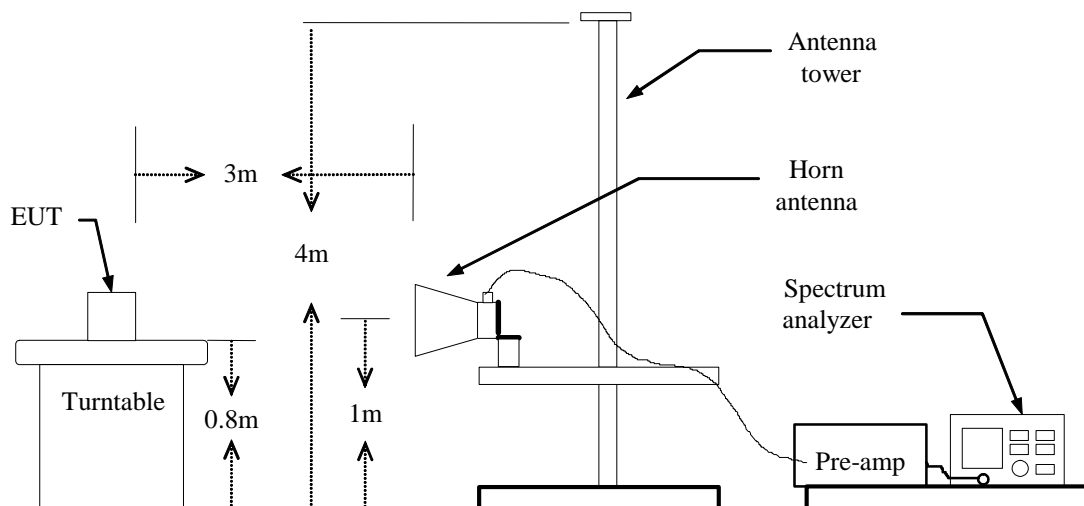
FCC 24.232(b): The equivalent Isotropic Radiated Power (EIRP) must not exceed 2 Watts.

### TEST CONFIGURATION

#### Below 1 GHz

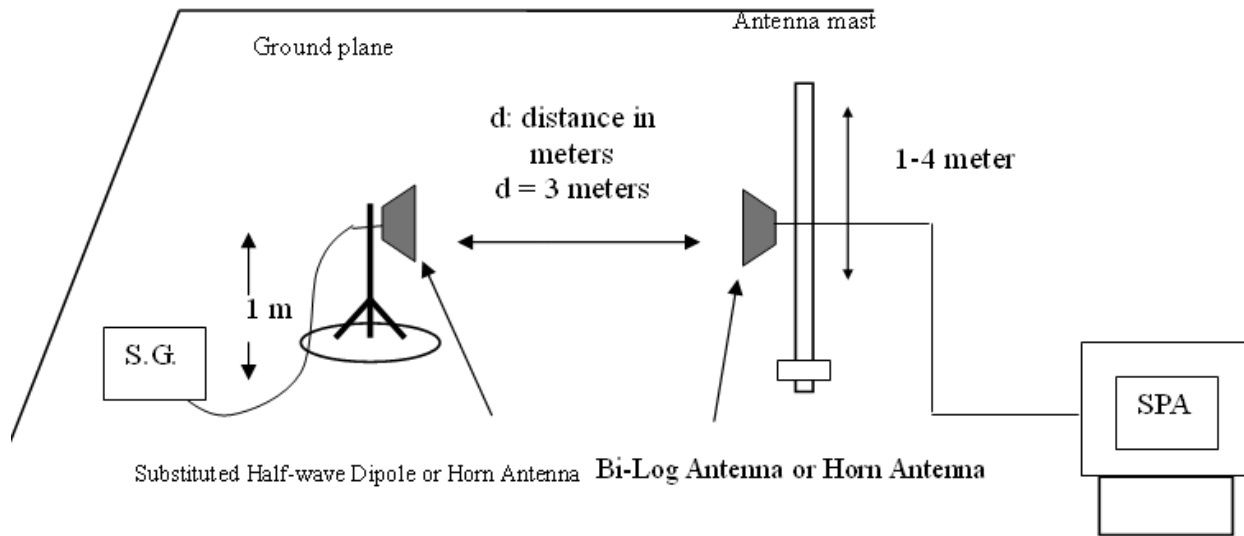


#### Above 1 GHz





## FOR SUBSTITUTED METHOD TEST SET-UP



## TEST PROCEDURE

The EUT was placed on a non-conductive turntable using a non-conductive support. The radiated emission at the fundamental frequency was measured at 3 m with a test antenna and EMI spectrum analyzer.

During the measurement of the EUT, the resolution bandwidth was set to 3MHz and the average bandwidth was set to 3MHz. The highest emission was recorded with the rotation of the turntable and the lowering of the test antenna. The reading was recorded and the field strength (E in dBuV/m) was calculated.

ERP in frequency band 824-849MHz, and EIRP in frequency band 1851.25 –1910MHz were measured using a substitution method. The EUT was replaced by half-wave dipole (824-849MHz) or horn antenna (1851.25-1910MHz) connected to a signal generator. The spectrum analyzer reading was recorded and ERP/EIRP was calculated as follows:

$$\text{ERP} = \text{S.G. output (dBm)} + \text{Antenna Gain (dBd)} - \text{Cable (dB)}$$

$$\text{EIRP} = \text{S.G. output (dBm)} + \text{Antenna Gain (dBi)} - \text{Cable (dB)}$$

## TEST RESULTS

*No non-compliance noted.*





# Compliance Certification Services Inc.

Reference No.: C140328R01-RP1

Report No: C140331R02-RP1

FCC ID: XMR201403GC65

Date of Issue :April 23, 2014

## GSM 850 TEST DATA

Channel	Frequency (MHz)	Antenna Pol.	Reading level (dB)	Correction Factor (dB)	Emission level (dBm)	Limit (dBm)	Margin (dB)
128	824.23	V	30.84	-1.58	29.26	38.50	-9.24
	824.20	H	28.97	-1.69	27.28	38.50	-11.22
190	836.65	V	30.88	-1.56	29.32	38.50	-9.18
	836.59	H	28.96	-1.73	27.23	38.50	-11.27
251	848.83	V	30.55	-1.54	29.01	38.50	-9.49
	848.77	H	28.95	-1.72	27.23	38.50	-11.27

## GSM 1900 TEST DATA

Channel	Frequency (MHz)	Antenna Pol.	Reading level (dB)	Correction Factor (dB)	Emission level (dBm)	Limit (dBm)	Margin (dB)
512	1850.11	V	25.68	-0.27	25.41	33.00	-7.59
	1850.18	H	24.62	-0.65	23.97	33.00	-9.03
661	1880.00	V	25.32	0.06	25.38	33.00	-7.62
	1879.93	H	24.75	-0.25	24.50	33.00	-8.50
810	1909.75	V	25.79	0.23	26.02	33.00	-6.98
	1909.75	H	24.41	-0.04	24.37	33.00	-8.63

## GPRS 850 TEST DATA

Channel	Frequency (MHz)	Antenna Pol.	Reading level (dB)	Correction Factor (dB)	Emission level (dBm)	Limit (dBm)	Margin (dB)
128	824.26	V	30.88	-1.58	29.30	38.50	-9.20
	824.26	H	29.09	-1.69	27.40	38.50	-11.10
190	836.56	V	30.92	-1.56	29.36	38.50	-9.14
	836.56	H	29.12	-1.73	27.39	38.50	-11.11
251	848.77	V	30.49	-1.54	28.95	38.50	-9.55
	848.77	H	28.99	-1.72	27.27	38.50	-11.23



# Compliance Certification Services Inc.

Reference No.: C140328R01-RP1

Report No: C140331R02-RP1

FCC ID: XMR201403GC65

Date of Issue :April 23, 2014

## GPRS 1900 TEST DATA

Channel	Frequency (MHz)	Antenna Pol.	Reading level (dB)	Correction Factor (dB)	Emission level (dBm)	Limit (dBm)	Margin (dB)
512	1850.25	V	25.69	-0.27	25.42	33.00	-7.58
	1850.25	H	24.55	-0.65	23.90	33.00	-9.10
661	1880.07	V	26.02	0.06	26.08	33.00	-6.92
	1880.00	H	24.32	-0.25	24.07	33.00	-8.93
810	1909.75	V	25.79	0.23	26.02	33.00	-6.98
	1909.68	H	24.14	-0.04	24.10	33.00	-8.90

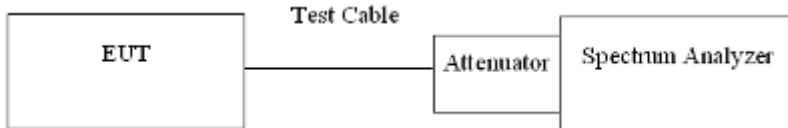


## 7.4. OCCUPIED BANDWIDTH MEASUREMENT

### LIMIT

According to §FCC 2.1049.

### TEST CONFIGURATION



**Remark:** Measurement setup for testing on Antenna connector

### TEST PROCEDURE

The EUT's output RF connector was connected with a short cable to the spectrum analyzer, RBW was set to about 1% ~5% of emission BW, VBW is set to 3 times the RBW, -26dBc display line was placed on the screen (or 99% bandwidth), the occupied bandwidth is the delta frequency between the two points where the display line intersects the signal trace.

### TEST RESULTS

*No non-compliance noted*

#### Test Data

Test Mode	CH	Frequency (MHz)	99% Bandwidth (kHz)	26dB Bandwidth KHz
GSM 850	128	824.40	243.590	314.103
	190	836.60	240.385	310.897
	251	848.80	233.974	314.103
GSM 850	128	824.40	240.385	320.513
	190	836.60	240.385	314.103
	251	848.80	237.179	317.308

Test Mode	CH	Frequency (MHz)	99% Bandwidth (kHz)	26dB Bandwidth KHz
GSM 1900	512	1850.20	243.590	317.308
	661	1880.00	246.795	310.897
	810	1909.80	246.795	320.513
GPRS 1900	512	1850.20	240.385	317.308
	661	1880.00	243.590	323.718
	810	1909.80	240.385	314.103



# Compliance Certification Services Inc.

Reference No.: C140328R01-RP1

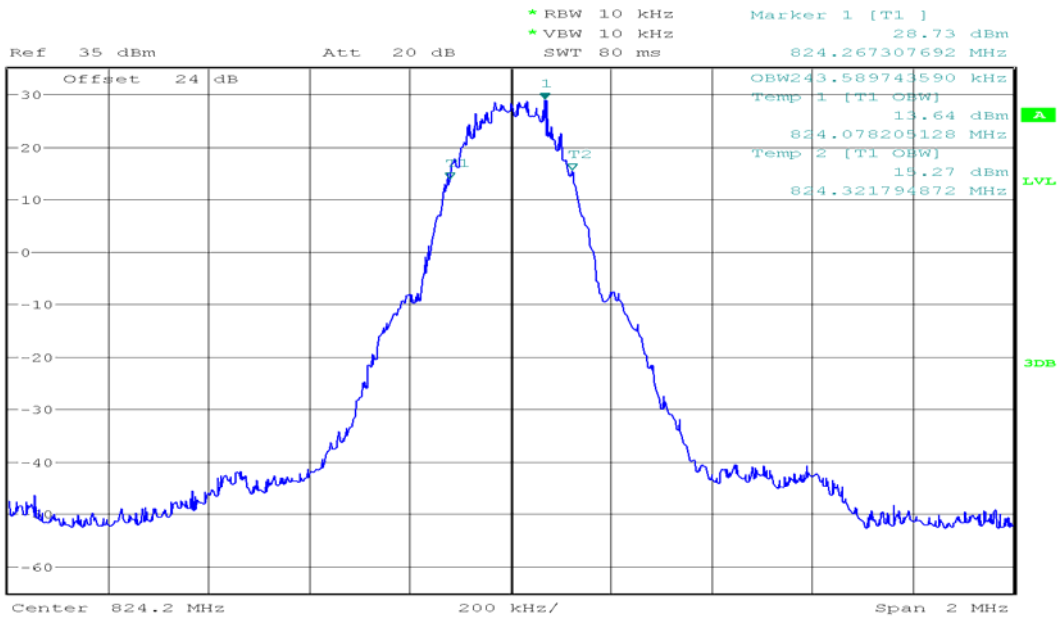
Report No: C140331R02-RP1

FCC ID: XMR201403GC65

Date of Issue :April 23, 2014

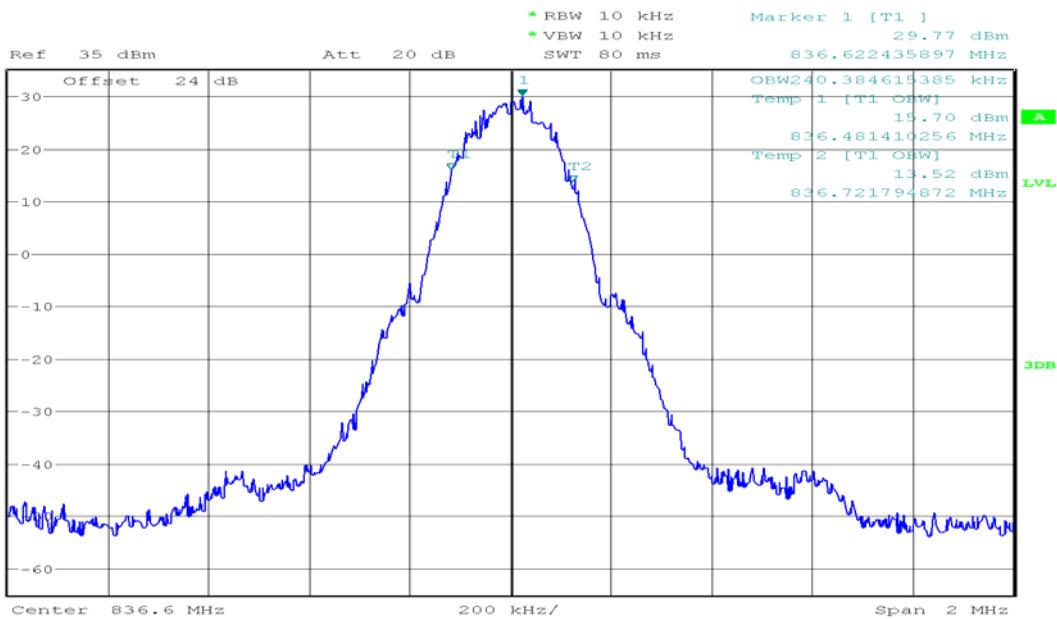
## Test Plot

### 99% Bandwidth GSM 850 (CH Low)



Date: 18.APR.2014 18:37:47

### 99% Bandwidth GSM 850 (CH Mid)



Date: 18.APR.2014 18:36:55



# Compliance Certification Services Inc.

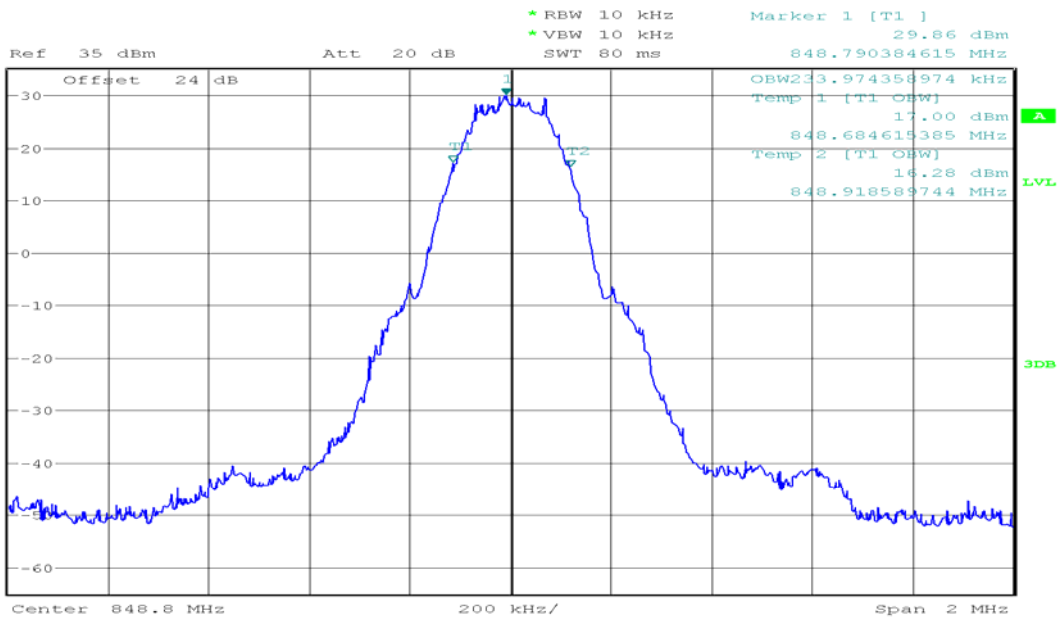
Reference No.: C140328R01-RP1

Report No: C140331R02-RP1

FCC ID: XMR201403GC65

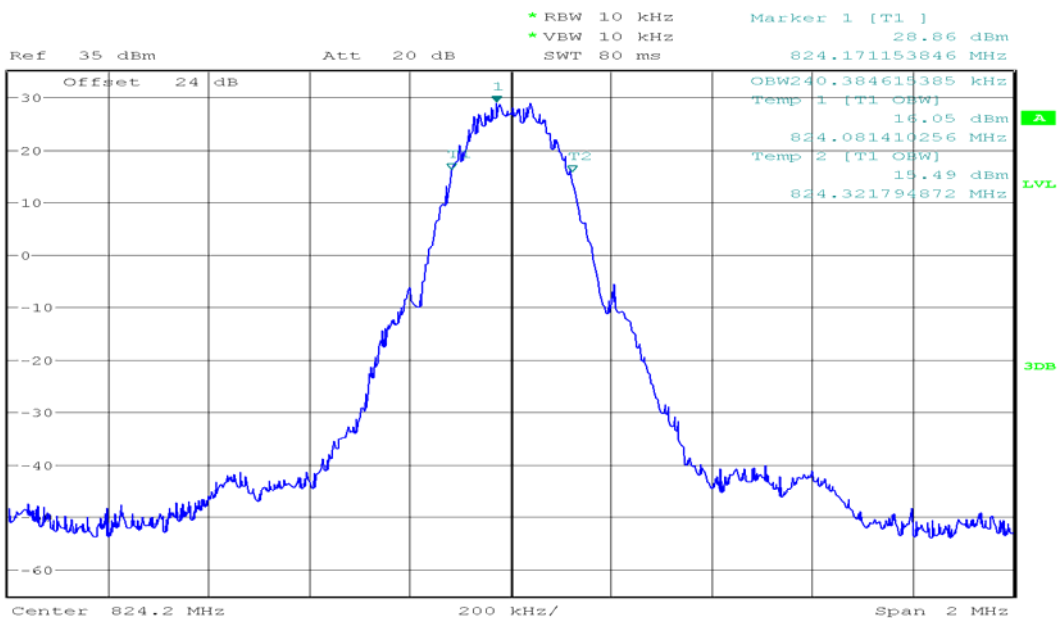
Date of Issue :April 23, 2014

## 99% Bandwidth GSM 850(CH High)



Date: 18.APR.2014 18:36:09

## 99% Bandwidth GPRS 850 (CH Low)



Date: 18.APR.2014 18:39:01



# Compliance Certification Services Inc.

Reference No.: C140328R01-RP1

Report No: C140331R02-RP1

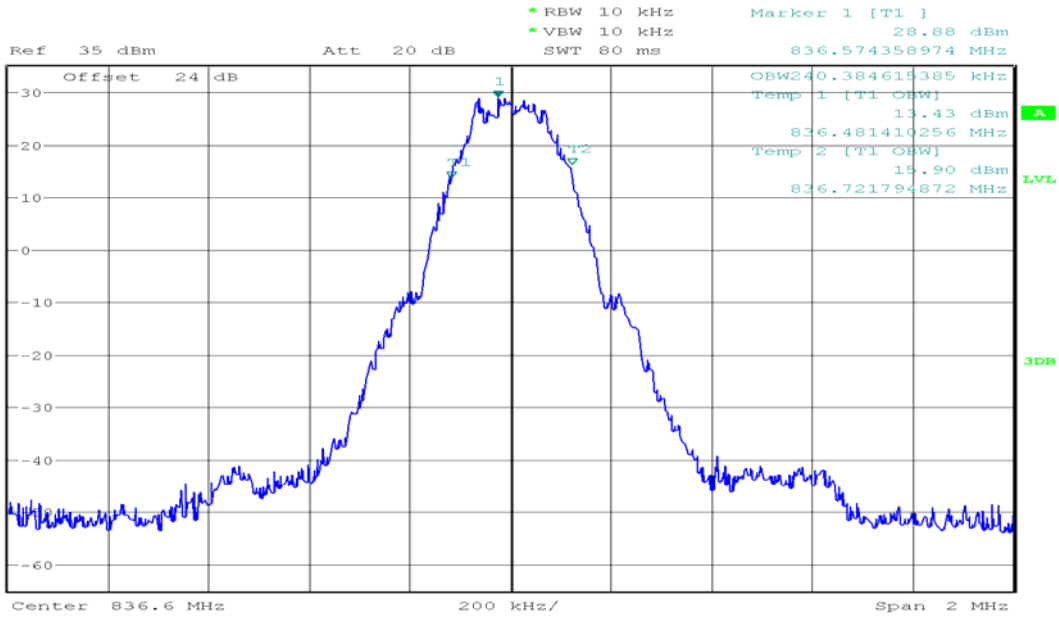
FCC ID: XMR201403GC65

Date of Issue :April 23, 2014

## 99% Bandwidth GPRS 850 (CH Mid)



1 PK  
MAXH

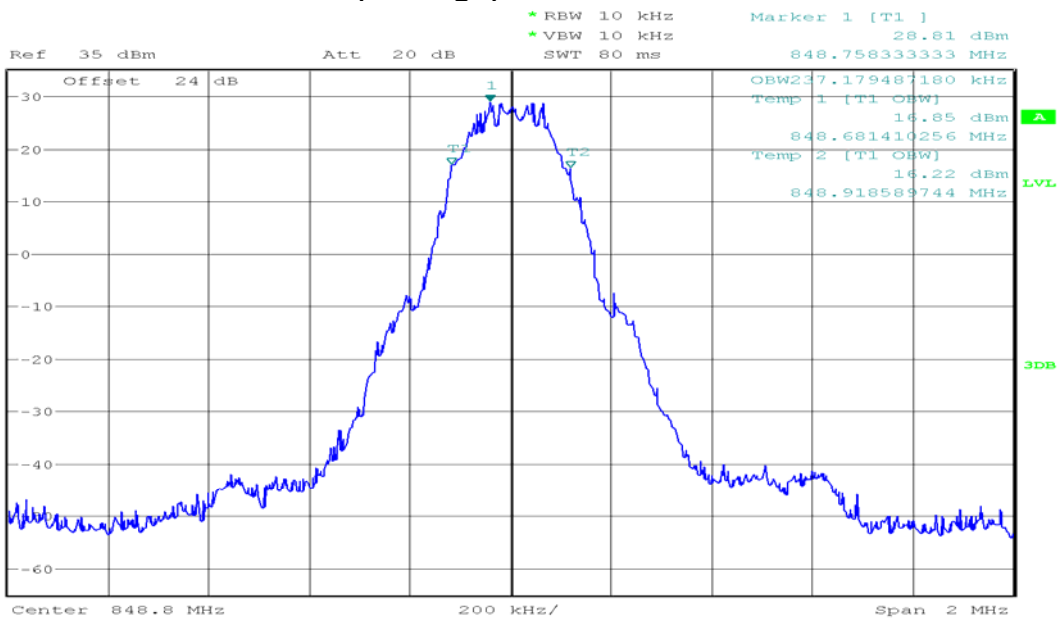


Date: 18.APR.2014 18:39:35

## 99% Bandwidth GPRS 850(CH High)



1 PK  
MAXH



Date: 18.APR.2014 18:40:11



# Compliance Certification Services Inc.

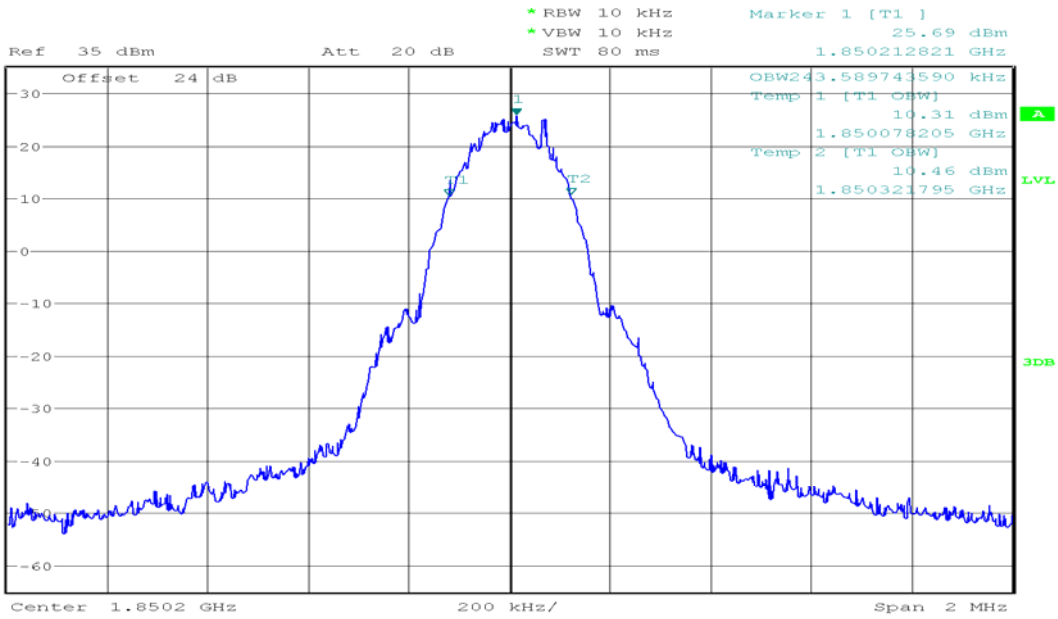
Reference No.: C140328R01-RP1

Report No: C140331R02-RP1

FCC ID: XMR201403GC65

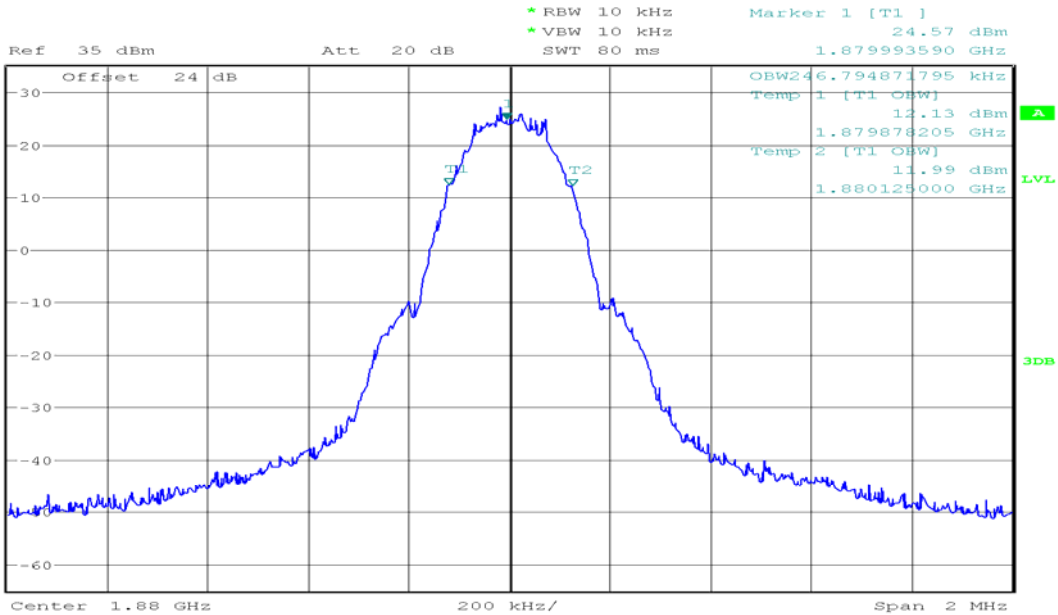
Date of Issue :April 23, 2014

## 99% Bandwidth GSM 1900 (CH Low)



Date: 18.APR.2014 18:41:24

## 99% Bandwidth GSM 1900 (CH Mid)



Date: 18.APR.2014 18:43:52



# Compliance Certification Services Inc.

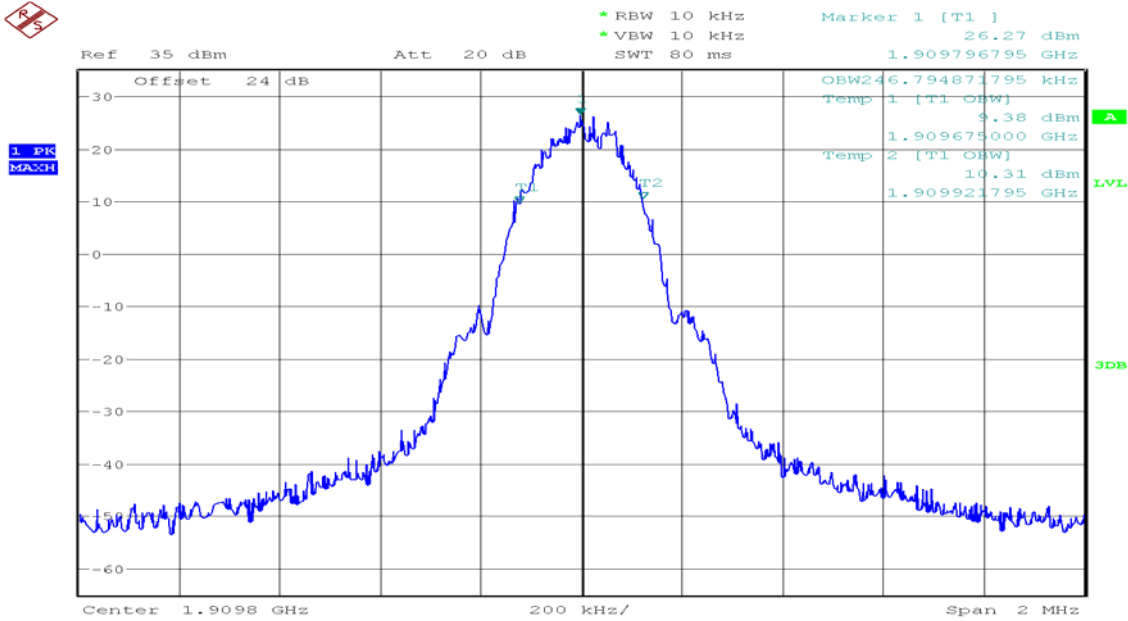
Reference No.: C140328R01-RP1

Report No: C140331R02-RP1

FCC ID: XMR201403GC65

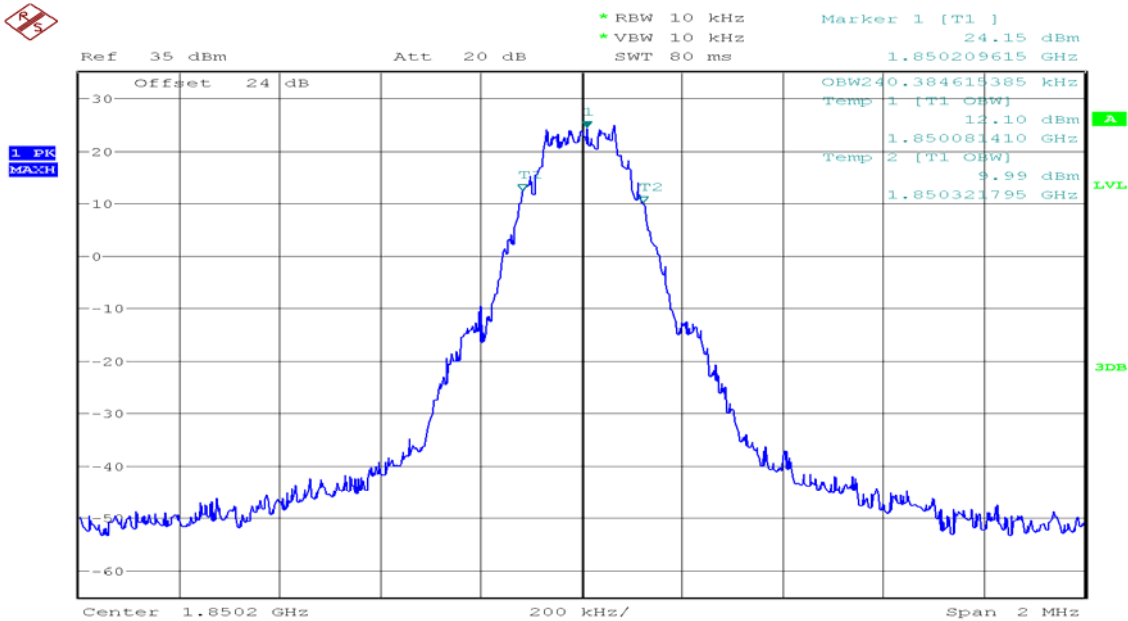
Date of Issue :April 23, 2014

## 99% Bandwidth GSM 1900 (CH High)



Date: 18.APR.2014 18:44:36

## 99% Bandwidth GPRS 1900 (CH Low)



Date: 18.APR.2014 18:49:10





# Compliance Certification Services Inc.

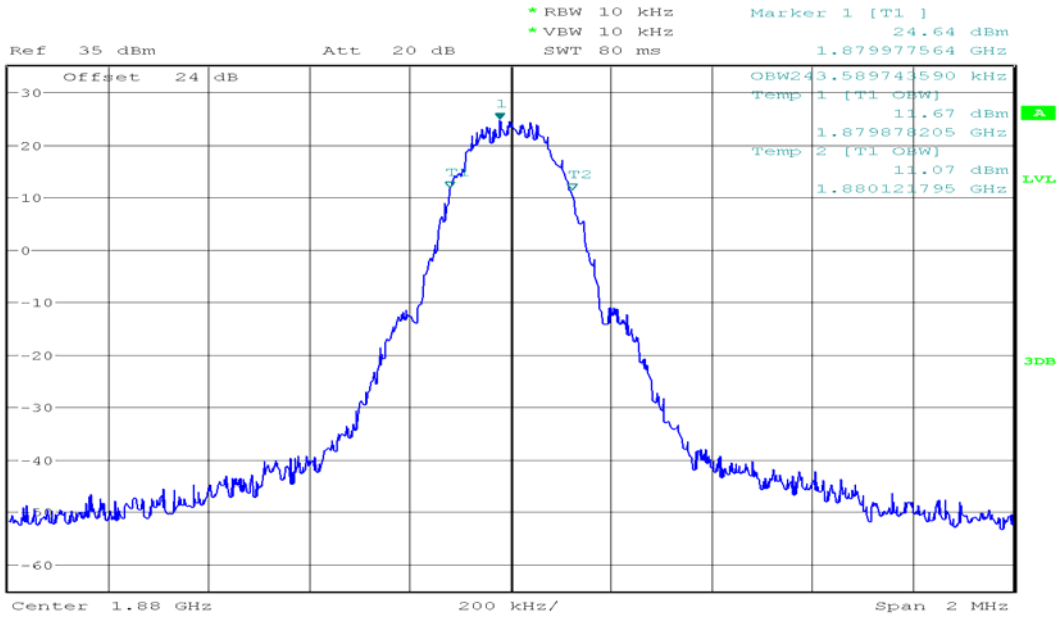
Reference No.: C140328R01-RP1

Report No: C140331R02-RP1

FCC ID: XMR201403GC65

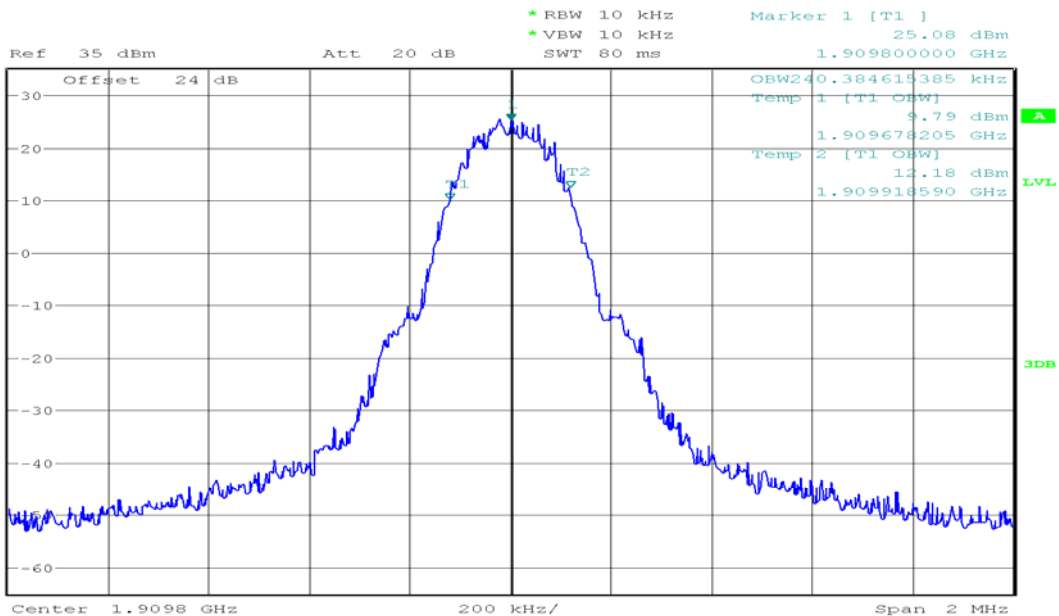
Date of Issue :April 23, 2014

## 99% Bandwidth GPRS 1900 (CH Mid)



Date: 18.APR.2014 18:48:25

## 99% Bandwidth GPRS 1900 (CH High)



Date: 18.APR.2014 18:47:51



# Compliance Certification Services Inc.

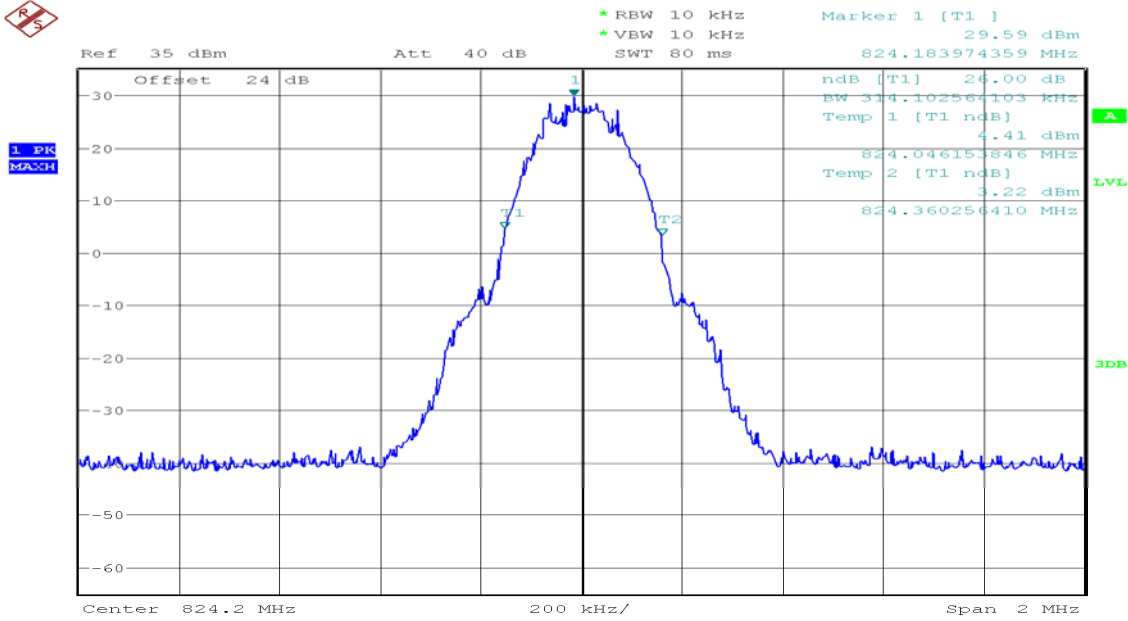
Reference No.: C140328R01-RP1

Report No: C140331R02-RP1

FCC ID: XMR201403GC65

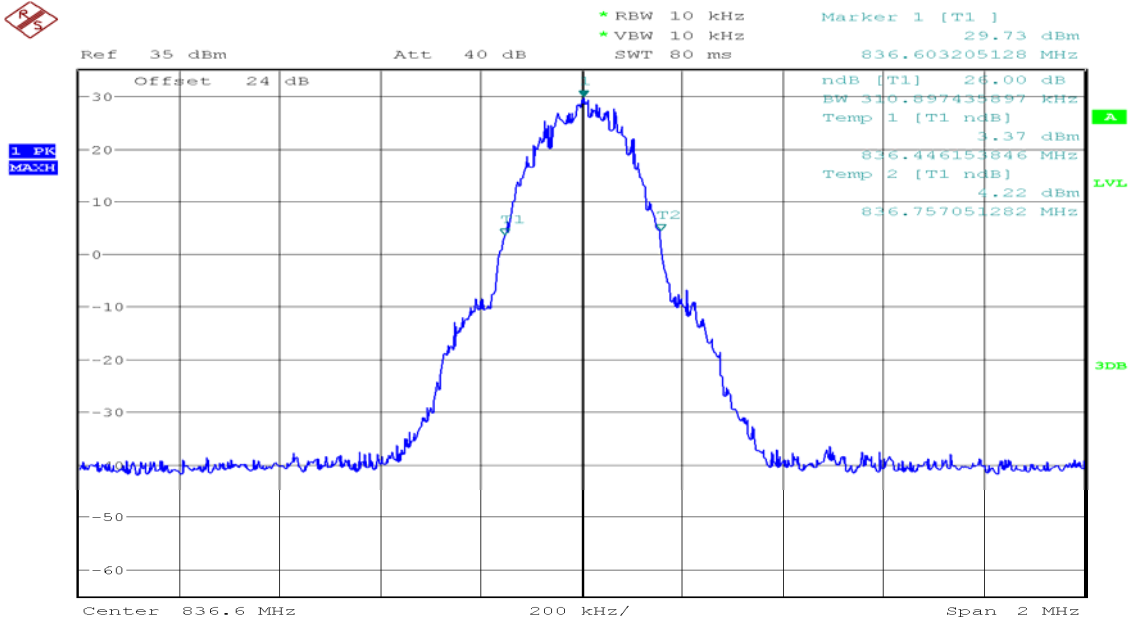
Date of Issue :April 23, 2014

## 26dB Bandwidth GSM 850 (CH Low)



Date: 18.APR.2014 18:58:58

## 26dB Bandwidth GSM 850 (CH Mid)



Date: 18.APR.2014 18:59:33



# Compliance Certification Services Inc.

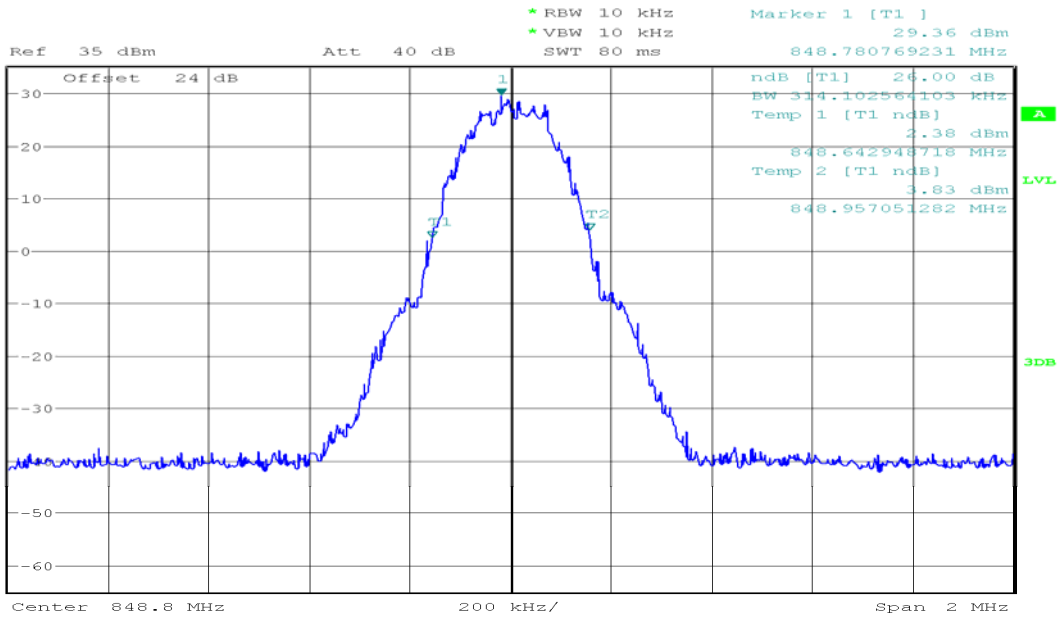
Reference No.: C140328R01-RP1

Report No: C140331R02-RP1

FCC ID: XMR201403GC65

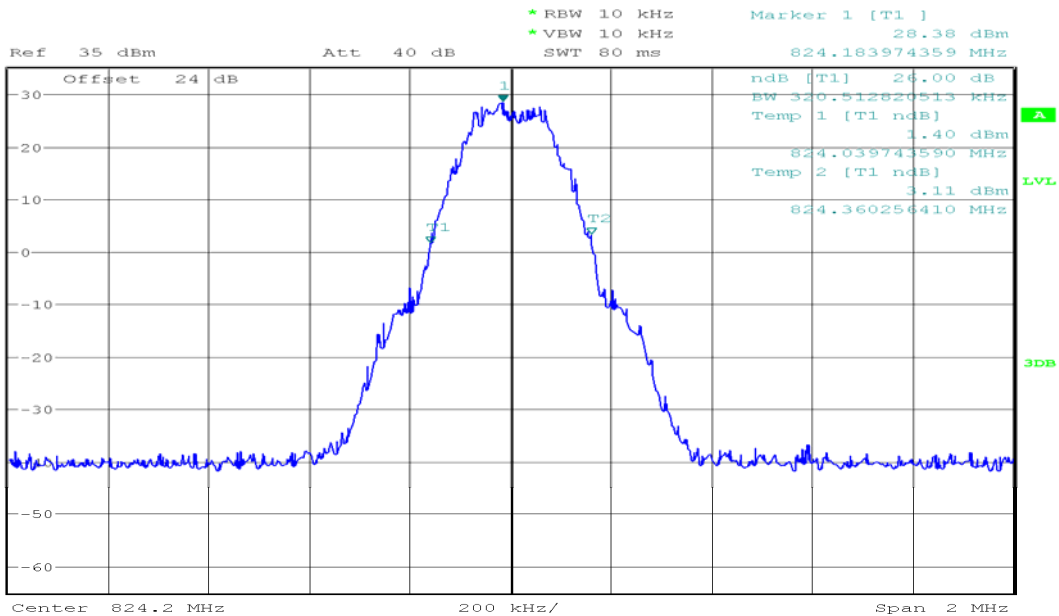
Date of Issue :April 23, 2014

## 26dB Bandwidth GSM 850(CH High)



Date: 18.APR.2014 19:01:03

## 26dB Bandwidth GPRS 850 (CH Low)



Date: 18.APR.2014 19:03:14



# Compliance Certification Services Inc.

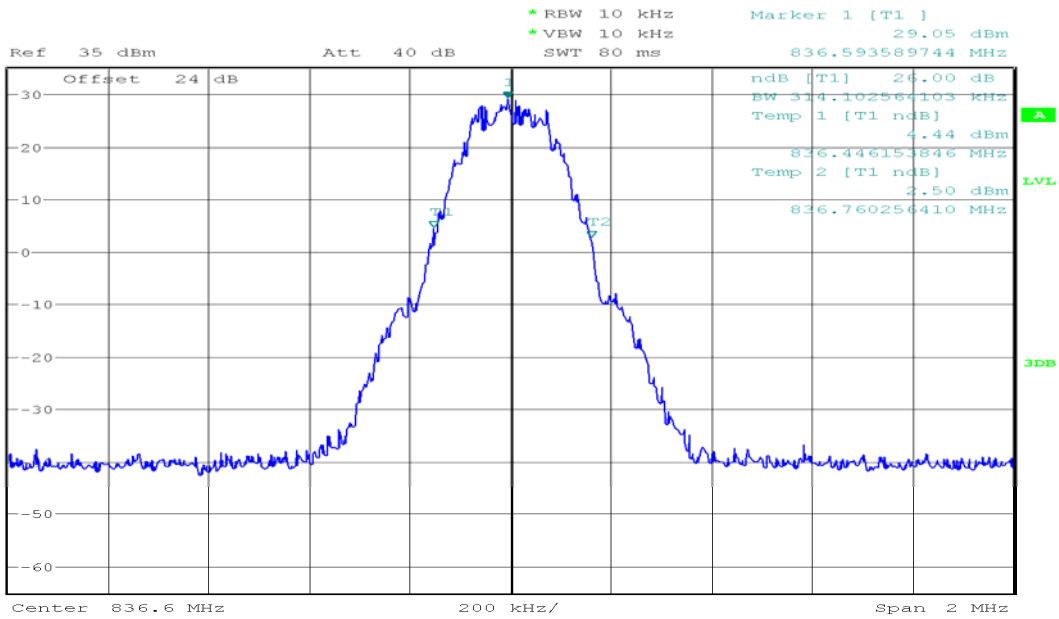
Reference No.: C140328R01-RP1

Report No: C140331R02-RP1

FCC ID: XMR201403GC65

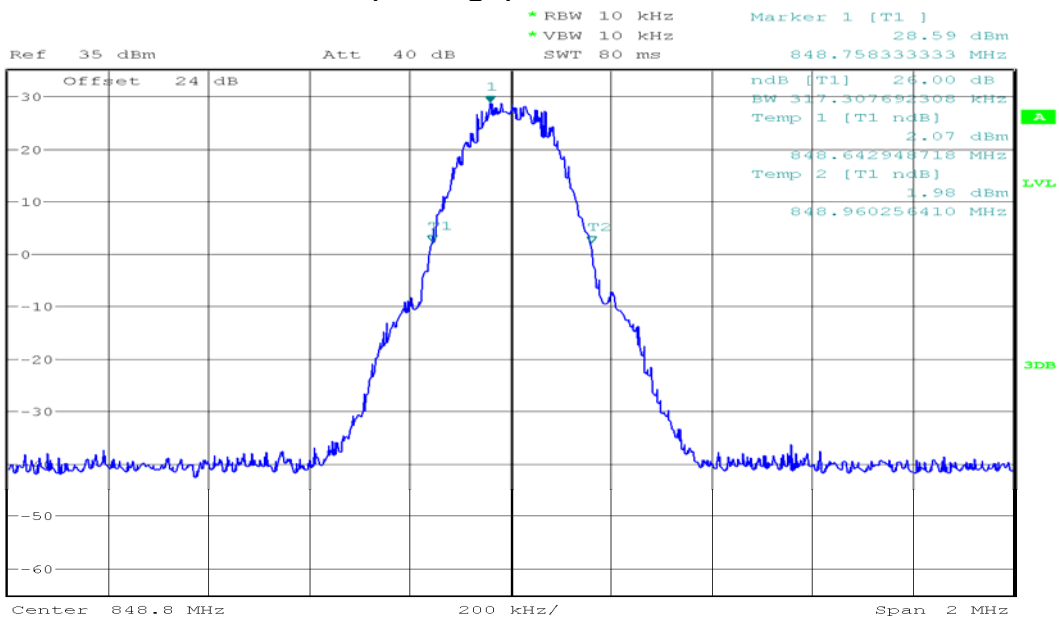
Date of Issue :April 23, 2014

## 26dB Bandwidth GPRS 850 (CH Mid)



Date: 18.APR.2014 19:02:41

## 26dB Bandwidth GPRS 850(CH High)



Date: 18.APR.2014 19:02:09



# Compliance Certification Services Inc.

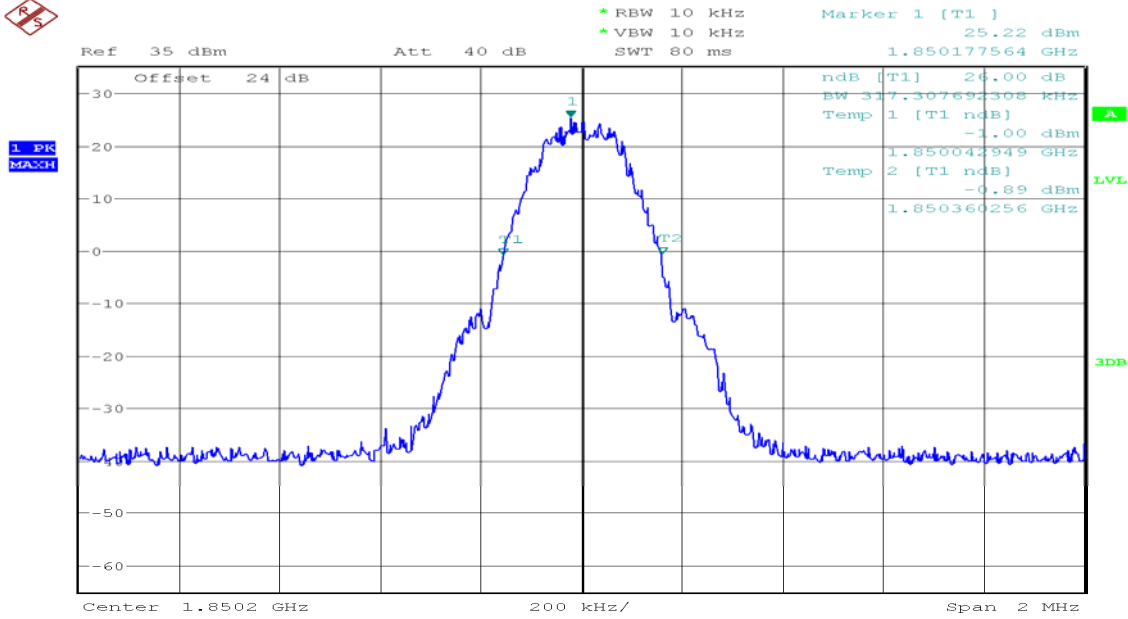
Reference No.: C140328R01-RP1

Report No: C140331R02-RP1

FCC ID: XMR201403GC65

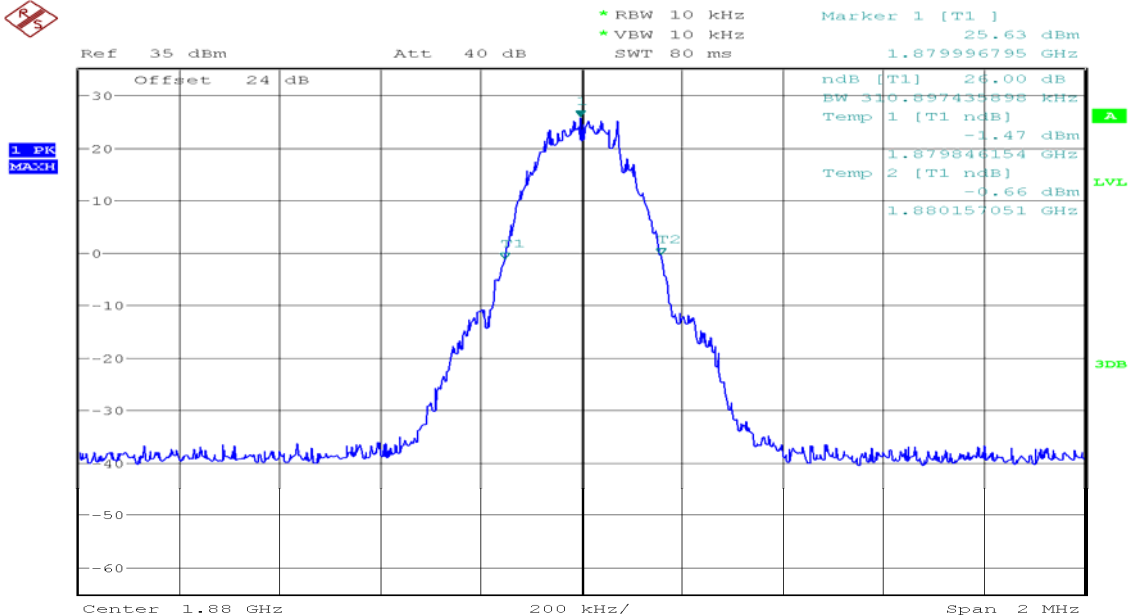
Date of Issue :April 23, 2014

## 26dB Bandwidth GSM 1900 (CH Low)



Date: 18.APR.2014 18:54:55

## 26dB Bandwidth GSM 1900 (CH Mid)



Date: 18.APR.2014 18:54:22



# Compliance Certification Services Inc.

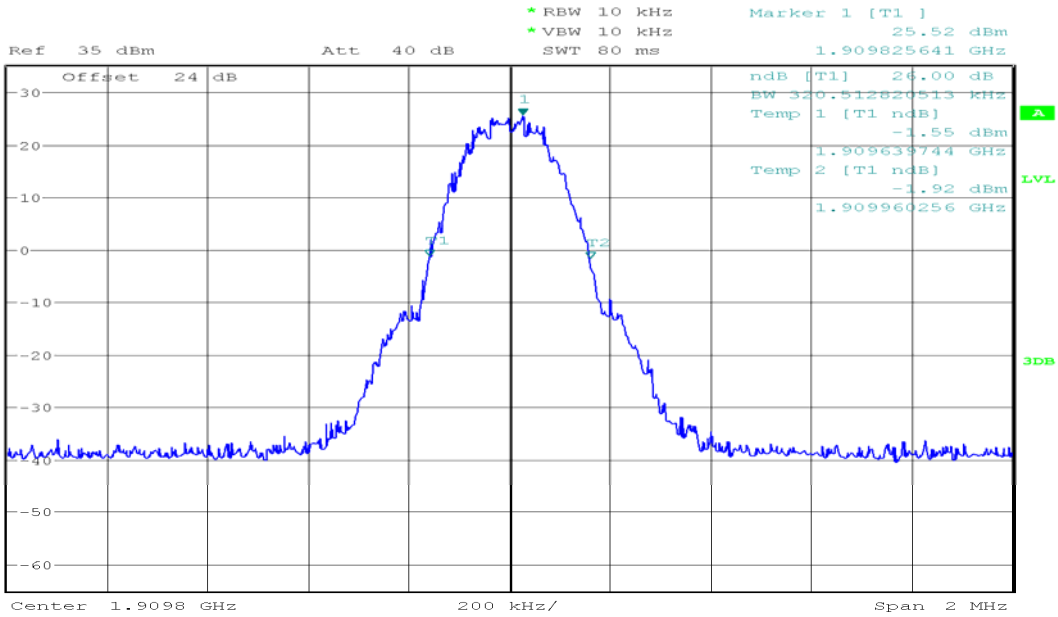
Reference No.: C140328R01-RP1

Report No: C140331R02-RP1

FCC ID: XMR201403GC65

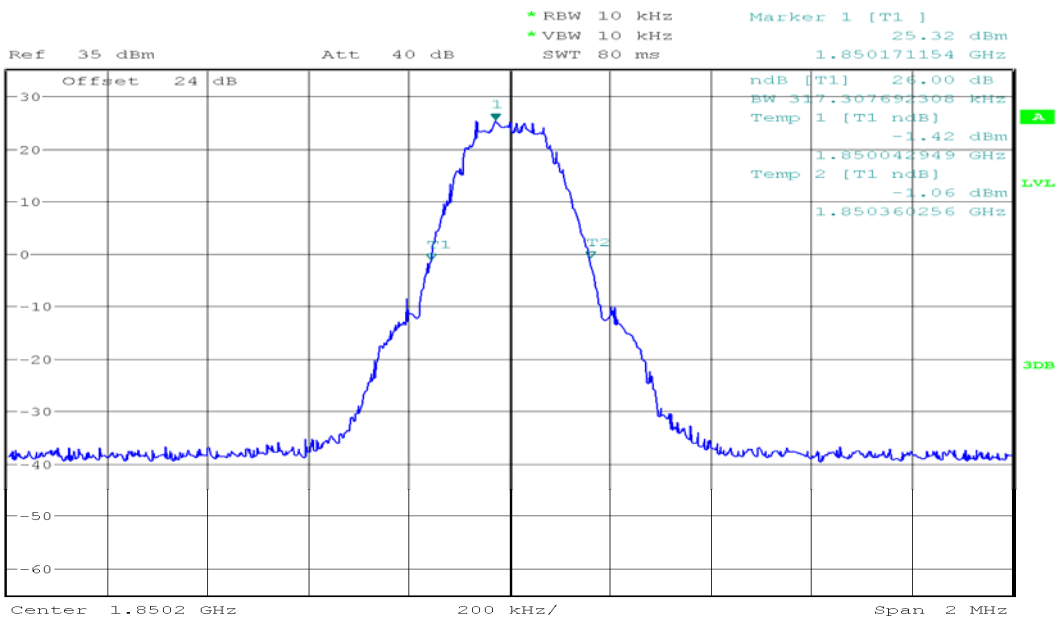
Date of Issue :April 23, 2014

## 26dB Bandwidth GSM 1900 (CH High)



Date: 18.APR.2014 18:53:47

## 26dB Bandwidth GPRS 1900 (CH Low)



Date: 18.APR.2014 18:51:14



# Compliance Certification Services Inc.

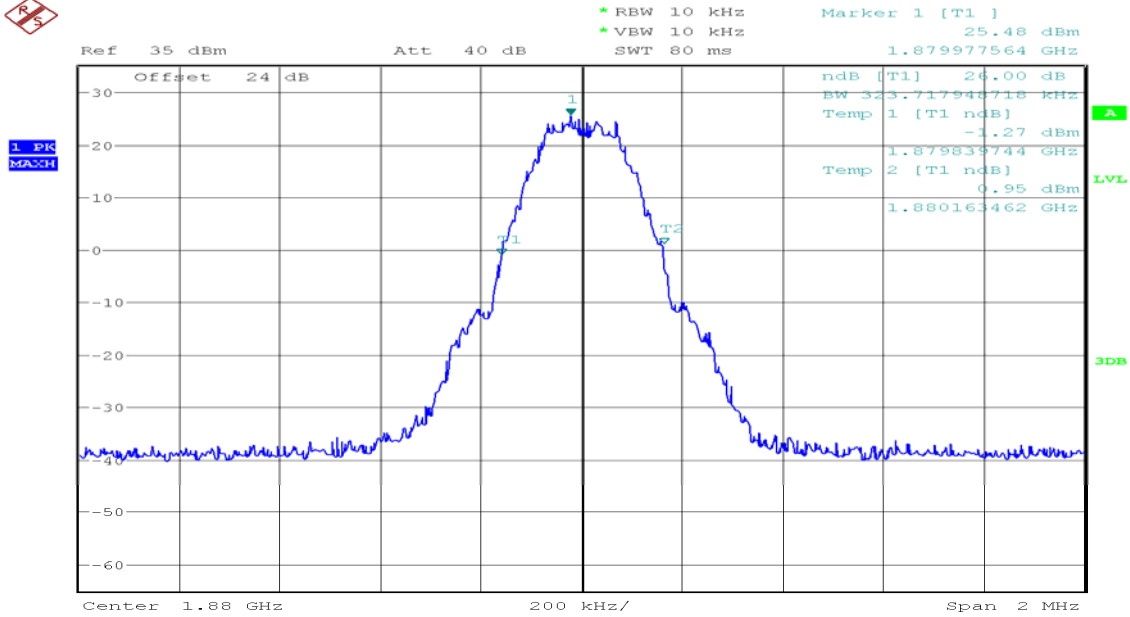
Reference No.: C140328R01-RP1

Report No: C140331R02-RP1

FCC ID: XMR201403GC65

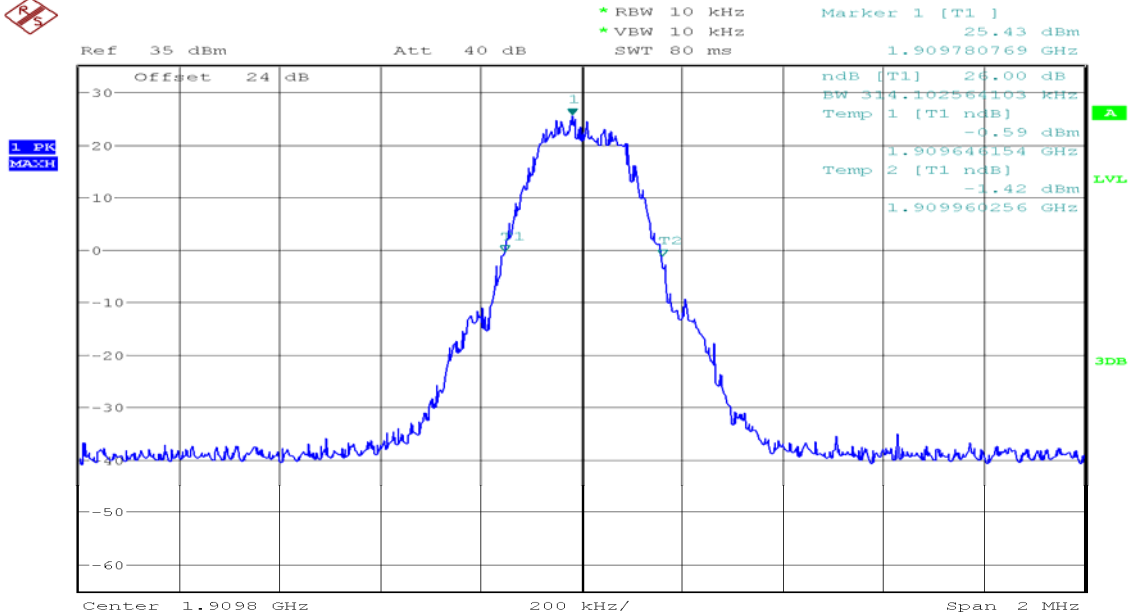
Date of Issue :April 23, 2014

## 26dB Bandwidth GPRS 1900 (CH Mid)



Date: 18.APR.2014 18:52:03

## 26dB Bandwidth GPRS 1900 (CH High)



Date: 18.APR.2014 18:52:42



## 7.5. OUT OF BAND EMISSION AT ANTENNA TERMINALS

### LIMIT

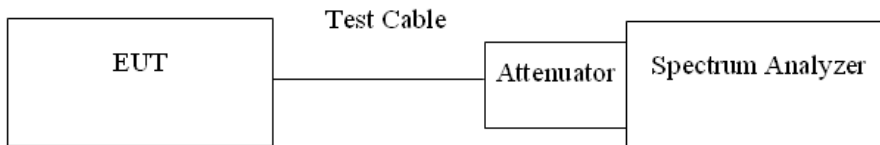
According to FCC §2.1051, FCC §22.917, FCC §24.238(a).

**Out of Band Emissions:** The mean power of emission must be attenuated below the mean power of the non-modulated carrier (P) on any frequency twice or more than twice the fundamental frequency by at least  $43 + 10 \log P$  dB.

**Mobile Emissions in Base Frequency Range:** The mean power of any emissions appearing in the base station frequency range from cellular mobile transmitters operated must be attenuated to a level not exceed  $-80$  dBm at the transmit antenna connector.

**Band Edge Requirements:** In the 1MHz bands immediately outside and adjacent to the frequency block, a resolution bandwidth of at least 1% of the emission bandwidth of the fundamental emission of the transmitter may be employed to measure the Out of band Emission

### TEST CONFIGURATION



### TEST PROCEDURE

The RF output of the transceiver was connected to a spectrum analyzer through appropriate attenuation. The resolution bandwidth of the spectrum analyzer was set at 1MHz, sufficient scans were taken to show the out of band Emissions if any up to 10th harmonic.

For the out of band: Set the RBW, VBW = 1MHz, Start=30MHz, Stop= 10 th harmonic. Limit = -13dBm

Band Edge Requirements (824 MHz and 849 MHz /1850MHz and 1910MHz): In the 1 MHz bands immediately outside and adjacent to the frequency block, a resolution bandwidth of at least 1 percent of the emission bandwidth of the fundamental emission of the transmitter may be employed to measure the out of band Emissions. Limit, -13dBm.

### TEST RESULTS

*No non-compliance noted.*





# Compliance Certification Services Inc.

Reference No.: C140328R01-RP1

Report No: C140331R02-RP1

FCC ID: XMR201403GC65

Date of Issue :April 23, 2014

## Test Data

Mode	CH	Location	Description
GSM 850	128	Figure 3-1	Band Edge emissions
	251	Figure 3-2	Band Edge emissions

Mode	CH	Location	Description
GSM 1900	512	Figure 4-1	Band Edge emissions
	810	Figure 4-2	Band Edge emissions

Mode	CH	Location	Description
GSM 850	128	Figure 5-1	Conducted spurious emissions, 30MHz - 20GHz
	190	Figure 5-2	Conducted spurious emissions, 30MHz - 20GHz
	251	Figure 5-3	Conducted spurious emissions, 30MHz - 20GHz

Mode	CH	Location	Description
GSM 1900	512	Figure 6-1	Conducted spurious emissions, 30MHz - 20GHz
	661	Figure 6-2	Conducted spurious emissions, 30MHz - 20GHz
	810	Figure 6-3	Conducted spurious emissions, 30MHz - 20GHz

Mode	CH	Location	Description
GPRS 850	128	Figure 7-1	Conducted spurious emissions, 30MHz - 20GHz
	190	Figure 7-2	Conducted spurious emissions, 30MHz - 20GHz
	251	Figure 7-3	Conducted spurious emissions, 30MHz - 20GHz

Mode	CH	Location	Description
GPRS 1900	512	Figure 8-1	Conducted spurious emissions, 30MHz - 20GHz
	661	Figure 8-2	Conducted spurious emissions, 30MHz - 20GHz
	810	Figure 8-3	Conducted spurious emissions, 30MHz - 20GHz



# Compliance Certification Services Inc.

Reference No.: C140328R01-RP1

Report No: C140331R02-RP1

FCC ID: XMR201403GC65

Date of Issue :April 23, 2014

Mode	CH	Location	Description
GPRS 850	128	Figure 9-1	Band Edge emissions
	251	Figure 9-2	Band Edge emissions

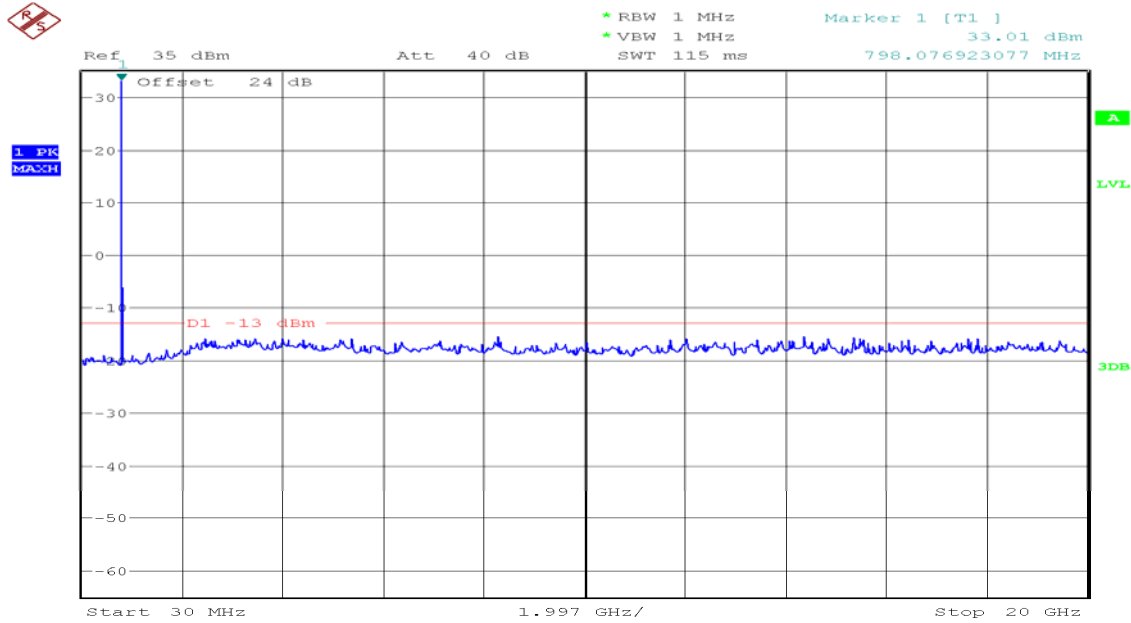
Mode	CH	Location	Description
GPRS 1900	512	Figure 10-1	Band Edge emissions
	810	Figure 10-2	Band Edge emissions



## Test Plot

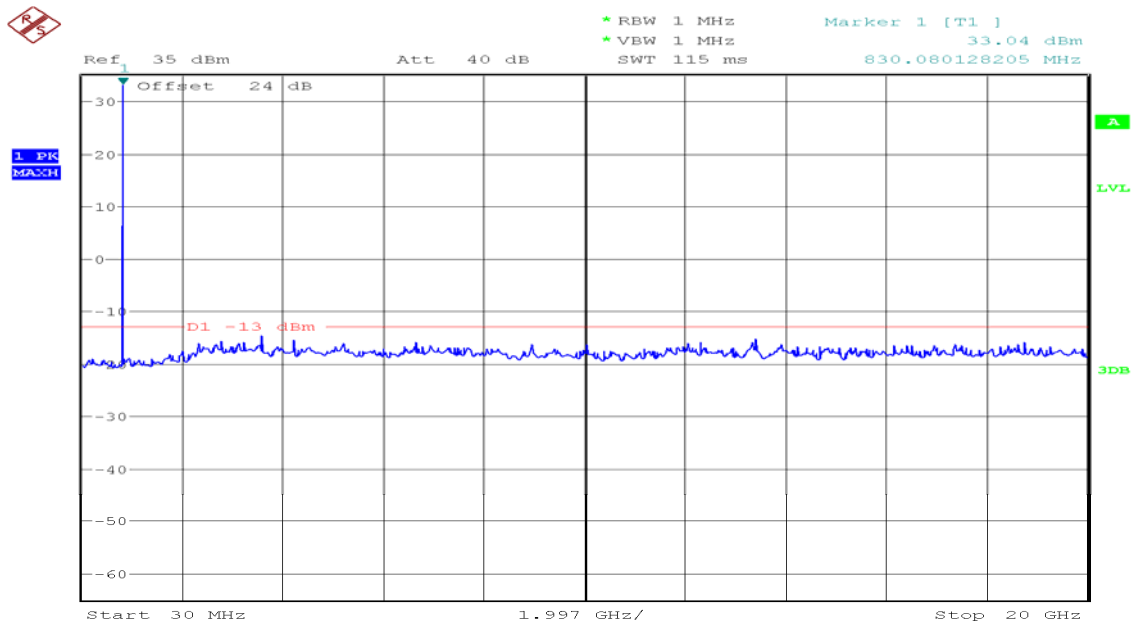
### GSM 850

Figure 5-1: Out of Band emission at antenna terminals – GSM CH Low



Date: 18.APR.2014 18:32:09

Figure 5-2: Out of Band emission at antenna terminals – GSM CH Mid



Date: 18.APR.2014 18:32:36



# Compliance Certification Services Inc.

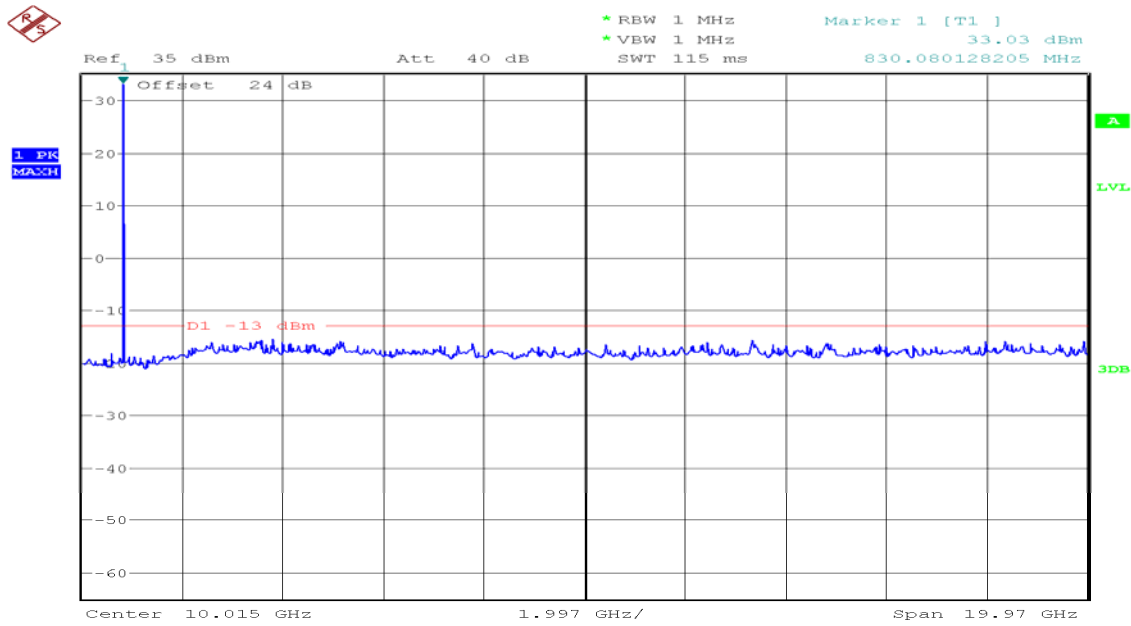
Reference No.: C140328R01-RP1

Report No: C140331R02-RP1

FCC ID: XMR201403GC65

Date of Issue :April 23, 2014

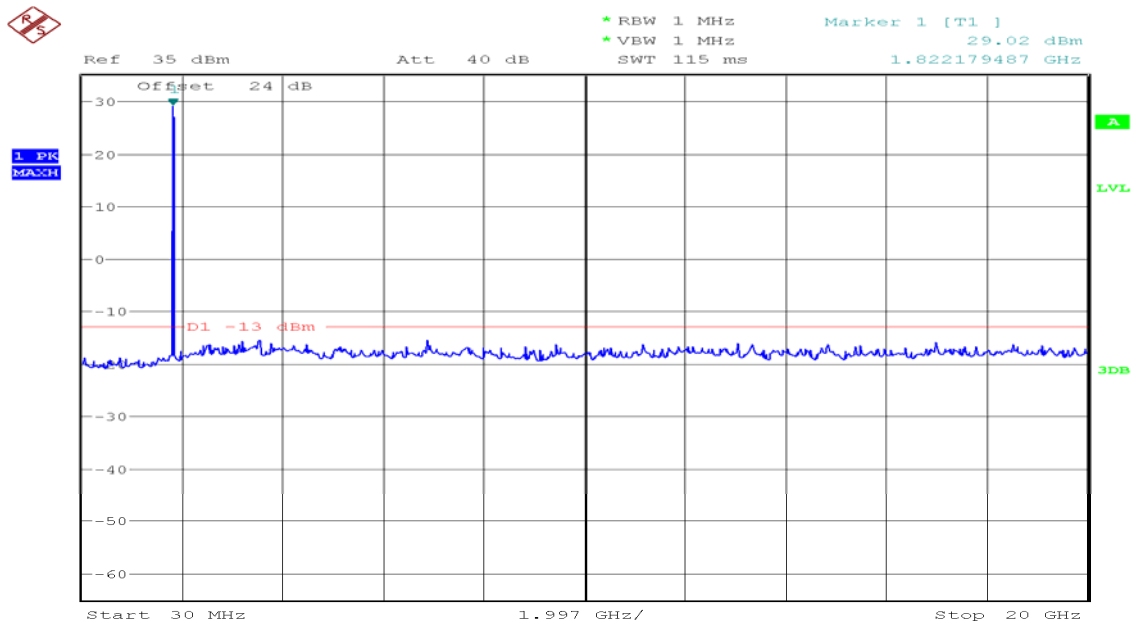
Figure 5-3: Out of Band emission at antenna terminals – GSM CH High



Date: 18.APR.2014 18:33:02

## GSM 1900

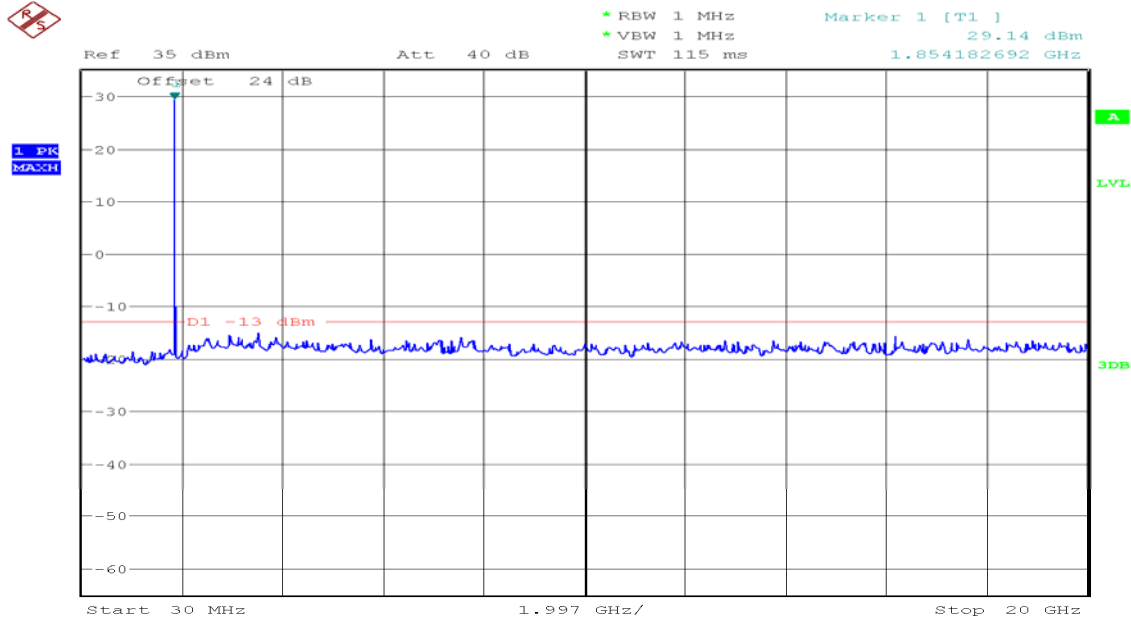
Figure 6-1: Out of Band emission at antenna terminals – GSM CH Low



Date: 18.APR.2014 18:27:30

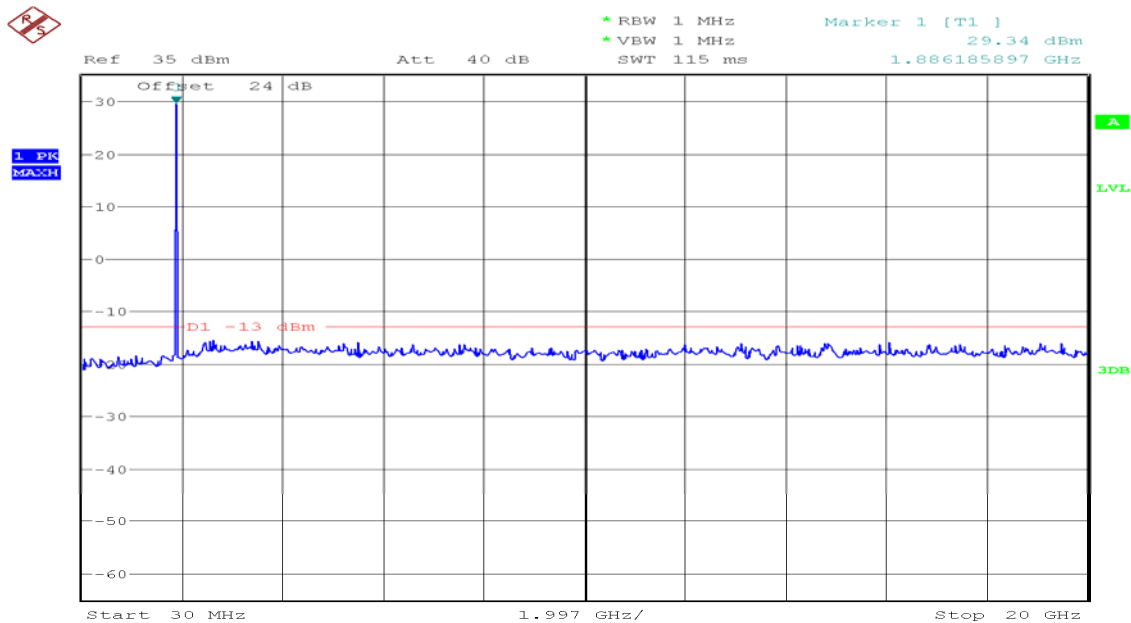


Figure 6-2: Out of Band emission at antenna terminals – GSM CH Mid



Date: 18.APR.2014 18:27:55

Figure 6-3: Out of Band emission at antenna terminals – GSM CH High

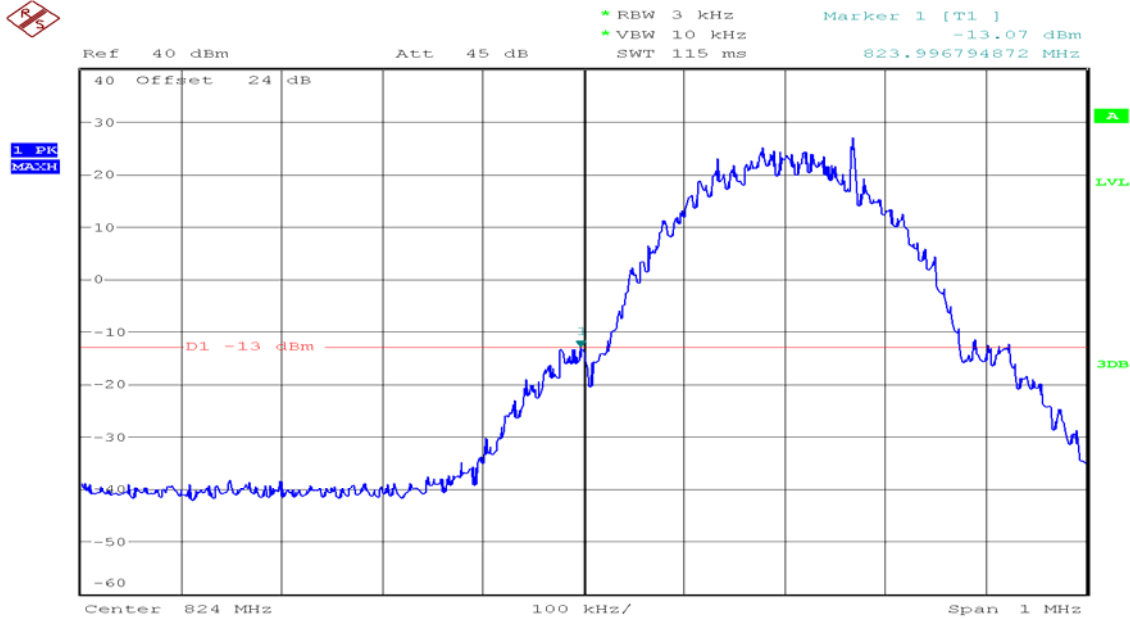


Date: 18.APR.2014 18:28:24



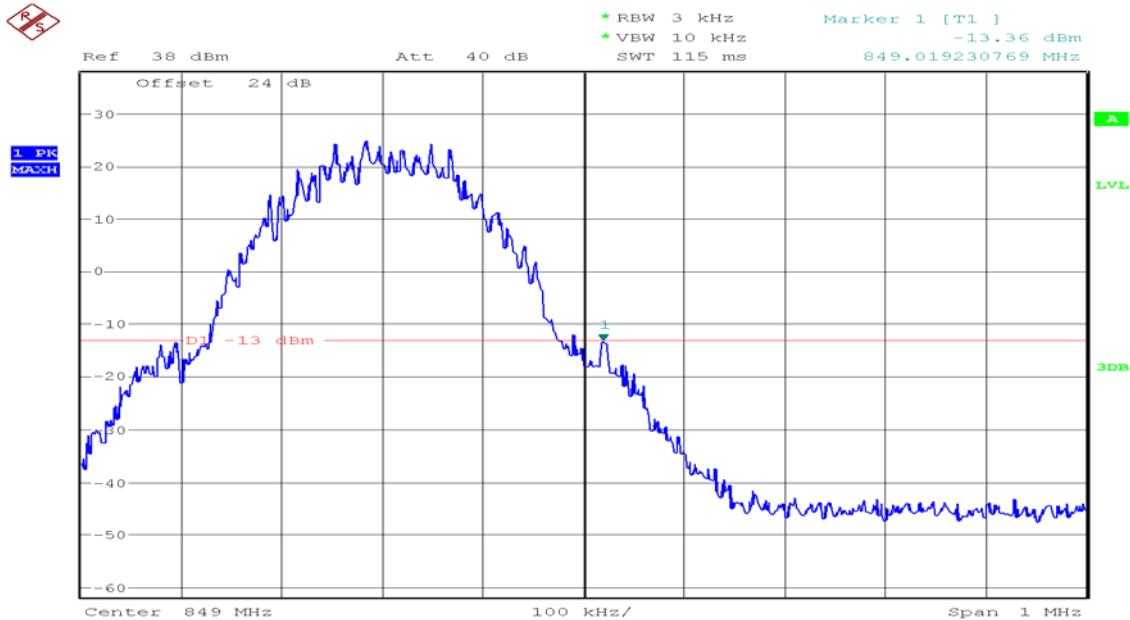
## GSM 850

Figure 3-1: Band Edge emissions – GSM CH Low



Date: 16.APR.2014 14:54:11

Figure 3-2: Band Edge emissions –GSM CH High

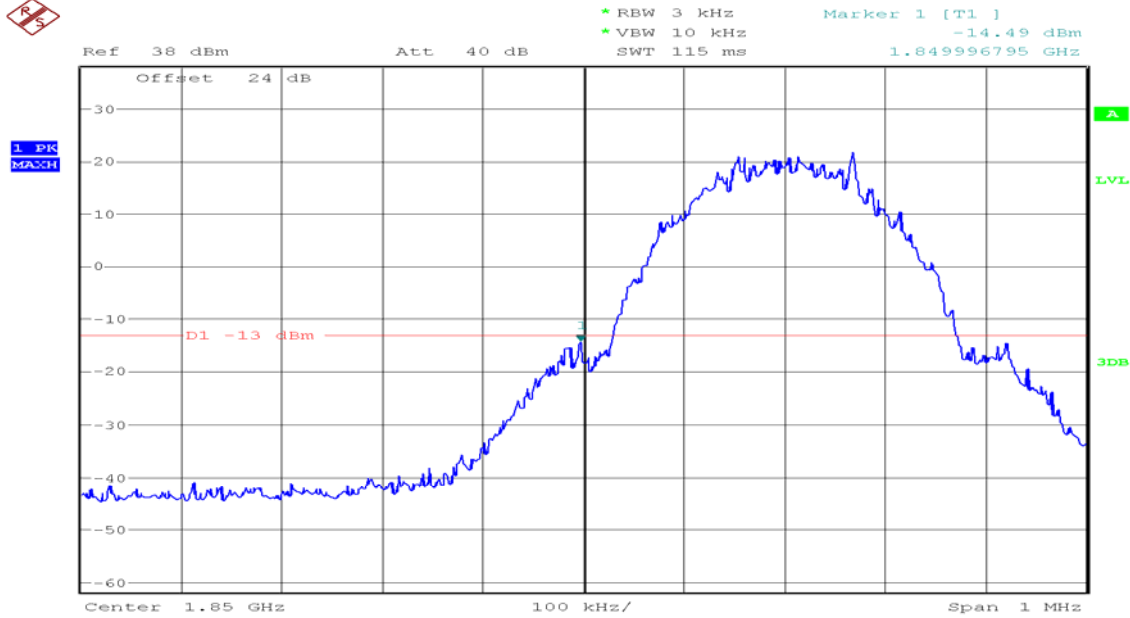


Date: 18.APR.2014 18:05:50



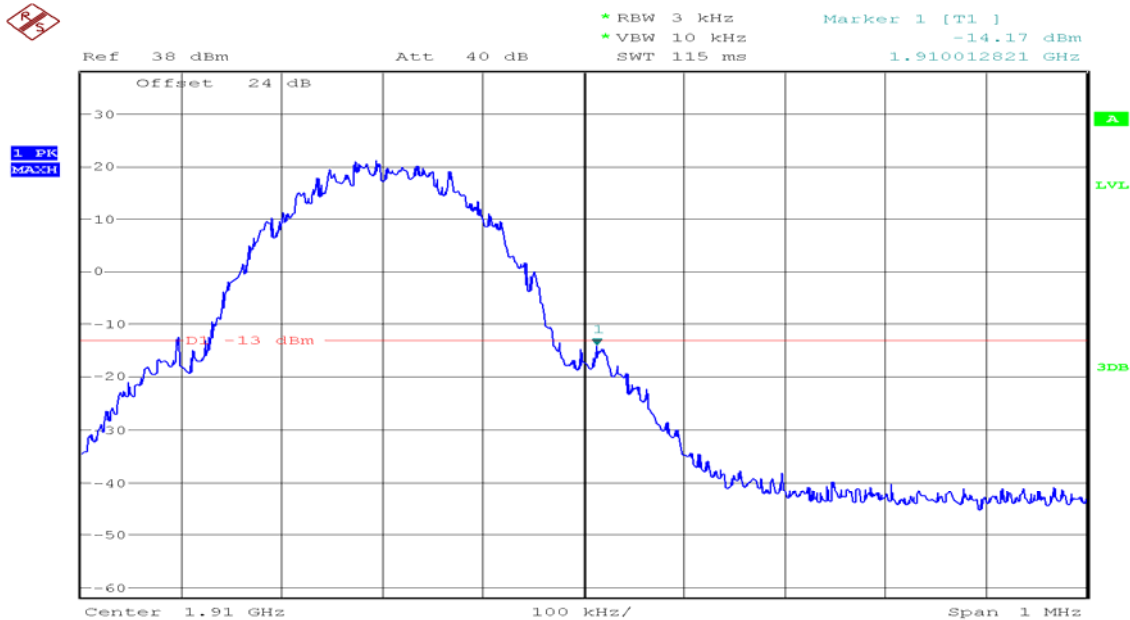
## GSM 1900

Figure 4-1: Band Edge emissions – GSM CH Low



Date: 18.APR.2014 18:13:57

Figure 4-2: Band Edge emissions – GSM CH High

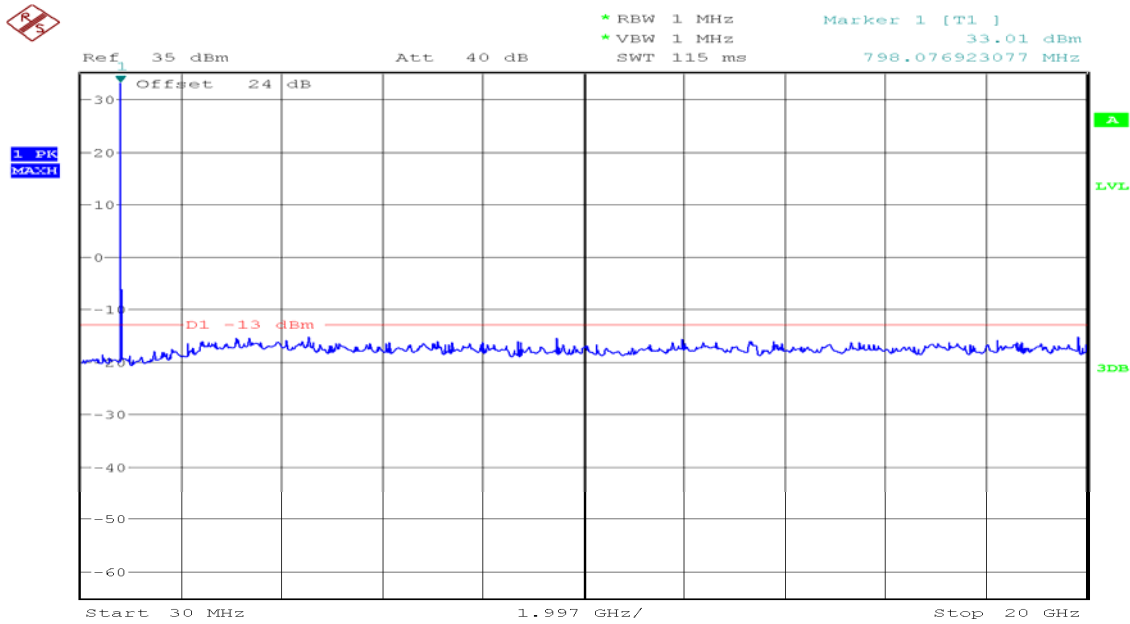


Date: 18.APR.2014 18:15:11



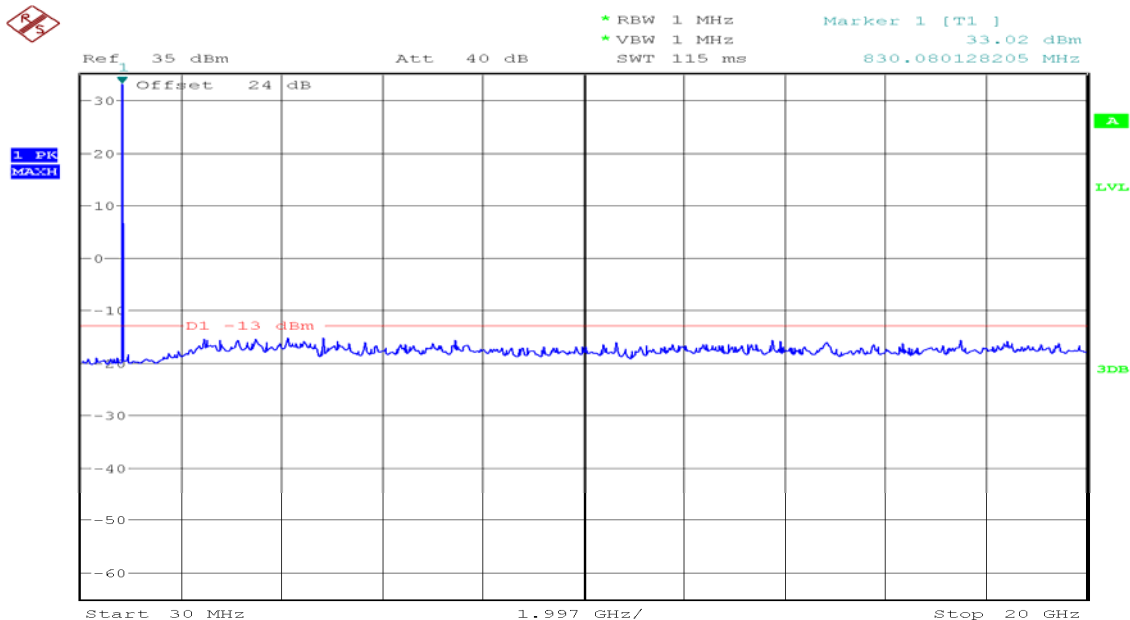
## GPRS 850

Figure 7-1: Out of Band emission at antenna terminals – GPRS CH Low



Date: 18.APR.2014 18:31:10

Figure 7-2: Out of Band emission at antenna terminals – GPRS CH Mid



Date: 18.APR.2014 18:30:38





# Compliance Certification Services Inc.

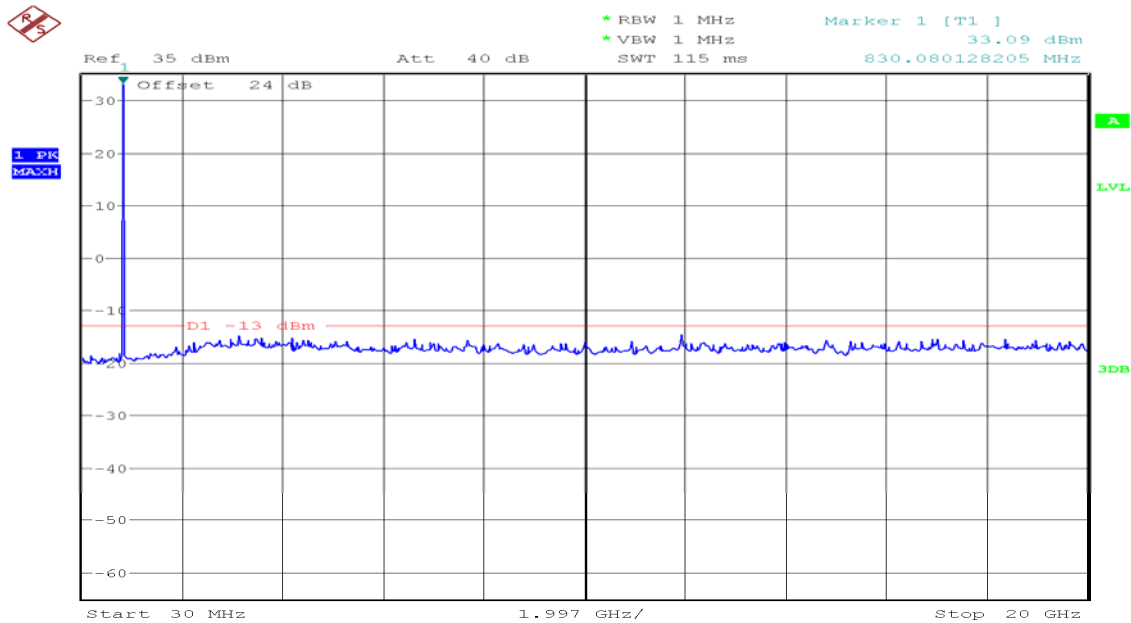
Reference No.: C140328R01-RP1

Report No: C140331R02-RP1

FCC ID: XMR201403GC65

Date of Issue :April 23, 2014

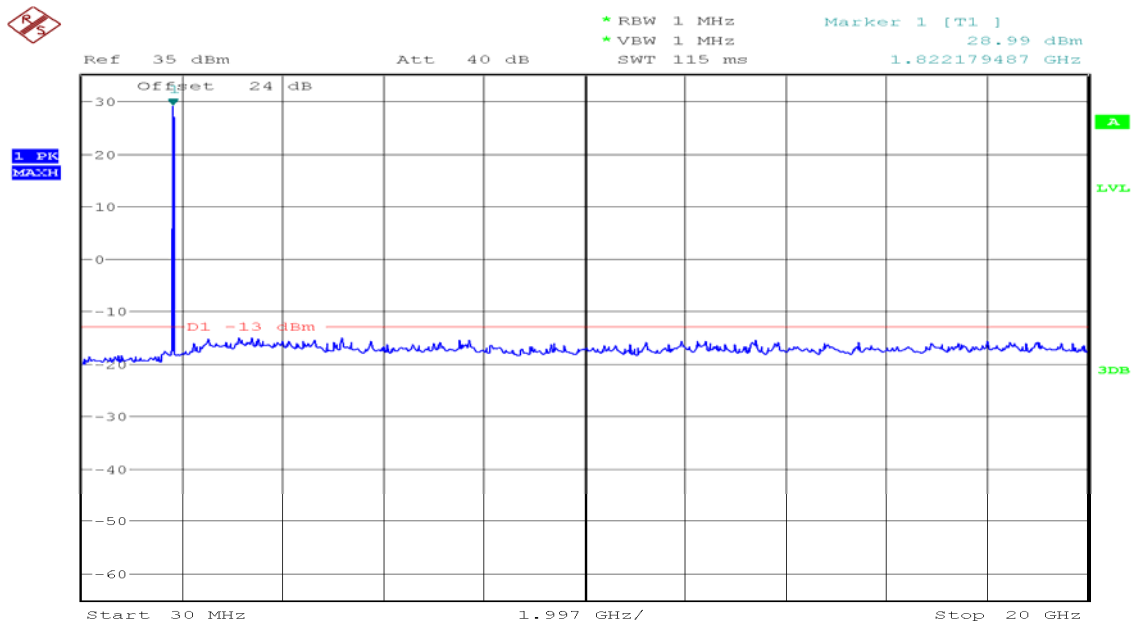
Figure 7-3: Out of Band emission at antenna terminals – GPRS CH High



Date: 18.APR.2014 18:29:58

## GPRS 1900

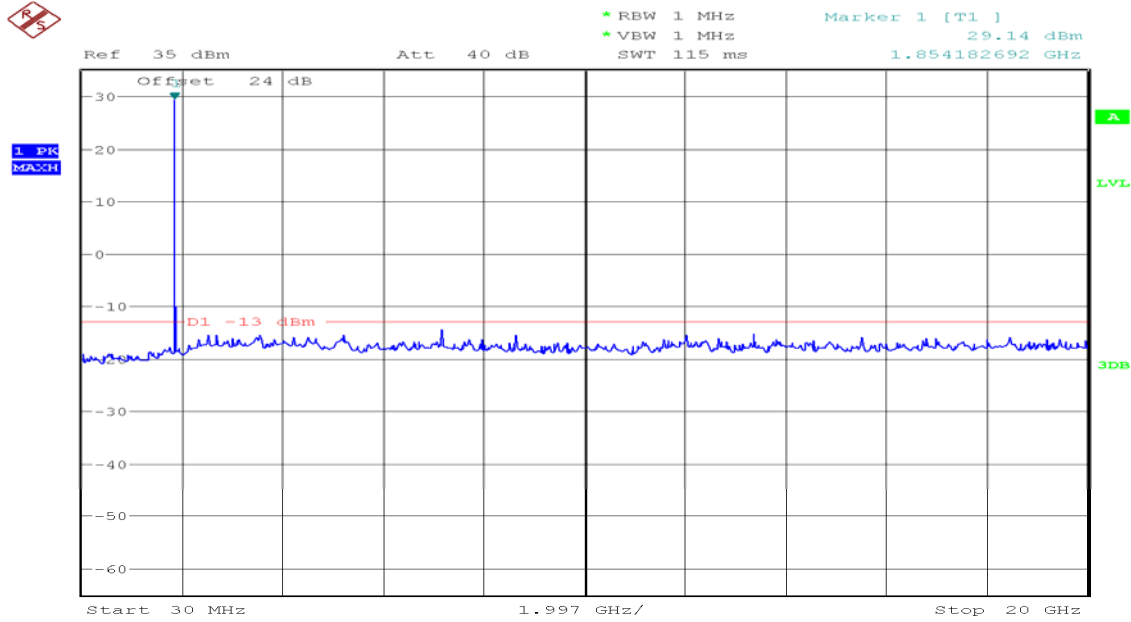
Figure 8-1: Out of Band emission at antenna terminals – GPRS CH Low



Date: 18.APR.2014 18:24:59

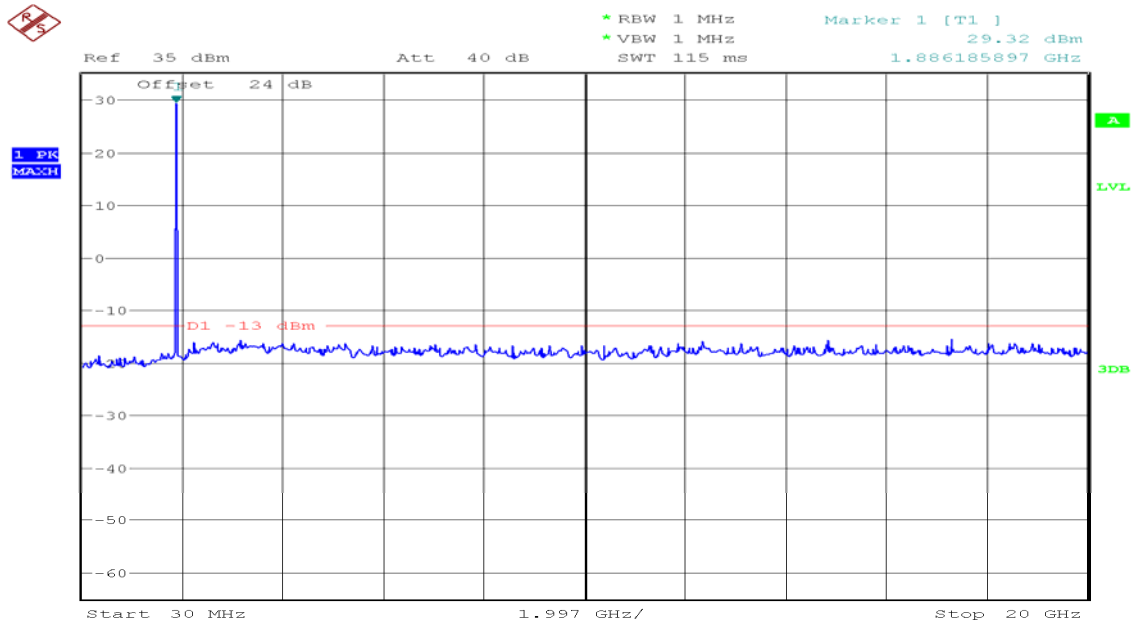


Figure 8-2: Out of Band emission at antenna terminals – GPRS CH Mid



Date: 18.APR.2014 18:25:34

Figure 8-3: Out of Band emission at antenna terminals – GPRS CH High

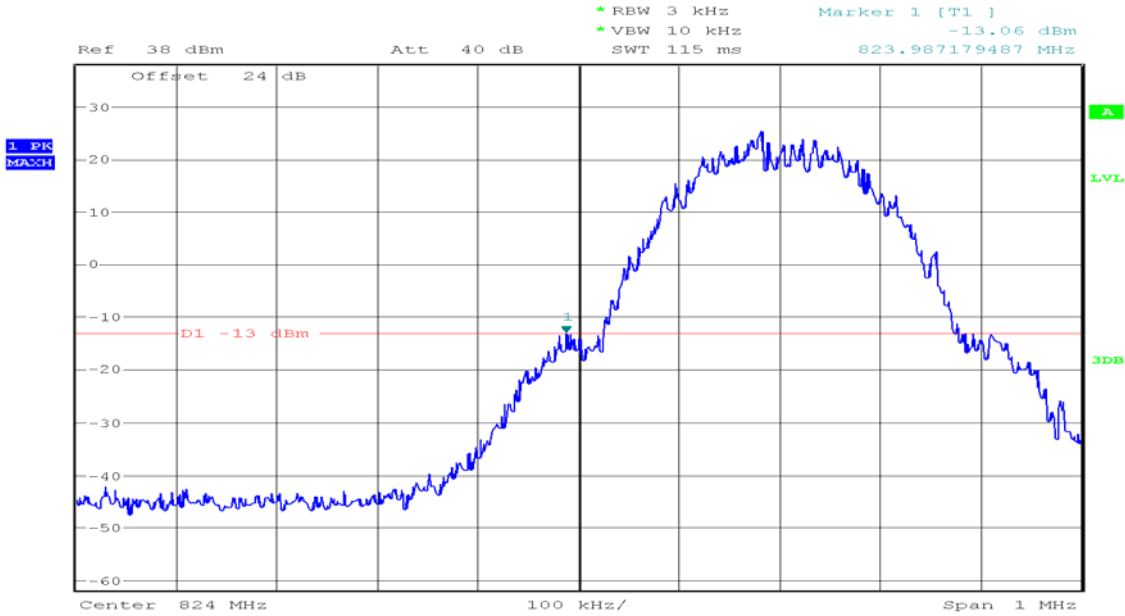


Date: 18.APR.2014 18:26:25



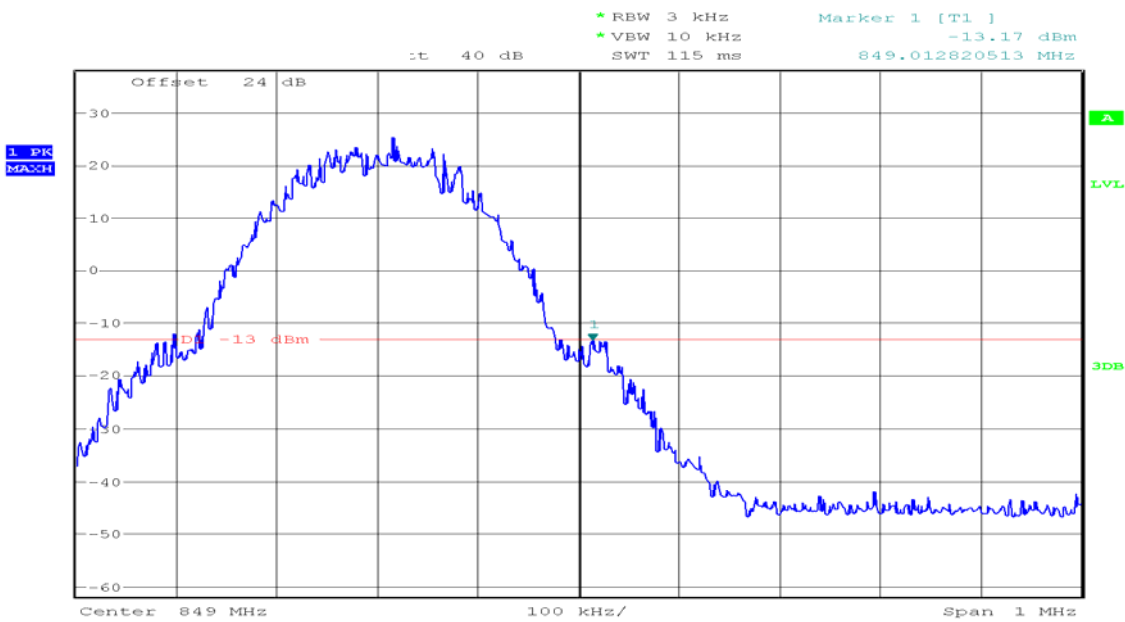
## GPRS 850

Figure 9-1: Band Edge emissions – GPRS CH Low



Date: 18.APR.2014 18:10:16

Figure 9-2: Band Edge emissions –GPRS CH High

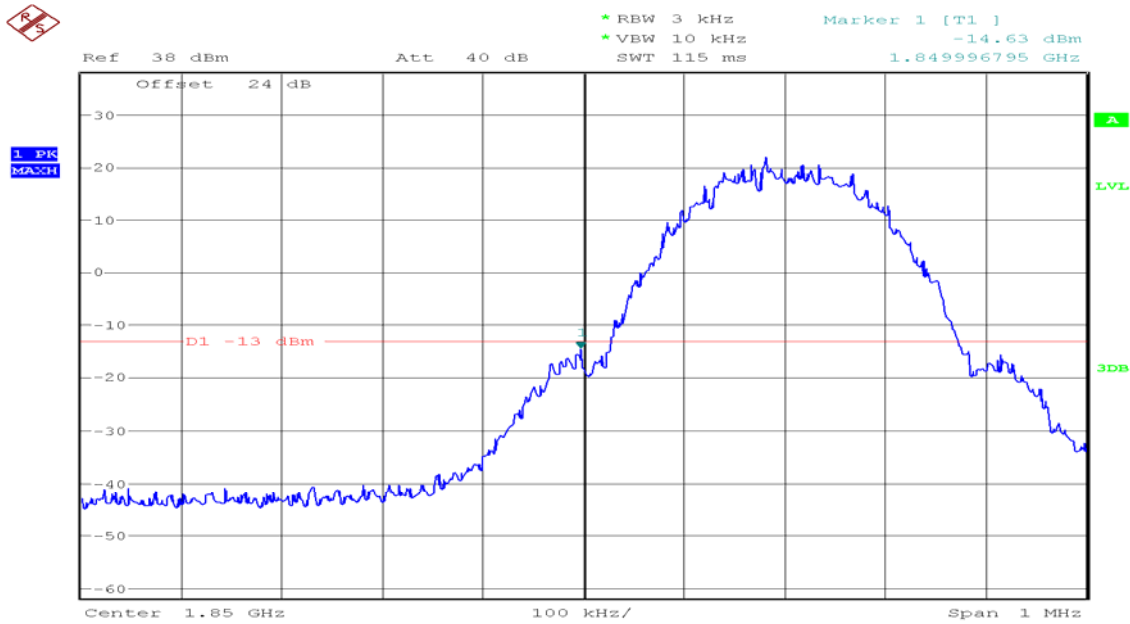


Date: 18.APR.2014 18:09:36



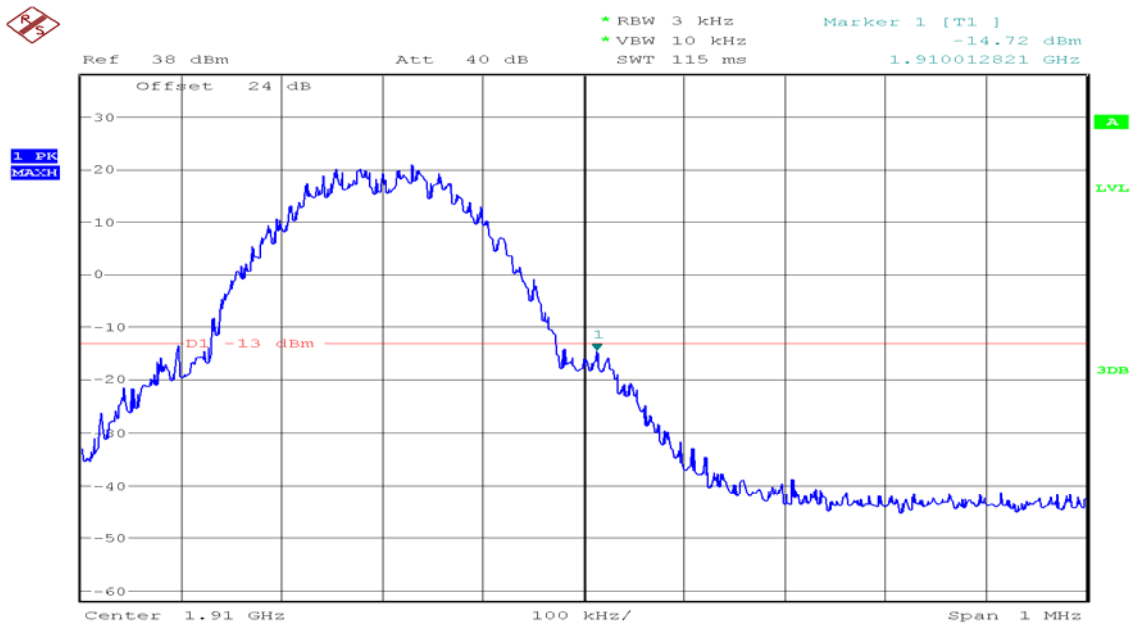
## GPRS 1900

Figure 10-1: Band Edge emissions – GPRS CH Low



Date: 18.APR.2014 18:19:30

Figure 10-2: Band Edge emissions – GPRS CH High



Date: 18.APR.2014 18:17:42



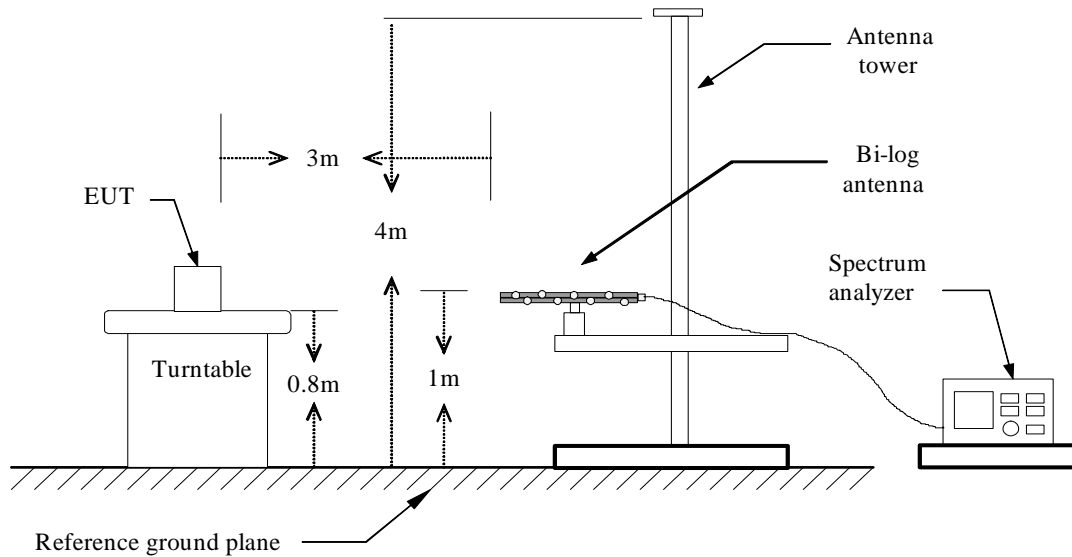
## 7.6. FIELD STRENGTH OF SPURIOUS RADIATION MEASUREMENT

### LIMIT

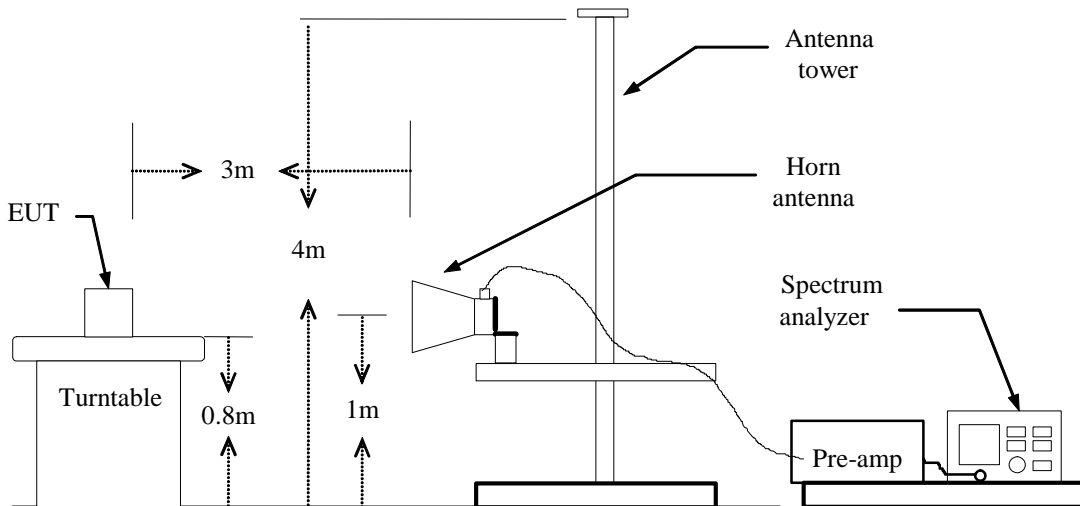
According to FCC §2.1053

### TEST CONFIGURATION

#### Below 1 GHz

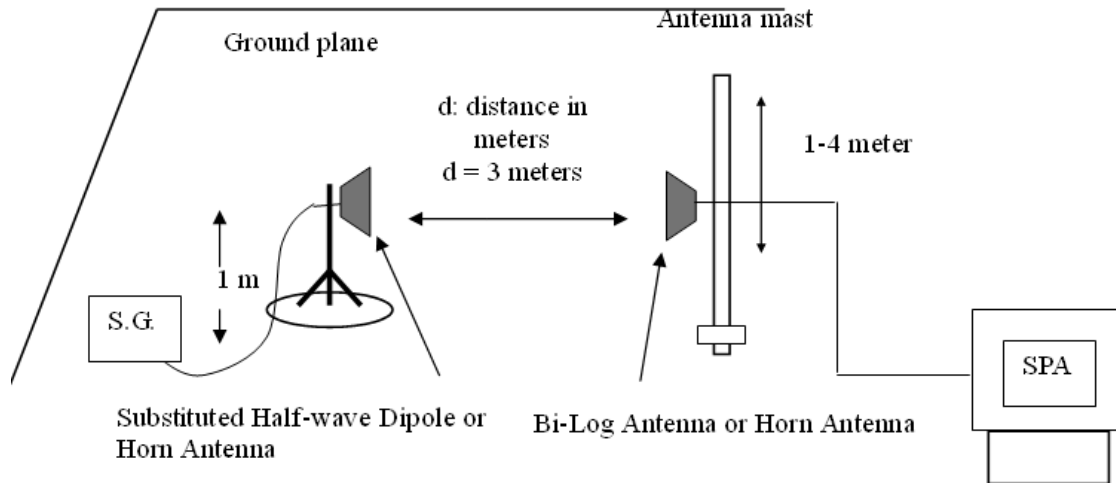


#### Above 1 GHz





## Substituted Method Test Set-up



## TEST PROCEDURE

The EUT was placed on a non-conductive, the measurement antenna was placed at a distance of 3 meters from the EUT. During the tests, the antenna height and the EUT azimuth were varied in order to identify the maximum level of emissions from the EUT. This maximization process was repeated with the EUT positioned in each of its three orthogonal orientations.

The frequency range up to tenth harmonic was investigated for each of three fundamental frequency (low, middle and high channels). Once spurious emission were identified, the power of the emission was determined using the substitution method.

The spurious emissions attenuation was calculated as the difference between radiated power at the fundamental frequency and the spurious emissions frequency.

$$\text{ERP} = \text{S.G. output (dBm)} + \text{Antenna Gain (dBd)} - \text{Cable (dB)}$$

$$\text{EIRP} = \text{S.G. output (dBm)} + \text{Antenna Gain (dBi)} - \text{Cable (dB)}$$



# Compliance Certification Services Inc.

Reference No.: C140328R01-RP1

Report No: C140331R02-RP1

FCC ID: XMR201403GC65

Date of Issue :April 23, 2014

## TEST RESULTS

Refer to the attached tabular data sheets.

### Radiated Spurious Emission Measurement Result / Below 1GHz

Operation Mode:	GSM 850 / TX / CH 128	Test Date:	2014-4-21
Temperature:	23°C	Tested by:	Blent.Wang
Humidity:	51 % RH	Polarity:	Ver. / Hor.

Frequency (MHz)	Antenna Polarization	Reading (dBm)	Correction Factor (dB)	Emission level (dBm)	Limit (dBm)	Margin (dB)
94.9900	V	-31.37	-12.91	-44.28	-13.00	-31.28
223.0300	V	-35.35	-13.01	-48.36	-13.00	-35.36
395.6900	V	-42.66	-8.17	-50.83	-13.00	-37.83
554.7700	V	-37.98	-5.10	-43.08	-13.00	-30.08
748.7700	V	-45.40	-2.08	-47.48	-13.00	-34.48
904.9400	V	-44.71	-0.89	-45.60	-13.00	-32.60
125.0600	H	-28.09	-8.64	-36.73	-13.00	-23.73
246.3100	H	-27.77	-12.71	-40.48	-13.00	-27.48
392.7800	H	-35.33	-8.43	-43.76	-13.00	-30.76
545.0700	H	-31.76	-5.37	-37.13	-13.00	-24.13
710.9400	H	-40.02	-2.69	-42.71	-13.00	-29.71
959.2600	H	-40.49	-0.57	-41.06	-13.00	-28.06

### Remark:

1. The emission behaviour belongs to narrowband spurious emission.
2. Measurements above show only up to 6 maximum emissions noted, or would be lesser, with "N/A" remark, if no specific emissions from the EUT are recorded (ie: margin>20dB from the applicable limit) and considered that's already beyond the background noise floor.



# Compliance Certification Services Inc.

Reference No.: C140328R01-RP1

Report No: C140331R02-RP1

FCC ID: XMR201403GC65

Date of Issue :April 23, 2014

<b>Operation Mode:</b>	GSM 850 / TX / CH 190	<b>Test Date:</b>	2014-4-21
<b>Temperature:</b>	23°C	<b>Tested by:</b>	Blent.Wang
<b>Humidity:</b>	51 % RH	<b>Polarity:</b>	Ver. / Hor.

Frequency (MHz)	Antenna Polarization	Reading (dBm)	Correction Factor (dB)	Emission level (dBm)	Limit (dBm)	Margin (dB)
124.0900	V	-29.75	-11.94	-41.69	-13.00	-28.69
157.0700	V	-37.57	-11.50	-49.07	-13.00	-36.07
310.3300	V	-35.04	-10.25	-45.29	-13.00	-32.29
529.5500	V	-44.28	-5.69	-49.97	-13.00	-36.97
680.8700	V	-44.11	-3.06	-47.17	-13.00	-34.17
847.7100	V	-52.31	-1.54	-53.85	-13.00	-40.85
71.7100	H	-12.46	-16.53	-28.99	-13.00	-15.99
156.1000	H	-23.69	-10.80	-34.49	-13.00	-21.49
329.7300	H	-30.90	-9.59	-40.49	-13.00	-27.49
512.0900	H	-24.87	-5.94	-30.81	-13.00	-17.81
660.5000	H	-34.62	-3.53	-38.15	-13.00	-25.15
883.6000	H	-38.36	-1.22	-39.58	-13.00	-26.58

**Remark:**

1. The emission behaviour belongs to narrowband spurious emission.
2. Measurements above show only up to 6 maximum emissions noted, or would be lesser, with "N/A" remark, if no specific emissions from the EUT are recorded (ie: margin>20dB from the applicable limit) and considered that's already beyond the background noise floor.





# Compliance Certification Services Inc.

Reference No.: C140328R01-RP1

Report No: C140331R02-RP1

FCC ID: XMR201403GC65

Date of Issue :April 23, 2014

<b>Operation Mode:</b>	GSM 850 / TX / CH 251	<b>Test Date:</b>	2014-4-21
<b>Temperature:</b>	23°C	<b>Tested by:</b>	Blent.Wang
<b>Humidity:</b>	51 % RH	<b>Polarity:</b>	Ver. / Hor.

Frequency (MHz)	Antenna Polarization	Reading (dBm)	Correction Factor (dB)	Emission level (dBm)	Limit (dBm)	Margin (dB)
65.8900	V	-24.96	-13.59	-38.55	-13.00	-25.55
172.5900	V	-29.74	-11.79	-41.53	-13.00	-28.53
273.4700	V	-38.21	-10.42	-48.63	-13.00	-35.63
504.3300	V	-43.07	-5.84	-48.91	-13.00	-35.91
745.8600	V	-44.51	-2.19	-46.70	-13.00	-33.70
935.0100	V	-42.59	-0.47	-43.06	-13.00	-30.06
122.1500	H	-27.58	-8.99	-36.57	-13.00	-23.57
287.0500	H	-27.88	-10.19	-38.07	-13.00	-25.07
419.9400	H	-37.16	-7.30	-44.46	-13.00	-31.46
592.6000	H	-35.59	-4.60	-40.19	-13.00	-27.19
734.2200	H	-38.99	-2.66	-41.65	-13.00	-28.65
920.4600	H	-37.04	-0.58	-37.62	-13.00	-24.62

**Remark:**

1. The emission behaviour belongs to narrowband spurious emission.
2. Measurements above show only up to 6 maximum emissions noted, or would be lesser, with "N/A" remark, if no specific emissions from the EUT are recorded (ie: margin>20dB from the applicable limit) and considered that's already beyond the background noise floor.



# Compliance Certification Services Inc.

Reference No.: C140328R01-RP1

Report No: C140331R02-RP1

FCC ID: XMR201403GC65

Date of Issue :April 23, 2014

<b>Operation Mode:</b>	GPRS 850 / TX / CH 128	<b>Test Date:</b>	2014-4-21
<b>Temperature:</b>	23°C	<b>Tested by:</b>	Blent.Wang
<b>Humidity:</b>	51 % RH	<b>Polarity:</b>	Ver. / Hor.

Frequency (MHz)	Antenna Polarization	Reading (dBm)	Correction Factor (dB)	Emission level (dBm)	Limit (dBm)	Margin (dB)
54.2500	V	-23.96	-13.96	-37.92	-13.00	-24.92
180.3500	V	-34.03	-11.75	-45.78	-13.00	-32.78
307.4200	V	-34.30	-10.26	-44.56	-13.00	-31.56
479.1100	V	-40.13	-5.95	-46.08	-13.00	-33.08
616.8500	V	-45.22	-3.69	-48.91	-13.00	-35.91
680.8700	V	-44.11	-3.06	-47.17	-13.00	-34.17
42.6100	H	-28.47	-11.14	-39.61	-13.00	-26.61
261.8300	H	-24.59	-11.08	-35.67	-13.00	-22.67
405.3900	H	-37.75	-7.77	-45.52	-13.00	-32.52
570.2900	H	-37.86	-5.01	-42.87	-13.00	-29.87
684.7500	H	-35.98	-3.07	-39.05	-13.00	-26.05
916.5800	H	-40.31	-0.71	-41.02	-13.00	-28.02

**Remark:**

1. The emission behaviour belongs to narrowband spurious emission.
2. Measurements above show only up to 6 maximum emissions noted, or would be lesser, with "N/A" remark, if no specific emissions from the EUT are recorded (ie: margin>20dB from the applicable limit) and considered that's already beyond the background noise floor.



# Compliance Certification Services Inc.

Reference No.: C140328R01-RP1

Report No: C140331R02-RP1

FCC ID: XMR201403GC65

Date of Issue :April 23, 2014

<b>Operation Mode:</b>	GPRS 850 / TX / CH 190	<b>Test Date:</b>	2014-4-21
<b>Temperature:</b>	23°C	<b>Tested by:</b>	Blent.Wang
<b>Humidity:</b>	51 % RH	<b>Polarity:</b>	Ver. / Hor.

Frequency (MHz)	Antenna Polarization	Reading (dBm)	Correction Factor (dB)	Emission level (dBm)	Limit (dBm)	Margin (dB)
102.7500	V	-26.43	-12.66	-39.09	-13.00	-26.09
345.2500	V	-36.82	-9.29	-46.11	-13.00	-33.11
462.6200	V	-46.80	-6.31	-53.11	-13.00	-40.11
582.9000	V	-41.44	-4.79	-46.23	-13.00	-33.23
754.5900	V	-49.32	-2.03	-51.35	-13.00	-38.35
947.6200	V	-43.52	-0.59	-44.11	-13.00	-31.11
105.6600	H	-27.74	-11.67	-39.41	-13.00	-26.41
265.7100	H	-24.10	-10.59	-34.69	-13.00	-21.69
321.9700	H	-31.51	-9.74	-41.25	-13.00	-28.25
454.8600	H	-37.60	-6.58	-44.18	-13.00	-31.18
640.1300	H	-38.80	-3.49	-42.29	-13.00	-29.29
847.7100	H	-42.57	-1.72	-44.29	-13.00	-31.29

**Remark:**

1. The emission behaviour belongs to narrowband spurious emission.
2. Measurements above show only up to 6 maximum emissions noted, or would be lesser, with "N/A" remark, if no specific emissions from the EUT are recorded (ie: margin>20dB from the applicable limit) and considered that's already beyond the background noise floor.



# Compliance Certification Services Inc.

Reference No.: C140328R01-RP1

Report No: C140331R02-RP1

FCC ID: XMR201403GC65

Date of Issue :April 23, 2014

<b>Operation Mode:</b>	GPRS 850 / TX / CH 251	<b>Test Date:</b>	2014-4-21
<b>Temperature:</b>	23°C	<b>Tested by:</b>	Blent.Wang
<b>Humidity:</b>	51 % RH	<b>Polarity:</b>	Ver. / Hor.

Frequency (MHz)	Antenna Polarization	Reading (dBm)	Correction Factor (dB)	Emission level (dBm)	Limit (dBm)	Margin (dB)
122.1500	V	-28.32	-12.01	-40.33	-13.00	-27.33
320.0300	V	-34.95	-10.02	-44.97	-13.00	-31.97
416.0600	V	-32.51	-7.26	-39.77	-13.00	-26.77
548.9500	V	-43.66	-5.20	-48.86	-13.00	-35.86
676.9900	V	-43.78	-3.14	-46.92	-13.00	-33.92
874.8700	V	-49.73	-1.03	-50.76	-13.00	-37.76
55.2200	H	-20.58	-16.18	-36.76	-13.00	-23.76
131.8500	H	-29.81	-8.29	-38.10	-13.00	-25.10
244.3700	H	-29.79	-12.77	-42.56	-13.00	-29.56
314.2100	H	-31.61	-9.88	-41.49	-13.00	-28.49
524.7000	H	-36.96	-5.93	-42.89	-13.00	-29.89
733.2500	H	-40.92	-2.69	-43.61	-13.00	-30.61

**Remark:**

1. The emission behaviour belongs to narrowband spurious emission.
2. Measurements above show only up to 6 maximum emissions noted, or would be lesser, with "N/A" remark, if no specific emissions from the EUT are recorded (ie: margin>20dB from the applicable limit) and considered that's already beyond the background noise floor.



# Compliance Certification Services Inc.

Reference No.: C140328R01-RP1

Report No: C140331R02-RP1

FCC ID: XMR201403GC65

Date of Issue :April 23, 2014

<b>Operation Mode:</b>	GSM 1900 / TX / CH 512	<b>Test Date:</b>	2014-4-21
<b>Temperature:</b>	21°C	<b>Tested by:</b>	Blent.Wang
<b>Humidity:</b>	53 % RH	<b>Polarity:</b>	Ver. / Hor.

Frequency (MHz)	Antenna Polarization	Reading (dBm)	Correction Factor (dB)	Emission level (dBm)	Limit (dBm)	Margin (dB)
100.8100	V	-28.41	-12.72	-41.13	-13.00	-28.13
193.9300	V	-33.81	-12.02	-45.83	-13.00	-32.83
343.3100	V	-36.89	-9.36	-46.25	-13.00	-33.25
519.8500	V	-30.33	-5.78	-36.11	-13.00	-23.11
722.5800	V	-39.90	-2.78	-42.68	-13.00	-29.68
883.6000	V	-35.84	-1.13	-36.97	-13.00	-23.97
36.7900	H	-27.38	-7.29	-34.67	-13.00	-21.67
121.1800	H	-33.40	-9.11	-42.51	-13.00	-29.51
273.4700	H	-32.48	-10.08	-42.56	-13.00	-29.56
446.1300	H	-40.56	-6.76	-47.32	-13.00	-34.32
766.2300	H	-41.04	-2.09	-43.13	-13.00	-30.13
872.9300	H	-44.82	-1.07	-45.89	-13.00	-32.89

**Remark:**

1. The emission behaviour belongs to narrowband spurious emission.
2. Measurements above show only up to 6 maximum emissions noted, or would be lesser, with "N/A" remark, if no specific emissions from the EUT are recorded (ie: margin>20dB from the applicable limit) and considered that's already beyond the background noise floor.



# Compliance Certification Services Inc.

Reference No.: C140328R01-RP1

Report No: C140331R02-RP1

FCC ID: XMR201403GC65

Date of Issue :April 23, 2014

<b>Operation Mode:</b>	GSM 1900 / TX / CH 661	<b>Test Date:</b>	2014-4-21
<b>Temperature:</b>	21°C	<b>Tested by:</b>	Blent.Wang
<b>Humidity:</b>	53 % RH	<b>Polarity:</b>	Ver. / Hor.

Frequency (MHz)	Antenna Polarization	Reading (dBm)	Correction Factor (dB)	Emission level (dBm)	Limit (dBm)	Margin (dB)
66.8600	V	-21.42	-13.56	-34.98	-13.00	-21.98
145.4300	V	-34.10	-11.42	-45.52	-13.00	-32.52
282.2000	V	-35.50	-10.34	-45.84	-13.00	-32.84
449.0400	V	-37.94	-6.73	-44.67	-13.00	-31.67
602.3000	V	-38.64	-4.21	-42.85	-13.00	-29.85
810.8500	V	-40.24	-1.59	-41.83	-13.00	-28.83
124.0900	H	-22.80	-8.76	-31.56	-13.00	-18.56
252.1300	H	-30.63	-12.31	-42.94	-13.00	-29.94
416.0600	H	-32.04	-7.39	-39.43	-13.00	-26.43
609.0900	H	-38.32	-3.99	-42.31	-13.00	-29.31
702.2100	H	-31.25	-2.77	-34.02	-13.00	-21.02
863.2300	H	-44.58	-1.26	-45.84	-13.00	-32.84

**Remark:**

1. *The emission behaviour belongs to narrowband spurious emission.*
2. *Measurements above show only up to 6 maximum emissions noted, or would be lesser, with "N/A" remark, if no specific emissions from the EUT are recorded (ie: margin>20dB from the applicable limit) and considered that's already beyond the background noise floor.*



# Compliance Certification Services Inc.

Reference No.: C140328R01-RP1

Report No: C140331R02-RP1

FCC ID: XMR201403GC65

Date of Issue :April 23, 2014

<b>Operation Mode:</b>	GSM 1900 / TX / CH 810	<b>Test Date:</b>	2014-4-21
<b>Temperature:</b>	21°C	<b>Tested by:</b>	Blent.Wang
<b>Humidity:</b>	53 % RH	<b>Polarity:</b>	Ver. / Hor.

Frequency (MHz)	Antenna Polarization	Reading (dBm)	Correction Factor (dB)	Emission level (dBm)	Limit (dBm)	Margin (dB)
70.7400	V	-26.71	-13.45	-40.16	-13.00	-27.16
176.4700	V	-29.67	-11.77	-41.44	-13.00	-28.44
368.5300	V	-38.01	-8.68	-46.69	-13.00	-33.69
567.3800	V	-36.64	-4.93	-41.57	-13.00	-28.57
685.7200	V	-35.87	-2.96	-38.83	-13.00	-25.83
877.7800	V	-35.52	-1.06	-36.58	-13.00	-23.58
59.1000	H	-37.13	-16.28	-53.41	-13.00	-40.41
167.7400	H	-35.79	-11.04	-46.83	-13.00	-33.83
335.5500	H	-36.27	-9.58	-45.85	-13.00	-32.85
525.6700	H	-40.85	-5.92	-46.77	-13.00	-33.77
649.8300	H	-43.99	-3.54	-47.53	-13.00	-34.53
804.0600	H	-42.38	-1.70	-44.08	-13.00	-31.08

**Remark:**

1. The emission behaviour belongs to narrowband spurious emission.
2. Measurements above show only up to 6 maximum emissions noted, or would be lesser, with "N/A" remark, if no specific emissions from the EUT are recorded (ie: margin>20dB from the applicable limit) and considered that's already beyond the background noise floor.



# Compliance Certification Services Inc.

Reference No.: C140328R01-RP1

Report No: C140331R02-RP1

FCC ID: XMR201403GC65

Date of Issue :April 23, 2014

<b>Operation Mode:</b>	GPRS 1900 / TX / CH 512	<b>Test Date:</b>	2014-4-21
<b>Temperature:</b>	21°C	<b>Tested by:</b>	Blent.Wang
<b>Humidity:</b>	53 % RH	<b>Polarity:</b>	Ver. / Hor.

Frequency (MHz)	Antenna Polarization	Reading (dBm)	Correction Factor (dB)	Emission level (dBm)	Limit (dBm)	Margin (dB)
55.2200	V	-28.88	-13.93	-42.81	-13.00	-29.81
156.1000	V	-27.32	-11.48	-38.80	-13.00	-25.80
301.6000	V	-35.27	-10.26	-45.53	-13.00	-32.53
532.4600	V	-37.93	-5.63	-43.56	-13.00	-30.56
779.8100	V	-40.92	-2.01	-42.93	-13.00	-29.93
945.6800	V	-31.60	-0.57	-32.17	-13.00	-19.17
70.7400	H	-21.33	-16.55	-37.88	-13.00	-24.88
175.5000	H	-33.37	-11.16	-44.53	-13.00	-31.53
372.4100	H	-36.48	-8.69	-45.17	-13.00	-32.17
463.5900	H	-40.90	-6.39	-47.29	-13.00	-34.29
613.9400	H	-39.49	-3.86	-43.35	-13.00	-30.35
826.3700	H	-43.30	-1.71	-45.01	-13.00	-32.01

**Remark:**

1. The emission behaviour belongs to narrowband spurious emission.
2. Measurements above show only up to 6 maximum emissions noted, or would be lesser, with "N/A" remark, if no specific emissions from the EUT are recorded (ie: margin>20dB from the applicable limit) and considered that's already beyond the background noise floor.





# Compliance Certification Services Inc.

Reference No.: C140328R01-RP1

Report No: C140331R02-RP1

FCC ID: XMR201403GC65

Date of Issue :April 23, 2014

<b>Operation Mode:</b>	GPRS 1900 / TX / CH 661	<b>Test Date:</b>	2014-4-21
<b>Temperature:</b>	21°C	<b>Tested by:</b>	Blent.Wang
<b>Humidity:</b>	53 % RH	<b>Polarity:</b>	Ver. / Hor.

Frequency (MHz)	Antenna Polarization	Reading (dBm)	Correction Factor (dB)	Emission level (dBm)	Limit (dBm)	Margin (dB)
190.0500	V	-36.50	-11.69	-48.19	-13.00	-35.19
318.0900	V	-36.47	-10.07	-46.54	-13.00	-33.54
483.9600	V	-35.17	-5.88	-41.05	-13.00	-28.05
632.3700	V	-42.02	-3.34	-45.36	-13.00	-32.36
712.8800	V	-39.94	-2.76	-42.70	-13.00	-29.70
892.3300	V	-35.77	-1.16	-36.93	-13.00	-23.93
101.7800	H	-30.55	-12.76	-43.31	-13.00	-30.31
144.4600	H	-34.95	-9.95	-44.90	-13.00	-31.90
273.4700	H	-32.48	-10.08	-42.56	-13.00	-29.56
409.2700	H	-33.93	-7.57	-41.50	-13.00	-28.50
543.1300	H	-42.64	-5.44	-48.08	-13.00	-35.08
757.5000	H	-41.52	-2.20	-43.72	-13.00	-30.72

**Remark:**

1. *The emission behaviour belongs to narrowband spurious emission.*
2. *Measurements above show only up to 6 maximum emissions noted, or would be lesser, with "N/A" remark, if no specific emissions from the EUT are recorded (ie: margin>20dB from the applicable limit) and considered that's already beyond the background noise floor.*



# Compliance Certification Services Inc.

Reference No.: C140328R01-RP1

Report No: C140331R02-RP1

FCC ID: XMR201403GC65

Date of Issue :April 23, 2014

<b>Operation Mode:</b>	GPRS 1900 / TX / CH 810	<b>Test Date:</b>	2014-4-21
<b>Temperature:</b>	21°C	<b>Tested by:</b>	Blent.Wang
<b>Humidity:</b>	53 % RH	<b>Polarity:</b>	Ver. / Hor.

Frequency (MHz)	Antenna Polarization	Reading (dBm)	Correction Factor (dB)	Emission level (dBm)	Limit (dBm)	Margin (dB)
98.8700	V	-32.94	-12.78	-45.72	-13.00	-32.72
254.0700	V	-32.21	-11.62	-43.83	-13.00	-30.83
432.5500	V	-37.57	-7.09	-44.66	-13.00	-31.66
521.7900	V	-36.76	-5.76	-42.52	-13.00	-29.52
614.9100	V	-39.41	-3.74	-43.15	-13.00	-30.15
823.4600	V	-37.66	-1.58	-39.24	-13.00	-26.24
118.2700	H	-32.72	-9.46	-42.18	-13.00	-29.18
183.2600	H	-36.24	-11.26	-47.50	-13.00	-34.50
294.8100	H	-36.66	-10.15	-46.81	-13.00	-33.81
416.0600	H	-32.04	-7.39	-39.43	-13.00	-26.43
642.0700	H	-40.86	-3.50	-44.36	-13.00	-31.36
795.3300	H	-41.54	-1.88	-43.42	-13.00	-30.42

**Remark:**

1. The emission behaviour belongs to narrowband spurious emission.
2. Measurements above show only up to 6 maximum emissions noted, or would be lesser, with "N/A" remark, if no specific emissions from the EUT are recorded (ie: margin>20dB from the applicable limit) and considered that's already beyond the background noise floor.



## Radiated Spurious Emission Measurement Result / Above 1GHz

Operation Mode:	GSM 850 / TX / CH 128	Test Date:	2014-4-21
Temperature:	21°C	Tested by:	Blent.Wang
Humidity:	53 % RH	Polarity:	Ver. / Hor.

Frequency (MHz)	Antenna Polarization	Reading (dBm)	Correction Factor (dB)	Emission level (dBm)	Limit (dBm)	Margin (dB)
1648.000	V	-22.99	-0.52	-23.51	-13.00	-22.99
2473.000	V	-47.62	2.29	-45.33	-13.00	-47.62
1648.000	H	-29.95	-0.72	-30.67	-13.00	-17.67
2473.000	H	-46.95	1.97	-44.98	-13.00	-31.98

### Remark:

1. Measuring frequencies from 1 GHz to the 10th harmonic of highest fundamental frequency.
2. Measurements above show only up to 6 maximum emissions noted, or would be lesser, with "N/A" remark, if no specific emissions from the EUT are recorded (ie: margin>20dB from the applicable limit) and considered that's already beyond the background noise floor.



# Compliance Certification Services Inc.

Reference No.: C140328R01-RP1

Report No: C140331R02-RP1

FCC ID: XMR201403GC65

Date of Issue :April 23, 2014

<b>Operation Mode:</b>	GSM 850 / TX / CH 190	<b>Test Date:</b>	2014-4-21
<b>Temperature:</b>	21°C	<b>Tested by:</b>	Blent.Wang
<b>Humidity:</b>	53 % RH	<b>Polarity:</b>	Ver. / Hor.

Frequency (MHz)	Antenna Polarization	Reading (dBm)	Correction Factor (dB)	Emission level (dBm)	Limit (dBm)	Margin (dB)
1672.000	V	-24.24	-0.32	-24.56	-13.00	-11.56
2509.000	V	-48.97	2.49	-46.48	-13.00	-33.48
1672.000	H	-30.18	-0.61	-30.79	-13.00	-17.79
2509.000	H	-48.59	2.19	-46.40	-13.00	-33.40

**Remark:**

1. Measuring frequencies from 1 GHz to the 10th harmonic of highest fundamental frequency.
2. Measurements above show only up to 6 maximum emissions noted, or would be lesser, with "N/A" remark, if no specific emissions from the EUT are recorded (ie: margin>20dB from the applicable limit) and considered that's already beyond the background noise floor.



# Compliance Certification Services Inc.

Reference No.: C140328R01-RP1

Report No: C140331R02-RP1

FCC ID: XMR201403GC65

Date of Issue :April 23, 2014

<b>Operation Mode:</b>	GSM 850 / TX / CH 251	<b>Test Date:</b>	2014-4-21
<b>Temperature:</b>	21°C	<b>Tested by:</b>	Blent.Wang
<b>Humidity:</b>	53 % RH	<b>Polarity:</b>	Ver. / Hor.

Frequency (MHz)	Antenna Polarization	Reading (dBm)	Correction Factor (dB)	Emission level (dBm)	Limit (dBm)	Margin (dB)
1696.000	V	-25.23	-0.11	-25.34	-13.00	-12.34
2548.000	V	-51.38	2.20	-49.18	-13.00	-36.18
1699.000	H	-30.55	-0.48	-31.03	-13.00	-18.03
2548.000	H	-50.17	1.83	-48.34	-13.00	-35.34

**Remark:**

1. Measuring frequencies from 1 GHz to the 10th harmonic of highest fundamental frequency.
2. Measurements above show only up to 6 maximum emissions noted, or would be lesser, with "N/A" remark, if no specific emissions from the EUT are recorded (ie: margin>20dB from the applicable limit) and considered that's already beyond the background noise floor.



# Compliance Certification Services Inc.

Reference No.: C140328R01-RP1

Report No: C140331R02-RP1

FCC ID: XMR201403GC65

Date of Issue :April 23, 2014

<b>Operation Mode:</b>	GPRS 850 / TX / CH 128	<b>Test Date:</b>	2014-4-21
<b>Temperature:</b>	21°C	<b>Tested by:</b>	Blent.Wang
<b>Humidity:</b>	53 % RH	<b>Polarity:</b>	Ver. / Hor.

Frequency (MHz)	Antenna Polarization	Reading (dBm)	Correction Factor (dB)	Emission level (dBm)	Limit (dBm)	Margin (dB)
1648.000	V	-28.99	-0.52	-29.51	-13.00	-16.51
2473.000	V	-43.62	2.29	-41.33	-13.00	-28.33
1648.000	H	-42.45	-0.72	-43.17	-13.00	-30.17
2473.000	H	-42.95	1.97	-40.98	-13.00	-27.98

**Remark:**

1. Measuring frequencies from 1 GHz to the 10th harmonic of highest fundamental frequency.
2. Measurements above show only up to 6 maximum emissions noted, or would be lesser, with " N/A " remark, if no specific emissions from the EUT are recorded (ie: margin>20dB from the applicable limit) and considered that's already beyond the background noise floor.



# Compliance Certification Services Inc.

Reference No.: C140328R01-RP1

Report No: C140331R02-RP1

FCC ID: XMR201403GC65

Date of Issue :April 23, 2014

<b>Operation Mode:</b>	GPRS 850 / TX / CH 190	<b>Test Date:</b>	2014-4-21
<b>Temperature:</b>	21°C	<b>Tested by:</b>	Blent.Wang
<b>Humidity:</b>	53 % RH	<b>Polarity:</b>	Ver. / Hor.

Frequency (MHz)	Antenna Polarization	Reading (dBm)	Correction Factor (dB)	Emission level (dBm)	Limit (dBm)	Margin (dB)
1672.000	V	-30.74	-0.32	-31.06	-13.00	-18.06
2509.000	V	-45.47	2.49	-42.98	-13.00	-29.98
1672.000	H	-35.18	-0.61	-35.79	-13.00	-22.79
2509.000	H	-45.59	2.19	-43.40	-13.00	-30.40

**Remark:**

1. Measuring frequencies from 1 GHz to the 10th harmonic of highest fundamental frequency.
2. Measurements above show only up to 6 maximum emissions noted, or would be lesser, with "N/A" remark, if no specific emissions from the EUT are recorded (ie: margin>20dB from the applicable limit) and considered that's already beyond the background noise floor.



# Compliance Certification Services Inc.

Reference No.: C140328R01-RP1

Report No: C140331R02-RP1

FCC ID: XMR201403GC65

Date of Issue :April 23, 2014

<b>Operation Mode:</b>	GPRS 850 / TX / CH 251	<b>Test Date:</b>	2014-4-21
<b>Temperature:</b>	21°C	<b>Tested by:</b>	Blent.Wang
<b>Humidity:</b>	53 % RH	<b>Polarity:</b>	Ver. / Hor.

Frequency (MHz)	Antenna Polarization	Reading (dBm)	Correction Factor (dB)	Emission level (dBm)	Limit (dBm)	Margin (dB)
1696.000	V	-30.73	-0.11	-30.84	-13.00	-17.84
2548.000	V	-45.88	2.20	-43.68	-13.00	-30.68
1699.000	H	-37.05	-0.48	-37.53	-13.00	-24.53
2548.000	H	-45.17	1.83	-43.34	-13.00	-30.34

**Remark:**

1. Measuring frequencies from 1 GHz to the 10th harmonic of highest fundamental frequency.
2. Measurements above show only up to 6 maximum emissions noted, or would be lesser, with "N/A" remark, if no specific emissions from the EUT are recorded (ie: margin>20dB from the applicable limit) and considered that's already beyond the background noise floor.





# Compliance Certification Services Inc.

Reference No.: C140328R01-RP1

Report No: C140331R02-RP1

FCC ID: XMR201403GC65

Date of Issue :April 23, 2014

<b>Operation Mode:</b>	GSM 1900 / TX / CH 512	<b>Test Date:</b>	2014-4-21
<b>Temperature:</b>	21°C	<b>Tested by:</b>	Blent.Wang
<b>Humidity:</b>	53 % RH	<b>Polarity:</b>	Ver. / Hor.

Frequency (MHz)	Antenna Polarization	Reading (dBm)	Correction Factor (dB)	Emission level (dBm)	Limit (dBm)	Margin (dB)
3700.000	V	-49.54	5.63	-43.91	-13.00	-30.91
5552.000	V	-53.89	7.47	-46.42	-13.00	-33.42
3700.000	H	-58.17	5.28	-52.89	-13.00	-39.89
5552.000	H	-60.06	7.62	-52.44	-13.00	-39.44

**Remark:**

1. Measuring frequencies from 1 GHz to the 10th harmonic of highest fundamental frequency.
2. Measurements above show only up to 6 maximum emissions noted, or would be lesser, with " N/A " remark, if no specific emissions from the EUT are recorded (ie: margin>20dB from the applicable limit) and considered that's already beyond the background noise floor.



# Compliance Certification Services Inc.

Reference No.: C140328R01-RP1

Report No: C140331R02-RP1

FCC ID: XMR201403GC65

Date of Issue :April 23, 2014

<b>Operation Mode:</b>	GSM 1900 / TX / CH 661	<b>Test Date:</b>	2014-4-21
<b>Temperature:</b>	21°C	<b>Tested by:</b>	Blent.Wang
<b>Humidity:</b>	53 % RH	<b>Polarity:</b>	Ver. / Hor.

Frequency (MHz)	Antenna Polarization	Reading (dBm)	Correction Factor (dB)	Emission level (dBm)	Limit (dBm)	Margin (dB)
3760.000	V	-56.89	6.70	-50.19	-13.00	-37.19
5640.000	V	-52.00	6.98	-45.02	-13.00	-32.02
3748.000	H	-61.86	6.22	-55.64	-13.00	-42.64
5640.000	H	-56.57	7.17	-49.40	-13.00	-36.40

**Remark:**

1. Measuring frequencies from 1 GHz to the 10th harmonic of highest fundamental frequency.
2. Measurements above show only up to 6 maximum emissions noted, or would be lesser, with "N/A" remark, if no specific emissions from the EUT are recorded (ie: margin>20dB from the applicable limit) and considered that's already beyond the background noise floor.



# Compliance Certification Services Inc.

Reference No.: C140328R01-RP1

Report No: C140331R02-RP1

FCC ID: XMR201403GC65

Date of Issue :April 23, 2014

<b>Operation Mode:</b>	GSM 1900 / TX / CH 810	<b>Test Date:</b>	2014-4-21
<b>Temperature:</b>	21°C	<b>Tested by:</b>	Blent.Wang
<b>Humidity:</b>	53 % RH	<b>Polarity:</b>	Ver. / Hor.

Frequency (MHz)	Antenna Polarization	Reading (dBm)	Correction Factor (dB)	Emission level (dBm)	Limit (dBm)	Margin (dB)
3820.000	V	-50.57	7.23	-43.34	-13.00	-30.34
5728.000	V	-52.64	6.90	-45.74	-13.00	-32.74
3679.000	H	-61.22	5.27	-55.95	-13.00	-42.95
5728.000	H	-57.36	6.80	-50.56	-13.00	-37.56

**Remark:**

1. Measuring frequencies from 1 GHz to the 10th harmonic of highest fundamental frequency.
2. Measurements above show only up to 6 maximum emissions noted, or would be lesser, with "N/A" remark, if no specific emissions from the EUT are recorded (ie: margin>20dB from the applicable limit) and considered that's already beyond the background noise floor.



# Compliance Certification Services Inc.

Reference No.: C140328R01-RP1

Report No: C140331R02-RP1

FCC ID: XMR201403GC65

Date of Issue :April 23, 2014

<b>Operation Mode:</b>	GPRS 1900 / TX / CH 512	<b>Test Date:</b>	2014-4-21
<b>Temperature:</b>	21°C	<b>Tested by:</b>	Blent.Wang
<b>Humidity:</b>	53 % RH	<b>Polarity:</b>	Ver. / Hor.

Frequency (MHz)	Antenna Polarization	Reading (dBm)	Correction Factor (dB)	Emission level (dBm)	Limit (dBm)	Margin (dB)
3700.000	V	-55.04	5.63	-49.41	-13.00	-36.41
5552.000	V	-55.89	7.47	-48.42	-13.00	-35.42
3700.000	H	-52.17	5.28	-46.89	-13.00	-33.89
5580.000	H	-56.29	7.66	-48.63	-13.00	-35.63

**Remark:**

1. Measuring frequencies from 1 GHz to the 10th harmonic of highest fundamental frequency.
2. Measurements above show only up to 6 maximum emissions noted, or would be lesser, with " N/A " remark, if no specific emissions from the EUT are recorded (ie: margin>20dB from the applicable limit) and considered that's already beyond the background noise floor.



# Compliance Certification Services Inc.

Reference No.: C140328R01-RP1

Report No: C140331R02-RP1

FCC ID: XMR201403GC65

Date of Issue :April 23, 2014

<b>Operation Mode:</b>	GPRS 1900 / TX / CH 661	<b>Test Date:</b>	2014-4-21
<b>Temperature:</b>	21°C	<b>Tested by:</b>	Blent.Wang
<b>Humidity:</b>	53 % RH	<b>Polarity:</b>	Ver. / Hor.

Frequency (MHz)	Antenna Polarization	Reading (dBm)	Correction Factor (dB)	Emission level (dBm)	Limit (dBm)	Margin (dB)
3760.000	V	-51.39	6.70	-44.69	-13.00	-31.69
5640.000	V	-56.00	6.98	-49.02	-13.00	-36.02
3748.000	H	-55.86	6.22	-49.64	-13.00	-36.64
5640.000	H	-52.57	7.17	-45.40	-13.00	-32.40

**Remark:**

1. Measuring frequencies from 1 GHz to the 10th harmonic of highest fundamental frequency.
2. Measurements above show only up to 6 maximum emissions noted, or would be lesser, with "N/A" remark, if no specific emissions from the EUT are recorded (ie: margin>20dB from the applicable limit) and considered that's already beyond the background noise floor.



# Compliance Certification Services Inc.

Reference No.: C140328R01-RP1

Report No: C140331R02-RP1

FCC ID: XMR201403GC65

Date of Issue :April 23, 2014

<b>Operation Mode:</b>	GPRS 1900 / TX / CH 810	<b>Test Date:</b>	2014-4-21
<b>Temperature:</b>	21°C	<b>Tested by:</b>	Blent.Wang
<b>Humidity:</b>	53 % RH	<b>Polarity:</b>	Ver. / Hor.

Frequency (MHz)	Antenna Polarization	Reading (dBm)	Correction Factor (dB)	Emission level (dBm)	Limit (dBm)	Margin (dB)
3820.000	V	-52.57	7.23	-45.34	-13.00	-32.34
5728.000	V	-48.14	6.90	-41.24	-13.00	-28.24
3691.000	H	-54.55	5.28	-49.27	-13.00	-36.27
5724.000	H	-57.18	6.80	-50.38	-13.00	-37.38

**Remark:**

1. Measuring frequencies from 1 GHz to the 10th harmonic of highest fundamental frequency.
2. Measurements above show only up to 6 maximum emissions noted, or would be lesser, with "N/A" remark, if no specific emissions from the EUT are recorded (ie: margin>20dB from the applicable limit) and considered that's already beyond the background noise floor.



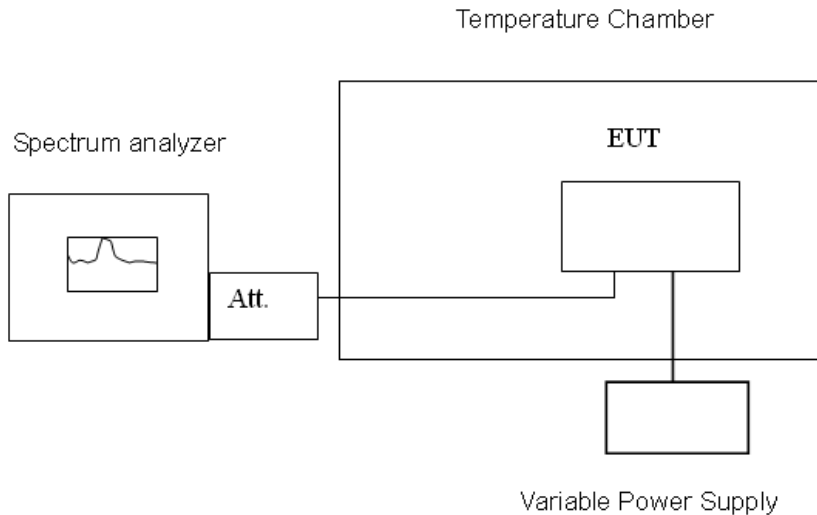
## 7.7. FREQUENCY STABILITY V.S. TEMPERATURE MEASUREMENT

### LIMIT

According to FCC §2.1055, FCC §22.355, .FCC §24.235.

Frequency Tolerance: 2.5 ppm

### TEST CONFIGURATION



**Remark:** Measurement setup for testing on Antenna connector

### TEST PROCEDURE

The equipment under test was connected to an external AC or DC power supply and input rated voltage. RF output was connected to a frequency counter or spectrum analyzer via feed through attenuators. The EUT was placed inside the temperature chamber. Set the spectrum analyzer RBW low enough to obtain the desired frequency resolution and measure EUT 20°C operating frequency as reference frequency. Turn EUT off and set the chamber temperature to -30°C. After the temperature stabilized for approximately 30 minutes recorded the frequency. Repeat step measure with 10°C increased per stage until the highest temperature of +50°C reached.



# Compliance Certification Services Inc.

Reference No.: C140328R01-RP1

Report No: C140331R02-RP1

FCC ID: XMR201403GC65

Date of Issue :April 23, 2014

## TEST RESULTS

No non-compliance noted.

Reference Frequency: GSM Mid Channel 836.6 MHz @ 20°C				
Limit: $\pm 2.5$ ppm = 2091.5 Hz				
Power Supply Vdc	Environment Temperature (°C)	Frequency (Hz)	Delta (Hz)	Limit (Hz)
4.0	55	836600132	132	2091.5
	50	836600129	129	
	40	836600131	131	
	30	836600130	131	
	20	836600133	133	
	10	836600135	135	
	0	836600136	136	
	-5	836600134	134	
	-10	836600137	137	

Reference Frequency: GSM Mid Channel 1880 MHz @ 20°C				
Limit: $\pm 2.5$ ppm = 4700 Hz				
Power Supply Vdc	Environment Temperature (°C)	Frequency (Hz)	Delta (Hz)	Limit (Hz)
4.0	55	1879999889	111	4700
	50	1879999891	109	
	40	1879999889	111	
	30	1879999887	113	
	20	1879999891	109	
	10	1879999892	108	
	0	1879999884	116	
	-5	1879999886	114	
	-10	1879999887	113	





# Compliance Certification Services Inc.

Reference No.: C140328R01-RP1

Report No: C140331R02-RP1

FCC ID: XMR201403GC65

Date of Issue :April 23, 2014

## Reference Frequency: GPRS Mid Channel 836.6 MHz @ 20°C

Limit: +/- 2.5 ppm = 2090 Hz

Power Supply Vdc	Environment Temperature (°C)	Frequency (Hz)	Delta (Hz)	Limit (Hz)
4.0	55	836600123	123	2090
	50	836600121	121	
	40	836600119	119	
	30	836600120	120	
	20	836600124	124	
	10	836600125	125	
	0	836600122	122	
	-5	836600121	121	
	-10	836600122	122	

## Reference Frequency: GPRS Mid Channel 1880 MHz @ 20°C

Limit: ± 2.5 ppm = 4700 Hz

Power Supply Vdc	Environment Temperature (°C)	Frequency (Hz)	Delta (Hz)	Limit (Hz)
4.0	55	1878999885	115	4700
	50	1878999883	117	
	40	1878999879	121	
	30	1878999878	122	
	20	1879999876	124	
	10	1878999865	135	
	0	1878999874	126	
	-5	1878999863	137	
	-10	1878999862	138	

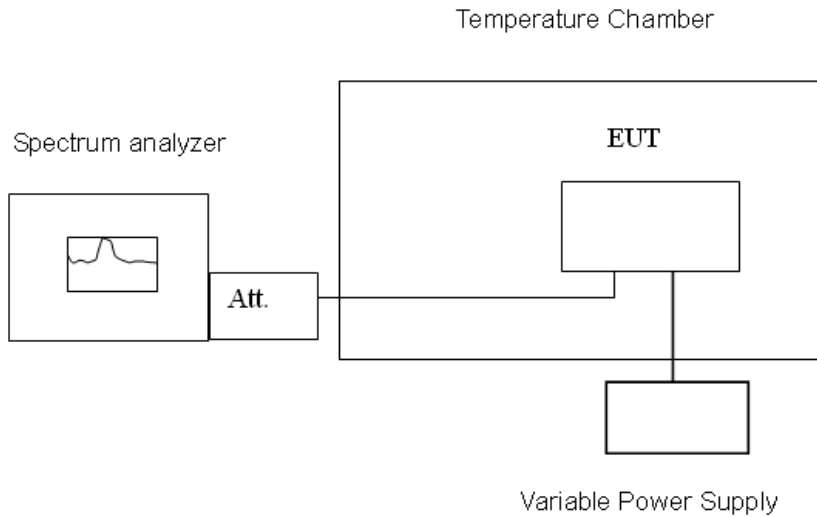


## 7.8. REQUENCY STABILITY V.S. VOLTAGE MEASUREMENT

### LIMIT

According to FCC §2.1055, FCC §22.355, .FCC §24.235,

### TEST CONFIGURATION



**Remark:** Measurement setup for testing on Antenna connector.

### TEST PROCEDURE

Set chamber temperature to 20°C. Use a variable AC power supply / DC power source to power the EUT and set the voltage to rated voltage. Set the spectrum analyzer RBW low enough to obtain the desired frequency resolution and recorded the frequency.

Reduce the input voltage to specify extreme voltage variation ( $\pm 10\%$ ) and endpoint, record the maximum frequency change.



# Compliance Certification Services Inc.

Reference No.: C140328R01-RP1

Report No: C140331R02-RP1

FCC ID: XMR201403GC65

Date of Issue :April 23, 2014

## TEST RESULTS

No non-compliance noted.

Reference Frequency: GPRS Mid Channel 836.6 MHz @ 20°C				
Limit: ± 2.5 ppm = 2090Hz				
Power Supply Vdc	Environment Temperature (°C)	Frequency (Hz)	Delta (Hz)	Limit (Hz)
4.6	20	836599875	125	2090
4.0		836599876	124	
3.3 end		836599878	122	

Reference Frequency: GPRS Mid Channel 1880 MHz @ 20°C				
Limit: ± 2.5 ppm = 4700 Hz				
Power Supply Vdc	Environment Temperature (°C)	Frequency (Hz)	Delta (Hz)	Limit (Hz)
4.6	20	1879999885	115	4700
4.0		1879999884	116	
3.3 end		1879999874	126	



## 7.9. POWERLINE CONDUCTED EMISSIONS

### LIMIT

For an intentional radiator which is designed to be connected to the public utility (AC) power line, the radio frequency voltage that is conducted back onto the AC power line on any frequency or frequencies within the band 150 kHz to 30 MHz shall not exceed 250 microvolts (The limit decreases linearly with the logarithm of the frequency in the range 0.15 MHz to 0.50 MHz). The limits at specific frequency range is listed as follows:

Frequency Range (MHz)	Limits (dB $\mu$ V)	
	Quasi-peak	Average
0.15 to 0.50	66 to 56	56 to 46
0.50 to 5	56	46
5 to 30	60	50

Compliance with this provision shall be based on the measurement of the radio frequency voltage between each power line (LINE and NEUTRAL) and ground at the power terminals.

### TEST CONFIGURATION

See test photographs attached in Appendix I for the actual connections between EUT and support equipment.

### TEST PROCEDURE

1. The EUT was placed on a table, which is 0.8m above ground plane.
2. Maximum procedure was performed on the six highest emissions to ensure EUT compliance.
3. Repeat above procedures until all frequency measured were complete.



# Compliance Certification Services Inc.

Reference No.: C140328R01-RP1

Report No: C140331R02-RP1

FCC ID: XMR201403GC65

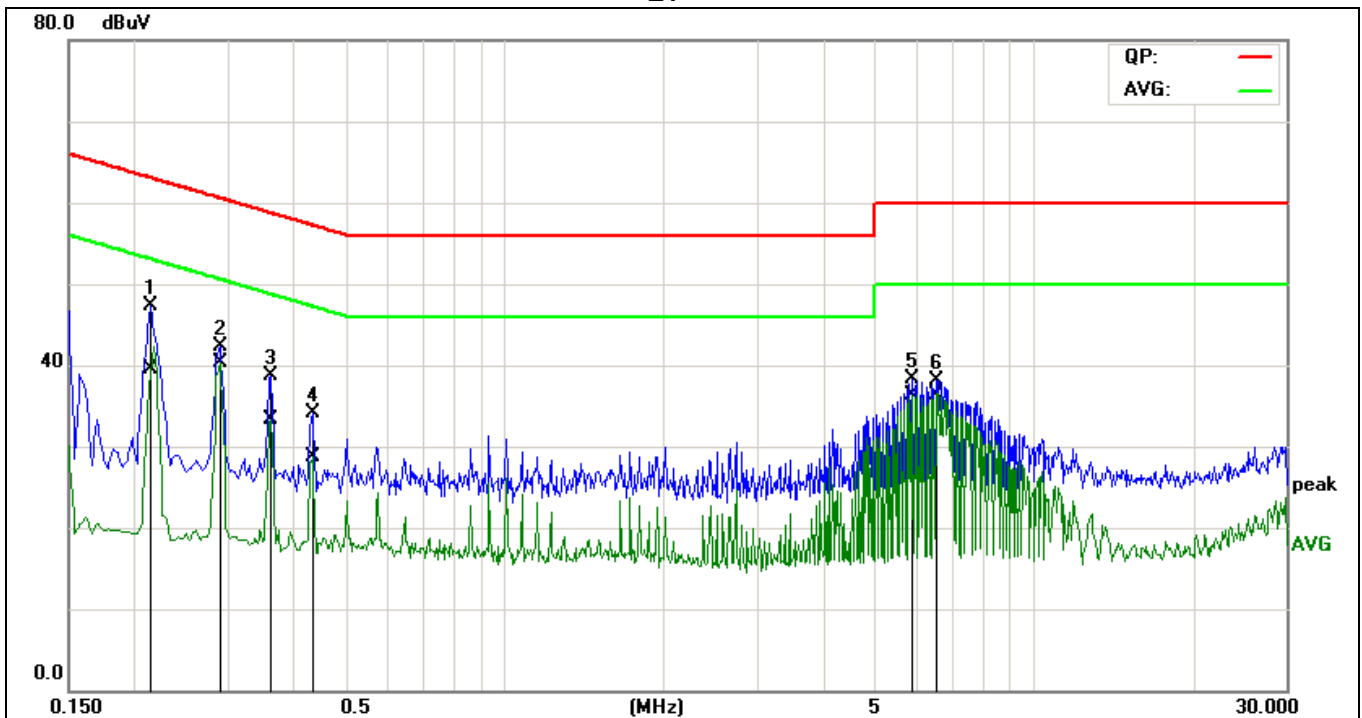
Date of Issue :April 23, 2014

## TEST RESULTS

The initial step in collecting conducted data is a spectrum analyzer peak scan of the measurement range. Significant peaks are then marked as shown on the following data page, and these signals are then quasi-peaked.

<b>Operation Mode:</b>	Normal Link	<b>Test Date:</b>	2014-4-21
<b>Temperature:</b>	23°C	<b>Tested by:</b>	Blent.Wang
<b>Humidity:</b>	50% RH		

L1



No.	Frequency (MHz)	QuasiPeak reading (dBuV)	Average reading (dBuV)	Correction factor (dB)	QuasiPeak result (dBuV)	Average result (dBuV)	QuasiPeak limit (dBuV)	Average limit (dBuV)	QuasiPeak margin (dB)	Average margin (dB)	Remark
1	0.2140	27.65	19.80	19.61	47.26	39.41	63.05	53.05	-15.79	-13.64	Pass
2	0.2900	22.67	20.55	19.67	42.34	40.22	60.52	50.52	-18.18	-10.30	Pass
3*	0.3620	19.01	13.52	19.72	38.73	33.24	58.68	48.68	-19.95	-15.44	Pass
4	0.4340	14.41	8.97	19.78	34.19	28.75	57.18	47.18	-22.99	-18.43	Pass
5	5.9060	17.89	16.00	20.39	38.28	36.39	60.00	50.00	-21.72	-13.61	Pass
6	6.5540	17.68	15.95	20.45	38.13	36.40	60.00	50.00	-21.87	-13.60	Pass

### Remark:

1. Measuring frequencies from 0.15 MHz to 30MHz.
2. The emissions measured in frequency range from 0.15 MHz to 30MHz were made with an instrument using Quasi-peak detector and average detector.
3. The IF bandwidth of SPA between 0.15MHz to 30MHz was 10kHz; the IF bandwidth of Test Receiver between 0.15MHz to 30MHz was 9kHz;
4. L1 = Line One (Live Line) / L2 = Line Two (Neutral Line)

"-" means Quasi-peak reading value also meets average limit and measurement with the average detector is unnecessary



# Compliance Certification Services Inc.

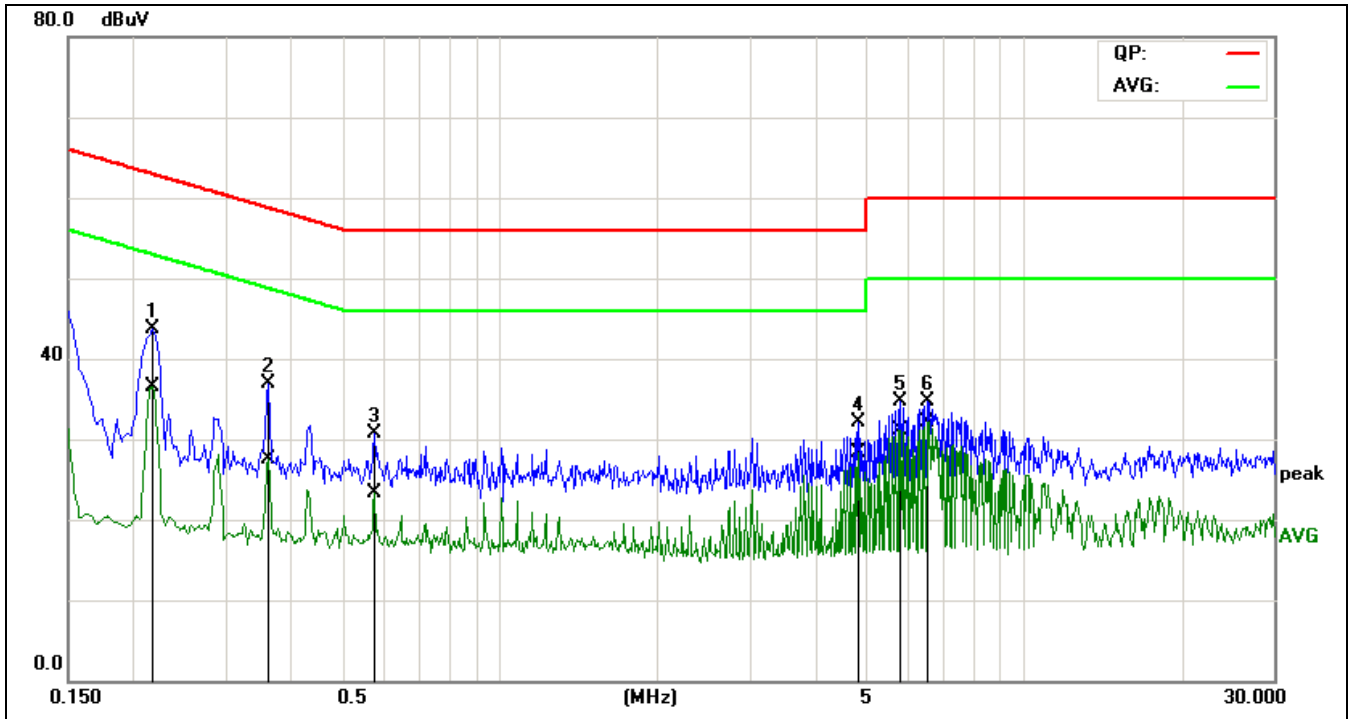
Reference No.: C140328R01-RP1

Report No: C140331R02-RP1

FCC ID: XMR201403GC65

Date of Issue :April 23, 2014

## L2



No.	Frequency (MHz)	QuasiPeak reading (dBuV)	Average reading (dBuV)	Correction factor (dB)	QuasiPeak result (dBuV)	Average result (dBuV)	QuasiPeak limit (dBuV)	Average limit (dBuV)	QuasiPeak margin (dB)	Average margin (dB)	Remark
1	0.2180	24.00	16.89	19.65	43.65	36.54	62.89	52.89	-19.24	-16.35	Pass
2	0.3620	17.14	7.82	19.75	36.89	27.57	58.68	48.68	-21.79	-21.11	Pass
3	0.5780	10.83	3.46	19.85	30.68	23.31	56.00	46.00	-25.32	-22.69	Pass
4	4.8260	11.88	8.04	20.28	32.16	28.32	56.00	46.00	-23.84	-17.68	Pass
5*	5.8340	14.31	10.81	20.39	34.70	31.20	60.00	50.00	-25.30	-18.80	Pass
6	6.5540	14.31	11.71	20.46	34.77	32.17	60.00	50.00	-25.23	-17.83	Pass

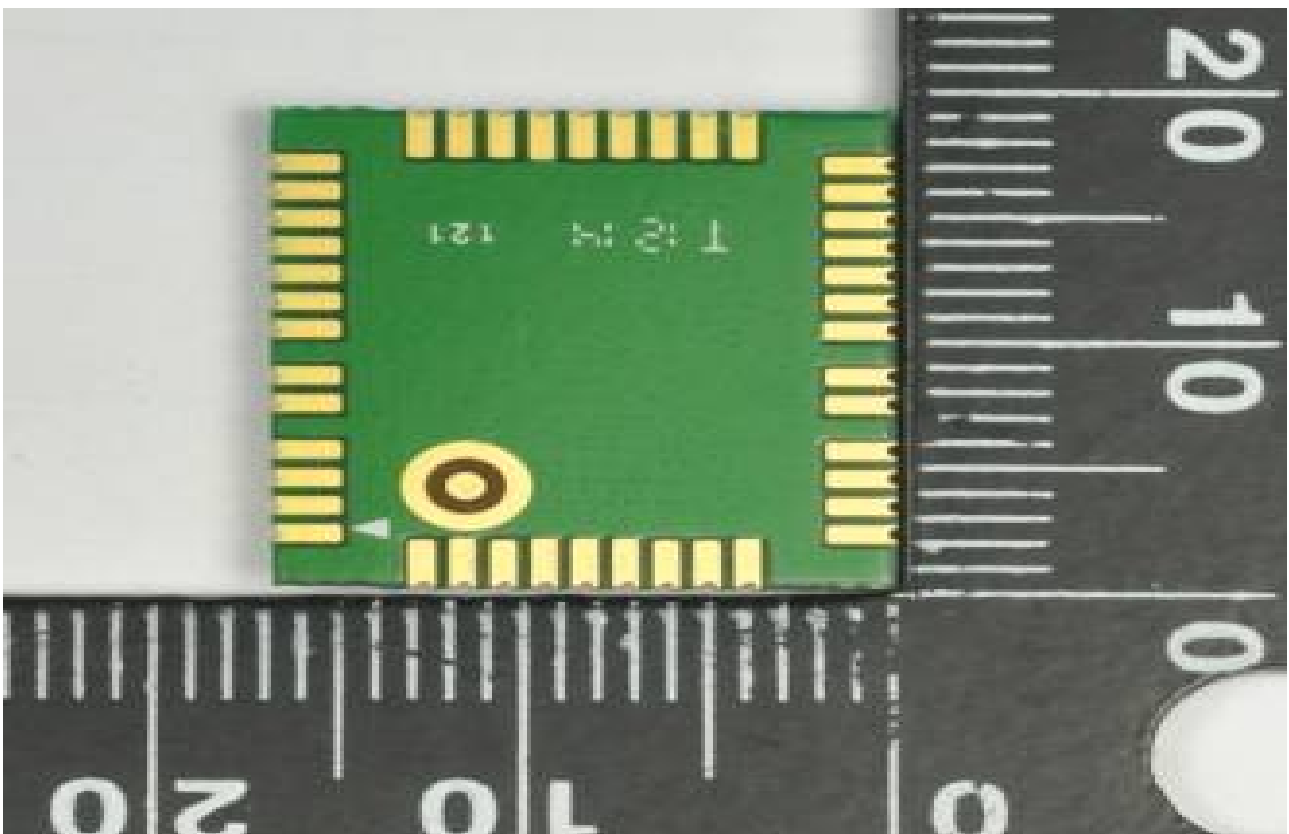
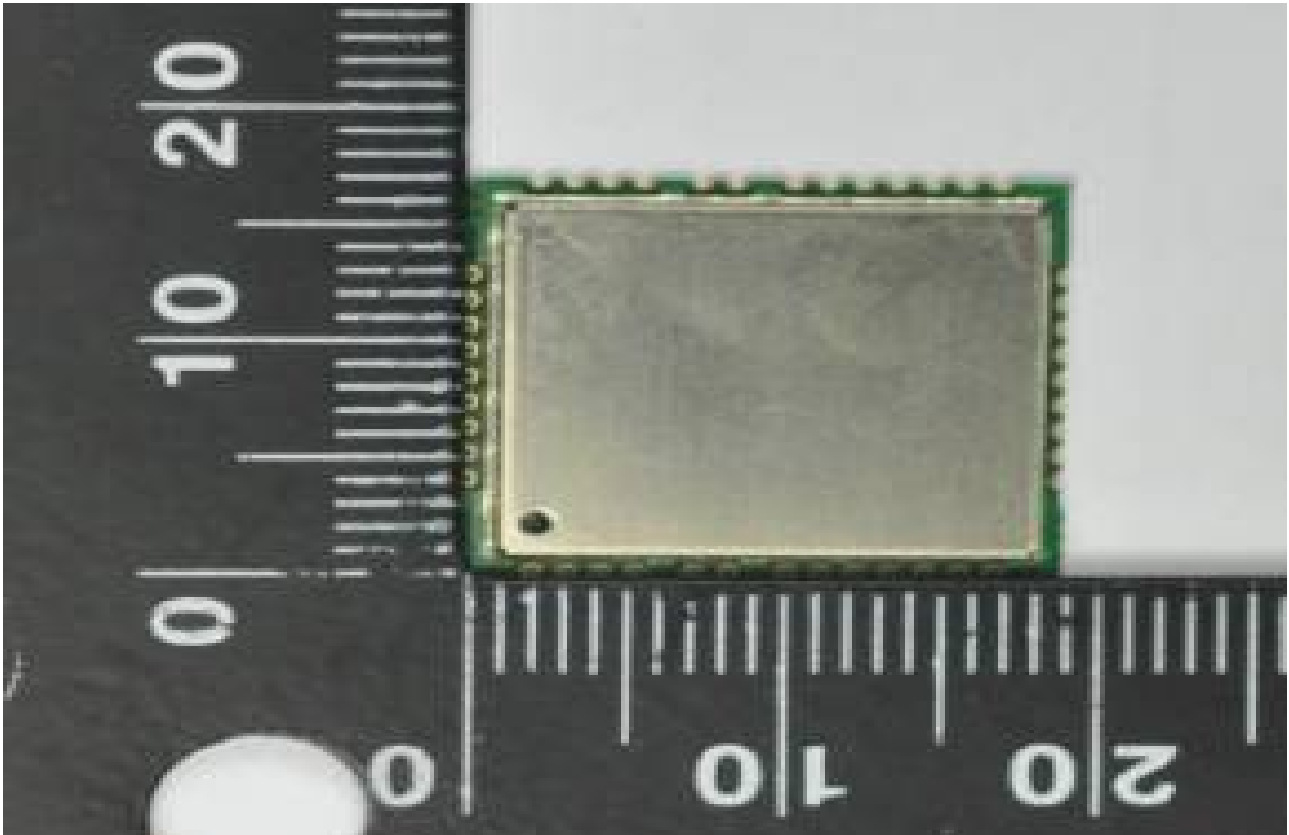
**Remark:**

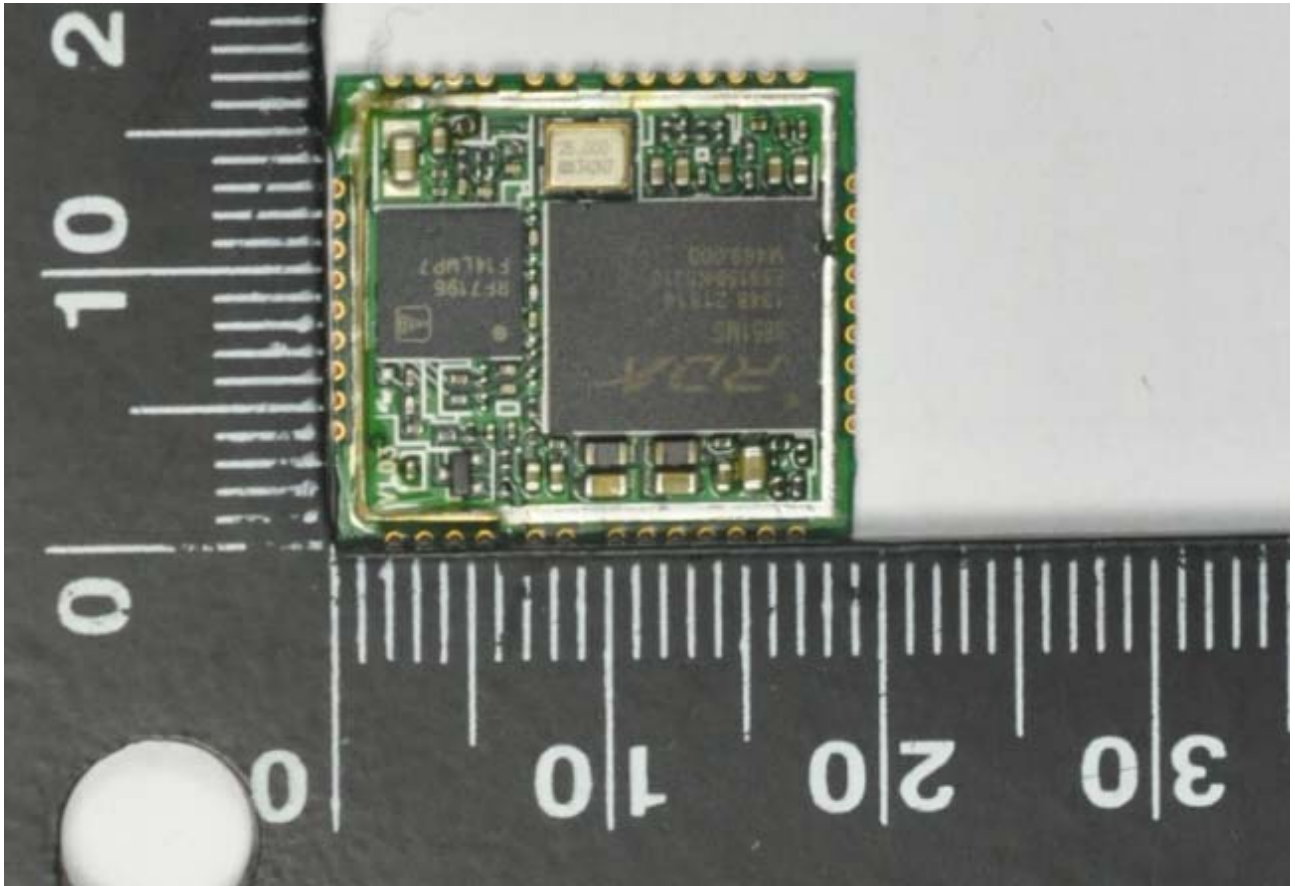
5. Measuring frequencies from 0.15 MHz to 30MHz.
6. The emissions measured in frequency range from 0.15 MHz to 30MHz were made with an instrument using Quasi-peak detector and average detector.
7. The IF bandwidth of SPA between 0.15MHz to 30MHz was 10kHz; the IF bandwidth of Test Receiver between 0.15MHz to 30MHz was 9kHz;
8. L1 = Line One (Live Line) / L2 = Line Two (Neutral Line)

"-" means Quasi-peak reading value also meets average limit and measurement with the average detector is unnecessary



## APPENDIX I: PHOTOS OF EUT





**END OF REPORT**