

FCC Radio Test Report

FCC ID: XMF-MID721-U

Original Grant

Report No. : TB-FCC140177
Applicant : Lightcomm Technology Co., Ltd.
Equipment Under Test (EUT)
EUT Name : MID
Model No. : MID721-U
Serial No. : MID713-U, MID710-U, DL700D, DL700D(B),
D2-741G_XX(XX represents different color)
Brand Name : N/A
Receipt Date : 2014-04-28
Test Date : 2014-04-28 to 2014-05-06
Issue Date : 2014-05-07
Standards : FCC Part 15, Subpart C (15.247:2012)
Test Method : ANSI C63.4:2003
Conclusions : **PASS**

In the configuration tested, the EUT complied with the standards specified above,

The EUT technically complies with the FCC and IC requirements

Test/Witness Engineer :

IVAN SU

Approved & Authorized :

Ray

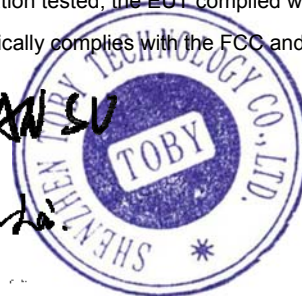

This report details the results of the testing carried out on one sample. The results contained in this test report do not relate to other samples of the same product. The manufacturer should ensure that all products in series production are in conformity with the product sample detailed in the report.

Contents

CONTENTS.....	2
1. GENERAL INFORMATION ABOUT EUT	4
1.1 Client Information.....	4
1.2 General Description of EUT (Equipment Under Test)	4
1.3 Block Diagram Showing the Configuration of System Tested.....	5
1.4 Description of Support Units	5
1.5 Description of Test Mode.....	6
1.6 Description of Test Software Setting	7
1.7 Test Facility.....	8
2. TEST SUMMARY	9
3. CONDUCTED EMISSION TEST	10
3.1 Test Standard and Limit.....	10
3.2 Test Setup.....	10
3.3 Test Procedure.....	10
3.4 Test Equipment Used.....	11
3.5 EUT Operating Mode	11
3.6 Test Data.....	11
4. RADIATED EMISSION TEST	16
4.1 Test Standard and Limit.....	16
4.2 Test Setup.....	17
4.3 Test Procedure.....	18
4.4 EUT Operating Condition	18
4.5 Test Equipment	18
4.6 Test Data.....	19
5. RESTRICTED BANDS REQUIREMENT	48
5.1 Test Standard and Limit.....	48
5.2 Test Setup.....	48
5.3 Test Procedure.....	48
5.4 EUT Operating Condition	49
5.5 Test Equipment	49
5.6 Test Data.....	49
6. BANDWIDTH TEST	78
6.1 Test Standard and Limit.....	78
6.2 Test Setup.....	78
6.3 Test Procedure.....	78
6.4 EUT Operating Condition	78
6.5 Test Equipment	78
6.6 Test Data.....	79
7. PEAK OUTPUT POWER TEST.....	87

7.1 Test Standard and Limit.....	87
7.2 Test Setup.....	87
7.3 Test Procedure.....	87
7.4 EUT Operating Condition	87
7.5 Test Equipment	87
7.6 Test Data.....	87
8. POWER SPECTRAL DENSITY TEST	96
8.1 Test Standard and Limit.....	96
8.2 Test Setup.....	96
8.3 Test Procedure.....	96
8.4 EUT Operating Condition	96
8.5 Test Equipment	96
8.6 Test Data.....	96
9. ANTENNA CONDUCTED SPURIOUS EMISSION	105
9.1 Test Standard and Limit.....	105
9.2 Test Setup.....	105
9.3 Test Procedure.....	105
9.4 EUT Operating Condition	106
9.5 Test Equipment	106
9.6 Test Data.....	106
10. ANTENNA REQUIREMENT.....	119
10.1 Standard Requirement.....	119
10.2 Antenna Connected Construction	119
10.2 Result.....	119

1. General Information about EUT

1.1 Client Information

Applicant : Lightcomm Technology Co., Ltd.
Address : RM 1708-10, 17/F, PROSPERITY CENTRE, 25 CHONG YIP STREET, KWUN TONG, KOWLOON, HONG KONG
Manufacturer : Huizhou Hengdu Electronics Co., Ltd.
Address : DIP South Area, Huiao Highway, Huizhou, Guangdong, China

1.2 General Description of EUT (Equipment Under Test)

EUT Name	:	MID		
Models No.	:	MID713-U, MID710-U, DL700D, DL700D(B), D2-741G_XX(XX represents different color)		
Model Difference	:	DL700D, DL700D(B) doesn't have the back camera and DC input jack, the other models are identical in the same PCB layout, interior structure and electrical circuits, The only difference is model name for commercial purpose.		
Product Description	:	Operation Frequency: 802.11b/g/n(HT20): 2412MHz~2462MHz 802.11b/g/n(HT40): 2422MHz~2452MHz		
	:	<table border="1"> <tr> <td>Number of Channel:</td> <td>802.11b/g/n(HT20):11 channels see note(3) 802.11b/g/n(HT40): 7 channels see note(3)</td> </tr> </table>	Number of Channel:	802.11b/g/n(HT20):11 channels see note(3) 802.11b/g/n(HT40): 7 channels see note(3)
	Number of Channel:	802.11b/g/n(HT20):11 channels see note(3) 802.11b/g/n(HT40): 7 channels see note(3)		
	:	<table border="1"> <tr> <td>RF Output Power:</td> <td>802.11b: 9.40 dBm 802.11g: 9.51 dBm 802.11n (HT20): 9.46 dBm 802.11n (HT40): 9.46 dBm</td> </tr> </table>	RF Output Power:	802.11b: 9.40 dBm 802.11g: 9.51 dBm 802.11n (HT20): 9.46 dBm 802.11n (HT40): 9.46 dBm
	RF Output Power:	802.11b: 9.40 dBm 802.11g: 9.51 dBm 802.11n (HT20): 9.46 dBm 802.11n (HT40): 9.46 dBm		
	:	<table border="1"> <tr> <td>Antenna Gain:</td> <td>0 dBi (PIFA Antenna)</td> </tr> </table>	Antenna Gain:	0 dBi (PIFA Antenna)
	Antenna Gain:	0 dBi (PIFA Antenna)		
:	<table border="1"> <tr> <td>Modulation Type:</td> <td>802.11b: DSSS (CCK, QPSK, BPSK) 802.11g: OFDM 802.11n: OFDM</td> </tr> </table>	Modulation Type:	802.11b: DSSS (CCK, QPSK, BPSK) 802.11g: OFDM 802.11n: OFDM	
Modulation Type:	802.11b: DSSS (CCK, QPSK, BPSK) 802.11g: OFDM 802.11n: OFDM			
:	<table border="1"> <tr> <td>Bit Rate of Transmitter:</td> <td>802.11b:11/5.5/2/1 Mbps 802.11g:54/48/36/24/18/12/9/6 Mbps 802.11n:up to 150Mbps</td> </tr> </table>	Bit Rate of Transmitter:	802.11b:11/5.5/2/1 Mbps 802.11g:54/48/36/24/18/12/9/6 Mbps 802.11n:up to 150Mbps	
Bit Rate of Transmitter:	802.11b:11/5.5/2/1 Mbps 802.11g:54/48/36/24/18/12/9/6 Mbps 802.11n:up to 150Mbps			
Power Supply	:	DC power supplied by AC/DC Adapter DC Voltage supplied from Li-Polymer battery.		
Power Rating	:	USB DC 5V form PC. AC/DC Adapter(TEKA01-0502000UK) 1# (DC Power Jack): Input: AC 100~240V 50/60Hz 0.35A Max. Output: DC 5V 2A AC/DC Adapter(TEKA01-0502000UK) 2# (USB Port): Input: AC 100~240V 50/60Hz 0.35A Max. Output: DC 5V 2A		

		DC 3.7V 2100mAh from Li-Polymer battery
Connecting I/O Port(S)	:	The equipment have USB port for link with PC, so the equipment is considered as a Computing Device Peripheral. Please refer to the User's Manual

Note:

- (1) This Test Report is FCC Part 15.247 for 802.11b/g/n, the test procedure follows the FCC KDB 558074 D01 DTS Meas Guidance v03r01.
- (2) For a more detailed features description, please refer to the manufacturer's specifications or the User's Manual.
- (3) Antenna information provided by the applicant.
- (4) Channel List:
 CH 01~CH 11 for 802.11b/g/n(HT20)
 CH 03~CH 09 for 802.11b/g/n(HT20)

Channel	Frequency (MHz)	Channel	Frequency (MHz)	Channel	Frequency (MHz)
01	2412	05	2432	09	2452
02	2417	06	2437	10	2457
03	2422	07	2442	11	2462
04	2427	08	2447		

1.3 Block Diagram Showing the Configuration of System Tested

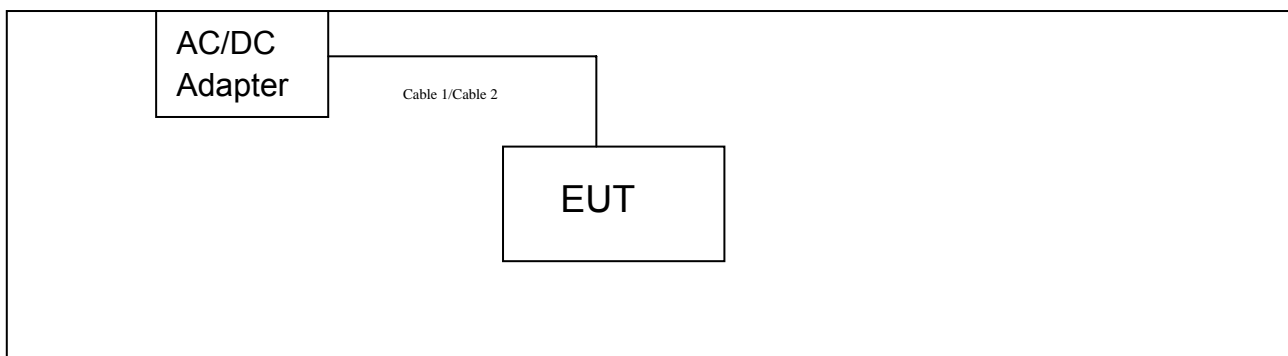
TX Mode

1.4 Description of Support Units

Equipment Information				
Name	Model	S/N	Manufacturer	Used "√"
/	/	/	/	/
Cable Information				
Number	Shielded Type	Ferrite Core	Length	Note

Cable 1	NO	NO	1.0M	Accessories
Cable 2	NO	NO	1.0M	Accessories

1.5 Description of Test Mode

To investigate the maximum EMI emission characteristics generates from EUT, the test system was pre-scanning tested base on the consideration of following EUT operation mode or test configuration mode which possible have effect on EMI emission level. Each of these EUT operation mode(s) or test configuration mode(s) mentioned follow was evaluated respectively.

For Conducted Test	
Final Test Mode	Description
Mode 1	AC Charging with TX B Mode
Note: Test with Adapter 1# and 2#	

For Radiated Test	
Final Test Mode	Description
Mode 3	TX Mode B Mode Channel 01/06/11
Mode 4	TX Mode G Mode Channel 01/06/11
Mode 5	TX Mode N(HT20) Mode Channel 01/06/11
Mode 6	TX Mode N(HT40) Mode Channel 01/06/11
Note: Pre-Test with Adapter 1# and 2#, and only show the worst mode data with Adapter 2#.	

Note:

- (1) For all test, we have verified the construction and function in typical operation. And all the test modes were carried out with the EUT in transmitting operation in maximum power with all kinds of data rate.

According to ANSI C63.4 standards, the measurements are performed at the highest, middle, lowest available channels, and the worst case data rate as follows:

- 802.11b Mode: CCK (1 Mbps)
- 802.11g Mode: OFDM (6 Mbps)
- 802.11n (HT20) Mode: MCS 0 (6.5 Mbps)
- 802.11n (HT40) Mode: MCS 0 (13 Mbps)

- (2) During the testing procedure, the continuously transmitting with the maximum power mode was programmed by the customer.
- (3) The EUT is considered a mobile unit; in normal use it was positioned on X-plane. The worst case was found positioned on X-plane. Therefore only the test data of this X-plane was used for radiated emission measurement test.

1.6 Description of Test Software Setting

During testing channel & Power controlling software provided by the customer was used to control the operating channel as well as the output power level. The RF output power selection is for the setting of RF output power expected by the customer and is going to be fixed on the firmware of the final end product power parameters of WLAN.

Test Software Version	Test Program: Realtek MP Tool.apk		
Channel	CH 01	CH 06	CH 11
IEEE 802.11b DSSS	27	25	26
IEEE 802.11g OFDM	27	28	28
IEEE 802.11n (HT20)	27	27	28
Channel	CH 03	CH 06	CH 09
IEEE 802.11n (HT40)	29	28	28

1.7 Test Facility

The testing was performed by the Shenzhen Toby Technology Co., Ltd., in their facilities located at:

1A/F., Bldg.6, Yusheng Industrial Zone, The National Road No.107 Xixiang Section 467, Xixiang, Bao'an, Shenzhen, Guangdong, China.

At the time of testing, the following bodies accredited the Laboratory:

The Laboratory has been accredited by CNAS to ISO/IEC 17025: 2005 General Requirements for the Competence of Testing and Calibration Laboratories for the competence in the field of testing. And the Registration No.: CNAS L5813.

The Laboratory is listed in the United States of American Federal Communications Commission (FCC), and the registration number is 811562.

2. Test Summary

FCC Part 15 Subpart C(15.247)/RSS-210: 2010				
Standard Section		Test Item	Judgment	Remark
FCC	IC			
15.203	/	Antenna Requirement	PASS	N/A
15.207	RSS-GEN 7.2.4	Conducted Emission	PASS	N/A
15.205	RSS-GEN 7.2.2	Restricted Bands	PASS	N/A
15.247(a)(2)	RSS-210 A.8.2(a)	6dB Bandwidth	PASS	N/A
15.247(b)	RSS-210 A.8.4(4)	Peak Output Power	PASS	N/A
15.247(e)	RSS-210 A.8.2(b)	Power Spectral Density	PASS	N/A
15.247(d)	RSS-210 Annex 8 (A8.5)	Transmitter Radiated Spurious Emission	PASS	N/A
15.247(d)	RSS-210 Annex 8 (A8.5)	Antenna Conducted Spurious Emission	PASS	N/A

Note: "/" for no requirement for this test item.
N/A is an abbreviation for Not Applicable.

3. Conducted Emission Test

3.1 Test Standard and Limit

3.1.1 Test Standard

FCC Part 15.207

3.1.2 Test Limit

Conducted Emission Test Limit

Frequency	Maximum RF Line Voltage (dB μ V)	
	Quasi-peak Level	Average Level
150kHz~500kHz	66 ~ 56 *	56 ~ 46 *
500kHz~5MHz	56	46
5MHz~30MHz	60	50

Notes:

- (1) *Decreasing linearly with logarithm of the frequency.
- (2) The lower limit shall apply at the transition frequencies.
- (3) The limit decrease in line with the logarithm of the frequency in the range of 0.15 to 0.50MHz.

3.2 Test Setup

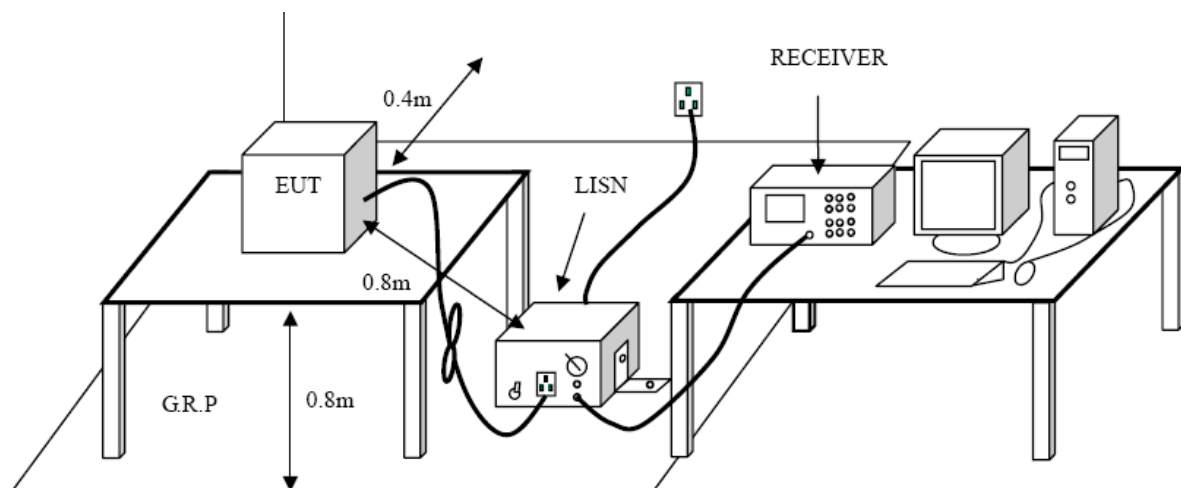

3.3 Test Procedure

The EUT was placed 0.8 meters from the horizontal ground plane with EUT being connected to the power mains through a line impedance stabilization network (LISN). All other support equipments powered from additional LISN(s). The LISN provide 50 Ohm/ 50uH of coupling impedance for the measuring instrument.

Interconnecting cables that hang closer than 40 cm to the ground plane shall be folded back and forth in the center forming a bundle 30 to 40 cm long.

I/O cables that are not connected to a peripheral shall be bundled in the center. The end of the cable may be terminated, if required, using the correct terminating impedance. The overall length shall not exceed 1 m.

LISN at least 80 cm from nearest part of EUT chassis.

The bandwidth of EMI test receiver is set at 9kHz, and the test frequency band is from 0.15MHz to 30MHz.

3.4 Test Equipment Used

Description	Manufacturer	Model No.	Serial No.	Cal. Date	Cal. Due Date
EMI Test Receiver	ROHDE & SCHWARZ	ESCI	100321	2013-08-10	2014-08-09
50Ω Coaxial Switch	Anritsu	MP59B	X10321	2013-08-10	2014-08-09
L.I.S.N	Rohde & Schwarz	ENV216	101131	2013-08-10	2014-08-09
L.I.S.N	SCHWARZBECK	NNBL 8226-2	8226-2/164	2013-08-10	2014-08-09

3.5 EUT Operating Mode

Please refer to the description of test mode.

3.6 Test Data

Please see the next page.

EUT:	MID	Model Name :	MID713-U
Temperature:	25 °C	Relative Humidity:	55%
Test Voltage:	AC 120V/60 Hz		
Terminal:	Line		
Test Mode:	AC Charging with TX B Mode		
Remark:	Adapter 1#		

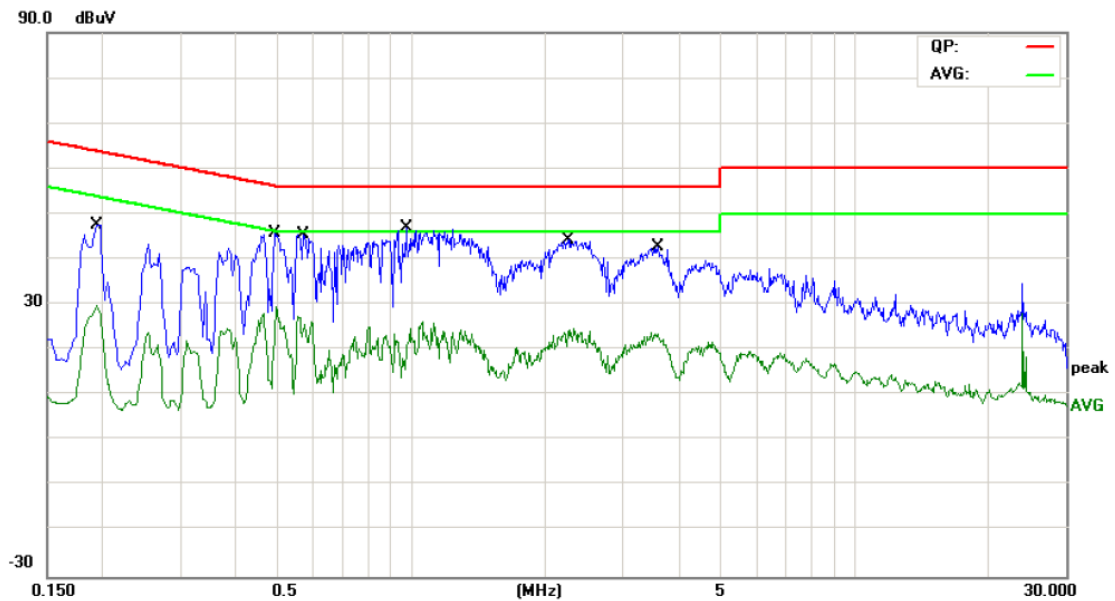

No.	Mk.	Freq. MHz	Reading Level dBuV	Correct Factor dB	Measure- ment dBuV	Limit dBuV	Over dB	Detector	Comment
1		0.1940	32.90	10.01	42.91	63.86	-20.95	QP	
2		0.1940	18.02	10.01	28.03	53.86	-25.83	AVG	
3	*	0.4900	32.62	10.02	42.64	56.17	-13.53	QP	
4		0.4900	14.84	10.02	24.86	46.17	-21.31	AVG	
5		0.5700	30.93	10.05	40.98	56.00	-15.02	QP	
6		0.5700	14.43	10.05	24.48	46.00	-21.52	AVG	
7		0.9700	27.48	10.07	37.55	56.00	-18.45	QP	
8		0.9700	6.83	10.07	16.90	46.00	-29.10	AVG	
9		2.2580	28.00	10.05	38.05	56.00	-17.95	QP	
10		2.2580	11.68	10.05	21.73	46.00	-24.27	AVG	
11		3.5860	25.36	10.01	35.37	56.00	-20.63	QP	
12		3.5860	10.97	10.01	20.98	46.00	-25.02	AVG	

Emission Level= Read Level+ Correct Factor

EUT:	MID	Model Name :	MID713-U
Temperature:	25 °C	Relative Humidity:	55%
Test Voltage:	AC 120V/60 Hz		
Terminal:	Neutral		
Test Mode:	AC Charging with TX B Mode		
Remark:	Adapter 1#		

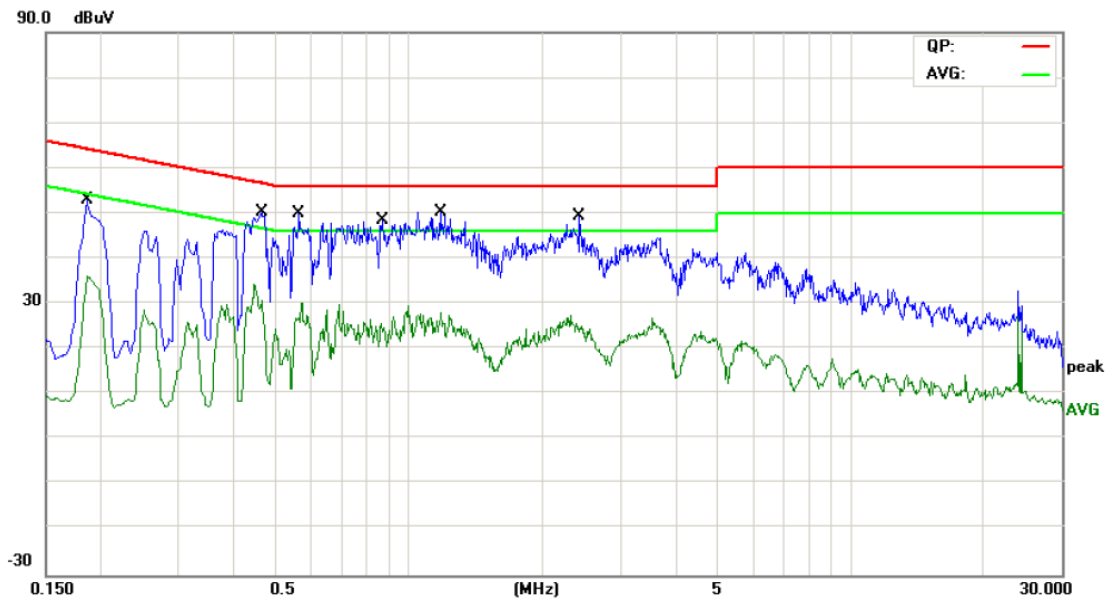

No.	Mk.	Freq.	Reading Level	Correct Factor	Measurement	Limit	Over	Detector	Comment
		MHz	dBuV	dB	dBuV	dBuV	dB		
1		0.1860	36.06	10.12	46.18	64.21	-18.03	QP	
2		0.1860	20.86	10.12	30.98	54.21	-23.23	AVG	
3	*	0.4620	34.41	10.03	44.44	56.66	-12.22	QP	
4		0.4620	17.45	10.03	27.48	46.66	-19.18	AVG	
5		0.5620	32.77	10.02	42.79	56.00	-13.21	QP	
6		0.5620	16.07	10.02	26.09	46.00	-19.91	AVG	
7		0.8700	30.36	10.10	40.46	56.00	-15.54	QP	
8		0.8700	13.60	10.10	23.70	46.00	-22.30	AVG	
9		1.1740	30.43	10.14	40.57	56.00	-15.43	QP	
10		1.1740	14.29	10.14	24.43	46.00	-21.57	AVG	
11		2.4260	27.22	10.06	37.28	56.00	-18.72	QP	
12		2.4260	12.47	10.06	22.53	46.00	-23.47	AVG	

Emission Level= Read Level+ Correct Factor

EUT:	MID	Model Name :	MID713-U
Temperature:	25 °C	Relative Humidity:	55%
Test Voltage:	AC 120V/60 Hz		
Terminal:	Line		
Test Mode:	AC Charging with TX B Mode		
Remark:	Adapter 2#		

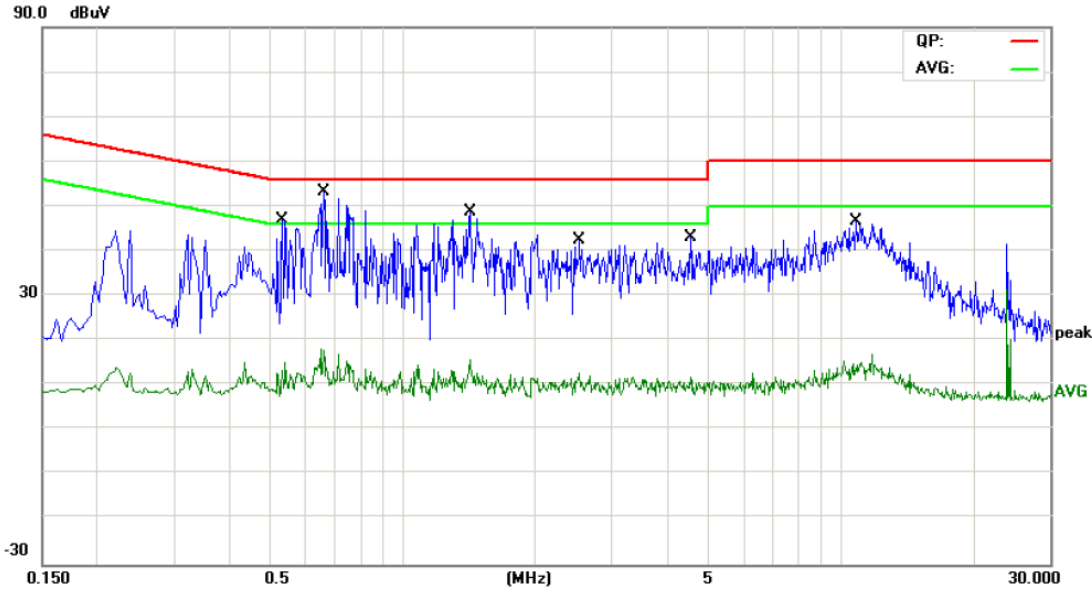

No.	Mk.	Freq.	Reading Level	Correct Factor	Measurement	Limit	Over	Detector	Comment
		MHz	dBuV	dB	dBuV	dBuV	dB		
1		0.5299	25.80	10.03	35.83	56.00	-20.17	QP	
2		0.5299	0.79	10.03	10.82	46.00	-35.18	AVG	
3	*	0.6580	30.91	10.10	41.01	56.00	-14.99	QP	
4		0.6580	4.29	10.10	14.39	46.00	-31.61	AVG	
5		1.4220	25.94	10.06	36.00	56.00	-20.00	QP	
6		1.4220	0.93	10.06	10.99	46.00	-35.01	AVG	
7		2.5300	20.22	10.04	30.26	56.00	-25.74	QP	
8		2.5300	-0.48	10.04	9.56	46.00	-36.44	AVG	
9		4.5260	18.58	9.98	28.56	56.00	-27.44	QP	
10		4.5260	-1.39	9.98	8.59	46.00	-37.41	AVG	
11		10.8420	22.65	10.18	32.83	60.00	-27.17	QP	
12		10.8420	1.28	10.18	11.46	50.00	-38.54	AVG	

Emission Level= Read Level+ Correct Factor

EUT:	MID	Model Name :	MID713-U
Temperature:	25 °C	Relative Humidity:	55%
Test Voltage:	AC 120V/60 Hz		
Terminal:	Neutral		
Test Mode:	AC Charging with TX B Mode		
Remark:	Adapter 2#		

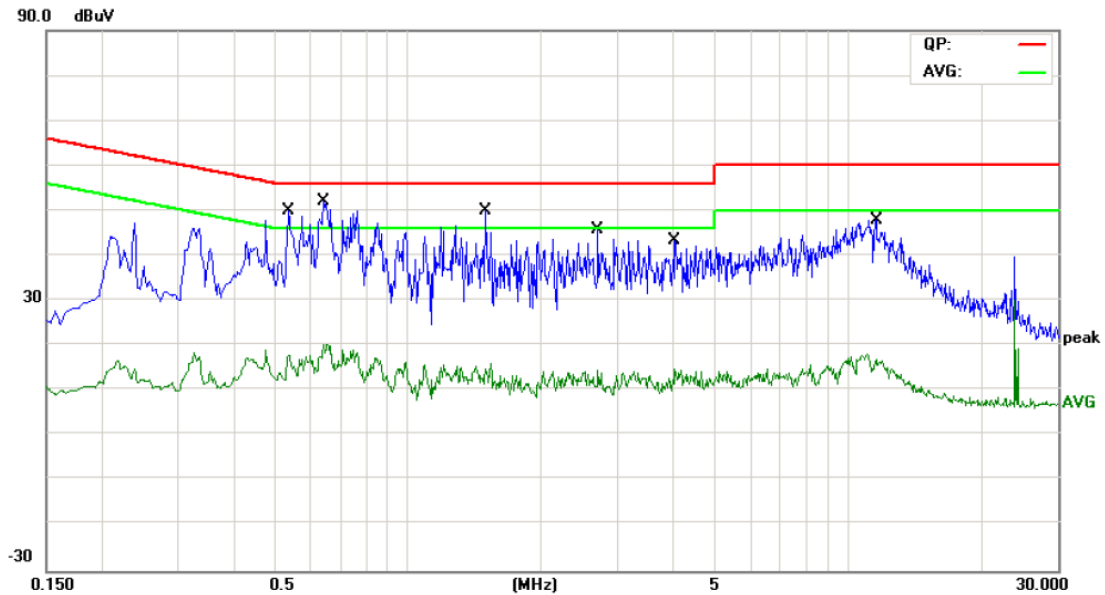

No.	Mk.	Freq.	Reading Level	Correct Factor	Measurement	Limit	Over	Detector	Comment
		MHz	dBuV	dB	dBuV	dBuV	dB		
1		0.5340	30.50	10.02	40.52	56.00	-15.48	QP	
2		0.5340	6.33	10.02	16.35	46.00	-29.65	AVG	
3	*	0.6419	31.17	10.02	41.19	56.00	-14.81	QP	
4		0.6419	7.35	10.02	17.37	46.00	-28.63	AVG	
5		1.4980	22.86	10.11	32.97	56.00	-23.03	QP	
6		1.4980	2.20	10.11	12.31	46.00	-33.69	AVG	
7		2.7060	19.17	10.06	29.23	56.00	-26.77	QP	
8		2.7060	0.86	10.06	10.92	46.00	-35.08	AVG	
9		4.0420	21.28	10.06	31.34	56.00	-24.66	QP	
10		4.0420	1.78	10.06	11.84	46.00	-34.16	AVG	
11		11.5980	22.21	10.13	32.34	60.00	-27.66	QP	
12		11.5980	3.72	10.13	13.85	50.00	-36.15	AVG	

Emission Level= Read Level+ Correct Factor

4. Radiated Emission Test

4.1 Test Standard and Limit

4.1.1 Test Standard

FCC Part 15.209

4.1.2 Test Limit

Radiated Emission Limits (9kHz~1000MHz)

Frequency (MHz)	Field Strength (microvolt/meter)	Measurement Distance (meters)
0.009~0.490	2400/F(KHz)	300
0.490~1.705	24000/F(KHz)	30
1.705~30.0	30	30
30~88	100	3
88~216	150	3
216~960	200	3
Above 960	500	3

Radiated Emission Limit (Above 1000MHz)

Frequency (MHz)	Class A (dBuV/m)(at 3 M)		Class B (dBuV/m)(at 3 M)	
	Peak	Average	Peak	Average
Above 1000	80	60	74	54

Note:

- (1) The tighter limit applies at the band edges.
- (2) Emission Level(dBuV/m)=20log Emission Level(uV/m)

4.2 Test Setup

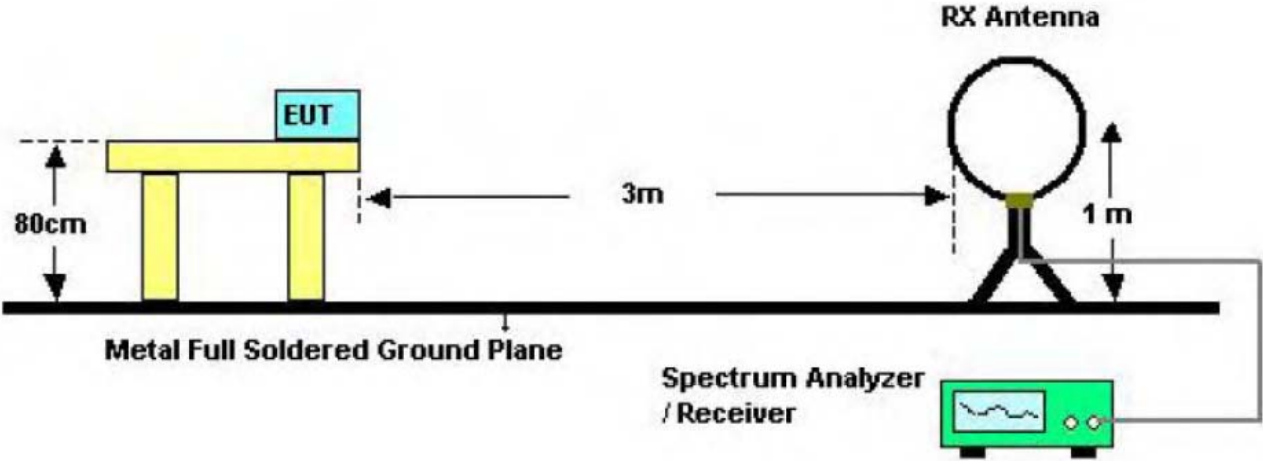

Below 30MHz Test Setup

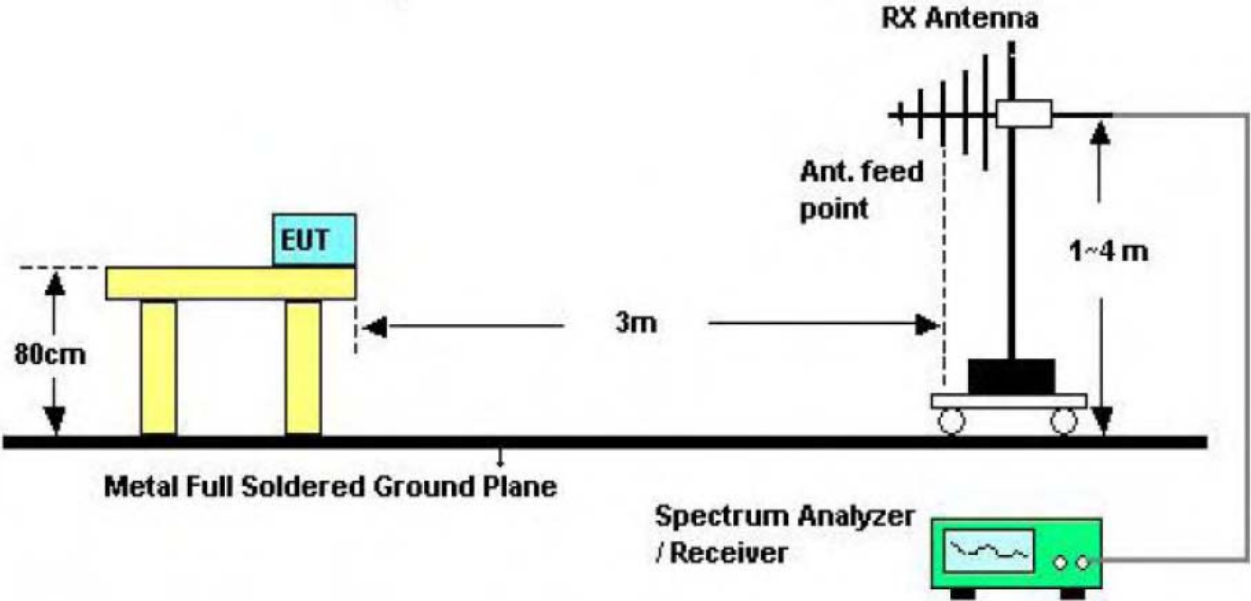

Below 1000MHz Test Setup

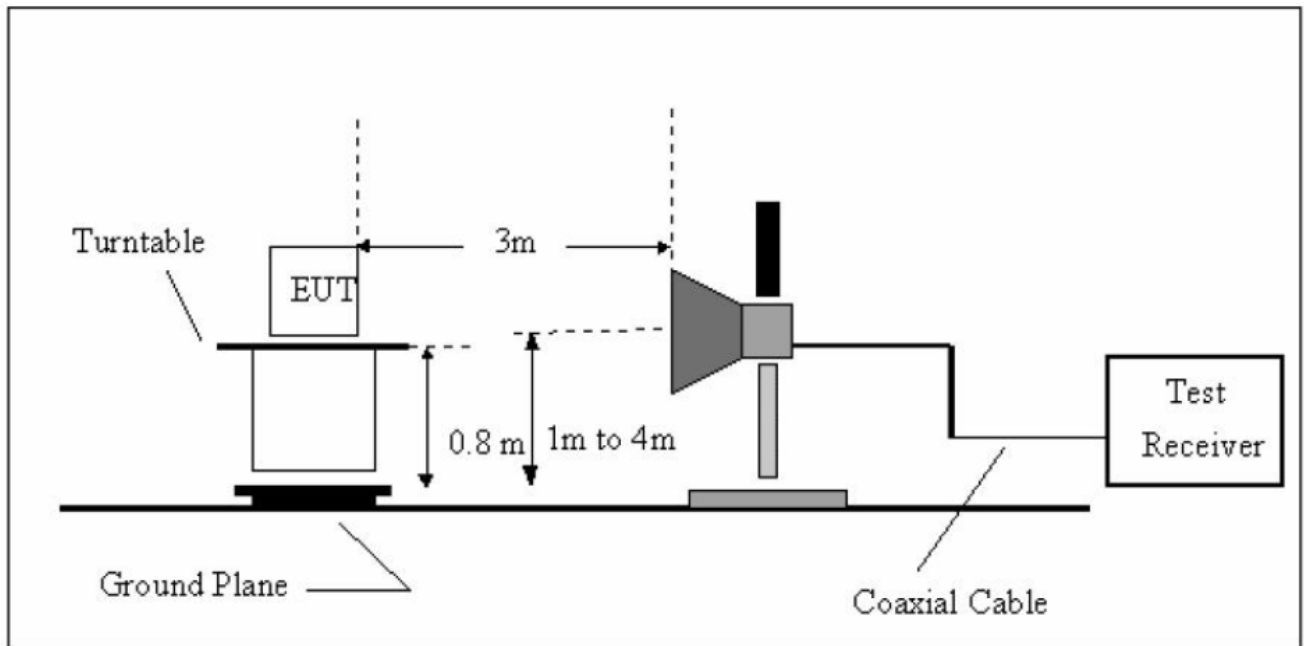

Above 1GHz Test Setup

4.3 Test Procedure

- (1) The measuring distance of 3m shall be used for measurements at frequency up to 1GHz and above 1 GHz. The EUT was placed on a rotating 0.8m high above the ground, the table was rotated 360 degrees to determine the position of the highest radiation.
- (2) The Test antenna shall vary between 1m and 4m, Both Horizontal and Vertical antenna are set to make measurement.
- (3) The initial step in collecting conducted emission data is a spectrum analyzer peak detector mode pre-scanning the measurement frequency range. Significant peaks are then marked and then Quasi Peak detector mode re-measured.
- (4) If the Peak Mode measured value compliance with and lower than Quasi Peak Mode Limit Bellow 1 GHz, the EUT shall be deemed to meet QP Limits and then no additional QP Mode measurement performed. But the Peak Value and average value both need to comply with applicable limit above 1 GHz.
- (5) For the actual test configuration, please see the test setup photo.

4.4 EUT Operating Condition

The Equipment Under Test was set to Continual Transmitting in maximum power.

4.5 Test Equipment

Equipment	Manufacturer	Model No.	Serial No.	Last Cal.	Cal. Due Date
Spectrum Analyzer	Agilent	E4407B	MY45106456	Mar. 20, 2014	Mar. 19, 2015

Spectrum Analyzer	Rohde & Schwarz	FSP30	DE25181	Aug. 10, 2013	Aug.09, 2014
EMI Test Receiver	Rohde & Schwarz	ESCI	101165	Aug. 10, 2013	Aug.09, 2014
Bilog Antenna	ETS-LINDGREN	3142E	00117537	Mar. 07, 2014	Mar.06, 2015
Bilog Antenna	ETS-LINDGREN	3142E	00117542	Mar. 07, 2014	Mar.06, 2015
Horn Antenna	ETS-LINDGREN	3117	00143207	Mar. 07, 2014	Mar.06, 2015
Horn Antenna	ETS-LINDGREN	3117	00143209	Mar. 07, 2014	Mar.06, 2015
Pre-amplifier	HP	11909A	185903	Mar. 07, 2014	Mar.06, 2015
Pre-amplifier	HP	8447B	3008A00849	Mar. 07, 2014	Mar.06, 2015
Cable	HUBER+SUHNE R	100	SUCOFLEX	Mar. 07, 2014	Mar.06, 2015
Signal Generator	Rohde & Schwarz	SML03	IKW682-054	Feb. 11, 2014	Feb.10, 2015
Positioning Controller	ETS-LINDGREN	2090	N/A	N/A	N/A

4.6 Test Data

Remark: During testing above 1GHz the measuring instrument use RBW=1 MHz and VBW=3 MHz with Peak Detector for Peak Values, and use RBW=1 MHz and VBW=10 Hz with Peak Detector for Average Values.

Test data please refer the following pages.

EUT:	MID	Model:	MID713-U
Temperature:	25 °C	Relative Humidity:	55%
Test Voltage:	AC 120V/60 Hz		
Ant. Pol.	Horizontal		
Test Mode:	TX B Mode 2412MHz		
Remark:	With Adapter 1#		

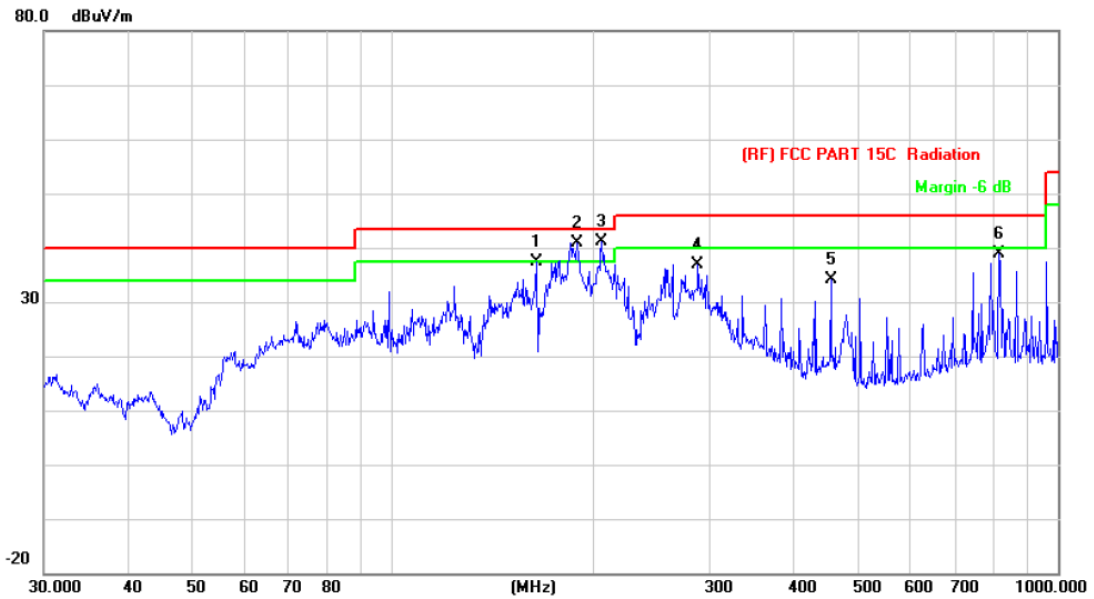

No.	Mk.	Freq. MHz	Reading Level dBuV	Correct Factor dB/m	Measure- ment dBuV/m	Limit dBuV/m	Over dB	Detector
1		164.9075	61.11	-23.79	37.32	43.50	-6.18	peak
2	!	189.7385	64.63	-23.85	40.78	43.50	-2.72	peak
3	*	206.3976	64.24	-23.06	41.18	43.50	-2.32	peak
4		287.9904	57.10	-20.27	36.83	46.00	-9.17	peak
5		455.9058	49.44	-15.21	34.23	46.00	-11.77	peak
6		815.9678	48.25	-9.32	38.93	46.00	-7.07	peak

Emission Level= Read Level+ Correct Factor

EUT:	MID	Model:	MID713-U
Temperature:	25 °C	Relative Humidity:	55%
Test Voltage:	AC 120V/60 Hz		
Ant. Pol.	Vertical		
Test Mode:	TX B Mode 2412MHz		
Remark:	With Adapter 1#		

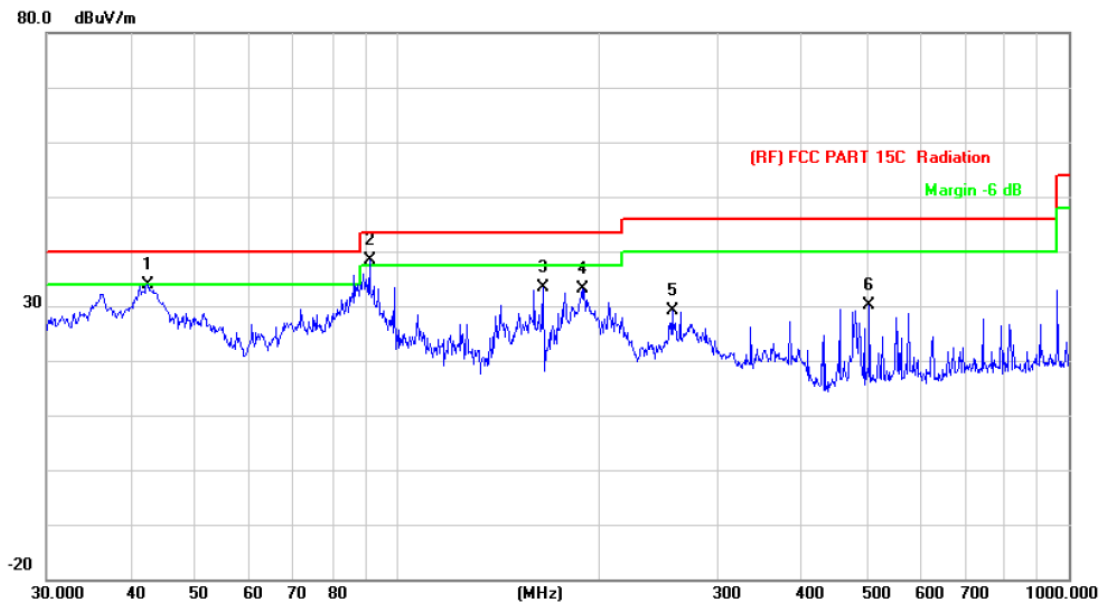

No.	Mk.	Freq.	Reading Level	Correct Factor	Measurement	Limit	Over	Detector
		MHz	dBuV	dB/m	dBuV/m	dBuV/m	dB	
1		42.4508	58.07	-24.14	33.93	40.00	-6.07	peak
2	*	90.8554	64.01	-25.56	38.45	43.50	-5.05	peak
3		164.9075	57.29	-23.79	33.50	43.50	-10.00	peak
4		188.4125	57.00	-23.80	33.20	43.50	-10.30	peak
5		256.5211	49.99	-20.93	29.06	46.00	-16.94	peak
6		504.7062	44.37	-14.36	30.01	46.00	-15.99	peak

Emission Level= Read Level+ Correct Factor

EUT:	MID	Model:	MID713-U
Temperature:	25 °C	Relative Humidity:	55%
Test Voltage:	AC 120V/60 Hz		
Ant. Pol.	Horizontal		
Test Mode:	TX B Mode 2412MHz		
Remark:	With Adapter 2#		

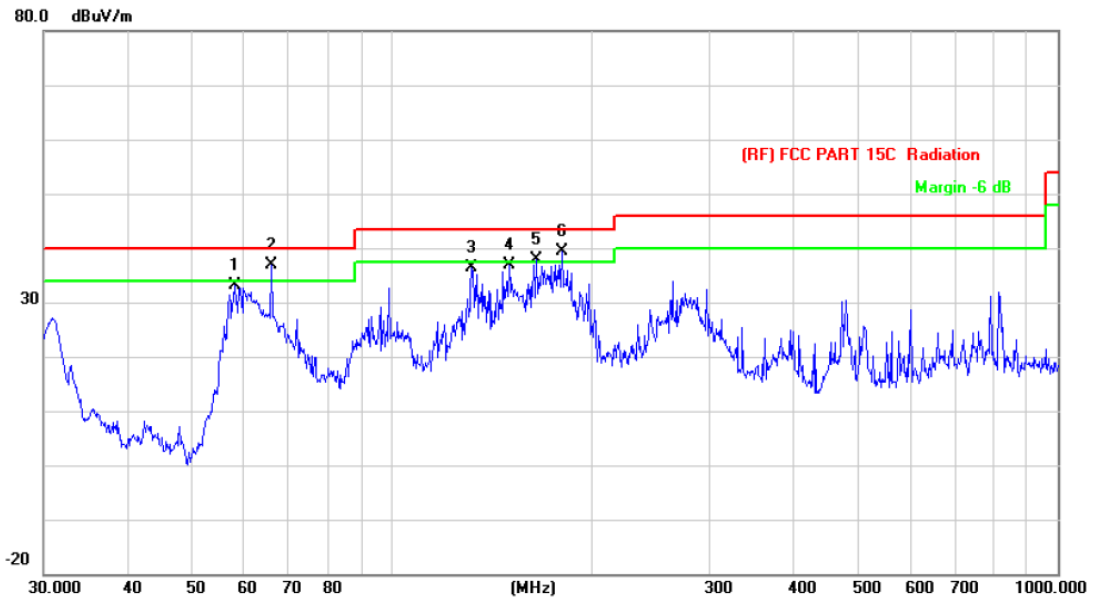

No.	Mk.	Freq.	Reading Level	Correct Factor	Measurement	Limit	Over	Detector
		MHz	dBuV	dB/m	dBuV/m	dBuV/m	dB	
1		57.9992	60.69	-27.45	33.24	40.00	-6.76	peak
2	*	66.0340	63.75	-26.93	36.82	40.00	-3.18	peak
3		131.7575	61.48	-25.09	36.39	43.50	-7.11	peak
4		150.0107	60.97	-24.12	36.85	43.50	-6.65	peak
5	!	164.9073	61.64	-23.79	37.85	43.50	-5.65	peak
6	!	180.0165	62.90	-23.52	39.38	43.50	-4.12	peak

Emission Level= Read Level+ Correct Factor

EUT:	MID	Model:	MID713-U
Temperature:	25 °C	Relative Humidity:	55%
Test Voltage:	AC 120V/60 Hz		
Ant. Pol.	Vertical		
Test Mode:	TX B Mode 2412MHz		
Remark:	With Adapter 2#		

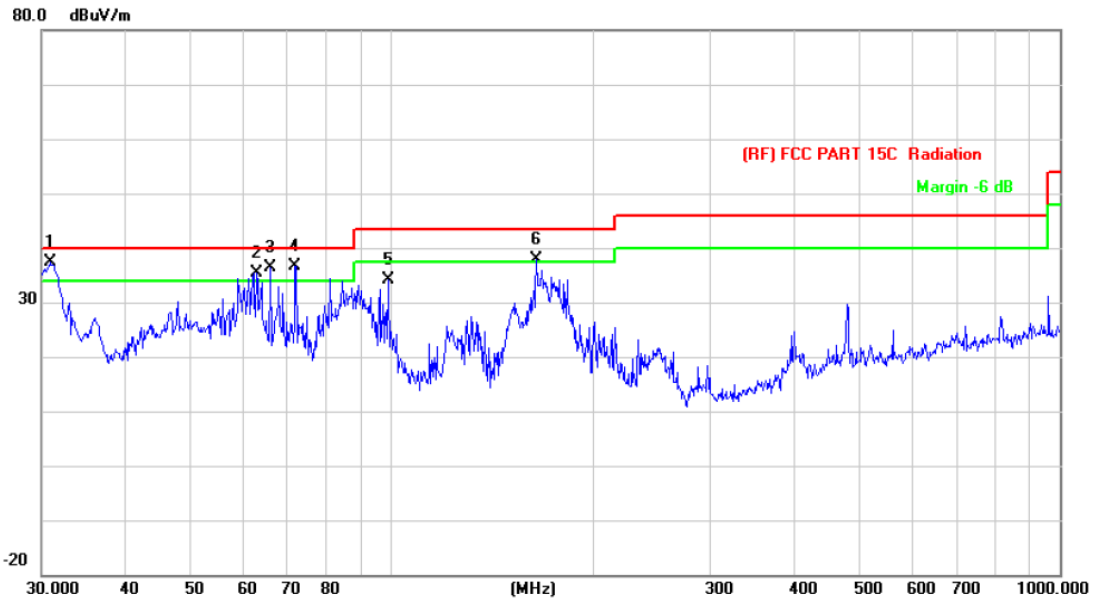

No.	Mk.	Freq. MHz	Reading Level dBuV	Correct Factor dB/m	Measure- ment dBuV/m	Limit dBuV/m	Over dB	Detector
1	*	30.9618	54.83	-17.50	37.33	40.00	-2.67	peak
2	!	62.8708	62.64	-27.21	35.43	40.00	-4.57	peak
3	!	66.0340	63.34	-26.93	36.41	40.00	-3.59	peak
4	!	71.8319	63.22	-26.51	36.71	40.00	-3.29	peak
5		98.8324	59.07	-24.87	34.20	43.50	-9.30	peak
6	!	164.9073	61.76	-23.79	37.97	43.50	-5.53	peak

Emission Level= Read Level+ Correct Factor

EUT:	MID	Model:	MID713-U
Temperature:	25 °C	Relative Humidity:	55%
Test Voltage:	AC 120V/60 Hz		
Ant. Pol.	Horizontal		
Test Mode:	TX B Mode 2412MHz		
Remark:	No report for the emission which more than 10 dB below the prescribed limit.		

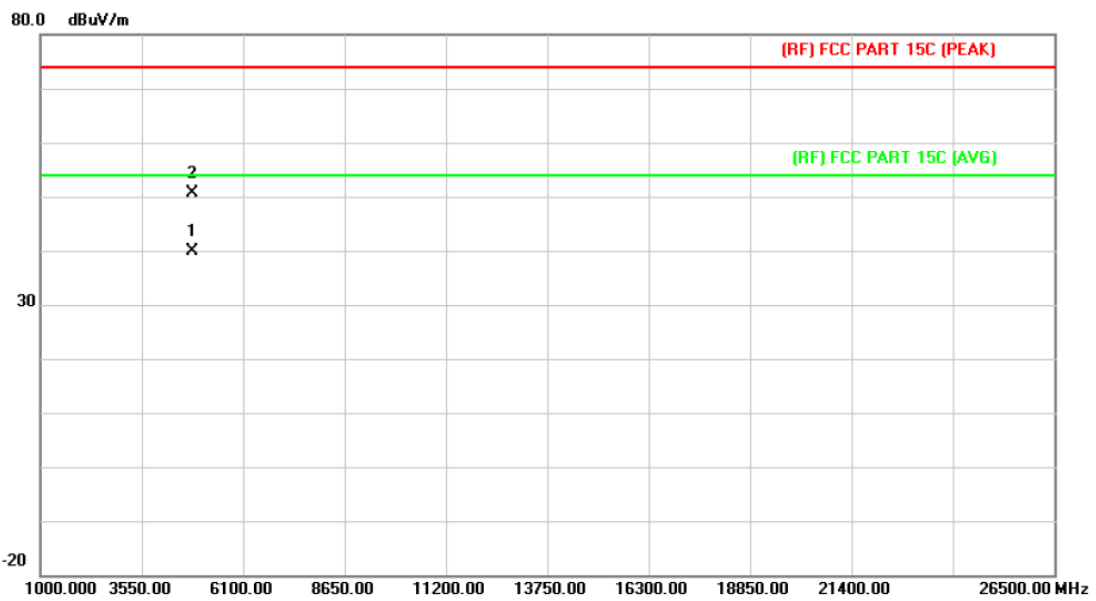

No.	Mk.	Freq. MHz	Reading Level dBuV	Correct Factor dB/m	Measure- ment dBuV/m	Limit dBuV/m	Over dB	Detector
1	*	4823.967	31.74	8.19	39.93	54.00	-14.07	AVG
2		4823.989	42.55	8.19	50.74	74.00	-23.26	peak

Emission Level= Read Level+ Correct Factor

EUT:	MID	Model:	MID713-U
Temperature:	25 °C	Relative Humidity:	55%
Test Voltage:	AC 120V/60 Hz		
Ant. Pol.	Vertical		
Test Mode:	TX B Mode 2412MHz		
Remark:	No report for the emission which more than 10 dB below the prescribed limit.		

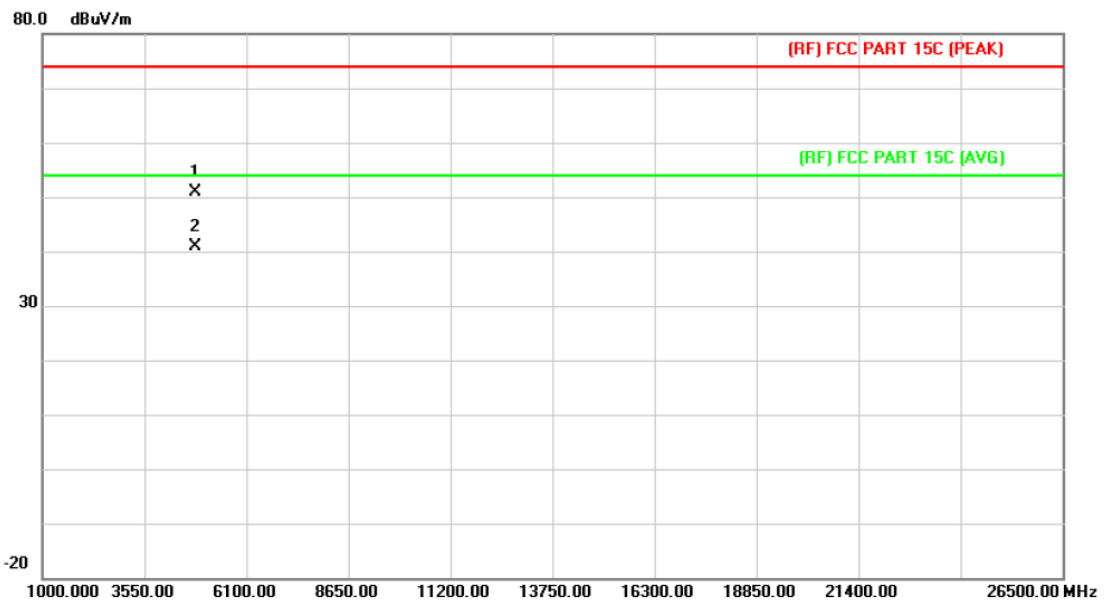

No.	Mk.	Freq.	Reading Level	Correct Factor	Measurement	Limit	Over	Detector
		MHz	dBuV	dB/m	dBuV/m	dBuV/m	dB	
1		4823.987	42.65	8.19	50.84	74.00	-23.16	peak
2	*	4823.987	32.60	8.19	40.79	54.00	-13.21	AVG

Emission Level= Read Level+ Correct Factor

EUT:	MID	Model:	MID713-U
Temperature:	25 °C	Relative Humidity:	55%
Test Voltage:	AC 120V/60 Hz		
Ant. Pol.	Horizontal		
Test Mode:	TX B Mode 2437MHz		
Remark:	No report for the emission which more than 10 dB below the prescribed limit.		

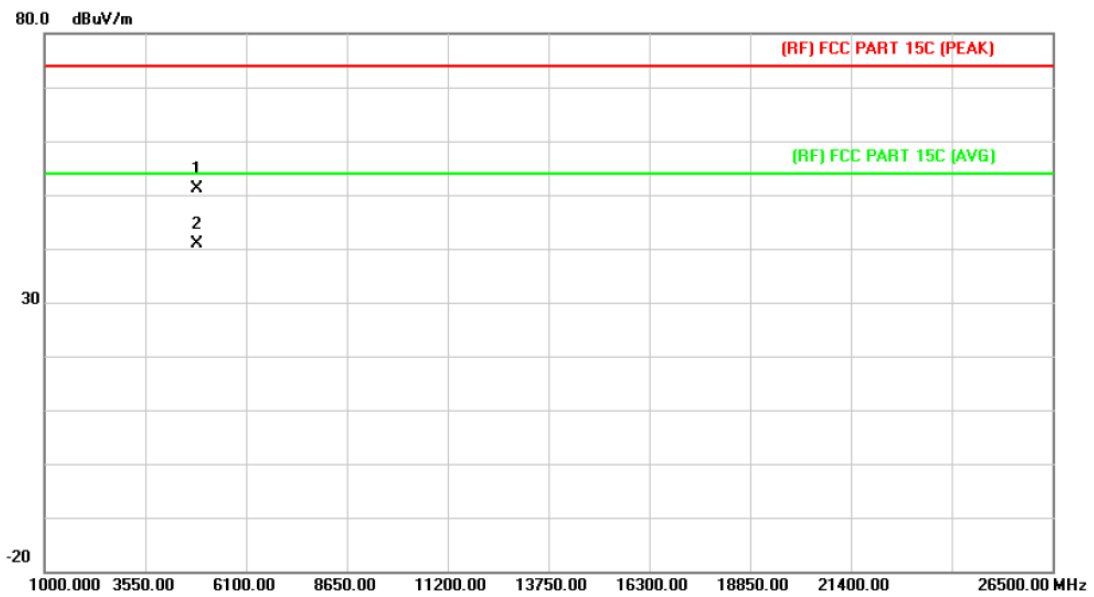

No.	Mk.	Freq.	Reading Level	Correct Factor	Measurement	Limit	Over	Detector
		MHz	dBuV	dB/m	dBuV/m	dBuV/m	dB	
1		4873.989	42.82	8.21	51.03	74.00	-22.97	peak
2	*	4873.989	32.68	8.21	40.89	54.00	-13.11	AVG

Emission Level= Read Level+ Correct Factor

EUT:	MID	Model:	MID713-U
Temperature:	25 °C	Relative Humidity:	55%
Test Voltage:	AC 120V/60 Hz		
Ant. Pol.	Vertical		
Test Mode:	TX B Mode 2437MHz		
Remark:	No report for the emission which more than 10 dB below the prescribed limit.		

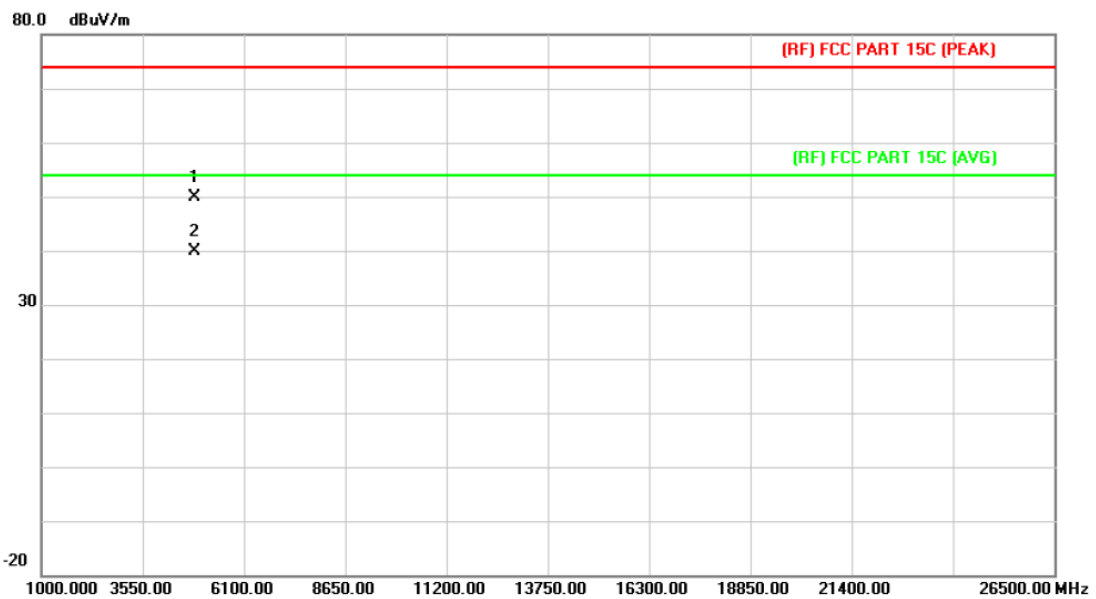

No.	Mk.	Freq. MHz	Reading Level dBuV	Correct Factor dB/m	Measure- ment dBuV/m	Limit dBuV/m	Over dB	Detector
1		4873.989	41.79	8.21	50.00	74.00	-24.00	peak
2	*	4873.989	31.63	8.21	39.84	54.00	-14.16	AVG

Emission Level= Read Level+ Correct Factor

EUT:	MID	Model:	MID713-U
Temperature:	25 °C	Relative Humidity:	55%
Test Voltage:	AC 120V/60 Hz		
Ant. Pol.	Horizontal		
Test Mode:	TX B Mode 2462MHz		
Remark:	No report for the emission which more than 10 dB below the prescribed limit.		

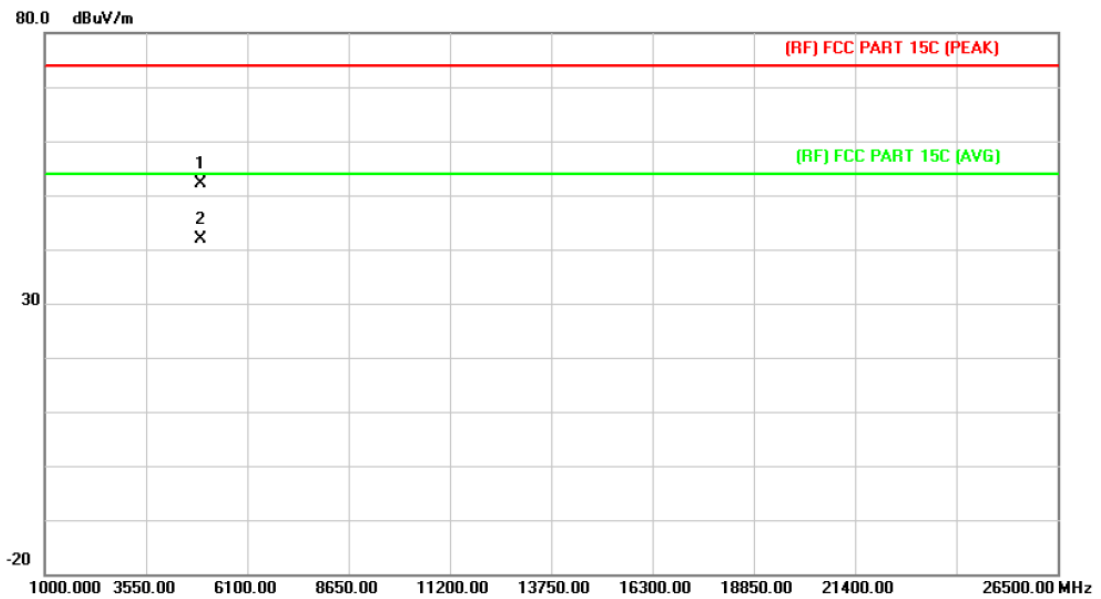

No.	Mk.	Freq.	Reading Level	Correct Factor	Measurement	Limit	Over	
		MHz	dBuV	dB/m	dBuV/m	dBuV/m	dB	Detector
1		4923.985	43.94	8.22	52.16	74.00	-21.84	peak
2	*	4923.985	33.59	8.22	41.81	54.00	-12.19	AVG

Emission Level= Read Level+ Correct Factor

EUT:	MID	Model:	MID713-U
Temperature:	25 °C	Relative Humidity:	55%
Test Voltage:	AC 120V/60 Hz		
Ant. Pol.	Vertical		
Test Mode:	TX B Mode 2462MHz		
Remark:	No report for the emission which more than 10 dB below the prescribed limit.		

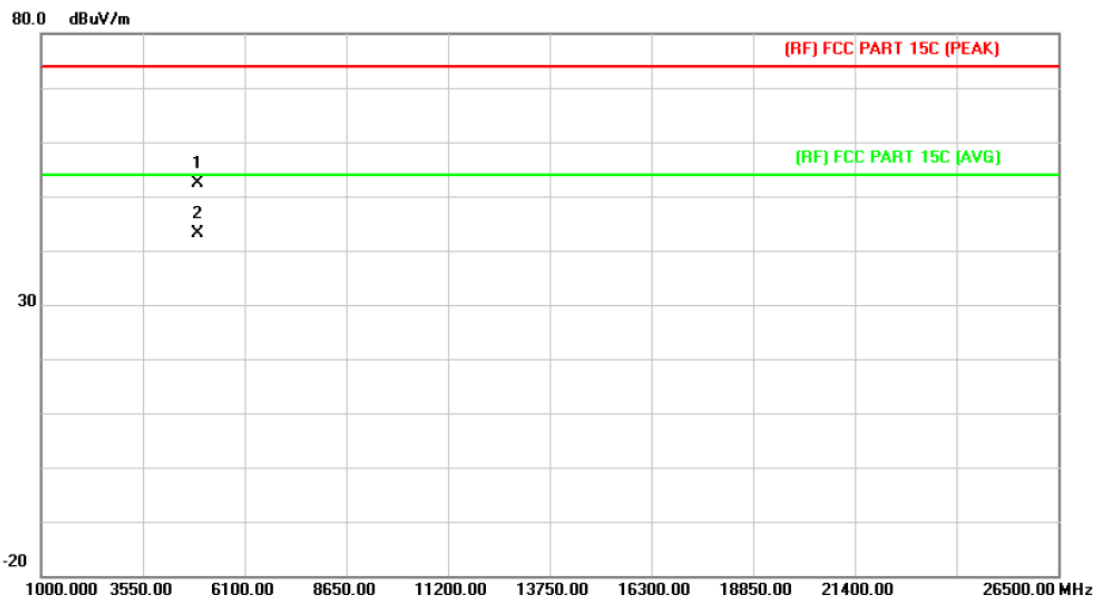

No.	Mk.	Freq.	Reading Level	Correct Factor	Measurement	Limit	Over	Detector
		MHz	dBuV	dB/m	dBuV/m	dBuV/m	dB	
1		4923.986	44.13	8.22	52.35	74.00	-21.65	peak
2	*	4923.986	34.98	8.22	43.20	54.00	-10.80	AVG

Emission Level= Read Level+ Correct Factor

EUT:	MID	Model:	MID713-U
Temperature:	25 °C	Relative Humidity:	55%
Test Voltage:	AC 120V/60 Hz		
Ant. Pol.	Horizontal		
Test Mode:	TX G Mode 2412MHz		
Remark:	No report for the emission which more than 10 dB below the prescribed limit.		

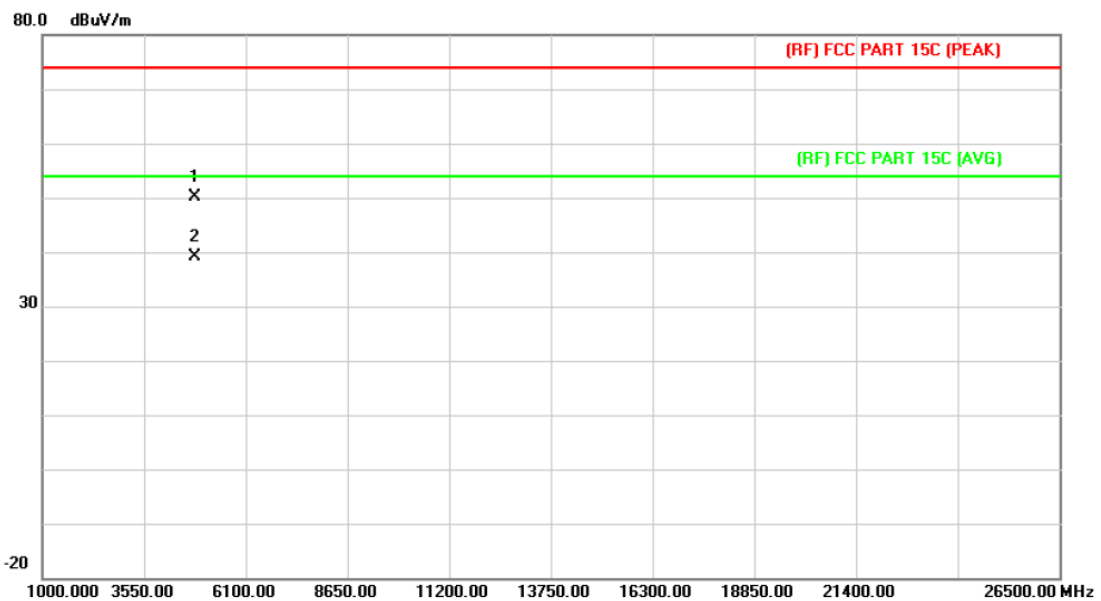

No.	Mk.	Freq. MHz	Reading Level dBuV	Correct Factor dB/m	Measure- ment dBuV/m	Limit dBuV/m	Over dB	Detector
1		4823.856	41.93	8.19	50.12	74.00	-23.88	peak
2	*	4823.856	31.06	8.19	39.25	54.00	-14.75	AVG

Emission Level= Read Level+ Correct Factor

EUT:	MID	Model:	MID713-U
Temperature:	25 °C	Relative Humidity:	55%
Test Voltage:	AC 120V/60 Hz		
Ant. Pol.	Vertical		
Test Mode:	TX G Mode 2412MHz		
Remark:	No report for the emission which more than 10 dB below the prescribed limit.		

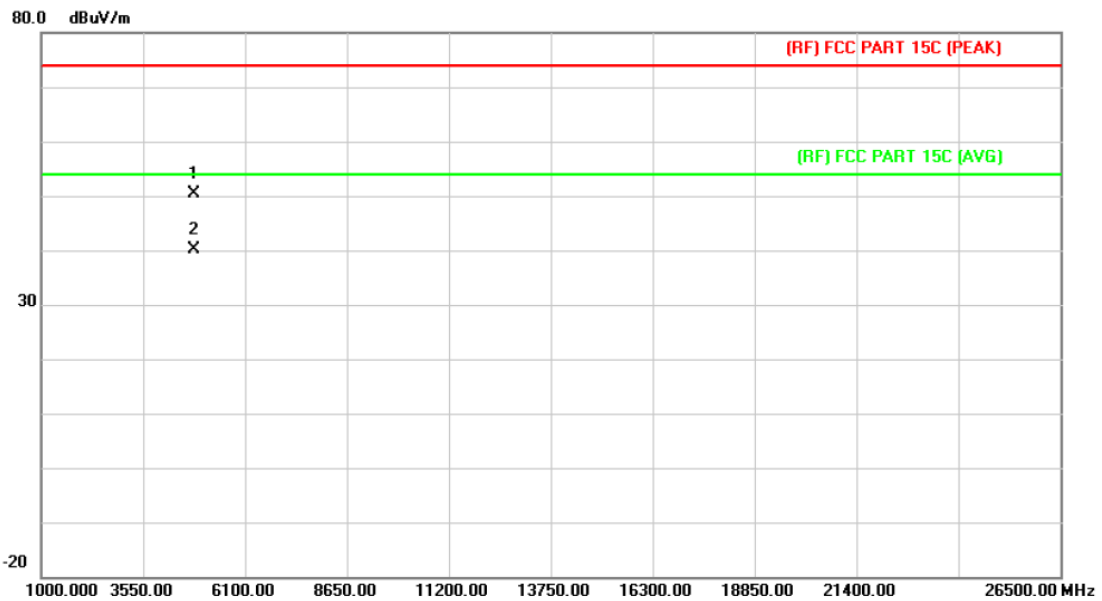

No.	Mk.	Freq.	Reading Level	Correct Factor	Measurement	Limit	Over	Detector
		MHz	dBuV	dB/m	dBuV/m	dBuV/m	dB	
1		4823.987	42.12	8.19	50.31	74.00	-23.69	peak
2	*	4823.987	31.96	8.19	40.15	54.00	-13.85	AVG

Emission Level= Read Level+ Correct Factor

EUT:	MID	Model:	MID713-U
Temperature:	25 °C	Relative Humidity:	55%
Test Voltage:	AC 120V/60 Hz		
Ant. Pol.	Horizontal		
Test Mode:	TX G Mode 2437MHz		
Remark:	No report for the emission which more than 10 dB below the prescribed limit.		

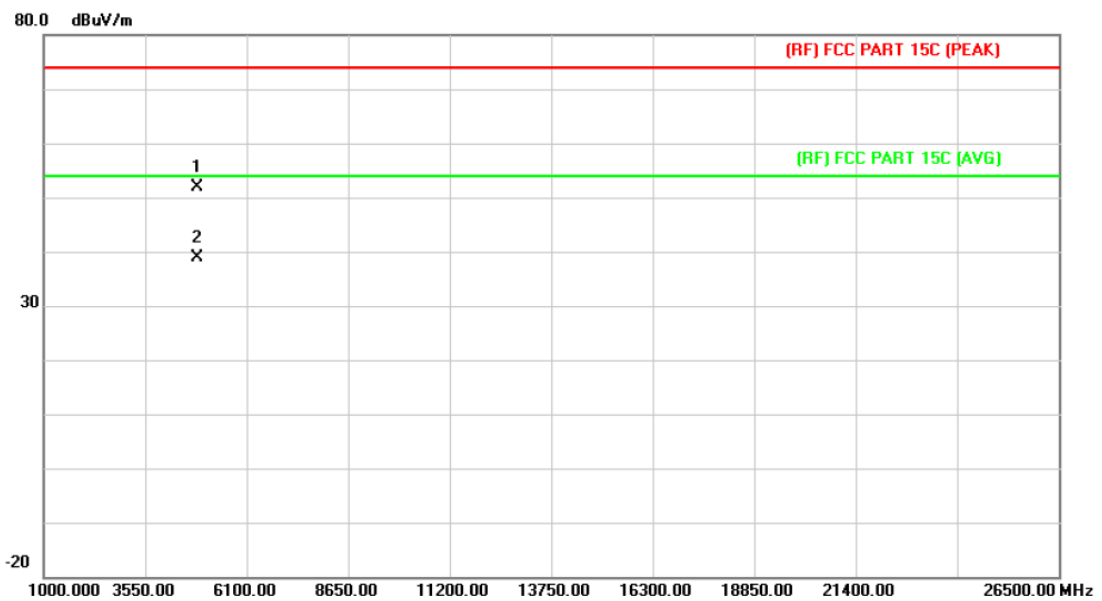

No.	Mk.	Freq.	Reading Level	Correct Factor	Measurement	Limit	Over	Detector
		MHz	dBuV	dB/m	dBuV/m	dBuV/m	dB	
1		4873.988	43.65	8.21	51.86	74.00	-22.14	peak
2	*	4873.988	30.76	8.21	38.97	54.00	-15.03	AVG

Emission Level= Read Level+ Correct Factor

EUT:	MID	Model:	MID713-U
Temperature:	25 °C	Relative Humidity:	55%
Test Voltage:	AC 120V/60 Hz		
Ant. Pol.	Vertical		
Test Mode:	TX G Mode 2437MHz		
Remark:	No report for the emission which more than 10 dB below the prescribed limit.		

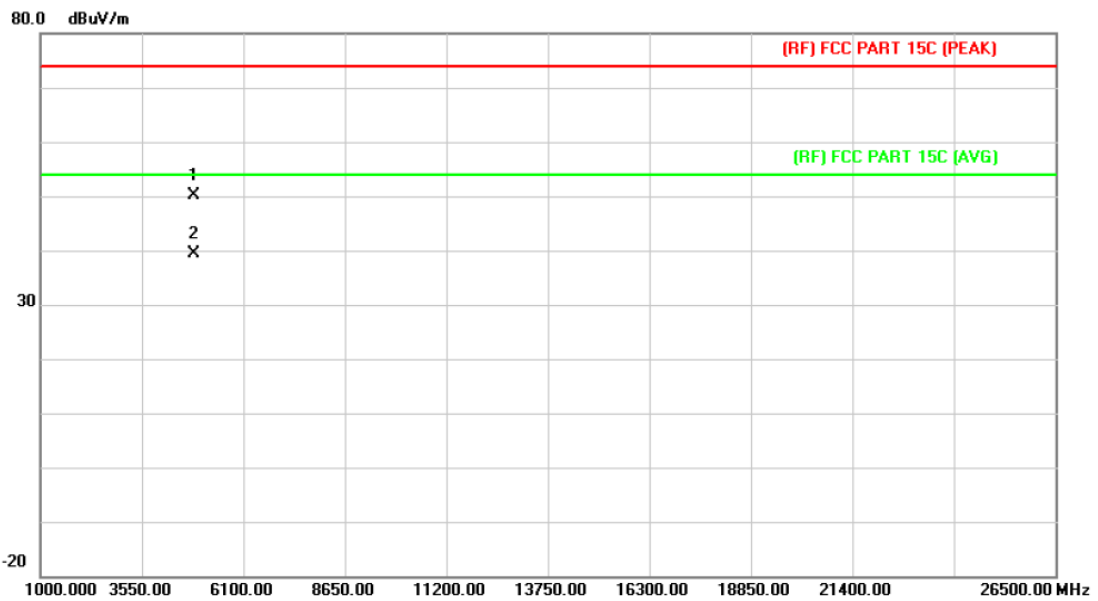

No.	Mk.	Freq.	Reading Level	Correct Factor	Measurement	Limit	Over	Detector
		MHz	dBuV	dB/m	dBuV/m	dBuV/m	dB	
1		4873.988	41.90	8.21	50.11	74.00	-23.89	peak
2	*	4873.988	31.08	8.21	39.29	54.00	-14.71	AVG

Emission Level= Read Level+ Correct Factor

EUT:	MID	Model:	MID713-U
Temperature:	25 °C	Relative Humidity:	55%
Test Voltage:	AC 120V/60 Hz		
Ant. Pol.	Horizontal		
Test Mode:	TX G Mode 2462MHz		
Remark:	No report for the emission which more than 10 dB below the prescribed limit.		

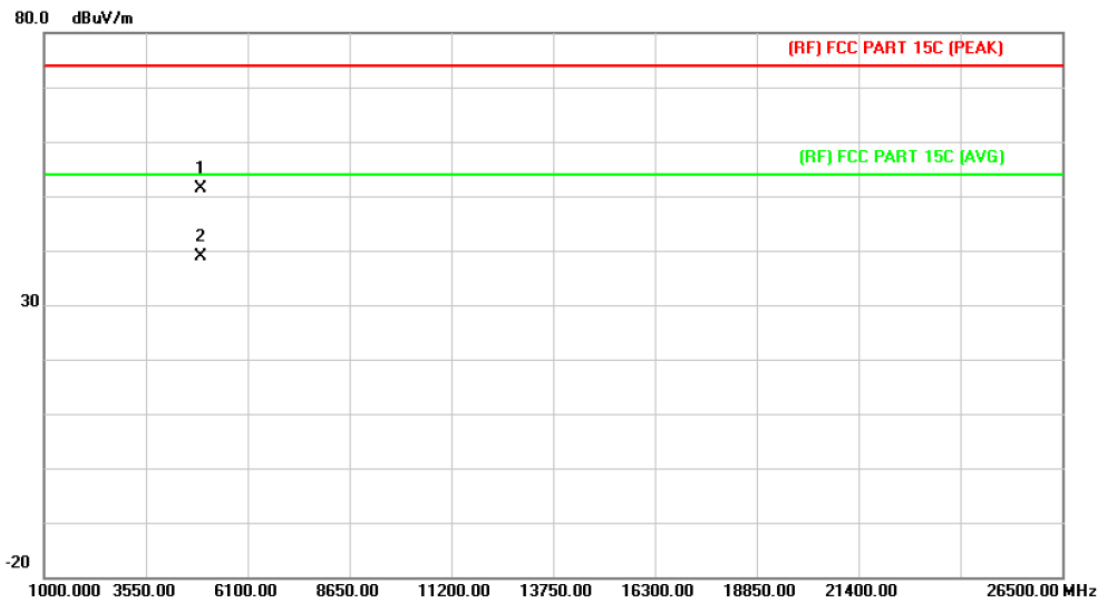

No.	Mk.	Freq.	Reading Level	Correct Factor	Measurement	Limit	Over	Detector
		MHz	dBuV	dB/m	dBuV/m	dBuV/m	dB	
1		4923.989	43.11	8.22	51.33	74.00	-22.67	peak
2	*	4923.989	30.56	8.22	38.78	54.00	-15.22	AVG

Emission Level= Read Level+ Correct Factor

EUT:	MID	Model:	MID713-U
Temperature:	25 °C	Relative Humidity:	55%
Test Voltage:	AC 120V/60 Hz		
Ant. Pol.	Vertical		
Test Mode:	TX G Mode 2462MHz		
Remark:	No report for the emission which more than 10 dB below the prescribed limit.		

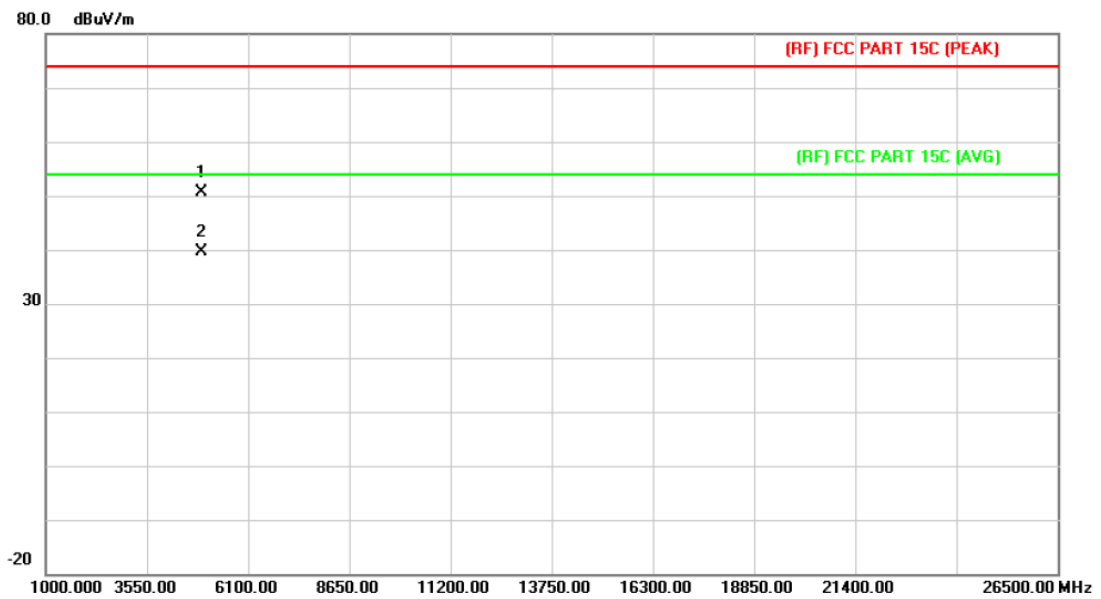

No.	Mk.	Freq.	Reading Level	Correct Factor	Measurement	Limit	Over	Detector
		MHz	dBuV	dB/m	dBuV/m	dBuV/m	dB	
1		4923.987	42.45	8.22	50.67	74.00	-23.33	peak
2	*	4923.987	31.34	8.22	39.56	54.00	-14.44	AVG

Emission Level= Read Level+ Correct Factor

EUT:	MID	Model:	MID713-U
Temperature:	25 °C	Relative Humidity:	55%
Test Voltage:	AC 120V/60 Hz		
Ant. Pol.	Horizontal		
Test Mode:	TX N(HT20) Mode 2412MHz		
Remark:	No report for the emission which more than 10 dB below the prescribed limit.		

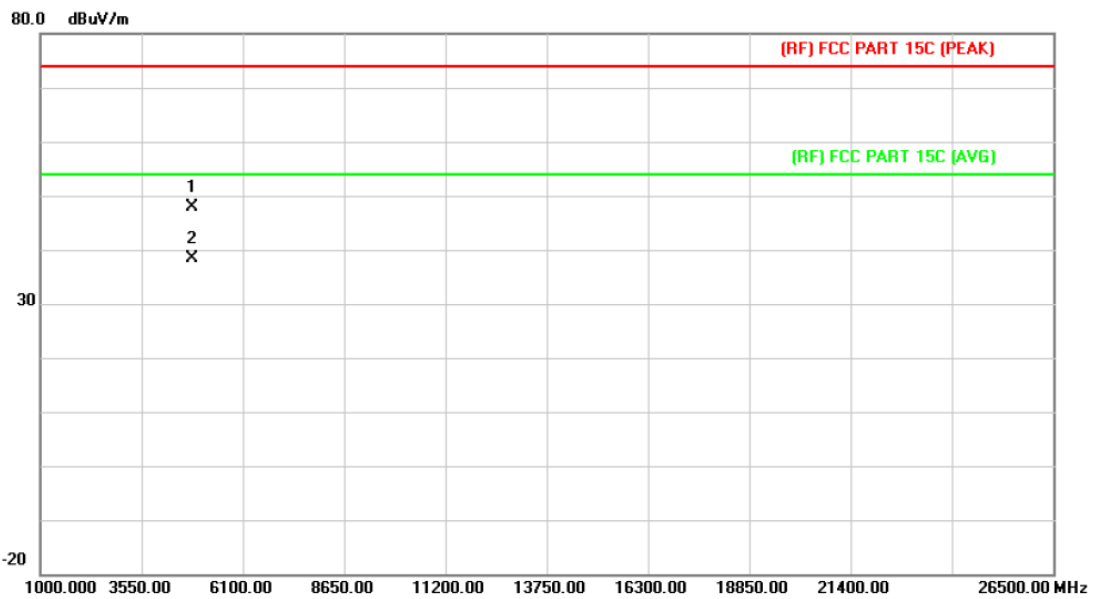

No.	Mk.	Freq.	Reading Level	Correct Factor	Measurement	Limit	Over	Detector
		MHz	dBuV	dB/m	dBuV/m	dBuV/m	dB	
1		4823.983	39.74	8.19	47.93	74.00	-26.07	peak
2	*	4823.983	30.11	8.19	38.30	54.00	-15.70	AVG

Emission Level= Read Level+ Correct Factor

EUT:	MID	Model:	MID713-U
Temperature:	25 °C	Relative Humidity:	55%
Test Voltage:	AC 120V/60 Hz		
Ant. Pol.	Vertical		
Test Mode:	TX N(HT20) Mode 2412MHz		
Remark:	No report for the emission which more than 10 dB below the prescribed limit.		

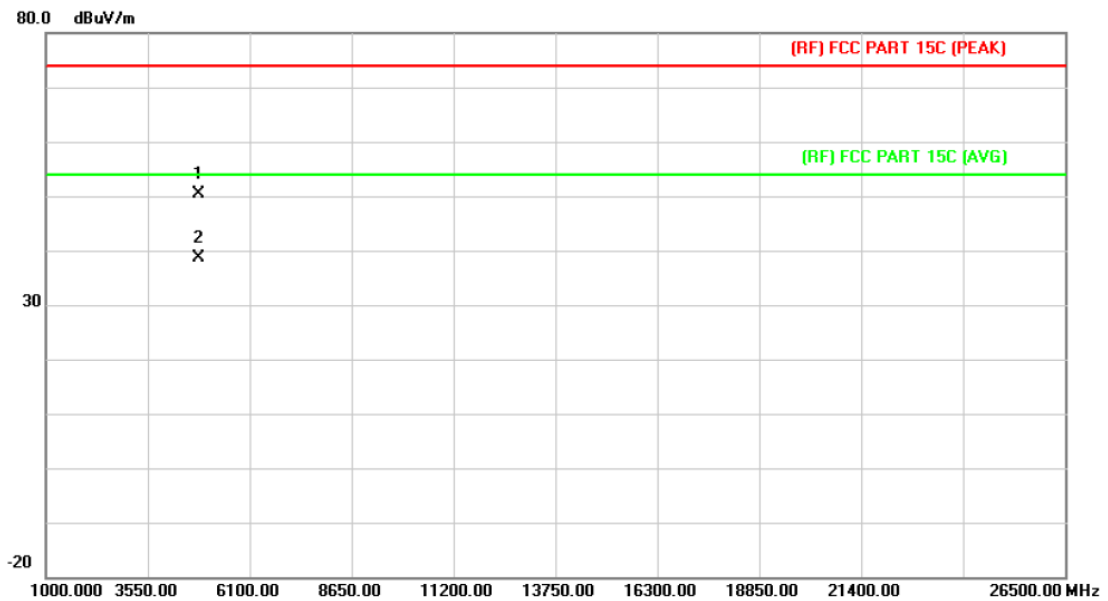

No.	Mk.	Freq.	Reading Level	Correct Factor	Measurement	Limit	Over	Detector
		MHz	dBuV	dB/m	dBuV/m	dBuV/m	dB	
1		4823.983	42.11	8.19	50.30	74.00	-23.70	peak
2	*	4823.983	30.53	8.19	38.72	54.00	-15.28	AVG

Emission Level= Read Level+ Correct Factor

EUT:	MID	Model:	MID713-U
Temperature:	25 °C	Relative Humidity:	55%
Test Voltage:	AC 120V/60 Hz		
Ant. Pol.	Horizontal		
Test Mode:	TX N(HT20) Mode 2437MHz		
Remark:	No report for the emission which more than 10 dB below the prescribed limit.		

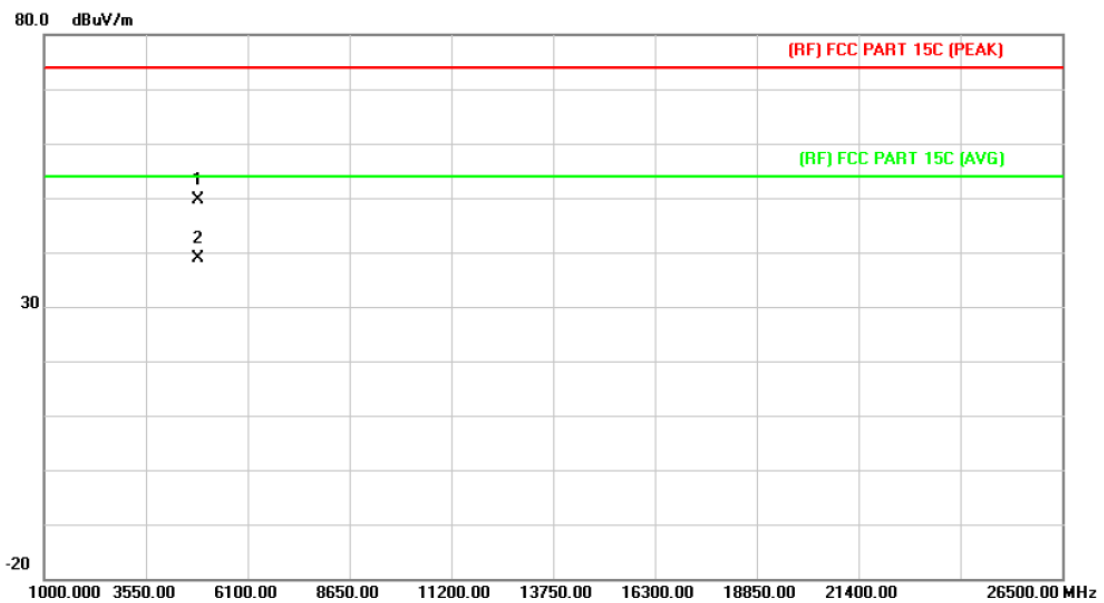

No.	Mk.	Freq.	Reading Level	Correct Factor	Measurement	Limit	Over	Detector
		MHz	dBuV	dB/m	dBuV/m	dBuV/m	dB	
1		4873.988	41.43	8.21	49.64	74.00	-24.36	peak
2	*	4873.988	30.79	8.21	39.00	54.00	-15.00	AVG

Emission Level= Read Level+ Correct Factor

EUT:	MID	Model:	MID713-U
Temperature:	25 °C	Relative Humidity:	55%
Test Voltage:	AC 120V/60 Hz		
Ant. Pol.	Vertical		
Test Mode:	TX N(HT20) Mode 2437MHz		
Remark:	No report for the emission which more than 10 dB below the prescribed limit.		

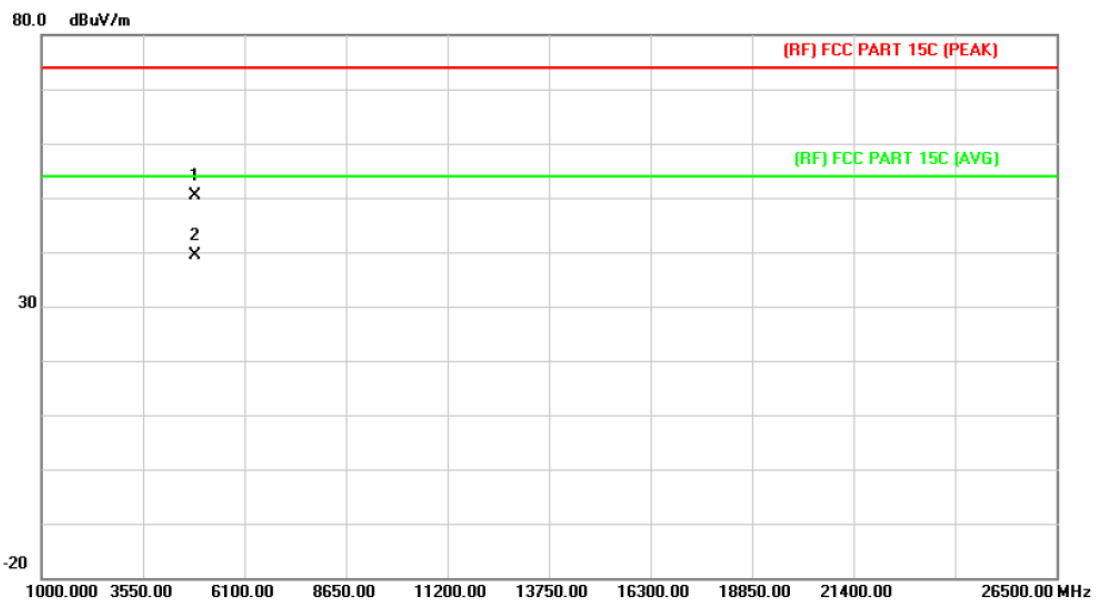

No.	Mk.	Freq.	Reading Level	Correct Factor	Measurement	Limit	Over	Detector
		MHz	dBuV	dB/m	dBuV/m	dBuV/m	dB	
1		4873.986	42.20	8.21	50.41	74.00	-23.59	peak
2	*	4873.986	31.10	8.21	39.31	54.00	-14.69	AVG

Emission Level= Read Level+ Correct Factor

EUT:	MID	Model:	MID713-U
Temperature:	25 °C	Relative Humidity:	55%
Test Voltage:	AC 120V/60 Hz		
Ant. Pol.	Horizontal		
Test Mode:	TX N(HT20) Mode 2462MHz		
Remark:	No report for the emission which more than 10 dB below the prescribed limit.		

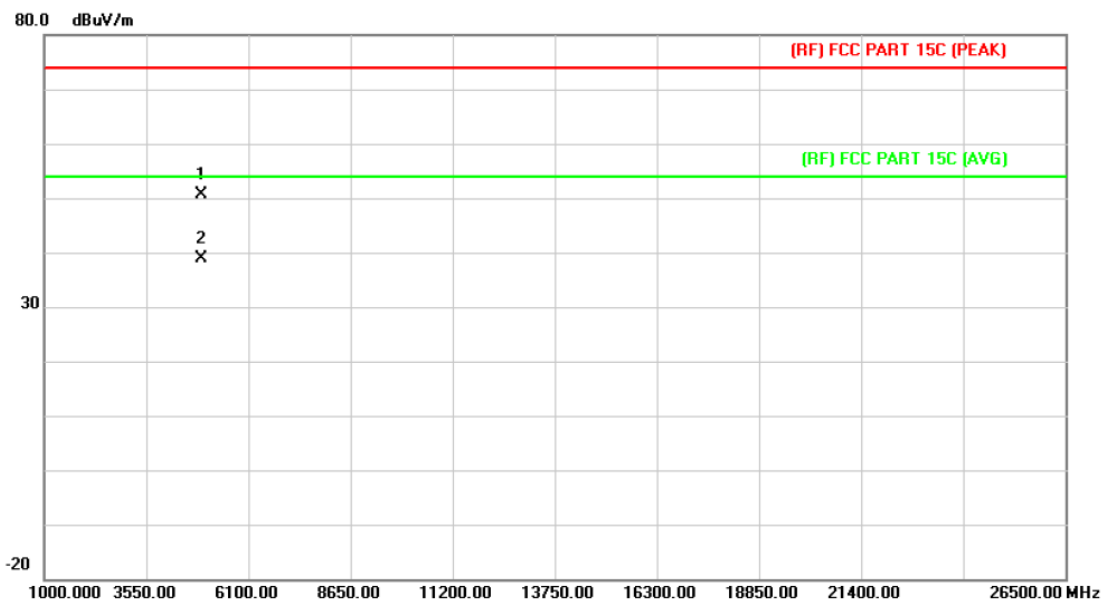

No.	Mk.	Freq.	Reading Level	Correct Factor	Measurement	Limit	Over	Detector
		MHz	dBuV	dB/m	dBuV/m	dBuV/m	dB	
1		4923.987	42.34	8.22	50.56	74.00	-23.44	peak
2	*	4923.987	30.61	8.22	38.83	54.00	-15.17	AVG

Emission Level= Read Level+ Correct Factor

EUT:	MID	Model:	MID713-U
Temperature:	25 °C	Relative Humidity:	55%
Test Voltage:	AC 120V/60 Hz		
Ant. Pol.	Vertical		
Test Mode:	TX N(HT20) Mode 2462MHz		
Remark:	No report for the emission which more than 10 dB below the prescribed limit.		

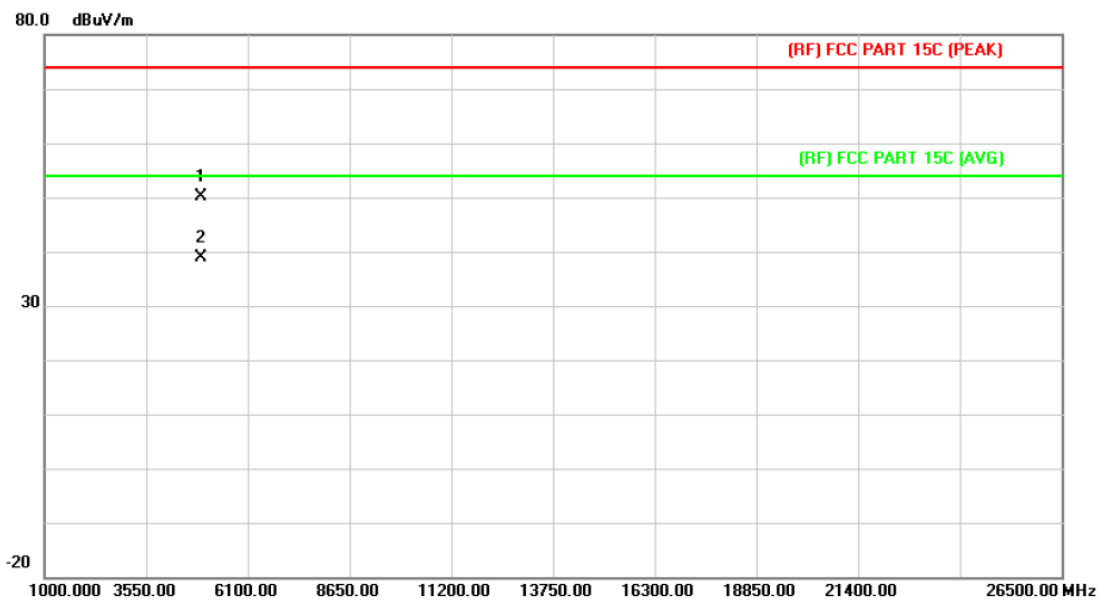

No.	Mk.	Freq. MHz	Reading Level dBuV	Correct Factor dB/m	Measure- ment dBuV/m	Limit dBuV/m	Over dB	Detector
1		4923.986	41.90	8.22	50.12	74.00	-23.88	peak
2	*	4923.986	30.76	8.22	38.98	54.00	-15.02	AVG

Emission Level= Read Level+ Correct Factor

EUT:	MID	Model:	MID713-U
Temperature:	25 °C	Relative Humidity:	55%
Test Voltage:	AC 120V/60 Hz		
Ant. Pol.	Horizontal		
Test Mode:	TX N(HT40) Mode 2422MHz		
Remark:	No report for the emission which more than 10 dB below the prescribed limit.		

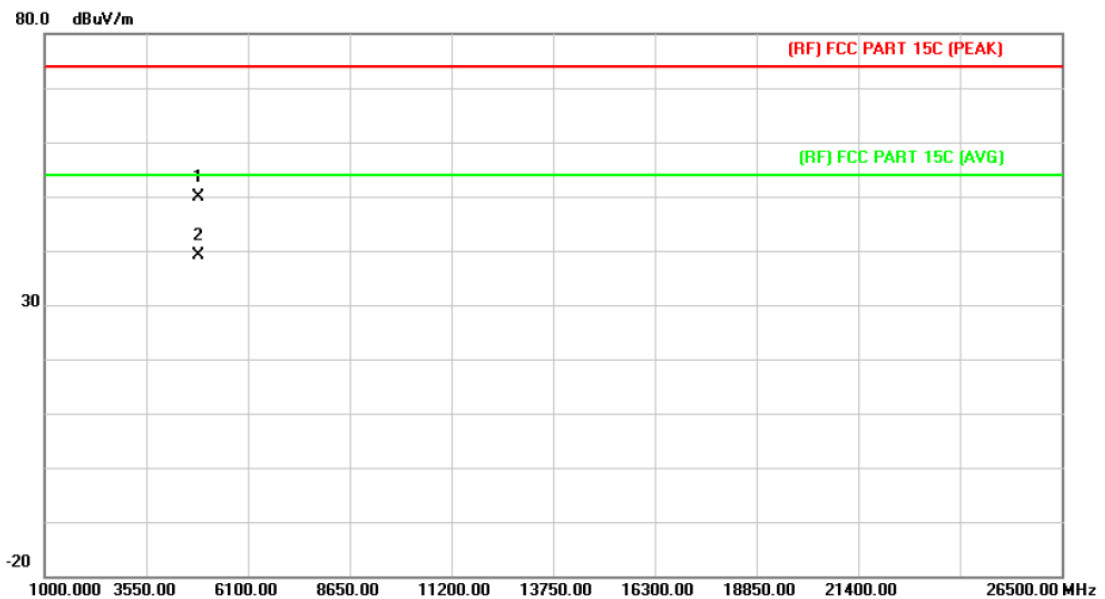

No.	Mk.	Freq.	Reading Level	Correct Factor	Measurement	Limit	Over	Detector
		MHz	dBuV	dB/m	dBuV/m	dBuV/m	dB	
1		4843.988	41.58	8.20	49.78	74.00	-24.22	peak
2	*	4843.988	30.98	8.20	39.18	54.00	-14.82	AVG

Emission Level= Read Level+ Correct Factor

EUT:	MID	Model:	MID713-U
Temperature:	25 °C	Relative Humidity:	55%
Test Voltage:	AC 120V/60 Hz		
Ant. Pol.	Vertical		
Test Mode:	TX N(HT40) Mode 2422MHz		
Remark:	No report for the emission which more than 10 dB below the prescribed limit.		

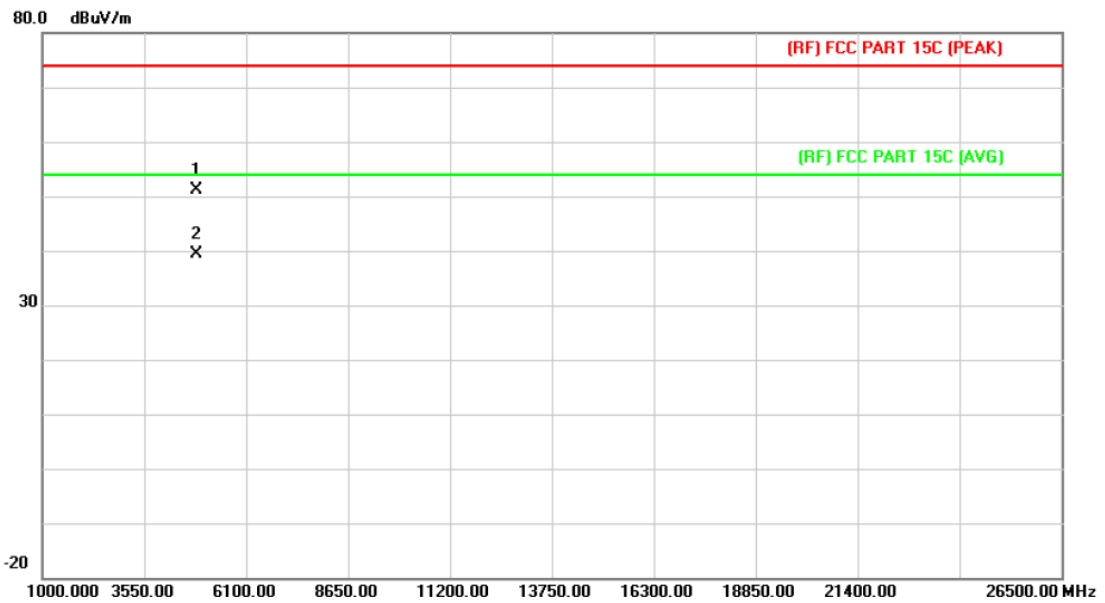

No.	Mk.	Freq. MHz	Reading Level dBuV	Correct Factor dB/m	Measure- ment dBuV/m	Limit dBuV/m	Over dB	Detector
1		4843.989	42.99	8.20	51.19	74.00	-22.81	peak
2	*	4843.989	31.17	8.20	39.37	54.00	-14.63	AVG

Emission Level= Read Level+ Correct Factor

EUT:	MID	Model:	MID713-U
Temperature:	25 °C	Relative Humidity:	55%
Test Voltage:	AC 120V/60 Hz		
Ant. Pol.	Horizontal		
Test Mode:	TX N(HT40) Mode 2437MHz		
Remark:	No report for the emission which more than 10 dB below the prescribed limit.		

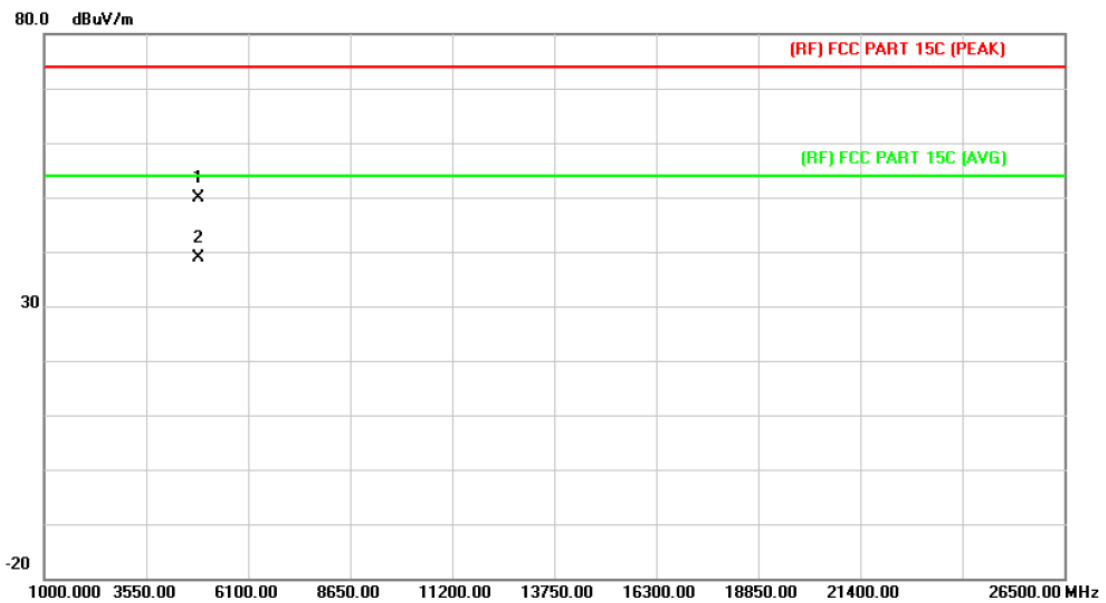

No.	Mk.	Freq.	Reading Level	Correct Factor	Measurement	Limit	Over	Detector
		MHz	dBuV	dB/m	dBuV/m	dBuV/m	dB	
1		4873.988	41.66	8.21	49.87	74.00	-24.13	peak
2	*	4873.988	30.77	8.21	38.98	54.00	-15.02	AVG

Emission Level= Read Level+ Correct Factor

EUT:	MID	Model:	MID713-U
Temperature:	25 °C	Relative Humidity:	55%
Test Voltage:	AC 120V/60 Hz		
Ant. Pol.	Vertical		
Test Mode:	TX N(HT40) Mode 2437MHz		
Remark:	No report for the emission which more than 10 dB below the prescribed limit.		

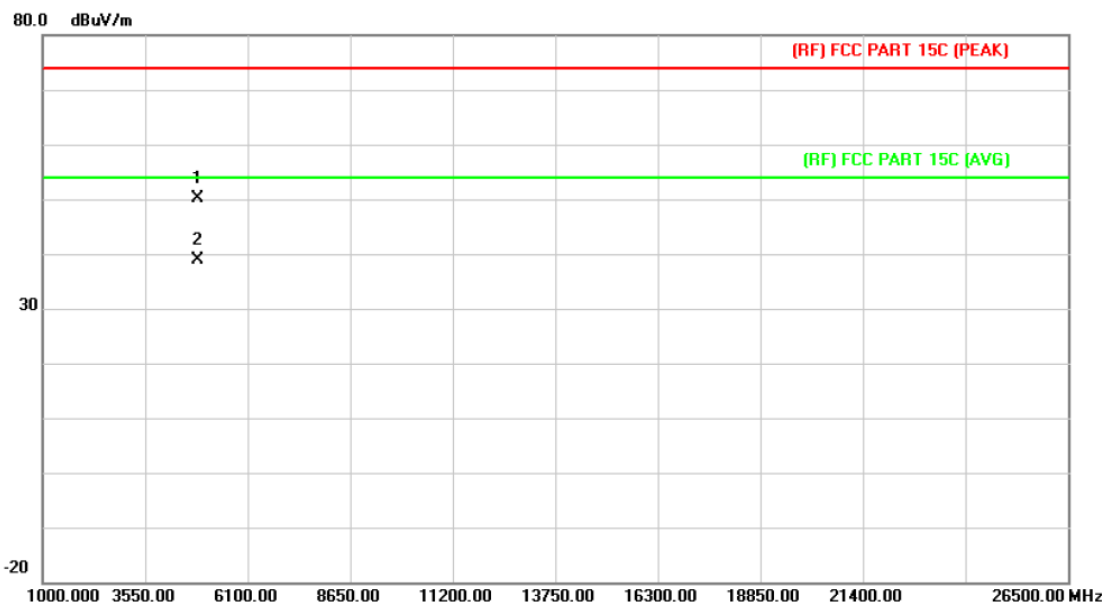

No.	Mk.	Freq. MHz	Reading Level dBuV	Correct Factor dB/m	Measure- ment dBuV/m	Limit dBuV/m	Over dB	Detector
1		4873.987	42.02	8.21	50.23	74.00	-23.77	peak
2	*	4873.987	30.74	8.21	38.95	54.00	-15.05	AVG

Emission Level= Read Level+ Correct Factor

EUT:	MID	Model:	MID713-U
Temperature:	25 °C	Relative Humidity:	55%
Test Voltage:	AC 120V/60 Hz		
Ant. Pol.	Horizontal		
Test Mode:	TX N(HT40) Mode 2452MHz		
Remark:	No report for the emission which more than 10 dB below the prescribed limit.		

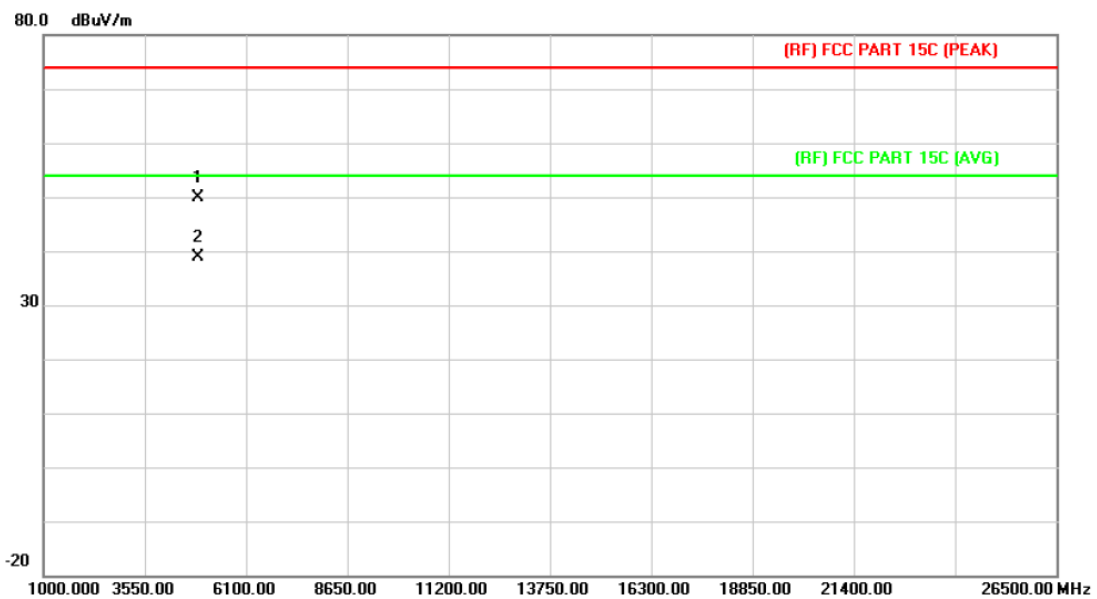

No.	Mk.	Freq. MHz	Reading Level dBuV	Correct Factor dB/m	Measure- ment dBuV/m	Limit dBuV/m	Over dB	Detector
1		4903.986	41.75	8.21	49.96	74.00	-24.04	peak
2	*	4903.986	30.68	8.21	38.89	54.00	-15.11	AVG

Emission Level= Read Level+ Correct Factor

EUT:	MID	Model:	MID713-U
Temperature:	25 °C	Relative Humidity:	55%
Test Voltage:	AC 120V/60 Hz		
Ant. Pol.	Vertical		
Test Mode:	TX N(HT40) Mode 2452MHz		
Remark:	No report for the emission which more than 10 dB below the prescribed limit.		

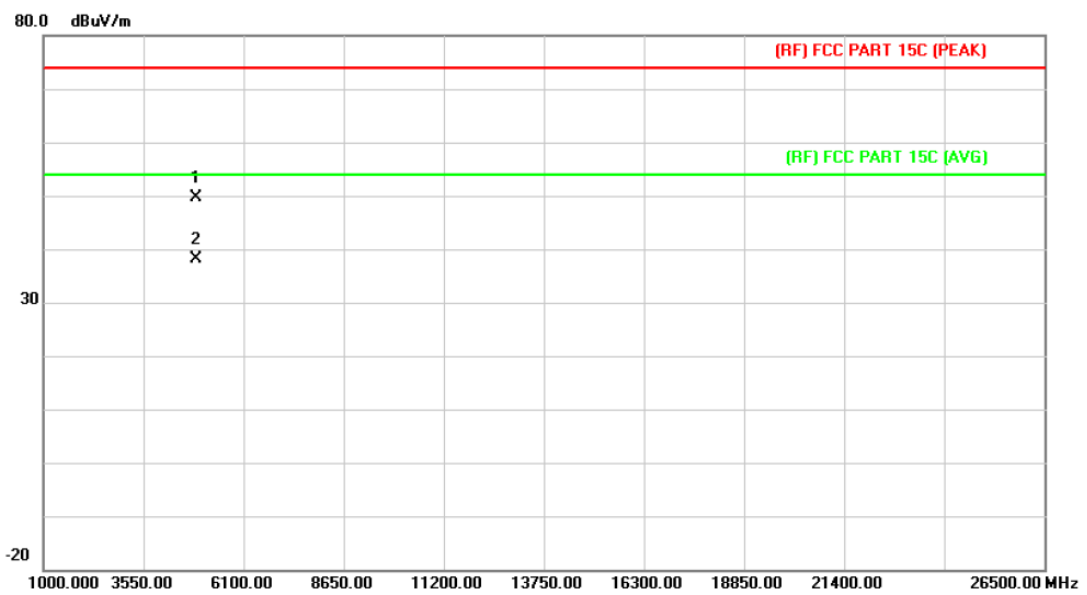

No.	Mk.	Freq.	Reading Level	Correct Factor	Measurement	Limit	Over	Detector
		MHz	dBuV	dB/m	dBuV/m	dBuV/m	dB	
1		4903.988	41.35	8.21	49.56	74.00	-24.44	peak
2	*	4903.988	29.91	8.21	38.12	54.00	-15.88	AVG

Emission Level= Read Level+ Correct Factor

5. Restricted Bands Requirement

5.1 Test Standard and Limit

5.1.1 Test Standard

FCC Part 15.209 FCC Part 15.205

5.1.2 Test Limit

Restricted Frequency Band (MHz)	Class B (dBuV/m)(at 3 M)	
	Peak	Average
2310 ~2390	74	54
2483.5 ~2500	74	54

5.2 Test Setup

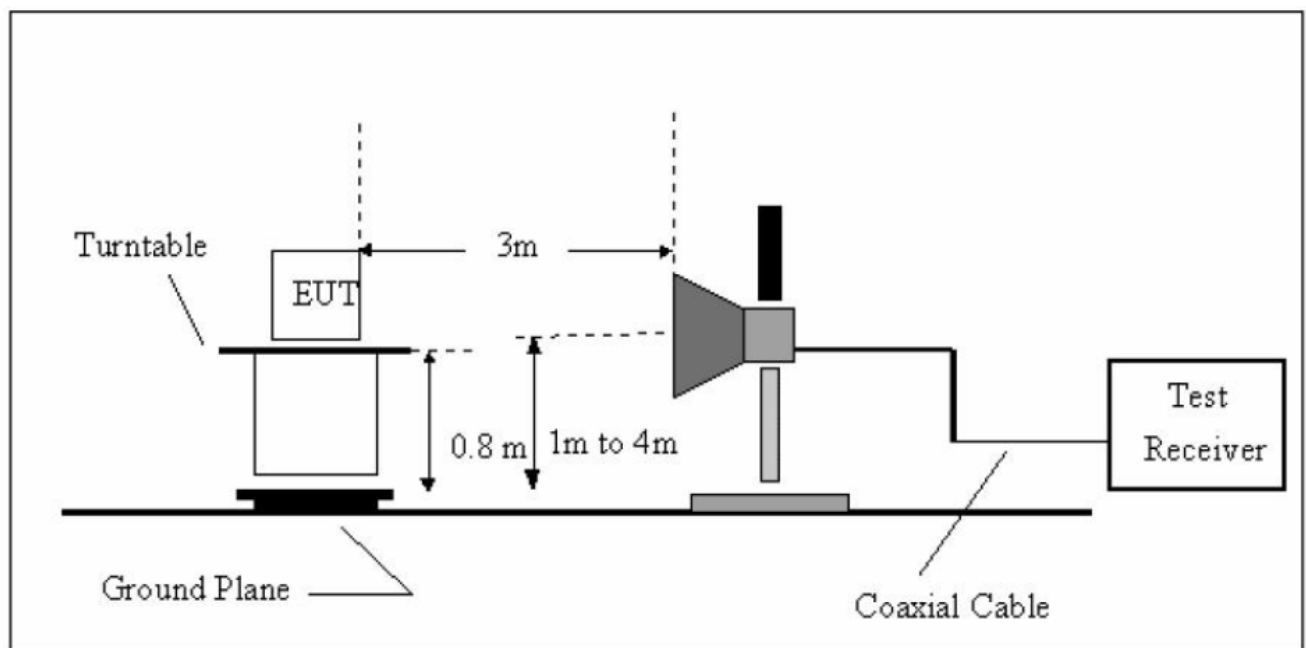

5.3 Test Procedure

- (1) The measuring distance of 3m shall be used for measurements at frequency up to 1GHz and above 1 GHz. The EUT was placed on a rotating 0.8m high above ground, the table was rotated 360 degrees to determine the position of the highest radiation.
- (2) The Test antenna shall vary between 1m and 4m, Both Horizontal and Vertical antenna are set to make measurement.
- (3) The initial step in collecting conducted emission data is a spectrum analyzer peak detector mode pre-scanning the measurement frequency range. Significant peaks are then marked and then Quasi Peak detector mode re-measured.
- (4) If the Peak Mode measured value compliance with and lower than Quasi Peak Mode Limit

Bellow 1 GHz, the EUT shall be deemed to meet QP Limits and then no additional QP Mode measurement performed. But the Peak Value and average value both need to comply with applicable limit above 1 GHz.

Peak Detection:

Set the center frequency of the emission to be measured (within 2 MHz of the authorized band edge), set span to 2 MHz, with RBW/VBW=100 kHz/300 kHz, detector mode is Peak, then use band power function to measure the Bandwidth of 1 MHz.

Average Detection (EUT transmitting continuously and duty cycle \geq 98 percent):

Set the center frequency of the emission to be measured (within 2 MHz of the authorized band edge), set span to 2 MHz, with RBW/VBW=100 kHz/300 kHz, detector mode is RMS or Average, then use band power function to measure the Bandwidth of 1 MHz.

(5) For the actual test configuration, please see the test setup photo.

5.4 EUT Operating Condition

The Equipment Under Test was set to Continual Transmitting in maximum power.

5.5 Test Equipment

Equipment	Manufacturer	Model No.	Serial No.	Last Cal.	Cal. Due Date
Spectrum Analyzer	Agilent	E4407B	MY45106456	Mar. 20, 2014	Mar. 19, 2015
Spectrum Analyzer	Rohde & Schwarz	FSP30	DE25181	Aug. 10, 2013	Aug.09, 2014
EMI Test Receiver	Rohde & Schwarz	ESCI	101165	Aug. 10, 2013	Aug.09, 2014
Bilog Antenna	ETS-LINDGREN	3142E	00117537	Mar. 07, 2014	Mar.06, 2015
Bilog Antenna	ETS-LINDGREN	3142E	00117542	Mar. 07, 2014	Mar.06, 2015
Horn Antenna	ETS-LINDGREN	3117	00143207	Mar. 07, 2014	Mar.06, 2015
Horn Antenna	ETS-LINDGREN	3117	00143209	Mar. 07, 2014	Mar.06, 2015
Pre-amplifier	HP	11909A	185903	Mar. 07, 2014	Mar.06, 2015
Pre-amplifier	HP	8447B	3008A00849	Mar. 07, 2014	Mar.06, 2015
Cable	HUBER+SUHNER	100	SUCOFLEX	Mar. 07, 2014	Mar.06, 2015
Signal Generator	Rohde & Schwarz	SML03	IKW682-054	Feb. 11, 2014	Feb.10, 2015
Positioning Controller	ETS-LINDGREN	2090	N/A	N/A	N/A

5.6 Test Data

Please see the next page.

(1) Radiation Test

EUT:	MID	Model:	MID713-U
Temperature:	25 °C	Relative Humidity:	55%
Test Voltage:	AC 120V/60 Hz		
Ant. Pol.	Horizontal		
Test Mode:	TX B Mode 2412MHz		
Remark:	N/A		

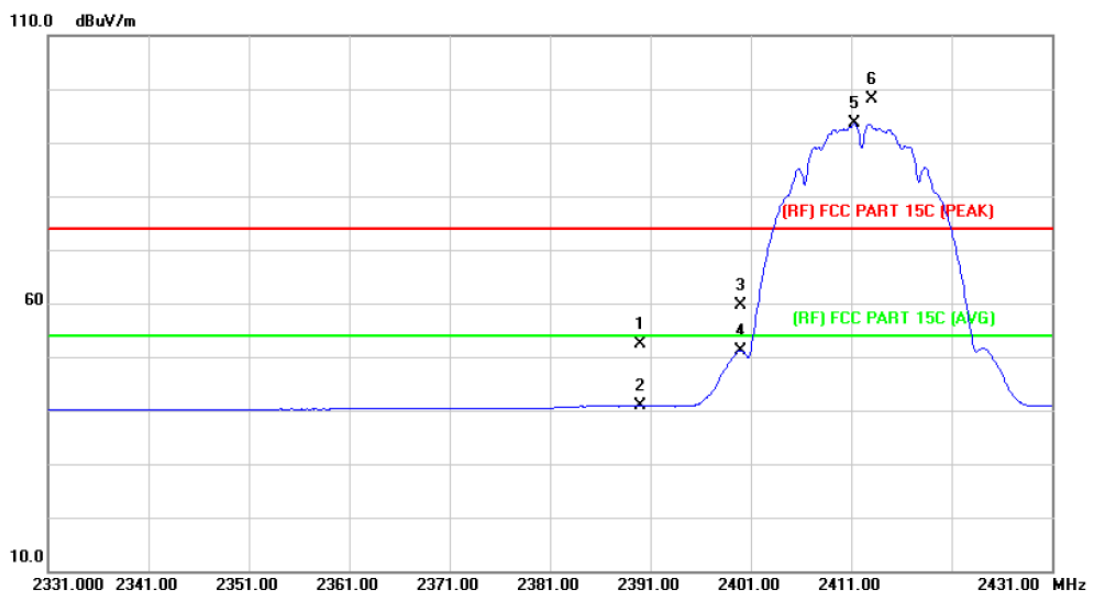

No.	Mk.	Freq. MHz	Reading Level dBuV	Correct Factor dB/m	Measure- ment dBuV/m	Limit dBuV/m	Over dB	Detector
1		2390.000	51.52	0.77	52.29	74.00	-21.71	peak
2		2390.000	40.12	0.77	40.89	54.00	-13.11	AVG
3		2400.000	58.72	0.81	59.53	74.00	-14.47	peak
4		2400.000	50.31	0.81	51.12	54.00	-2.88	AVG
5	*	2411.300	92.65	0.86	93.51	54.00	39.51	AVG
6	X	2413.100	97.35	0.86	98.21	74.00	24.21	peak

Emission Level= Read Level+ Correct Factor

EUT:	MID	Model:	MID713-U
Temperature:	25 °C	Relative Humidity:	55%
Test Voltage:	AC 120V/60 Hz		
Ant. Pol.	Vertical		
Test Mode:	TX B Mode 2412MHz		
Remark:	N/A		

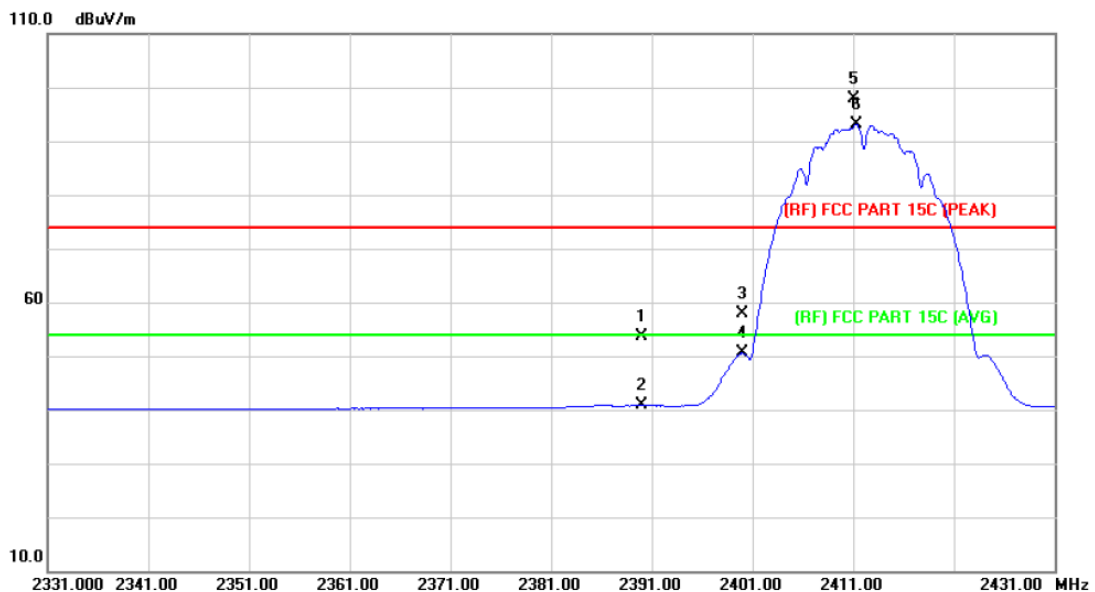

No.	Mk.	Freq. MHz	Reading Level dBuV	Correct Factor dB/m	Measure- ment dBuV/m	Limit dBuV/m	Over dB	Detector
1		2390.000	52.97	0.77	53.74	74.00	-20.26	peak
2		2390.000	39.99	0.77	40.76	54.00	-13.24	AVG
3		2400.000	57.18	0.81	57.99	74.00	-16.01	peak
4		2400.000	49.72	0.81	50.53	54.00	-3.47	AVG
5	X	2411.000	96.91	0.86	97.77	74.00	23.77	peak
6	*	2411.300	92.27	0.86	93.13	54.00	39.13	AVG

Emission Level= Read Level+ Correct Factor

EUT:	MID	Model:	MID713-U
Temperature:	25 °C	Relative Humidity:	55%
Test Voltage:	AC 120V/60 Hz		
Ant. Pol.	Horizontal		
Test Mode:	TX B Mode 2437MHz		
Remark:	N/A		

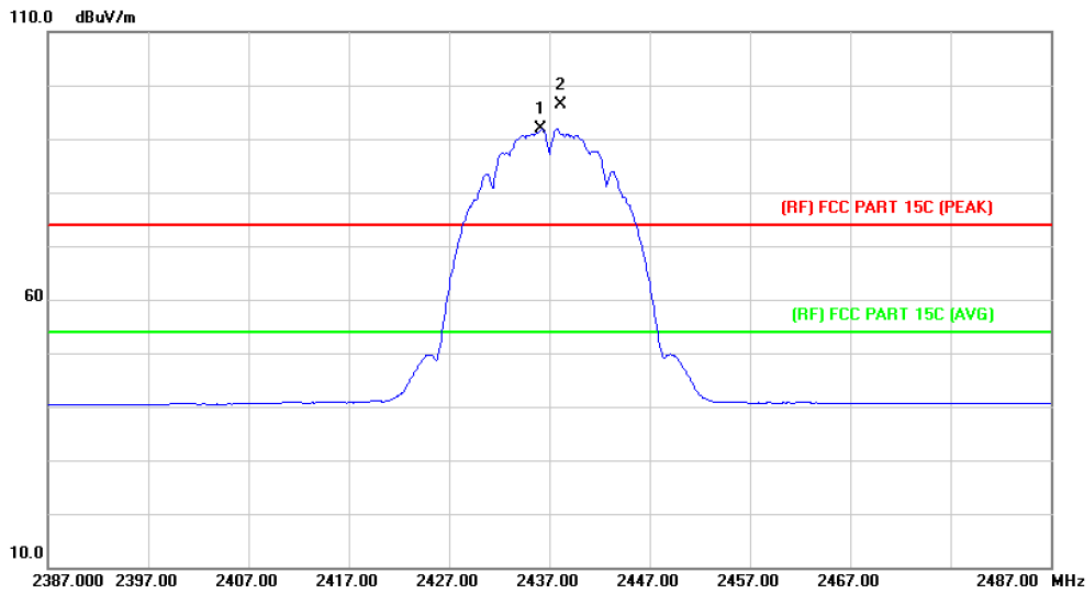

No.	Mk.	Freq.	Reading Level	Correct Factor	Measurement	Limit	Over	
		MHz	dBuV	dB/m	dBuV/m	dBuV/m	dB	Detector
1	*	2436.200	90.82	0.97	91.79	54.00	37.79	AVG
2	X	2438.100	95.50	0.98	96.48	74.00	22.48	peak

Emission Level= Read Level+ Correct Factor

EUT:	MID	Model:	MID713-U
Temperature:	25 °C	Relative Humidity:	55%
Test Voltage:	AC 120V/60 Hz		
Ant. Pol.	Vertical		
Test Mode:	TX B Mode 2437MHz		
Remark:	N/A		

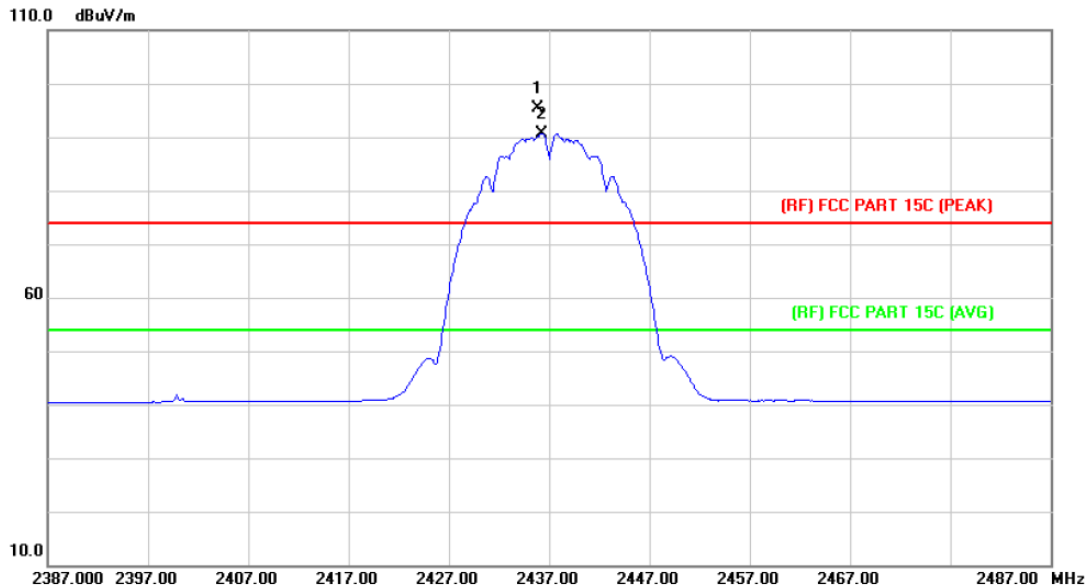

No.	Mk.	Freq.	Reading Level	Correct Factor	Measurement	Limit	Over	Detector
		MHz	dBuV	dB/m	dBuV/m	dBuV/m	dB	
1	X	2435.900	94.39	0.97	95.36	74.00	21.36	peak
2	*	2436.300	89.73	0.97	90.70	54.00	36.70	AVG

Emission Level= Read Level+ Correct Factor

EUT:	MID	Model:	MID713-U
Temperature:	25 °C	Relative Humidity:	55%
Test Voltage:	AC 120V/60 Hz		
Ant. Pol.	Horizontal		
Test Mode:	TX B Mode 2462MHz		
Remark:	N/A		

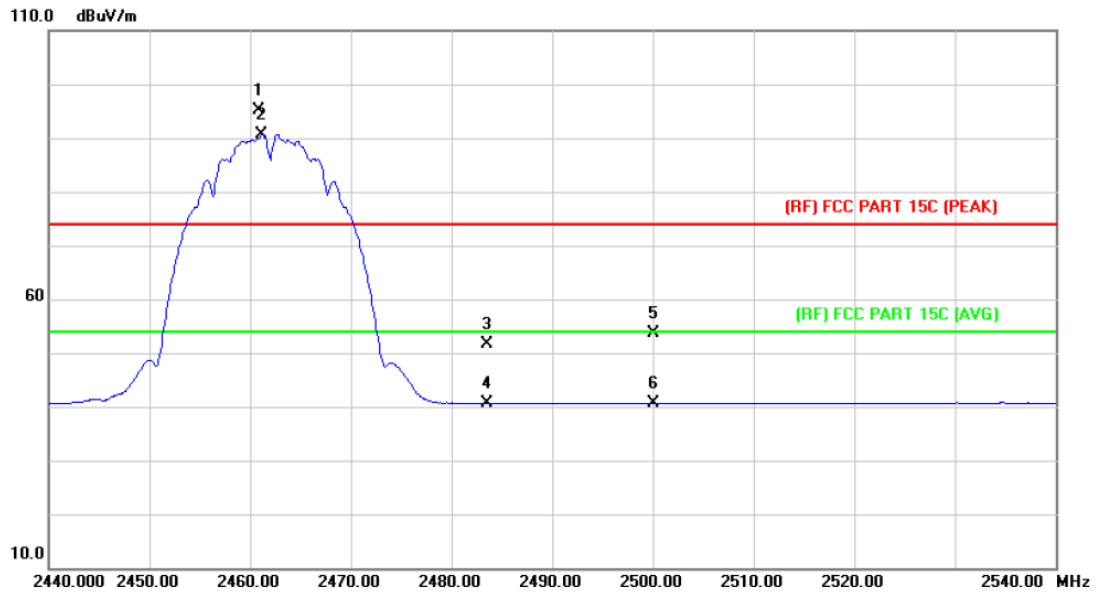

No.	Mk.	Freq. MHz	Reading Level dBuV	Correct Factor dB/m	Measure- ment dBuV/m	Limit dBuV/m	Over dB	Detector
1	X	2460.900	94.15	1.06	95.21	74.00	21.21	peak
2	*	2461.200	89.55	1.07	90.62	54.00	36.62	AVG
3		2483.500	50.35	1.17	51.52	74.00	-22.48	peak
4		2483.500	39.45	1.17	40.62	54.00	-13.38	AVG
5		2500.000	52.38	1.23	53.61	74.00	-20.39	peak
6		2500.000	39.34	1.23	40.57	54.00	-13.43	AVG

Emission Level= Read Level+ Correct Factor

EUT:	MID	Model:	MID713-U
Temperature:	25 °C	Relative Humidity:	55%
Test Voltage:	AC 120V/60 Hz		
Ant. Pol.	Vertical		
Test Mode:	TX B Mode 2462MHz		
Remark:	N/A		

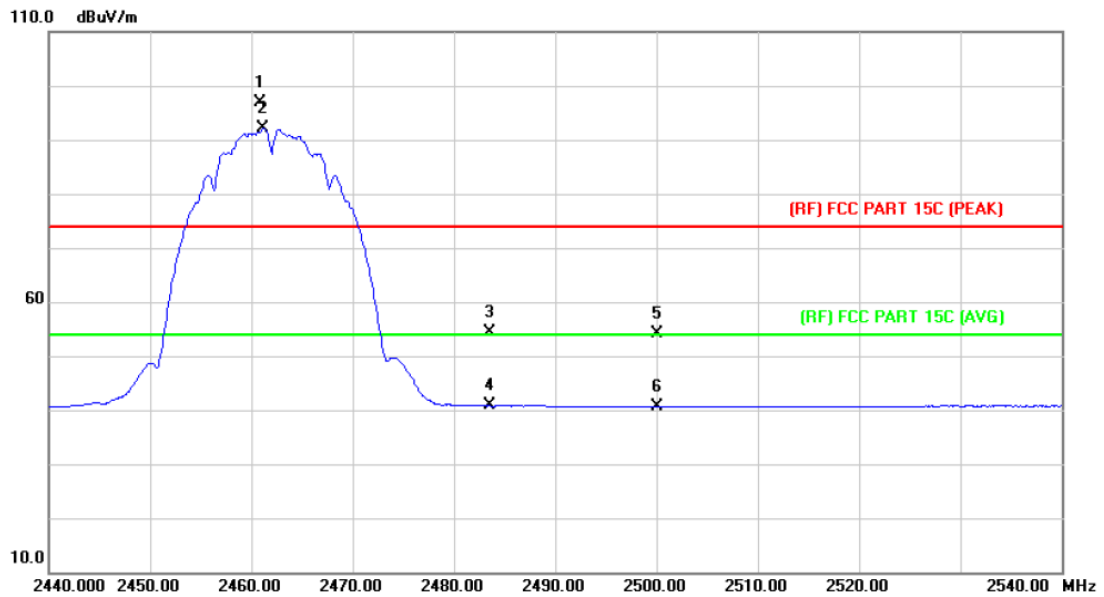

No.	Mk.	Freq. MHz	Reading Level dBuV	Correct Factor dB/m	Measure- ment dBuV/m	Limit dBuV/m	Over dB	Detector
1	X	2460.900	95.74	1.06	96.80	74.00	22.80	peak
2	*	2461.200	91.08	1.07	92.15	54.00	38.15	AVG
3		2483.500	53.20	1.17	54.37	74.00	-19.63	peak
4		2483.500	39.60	1.17	40.77	54.00	-13.23	AVG
5		2500.000	52.81	1.23	54.04	74.00	-19.96	peak
6		2500.000	39.41	1.23	40.64	54.00	-13.36	AVG

Emission Level= Read Level+ Correct Factor

EUT:	MID	Model:	MID713-U
Temperature:	25 °C	Relative Humidity:	55%
Test Voltage:	AC 120V/60 Hz		
Ant. Pol.	Horizontal		
Test Mode:	TX G Mode 2412MHz		
Remark:	N/A		

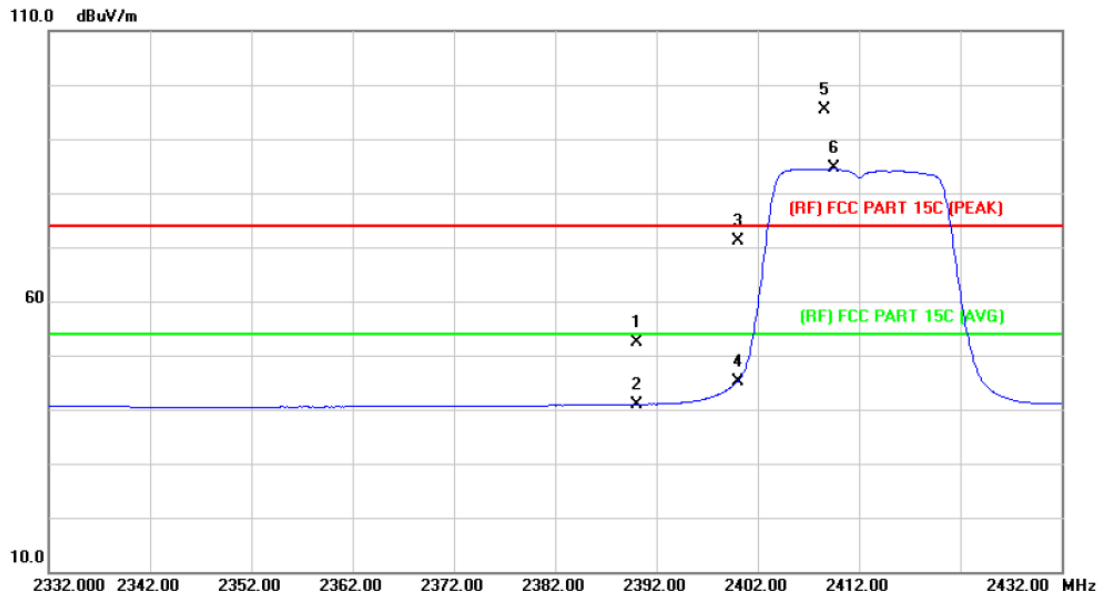

No.	Mk.	Freq. MHz	Reading Level dBuV	Correct Factor dB/m	Measure- ment dBuV/m	Limit dBuV/m	Over dB	Detector
1		2390.000	51.54	0.77	52.31	74.00	-21.69	peak
2		2390.000	40.14	0.77	40.91	54.00	-13.09	AVG
3		2400.000	70.32	0.81	71.13	74.00	-2.87	peak
4		2400.000	44.39	0.81	45.20	54.00	-8.80	AVG
5	X	2408.600	94.43	0.85	95.28	74.00	21.28	peak
6	*	2409.500	83.69	0.85	84.54	54.00	30.54	AVG

Emission Level= Read Level+ Correct Factor

EUT:	MID	Model:	MID713-U
Temperature:	25 °C	Relative Humidity:	55%
Test Voltage:	AC 120V/60 Hz		
Ant. Pol.	Vertical		
Test Mode:	TX G Mode 2412MHz		
Remark:	N/A		

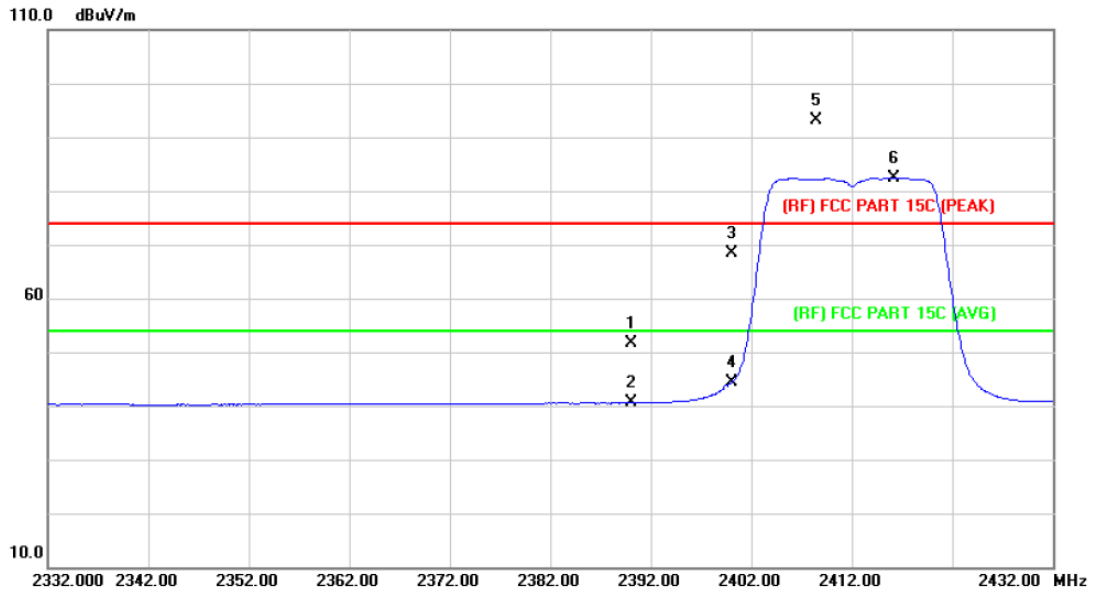

No.	Mk.	Freq. MHz	Reading Level dBuV	Correct Factor dB/m	Measure- ment dBuV/m	Limit dBuV/m	Over dB	Detector
1		2390.000	50.98	0.77	51.75	74.00	-22.25	peak
2		2390.000	39.83	0.77	40.60	54.00	-13.40	AVG
3		2400.000	67.60	0.81	68.41	74.00	-5.59	peak
4		2400.000	43.56	0.81	44.37	54.00	-9.63	AVG
5	X	2408.500	92.24	0.85	93.09	74.00	19.09	peak
6	*	2416.200	81.53	0.88	82.41	54.00	28.41	AVG

Emission Level= Read Level+ Correct Factor

EUT:	MID	Model:	MID713-U
Temperature:	25 °C	Relative Humidity:	55%
Test Voltage:	AC 120V/60 Hz		
Ant. Pol.	Horizontal		
Test Mode:	TX G Mode 2437MHz		
Remark:	N/A		

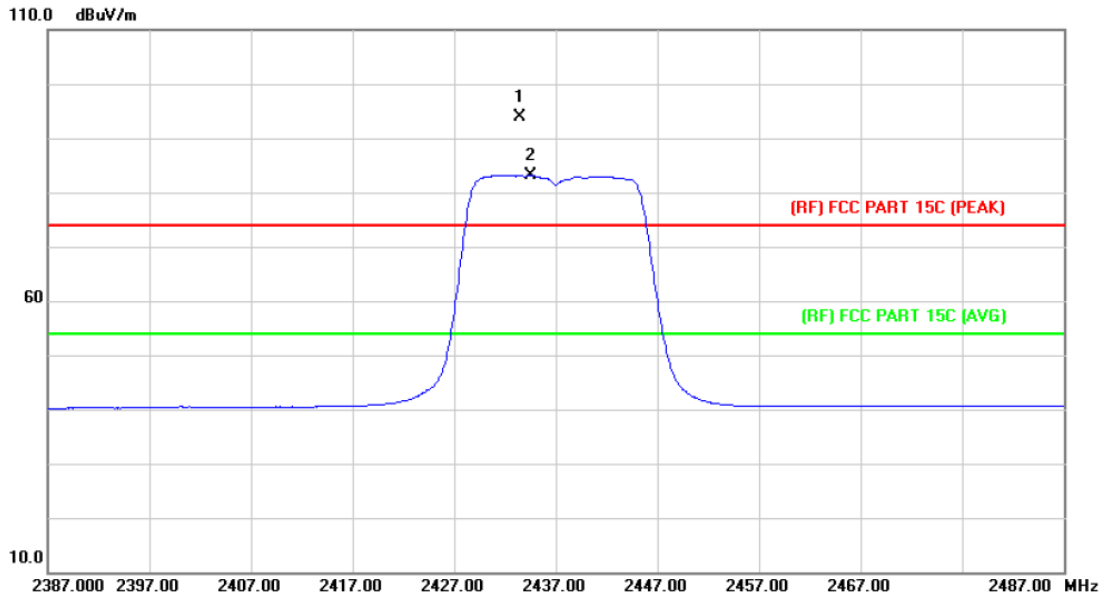

No.	Mk.	Freq.	Reading Level	Correct Factor	Measurement	Limit	Over	
		MHz	dBuV	dB/m	dBuV/m	dBuV/m	dB	Detector
1	X	2433.500	92.94	0.96	93.90	74.00	19.90	peak
2	*	2434.600	82.20	0.97	83.17	54.00	29.17	AVG

Emission Level= Read Level+ Correct Factor

EUT:	MID	Model:	MID713-U
Temperature:	25 °C	Relative Humidity:	55%
Test Voltage:	AC 120V/60 Hz		
Ant. Pol.	Vertical		
Test Mode:	TX G Mode 2437MHz		
Remark:	N/A		

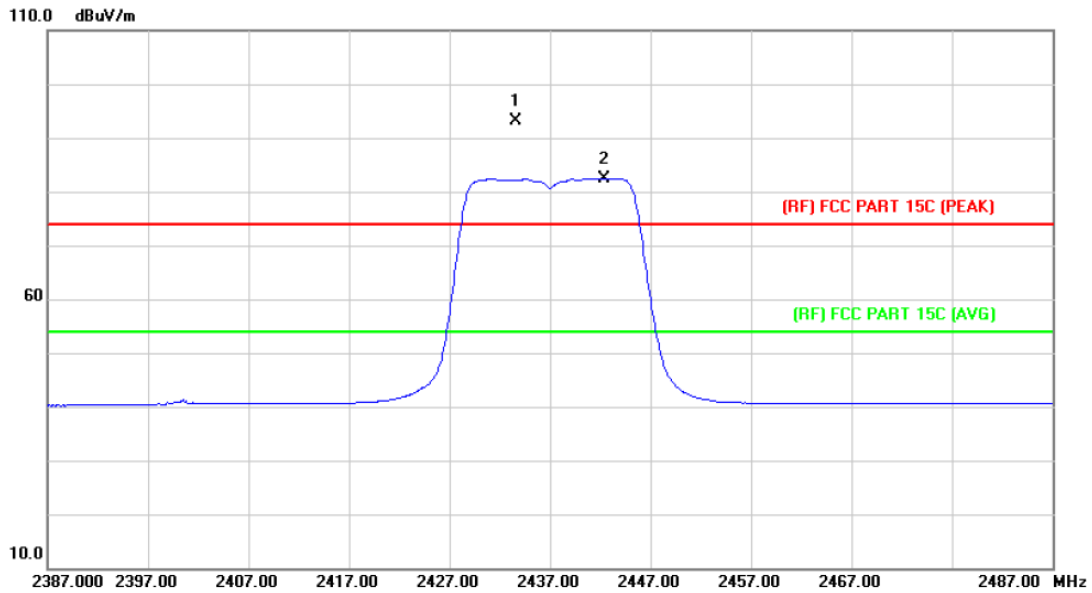

No.	Mk.	Freq.	Reading Level	Correct Factor	Measurement	Limit	Over	
		MHz	dBuV	dB/m	dBuV/m	dBuV/m	dB	Detector
1	X	2433.600	92.14	0.96	93.10	74.00	19.10	peak
2	*	2442.400	81.48	0.99	82.47	54.00	28.47	AVG

Emission Level= Read Level+ Correct Factor

EUT:	MID	Model:	MID713-U
Temperature:	25 °C	Relative Humidity:	55%
Test Voltage:	AC 120V/60 Hz		
Ant. Pol.	Horizontal		
Test Mode:	TX G Mode 2462MHz		
Remark:	N/A		

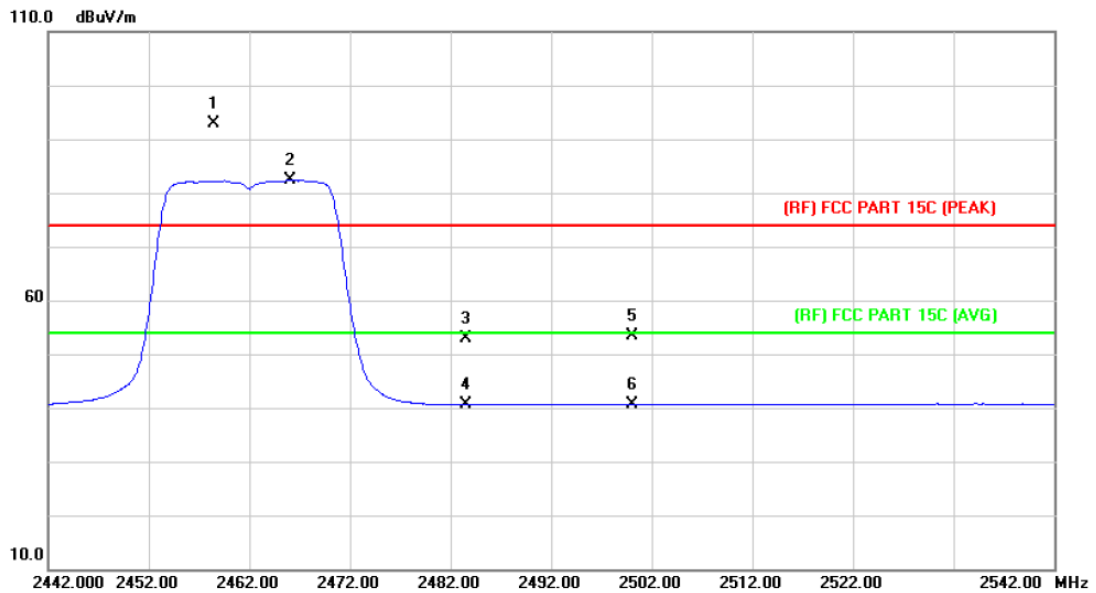

No.	Mk.	Freq. MHz	Reading Level dBuV	Correct Factor dB/m	Measure- ment dBuV/m	Limit dBuV/m	Over dB	Detector
1	X	2458.500	91.92	1.06	92.98	74.00	18.98	peak
2	*	2466.100	81.26	1.09	82.35	54.00	28.35	AVG
3		2483.500	51.72	1.17	52.89	74.00	-21.11	peak
4		2483.500	39.43	1.17	40.60	54.00	-13.40	AVG
5		2500.000	52.11	1.23	53.34	74.00	-20.66	peak
6		2500.000	39.38	1.23	40.61	54.00	-13.39	AVG

Emission Level= Read Level+ Correct Factor

EUT:	MID	Model:	MID713-U
Temperature:	25 °C	Relative Humidity:	55%
Test Voltage:	AC 120V/60 Hz		
Ant. Pol.	Vertical		
Test Mode:	TX G Mode 2462MHz		
Remark:	N/A		

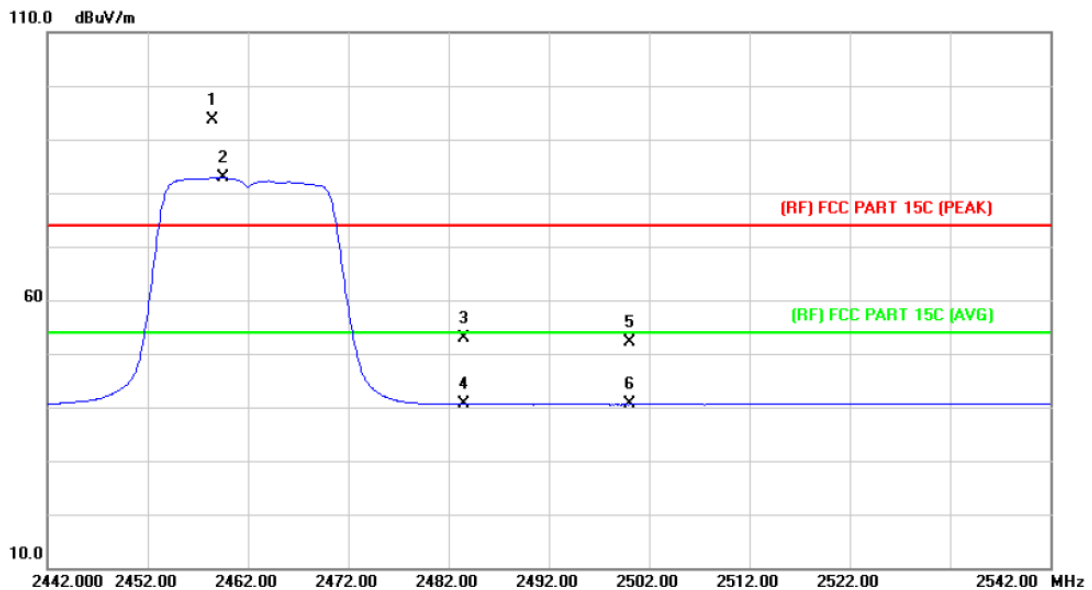

No.	Mk.	Freq. MHz	Reading Level dBuV	Correct Factor dB/m	Measure- ment dBuV/m	Limit dBuV/m	Over dB	Detector
1	X	2458.500	92.63	1.06	93.69	74.00	19.69	peak
2	*	2459.500	81.88	1.06	82.94	54.00	28.94	AVG
3		2483.500	51.72	1.17	52.89	74.00	-21.11	peak
4		2483.500	39.41	1.17	40.58	54.00	-13.42	AVG
5		2500.000	50.99	1.23	52.22	74.00	-21.78	peak
6		2500.000	39.30	1.23	40.53	54.00	-13.47	AVG

Emission Level= Read Level+ Correct Factor

EUT:	MID	Model:	MID713-U
Temperature:	25 °C	Relative Humidity:	55%
Test Voltage:	AC 120V/60 Hz		
Ant. Pol.	Horizontal		
Test Mode:	TX N(HT20) Mode 2412MHz		
Remark:	N/A		

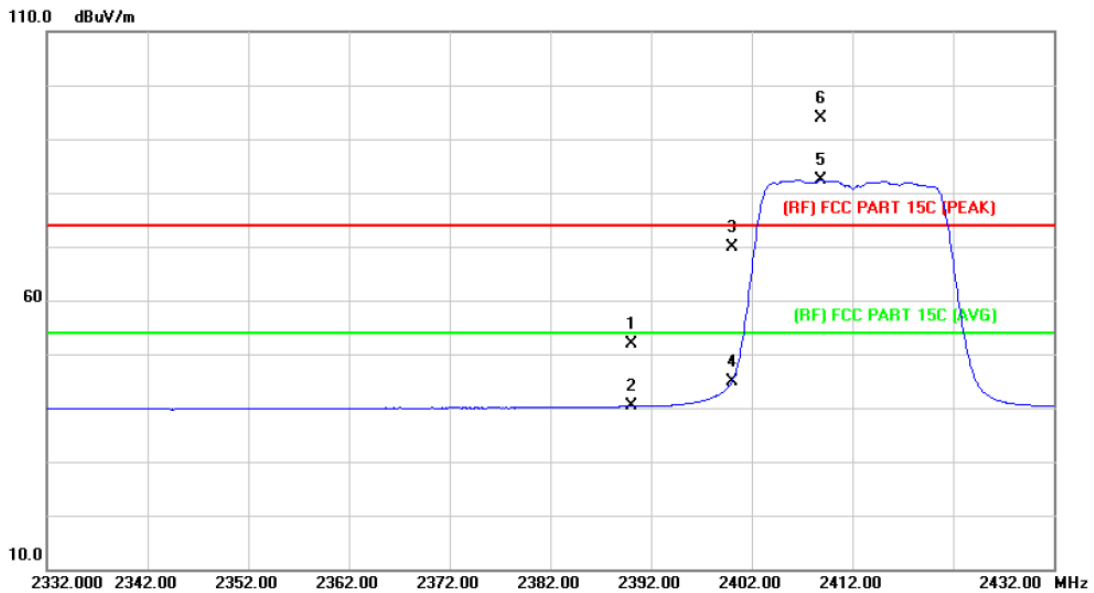

No.	Mk.	Freq.	Reading Level	Correct Factor	Measurement	Limit	Over	Detector
		MHz	dBuV	dB/m	dBuV/m	dBuV/m	dB	
1		2390.000	51.04	0.77	51.81	74.00	-22.19	peak
2		2390.000	39.52	0.77	40.29	54.00	-13.71	AVG
3		2400.000	69.04	0.81	69.85	74.00	-4.15	peak
4		2400.000	43.96	0.81	44.77	54.00	-9.23	AVG
5	*	2408.800	81.45	0.85	82.30	54.00	28.30	AVG
6	X	2408.900	92.95	0.85	93.80	74.00	19.80	peak

Emission Level= Read Level+ Correct Factor

EUT:	MID	Model:	MID713-U
Temperature:	25 °C	Relative Humidity:	55%
Test Voltage:	AC 120V/60 Hz		
Ant. Pol.	Vertical		
Test Mode:	TX N(HT20) Mode 2412MHz		
Remark:	N/A		

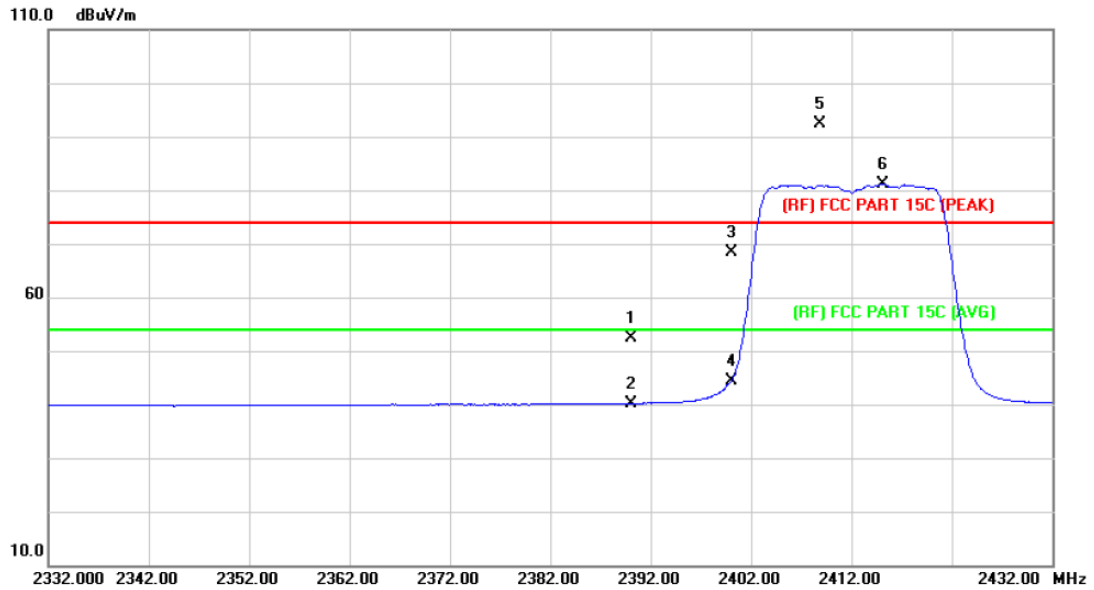

No.	Mk.	Freq. MHz	Reading Level dBuV	Correct Factor dB/m	Measure- ment dBuV/m	Limit dBuV/m	Over dB	Detector
1		2390.000	51.55	0.77	52.32	74.00	-21.68	peak
2		2390.000	39.48	0.77	40.25	54.00	-13.75	AVG
3		2400.000	67.48	0.81	68.29	74.00	-5.71	peak
4		2400.000	43.58	0.81	44.39	54.00	-9.61	AVG
5	X	2408.800	91.48	0.85	92.33	74.00	18.33	peak
6	*	2415.200	80.23	0.88	81.11	54.00	27.11	AVG

Emission Level= Read Level+ Correct Factor

EUT:	MID	Model:	MID713-U
Temperature:	25 °C	Relative Humidity:	55%
Test Voltage:	AC 120V/60 Hz		
Ant. Pol.	Horizontal		
Test Mode:	TX N(HT20) Mode 2437MHz		
Remark:	N/A		

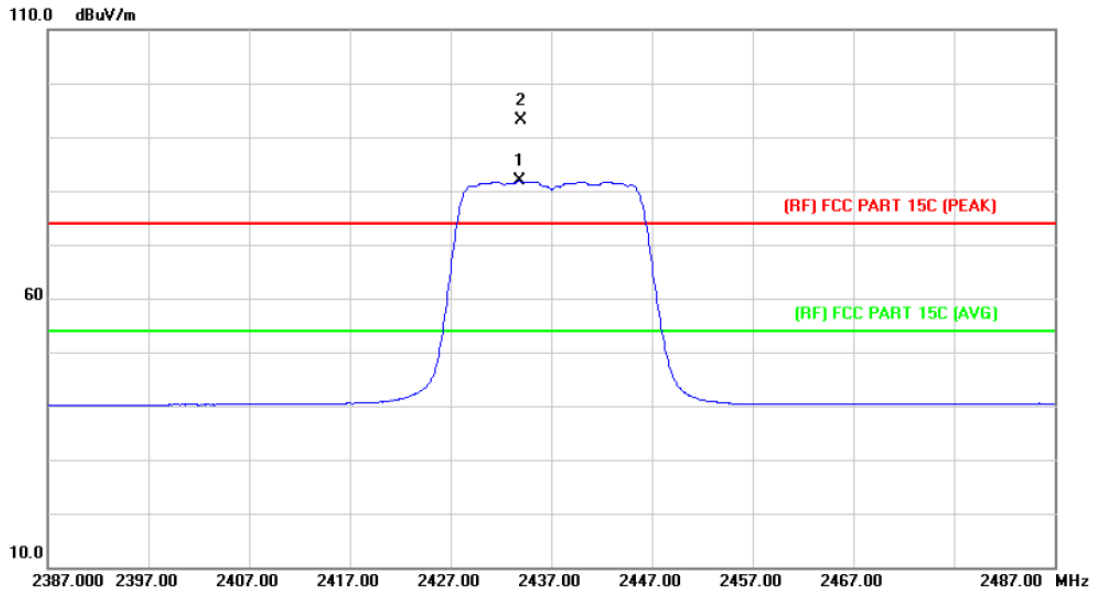

No.	Mk.	Freq. MHz	Reading Level dBuV	Correct Factor dB/m	Measure- ment dBuV/m	Limit dBuV/m	Over dB	Detector
1	*	2433.800	80.84	0.96	81.80	54.00	27.80	AVG
2	X	2434.000	92.27	0.96	93.23	74.00	19.23	peak

Emission Level= Read Level+ Correct Factor

EUT:	MID	Model:	MID713-U
Temperature:	25 °C	Relative Humidity:	55%
Test Voltage:	AC 120V/60 Hz		
Ant. Pol.	Vertical		
Test Mode:	TX N(HT20) Mode 2437MHz		
Remark:	N/A		

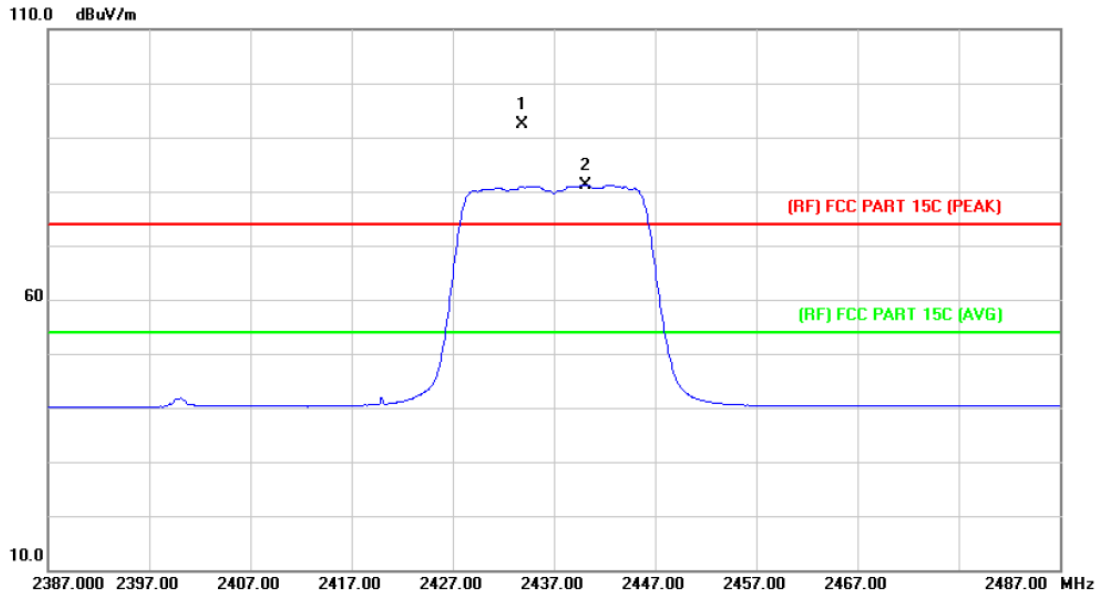

No.	Mk.	Freq. MHz	Reading Level dBuV	Correct Factor dB/m	Measure- ment dBuV/m	Limit dBuV/m	Over dB	Detector
1	X	2433.800	91.33	0.96	92.29	74.00	18.29	peak
2	*	2440.200	80.26	0.98	81.24	54.00	27.24	AVG

Emission Level= Read Level+ Correct Factor

EUT:	MID	Model:	MID713-U
Temperature:	25 °C	Relative Humidity:	55%
Test Voltage:	AC 120V/60 Hz		
Ant. Pol.	Horizontal		
Test Mode:	TX N(HT20) Mode 2462MHz		
Remark:	N/A		

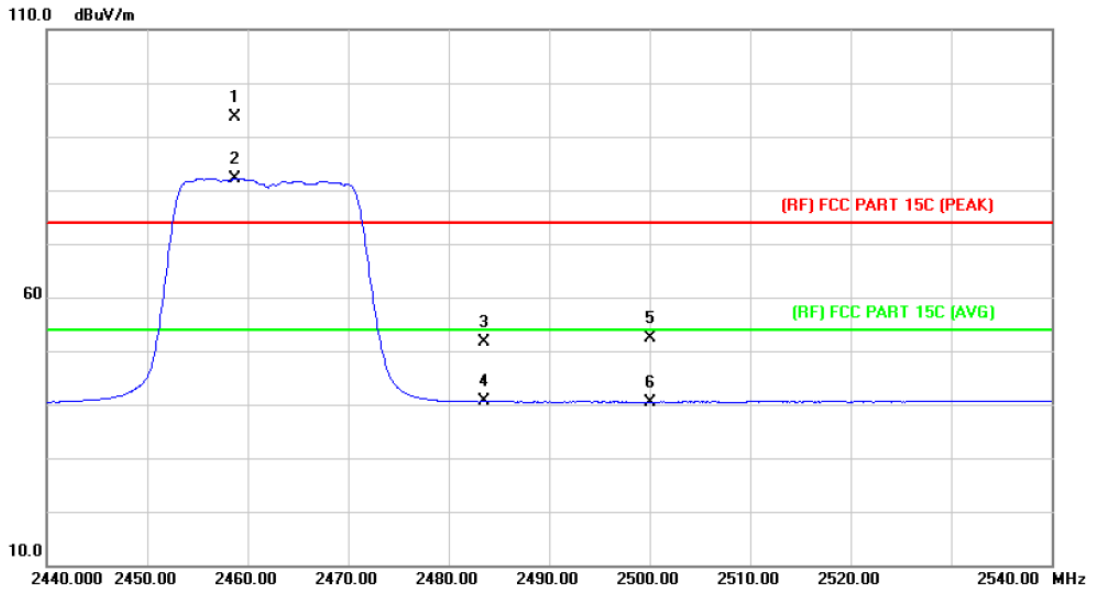

No.	Mk.	Freq. MHz	Reading Level dBuV	Correct Factor dB/m	Measure- ment dBuV/m	Limit dBuV/m	Over dB	Detector
1	X	2458.700	92.49	1.06	93.55	74.00	19.55	peak
2	*	2458.700	81.11	1.06	82.17	54.00	28.17	AVG
3		2483.500	50.40	1.17	51.57	74.00	-22.43	peak
4		2483.500	39.36	1.17	40.53	54.00	-13.47	AVG
5		2500.000	51.25	1.23	52.48	74.00	-21.52	peak
6		2500.000	39.23	1.23	40.46	54.00	-13.54	AVG

Emission Level= Read Level+ Correct Factor

EUT:	MID	Model:	MID713-U
Temperature:	25 °C	Relative Humidity:	55%
Test Voltage:	AC 120V/60 Hz		
Ant. Pol.	Vertical		
Test Mode:	TX N(HT20) Mode 2462MHz		
Remark:	N/A		

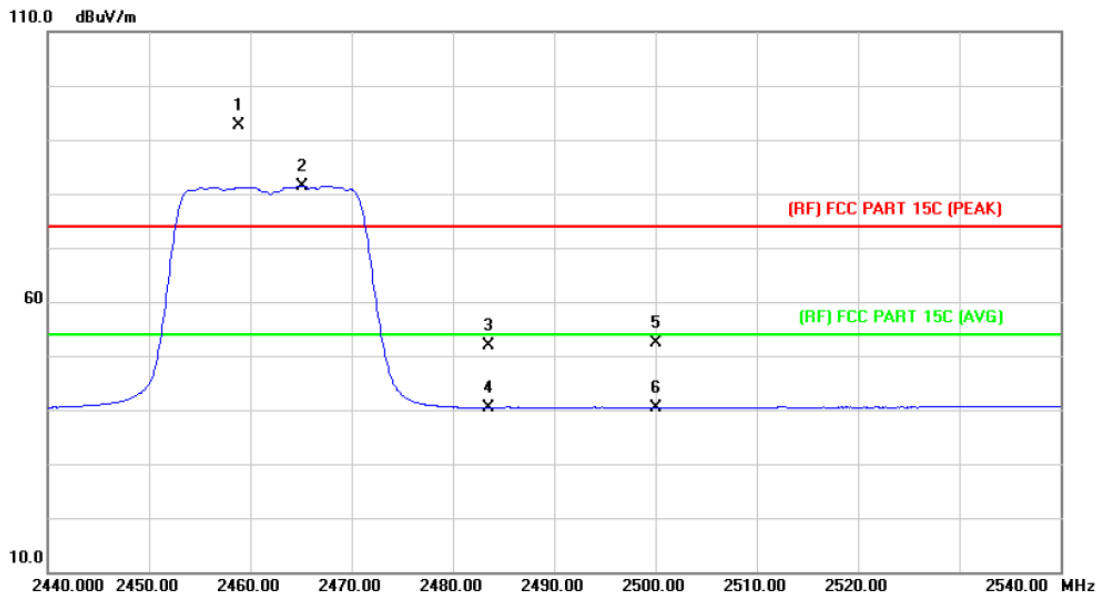

No.	Mk.	Freq. MHz	Reading Level dBuV	Correct Factor dB/m	Measure- ment dBuV/m	Limit dBuV/m	Over dB	Detector
1	X	2458.800	91.69	1.06	92.75	74.00	18.75	peak
2	*	2465.100	80.41	1.09	81.50	54.00	27.50	AVG
3		2483.500	50.83	1.17	52.00	74.00	-22.00	peak
4		2483.500	39.27	1.17	40.44	54.00	-13.56	AVG
5		2500.000	51.12	1.23	52.35	74.00	-21.65	peak
6		2500.000	39.18	1.23	40.41	54.00	-13.59	AVG

Emission Level= Read Level+ Correct Factor

EUT:	MID	Model:	MID713-U
Temperature:	25 °C	Relative Humidity:	55%
Test Voltage:	AC 120V/60 Hz		
Ant. Pol.	Horizontal		
Test Mode:	TX N(HT40) Mode 2422MHz		
Remark:	N/A		

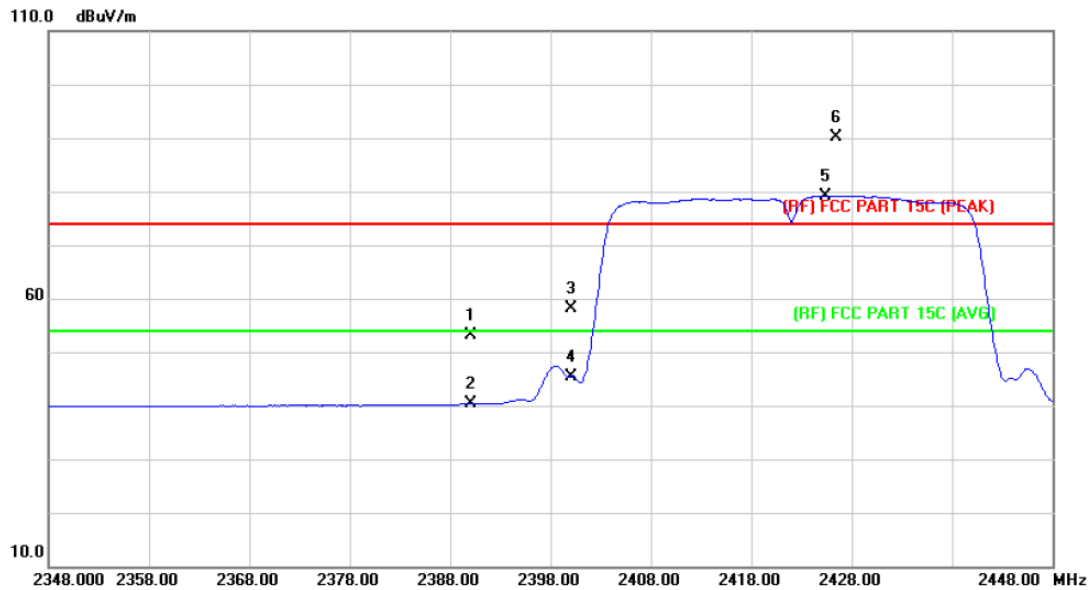

No.	Mk.	Freq.	Reading Level	Correct Factor	Measurement	Limit	Over	Detector
		MHz	dBuV	dB/m	dBuV/m	dBuV/m	dB	
1		2390.000	52.24	0.77	53.01	74.00	-20.99	peak
2		2390.000	39.53	0.77	40.30	54.00	-13.70	AVG
3		2400.000	57.27	0.81	58.08	74.00	-15.92	peak
4		2400.000	44.68	0.81	45.49	54.00	-8.51	AVG
5	*	2425.400	78.29	0.93	79.22	54.00	25.22	AVG
6	X	2426.400	89.08	0.93	90.01	74.00	16.01	peak

Emission Level= Read Level+ Correct Factor

EUT:	MID	Model:	MID713-U
Temperature:	25 °C	Relative Humidity:	55%
Test Voltage:	AC 120V/60 Hz		
Ant. Pol.	Vertical		
Test Mode:	TX N(HT40) Mode 2422MHz		
Remark:	N/A		

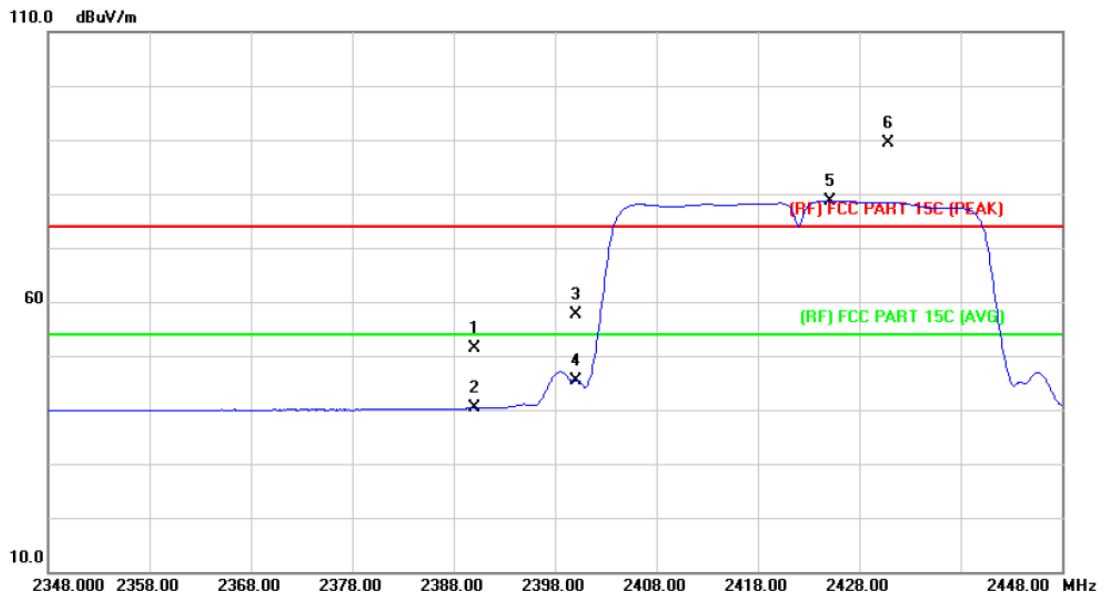

No.	Mk.	Freq.	Reading Level	Correct Factor	Measurement	Limit	Over	Detector
		MHz	dBuV	dB/m	dBuV/m	dBuV/m	dB	
1		2390.000	50.61	0.77	51.38	74.00	-22.62	peak
2		2390.000	39.49	0.77	40.26	54.00	-13.74	AVG
3		2400.000	56.83	0.81	57.64	74.00	-16.36	peak
4		2400.000	44.55	0.81	45.36	54.00	-8.64	AVG
5	*	2425.100	77.74	0.93	78.67	54.00	24.67	AVG
6	X	2430.900	88.43	0.95	89.38	74.00	15.38	peak

Emission Level= Read Level+ Correct Factor

EUT:	MID	Model:	MID713-U
Temperature:	25 °C	Relative Humidity:	55%
Test Voltage:	AC 120V/60 Hz		
Ant. Pol.	Horizontal		
Test Mode:	TX N(HT40) Mode 2437MHz		
Remark:	N/A		

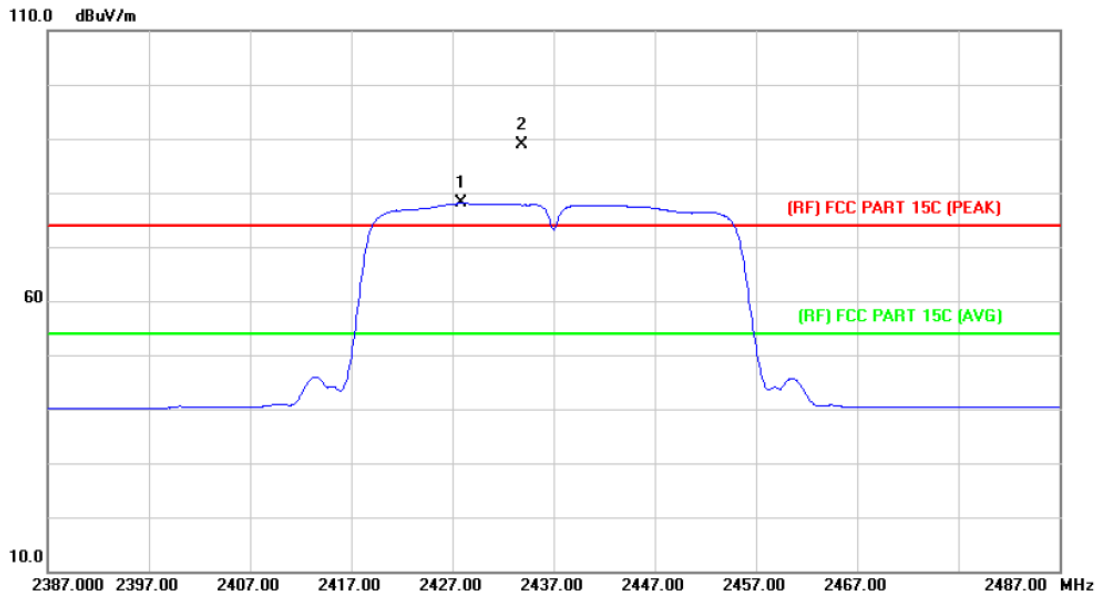

No.	Mk.	Freq.	Reading Level	Correct Factor	Measurement	Limit	Over	
		MHz	dBuV	dB/m	dBuV/m	dBuV/m	dB	Detector
1	*	2427.800	77.09	0.94	78.03	54.00	24.03	AVG
2	X	2433.900	87.87	0.96	88.83	74.00	14.83	peak

Emission Level= Read Level+ Correct Factor

EUT:	MID	Model:	MID713-U
Temperature:	25 °C	Relative Humidity:	55%
Test Voltage:	AC 120V/60 Hz		
Ant. Pol.	Vertical		
Test Mode:	TX N(HT40) Mode 2437MHz		
Remark:	N/A		

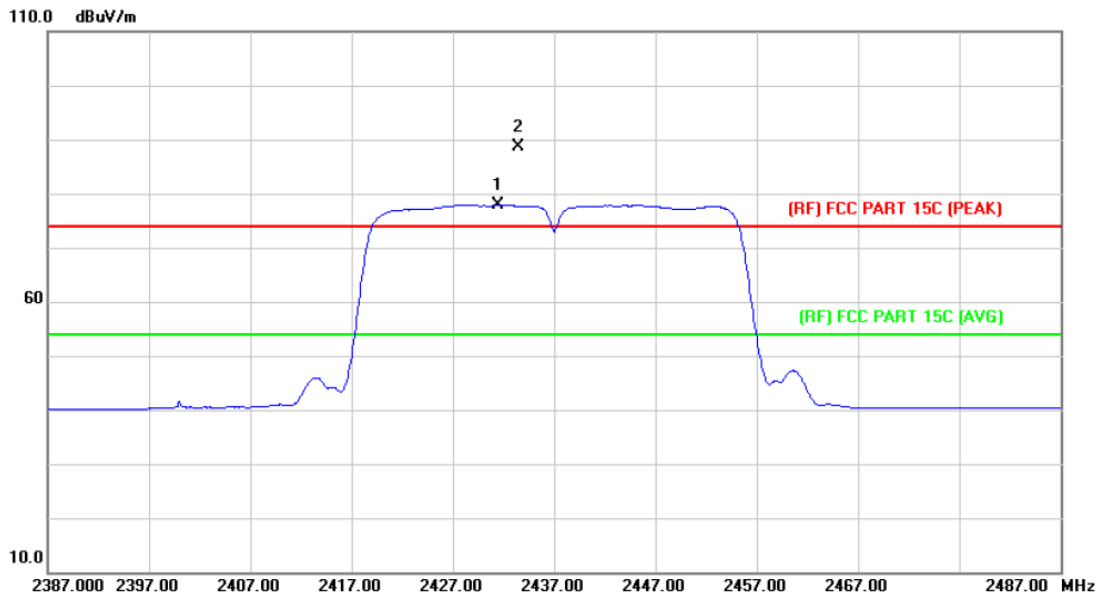

No.	Mk.	Freq.	Reading Level	Correct Factor	Measurement	Limit	Over	Detector
		MHz	dBuV	dB/m	dBuV/m	dBuV/m	dB	
1	*	2431.500	76.90	0.95	77.85	54.00	23.85	AVG
2	X	2433.400	87.79	0.96	88.75	74.00	14.75	peak

Emission Level= Read Level+ Correct Factor

EUT:	MID	Model:	MID713-U
Temperature:	25 °C	Relative Humidity:	55%
Test Voltage:	AC 120V/60 Hz		
Ant. Pol.	Horizontal		
Test Mode:	TX N(HT40) Mode 2452MHz		
Remark:	N/A		

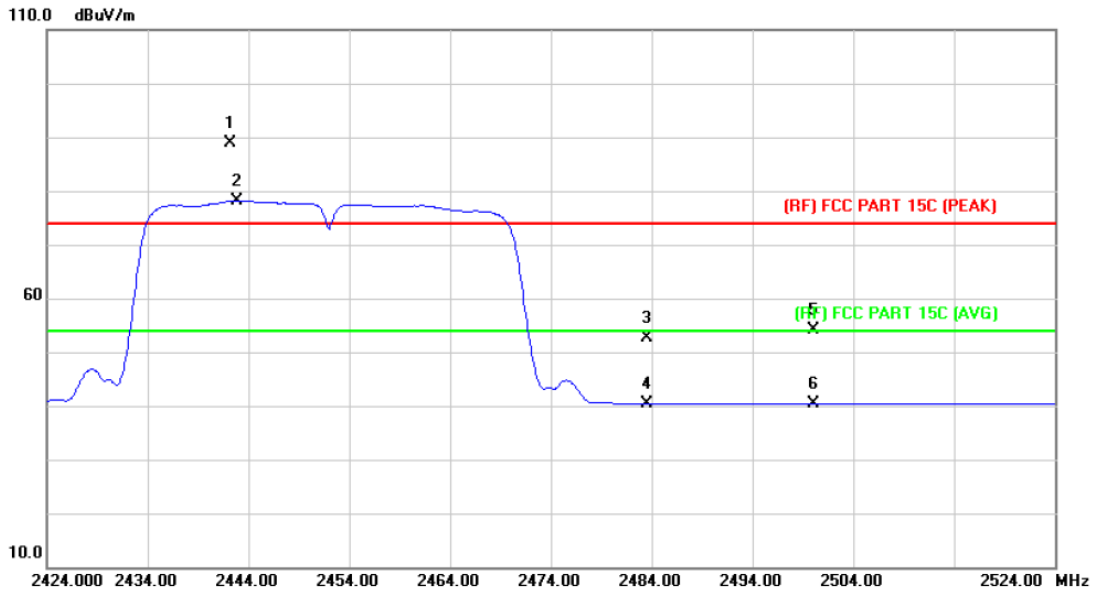

No.	Mk.	Freq. MHz	Reading Level dBuV	Correct Factor dB/m	Measure- ment dBuV/m	Limit dBuV/m	Over dB	Detector
1	X	2442.200	87.95	0.99	88.94	74.00	14.94	peak
2	*	2442.800	77.17	0.99	78.16	54.00	24.16	AVG
3		2483.500	51.57	1.17	52.74	74.00	-21.26	peak
4		2483.500	39.19	1.17	40.36	54.00	-13.64	AVG
5		2500.000	52.78	1.23	54.01	74.00	-19.99	peak
6		2500.000	39.15	1.23	40.38	54.00	-13.62	AVG

Emission Level= Read Level+ Correct Factor

EUT:	MID	Model:	MID713-U
Temperature:	25 °C	Relative Humidity:	55%
Test Voltage:	AC 120V/60 Hz		
Ant. Pol.	Vertical		
Test Mode:	TX N(HT40) Mode 2452MHz		
Remark:	N/A		

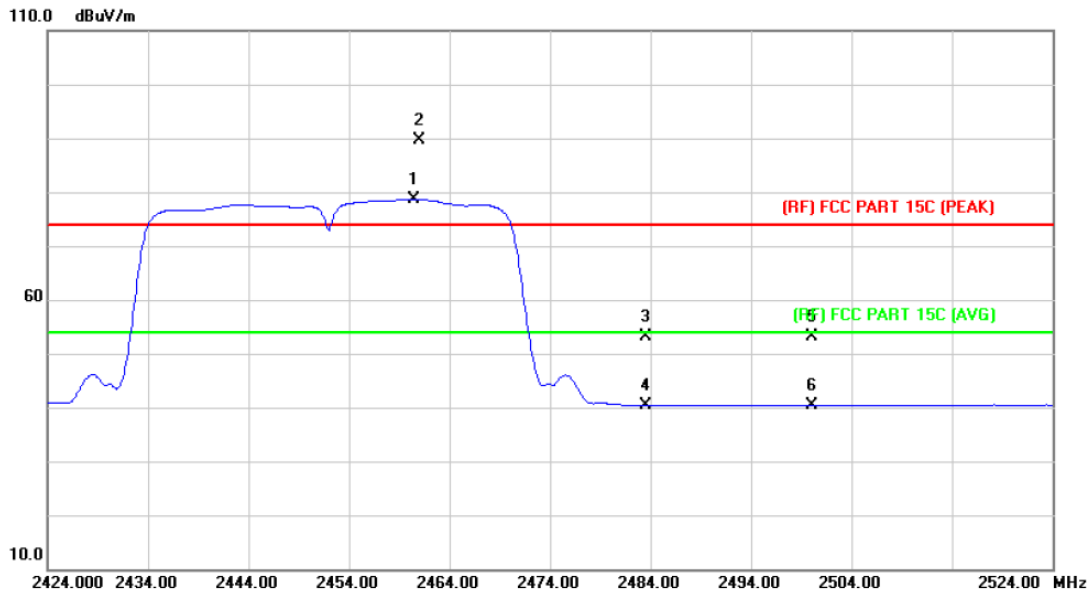

No.	Mk.	Freq.	Reading Level	Correct Factor	Measurement	Limit	Over	Detector
		MHz	dBuV	dB/m	dBuV/m	dBuV/m	dB	
1	*	2460.400	77.61	1.06	78.67	54.00	24.67	AVG
2	X	2461.000	88.53	1.06	89.59	74.00	15.59	peak
3		2483.500	51.90	1.17	53.07	74.00	-20.93	peak
4		2483.500	39.26	1.17	40.43	54.00	-13.57	AVG
5		2500.000	52.02	1.23	53.25	74.00	-20.75	peak
6		2500.000	39.18	1.23	40.41	54.00	-13.59	AVG

Emission Level= Read Level+ Correct Factor

(2) Conducted Test

EUT:	MID	Model:	MID713-U
Temperature:	25 °C	Relative Humidity:	55%
Test Voltage:	AC 120V/60 Hz		
Test Mode:	TX B Mode 2412MHz / TX B Mode 2462MHz		
Peak Power Output (dBm)	Emission Read Value (dBm)	Result of Band Edge (dBc)	Band edge Limit (dBc)
-5.50	-48.90	43.40	>20
-5.61	-48.66	43.05	

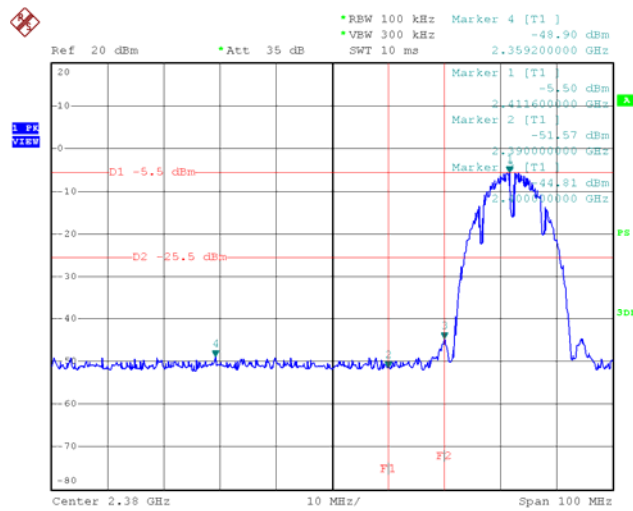

Date: 2.MAY.2014 06:58:38

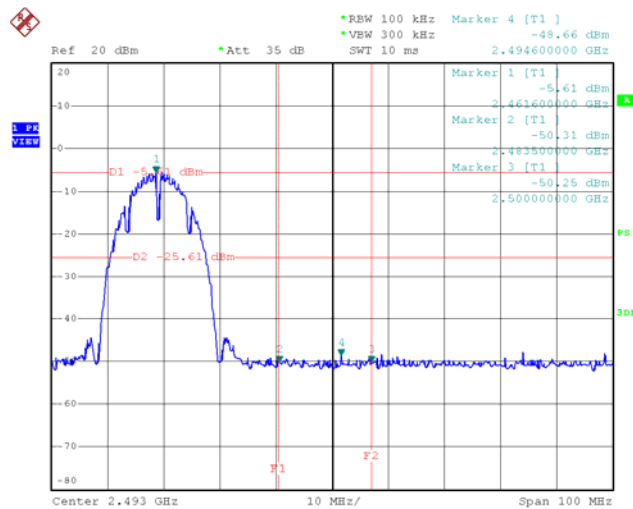

Date: 2.MAY.2014 07:06:39

EUT:	MID	Model:	MID713-U
Temperature:	25 °C	Relative Humidity:	55%
Test Voltage:	AC 120V/60 Hz		
Test Mode:	TX G Mode 2412MHz / TX G Mode 2462MHz		
Peak Power Output (dBm)	Emission Read Value (dBm)	Result of Band Edge (dBc)	Band edge Limit (dBc)
-13.63	-48.44	34.81	>20
-14.29	-48.87	34.58	

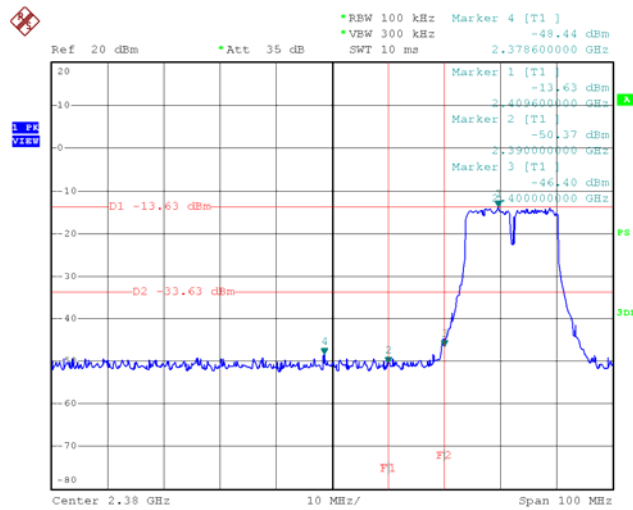

Date: 2.MAY.2014 06:56:39

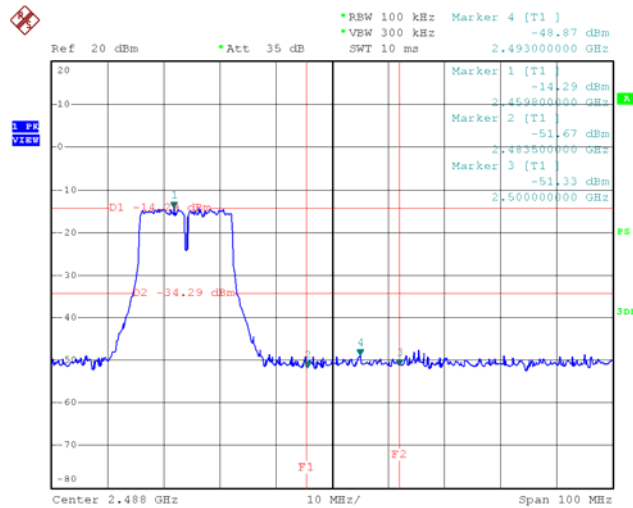

Date: 2.MAY.2014 06:48:38

EUT:	MID	Model:	MID713-U
Temperature:	25 °C	Relative Humidity:	55%
Test Voltage:	AC 120V/60 Hz		
Test Mode:	TX N(HT20) Mode 2412MHz / TX N(HT20) Mode 2462MHz		
Peak Power Output (dBm)	Emission Read Value (dBm)	Result of Band Edge (dBc)	Band edge Limit (dBc)
-13.72	-47.74	34.02	>20
-13.96	-49.00	35.04	

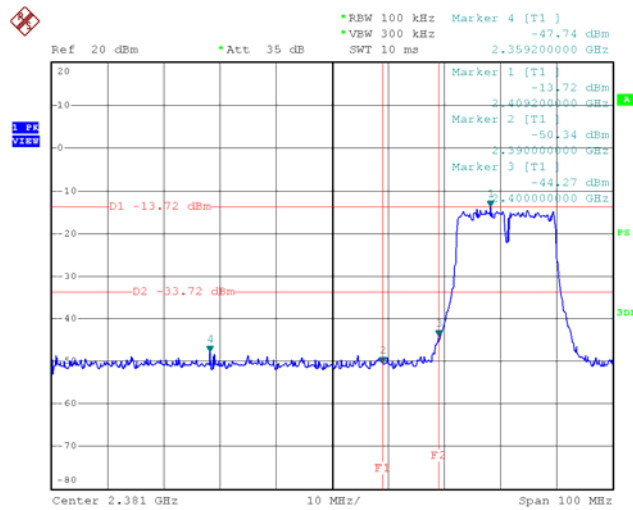

Date: 2.MAY.2014 06:42:04

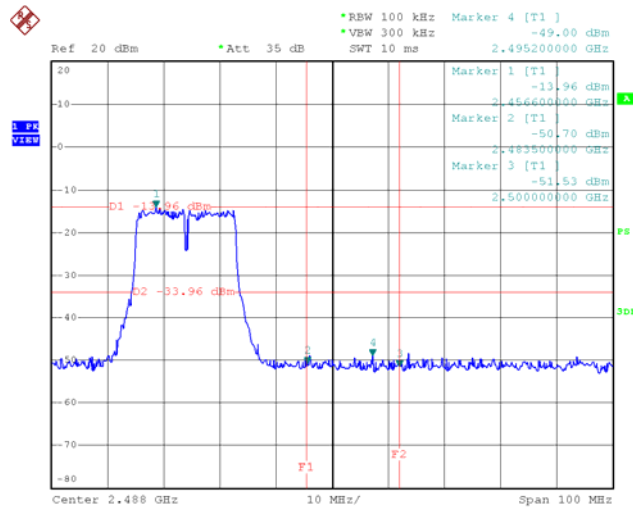

Date: 2.MAY.2014 06:43:38

EUT:	MID	Model:	MID713-U
Temperature:	25 °C	Relative Humidity:	55%
Test Voltage:	AC 120V/60 Hz		
Test Mode:	TX N(HT40) Mode 2422MHz / TX N(HT40) Mode 2452MHz		
Peak Power Output (dBm)	Emission Read Value (dBm)	Result of Band Edge (dBc)	Band edge Limit (dBc)
-15.62	-48.47	32.85	>20
-17.23	-47.33	30.10	

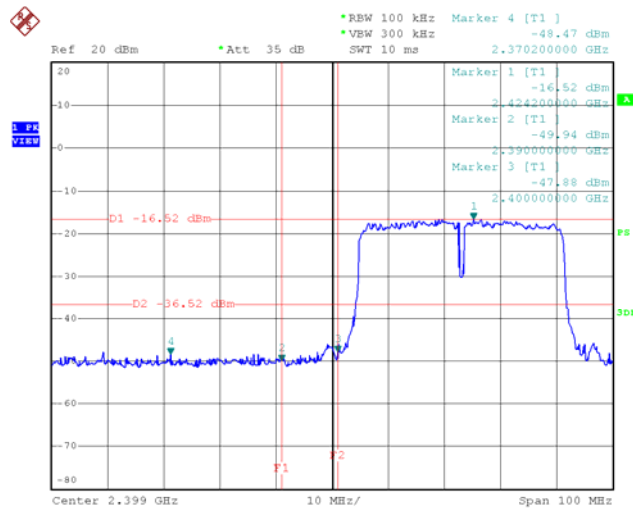

Date: 2.MAY.2014 06:30:01

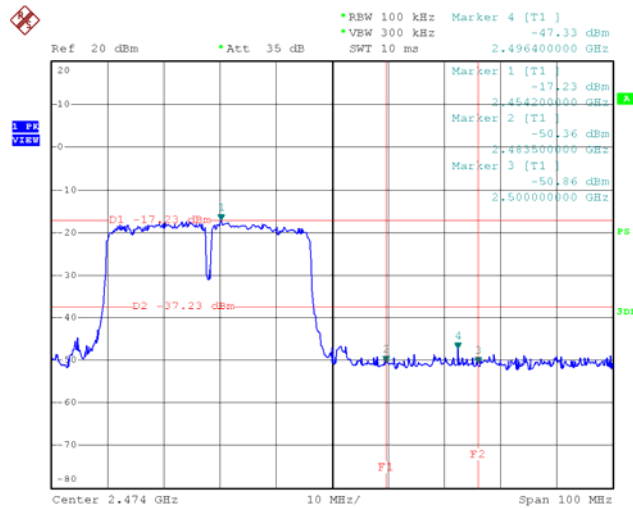

Date: 2.MAY.2014 06:32:43

6. Bandwidth Test

6.1 Test Standard and Limit

- 8.1.1 Test Standard
FCC Part 15.247 (a)(2)
- 8.1.2 Test Limit

FCC Part 15 Subpart C(15.247)/RSS-210		
Test Item	Limit	Frequency Range(MHz)
Bandwidth	≥ 500 KHz (6dB bandwidth)	2400~2483.5

6.2 Test Setup

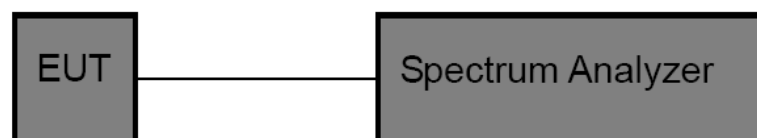

6.3 Test Procedure

- (1) The EUT was directly connected to the spectrum analyzer and antenna output port as show in the block diagram above.
- (2) The bandwidth is measured at an amplitude level reduced 6dB from the reference level. The reference level is the level of the highest amplitude signal observed from the transmitter at the fundamental frequency. Once the reference level is established, the equipment is conditioned with typical modulating signal to produce the worst –case (i.e the widest) bandwidth.
- (3) Measure the channel separation the spectrum analyzer was set to Resolution Bandwidth:100 kHz, and Video Bandwidth:300 kHz, Detector: Peak, Sweep Time set auto.

6.4 EUT Operating Condition

The EUT was set to continuously transmitting in each mode and low, middle and high channel for the test.

6.5 Test Equipment

Equipment	Manufacturer	Model No.	Serial No.	Last Cal.	Cal. Due Date
Spectrum Analyzer	Rohde & Schwarz	FSP30	DE25181	Aug. 10, 2013	Aug.09, 2014

6.6 Test Data

802.11b			
Channel frequency (MHz)	6dB Bandwidth (MHz)	99% Bandwidth (MHz)	Limit
2412	10.08	14.96	>=500 kHz
2437	10.08	15.00	>=500 kHz
2462	10.08	14.96	>=500 kHz

2412 MHz

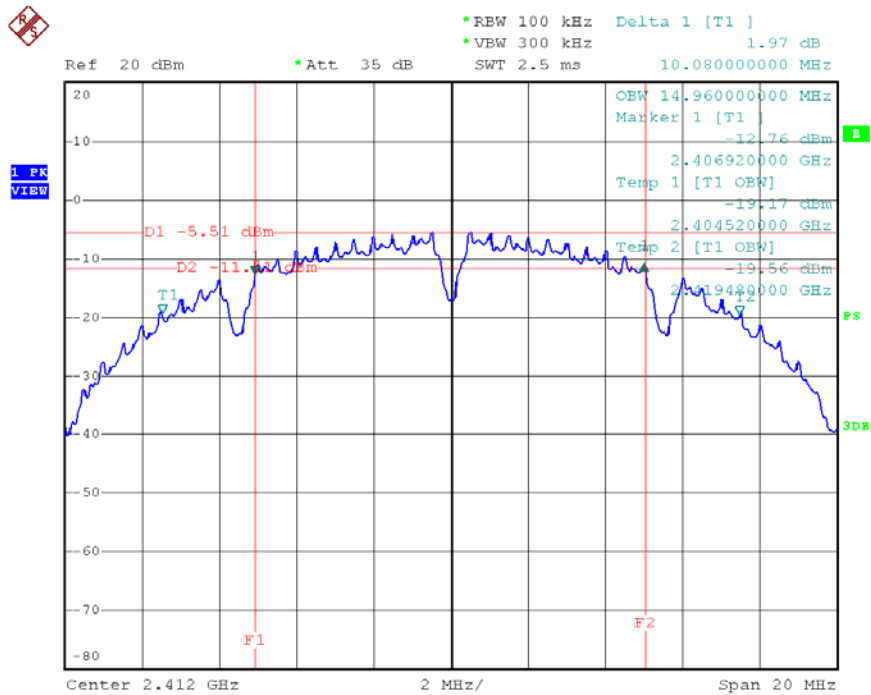

Date: 2.MAY.2014 06:59:45

2437 MHz

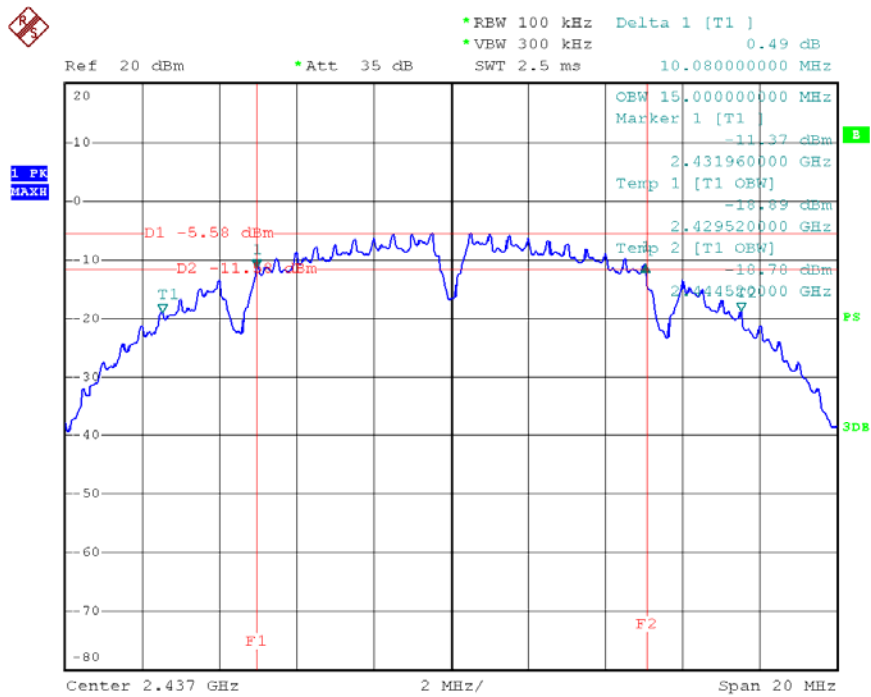

Date: 2.MAY.2014 07:03:47

2462 MHz

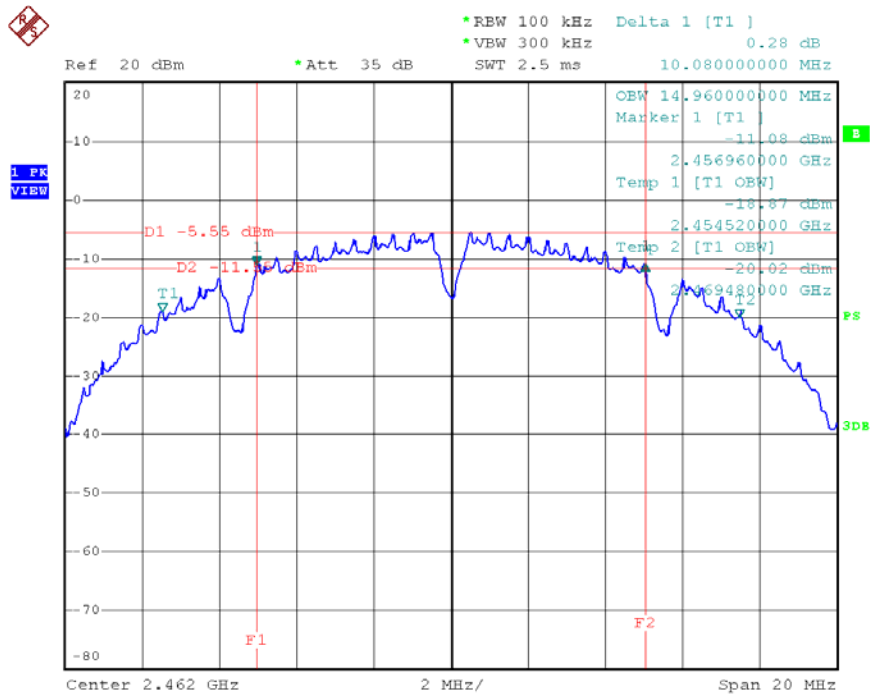

Date: 2.MAY.2014 07:05:10

802.11g			
Channel frequency (MHz)	6dB Bandwidth (MHz)	99% Bandwidth (MHz)	Limit
2412	16.60	16.52	>=500 kHz
2437	16.56	16.48	>=500 kHz
2462	16.60	16.52	>=500 kHz

2412 MHz

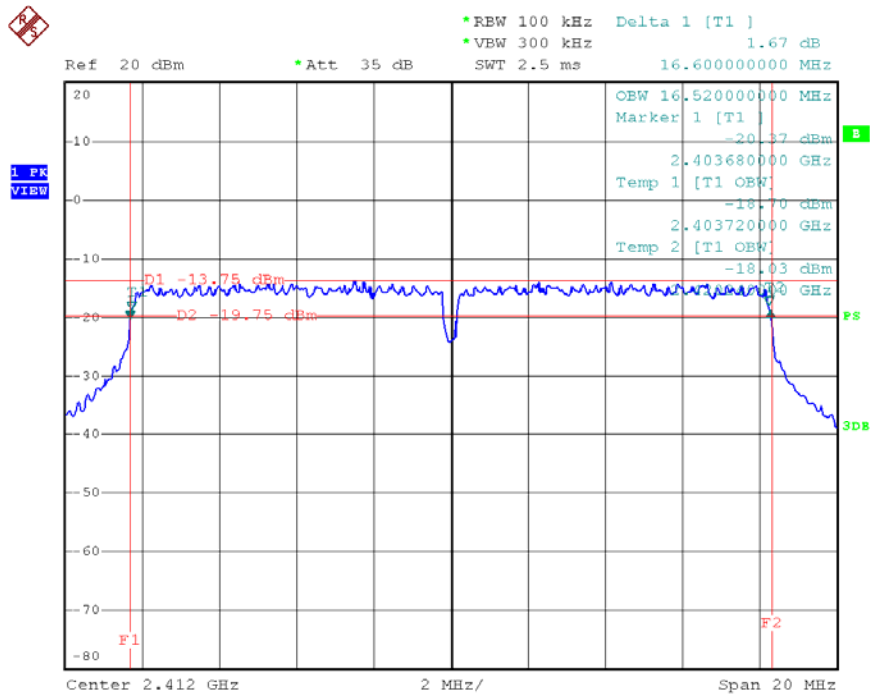

Date: 2.MAY.2014 06:52:43

2437 MHz

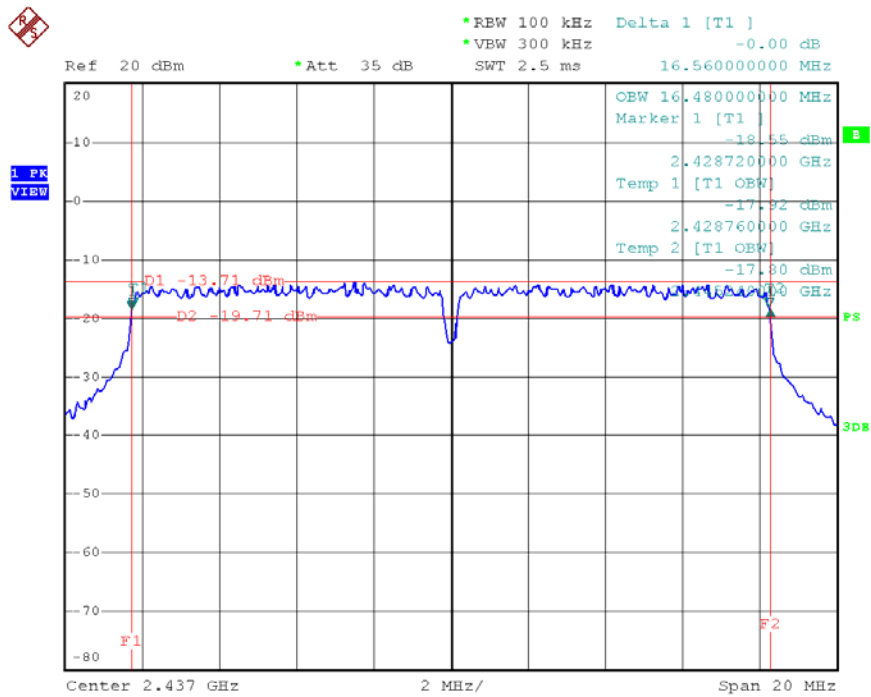

Date: 2.MAY.2014 06:51:05

2462 MHz

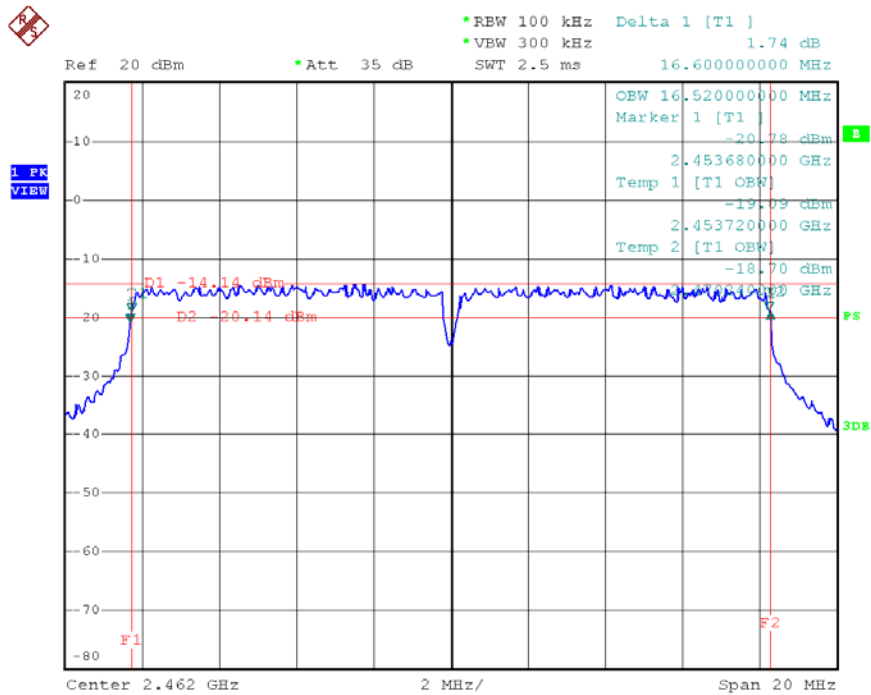

Date: 2.MAY.2014 06:46:27

802.11n(HT20)			
Channel frequency (MHz)	6dB Bandwidth (MHz)	99% Bandwidth (MHz)	Limit
2412	17.84	17.72	>=500 kHz
2437	17.84	17.68	>=500 kHz
2462	17.84	17.72	>=500 kHz

2412 MHz

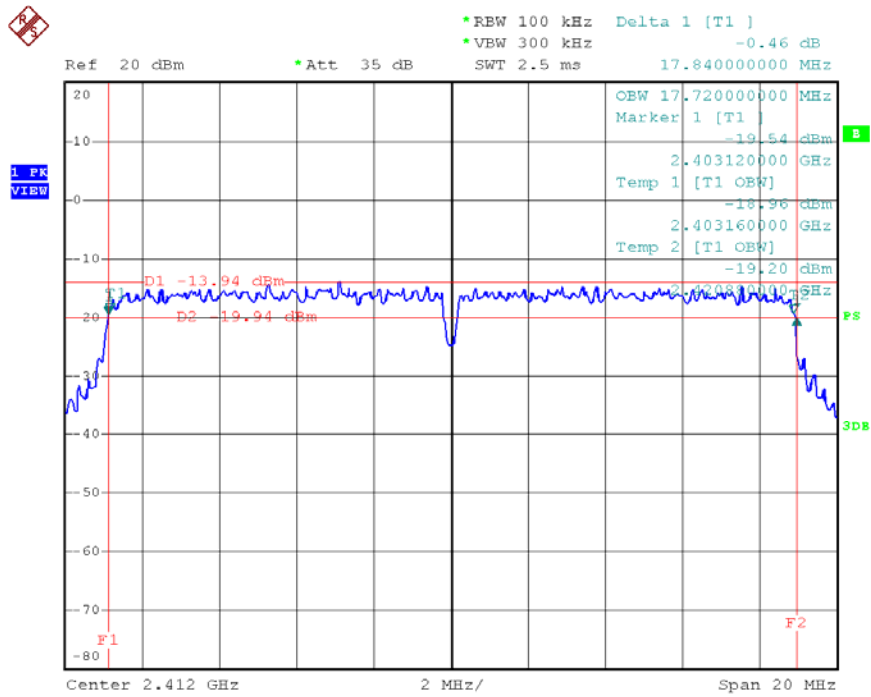

Date: 2.MAY.2014 06:40:30

2437 MHz

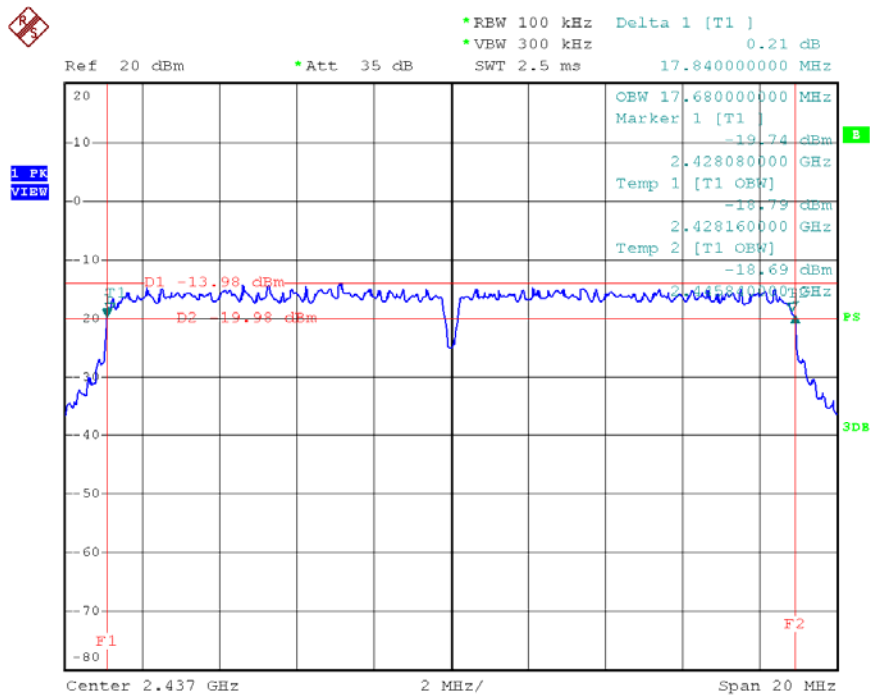

Date: 2.MAY.2014 06:38:34

2462 MHz

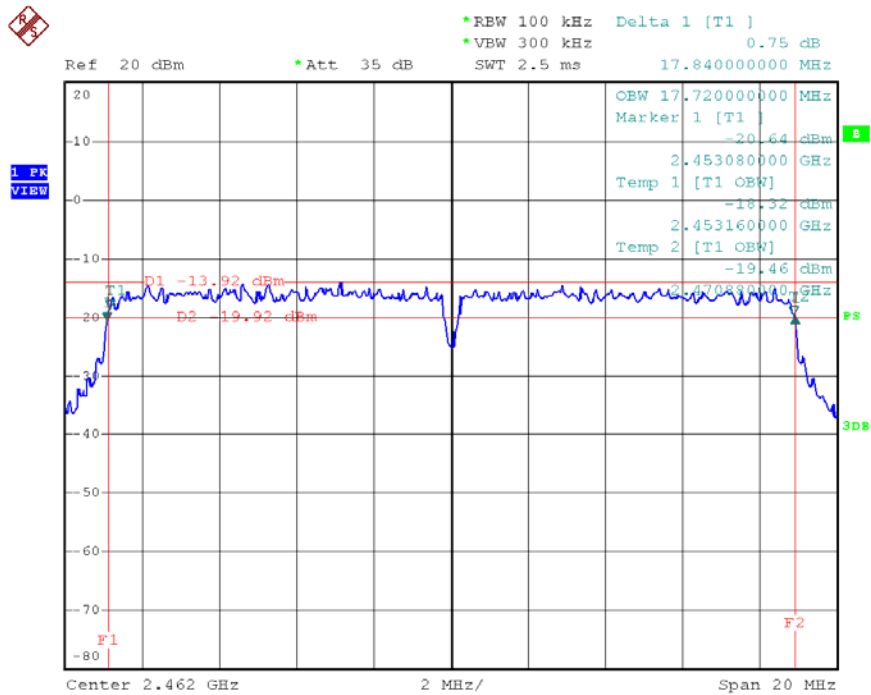

Date: 2.MAY.2014 06:44:52

802.11n(HT40)			
Channel frequency (MHz)	6dB Bandwidth (MHz)	99% Bandwidth (MHz)	Limit
2422	36.32	35.92	>=500 kHz
2437	36.32	36.00	>=500 kHz
2452	36.32	36.00	>=500 kHz

2422 MHz

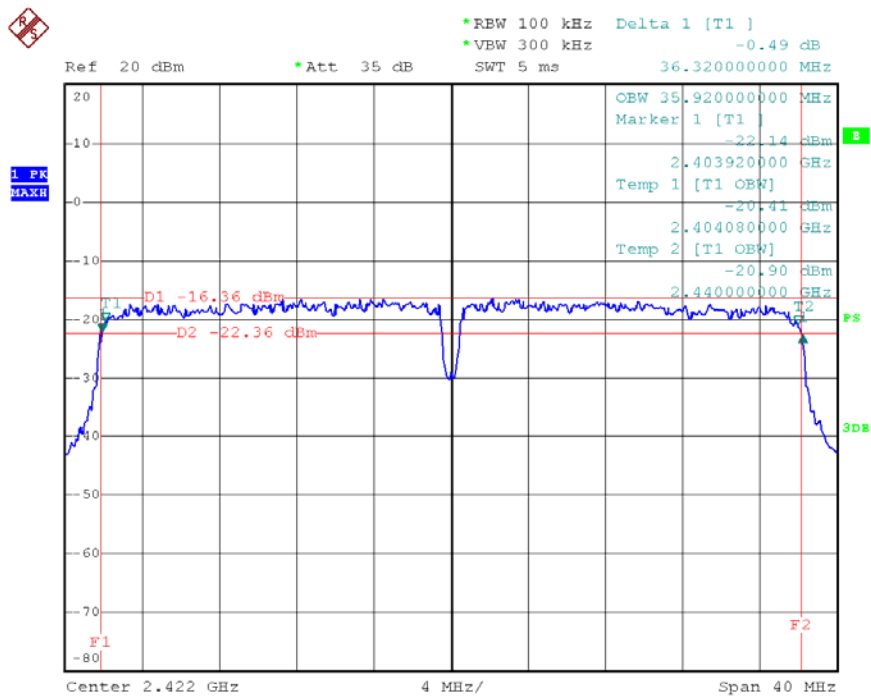

Date: 2.MAY.2014 06:28:07

2437 MHz

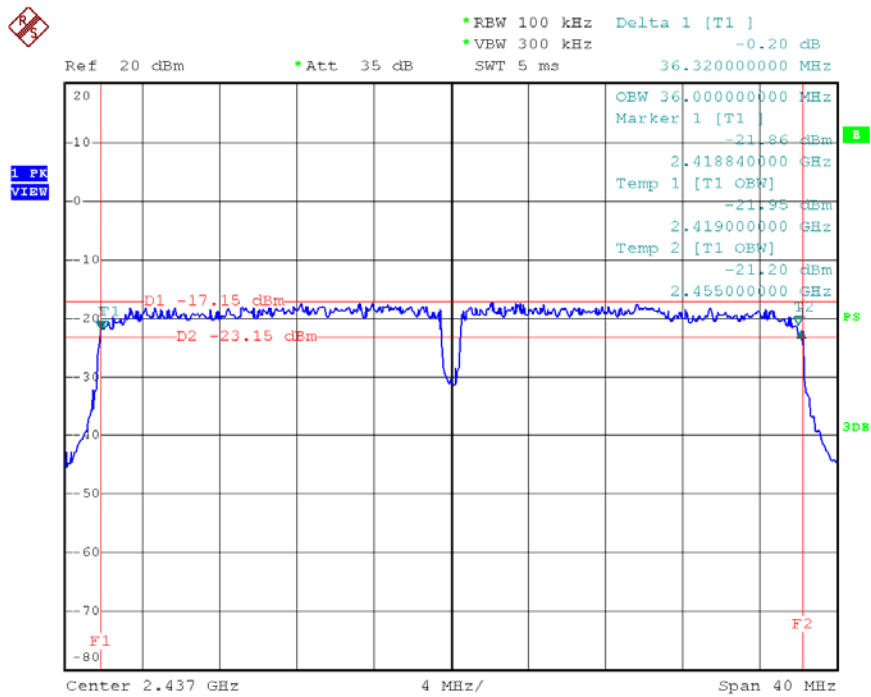

Date: 2.MAY.2014 06:36:39

2452 MHz

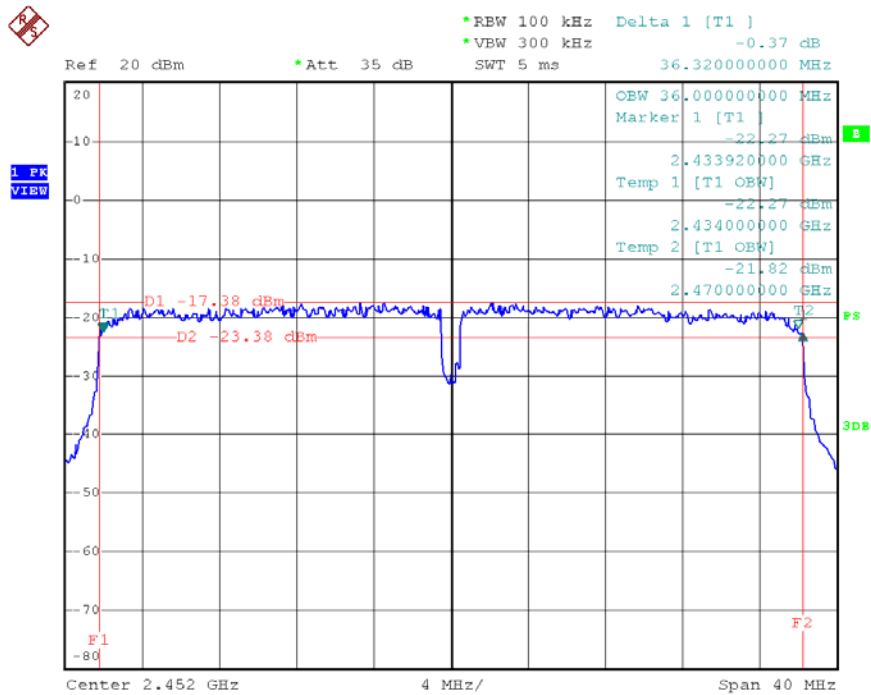

Date: 2.MAY.2014 06:34:56

7. Peak Output Power Test

7.1 Test Standard and Limit

9.1.1 Test Standard

FCC Part 15.247 (b)

9.1.2 Test Limit

FCC Part 15 Subpart C(15.247)/RSS-210		
Test Item	Limit	Frequency Range(MHz)
Peak Output Power	1 Watt or 30 dBm	2400~2483.5

7.2 Test Setup

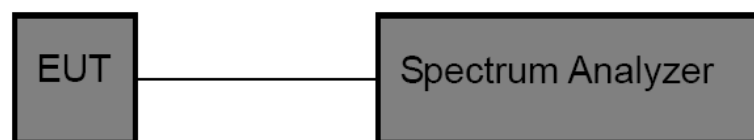

7.3 Test Procedure

The EUT was directly connected to the Spectrum Analyzer and antenna output port as show in the block diagram above.

7.4 EUT Operating Condition

The EUT was set to continuously transmitting in the max power during the test.

7.5 Test Equipment

Equipment	Manufacturer	Model No.	Serial No.	Last Cal.	Cal. Due Date
Spectrum Analyzer	Rohde & Schwarz	FSP30	DE25181	Aug. 10, 2013	Aug.09, 2014

7.6 Test Data

801.11b Mode			
Test Channel	Frequency (MHz)	Peak Output Power (dBm)	Limit (dBm)
CH 01	2412	9.38	30
CH 06	2437	9.40	30
CH 11	2462	9.25	30

2412 MHz

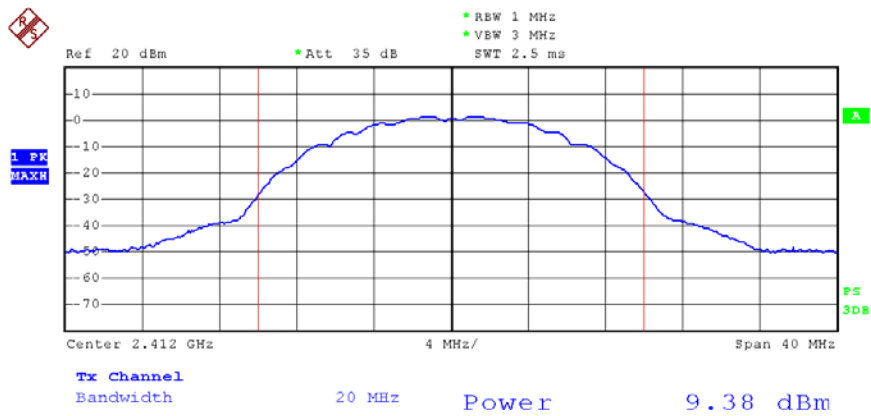

Date: 2.MAY.2014 07:15:40

2437 MHz

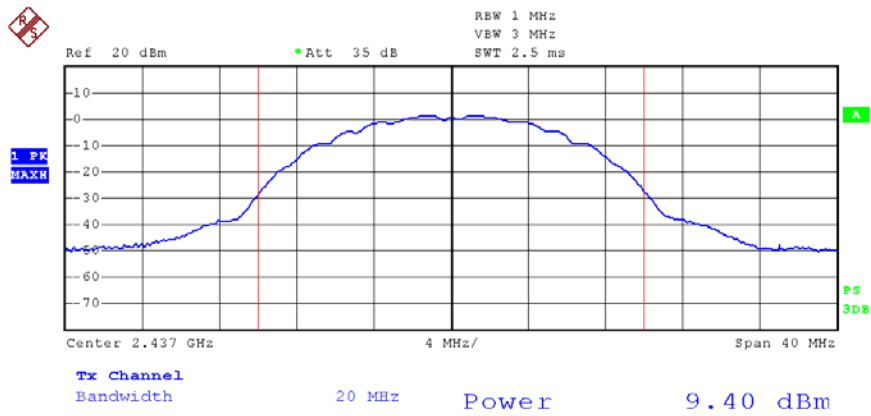

Date: 1.MAY.2014 14:45:39

2462 MHz

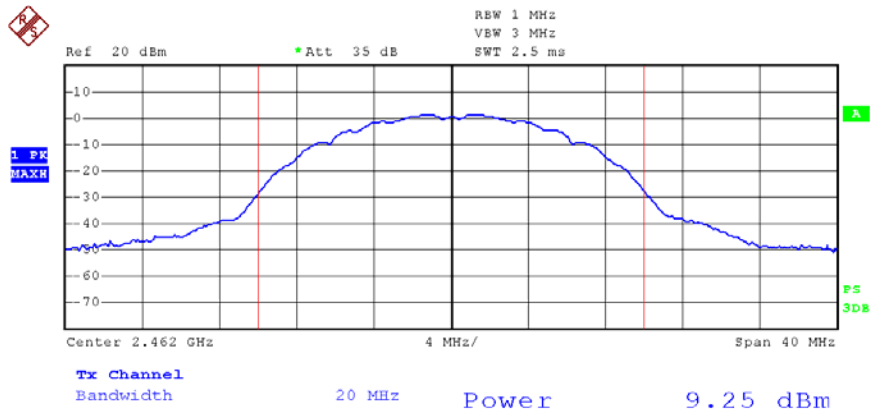

Date: 1.MAY.2014 14:47:09

801.11g Mode			
Test Channel	Frequency (MHz)	Peak Output Power (dBm)	Limit (dBm)
CH 01	2412	9.06	30
CH 06	2437	9.51	30
CH 11	2462	9.47	30

2412 MHz

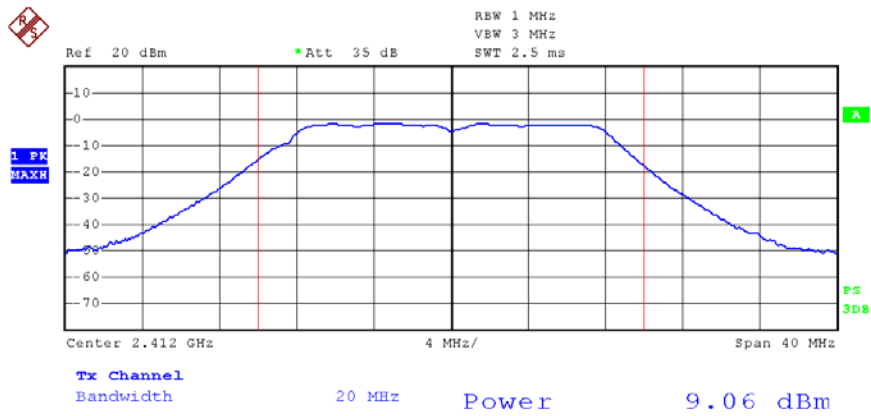

Date: 1.MAY.2014 14:53:56

2437 MHz

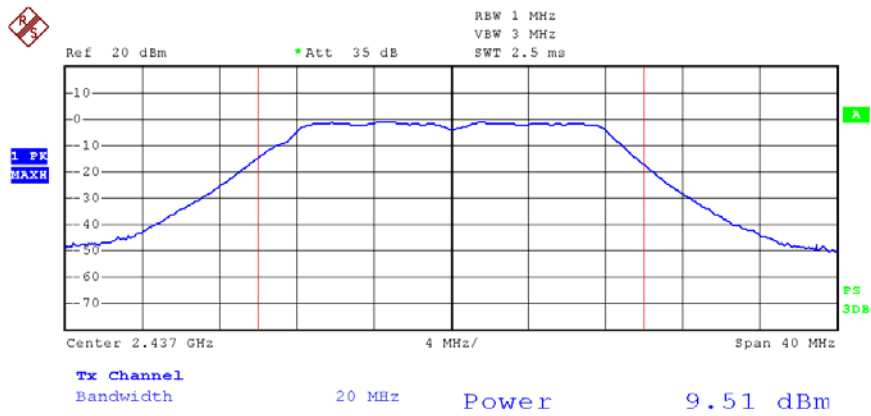

Date: 1.MAY.2014 14:52:32

2462 MHz

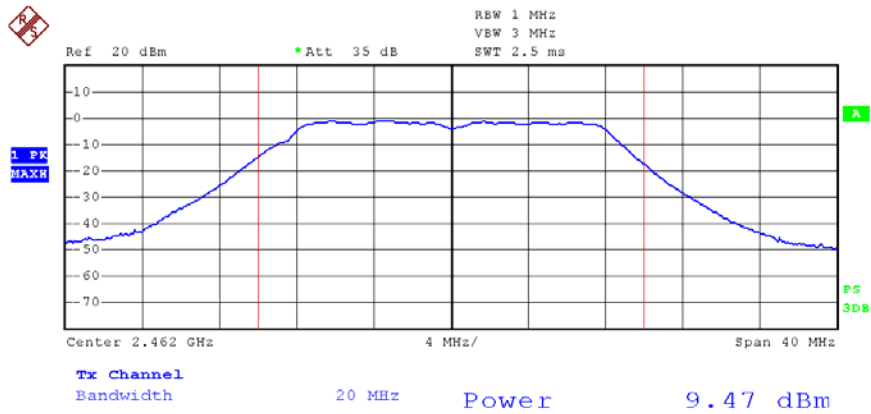

Date: 1.MAY.2014 14:50:55

801.11n(HT20) Mode			
Test Channel	Frequency (MHz)	Peak Output Power (dBm)	Limit (dBm)
CH 01	2412	9.46	30
CH 06	2437	9.27	30
CH 11	2462	9.41	30

2412 MHz

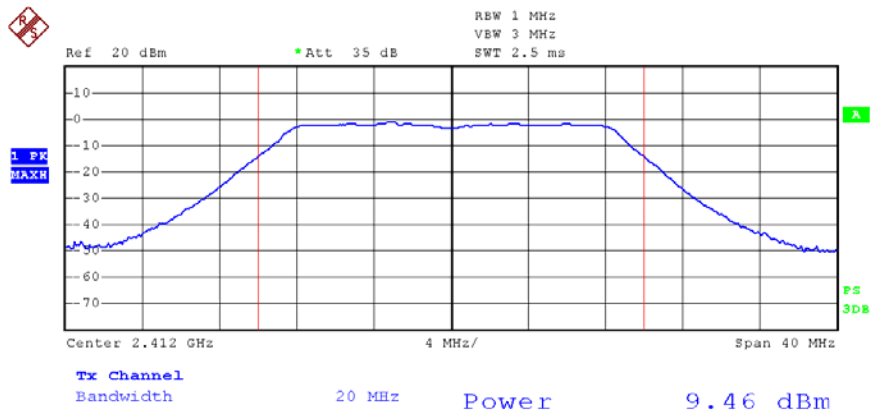

Date: 1.MAY.2014 14:55:26

2437 MHz

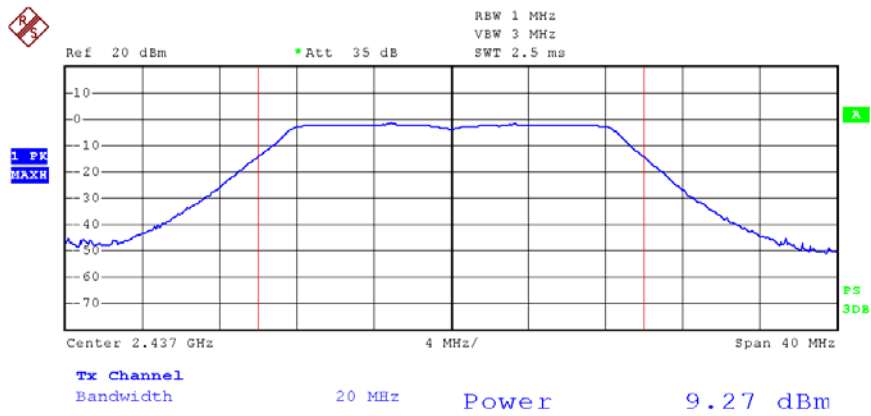

Date: 1.MAY.2014 14:57:27

2462 MHz

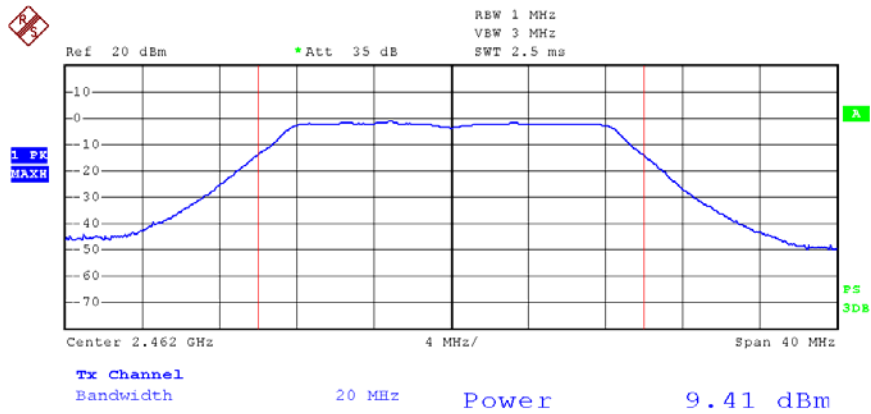

Date: 1.MAY.2014 14:59:11

801.11n(HT40) Mode			
Test Channel	Frequency (MHz)	Peak Output Power (dBm)	Limit (dBm)
CH 03	2422	9.46	30
CH 06	2437	9.40	30
CH 09	2452	9.16	30

2422 MHz

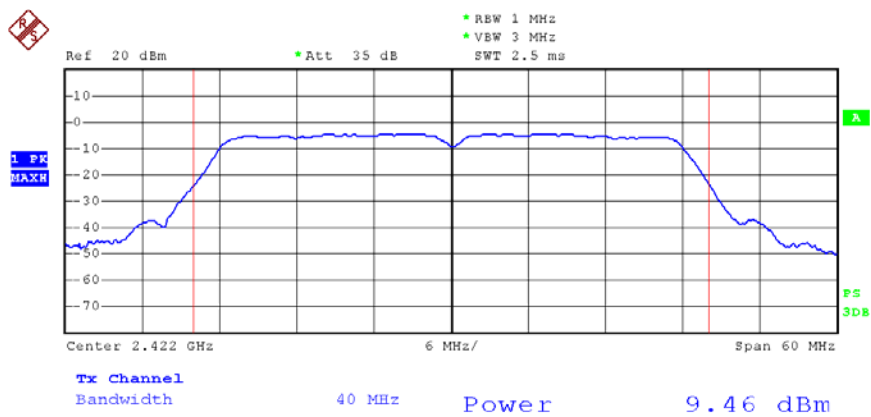

Date: 2.MAY.2014 06:18:42

2437 MHz

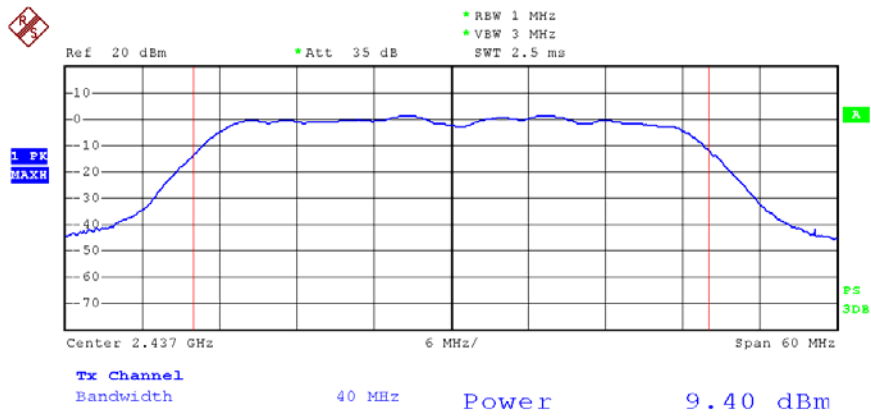

Date: 2.MAY.2014 06:08:07

2452 MHz

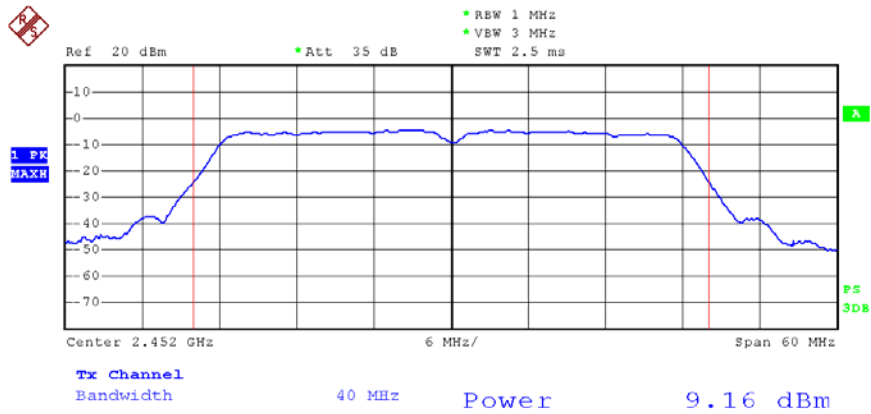

Date: 2.MAY.2014 06:10:48

8. Power Spectral Density Test

8.1 Test Standard and Limit

8.1.1 Test Standard

FCC Part 15.247 (e)

8.1.2 Test Limit

FCC Part 15 Subpart C(15.247)		
Test Item	Limit	Frequency Range(MHz)
Power Spectral Density	8dBm(in any 3 kHz)	2400~2483.5

8.2 Test Setup

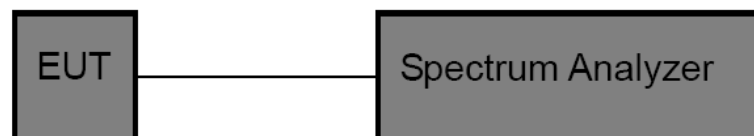

8.3 Test Procedure

- (1) The EUT was directly connected to the spectrum analyzer and antenna output port as show in the block diagram above.
- (2) Measure the spectral power density the spectrum analyzer was set to Resolution Bandwidth=100 kHz, and Video Bandwidth \geq 300 kHz, Detector: Peak, Span to 5%~30% greater than EBW, Sweep time auto.
- (3) Scale the observed power level to an equivalent value in 3 kHz by adjusting (reducing) the measured power by a BWCF=-15.2 dB.

8.4 EUT Operating Condition

The EUT was set to continuously transmitting in each mode and low, middle and high channel for the test.

8.5 Test Equipment

Equipment	Manufacturer	Model No.	Serial No.	Last Cal.	Cal. Due Date
Spectrum Analyzer	Rohde & Schwarz	FSP30	DE25181	Aug. 10, 2013	Aug.09, 2014

8.6 Test Data

802.11b Mode			
Test Channel	Frequency (MHz)	Power Density (3 kHz/dBm)	Limit (dBm)
CH 01	2412	-24.69	8
CH 06	2437	-24.88	8
CH 11	2462	-24.86	8

2412 MHz

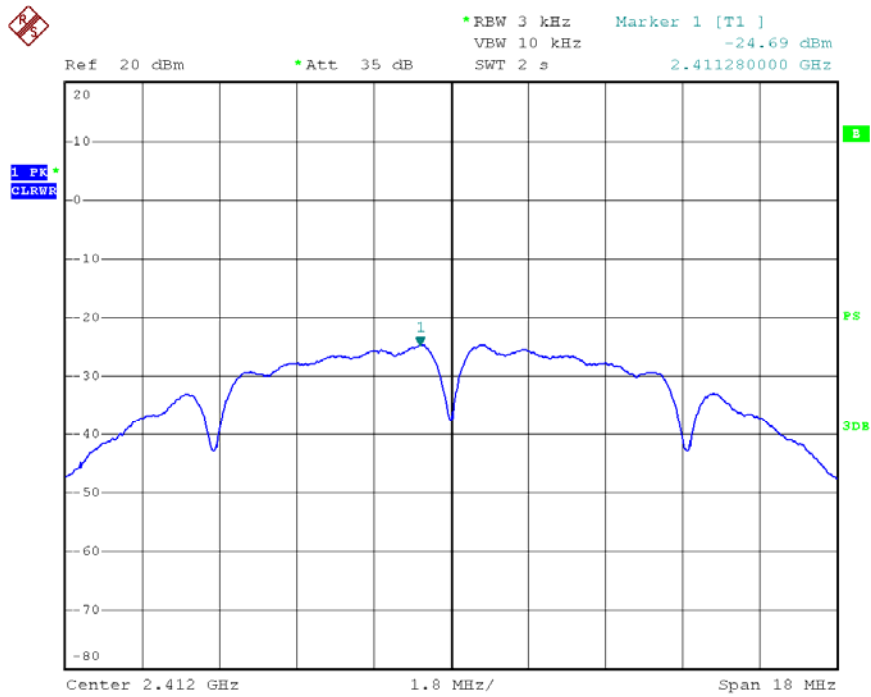

Date: 1.MAY.2014 14:44:38

2437 MHz

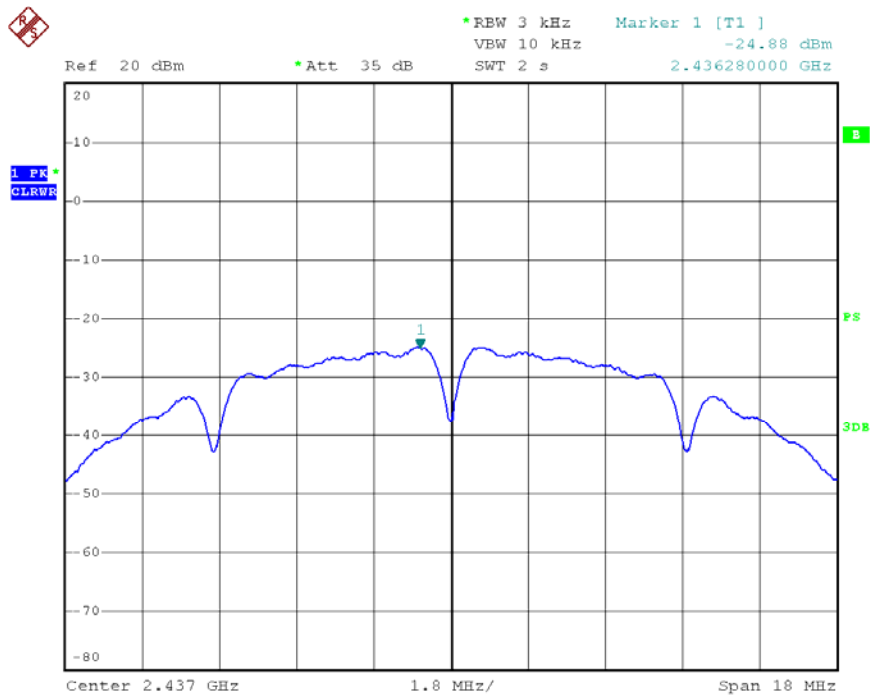

Date: 1.MAY.2014 14:46:10

2462 MHz

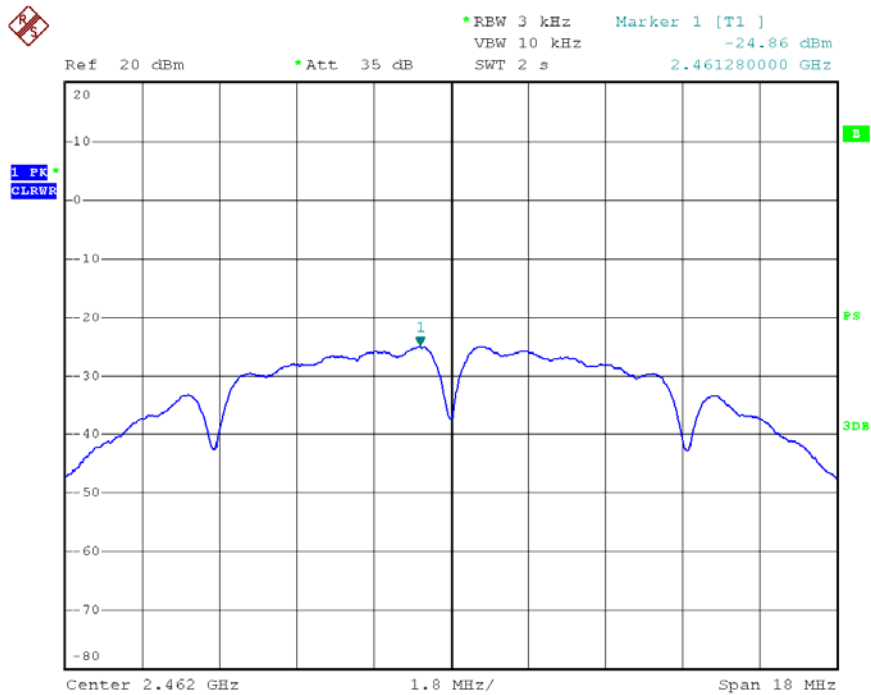

Date: 1.MAY.2014 14:47:33

802.11g Mode			
Test Channel	Frequency (MHz)	Power Density (3 kHz/dBm)	Limit (dBm)
CH 01	2412	-28.05	8
CH 06	2437	-28.87	8
CH 11	2462	-27.95	8

2412 MHz

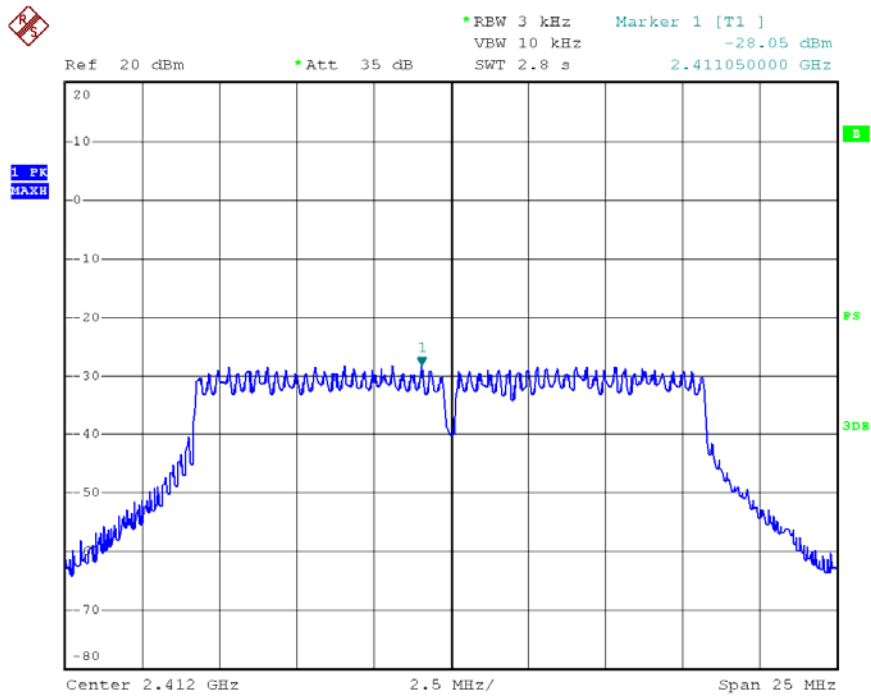

Date: 1.MAY.2014 14:54:27

2437 MHz

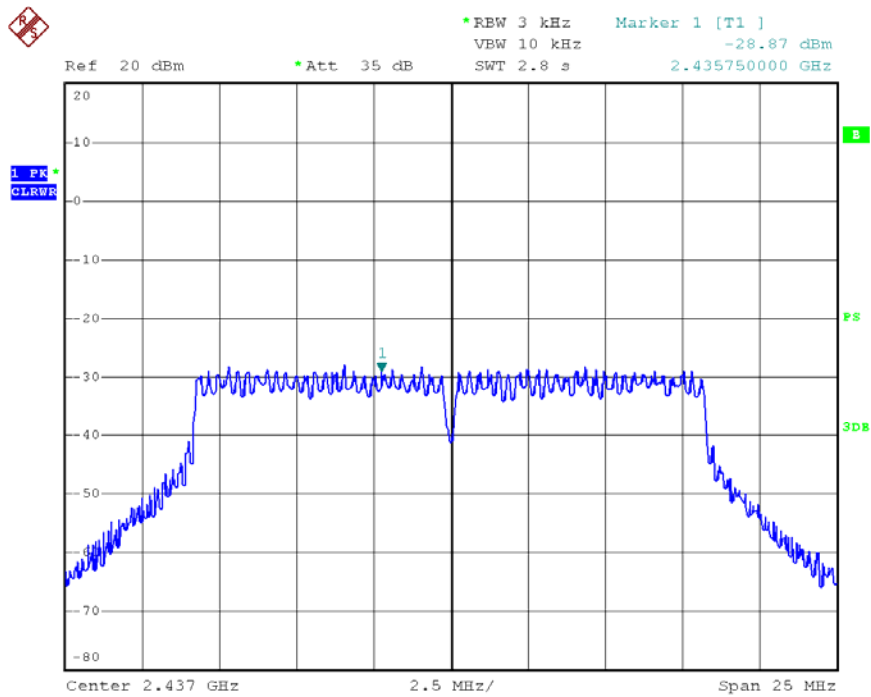

Date: 1.MAY.2014 14:53:05

2462 MHz

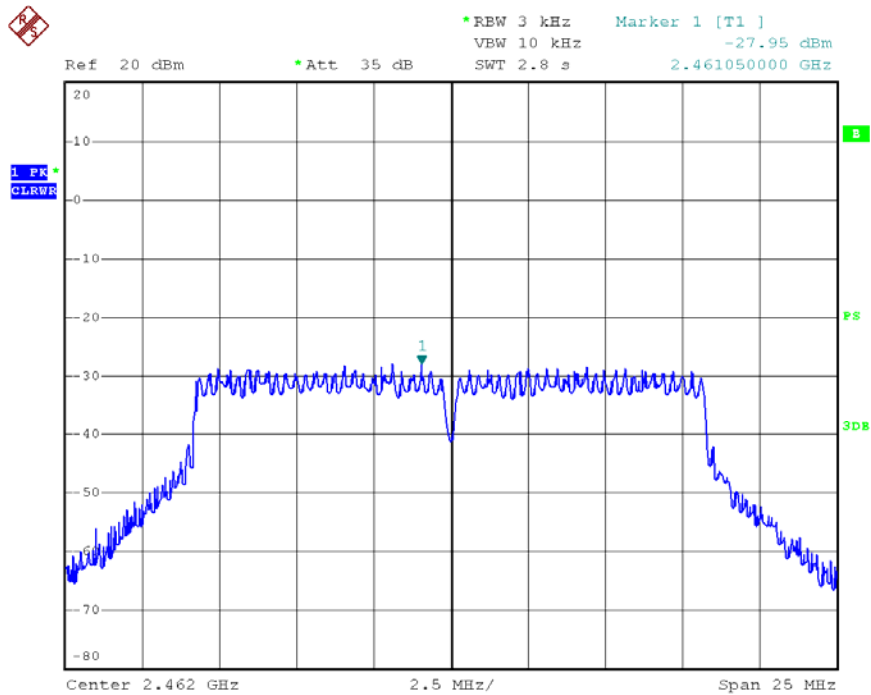

Date: 1.MAY.2014 14:51:44

802.11n(HT20) Mode			
Test Channel	Frequency (MHz)	Power Density (3 kHz/dBm)	Limit (dBm)
CH 01	2412	-27.20	8
CH 06	2437	-28.27	8
CH 11	2462	-27.77	8

2412 MHz

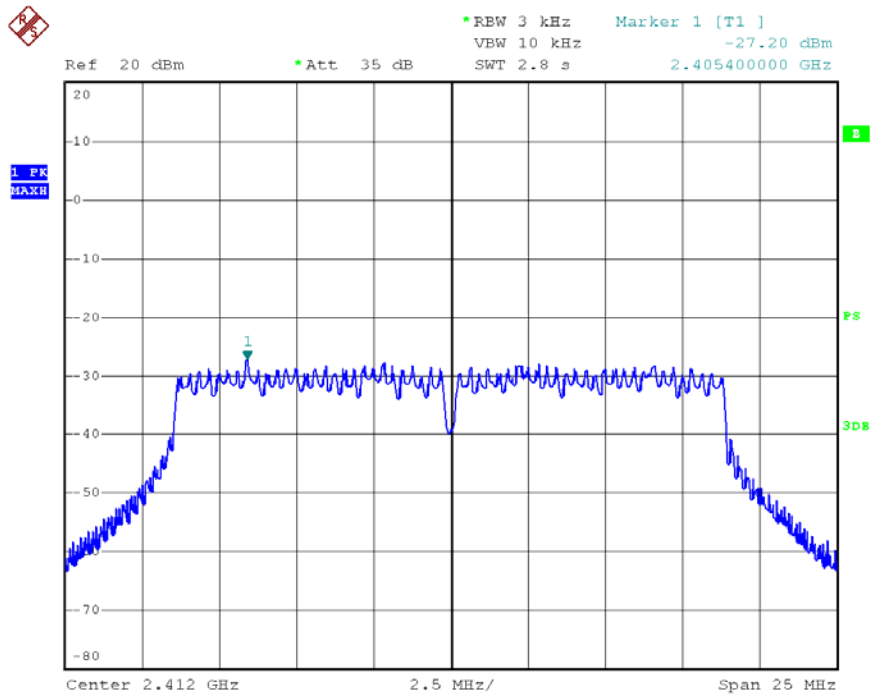

Date: 1.MAY.2014 14:56:20

2437 MHz

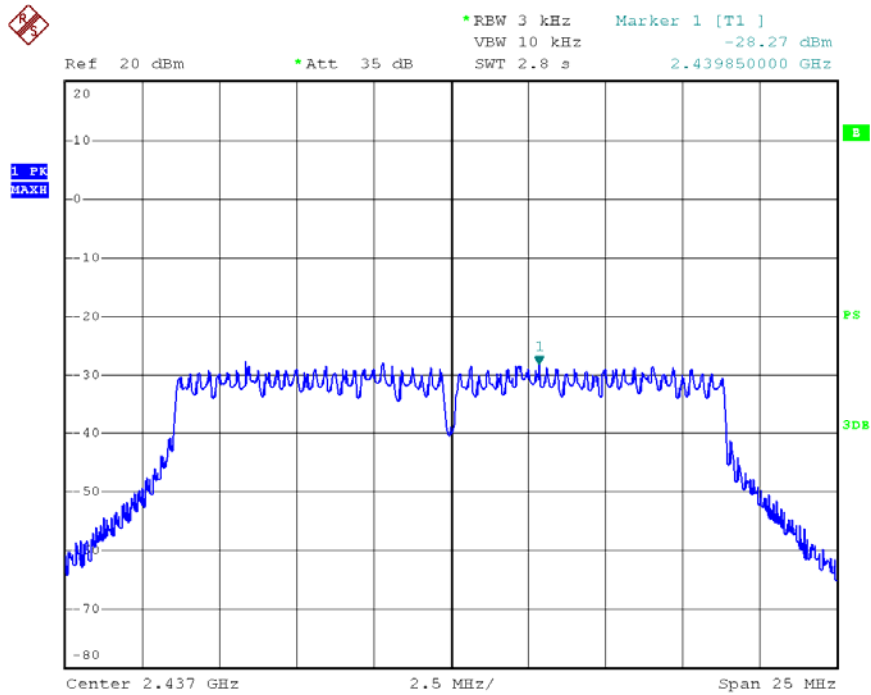

Date: 1.MAY.2014 14:58:00

2462 MHz

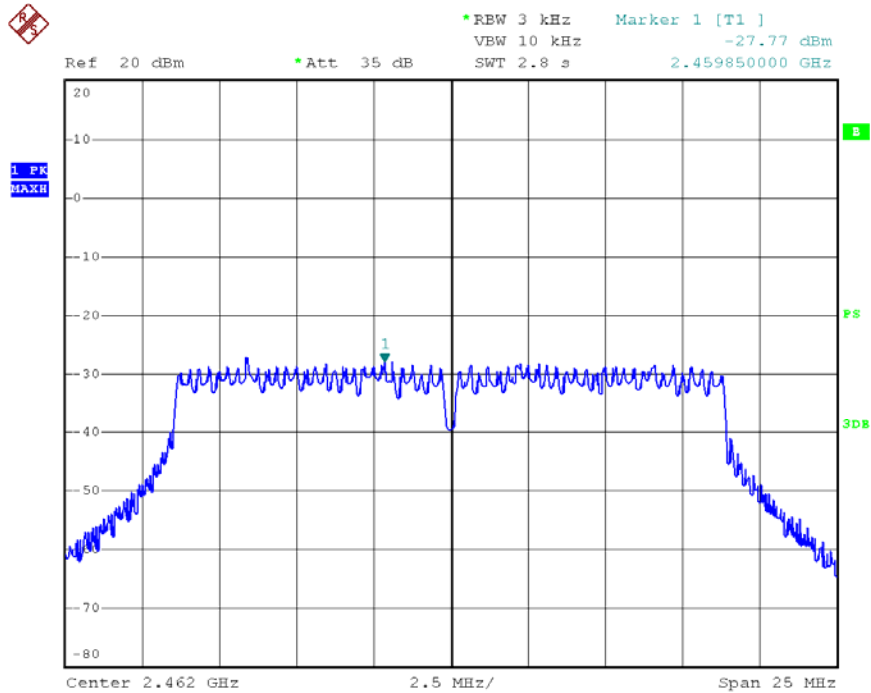

Date: 1.MAY.2014 14:59:55

802.11n(HT40) Mode			
Test Channel	Frequency (MHz)	Power Density (3 kHz/dBm)	Limit (dBm)
CH 03	2422	-27.49	8
CH 06	2437	-29.60	8
CH 09	2452	-29.09	8

2422 MHz

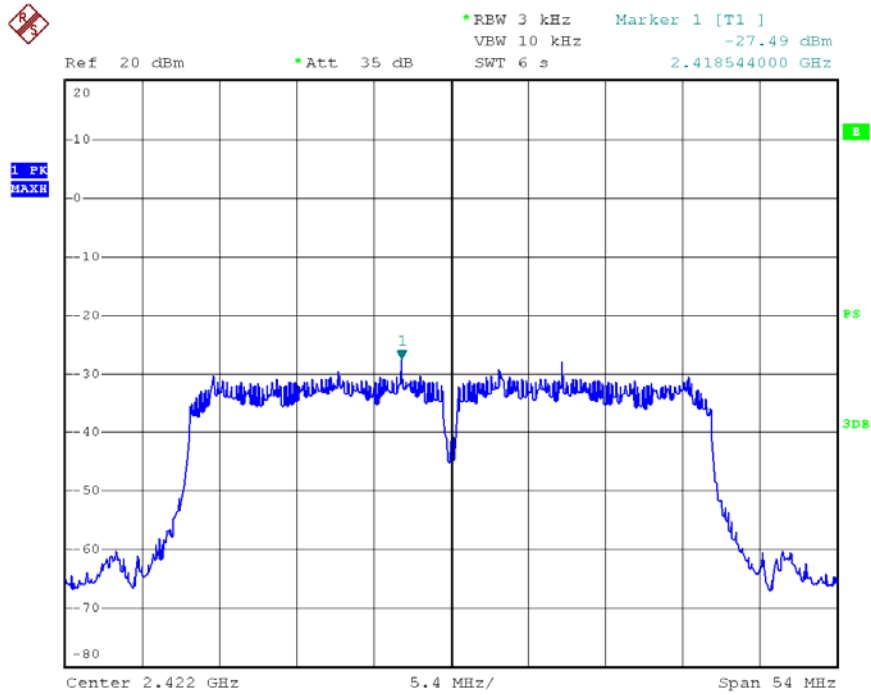

Date: 2.MAY.2014 06:19:50

2437 MHz

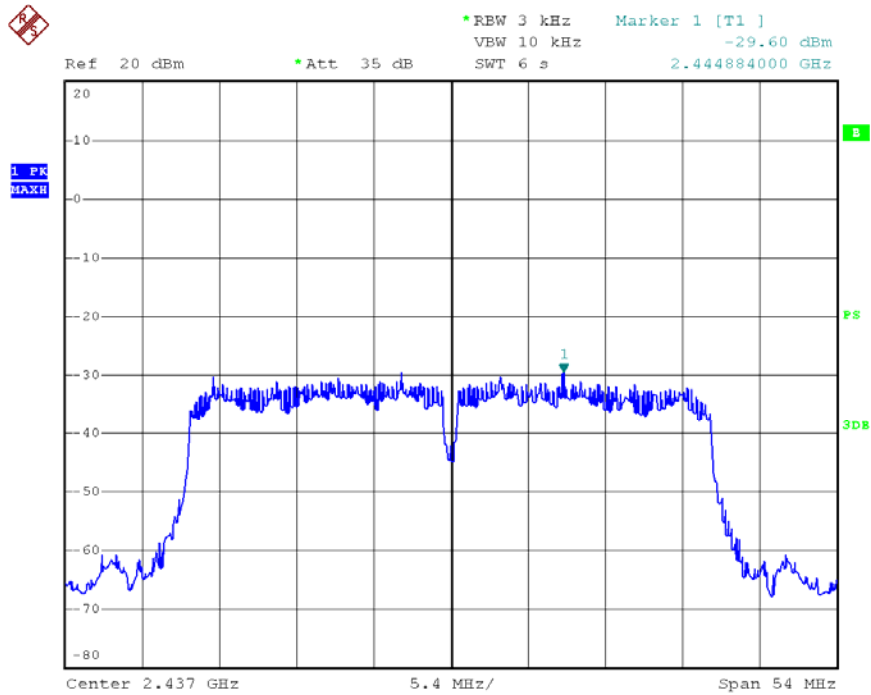

Date: 2.MAY.2014 06:17:31

2452 MHz

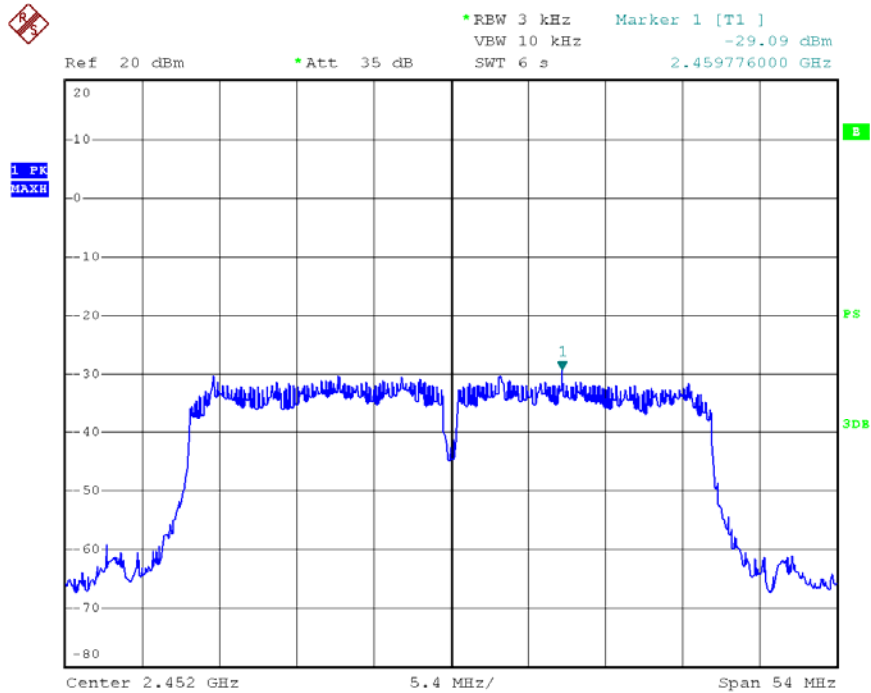

Date: 2.MAY.2014 06:12:32

9. Antenna Conducted Spurious Emission

9.1 Test Standard and Limit

10.1.1 Test Standard

FCC Part 15.247 (d)

10.1.2 Test Limit

In any 100 kHz bandwidth outside the frequency band in which the spread spectrum or digitally modulated intentional radiator is operating, the radio frequency power that is produced by the intentional radiator shall be at least 20 dB below that in the 100 kHz bandwidth within the band that contains the highest level of the desired power. In case the emission fall within the restricted band specified on 15.205(a), then the 15.209(a) limit in the table below has to be followed.

Frequencies (MHz)	Field Strength (microvolt/meter)	Measurement Distance (meters)
0.009~0.490	2400/F(KHz)	300
0.490~1.705	24000/F(KHz)	30
1.705~30.0	30	30
30~88	100	3
88~216	150	3
216~960	200	3
Above~960	500	3

(2)If the peak output power procedure is used to measure the fundamental emission power to demonstrate compliance to 15.247(b)(3) requirements, then the peak conducted output power measured within any 100 kHz outside the authorized frequency band shall be attenuated by at least 20 dB relative to the maximum measured in-band peak PSD level.

9.2 Test Setup

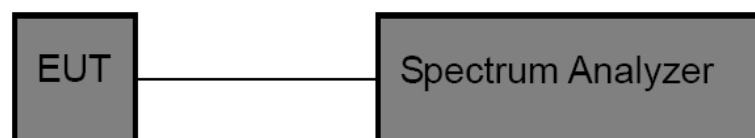

9.3 Test Procedure

(1) The EUT was directly connected to the spectrum analyzer and antenna output port as show in the block diagram above.

(2) Spectrum Setting:

RBW=100 KHz, VBW=300 KHz.

Frequency range: from 30MHz to 26.5 GHz.

9.4 EUT Operating Condition

The EUT was set to continuously transmitting in the max power during the test.

9.5 Test Equipment

Equipment	Manufacturer	Model No.	Serial No.	Last Cal.	Cal. Due Date
Spectrum Analyzer	Agilent	E4407B	MY45106456	Mar. 20, 2014	Mar. 19, 2015

9.6 Test Data

802.11b Mode TX CH 01 2412MHz

Above 1 GHz

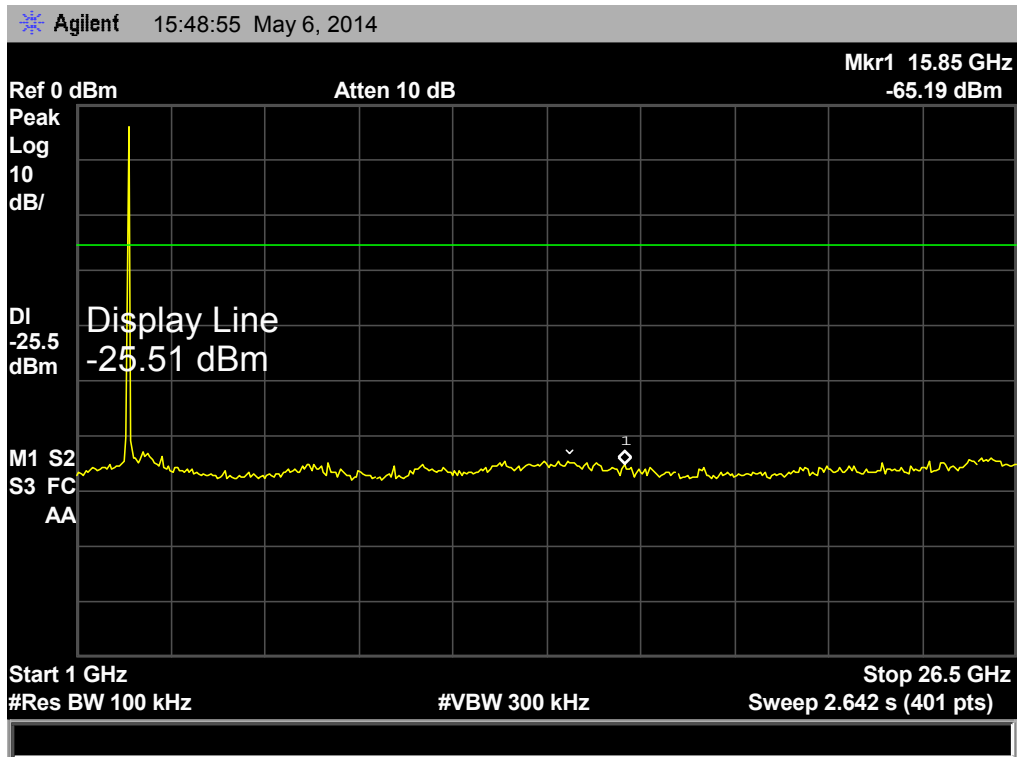

Below 1 GHz

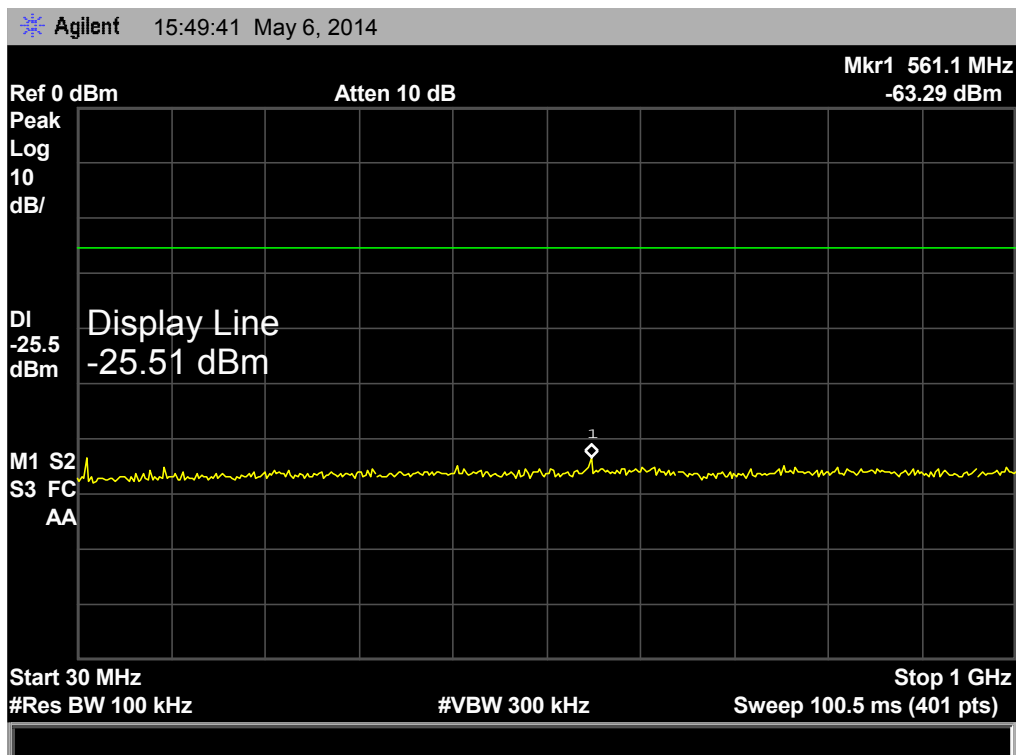

802.11b Mode TX CH 06 2437MHz

Above 1 GHz

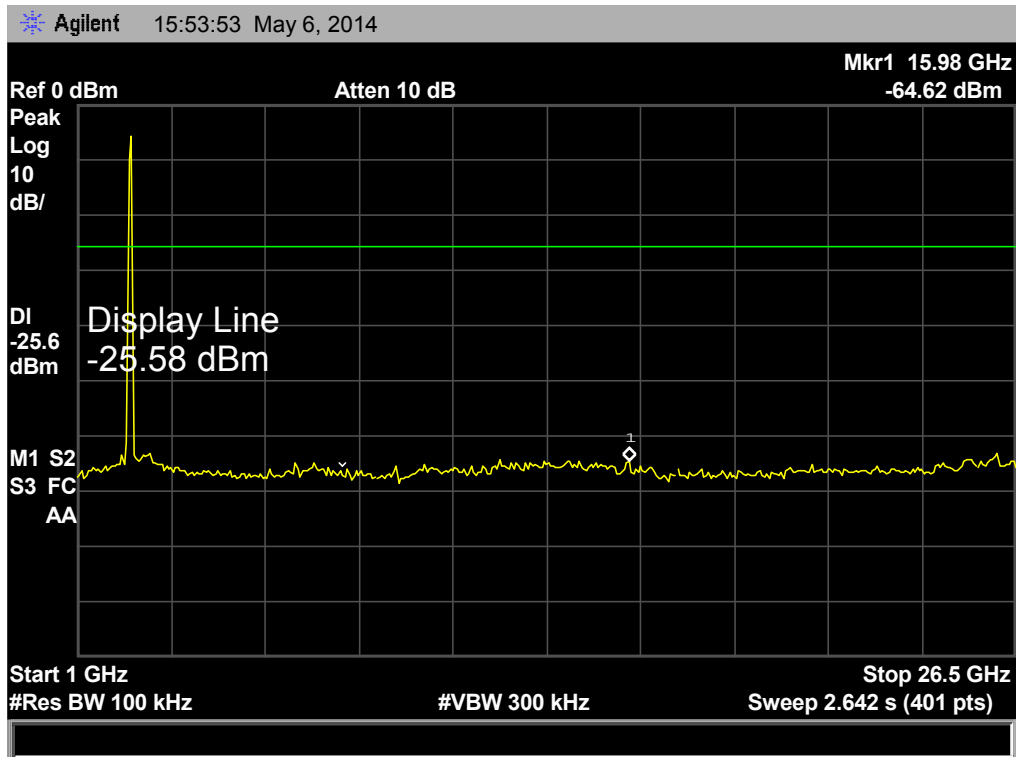

Below 1 GHz

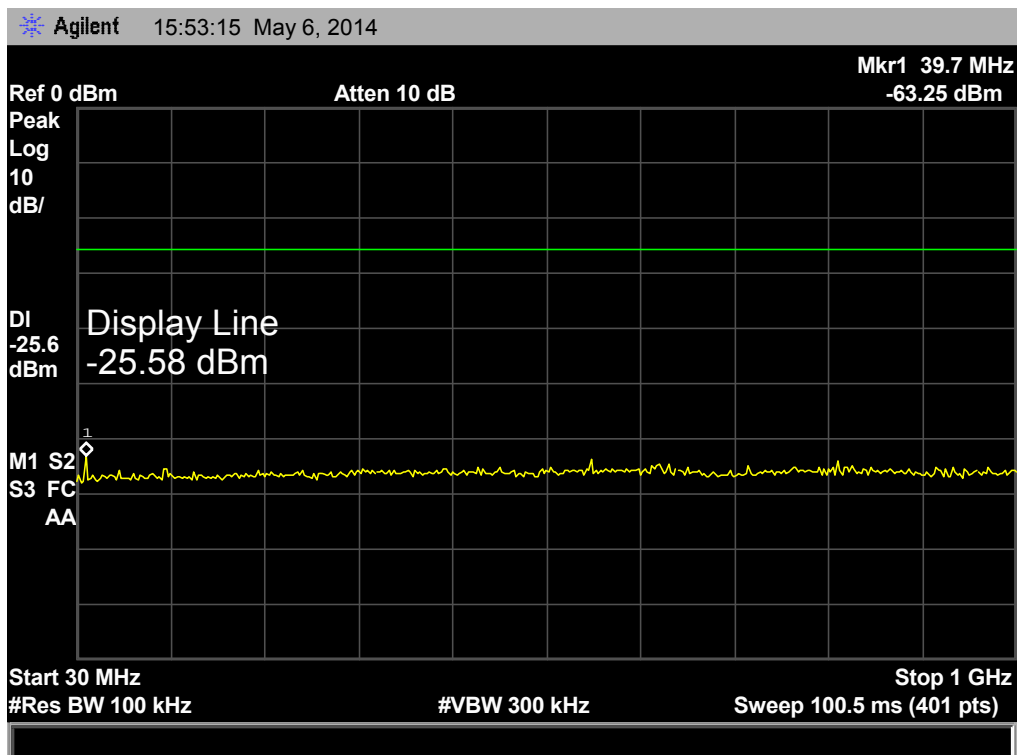

802.11b Mode

TX CH 11 2462MHz

Above 1 GHz

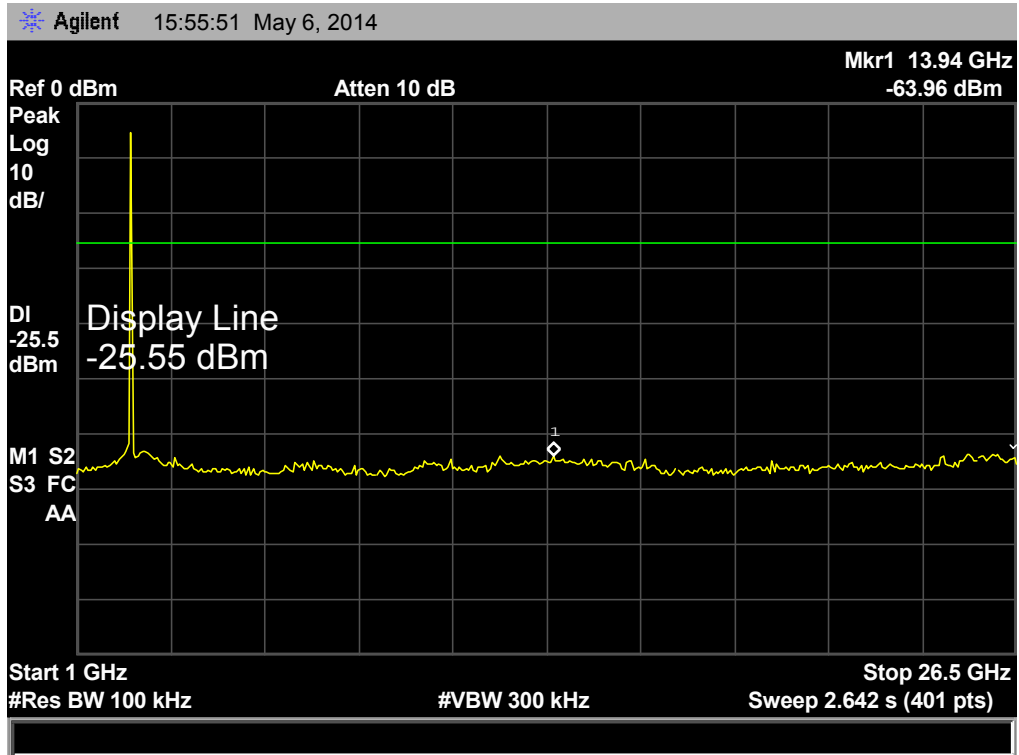

Below 1 GHz

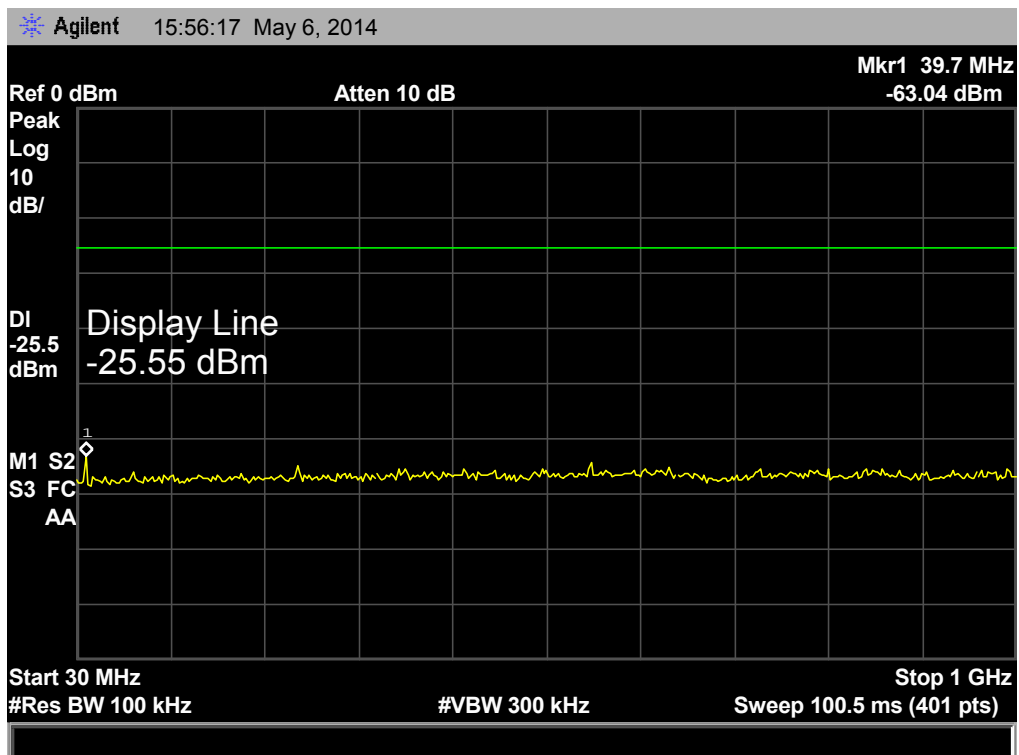

802.11g Mode TX CH 01 2412MHz

Above 1 GHz

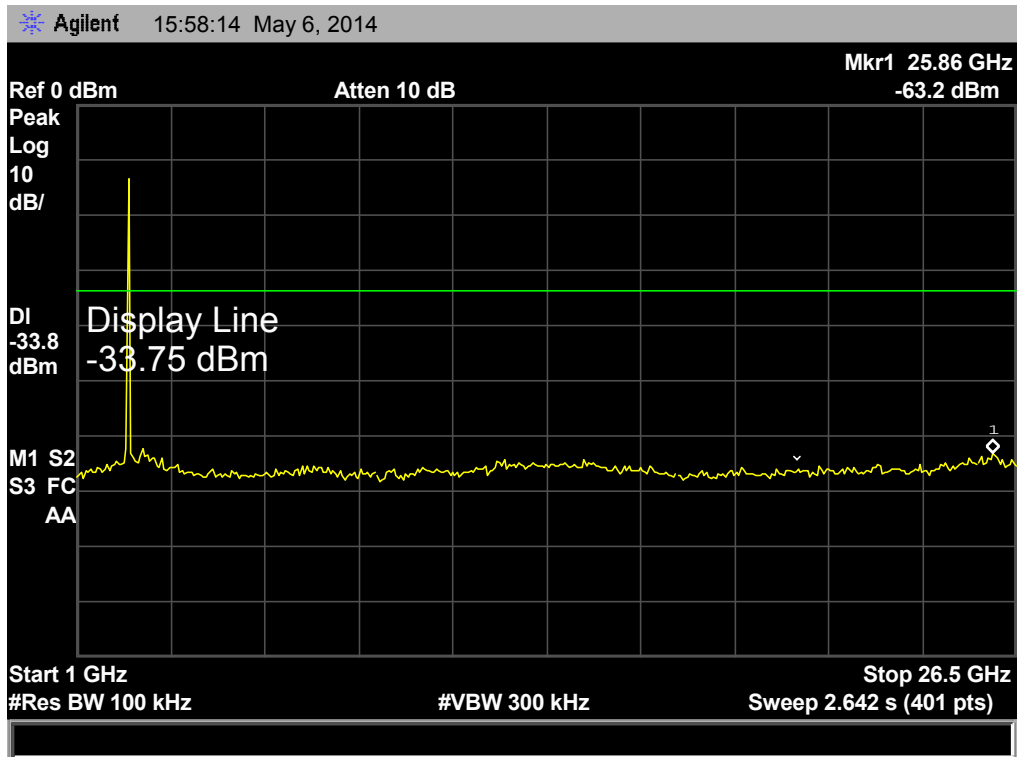

Below 1 GHz

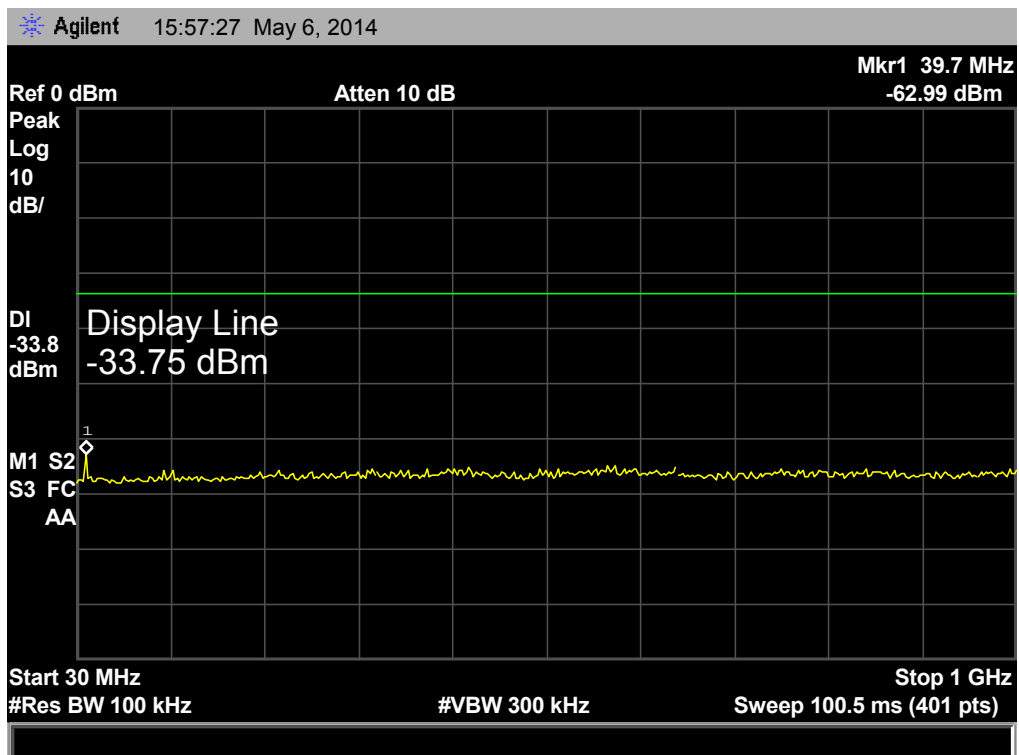

802.11g Mode TX CH 06 2437MHz

Above 1 GHz

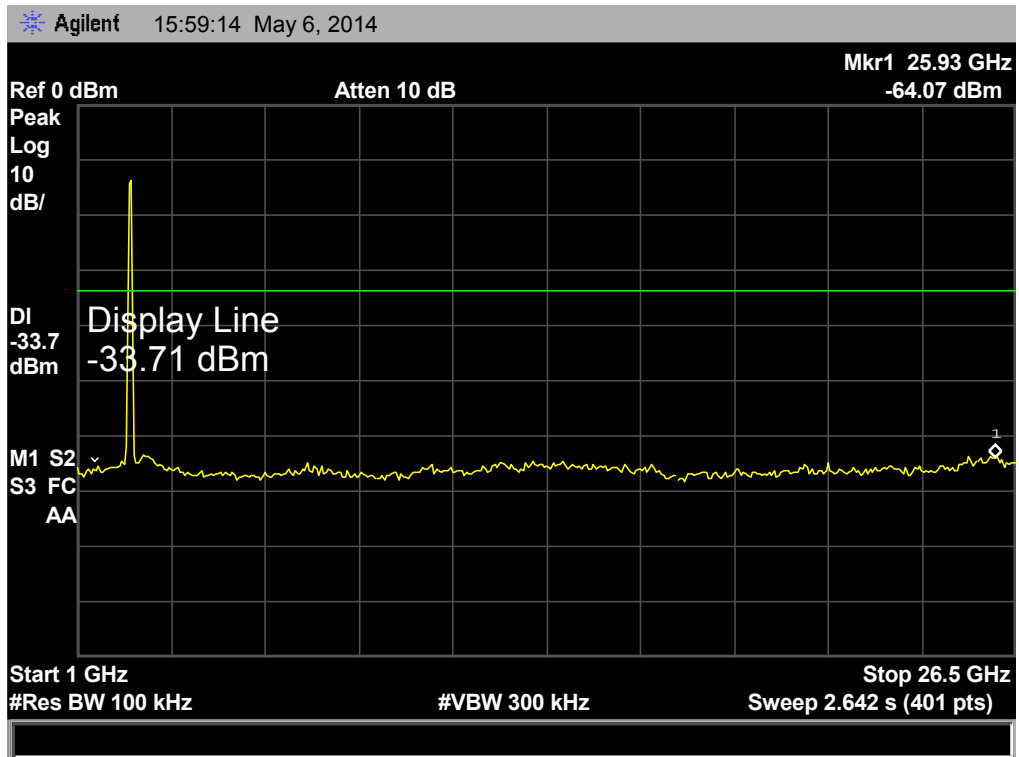

Below 1 GHz

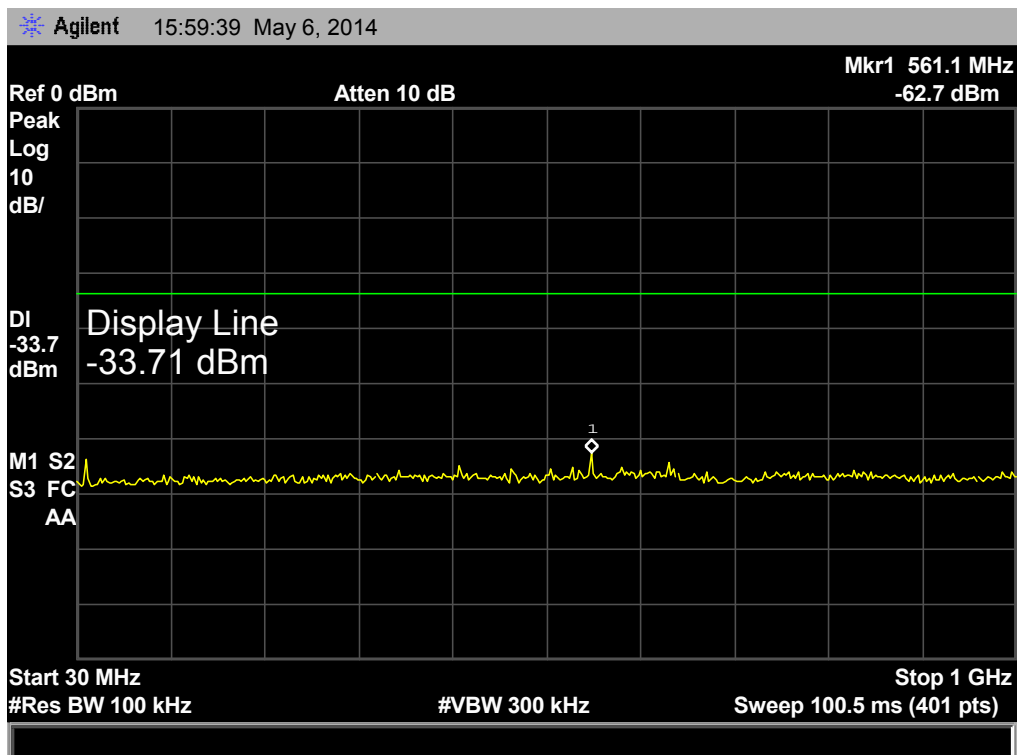

802.11g Mode

TX CH 11 2462MHz

Above 1 GHz

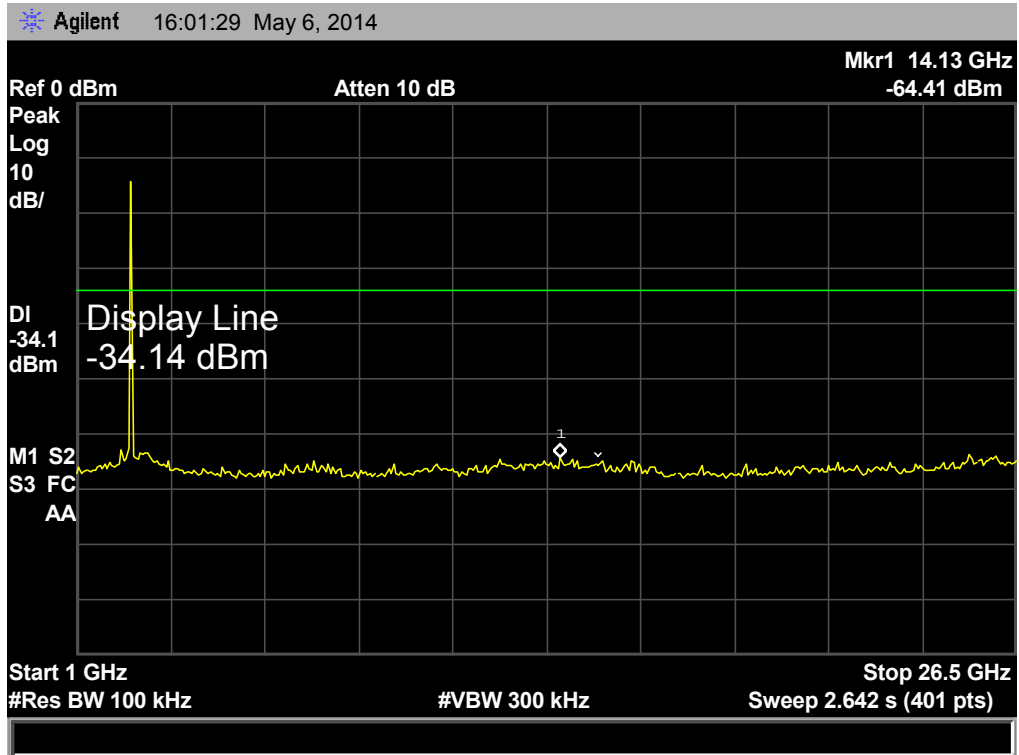

Below 1 GHz

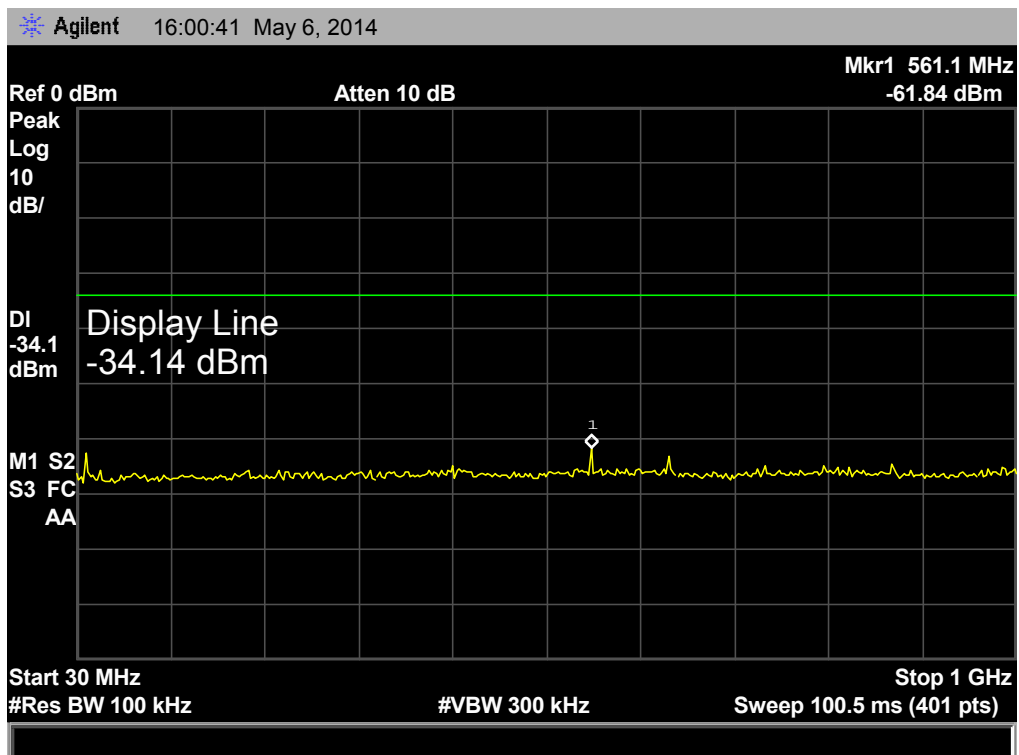

802.11n (HT20) Mode TX CH 01 2412MHz

Above 1 GHz

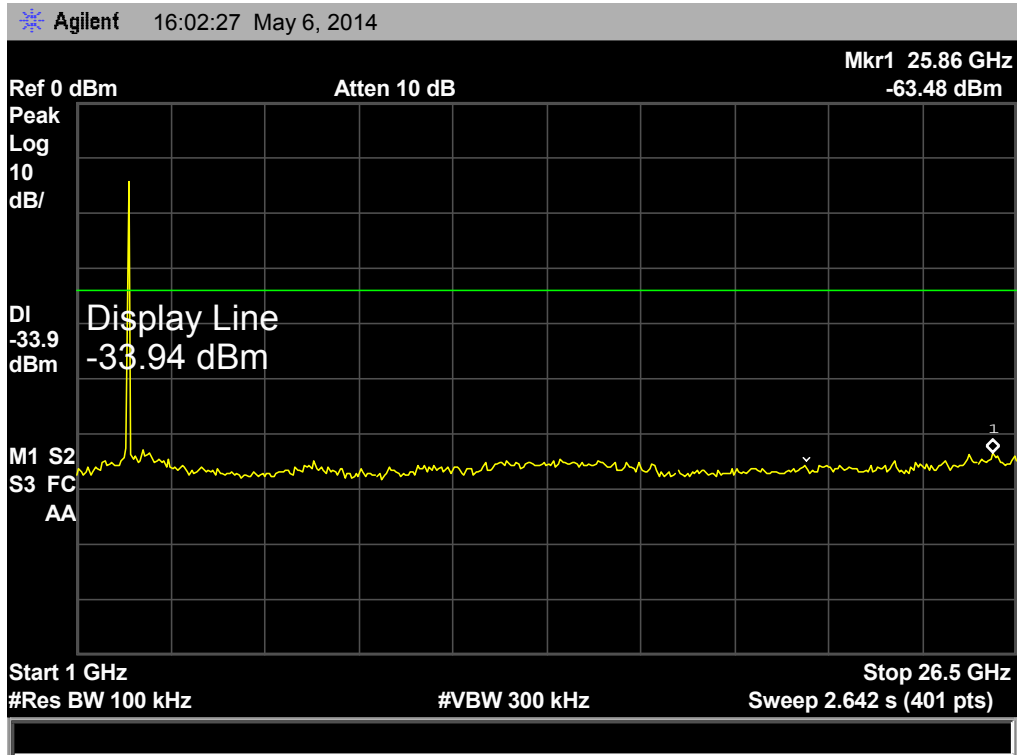

Below 1 GHz

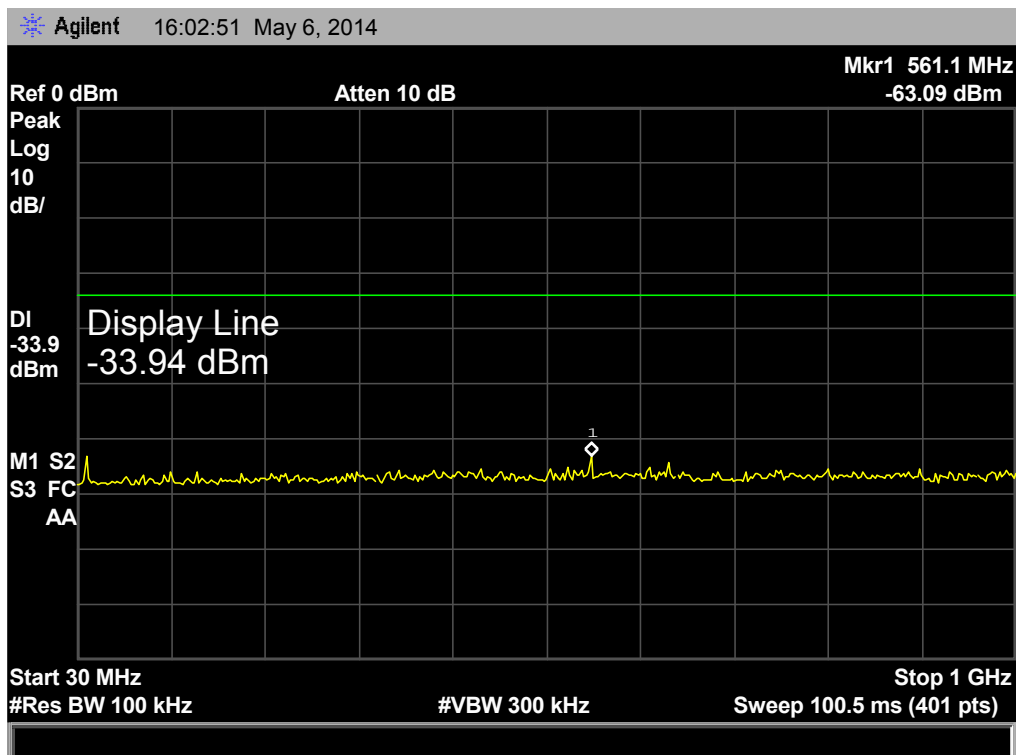

802.11n (HT20) Mode TX CH 06 2437MHz

Above 1 GHz

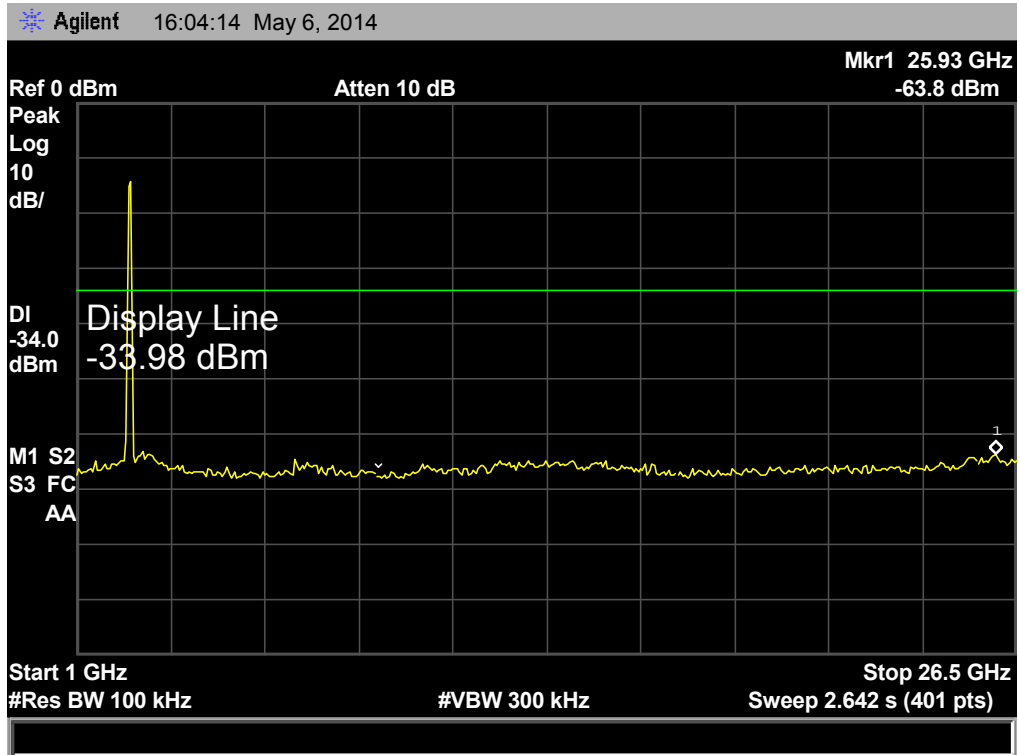

Below 1 GHz

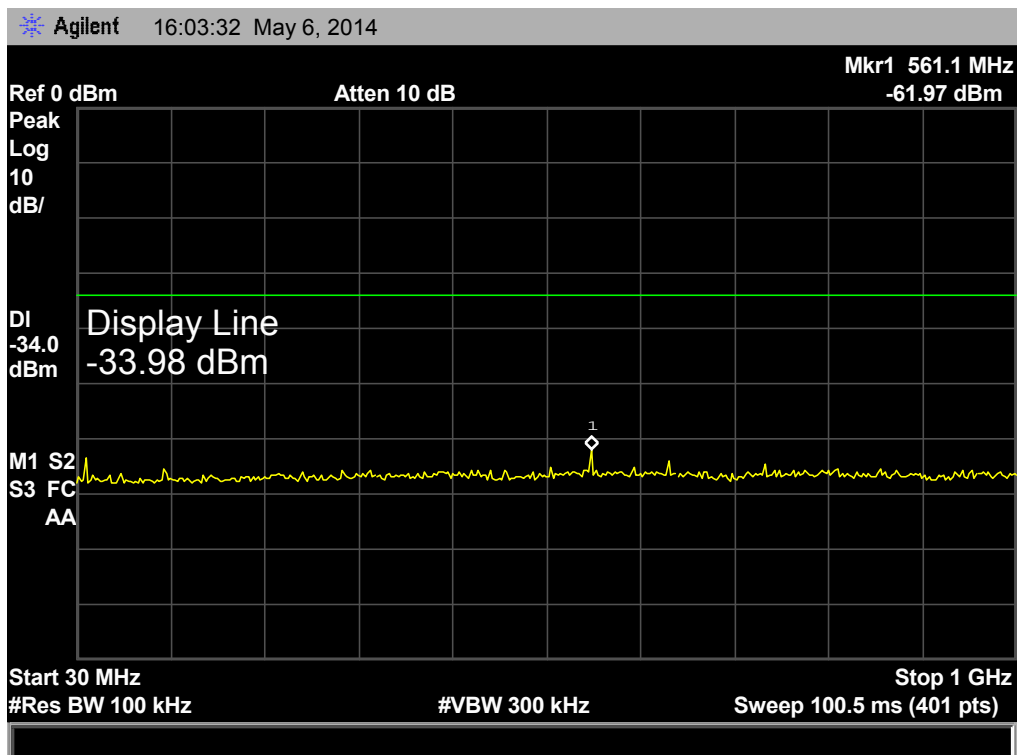

802.11n (HT20) Mode

TX CH 11 2462MHz

Above 1 GHz

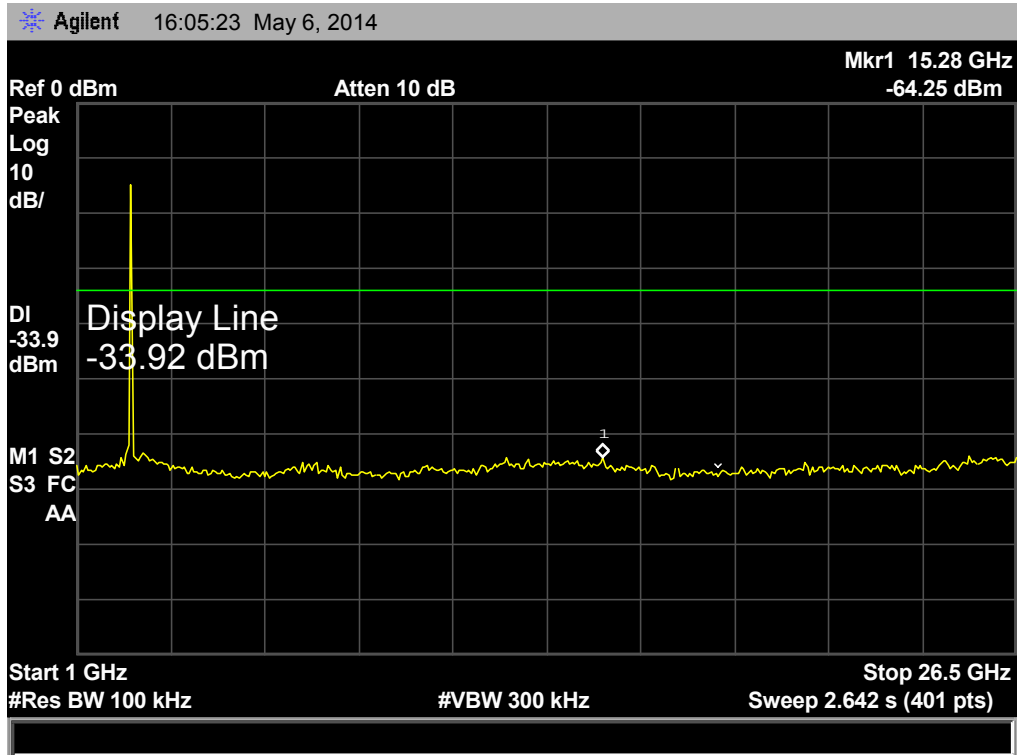

Below 1 GHz

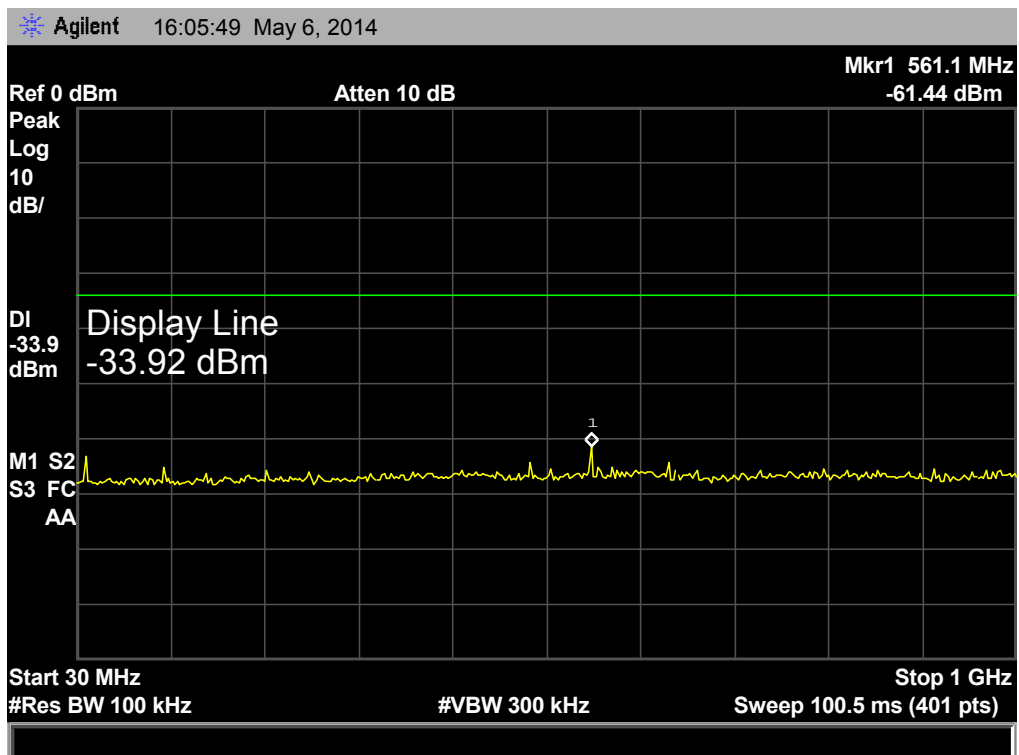

802.11n (HT40) Mode TX CH 03 2422MHz

Above 1 GHz

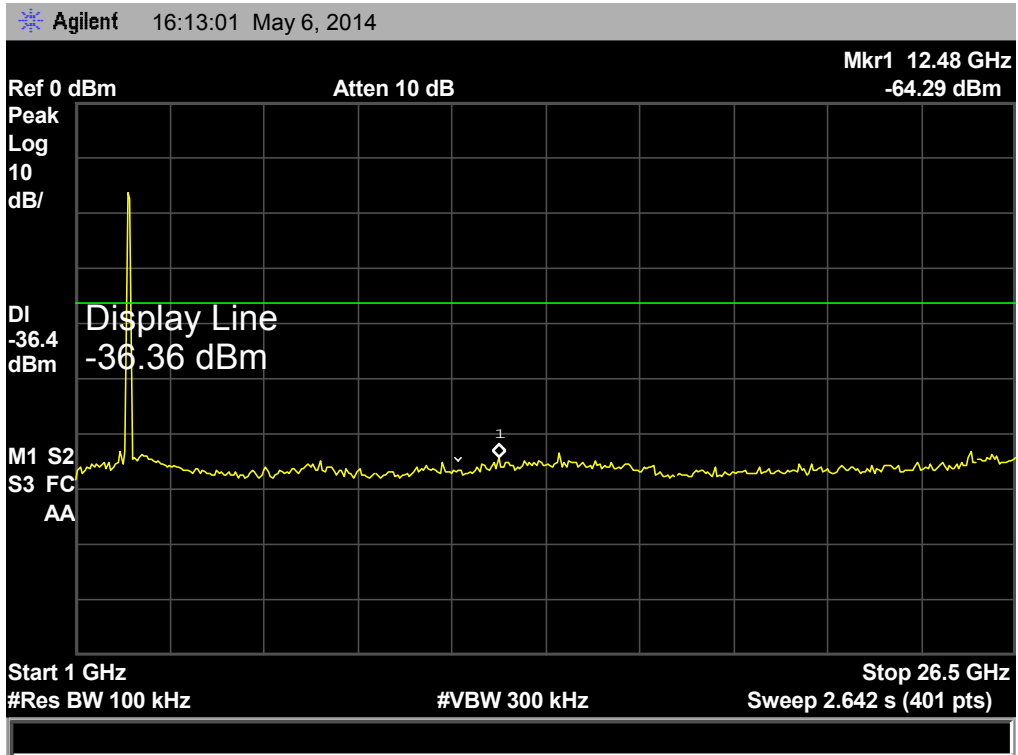

Below 1 GHz

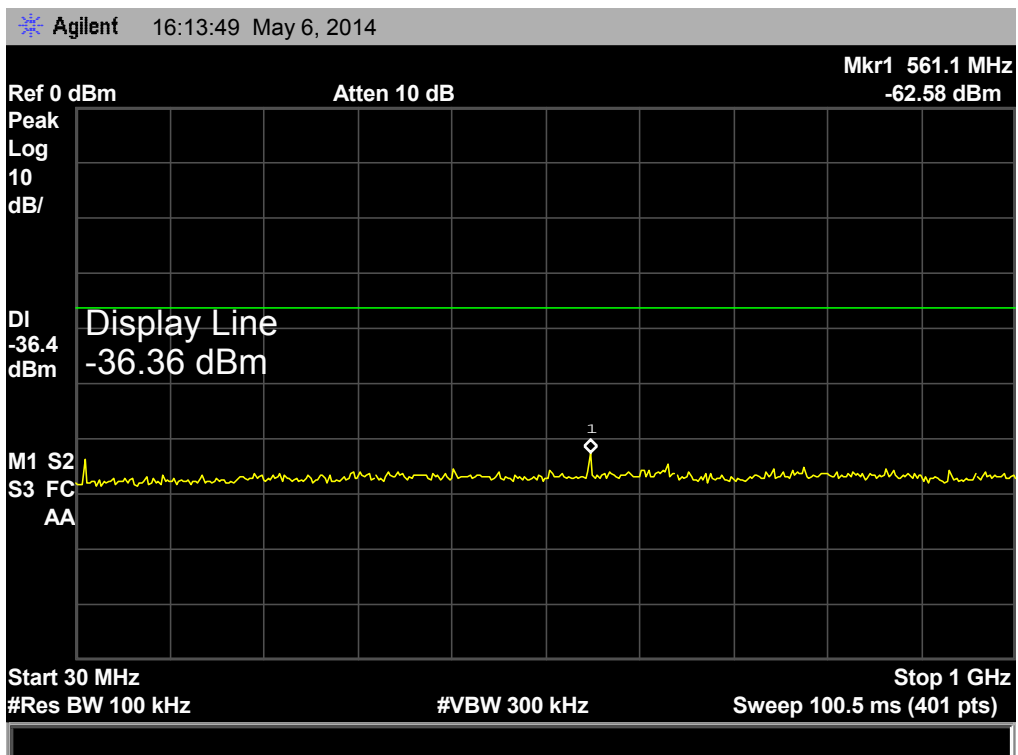

802.11n (HT40) Mode TX CH 06 2437MHz

Above 1 GHz

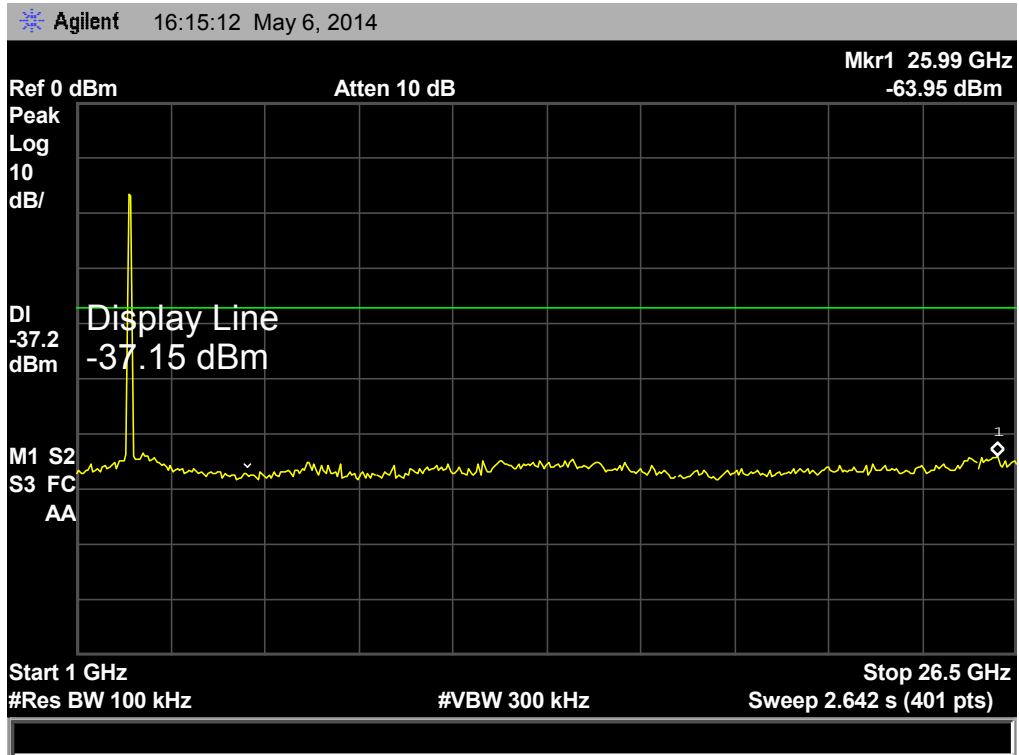

Below 1 GHz

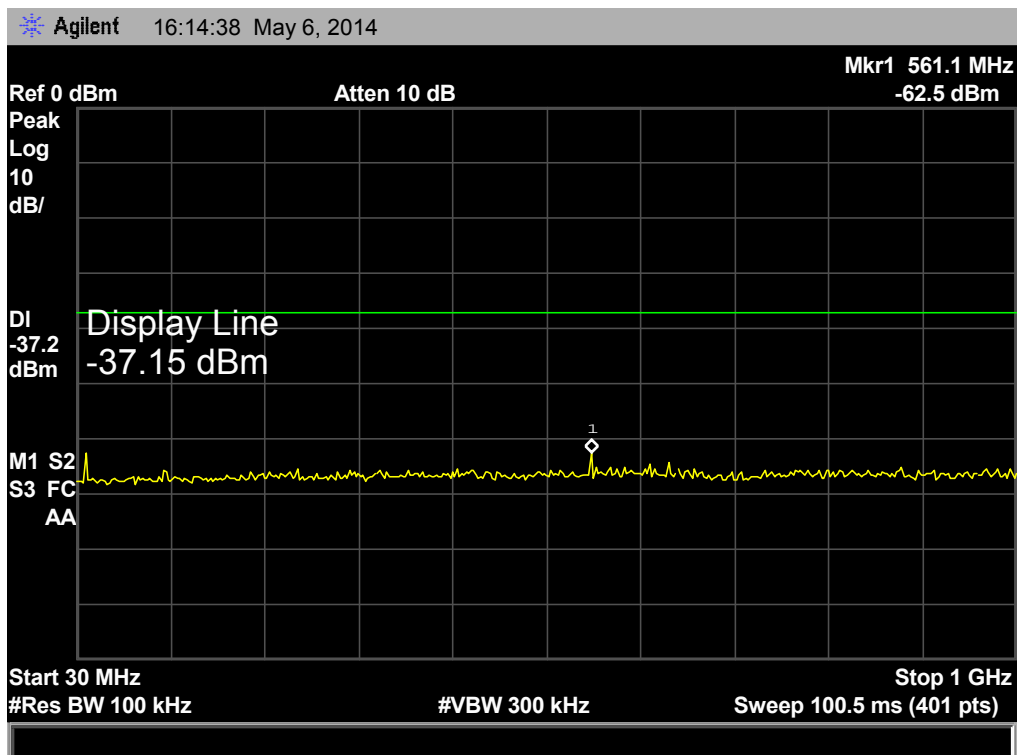

802.11n (HT40) Mode

TX CH 09 2452MHz

Above 1 GHz

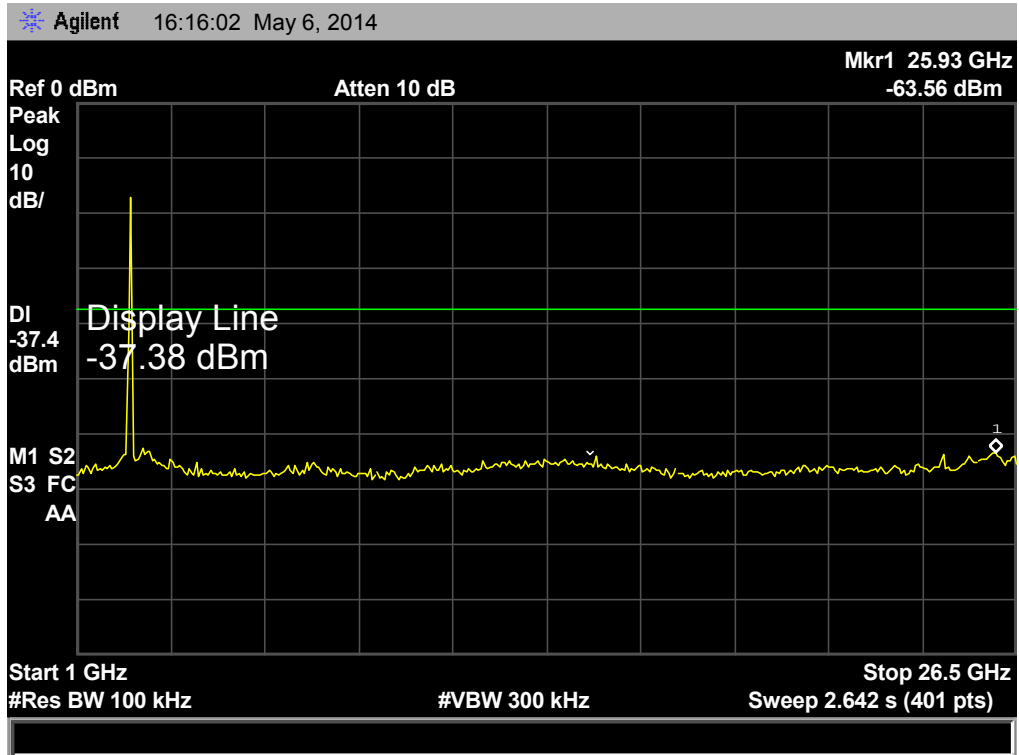

Below 1 GHz

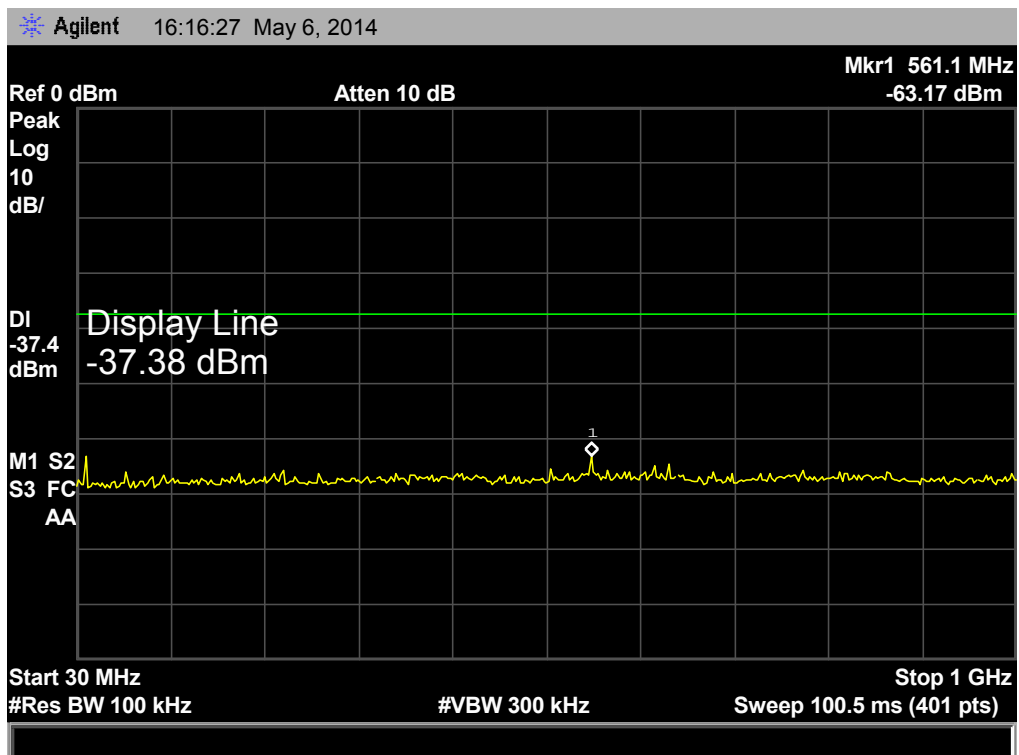

10. Antenna Requirement

10.1 Standard Requirement

11.1.1 Standard

FCC Part 15.203

11.1.2 Requirement

An intentional radiator shall be designed to ensure that no antenna other than that furnished by the responsible party shall be used with the device. The use of a permanently attached antenna or of an antenna that uses a unique coupling to the intentional radiator shall be considered sufficient to comply with the provisions of this Section. The manufacturer may design the unit so that a broken antenna can be replaced by the user, but the use of a standard antenna jack or electrical connector is prohibited.

10.2 Antenna Connected Construction

The directional gains of the antenna used for transmitting is 0dBi, and the antenna de-signed with permanent attachment and no consideration of replacement. Please see the EUT photo for details.

10.2 Result

The EUT antenna is a PIFA Antenna. It complies with the standard requirement.