



TEST REPORT	
Report Number.	90454-23-72-23-PP001
Date of issue	June 29.2023
Tested by (+signature)	Duke Chen 
Approved by (+signature)	Jason Gao 
Testing Laboratory name	SLG-CPC Testlaboratory Co., Ltd.
Address	No. 11, Wu Song Road, Dongcheng District, Dongguan, Guangdong Province, China 523117
Applicant's name	Lightcomm Technology Co., Ltd.
Address	UNIT 1306 13/F ARION COMMERCIAL CENTRE,2-12 QUEEN'S ROAD WEST,SHEUNG WAN HK
Manufacturer's name	Lightcomm Technology Co., Ltd.
Address	UNIT 1306 13/F ARION COMMERCIAL CENTRE,2-12 QUEEN'S ROAD WEST,SHEUNG WAN HK
Factory's name	Huizhou Hengdu Electronics Co.,Ltd.
Address	No.8 Huitai Road,Huinan High-tech Industrial Park,Huiiao Avenue,Huizhou,Guangdong,China
Standard(s)	FCC 47 CFR Part 15, Subpart C
Test item description	Car Multimedia System
Model/Type reference	DMCPA8W
Series models	DMCPA80FL, DCPA813, DCPA81W, DMCPA10W, AVM2310W, J1CA10FL, CAR1013, CAR813, J1CA8FL, CVS8489W-SD, CVS1515W-SD, XDCPA73W, DCPA723W, DCA73W, DMCPA703W, CAR723W, J3CA7W, CVS7482W-SD
FCC ID	XMF-DMCPA8W
Date of receipt of test item .. :	June 01.2023
Date (s) of performance of test :	June 02.2023 to June 15.2023
Summary of Test Results :	Pass
The Summary of Test Results based on a technical opinion belongs to the standard(s).	
General disclaimer:	
This report shall not be reproduced except in full, without the written approval of SLG-CPC Testlaboratory Co., Ltd. The test results in the report only apply to the tested sample.	

TABLE OF CONTENTS

1	EUT TECHNICAL DESCRIPTION.....	4
2	SUMMARY OF TEST RESULT	5
3	TEST METHODOLOGY	6
3.1	GENERAL DESCRIPTION OF APPLIED STANDARDS	6
3.2	MEASUREMENT EQUIPMENT USED	6
3.3	DESCRIPTION OF TEST MODES.....	7
4	FACILITIES AND ACCREDITATIONS	8
4.1	FACILITIES	8
4.2	LABORATORY ACCREDITATIONS AND LISTINGS.....	8
5	TEST SYSTEM UNCERTAINTY	9
6	SETUP OF EQUIPMENT UNDER TEST	10
6.1	RADIO FREQUENCY TEST SETUP 1	10
6.2	RADIO FREQUENCY TEST SETUP 2	10
6.3	CONDUCTED EMISSION TEST SETUP	12
6.4	BLOCK DIAGRAM CONFIGURATION OF TEST SYSTEM.....	13
6.5	SUPPORT EQUIPMENT.....	13
7	Frequency Hopping System Requirements.....	14
7.1	Standard Applicable	14
7.2	EUT Pseudorandom Frequency Hopping Sequence	14
7.3	Equal Hopping Frequency Use	15
7.4	Frequency Hopping System.....	15
8	TEST REQUIREMENTS	16
8.1	20DB BANDWIDTH	16
8.2	CARRIER FREQUENCY SEPARATION	21
8.3	NUMBER OF HOPPING FREQUENCIES	26
8.4	AVERAGE TIME OF OCCUPANCY (DWELL TIME)	29
8.5	MAXIMUM PEAK CONDUCTED OUTPUT POWER	37
8.6	RADIATED SPURIOUS EMISSION	41
8.7	ANTENNA APPLICATION.....	57
8.8	TEST PHOTO	58
8.9	EUT PHOTO	59

Modified Information

Version	Report No.	Revision Data	Summary
Ver.1.0	90454-23-72-23-PP001	2023-06-29	Original Version

1 EUT TECHNICAL DESCRIPTION

Characteristics	Description
Product	Car Multimedia System
Model Number	DMCPA8W
Series models	DMCPA80FL, DCPA813, DCPA81W, DMCPA10W, AVM2310W, J1CA10FL, CAR1013, CAR813, J1CA8FL, CVS8489W-SD, CVS1515W-SD, XDCPA73W, DCPA723W, DCA73W, DMCPA703W, CAR723W, J3CA7W, CVS7482W-SD
Modulation:	GFSK, $\pi/4$ DQPSK, 8DPSK
Operating Frequency Range(s):	2402-2480MHz
Number of Channels:	79 channels
Antenna Type	External antenna
Antenna Gain	1.59dBi
Power supply	<input checked="" type="checkbox"/> DC supply: DC 12V

Note: for more details, please refer to the User's manual of the EUT.

2 SUMMARY OF TEST RESULT

FCC Part Clause	Test Parameter	Verdict	Remark
15.247(a)(1)	20 dB Bandwidth	PASS	
15.247(a)(1)	Carrier Frequency Separation	PASS	
15.247(a)(1)	Number of Hopping Frequencies	PASS	
15.247(a)(1)	Average Time of Occupancy (Dwell Time)	PASS	
15.247(b)(1)	Maximum Peak Conducted Output Power	PASS	
15.247(d) 15.209	Radiated Spurious Emissions	PASS	
15.207	Conducted Emission	N/A	
15.203	Antenna Application	PASS	
15.247 (a) (1)/g/h	Frequency Hopping System	PASS	
NOTE1: N/A (Not Applicable) 15.207 only signals conducted onto the AC power lines are required to be measured. The equipment is only DC power supply, so "Power Line Conducted Emissions" is not required.			

RELATED SUBMITTAL(S) / GRANT(S):

This submittal(s) (test report) is intended for FCC ID: XMF-DMCPA8W filing to comply with Section 15.247 of the FCC Part 15, Subpart C Rules.

3 TEST METHODOLOGY

3.1 GENERAL DESCRIPTION OF APPLIED STANDARDS

According to its specifications, the EUT must comply with the requirements of the following standards:

FCC 47 CFR Part 15, Subpart C

FCC KDB 558074 D01 15.247 Meas Guidance v05r02

3.2 MEASUREMENT EQUIPMENT USED

Equipment	Model	Manufacturer	S/N	Last Cal.	DUE Cal.
RF Connected Test					
Vector Signal Generater	Rohde & Schwarz	SMBV100B(6G)	101166	2022/06/29	1 year
Analog Signal Generator	Rohde & Schwarz	SMB100A(40G)	181333	2022/06/29	1 year
Signal Analyzer	Rohde & Schwarz	FSV40	101527	2023/03/29	1 year
Power Analyzer	Rohde & Schwarz	OSP-B157W8	N/A	2022/06/29	1 year
Wideband Radio Communication Tester	R&S	CMW270	101985	2022/07/05	1 year
Wideband Radio Communication Tester	Rohde & Schwarz	CMW500	166898	2022/07/14	1 year
Spectrum Analyzer	Agilent	E4408B	MY44211139	2022/11/07	1 year
Temperature&Humidity test chamber	ESPEC	VC 4018	/	2023/03/29	1 year
Radiated Emission Test					
EMI Test Receiver	KEYSIGHT	N9010A	MY56070465	2022/12/07	1 year
EMI Test Receiver	Rohde & Schwarz	FSV40	101511	2023/03/29	1 year
Bilog Antenna	Schwarzbeck	VULB 9163	01335	2023/04/21	3 year
Power Amplifier	EMEC	EM330	060676	2022/12/07	3 year
Cable	Tuyue	F4309	L-400-NmNm-1 2000	2022/12/07	1 year
Horn Antenna	Schwarzbeck	BBHA9120D	1779	2022/04/21	3 year
Horn Antenna	Schwarzbeck	BBHA9170	00954	2022/09/13	3 year
Power Amplifier	Rohde & Schwarz	SCU-18F	180118	2022/04/21	3 year
Active Loop Antenna	ETS LINDGREN	6512	41623	2022/04/23	3 year
Test Software	Farad	EZ-EMC	Ver.CPC-3A1	/	/
Conducted Emission Test					
LISN	Schwarzbeck	NSLK 8127	8127-892	2023/03/21	1 year
EMI Test Receiver	R&S	ESR3	102124	2022/12/07	1 year
Pulse Limiter	R&S	ESH3-Z2	357.8810.52	2022/12/07	1 year
Test Software	Farad	EZ-EMC	Ver.CPC-3A1	/	/

3.3 DESCRIPTION OF TEST MODES

The EUT has been tested under its typical operating condition.

The EUT configuration for testing is installed on RF field strength measurement to meet the Commissions requirement and operating in a manner which intends to maximize its emission characteristics in a continuous normal application.

The Transmitter was operated in the normal operating mode. The TX frequency was fixed which was for the purpose of the measurements.

Test of channel included the lowest and middle and highest frequency to perform the test, then record on this report.

Those data rates (1Mbps for GFSK modulation; 2Mbps for pi/4-DQPSK modulation; 3Mbps for 8DPSK modulation) were used for all test.

Pre-defined engineering program for regulatory testing used to control the EUT for staying in continuous transmitting and receiving mode is programmed.

Frequency and Channel list

Channel No.	Frequency (MHz)	Channel No.	Frequency (MHz)	Channel No.	Frequency (MHz)	Channel No.	Frequency (MHz)
1	2402	2	2403	3	2404	4	2405
5	2406	6	2407	7	2408	8	2409
9	2410	10	2411	11	2412	12	2413
13	2414	14	2415	15	2416	16	2417
17	2418	18	2419	19	2420	20	2421
21	2422	22	2423	23	2424	24	2425
25	2426	26	2427	27	2428	28	2429
29	2430	30	2431	31	2432	32	2433
33	2434	34	2435	35	2436	36	2437
37	2438	38	2439	39	2440	40	2441
41	2442	42	2443	43	2444	44	2445
45	2446	46	2447	47	2448	48	2449
49	2450	50	2451	51	2452	52	2453
53	2454	54	2455	55	2456	56	2457
57	2458	58	2459	59	2460	60	2461
61	2462	62	2463	63	2464	64	2465
65	2466	66	2467	67	2468	68	2469
69	2470	70	2471	71	2472	72	2473
73	2474	74	2475	75	2476	76	2477
77	2478	78	2479	79	2480	-	-

4 FACILITIES AND ACCREDITATIONS

4.1 FACILITIES

All measurement facilities used to collect the measurement data are located at

No. 11, Wu Song Road, Dongcheng District, Dongguan, Guangdong Province, China 523117

The sites are constructed in conformance with the requirements of ANSI C63.7, ANSI C63.10 and CISPR Publication 22.

4.2 LABORATORY ACCREDITATIONS AND LISTINGS

Site Description

EMC Lab.

:

Accredited by A2LA

The Certificate Number is 6325.01.

Name of Firm

: SLG-CPC Testlaboratory Co., Ltd.

Site Location

: No. 11, Wu Song Road, Dongcheng District, Dongguan,
Guangdong Province, China 523117

5 TEST SYSTEM UNCERTAINTY

The following measurement uncertainty levels have been estimated for tests performed on the apparatus:

Test Parameter	Measurement Uncertainty
RF Output Power	±1.0%
Power Spectral Density	±0.9%
Duty Cycle and Tx-Sequence and Tx-Gap	±1.3%
Medium Utilisation Factor	±1.5%
Occupied Channel Bandwidth	±2.3%
Transmitter Unwanted Emission in the Out-of Band	±1.2%
Transmitter Unwanted Emissions in the Spurious Domain	±2.7%
Receiver Spurious Emissions	±2.7%
Temperature	±3.2%
Humidity	±2.5%

Measurement Uncertainty for a level of Confidence of 95%

6 SETUP OF EQUIPMENT UNDER TEST

6.1 RADIO FREQUENCY TEST SETUP 1

The Bluetooth V4.0 component's antenna ports(s) of the EUT are connected to the measurement instrument per an appropriate attenuator. The EUT is controlled by PC/software to emit the specified signals for the purpose of measurements.

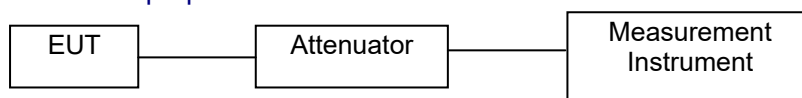

6.2 RADIO FREQUENCY TEST SETUP 2

The test site semi-anechoic chamber has met the requirement of NSA tolerance 4 dB according to the standards: ANSI C63.10. The test distance is 3m. The setup is according to the requirements in Section 13.1.4.1 of ANSI C63.10-2013 and CAN/CSA-CEI/IEC CISPR 22.

Below 30MHz:

The EUT is placed on a turntable 0.8meters above the ground in the chamber, 3 meter away from the antenna (loop antenna). The Antenna should be positioned with its plane vertical at the specified distance from the EUT and rotated about its vertical axis for maximum response at each azimuth about the EUT. The center of the loop shall be 1 m above the ground. For certain applications, the loop antenna plane may also need to be positioned horizontally at the specified distance from the EUT.

Above 30MHz:

The EUT is placed on a turntable 0.8meters above the ground in the chamber, 3 meter away from the antenna. The maximal emission value is acquired by adjusting the antenna height, polarisation and turntable azimuth. Normally, the height range of antenna is 1 m to 4 m, the azimuth range of turntable is 0° to 360°, and the receive antenna has two polarizations Vertical (V) and Horizontal (H).

Above 1GHz:

(Note: the FCC's permission to use 1.5m as an alternative per TCBC Conf call of Dec. 2, 2014.)

The EUT is placed on a turntable 1.5 meters above the ground in the chamber, 3 meter away from the antenna. The maximal emission value is acquired by adjusting the antenna height, polarisation and turntable azimuth. Normally, the height range of antenna is 1 m to 4 m, the azimuth range of turntable is 0° to 360°, and the receive antenna has two polarizations Vertical (V) and Horizontal (H).

(a) Radiated Emission Test Set-Up, Frequency Below 30MHz

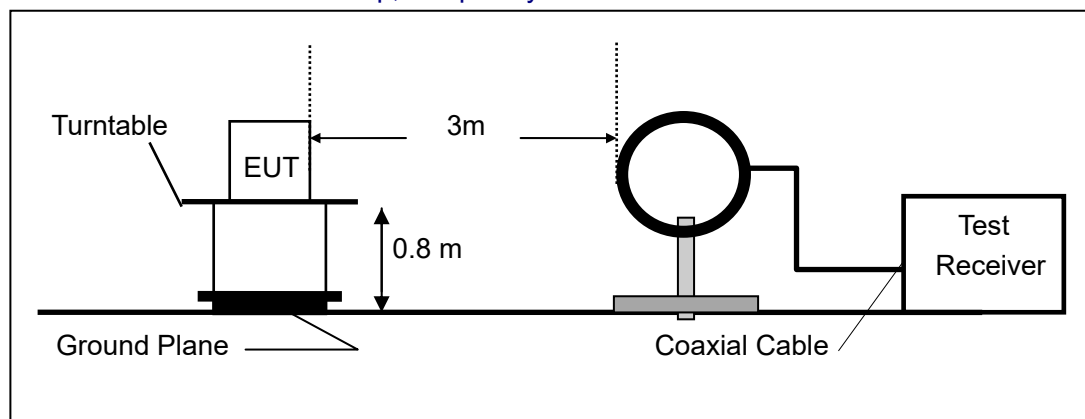

(b) Radiated Emission Test Set-Up, Frequency Below 1000MHz

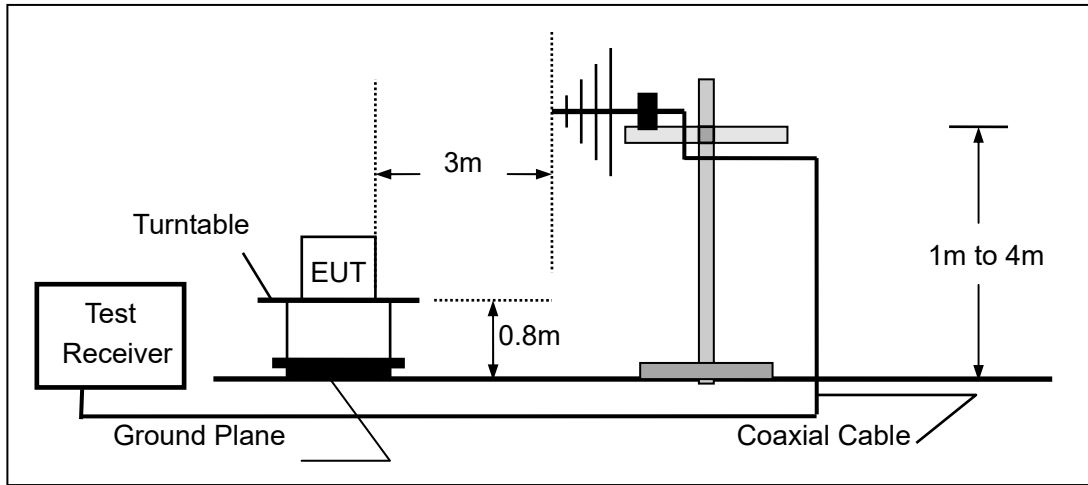

(c) Radiated Emission Test Set-Up, Frequency above 1000MHz

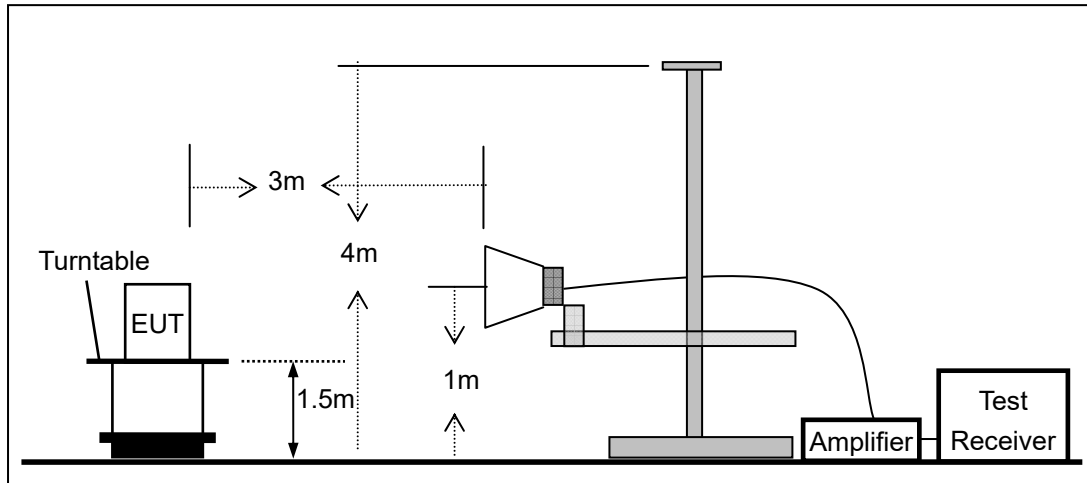

6.3 CONDUCTED EMISSION TEST SETUP

The mains cable of the EUT (Perfect Share Mini) must be connected to LISN. The LISN shall be placed 0.8m from the boundary of EUT and bonded to a ground reference plane for LISN mounted on top of the ground reference plane. This distance is between the closest points of the LISN and the EUT. All other units of the EUT and associated equipment shall be at least 0.8m from the LISN.

Ground connections, where required for safety purposes, shall be connected to the reference ground point of the LISN and, where not otherwise provided or specified by the manufacturer, shall be of same length as the mains cable and run parallel to the mains connection at a separation distance of not more than 0.8m.

According to the requirements in Section 13.1.4.1 of ANSI C63.10-2013 Conducted emissions from the EUT measured in the frequency range between 0.15 MHz and 30 MHz using CISPR Quasi-Peak and average detector mode.

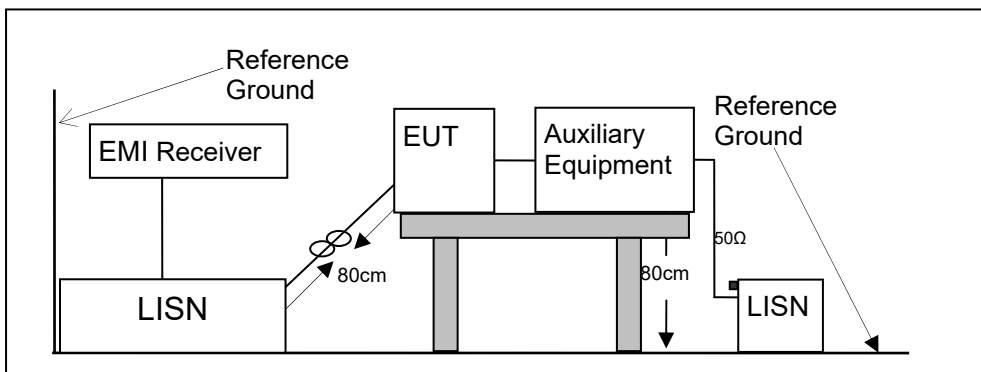

6.4 BLOCK DIAGRAM CONFIGURATION OF TEST SYSTEM

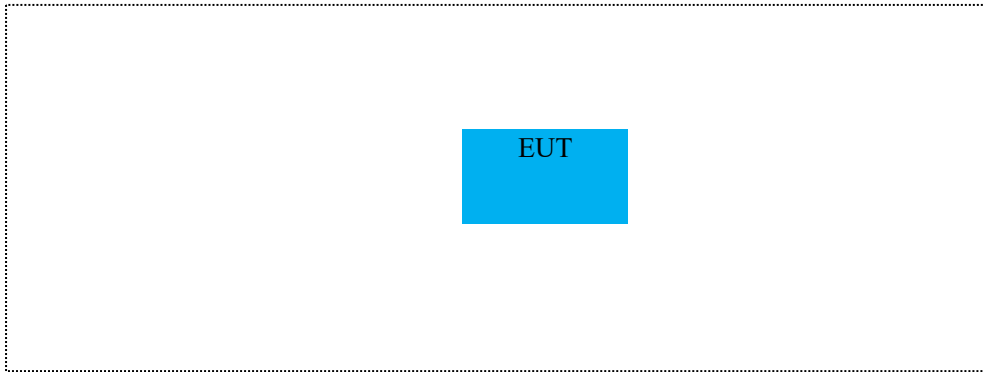

6.5 SUPPORT EQUIPMENT

EUT Cable List and Details			
Cable Description	Length (m)	Shielded/Unshielded	With / Without Ferrite

Auxiliary Cable List and Details			
Cable Description	Length (m)	Shielded/Unshielded	With / Without Ferrite

Auxiliary Equipment List and Details			
Description	Manufacturer	Model	Serial Number

Notes:

1. All the equipment/cables were placed in the worst-case configuration to maximize the emission during the test.
2. Grounding was established in accordance with the manufacturer's requirements and conditions for the intended use.

7 FREQUENCY HOPPING SYSTEM REQUIREMENTS

7.1 Standard Applicable

According to FCC Part 15.247(a)(1), The system shall hop to channel frequencies that are selected at the system hopping rate from a pseudo randomly ordered list of hopping frequencies. Each frequency must be used equally on the average by each transmitter. The system receivers shall have input bandwidths that match the hopping channel bandwidths of their corresponding transmitters and shall shift frequencies in synchronization with the transmitted signals.

(g) Frequency hopping spread spectrum systems are not required to employ all available hopping channels during each transmission. However, the system, consisting of both the transmitter and the receiver, must be designed to comply with all of the regulations in this section should the transmitter be presented with a continuous data (or information) stream. In addition, a system employing short transmission bursts must comply with the definition of a frequency hopping system and must distribute its transmissions over the minimum number of hopping channels specified in this section.

(h) The incorporation of intelligence within a frequency hopping spread spectrum system that permits the system to recognize other users within the spectrum band so that it individually and independently chooses and adapts its hopsets to avoid hopping on occupied channels is permitted. The coordination of frequency hopping systems in any other manner for the express purpose of avoiding the simultaneous occupancy of individual hopping frequencies by multiple transmitters is not permitted.

7.2 EUT Pseudorandom Frequency Hopping Sequence

The channel is represented by a pseudo-random hopping sequence hopping through the 79 RF channels.

The hopping sequence is unique for the piconet and is determined by the Bluetooth device address of the master; the phase in the hopping sequence is determined by the Bluetooth clock of the master. The channel is divided into time slots where each slot corresponds to an RF hop frequency. Consecutive hops correspond to different RF hop frequencies. The normal hop is 1 600 hops/s.

The pseudorandom sequence may be generated in a nine-stage shift register whose 5th and 9th stage outputs are added in a modulo-two addition stage, and the result is fed back to the input of the first stage. The sequence begins with the first ONE of 9 consecutive ONES; i.e. the shift register is initialized with nine ones. Number of shift register stages: 9

Length of pseudo-random sequence: $2^9 - 1 = 511$ bits

Longest sequence of zeros: 8 (non-inverted signal)

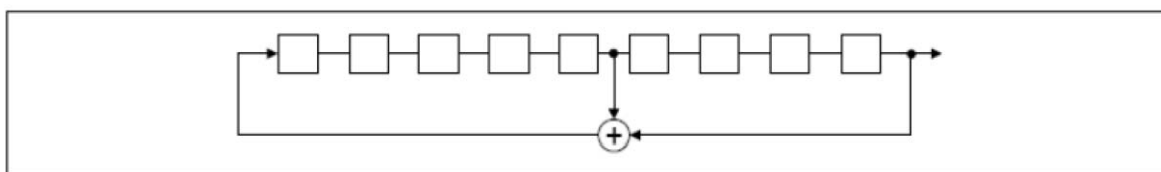

Linear Feedback Shift Register for Generation of the PRBS sequence

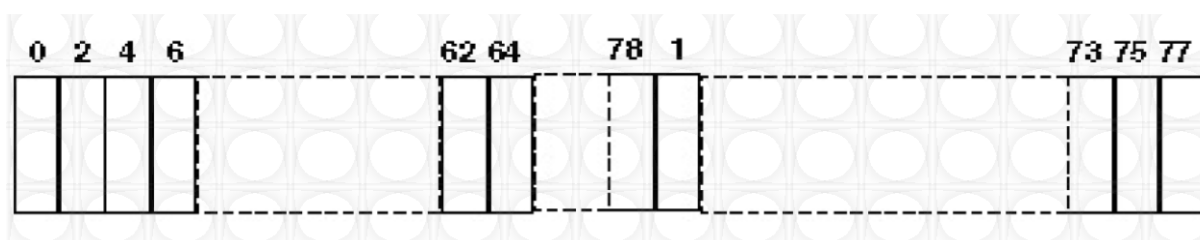

Each frequency used equally on the average by each transmitter.

The system receiver have input bandwidths that match the hopping channel bandwidths of their corresponding transmitters and shift frequencies in synchronization with the transmitted signals.

7.3 Equal Hopping Frequency Use

All Bluetooth units participating in the piconet are time and hop-synchronized to the channel.

Example of a 79 hopping sequence in data mode:

35, 27, 6, 44, 14, 61, 74, 32, 1, 11, 23, 2, 55, 65, 29, 3, 9, 52, 78, 58, 40, 25, 0, 7, 18, 26, 76, 60, 47, 50, 2, 5, 16, 37, 70, 63, 66, 54, 20, 13, 4, 8, 15, 21, 26, 10, 73, 77, 67, 69, 43, 24, 57, 39, 46, 72, 48, 33, 17, 31, 75, 19, 41, 62, 68, 28, 51, 66, 30, 56, 34, 59, 71, 22, 49, 64, 38, 45, 36, 42, 53

Each Frequency used equally on the average by each transmitter

7.4 Frequency Hopping System

This transmitter device is frequency hopping device, and complies with FCC part 15.247 rule.

This device uses Bluetooth radio which operates in 2400-2483.5 MHz band. Bluetooth uses a radio technology called frequency-hopping spread spectrum, which chops up the data being sent and transmits chunks of it on up to 79 bands (1 MHz each; centred from 2402 to 2480 MHz) in the range 2,400-2,483.5 MHz. The transmitter switches hop frequencies 1,600 times per second to assure a high degree of data security. All Bluetooth devices participating in a given piconet are synchronized to the frequency-hopping channel for the piconet. The frequency hopping sequence is determined by the master's device address and the phase of the hopping sequence (the frequency to hop at a specific time) is determined by the master's internal clock. Therefore, all slaves in a piconet must know the master's device address and must synchronize their clocks with the master's clock.

Adaptive Frequency Hopping (AFH) was introduced in the Bluetooth specification to provide an effective way for a Bluetooth radio to counteract normal interference. AFH identifies "bad" channels, where either other wireless devices are interfering with the Bluetooth signal or the Bluetooth signal is interfering with another device. The AFH-enabled Bluetooth device will then communicate with other devices within its piconet to share details of any identified bad channels. The devices will then switch to alternative available "good" channels, away from the areas of interference, thus having no impact on the bandwidth used.

8 TEST REQUIREMENTS

8.1 20DB BANDWIDTH

8.1.1 Applicable Standard

According to FCC Part 15.247(a)(1) and KDB 558074 D01 15.247 MEAS GUIDANCE v05r02

8.1.2 Conformance Limit

No limit requirement.

8.1.3 Test Configuration

Test according to clause 7.1 radio frequency test setup 1

8.1.4 Test Procedure

The EUT was operating in Bluetooth V4.0 mode and controlled its channel. Printed out the test result from the spectrum by hard copy function.

The RF output of EUT was connected to the spectrum analyzer by RF cable and attenuator. The path loss was compensated to the results for each measurement.

Set to the maximum power setting and enable the EUT transmit continuously

Set RBW = 30 kHz.

Set the video bandwidth (VBW) =100 kHz.

Set Span= approximately 2 to 3 times the 20 dB bandwidth

Set Detector = Peak.

Set Trace mode = max hold.

Set Sweep = auto couple.

The EUT should be transmitting at its maximum data rate. Allow the trace to stabilize. Use the marker-to-peak function to set the marker to the peak of the emission. Use the marker-delta function to measure 20 dB down one side of the emission. Reset the markerdelta function, and move the marker to the other side of the emission, until it is (as close as possible to) even with the reference marker level. The marker-delta reading at this point is the 20 dB bandwidth of the emission.

If this value varies with different modes of operation (e.g., data rate, modulation format, etc.), repeat this test for each variation.

Measure and record the results in the test report.

Test Results

Temperature:	26° C
Relative Humidity:	54%
ATM Pressure:	1011 mbar

Modulation Mode	Channel Number	Channel Frequency (MHz)	Measurement Bandwidth (MHz)	Limit (MHz)	Verdict
GFSK	1	2402	0.886	N/A	PASS
	40	2441	0.865	N/A	PASS
	79	2480	0.859	N/A	PASS
8DPSK	1	2402	1.214	N/A	PASS
	40	2441	1.218	N/A	PASS
	79	2480	1.218	N/A	PASS

Note: N/A (Not Applicable)

Through Pre-scan, find the DH5 of data type is the worst case of GFSK modulation type, 3-DH5 of data type is the worst case of 8DPSK modulation type.

Only the worst case is recorded in the report.

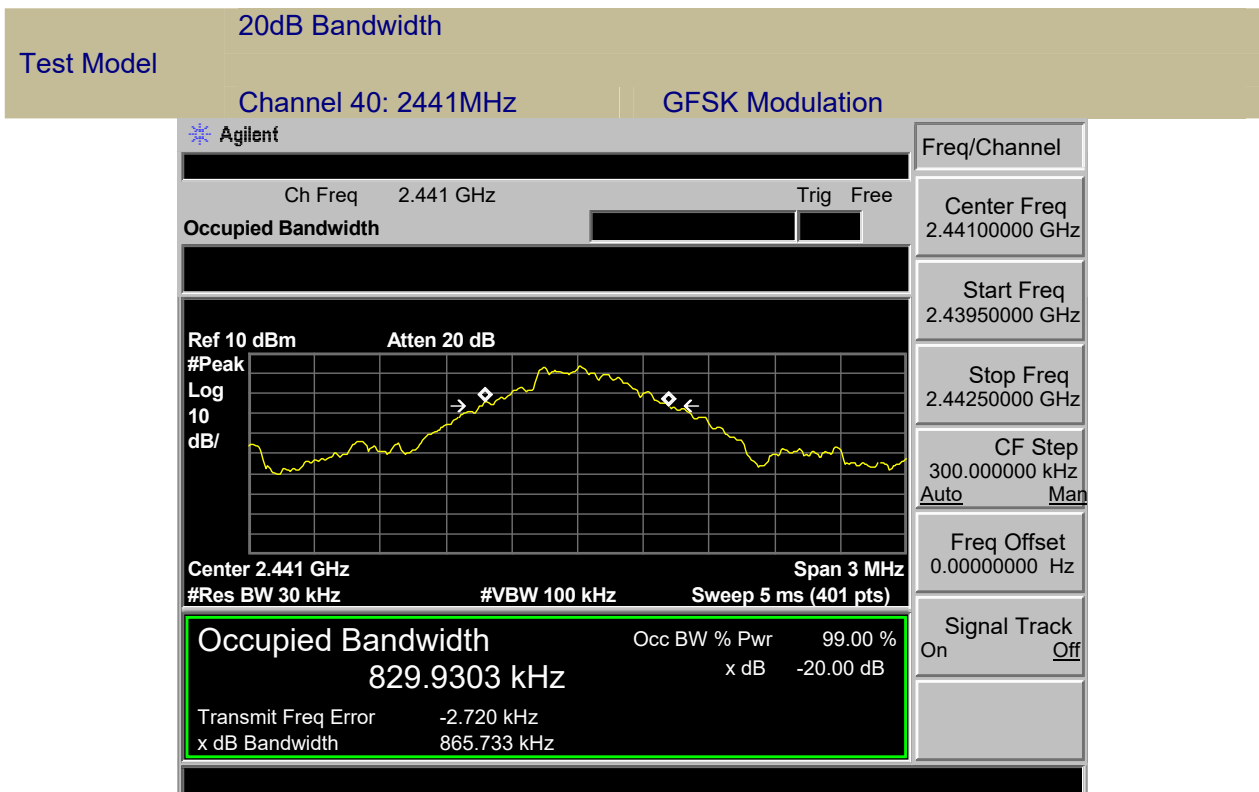
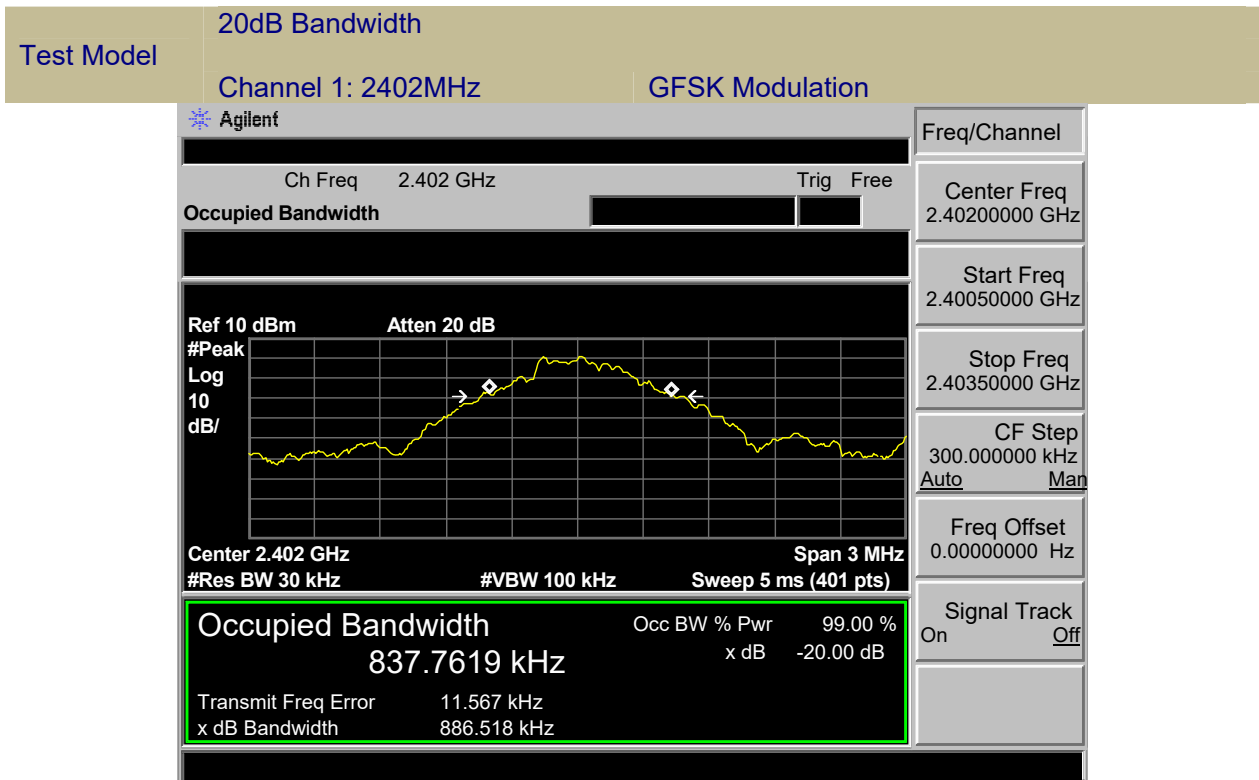

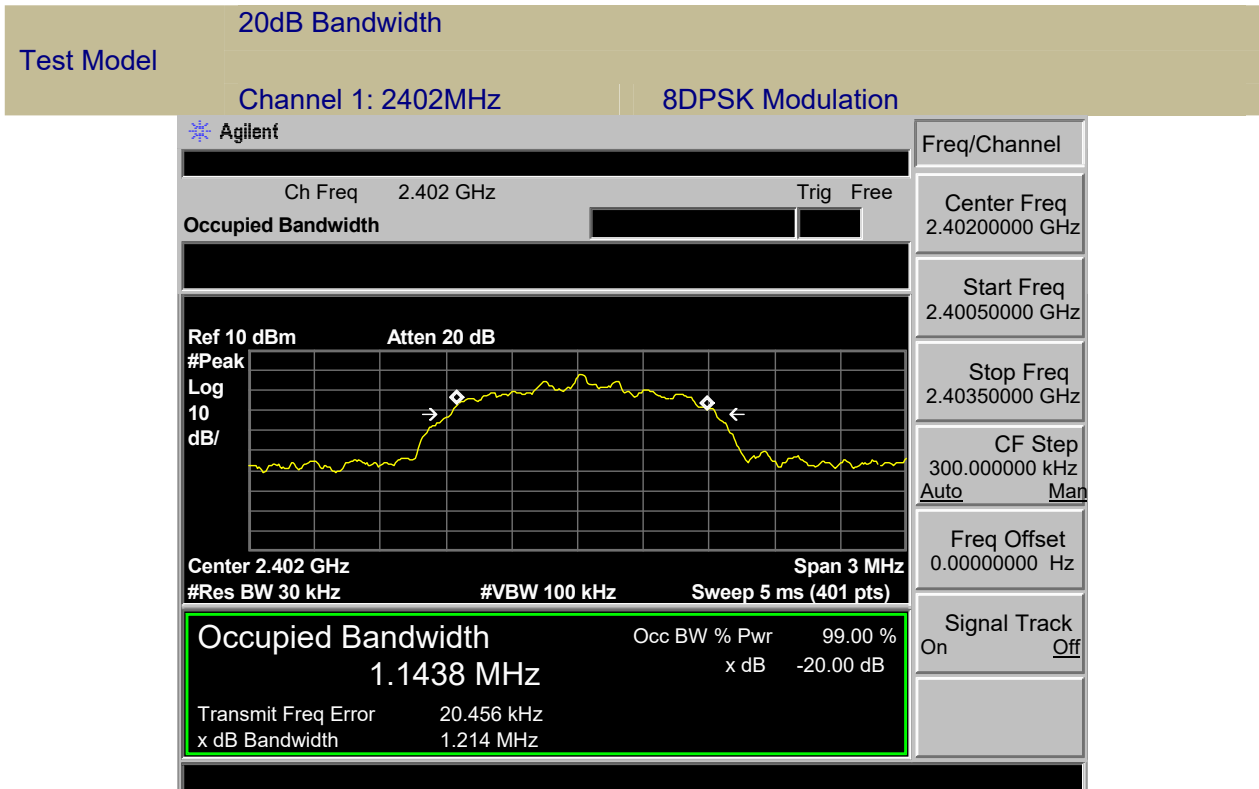
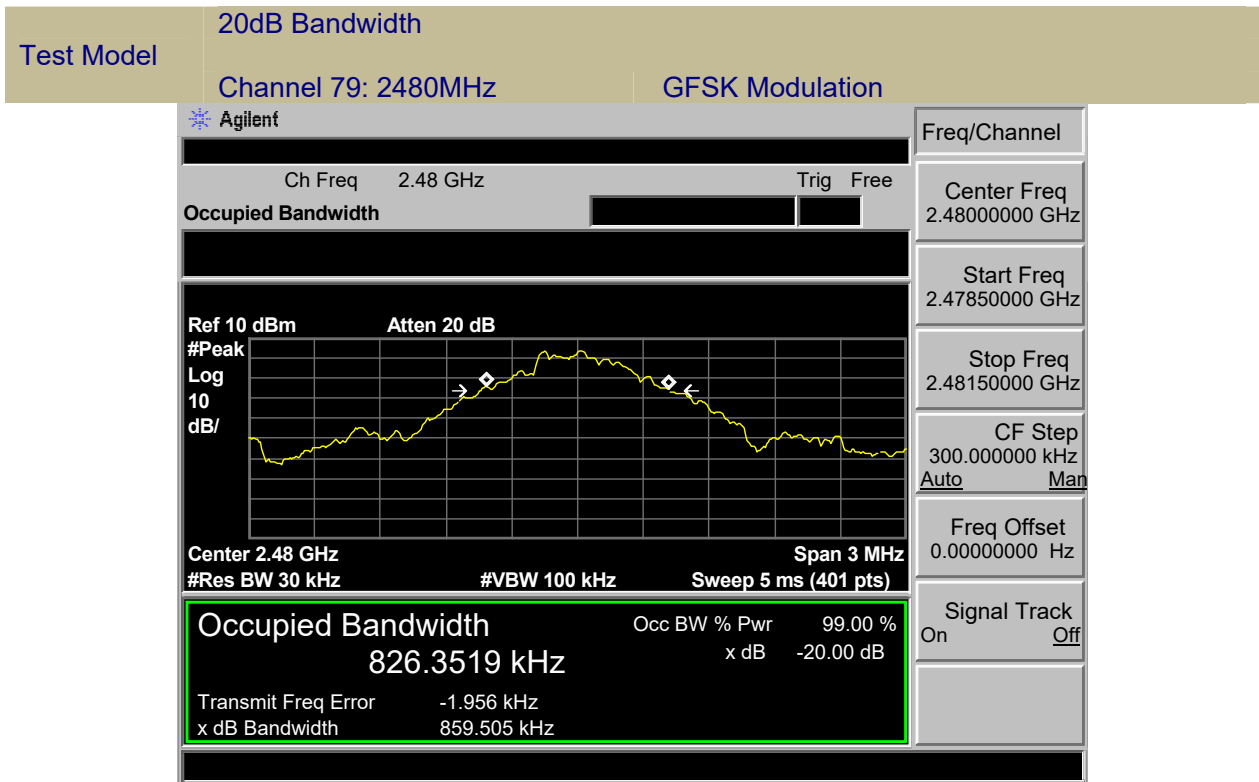

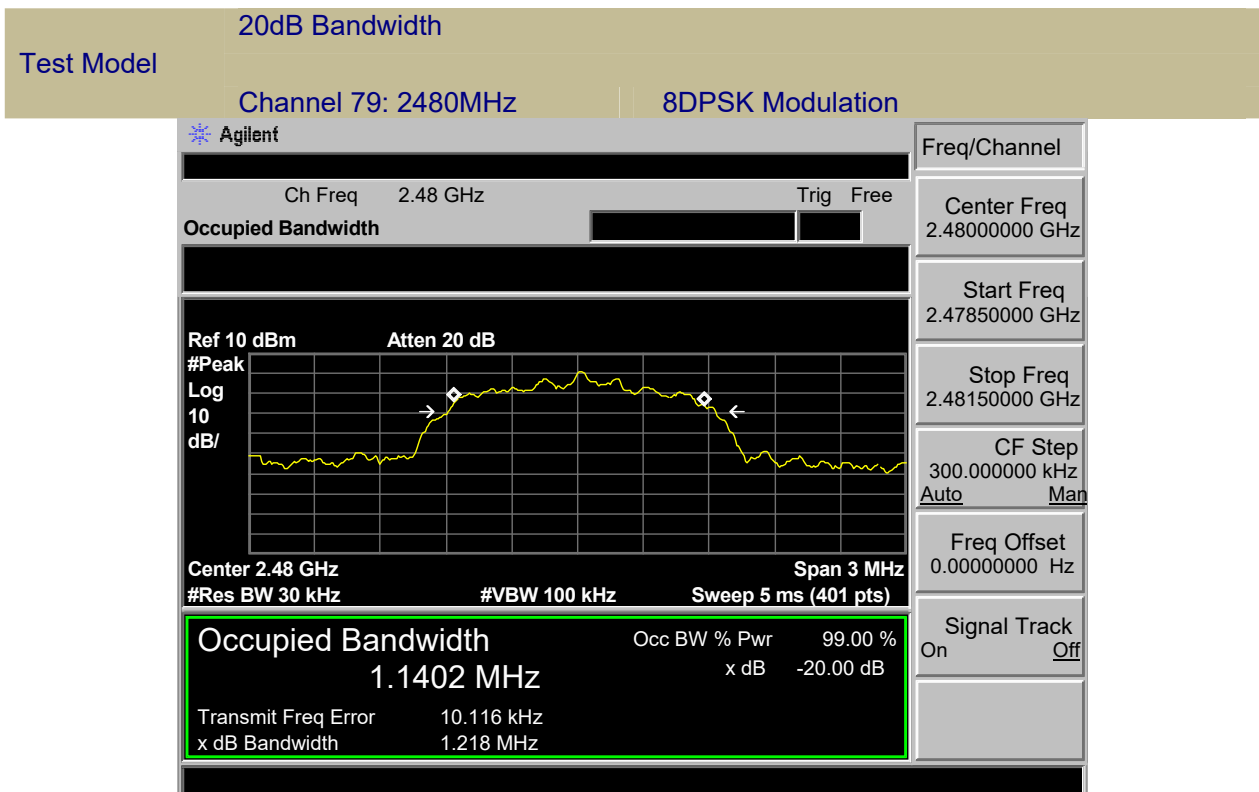
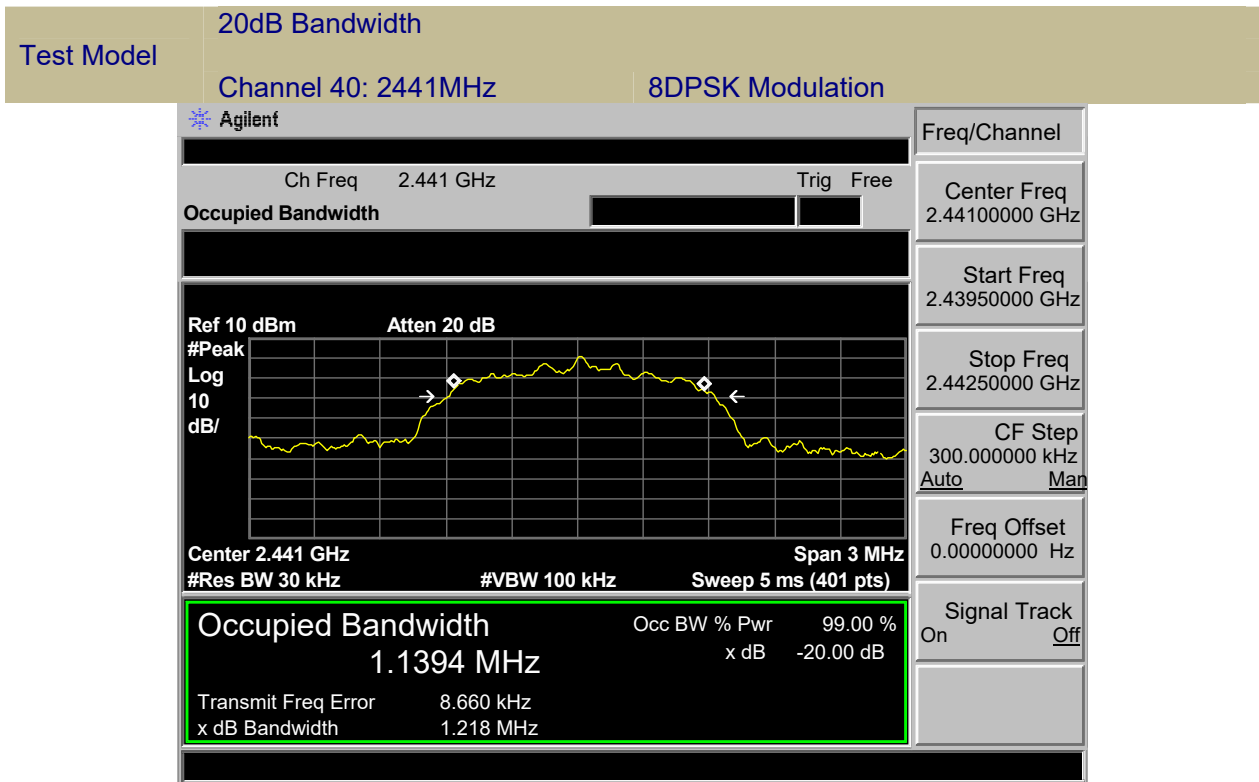

8.2 CARRIER FREQUENCY SEPARATION

8.2.1 Applicable Standard

According to FCC Part 15.247(a)(1) and KDB 558074 D01 15.247 MEAS GUIDANCE v05r02

8.2.2 Conformance Limit

Frequency hopping systems operating in the 2400-2483.5MHz band shall have hopping channel carrier frequencies separated by a minimum of 25kHz or the 20dB bandwidth of the hopping channel, whichever is greater.

In case of an output power less than 125mW, the frequency hopping system may have channels separated by a minimum of 25kHz or two-thirds of the 20dB bandwidth of the hopping channel, whichever is greater.

8.2.3 Test Configuration

Test according to clause 6.1 radio frequency test setup 1

8.2.4 Test Procedure

■ According to FCC Part 15.247(a)(1)

The EUT must have its hopping function enabled. Use the following spectrum analyzer settings:

Set the RBW = 100kHz. Set VBW = 300kHz.

Set the span = wide enough to capture the peaks of two adjacent channels

Set Sweep time = auto couple.

Set Detector = peak. Set Trace mode = max hold.

Allow the trace to stabilize. Use the marker-delta function to determine the separation between the peaks of the adjacent channels. The limit is specified in one of the subparagraphs of this Section. Submit this plot.

Test Results

Temperature:	26° C
Relative Humidity:	54%
ATM Pressure:	1011 mbar

Modulation Mode	Channel Number	Channel Frequency (MHz)	Measurement Bandwidth (MHz)	Limit (MHz)	Verdict
GFSK	1	2402	1.006	0.887	PASS
	40	2441	1.000	0.866	PASS
	79	2480	1.000	0.860	PASS
8DPSK	1	2402	1.000	> 2/3 of the 20dB Bandwidth or 25[kHz](whichever is greater)	PASS
	40	2441	1.013		PASS
	79	2480	1.000		PASS

Note: Limit = 20dB bandwidth * 2/3

Through Pre-scan, find the DH5 of data type is the worst case of GFSK modulation type, 3-DH5 of data type is the worst case of 8DPSK modulation type.

Only the worst case is recorded in the report.

Carrier Frequency Separation
Test Model Channel 1: 2402MHz GFSK Modulation

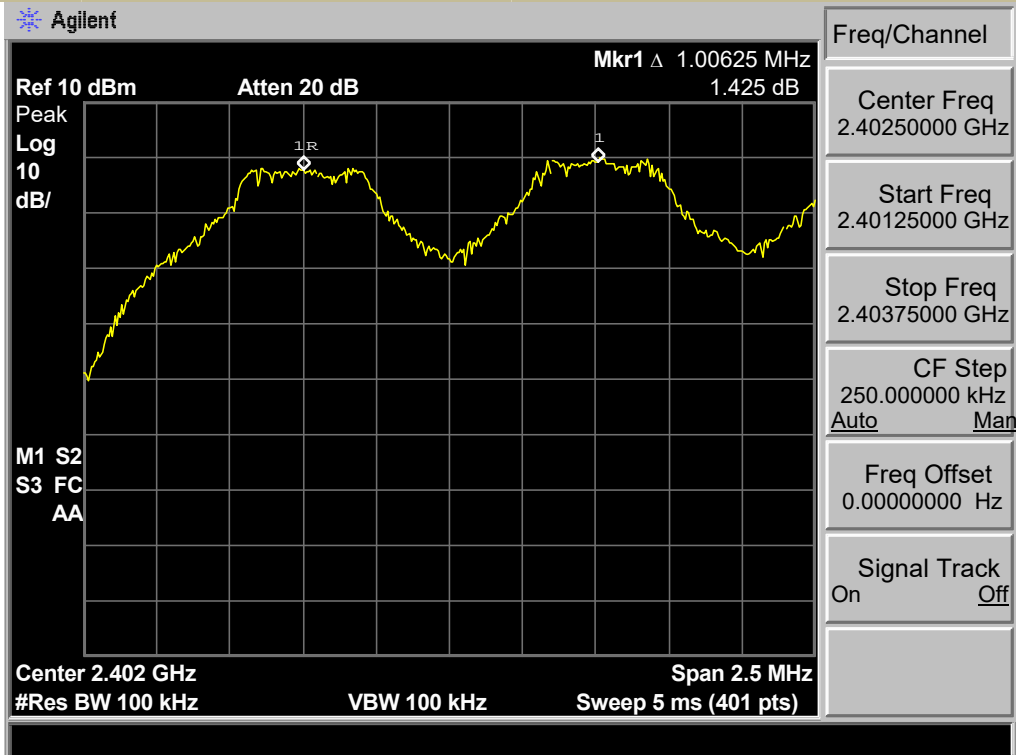

Carrier Frequency Separation
Test Model Channel 40: 2441MHz GFSK Modulation

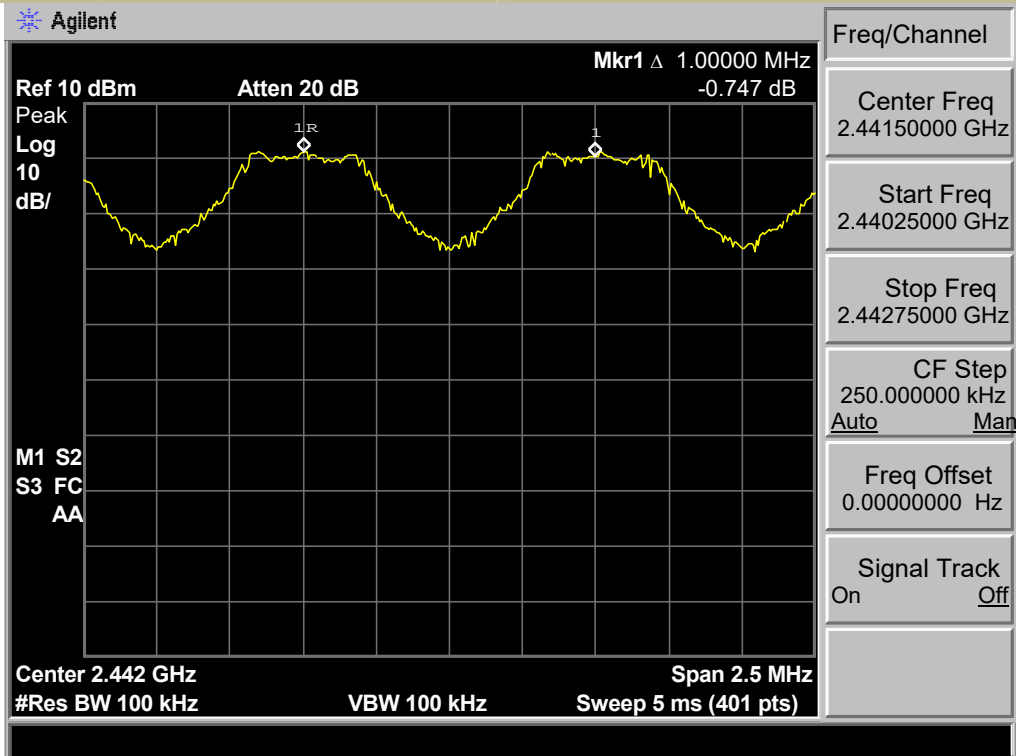

Carrier Frequency Separation

Test Model Channel 79: 2480MHz GFSK Modulation

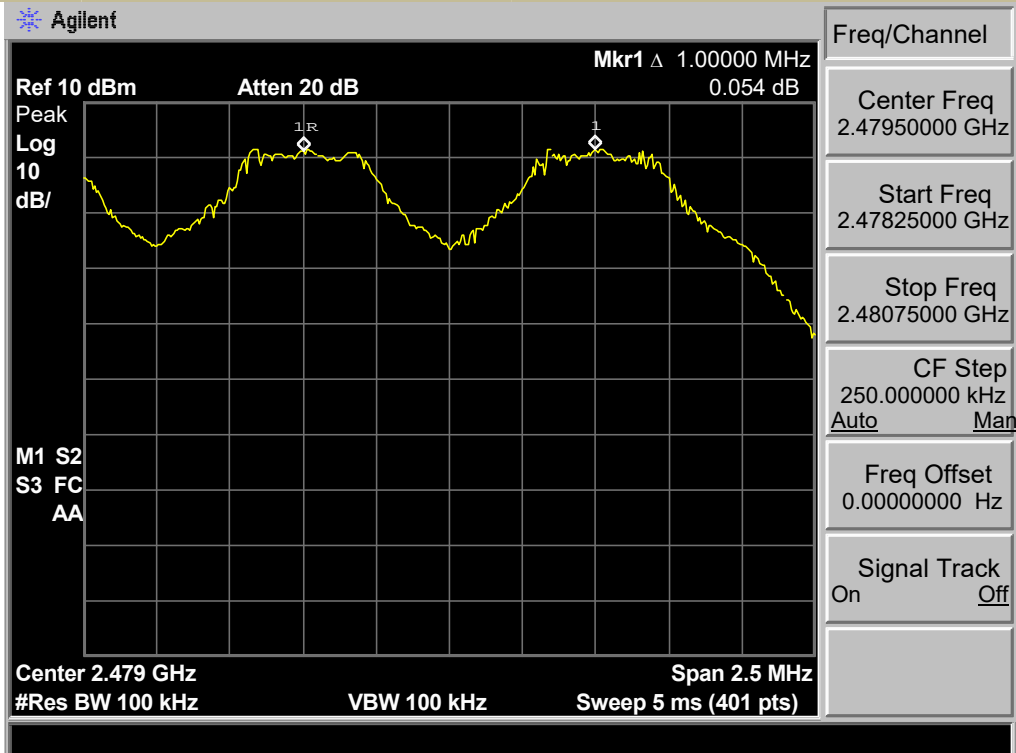

Carrier Frequency Separation

Test Model Channel:1: 2402MHz 8DPSK Modulation

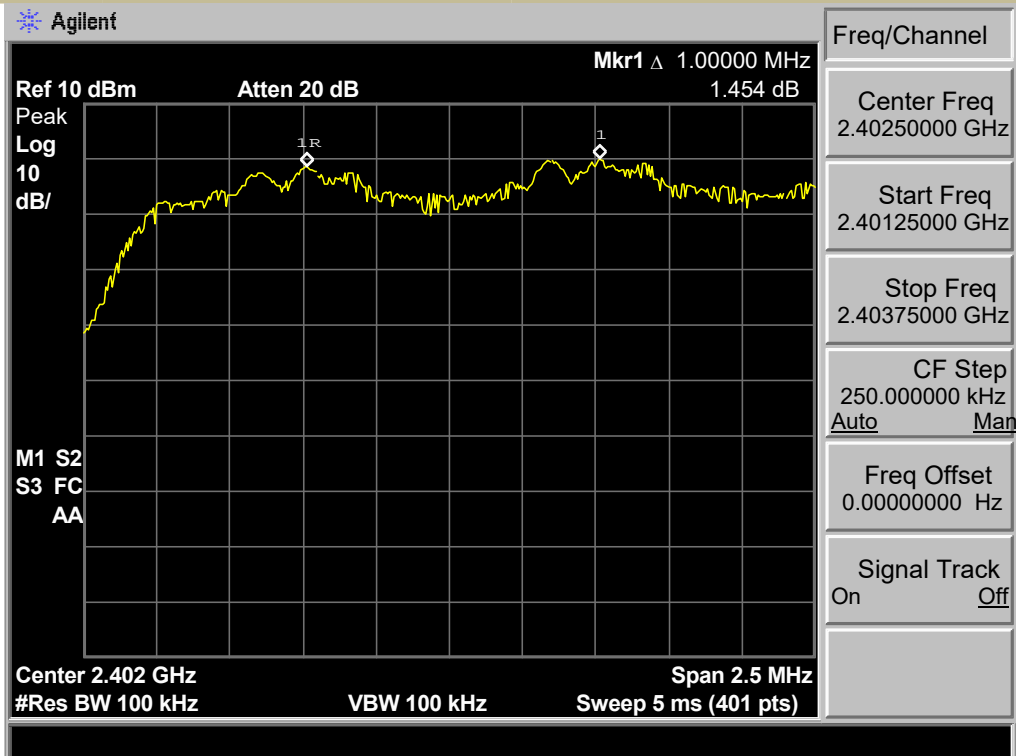

Carrier Frequency Separation
Test Model Channel 40: 2441MHz 8DPSK Modulation

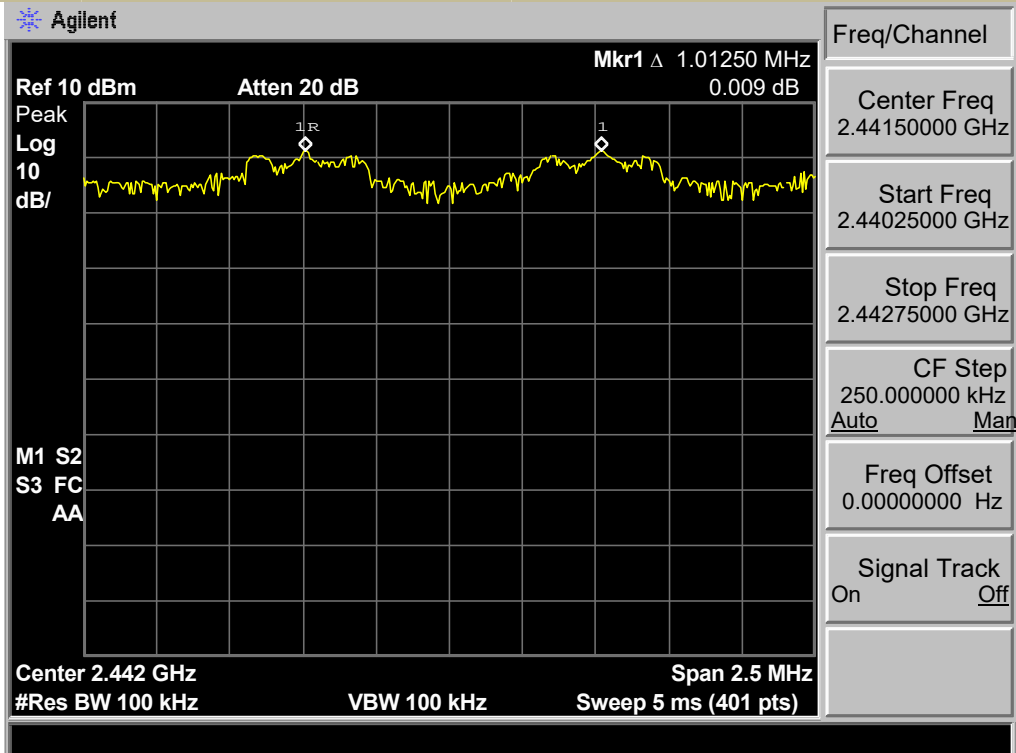

Carrier Frequency Separation
Test Model Channel 79: 2480MHz 8DPSK Modulation

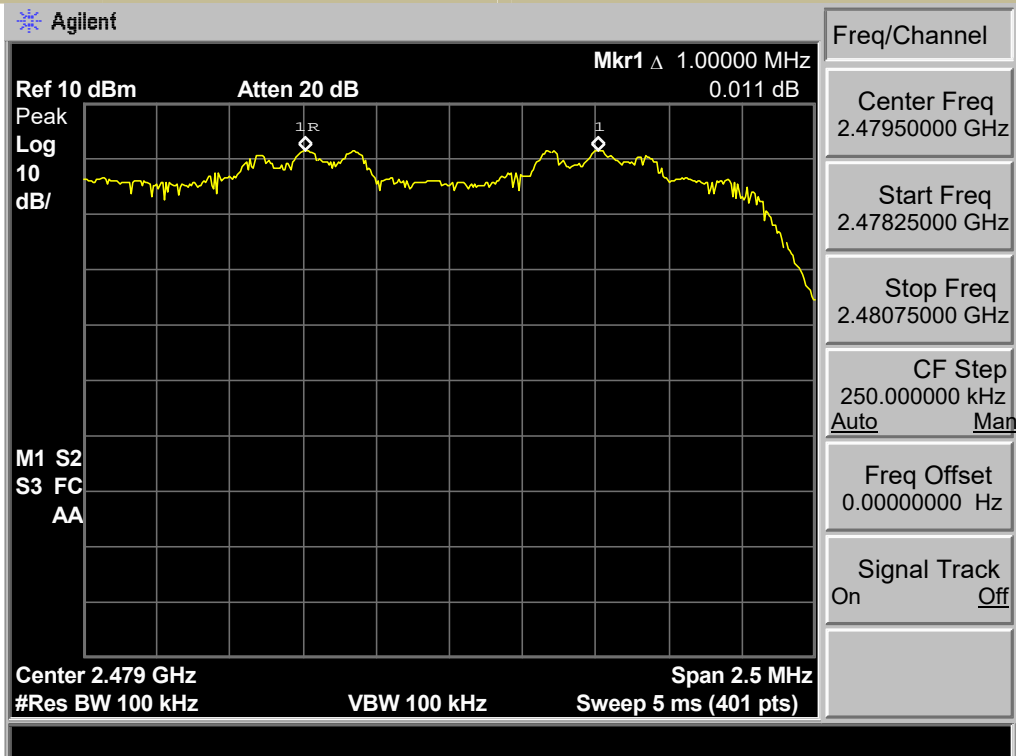

8.3 NUMBER OF HOPPING FREQUENCIES

8.3.1 Applicable Standard

According to FCC Part 15.247(a)(1) (iii) and KDB 558074 D01 15.247 MEAS GUIDANCE v05r02

8.3.2 Conformance Limit

Frequency hopping systems operating in the 2400-2483.5MHz band shall use at least 15 channels.

8.3.3 Test Configuration

Test according to clause 6.1 radio frequency test setup 1

8.3.4 Test Procedure

■ According to FCC Part 15.247(a)(1)(iii)

The EUT must have its hopping function enabled. Use the following spectrum analyzer settings:

Span = the frequency band of operation (2400-2483.5MHz)

RBW \geq 100KHz

VBW \geq RBW

Sweep = auto

Detector function = peak

Trace = max hold

Allow the trace to stabilize. It may prove necessary to break the span up to sections, in order to clearly show all of the hopping frequencies.

Test Results

Temperature:	26° C
Relative Humidity:	54%
ATM Pressure:	1011 mbar

Modulation Mode	Hopping Channel Frequency Range	Quantity of Hopping Channel	Quantity of Hopping Channel limit
GFSK	2402-2480	79	> 15
8DPSK	2402-2480	79	> 15

Through Pre-scan, find the DH5 of data type is the worst case of GFSK modulation type, 3-DH5 of data type is the worst case of 8DPSK modulation type. Only the worst case is recorded in the report.

Test Model GFSK/Hop

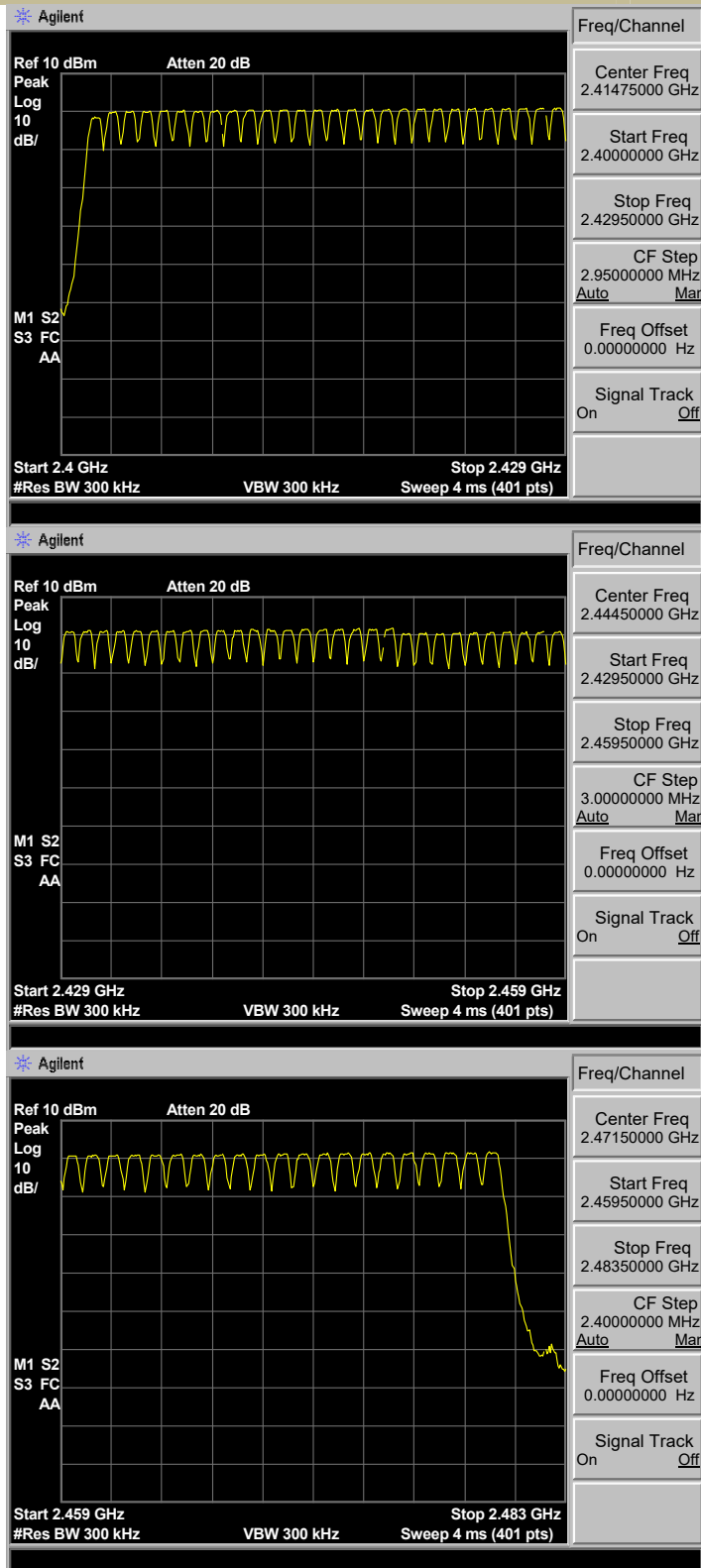

Test Model 8DPSK/Hop

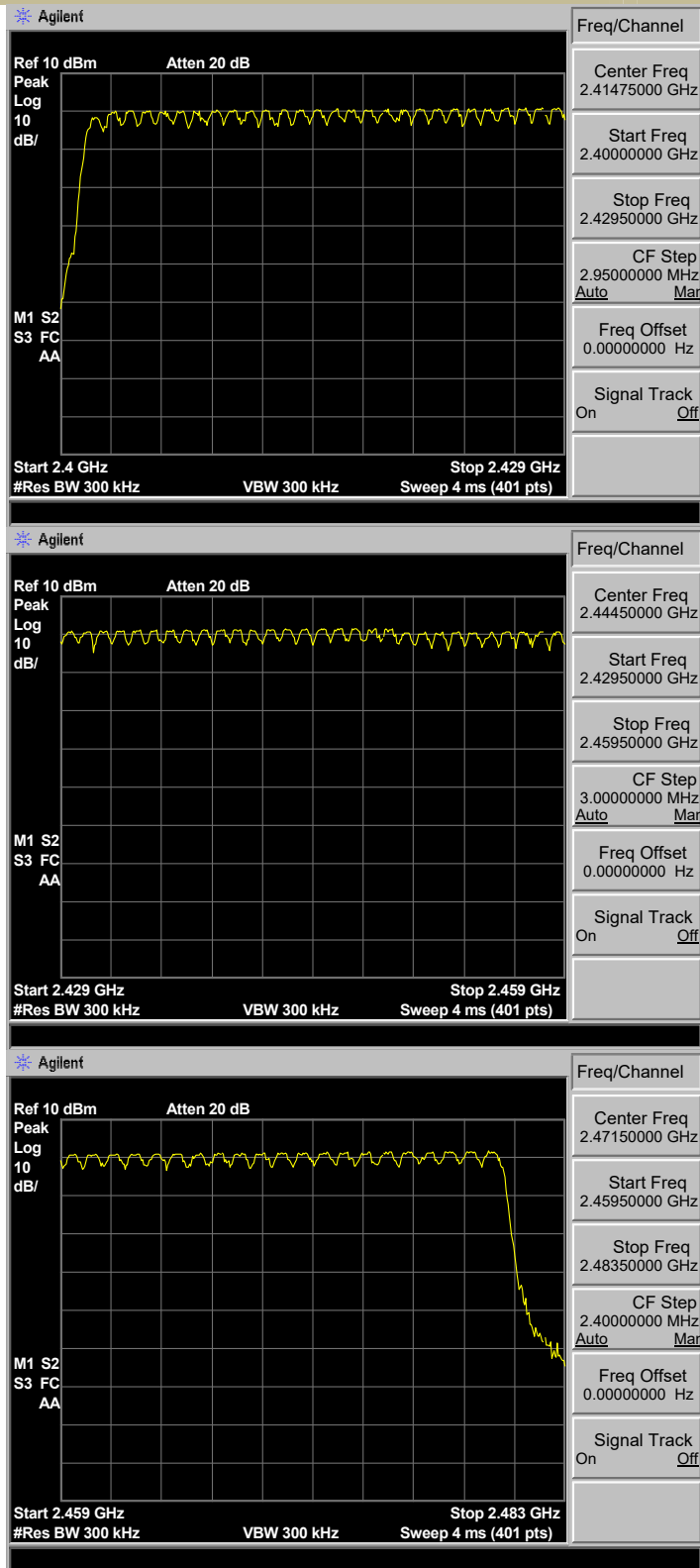

8.4 AVERAGE TIME OF OCCUPANCY (DWELL TIME)

8.4.1 Applicable Standard

According to FCC Part 15.247(a)(1)(iii) and KDB 558074 D01 15.247 MEAS GUIDANCE v05r02

8.4.2 Conformance Limit

For frequency hopping systems operating in the 2400-2483.5MHz band, the average time of occupancy on any channel shall not be greater than 0.4s within a period of 0.4s multiplied by the number of hopping channels employed.

8.4.3 Test Configuration

Test according to clause 6.1 radio frequency test setup 1

8.4.4 Test Procedure

■ According to FCC Part 15.247(a)(1)(iii)

The EUT must have its hopping function enabled. Use the following spectrum analyzer settings:

Span = zero span, centered on a hopping channel

RBW = 1 MHz

VBW \geq RBW

Sweep = as necessary to capture the entire dwell time per hopping channel

Detector function = peak

Trace = max hold

If possible, use the marker-delta function to determine the dwell time. If this value varies with different modes of operation (e.g., data rate, modulation format, etc.),

repeat this test for each variation. The limit is specified in one of the subparagraphs of this Section.

8.4.5 Test Results

Temperature:	26° C
Relative Humidity:	54%
ATM Pressure:	1011 mbar

Measurement Data:

Mode	Dwell time (ms)	Limit	Conclusion
GFSK DH1	144.00	<400ms	PASS
GFSK DH3	278.40	<400ms	PASS
GFSK DH5	318.73	<400ms	PASS
8-DPSK 3DH1	153.60	<400ms	PASS
8-DPSK 3DH3	284.80	<400ms	PASS
8-DPSK 3DH5	316.60	<400ms	PASS

Remark:

GFSK DH1 : $50\text{hop}/5\text{s} * 0.4 * 79 * 0.45\text{ms} = 144.00$

GFSK DH3 : $25\text{hop}/5\text{s} * 0.4 * 79 * 1.74\text{ms} = 278.40$

GFSK DH5 : $17\text{hop}/5\text{s} * 0.4 * 79 * 2.99\text{ms} = 318.73$

8-DPSK 3DH1 : $50\text{hop}/5\text{s} * 0.4 * 79 * 0.48\text{ms} = 153.60$

8-DPSK 3DH3 : $25\text{hop}/5\text{s} * 0.4 * 79 * 1.78\text{ms} = 284.80$

8-DPSK 3DH5 : $17\text{hop}/5\text{s} * 0.4 * 79 * 2.97\text{ms} = 316.60$

Test Model	Average Time Of Occupancy (Dwell Time)	
	CH 0: 2402MHz	GFSK DH1

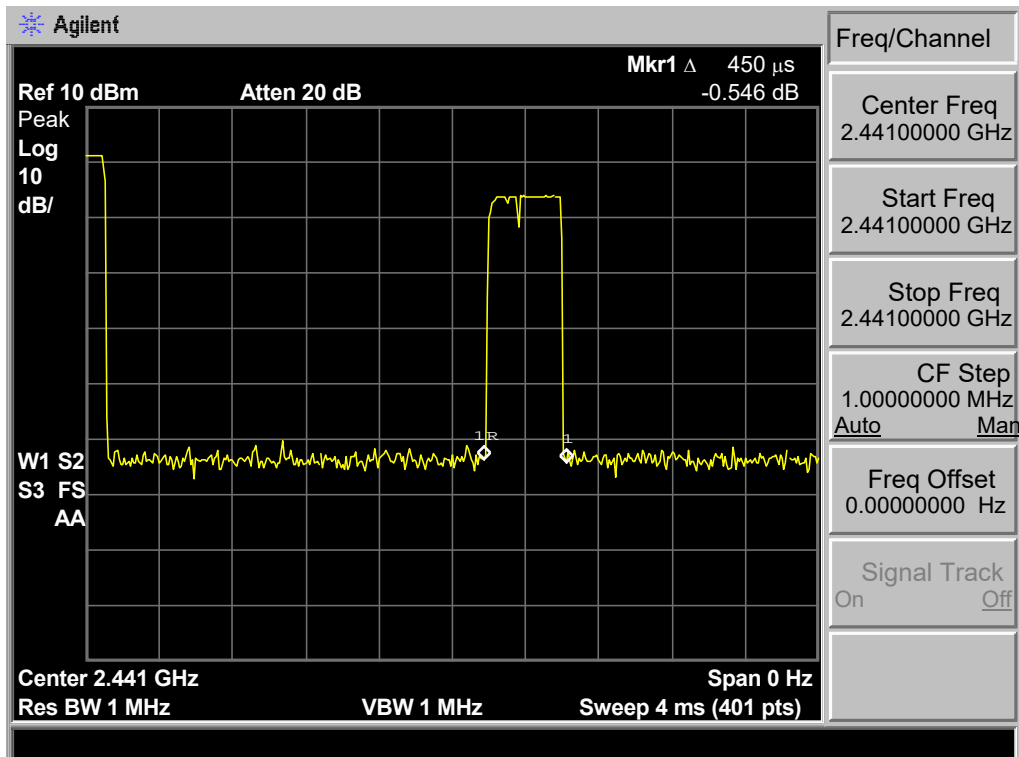
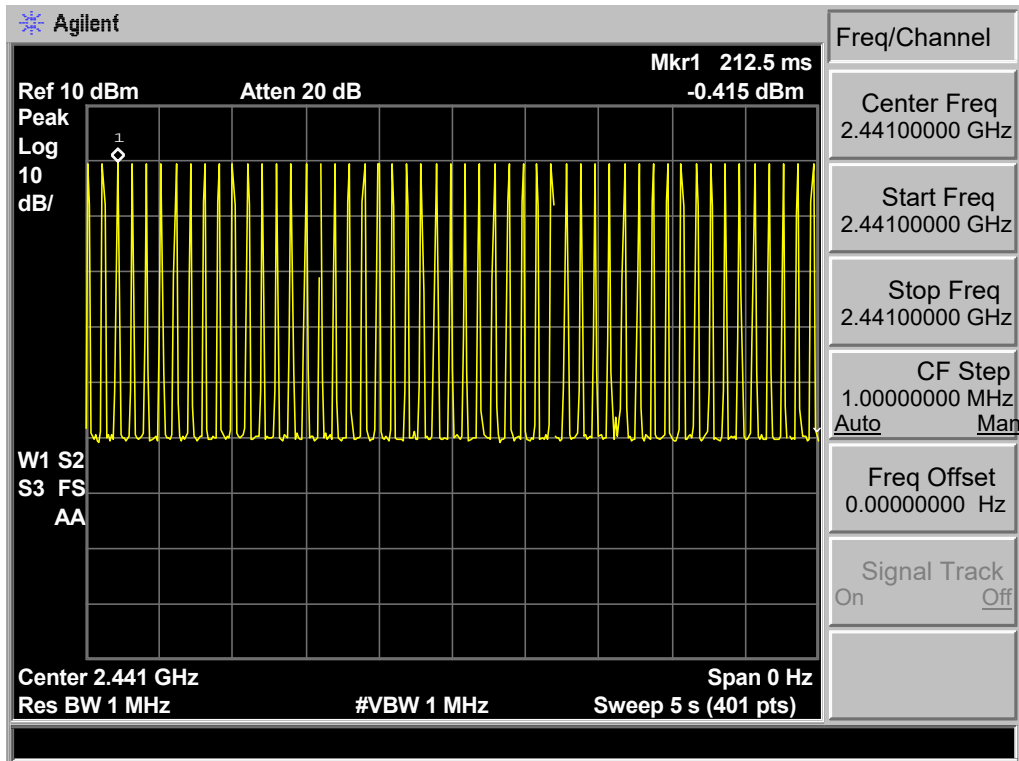

Average Time Of Occupancy (Dwell Time)
Test Model CH 0: 2402MHz GFSK DH3

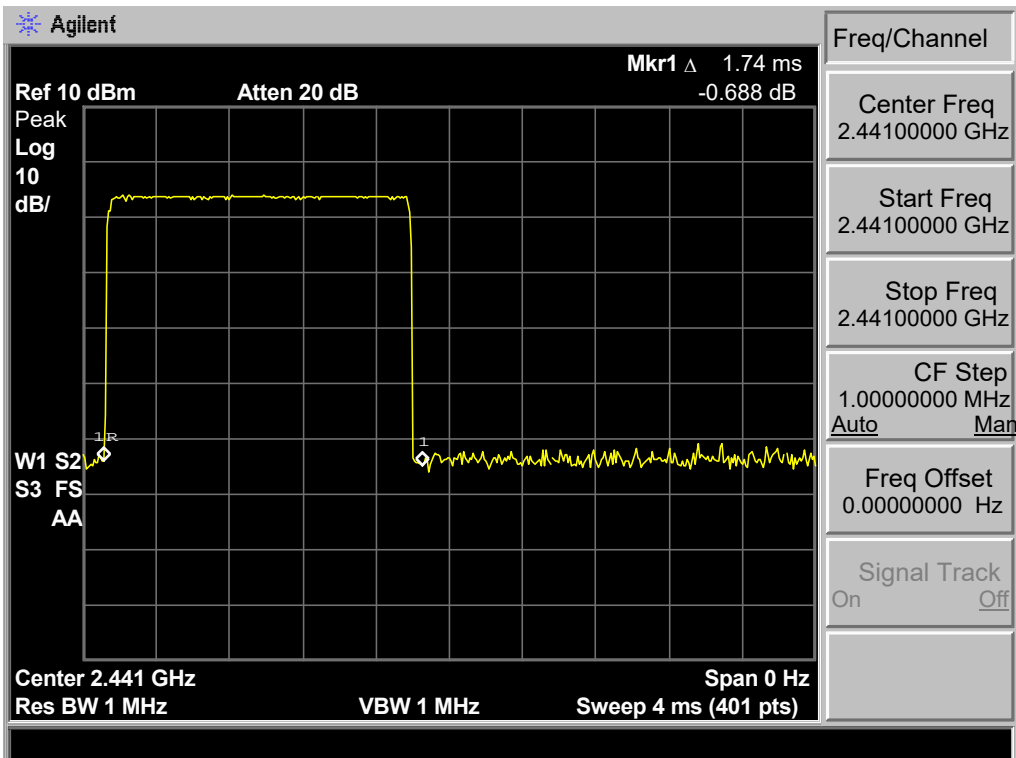
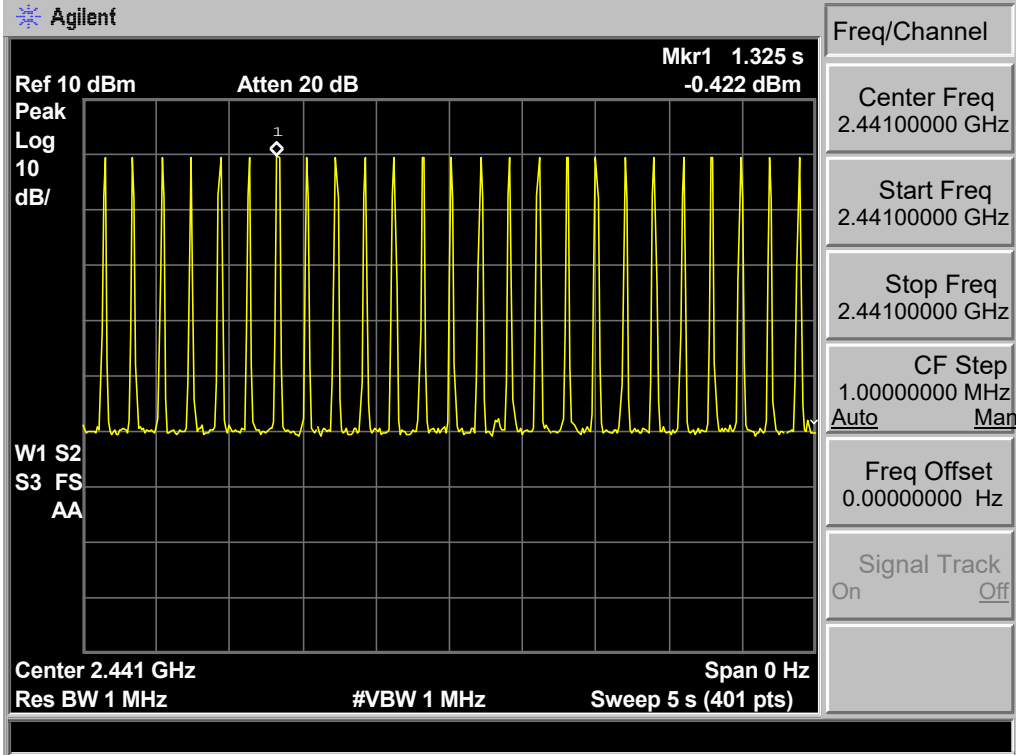

Test Model Average Time Of Occupancy (Dwell Time)
CH 0: 2402MHz GFSK DH5

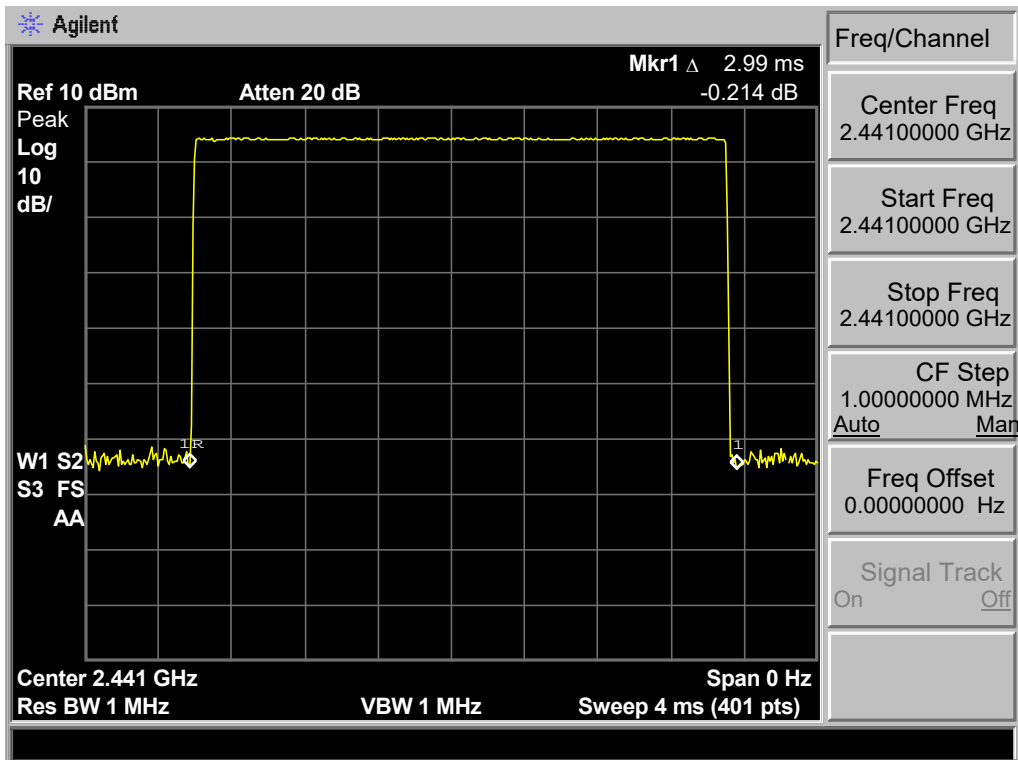
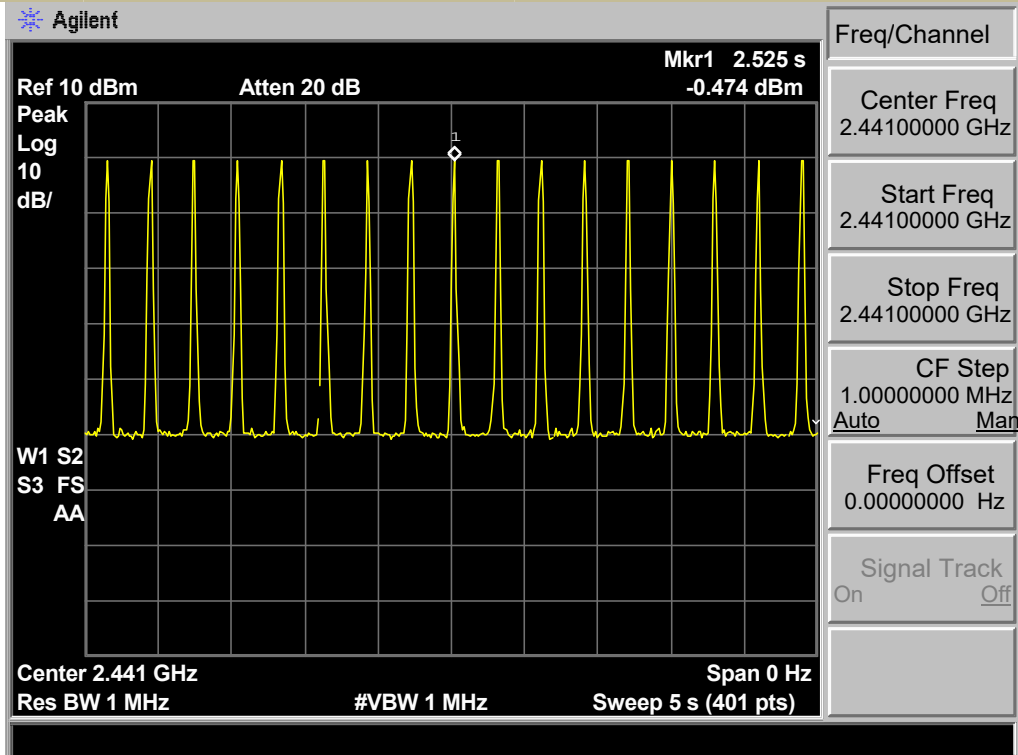

Test Model	Average Time Of Occupancy (Dwell Time)		
	CH 0: 2402MHz	8DPSK	3DH1

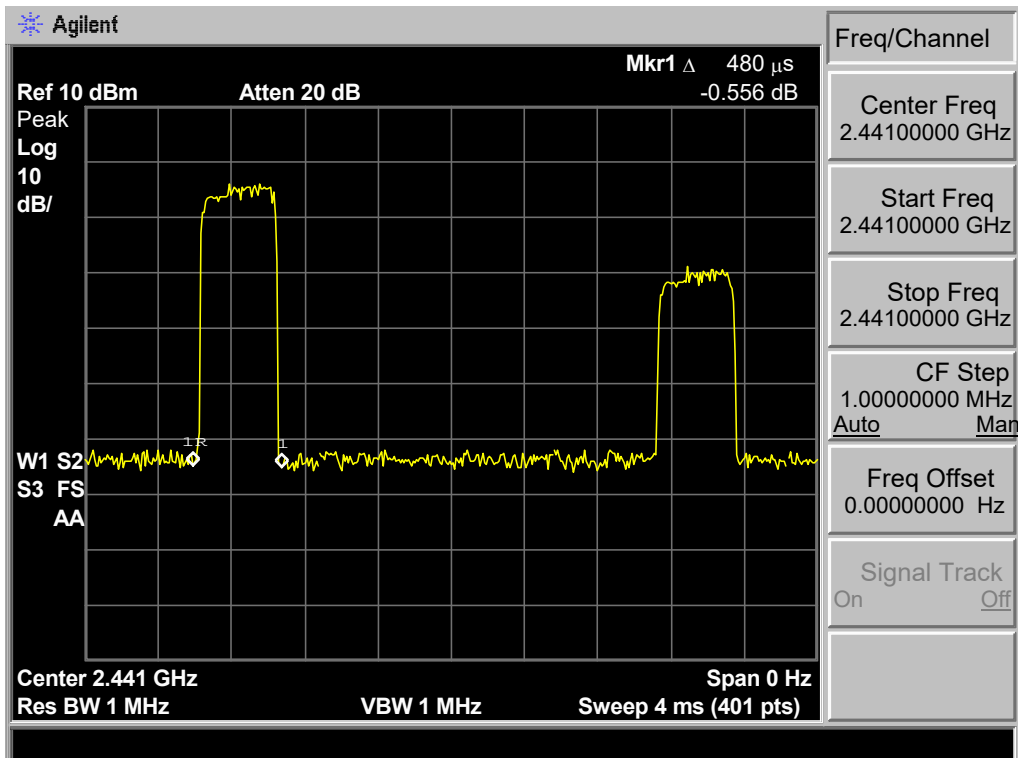
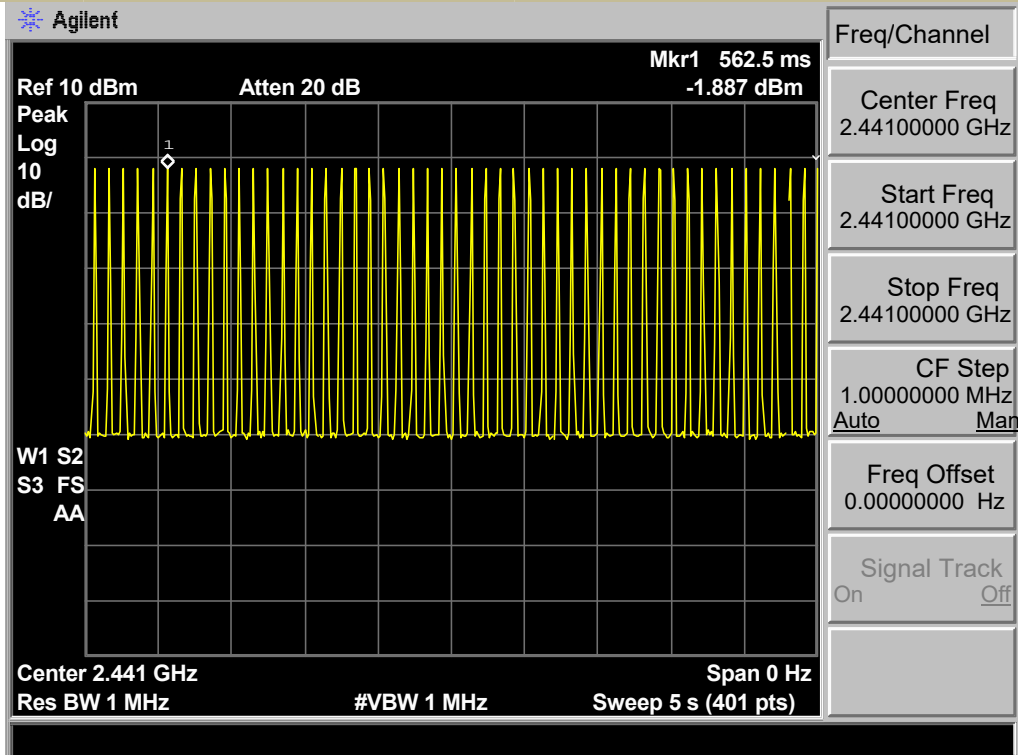

Average Time Of Occupancy (Dwell Time)
Test Model CH 0: 2402MHz 8DPSK 3DH3

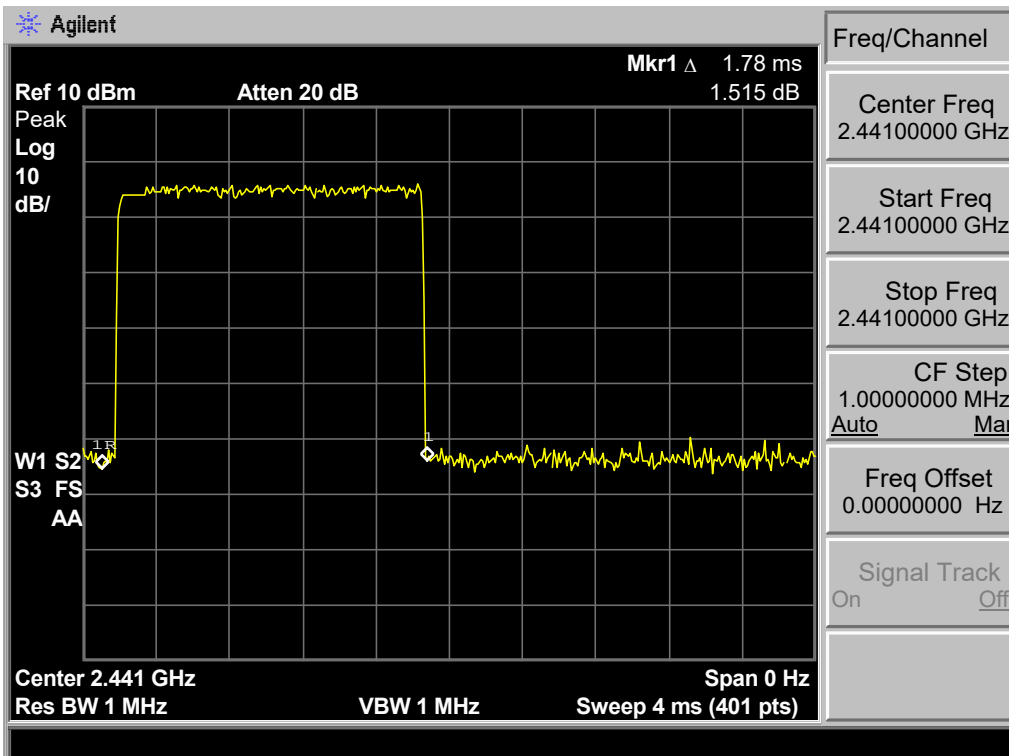
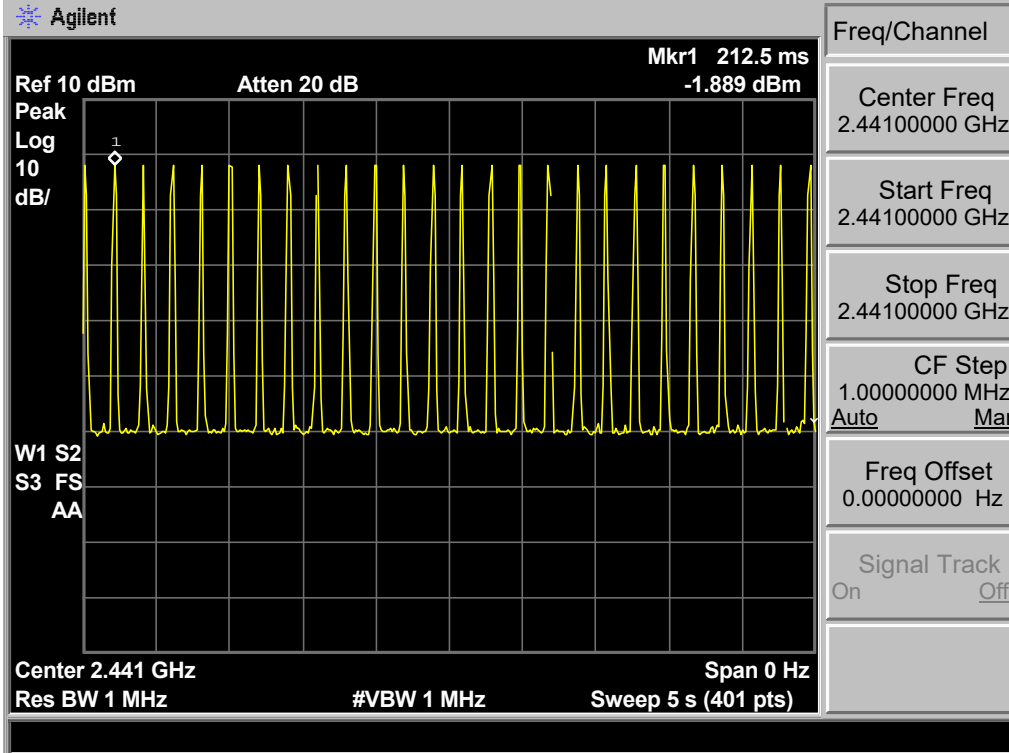

Test Model	Average Time Of Occupancy (Dwell Time)		
	CH 0: 2402MHz	8DPSK	3DH5

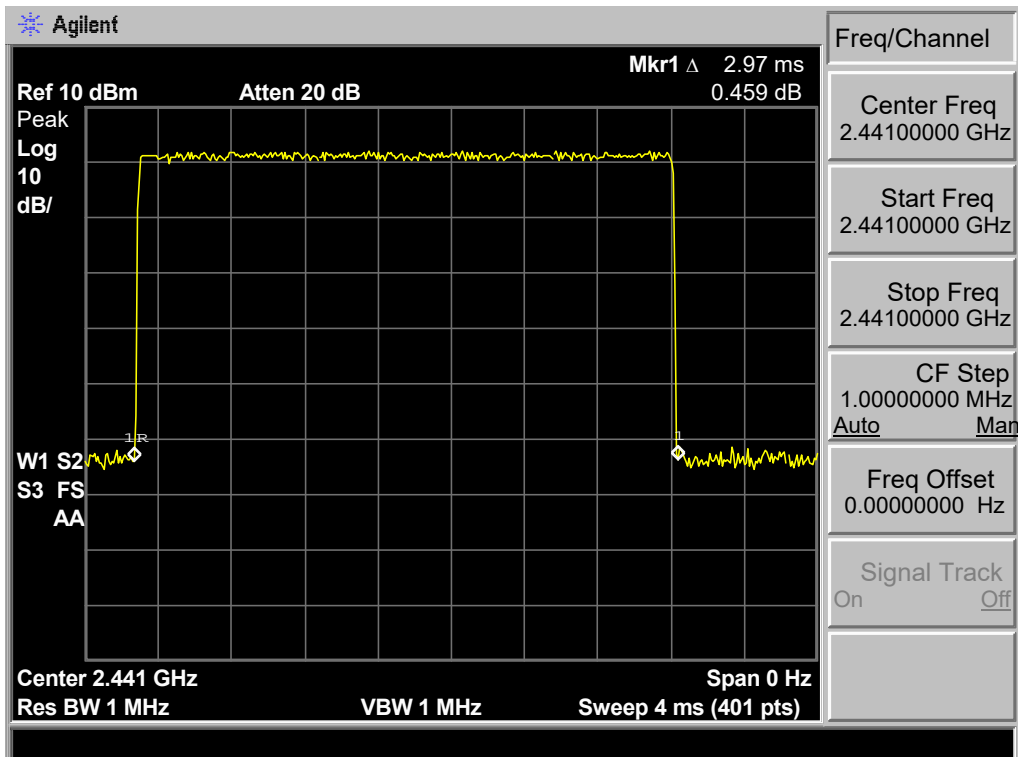
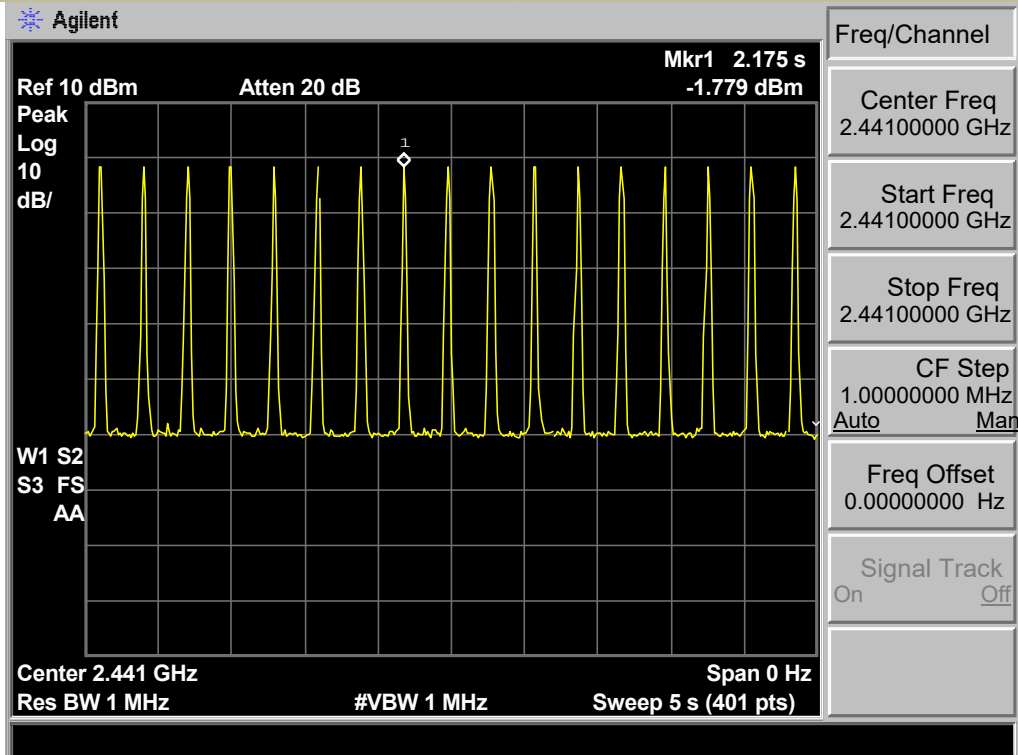

8.5 MAXIMUM PEAK CONDUCTED OUTPUT POWER

8.5.1 Applicable Standard

According to FCC Part 15.247(b)(1) and KDB 558074 D01 15.247 MEAS GUIDANCE v05r02

8.5.2 Conformance Limit

The max For frequency hopping systems operating in the 2400-2483.5 MHz band employing at least 75 non-overlapping hopping channels: 1 watt. For all other frequency hopping systems in the 2400-2483.5 MHz band: 0.125 watts.

8.5.3 Test Configuration

Test according to clause 6.1 radio frequency test setup 1

8.5.4 Test Procedure

■ According to FCC Part15.247(b)(1)

As an alternative to a peak power measurement, compliance with the limit can be based on a measurement of the maximum conducted output power.

Use the following spectrum analyzer settings:

Set Span = approximately 5 times the 20 dB bandwidth, centered on a hopping channel (about 10MHz)

Set RBW > the 20 dB bandwidth of the emission being measured (about 3MHz)

Set VBW ≥ RBW

Set Sweep = auto

Set Detector function = peak

Set Trace = max hold

Allow the trace to stabilize. Use the marker-to-peak function to set the marker to the peak of the emission to determine the peak amplitude level.

Test Results

Temperature:	26° C
Relative Humidity:	54%
ATM Pressure:	1011 mbar

Operation Mode	Channel Number	Channel Frequency (MHz)	Measurement Level (dBm)	Limit (dBm)	Verdict
GFSK	1	2402	-1.535	30	PASS
	40	2441	0.778	30	PASS
	79	2480	1.374	30	PASS
8DPSK	1	2402	-1.368	30	PASS
	40	2441	1.072	30	PASS
	79	2480	1.685	30	PASS

Note: N/A

Through Pre-scan, find the DH5 of data type is the worst case of GFSK modulation type, 3-DH5 of data type is the worst case of 8DPSK modulation type. Only the worst case is recorded in the report.

Maximum Peak Conducted Output Power
Test Model Channel 1: 2402MHz GFSK

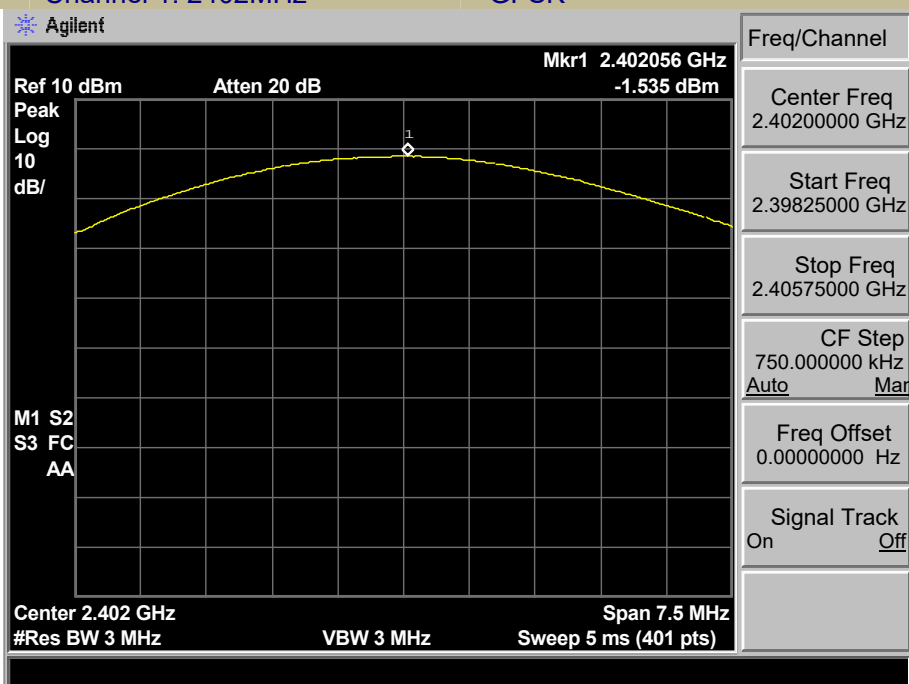

Maximum Peak Conducted Output Power
Test Model Channel 40: 2441MHz GFSK

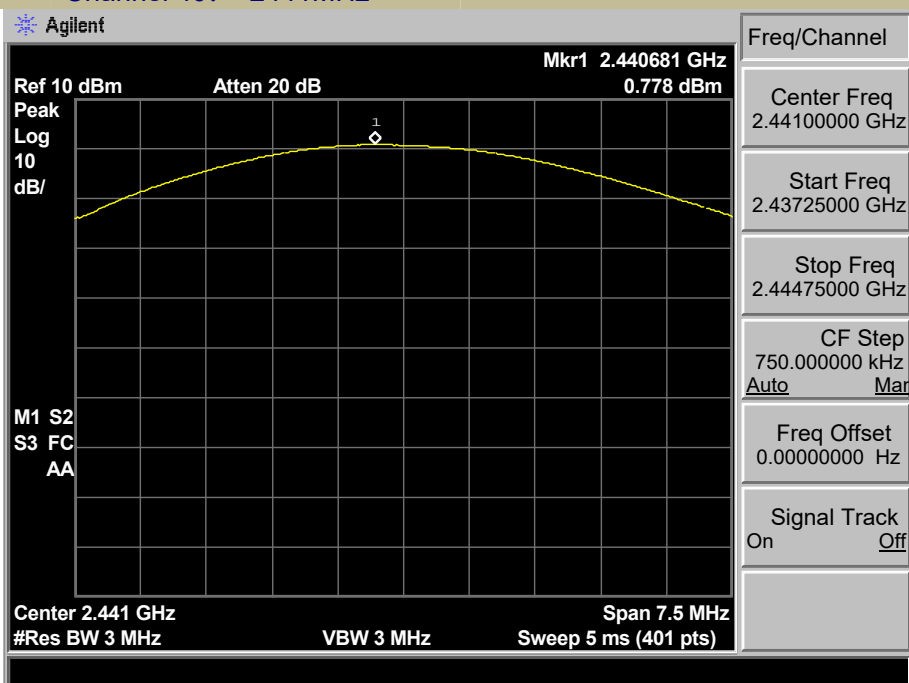

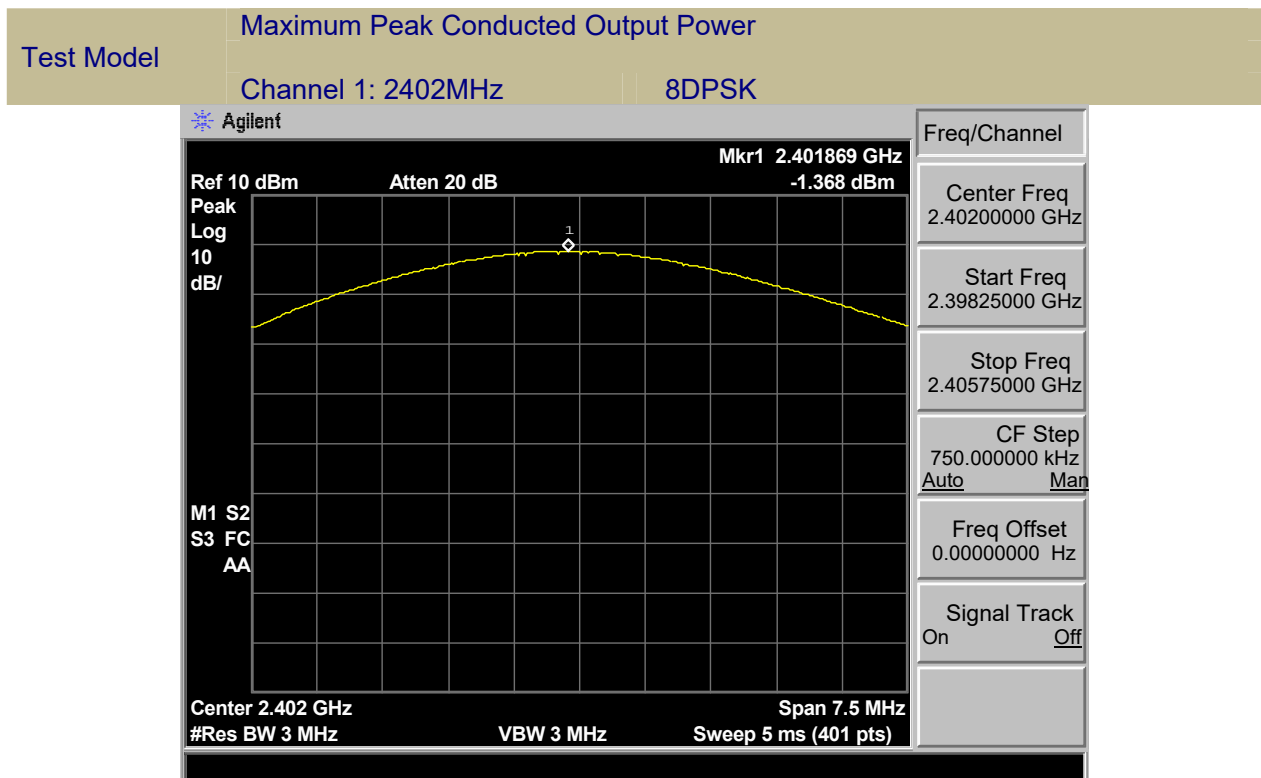
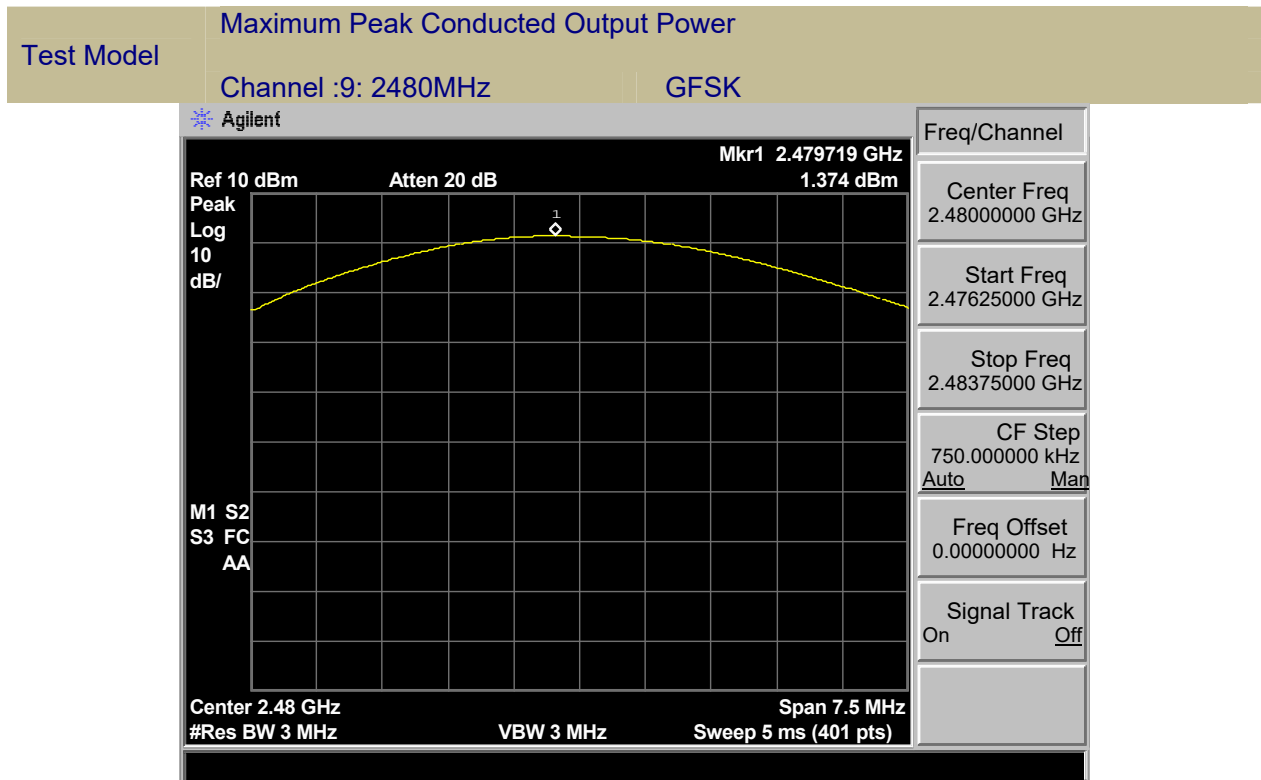

Test Model Maximum Peak Conducted Output Power
Channel 40: 2441MHz 8DPSK

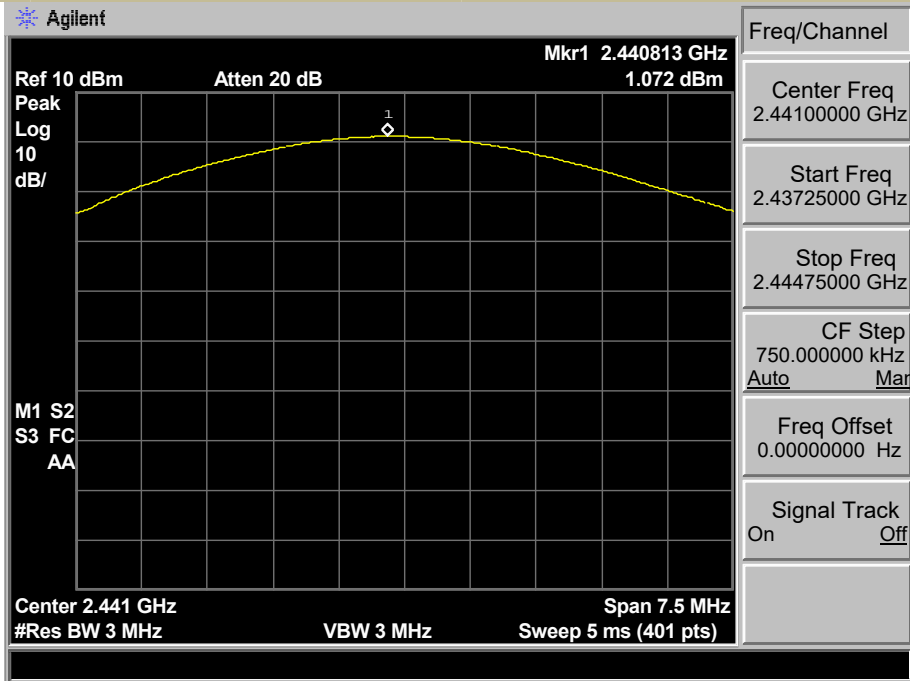

Test Model Maximum Peak Conducted Output Power
Bluetooth V4.0
Channel 79: 2480MHz 8DPSK

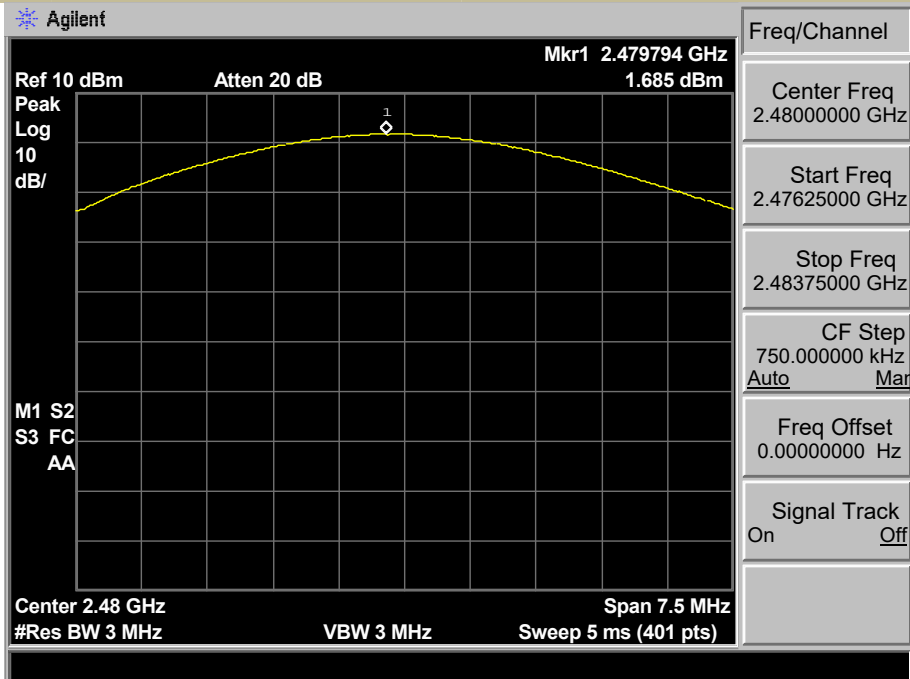

8.6 RADIATED SPURIOUS EMISSION

8.6.1 Applicable Standard

According to FCC Part 15.247(d) and 15.209 and KDB 558074 D01 15.247 MEAS GUIDANCE v05r02

8.6.2 Conformance Limit

According to FCC Part 15.247(d): radiated emissions which fall in the restricted bands, as defined in §15.205(a), must also comply with the radiated emission limits specified in §15.209(a) (see §15.205(c)).

According to FCC Part 15.205, Restricted bands

MHz	MHz	MHz	GHz
0.090-0.110	16.42-16.423	399.9-410	4.5-5.15
10.495-0.505	16.69475-16.69525	608-614	5.35-5.46
2.1735-2.1905	16.80425-16.80475	960-1240	7.25-7.75
4.125-4.128	25.5-25.67	1300-1427	8.025-8.5
4.17725-4.17775	37.5-38.25	1435-1626.5	9.0-9.2
4.20725-4.20775	73-74.6	1645.5-1646.5	9.3-9.5
6.215-6.218	74.8-75.2	1660-1710	10.6-12.7
6.26775-6.26825	123-138	2200-2300	14.47-14.5
8.291-8.294	149.9-150.05	2310-2390	15.35-16.2
8.362-8.366	156.52475-156.52525	2483.5-2500	17.7-21.4
8.37625-8.38675	156.7-156.9	2690-2900	22.01-23.12
8.41425-8.41475	162.0125-167.17	3260-3267	23.6-24.0
12.29-12.293	167.72-173.2	3332-3339	31.2-31.8
12.51975-12.52025	240-285	3345.8-3358	36.43-36.5
12.57675-12.57725	322-335.4	3600-4400	(2)
13.36-13.41			

According to FCC Part 15.205, the level of any transmitter spurious emission in Restricted bands shall not exceed the level of the emission specified in the following table

Restricted Frequency(MHz)	Field Strength ($\mu\text{V}/\text{m}$)	Field Strength ($\text{dB}\mu\text{V}/\text{m}$)	Measurement Distance
0.009-0.490	2400/F(KHz)	20 log ($\mu\text{V}/\text{m}$)	300
0.490-1.705	24000/F(KHz)	20 log ($\mu\text{V}/\text{m}$)	30
1.705-30	30	29.5	30
30-88	100	40	3
88-216	150	43.5	3
216-960	200	46	3
Above 960	500	54	3

8.6.3 Test Configuration

Test according to clause 7.2 radio frequency test setup 2

8.6.4 Test Procedure

This test is required for any spurious emission that falls in a Restricted Band, as defined in Section 15.205. It must be performed with the highest gain of each type of antenna proposed for use with the EUT. Use the following spectrum analyzer settings:

For Above 1GHz:

The EUT was placed on a turn table which is 1.5m above ground plane.

Maximum procedure was performed on the highest emissions to ensure EUT compliance.

Span = wide enough to fully capture the emission being measured

RBW = 1 MHz

VBW \geq RBW

Sweep = auto

Detector function = peak

Trace = max hold

For Below 1GHz:

The EUT was placed on a turn table which is 0.8m above ground plane.

Maximum procedure was performed on the highest emissions to ensure EUT compliance.

Span = wide enough to fully capture the emission being measured

RBW = 100 kHz for

VBW \geq RBW

Sweep = auto

Detector function = peak

Trace = max hold

For Below 30MHz:

The EUT was placed on a turn table which is 0.8m above ground plane.

Maximum procedure was performed on the highest emissions to ensure EUT compliance.

Span = wide enough to fully capture the emission being measured

RBW = 9kHz

VBW \geq RBW

Sweep = auto

Detector function = peak

Trace = max hold

For Below 150KHz:

The EUT was placed on a turn table which is 0.8m above ground plane.

Maximum procedure was performed on the highest emissions to ensure EUT compliance.

Span = wide enough to fully capture the emission being measured

RBW = 200Hz

VBW \geq RBW

Sweep = auto

Detector function = peak

Trace = max hold

Follow the guidelines in ANSI C63.10-2013 with respect to maximizing the emission by rotating the EUT, measuring the emission while the EUT is situated in three orthogonal planes (if appropriate), adjusting the measurement antenna height and polarization, etc. A pre-amp and a high pass filter are required for this test, in order to provide the measuring system with sufficient sensitivity. Allow the trace to stabilize. The peak reading of the emission, after being corrected by the antenna factor, cable loss, pre-amp gain, etc., is the peak field strength, which must comply with the limit specified in Section 15.35(b). Submit this data.

Now set the VBW to 10 Hz, while maintaining all of the other instrument settings. This peak level, once corrected, must comply with the limit specified in Section 15.209. If the dwell time per channel of the hopping signal is less than 100 ms, then the reading obtained with the 10 Hz VBW may be further adjusted by a "duty cycle correction factor", derived from $20\log(\text{dwell time}/100 \text{ ms})$, in an effort to demonstrate compliance with the 15.209 limit. Submit this data.

Repeat above procedures until all frequency measured was complete.

8.6.5 Test Results

■ Spurious Emission below 30MHz (9KHz to 30MHz)

Temperature:	26° C
Relative Humidity:	54%
ATM Pressure:	1011 mbar

Freq. (MHz)	Ant.Pol. H/V	Emission Level(dBuV/m)		Limit 3m(dBuV/m)		Over(dB)	
		PK	AV	PK	AV	PK	AV
--	--	--	--	--	--	--	--

Note: the amplitude of spurious emission that is attenuated by more than 20dB below the permissible limit has no need to be reported.

Distance extrapolation factor = $40 \log(\text{Specific distance} / \text{test distance})$ (dB);

Limit line = Specific limits(dBuV) + distance extrapolation factor

■ Spurious Emission Above 1GHz (1GHz to 25GHz)

(worst case. Pretest the EUT at Transmitting mode and Charge + Transmitting mode, found the Charge + Transmitting mode which it is worse case

For below 1GHz part, through pre-scan, the worst case is the lowest channel.

Only the worst case is recorded in the report.):

Worse case mode:		GFSK(DH5)		Test channel:		Lowest	
Frequency	Meter Reading	Factor	Emission Level	Limits	Over	Detector Type	Ant. Pol.
(MHz)	(dB μ V)	(dB)	(dB μ V/m)	(dB μ V/m)	(dB)		H/V
4804	53.04	-4.33	48.71	74	-25.29	Peak	H
7206	50.58	1.01	51.59	74	-22.41	Peak	H
4804	52.35	-4.33	48.02	74	-25.98	Peak	V
7206	49.47	1.01	50.48	74	-23.52	Peak	V

Worse case mode:		GFSK(DH5)		Test channel:		Middle	
Frequency	Meter Reading	Factor	Emission Level	Limits	Over	Detector Type	Ant. Pol.
(MHz)	(dB μ V)	(dB)	(dB μ V/m)	(dB μ V/m)	(dB)		H/V
4882	50.69	-4.11	46.58	74	-27.42	peak	H
7323	48.89	1.51	50.40	74	-23.60	peak	H
4882	51.75	-4.11	47.64	74	-26.36	peak	V
7323	49.94	1.51	51.45	74	-22.55	peak	V

Worse case mode:		GFSK(DH5)		Test channel:		Highest	
Frequency	Meter Reading	Factor	Emission Level	Limits	Over	Detector Type	Ant. Pol.
(MHz)	(dB μ V)	(dB)	(dB μ V/m)	(dB μ V/m)	(dB)		H/V
4960	49.80	-4.04	45.76	74	-28.24	Peak	H
7440	49.60	1.57	51.17	74	-22.83	Peak	H
4960	49.16	-4.04	45.12	74	-28.88	Peak	V
7440	48.97	1.57	50.54	74	-23.46	Peak	V

Worse case mode:		8DPSKDH5)		Test channel:		Lowest	
Frequency	Meter Reading	Factor	Emission Level	Limits	Over	Detector	Ant. Pol.
(MHz)	(dB μ V)	(dB)	(dB μ V/m)	(dB μ V/m)	(dB)	Type	H/V
4804	59.63	-4.12	55.51	74	-18.49	peak	H
4804	46.01	-4.12	41.89	54	-12.11	AVG	H
7206	51.23	1.46	52.69	74	-21.31	peak	H
7206	37.66	1.46	39.12	54	-14.88	AVG	H
4804	60.36	-4.12	56.24	74	-17.76	peak	V
4804	50.01	-4.12	45.89	54	-8.11	AVG	V
7206	49.11	1.46	50.57	74	-23.43	peak	V
7206	39.86	1.46	38.40	54	-15.60	AVG	V

Worse case mode:		8DPSKDH5)		Test channel:		Middle	
Frequency	Meter Reading	Factor	Emission Level	Limits	Over	Detector	Ant. Pol.
(MHz)	(dB μ V)	(dB)	(dB μ V/m)	(dB μ V/m)	(dB)	Type	H/V
4882	61.03	-4.03	57.00	74	-17.00	peak	H
4882	50.45	-4.03	46.42	54	-7.58	AVG	H
7323	53.06	1.66	54.72	74	-19.28	peak	H
7323	40.04	1.66	41.70	54	-12.30	AVG	H
4882	59.99	-4.03	55.96	74	-18.04	peak	V
4882	42.86	-4.03	38.83	54	-15.17	AVG	V
7323	48.69	1.66	50.35	74	-23.65	peak	V
7323	36.40	1.66	38.06	54	-15.94	AVG	V

Worse case mode:		8DPSKDH5)		Test channel:		Highest	
Frequency	Meter Reading	Factor	Emission Level	Limits	Over	Detector	Ant. Pol.
(MHz)	(dBμV)	(dB)	(dBμV/m)	(dBμV/m)	(dB)	Type	H/V
4960	61.39	-4.26	57.13	74	-16.87	peak	H
4960	49.77	-4.26	45.51	54	-8.49	AVG	H
7440	53.11	1.18	54.29	74	-19.71	peak	H
7440	42.01	1.18	43.19	54	-10.81	AVG	H
4960	60.96	-4.26	56.70	74	-17.30	peak	V
4960	46.79	-4.26	42.53	54	-11.47	AVG	V
7440	51.33	1.18	52.51	74	-21.49	peak	V
7440	39.66	1.18	40.84	54	-13.16	AVG	V

Remark:

- 1) The field strength is calculated by adding the Antenna Factor, Cable Factor & Preamplifier. The basic equation with a sample calculation is as follows:

Final Test Level = Receiver Reading + Antenna Factor + Cable Factor – Preamplifier Factor

- 2) Scan from 9kHz to 25GHz, the disturbance above 10GHz and below 30MHz was very low. As shown in this section, for frequencies above 1GHz, the field strength limits are based on average limits. However, the peak field strength of any emission shall not exceed the maximum permitted average limits specified above by more than 20 dB under any condition of modulation. So, only the peak measurements were shown in the report.

Spurious Emission in Restricted Band 2310-2390MHz and 2483.5-2500MHz was report as below:

Test mode: GFSK(DH5)	2402MHz	Test channel:	Lowest	Polarization	Horizontal
No Hopping					

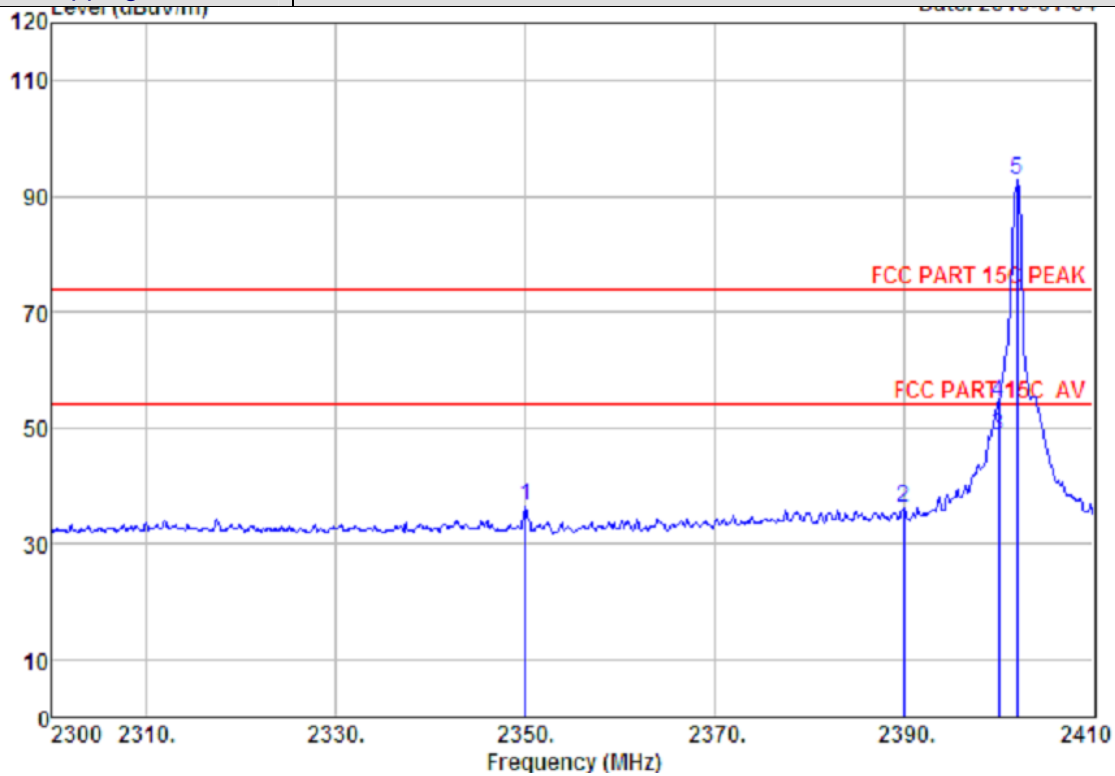

	Freq. (MHz)	Ant. Factor (dB/m)	Cable Loss (dB)	Amp Factor (dB)	Reading (dBuV)	Emission Level (dBuV/m)	Limits (dBuV/m)	Margin (dB)	Remark
1	2350.05	27.70	6.56	34.57	36.74	36.43	74.00	37.57	Peak
2	2390.00	27.64	6.62	34.62	36.60	36.24	74.00	37.76	Peak
3	2400.00	27.61	6.62	34.64	49.01	48.60	54.00	5.40	Average
4	2400.00	27.61	6.62	34.64	54.93	54.52	74.00	19.48	Peak
5	2402.00	27.61	6.62	34.64	93.33	92.92	74.00	-18.92	Peak

Remarks: 1. Emission Level= Antenna Factor + Cable Loss - Amp Factor + Reading.
2. The emission levels that are 20dB below the official limit are not reported.

Test mode: GFSK(DH5)	2402MHz	Test channel:	Lowest	Polarization	vertical
No Hopping					

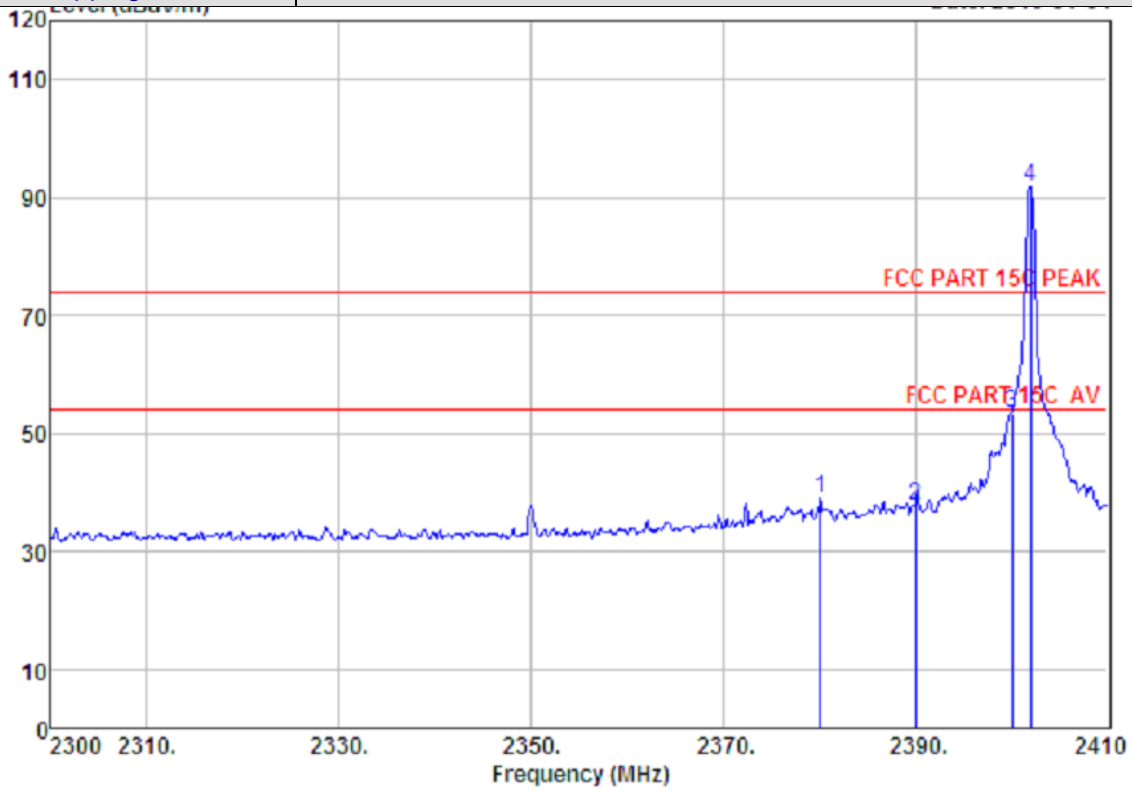

	Freq. (MHz)	Ant. Factor (dB/m)	Cable Loss (dB)	Amp Factor (dB)	Reading (dBuV)	Emission Level (dBuV/m)	Limits (dBuV/m)	Margin (dB)	Remark
1	2380.08	27.64	6.60	34.59	39.37	39.02	74.00	34.98	Peak
2	2390.00	27.64	6.62	34.62	38.02	37.66	74.00	36.34	Peak
3	2400.00	27.61	6.62	34.64	53.96	53.55	74.00	20.45	Peak
4	2402.00	27.61	6.62	34.64	92.29	91.88	74.00	-17.88	Peak

Remarks: 1. Emission Level= Antenna Factor + Cable Loss - Amp Factor + Reading.
 2. The emission levels that are 20dB below the official limit are not reported.

Test mode : GFSK(DH5)	2480MHz	Test channel:	Highest	Polarization	vertical
No Hopping					

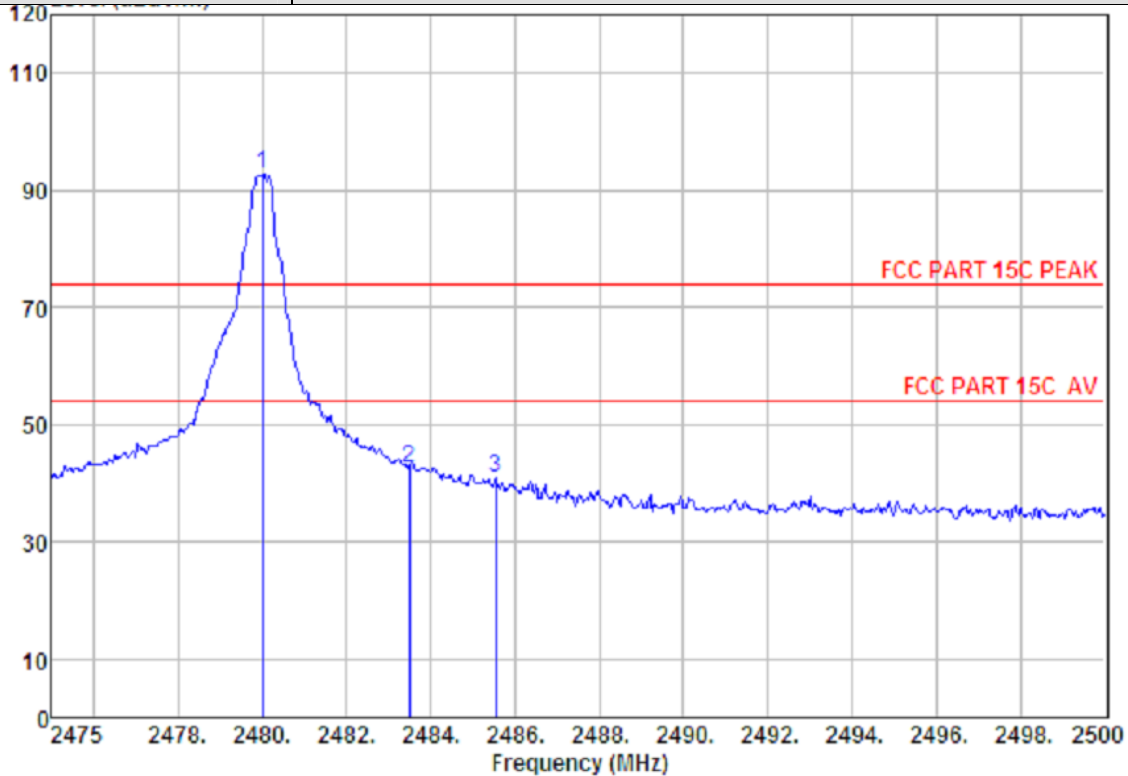

	Freq. (MHz)	Ant. Factor (dB/m)	Cable Loss (dB)	Amp Factor (dB)	Reading (dBuV)	Emission Level (dBuV/m)	Limits (dBuV/m)	Margin (dB)	Remark
1	2480.00	27.58	6.71	35.11	93.64	92.82	74.00	-18.82	Peak
2	2483.50	27.58	6.71	35.11	43.40	42.58	74.00	31.42	Peak
3	2485.55	27.58	6.71	35.11	41.66	40.84	74.00	33.16	Peak

Remarks: 1. Emission Level= Antenna Factor + Cable Loss - Amp Factor + Reading.
 2. The emission levels that are 20dB below the official limit are not reported.

Test mode : GFSK(DH5)	2480MHz	Test channel:	Highest	Polarization	Horizontal
No Hopping					

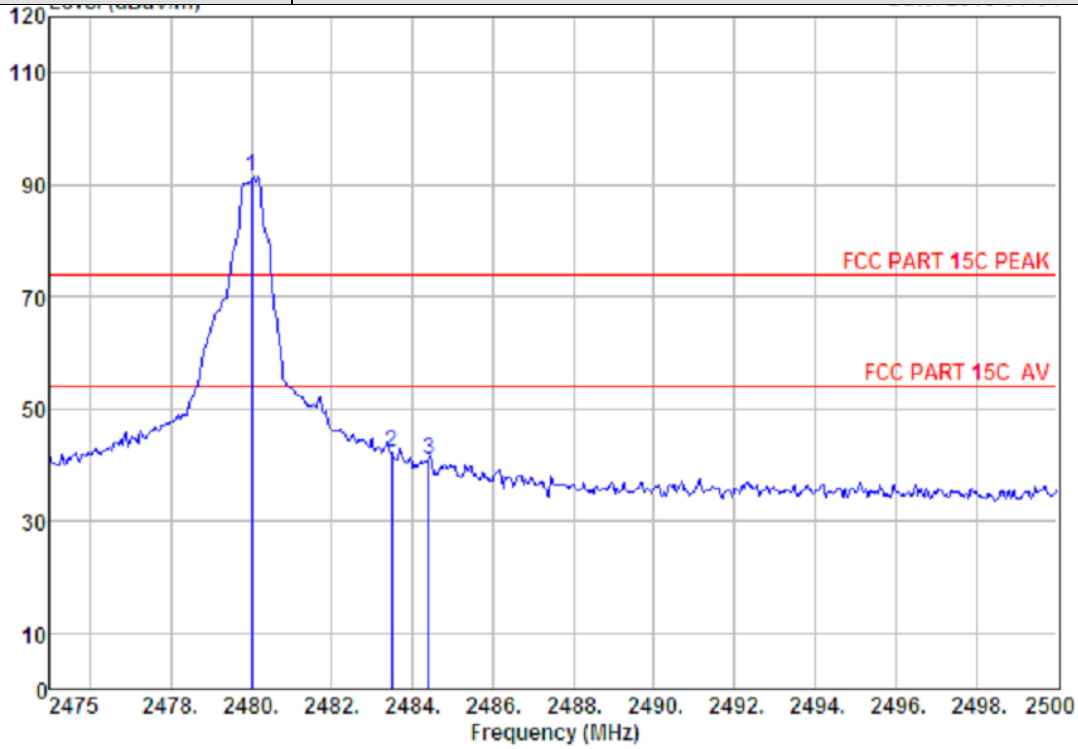

	Freq. (MHz)	Ant. Factor (dB/m)	Cable Loss (dB)	Amp Factor (dB)	Reading (dBuV)	Emission Level (dBuV/m)	Limits (dBuV/m)	Margin (dB)	Remark
1	2480.00	27.58	6.71	35.11	92.30	91.48	74.00	-17.48	Peak
2	2483.50	27.58	6.71	35.11	42.96	42.14	74.00	31.86	Peak
3	2484.40	27.58	6.71	35.11	41.89	41.07	74.00	32.93	Peak

Remarks: 1. Emission Level= Antenna Factor + Cable Loss - Amp Factor + Reading.
 2. The emission levels that are 20dB below the official limit are not reported.

Test mode : GFSK(DH5)	2402MHz	Test channel:	Lowest	Polarization	Horizontal
Hopping on					

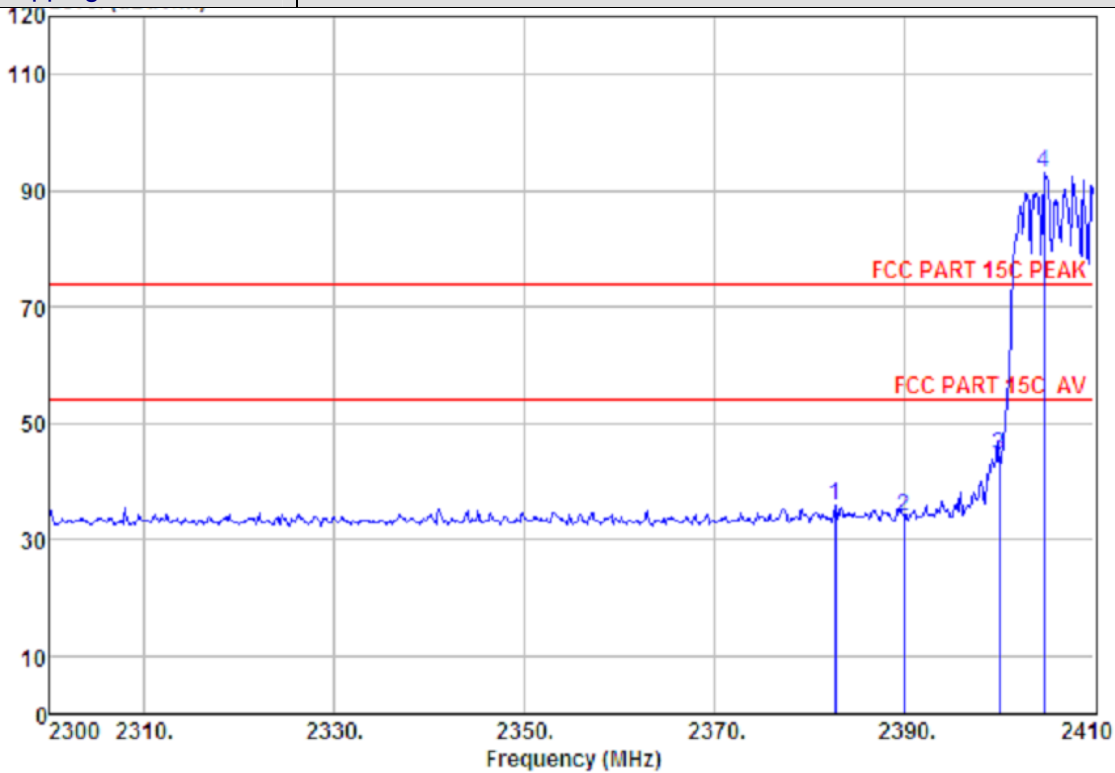

	Freq. (MHz)	Ant. Factor (dB/m)	Cable Loss (dB)	Amp Factor (dB)	Reading (dBuV)	Emission Level (dBuV/m)	Limits (dBuV/m)	Margin (dB)	Remark
1	2382.72	27.64	6.60	34.62	36.21	35.83	74.00	38.17	Peak
2	2390.00	27.64	6.62	34.62	34.41	34.05	74.00	39.95	Peak
3	2400.00	27.61	6.62	34.64	44.92	44.51	74.00	29.49	Peak
4	2404.72	27.61	6.64	34.64	93.38	92.99	74.00	-18.99	Peak

Remarks: 1. Emission Level= Antenna Factor + Cable Loss - Amp Factor + Reading.
 2. The emission levels that are 20dB below the official limit are not reported.

Test mode : GFSK(DH5)	2402MHz	Test channel:	Lowest	Polarization	vertical
Hopping on					

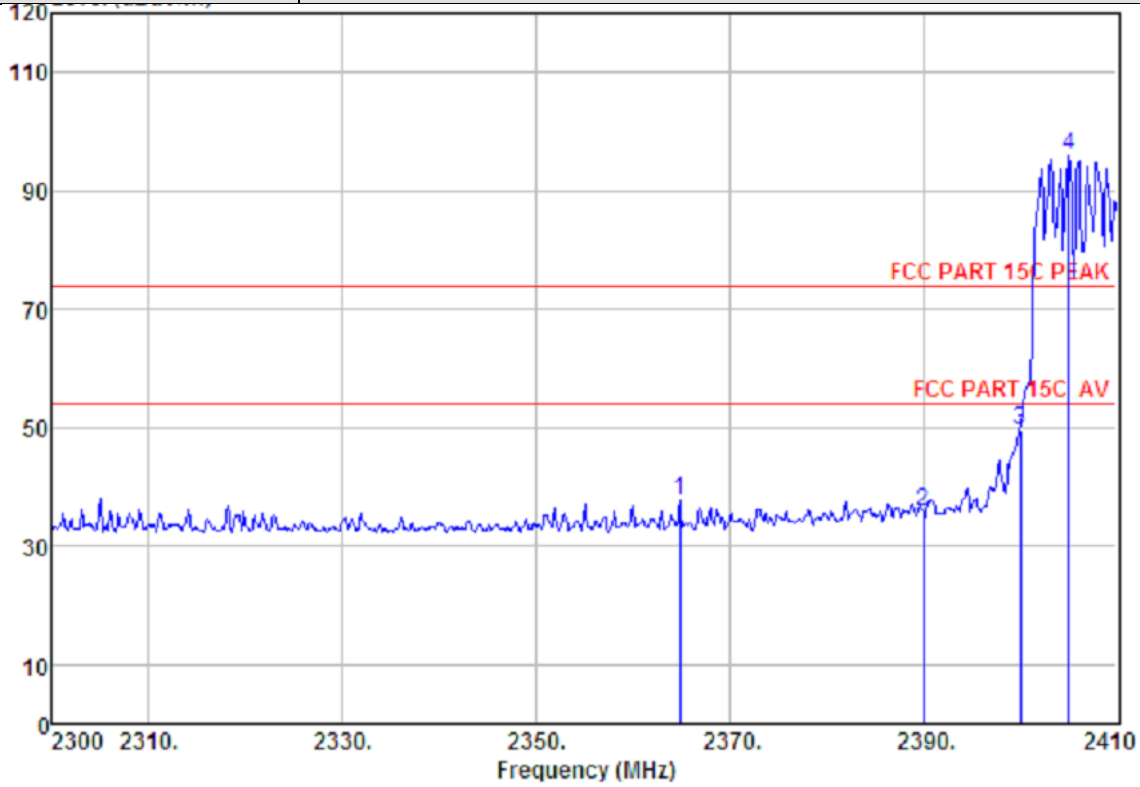

	Freq. (MHz)	Ant. Factor (dB/m)	Cable Loss (dB)	Amp Factor (dB)	Reading (dBuV)	Emission Level (dBuV/m)	Limits (dBuV/m)	Margin (dB)	Remark
1	2364.90	27.67	6.58	34.59	38.16	37.82	74.00	36.18	Peak
2	2390.00	27.64	6.62	34.62	36.20	35.84	74.00	38.16	Peak
3	2400.00	27.61	6.62	34.64	50.17	49.76	74.00	24.24	Peak
4	2405.05	27.61	6.64	34.64	96.47	96.08	74.00	-22.08	Peak

Remarks: 1. Emission Level= Antenna Factor + Cable Loss - Amp Factor + Reading.
 2. The emission levels that are 20dB below the official limit are not reported.

Test mode: GFSK(DH5)	2480MHz	Test channel:	Highest	Polarization	vertical
Hopping on					

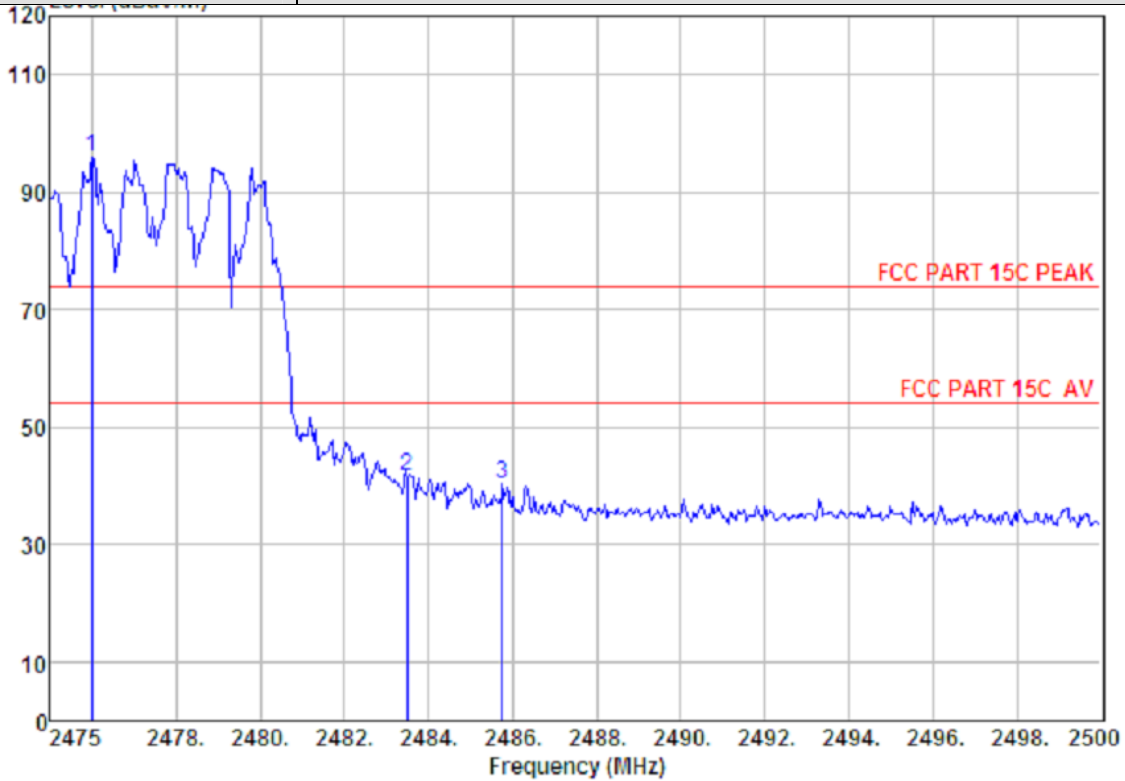

	Freq. (MHz)	Ant. Factor (dB/m)	Cable Loss (dB)	Amp Factor (dB)	Reading (dBuV)	Emission Level (dBuV/m)	Limits (dBuV/m)	Margin (dB)	Remark
1	2476.00	27.58	6.71	35.11	96.94	96.12	74.00	-22.12	Peak
2	2483.50	27.58	6.71	35.11	42.44	41.62	74.00	32.38	Peak
3	2485.75	27.58	6.71	35.11	41.26	40.44	74.00	33.56	Peak

Remarks: 1. Emission Level= Antenna Factor + Cable Loss - Amp Factor + Reading.
2. The emission levels that are 20dB below the official limit are not reported.

Test mode: GFSK(DH5)	2480MHz	Test channel:	Highest	Polarization	Horizontal
Hopping on					

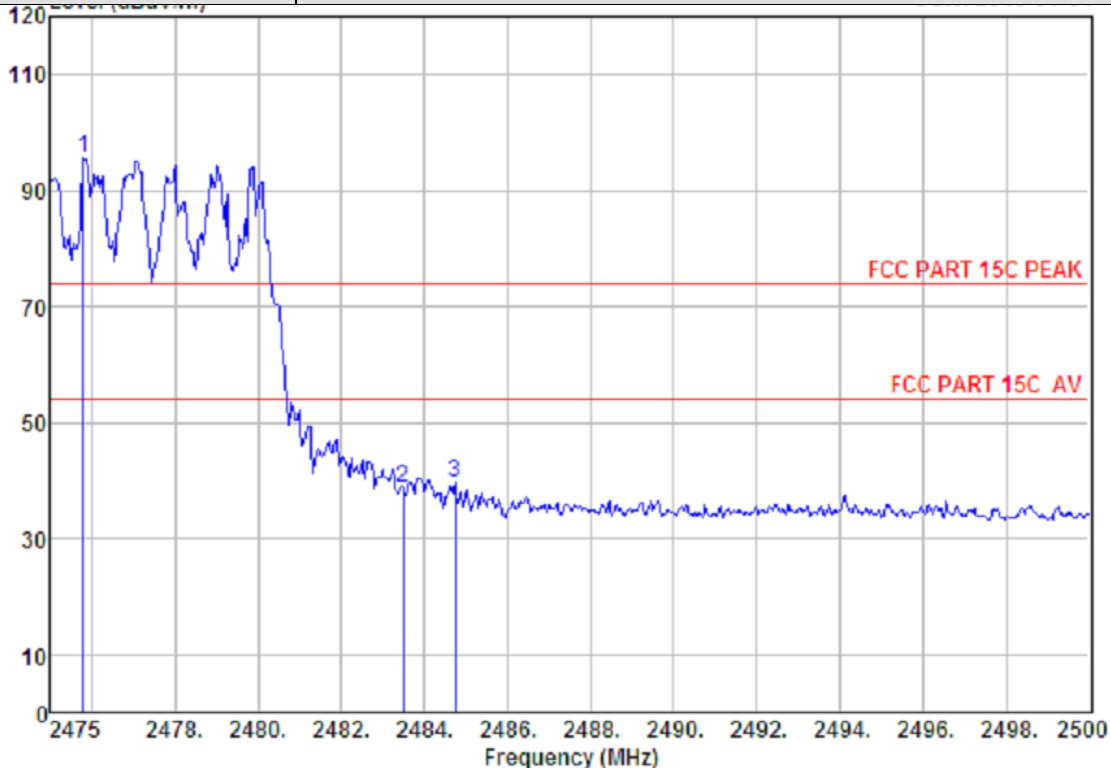

	Freq. (MHz)	Ant. Factor (dB/m)	Cable Loss (dB)	Amp Factor (dB)	Reading (dBuV)	Emission Level (dBuV/m)	Limits (dBuV/m)	Margin (dB)	Remark
1	2475.80	27.58	6.71	35.11	96.45	95.63	74.00	-21.63	Peak
2	2483.50	27.58	6.71	35.11	39.49	38.67	74.00	35.33	Peak
3	2484.75	27.58	6.71	35.11	40.57	39.75	74.00	34.25	Peak

Remarks: 1. Emission Level= Antenna Factor + Cable Loss - Amp Factor + Reading.
2. The emission levels that are 20dB below the official limit are not reported.

■ Spurious Emission below 1GHz (30MHz to 1GHz)
Only the worst case is recorded in the report.:

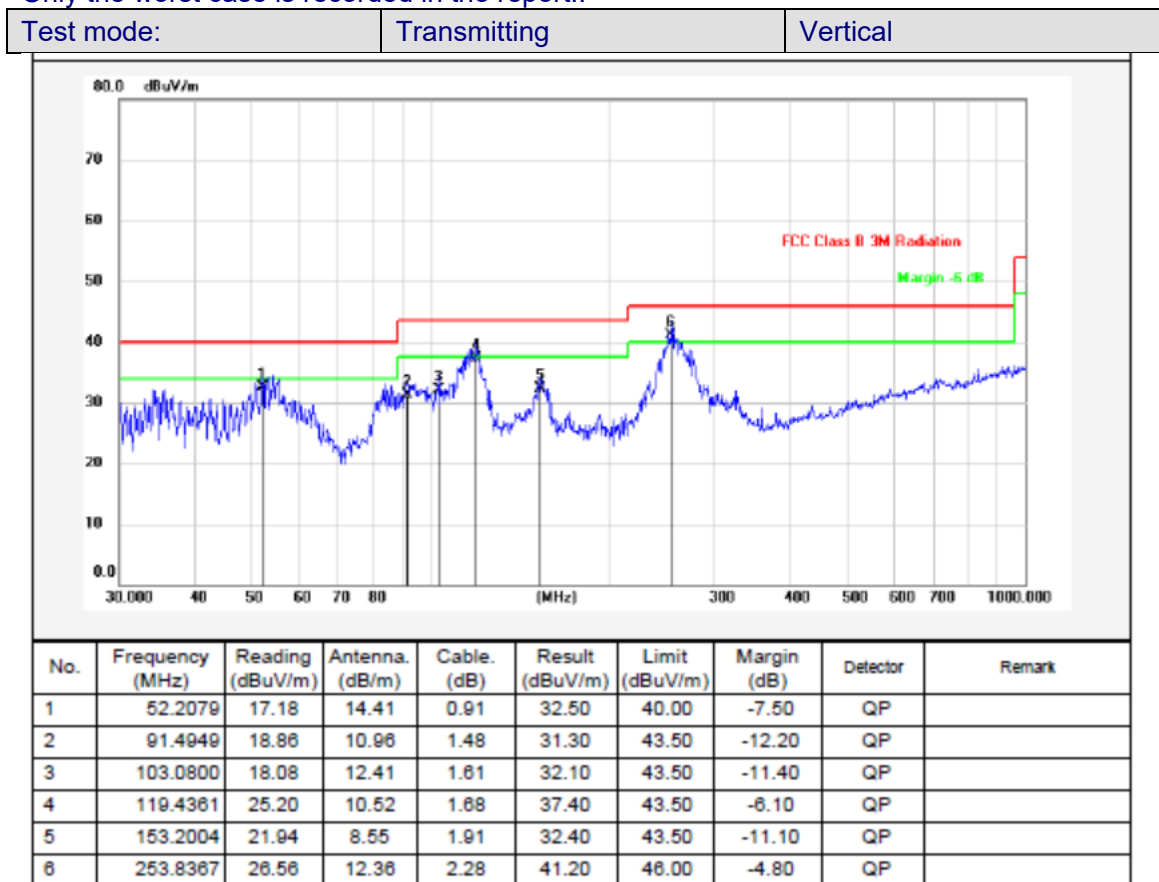

Test mode: Transmitting Horizontal

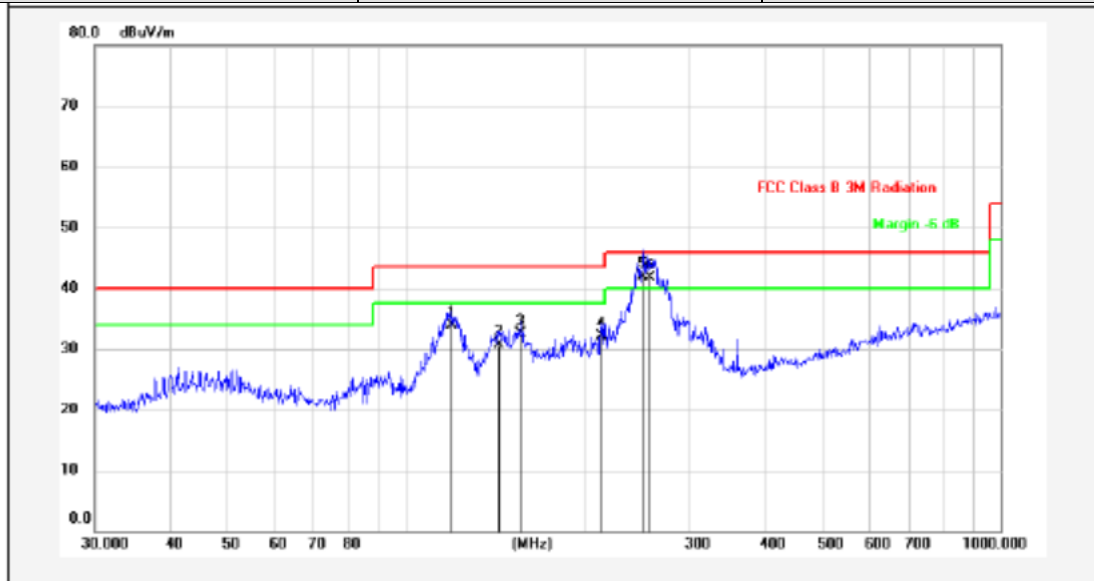

No.	Frequency (MHz)	Reading (dBuV/m)	Antenna. (dB/m)	Cable. (dB)	Result (dBuV/m)	Limit (dBuV/m)	Margin (dB)	Detector	Remark
1	119.4360	21.80	10.52	1.88	34.00	43.50	-9.50	QP	
2	143.3260	20.60	8.36	1.84	30.80	43.50	-12.70	QP	
3	155.9100	21.92	8.65	1.93	32.50	43.50	-11.00	QP	
4	213.0150	19.03	11.04	2.13	32.20	43.50	-11.30	QP	
5	250.3011	27.43	12.3	2.27	42.00	46.00	-4.00	QP	
6	257.4221	27.09	12.42	2.29	41.80	46.00	-4.20	QP	

8.7 ANTENNA APPLICATION

8.7.1 Antenna Requirement

Standard	Requirement
FCC CRF Part 15.203	An intentional radiator shall be designed to ensure that no antenna other than that furnished by the responsible party shall be used with the device. The use of a permanently attached antenna or of an antenna that uses a unique coupling to the intentional radiator shall be considered sufficient to comply with the provisions of this section. The manufacturer may design the unit so that a broken antenna can be replaced by the user, but the use of a standard antenna jack or electrical connector is prohibited. This requirement does not apply to carrier current devices or to devices operated under the provisions of §15.211, §15.213, §15.217, §15.219, or §15.221. Further, this requirement does not apply to intentional radiators that must be professionally installed, such as perimeter protection systems and some field disturbance sensors, or to other intentional radiators which, in accordance with §15.31(d), must be measured at the installation site. However, the installer shall be responsible for ensuring that the proper antenna is employed so that the limits in this part are not exceeded.

For intentional device, according to FCC 47 CFR Section 15.203, an intentional radiator shall be designed to ensure that no antenna other than that furnished by the responsible party shall be used with the device. And according to FCC 47 CFR Section 15.247 (b), if transmitting antennas of directional gain greater than 6dBi are used, the power shall be reduced by the amount in dB that the directional gain of the antenna exceeds 6dBi.

8.7.2 Result

PASS.

The EUT has 1 antenna: aExternal antenna the gain is 1.59 dBi;

Note: Antenna use a permanently attached antenna which is not replaceable.
 Not using a standard antenna jack or electrical connector for antenna replacement
 The antenna has to be professionally installed (please provide method of installation)

which in accordance to section 15.203, please refer to the internal photos.

8.8 TEST PHOTO

Radiated emission



8.9 EUT PHOTO

External photo

M/N: DMCPA8W, DMCPA80FL, DCPA813, DCPA81W, CAR1013, CAR813, J1CA8FL,
CVS8489W-SD, XDCPA73W, DCPA723W, DCA73W, DMCPA703W, CAR723W, J3CA7W,
CVS7482W-SD



External photo

M/N: DMCPA8W, DMCPA80FL, DCPA813, DCPA81W, CAR1013, CAR813, J1CA8FL, CVS8489W-SD, XDCPA73W, DCPA723W, DCA73W, DMCPA703W, CAR723W, J3CA7W, CVS7482W-SD

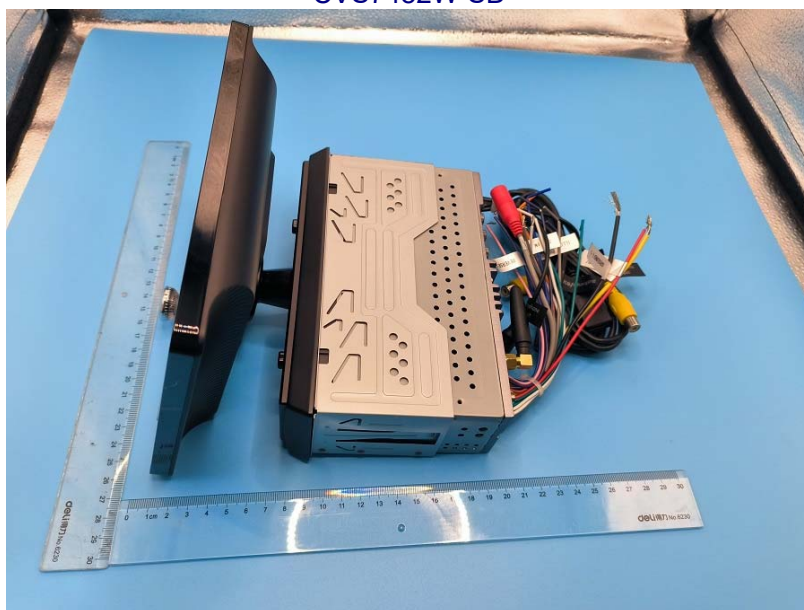

External photo

M/N: DMCPA8W, DMCPA80FL, DCPA813, DCPA81W, CAR1013, CAR813, J1CA8FL,
CVS8489W-SD, XDCPA73W, DCPA723W, DCA73W, DMCPA703W, CAR723W, J3CA7W,
CVS7482W-SD

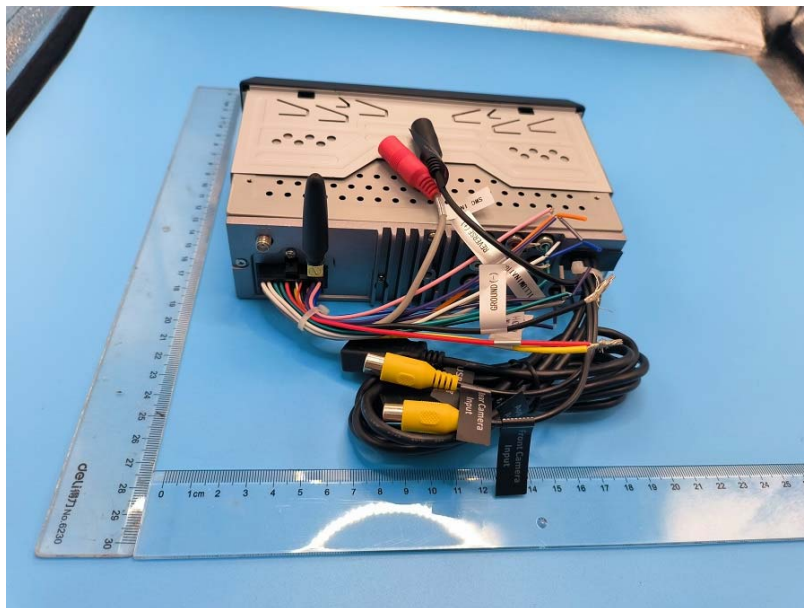

External photo

M/N: DMCPA8W, DMCPA80FL, DCPA813, DCPA81W, CAR1013, CAR813, J1CA8FL,
CVS8489W-SD, XDCPA73W, DCPA723W, DCA73W, DMCPA703W, CAR723W, J3CA7W,
CVS7482W-SD



External photo
M/N: DMCPA10W, AVM2310W, J1CA10FL, CAR1013, CVS1515W-SD



External photo
M/N: DMCPA10W, AVM2310W, J1CA10FL, CAR1013, CVS1515W-SD

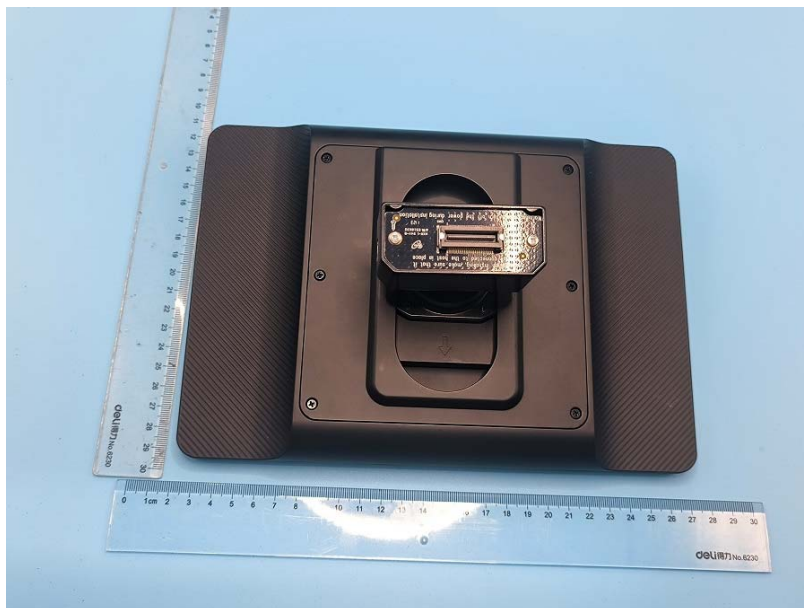

External photo
M/N: DMCPA10W, AVM2310W, J1CA10FL, CAR1013, CVS1515W-SD

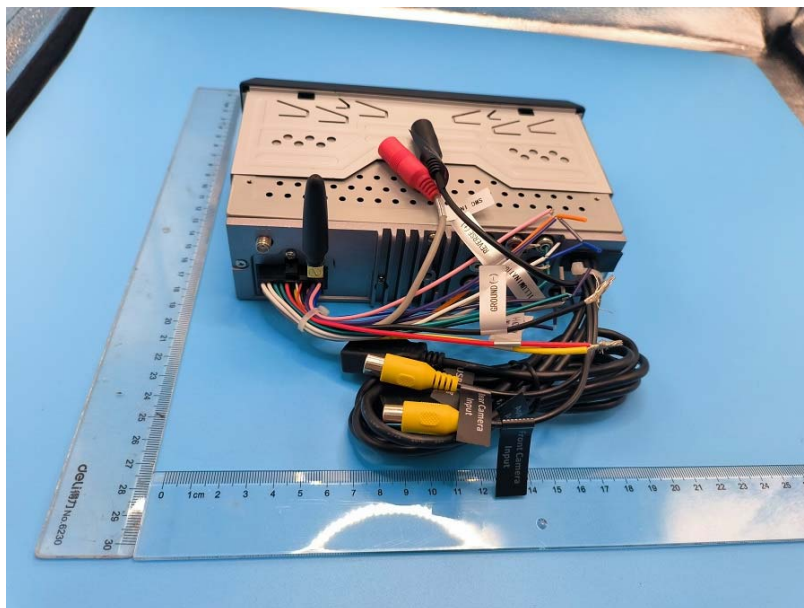
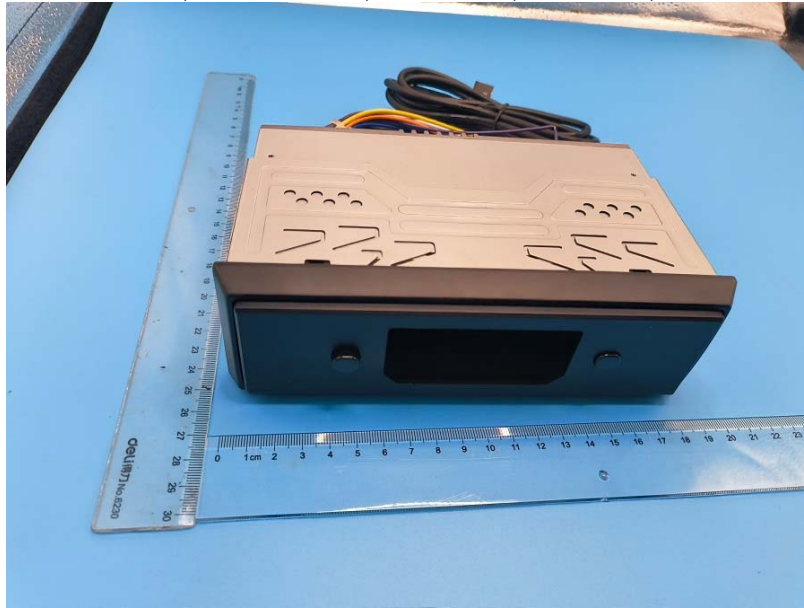

Internal photo

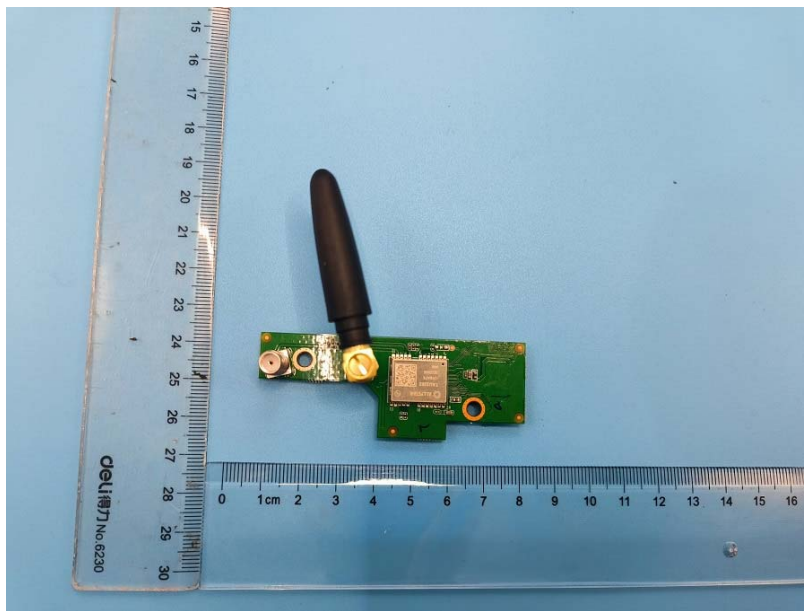
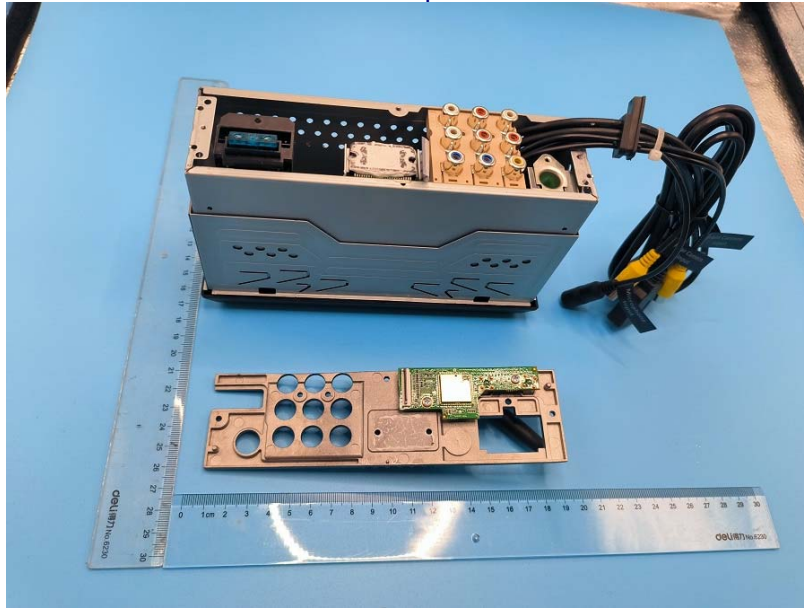

Internal photo

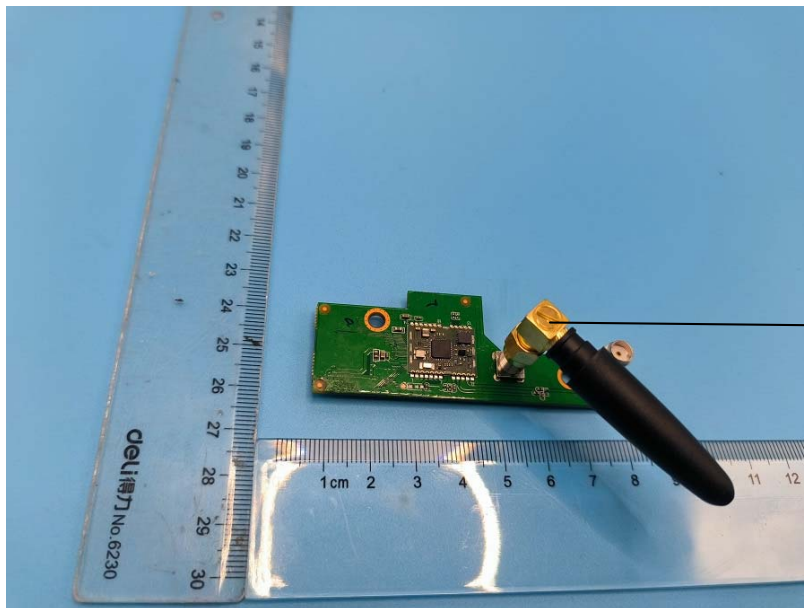
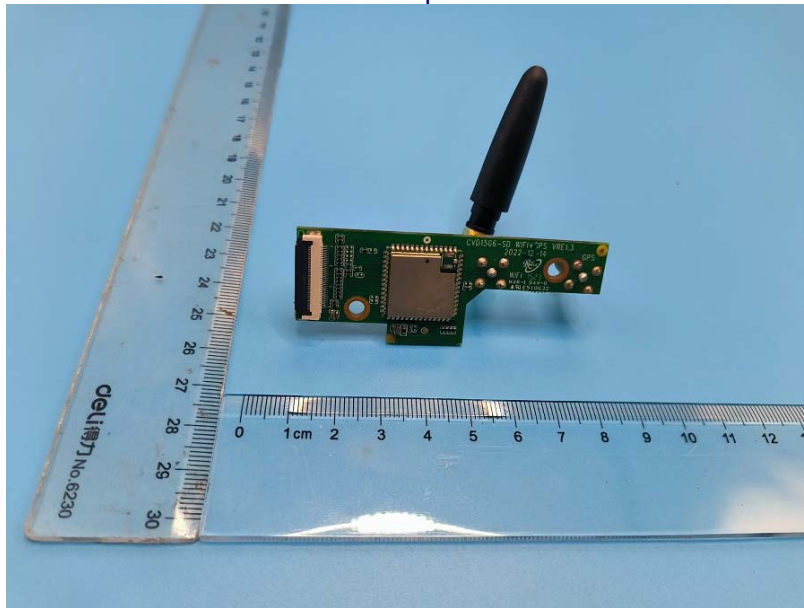

BT/2.4GHz WIFI
antenna

Internal photo

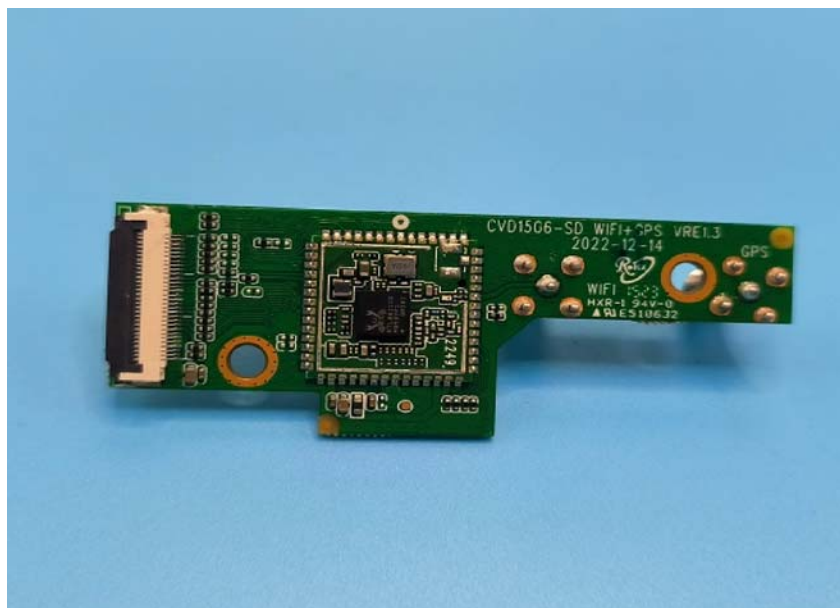
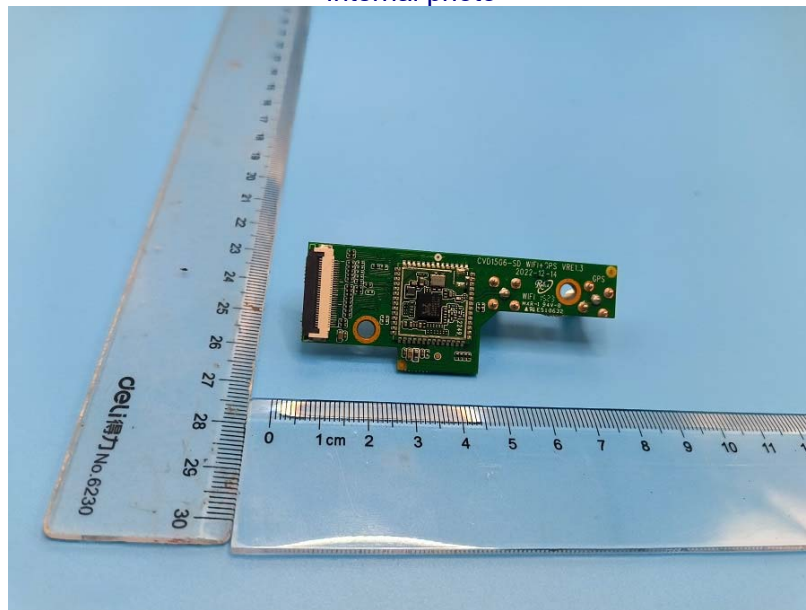

Internal photo

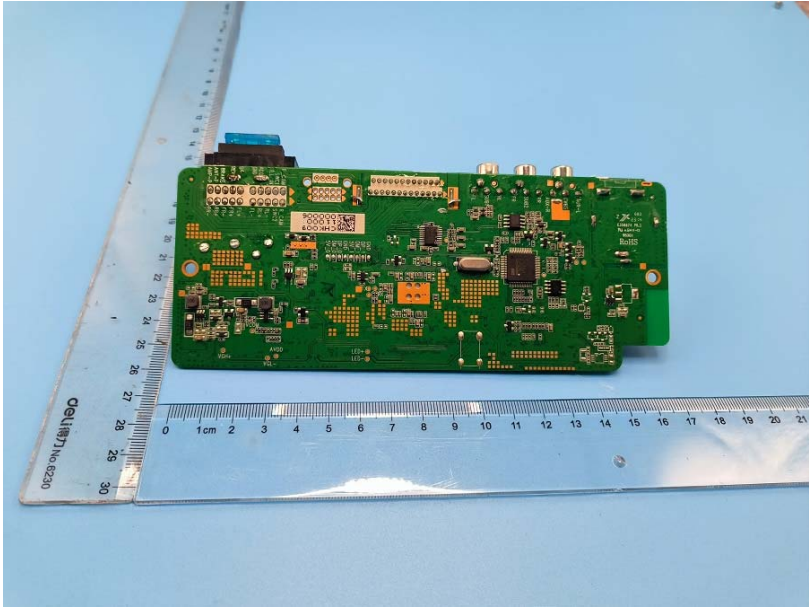
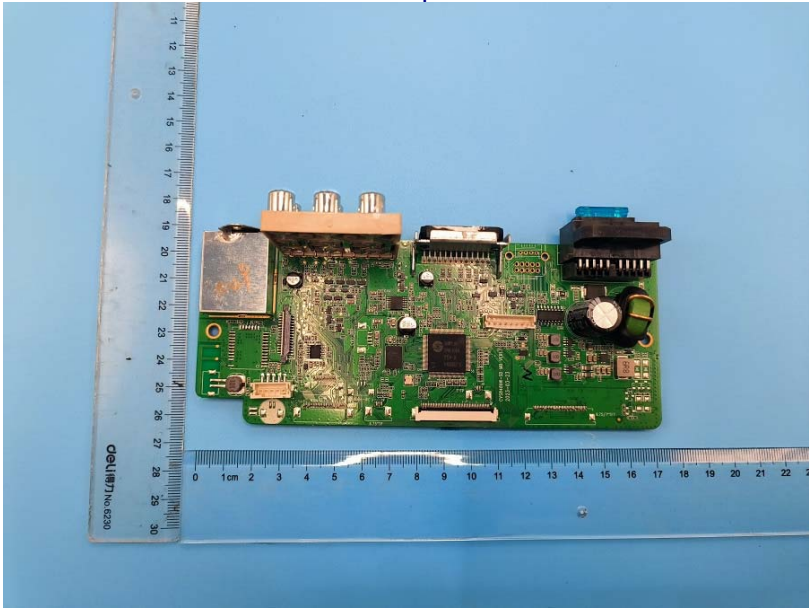

----- END OF REPORT -----