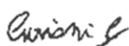
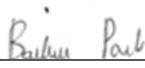

<b>Report Reference ID:</b>	278618-1TRFWL
-----------------------------	---------------

<b>Test specification:</b>	<b>Title 47 – Telecommunication</b> Chapter I – Federal Communications Commission Subchapter D – Safety and special radio services Part 90 – Private land mobile services Subpart I – General technical standards
----------------------------	---

<b>Applicant:</b>	TEKO Telecom Srl Via Meucci, 24/a I-40024 Castel S. Pietro Terme (BO) (Italy)
<b>Apparatus:</b>	Digital Donor Front End
<b>Model:</b>	TDFE-7F
<b>FCC ID:</b>	XM2-DFE7F

<b>Testing laboratory:</b>	<b>Nemko Italy Spa</b> Via del Carroccio, 4 20853 Biassono (MB) – Italy Telephone: +39 039 2201201 Facsimile: +39 039 2201221
----------------------------	---

	Name and title	Date
<b>Tested by:</b>	 <hr/> G. Curioni, Wireless/EMC Specialist	2015-03-12
<b>Reviewed by:</b>	 <hr/> P. Barbieri, Wireless/EMC Specialist	2015-03-12

**Nemko Spa, 20853 Biassono (MB) - Italy. All rights reserved.**

This publication may be reproduced in whole for non-commercial purposes as long as Nemko Spa is acknowledged as copyright owner and source of the material. Nemko Spa takes no responsibility for and will not assume liability for damages resulting from the reader's interpretation of the reproduced material due to its placement and context. Nemko Spa accepts no responsibility for damages, if any, suffered by any third party as a result of decisions made or actions based on this report. This test report may not be partially reproduced, except with the prior written permission of Nemko Spa. The test report merely corresponds to the test sample. The phase of sampling / collection of equipment under test is carried out by the customer.

This Test Report, when bearing the Nemko name and logo is only valid when issued by a Nemko laboratory, or by a laboratory having special agreement with Nemko.

Table of contents

<b>Section 1: Report summary .....</b>	<b>3</b>
<b>Section 2: Equipment under test .....</b>	<b>4</b>
2.1 Identification of equipment under test (EUT).....	4
2.2 Accessories and support equipment.....	5
2.3 EUT description.....	6
2.4 Technical specifications of the EUT .....	6
2.5 EUT setup diagram.....	7
2.6 Operation of the EUT during testing.....	8
2.7 Modifications incorporated in the EUT .....	8
<b>Section 3: Test conditions .....</b>	<b>9</b>
3.1 Deviations from laboratory tests procedures.....	9
3.2 Test conditions, power source and ambient temperatures .....	9
3.3 Measurement uncertainty .....	10
3.4 Test equipment.....	10
<b>Section 4: Result summary .....</b>	<b>11</b>
4.1 FCC Part 90: test results .....	11
<b>Appendix A: Test results.....</b>	<b>12</b>
Clause 90.205, 90.219(e)(1) Output power .....	12
Clause 90.209, 90.219(e)(4) Occupied bandwidth .....	14
Clause 90.543(e), 90.219(e)(3) Spurious emissions at the antenna terminal .....	15
Clause 90.543(e), 90.219(e)(3) Field strength of spurious radiation.....	18
Clause 90.543(f) Radiated spurious emissions within 1559–1610 MHz band .....	22
Clause 90.219(e)(2) Noise Figure.....	24
Clause 935210 D02v02r01 Appendix D.3 (i) Intermodulation.....	25
Clause 935210 D02v02r01 (D.3)(l) Out of band rejection.....	26
<b>Appendix B: Block diagrams of test set-ups .....</b>	<b>27</b>
<b>Appendix C: EUT Photos.....</b>	<b>28</b>

## Section 1: Report summary

This report contains an assessment of apparatus against specifications based upon tests carried out on samples submitted at Nemko Spa.

**Test specification:**  
 FCC Part 90 Private land mobile services  
 Subpart I – General technical standards

Compliance status:	Complies
Exclusions:	None
Non-compliances:	None
Report release history:	Original release
Test location:	Nemko Spa Via Del Carroccio, 4 – 20853 Biassono (MB) - Italy
Registration number:	481407 (10 m Semi anechoic chamber)

Note that the results contained in this report relate only to the items tested and were obtained in the period between the date of initial receipt of samples and the date of issue of the report.

This test report has been completed in accordance with the requirements of ISO/IEC 17025.

Nemko Spa authorizes the applicant to reproduce this report provided it is reproduced in its entirety and for use by the company's employees only.

Any use which a third party makes of this report, or any reliance on or decisions to be made based on it, are the responsibility of such third parties. Nemko Spa accepts no responsibility for damages, if any, suffered by any third party as a result of decisions made or actions based on this report.

## Section 2: Equipment under test

### 2.1 Identification of equipment under test (EUT)

The following information identifies the EUT under test:

Type of equipment:	Donor Front End
Product marketing name:	Teko Telecom Srl
Model number:	TDFE-7F
Serial number:	130977001
Nemko sample number:	--
FCC ID:	XM2-DFE7F
Date of receipt:	2015-03-09

2.2 Accessories and support equipment	
The following information identifies accessories used to exercise the EUT during testing:	
No other FCC-ID equipment are used to exercise the EUT during testing	
Item # 1	
Type of equipment:	Master Unit - Subrack
Brand name:	Teko Telecom srl
Model name or number:	SUB-TRX-PSU
Serial number:	101083001
Nemko sample number:	-----
Connection port:	-----
Cable length and type:	-----
Item # 2	
Type of equipment:	Master Unit – Management Module
Brand name:	Teko Telecom srl
Model name or number:	TSPV-R
Serial number:	081900043
Nemko sample number:	-----
Connection port:	LAN port
Cable length and type:	-----
Item # 3	
Type of equipment:	Master Unit – Power Supply
Brand name:	Teko Telecom srl
Model name or number:	TPSU/AC
Serial number:	100012286
Nemko sample number:	-----
Connection port:	-----
Cable length and type:	-----

Section 2: Equipment under test, continued

2.3 EUT description

See confidential block diagram and operational description

2.4 Technical specifications of the EUT

Operating band:	Down Link: 763–768 MHz, Up Link: 793-798 MHz
Operating frequencies:	Wideband
Modulation type:	iDEN
Occupied bandwidth:	Standard
Channel spacing:	Standard
Emission designator:	iDEN: D7W
RF Output	Down Link: N.A. (The EUT does not transmit over the air in the down-link direction) Up Link: 26dBm
Gain	Down Link: N.A. (The EUT does not transmit over the air in the down-link direction) Up Link: 64dB
Antenna data:	No antenna provided
Antenna type:	No antenna provided External Antenna (Equipment that has an external 50 Ω RF connector)
Power source	100-240 Vac

Section 2: Equipment under test, continued

2.5 EUT setup diagram

In this system, DFE is the EUT. As described in “Operational description”, DFE can be connected directly to optical system or Service Front end. Signal generator is linked directly to the RF input connector of the EUT, so the system doesn’t use another equipment (under another FCC ID) to exercise the EUT.

**Test setup for output power, occupied bandwidth, spurious emissions:**



**Procedure**

Connect the signal modulated generator to the input of the EUT, so that the EUT works at the max gain. Raise the input level to the EUT until reach the maximum output power. Connect the spectrum analyzer to the RF output connector of the EUT.

**Test setup for intermodulation:**

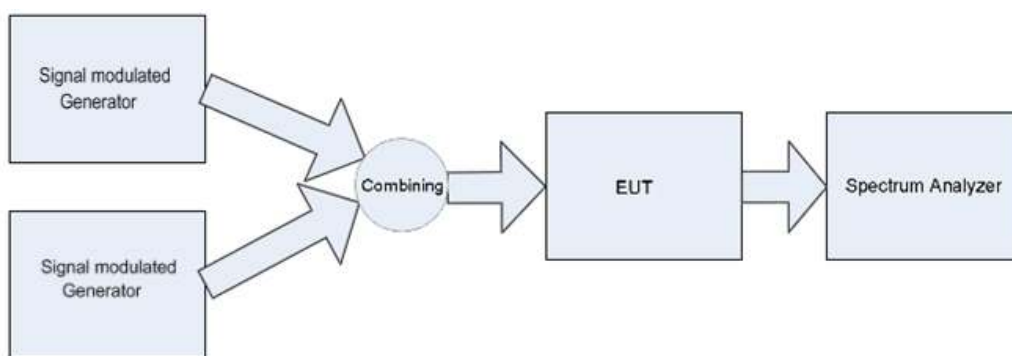

**Procedure**

Connect two signal modulated generators to the input of the EUT, so that the two input signals are same level. The EUT works at the max gain. Raise the input level to the EUT until reach the maximum output power. Connect the spectrum analyzer to the RF output connector of the EUT. At maximum drive level, for each modulation applies two tones for fulfill two tests (high-band edge and low-band-edge)

**Test setup for Noise figure:**

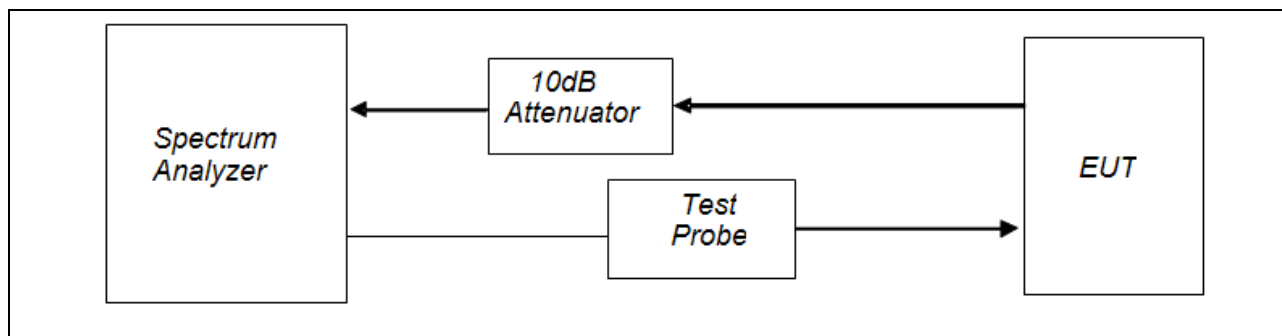

**Procedure**

Connect the EUT with the spectrum analyzer as described in the picture below. Connect the “Output Noise Source” spectrum analyzer with the RF input connector of the Remote Unit. Connect the output RF connector with the spectrum analyzer. Between spectrum analyzer and Remote Unit use a “Noise Source” (Test probe), so the noise of reference is generated. Set the EUT at max gain.

**2.6 Operation of the EUT during testing**

In up-link direction, normal working at max gain with max RF power output

**2.7 Modifications incorporated in the EUT**

None

There were no modifications performed to the EUT during this assessment



## Section 3: Test conditions

### 3.1 Deviations from laboratory tests procedures

No deviations were made from laboratory test procedures.

### 3.2 Test conditions, power source and ambient temperatures

<p>Normal temperature, humidity and air pressure test conditions</p>	<p>Temperature: 15–30 °C                  Relative humidity: 20–75 %                  Air pressure: 86–106 kPa</p> <p>When it is impracticable to carry out tests under these conditions, a note to this effect stating the ambient temperature and relative humidity during the tests shall be recorded and stated.</p>
<p>Power supply range:</p>	<p>The normal test voltage for equipment to be connected to the mains shall be the nominal mains voltage. For the purpose of the present document, the nominal voltage shall be the declared voltage, or any of the declared voltages <math>\pm 5\%</math>, for which the equipment was designed.</p>

Section 3: Test conditions, continued

3.3 Measurement uncertainty

Nemko S.p.A. measurement uncertainty has been calculated using the standard CISPR 16-4-2 “Specification for radio disturbance and immunity measuring apparatus and methods – Part 4-2: Uncertainties, statistics and limit modeling – Uncertainty in EMC measurements“. All calculations can be found in Nemko S.p.A. document WML1002.

3.4 Test equipment

Equipment	Manufacturer	Model No.	Asset/Serial No.	Next cal.
Vector Signal Generator	Agilent	N5172B EXG	MY53050534	Feb 2017
Vector Signal Generator	Agilent	E4438C ESG	MY45094485	Ago 2016
Spectrum Analyzer	Agilent	N9030A PXA	MY53120882	Apr 2015
Network Analyzer	Agilent	E5071B ENA	MY46418709	Jan 2016
--	--	--	--	--
EMI Receiver	R & S	ESCI	100888	08/2015
V-network	R & S	ESH2-Z5	872 460/041	09/2015
Trilog Broad Band Antenna 25-2000 MHz	Schwarzbeck	VULB 9168	VULB 9168-242	02/2015
Trilog Broad Band Antenna 25-8000 MHz	Schwarzbeck	VULB 9162	VULB 9162-25	05/2015
Antenna 1-18 GHz	Schwarzbeck	STLP 9148	STPL 9148-123	02/2015
Double ridge waveguide horn	RFspin	DRH40	061106A40	08/2016
Preamplifier 18-40 GHz	Miteq	JS44	1648665	11/2015
Broadband preamplifier 1-18 GHz	Schwarzbeck	BBV 9718	9718-137	10/2015
EMI receiver 20 Hz ÷ 8 GHz	R&S	ESU8	100202	02/2015
EMI receiver 20 Hz ÷ 3 GHz	R&S	ESCI	100888	08/2015
Hydraulic revolving platform	Nemko	RTPL 01	4.233	NCR
Turning-table	R&S	HCT	835 803/03	NCR
Antenna mast	R&S	HCM	836 529/05	NCR
Controller	R&S	HCC	836 620/7	NCR
Spectrum Analyzer 9kHz ÷ 40GHz	R&S	FSEK	848255/005	08/2015
Semi-anechoic chamber	Nemko	10m semi-anechoic chamber	530	09/2016
Shielded room	Siemens	10m control room	1947	NCR
Semi-anechoic chamber	Nemko	10m semi-anechoic chamber	70	NCR
Shielded Room	Siemens	3m semi-anechoic chamber	3	NCR
Motor controller	Emco	1051-25	9012-1559	NCR
Motor controller	Emco	1061-1.521	9012-1508	NCR
Antenna Tower	Emco	2071-2	9601-1940	NCR
Controller pole/table	Emco	2090	9511-1099	NCR
V-Network	R & S	ESH2-Z5	872 460/041	09/2015

Note: N/A = Not Applicable, NCR = No Cal Required, COU = CAL On Use  
 (\*) Equipment supplied by manufacturer's

## Section 4: Result summary

### 4.1 FCC Part 90: test results

The column headed 'Required' indicates whether the associated clauses were invoked for the apparatus under test. The following abbreviations are used:

N	No : not applicable / not relevant.
Y	Yes : Mandatory i.e. the apparatus shall conform to these tests.
N/T	Not Tested, mandatory but not assessed. (See report summary)

Part	Test method	Test description	Required	Result
§90.205 §90.219(e)(1)	§2.1047	Output power	Y	Pass
§90.209 §90.219(e)(4)	§2.1049	Occupied bandwidth	Y	Pass
§90.543(e) §90.219(e)(3)	§2.1051	Spurious Emissions at the antenna terminal	Y	Pass
§90.543(e) §90.219(e)(3)	§2.1053	Field strength of spurious radiation	Y	Pass
§90.543(f)	--	Radiated spurious emissions within 1559-1610 MHz band	Y	Pass
§90.213	§2.1055	Frequency stability	N	N/A a)
§90.219(e)(2)	--	Noise Figure	Y	Pass
935210 D02v02r01 (D.3)(i)	--	Intermodulation	Y	Pass
935210 D02v02r01 (D.3)(l)	--	Out of Band Rejection (Filter Frequency Response)	Y	Pass

**Notes:**

a) NOT APPLICABLE: Modulation/frequency conversion circuitry not in use. No frequency change in EUT (input and output have same frequency)

## Appendix A: Test results

### Clause 90.205, 90.219(e)(1) Output power

#### § 90.205

Applicants for licenses must request and use no more power than the actual power necessary for satisfactory operation. Except where otherwise specifically provided for, the maximum power that will be authorized to applicants whose license applications for new stations are filed after August 18, 1995 is as follows in FCC Part 90.205 (a) through (r).

#### § 90.219(e)(1)

The output power capability of a signal booster must be designed for deployments providing a radiated power not exceeding 5 Watts ERP for each retransmitted channel.

Test date: 2015-03-10

Test results: Pass

#### Special notes

The results are the same both with maximum and minimum pass-band of the digital filter: the bandwidth of the signal is lower than minimum pass-band.

#### Special notes

Conducted measurement were performed:

- The power was measured using spectrum analyzer with RMS detector / average power meter.

In measuring transmissions in this band using an average power technique, the peak-to-average ratio (PAR) of the transmission may not exceed 13dB.

Only conducted measurement at antenna connector was possible, no antenna provided by manufacturer.

Test data					
Direction	Modulation	Frequency (MHz)	RF output channel Power (dBm)	RF output channel Power (W)	PAR (dB)
Down-link	iDEN (25 kHz)	765.5	26.14	0.41	3.24

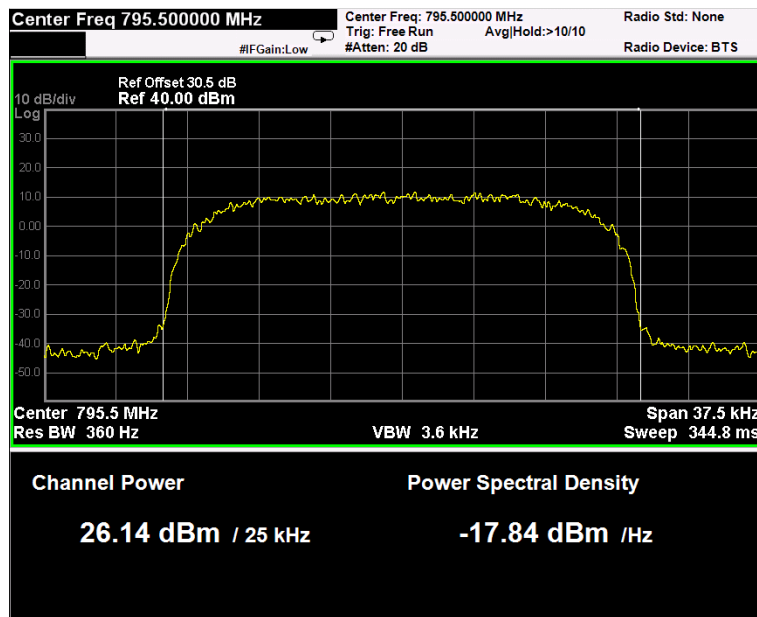

Mod. iDEN

Test result
Gmax antenna gain (dBi) = 39 - 26.14 = 12.86 dBi
EIRP = 26.14 + 12.86 = 39 dBm
ERP = 39 - 2.14 = 36.86dBm = 4.85W < 5 W ERP

Clause 90.209, 90.219(e)(4) Occupied bandwidth

**§ 90.219(e)(4)**  
 A signal booster must be designed such that all signals that it retransmits meet the following requirements:

- (i) The signals are retransmitted on the same channels as received. Minor departures from the exact provider or reference frequencies of the input signals are allowed, *provided that* the retransmitted signals meet the requirements of § 90.213.
- (ii) There is no change in the occupied bandwidth of the retransmitted signals.
- (iii) The retransmitted signals continue to meet the unwanted emissions limits of § 90.210 applicable to the corresponding received signals (assuming that these received signals meet the applicable unwanted emissions limits by a reasonable margin).

Test date: 2015-03-10  
 Test results: Pass

Special notes  
 The results are the same both with maximum and minimum pass-band of the digital filter: the bandwidth of the signal is lower than minimum pass-band.

Test data  
 Resolution bandwidth was set wider or equal than occupied bandwidth.

Mod. iDEN (QAM)

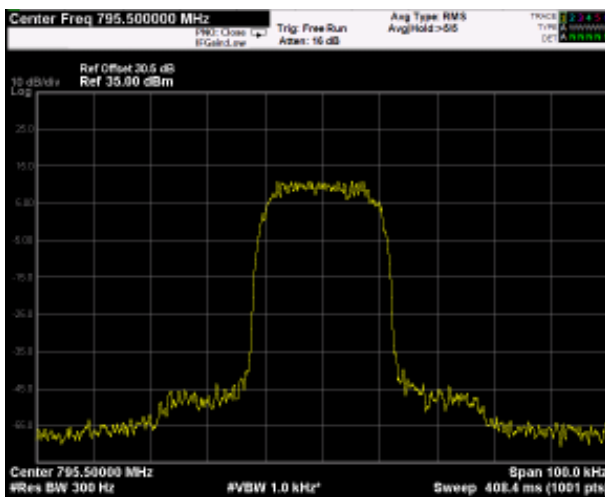

Output

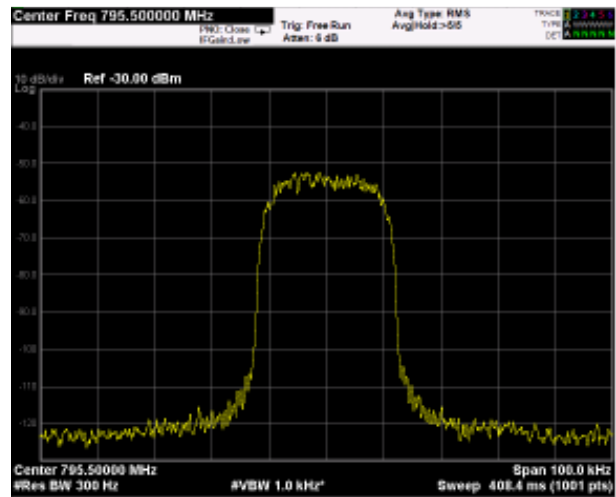

Input

## Clause 90.543(e), 90.219(e)(3) Spurious emissions at the antenna terminal

### § 90.543(e)

For operations in the 758-768 MHz and the 788-798 MHz bands, the power of any emission outside the licensee's frequency band(s) of operation shall be attenuated below the transmitter power (P) within the licensed band(s) of operation, measured in watts, in accordance with the following:

- (1) On all frequencies between 769-775 MHz and 799-805 MHz, by a factor not less than  $76 + 10 \log (P)$  dB in a 6.25 kHz band segment, for base and fixed stations.
- (2) On all frequencies between 769-775 MHz and 799-805 MHz, by a factor not less than  $65 + 10 \log (P)$  dB in a 6.25 kHz band segment, for mobile and portable stations.
- (3) On any frequency between 775-788 MHz, above 805 MHz, and below 758 MHz, by at least  $43 + 10 \log (P)$  dB.
- (4) Compliance with the provisions of paragraphs (e)(1) and (2) of this section is based on the use of measurement instrumentation such that the reading taken with any resolution bandwidth setting should be adjusted to indicate spectral energy in a 6.25 kHz segment.
- (5) Compliance with the provisions of paragraph (e)(3) of this section is based on the use of measurement instrumentation employing a resolution bandwidth of 100 kHz or greater. However, in the 100 kHz bands immediately outside and adjacent to the frequency block, a resolution bandwidth of 30 kHz may be employed.

### § 90.219(e)(3)

Spurious emissions from a signal booster must not exceed  $-13$  dBm within any 100 kHz measurement bandwidth.

### § 2.1051 Measurements required: Spurious emissions at antenna terminals.

The radio frequency voltage or powers generated within the equipment and appearing on a spurious frequency shall be checked at the equipment output terminals when properly loaded with a suitable artificial antenna. Curves or equivalent data shall show the magnitude of each harmonic and other spurious emission that can be detected when the equipment is operated under the conditions specified in §2.1049 as appropriate. The magnitude of spurious emissions which are attenuated more than 20 dB below the permissible value need not be specified.

Test date: 2015-03-10

Test results: Pass

### Special notes

The results are the same both with maximum and minimum pass-band of the digital filter: the bandwidth of the signal is lower than minimum pass-band.

Spurious emissions at antenna terminal:

**Mod. iDEN (QAM) (Down-link)**

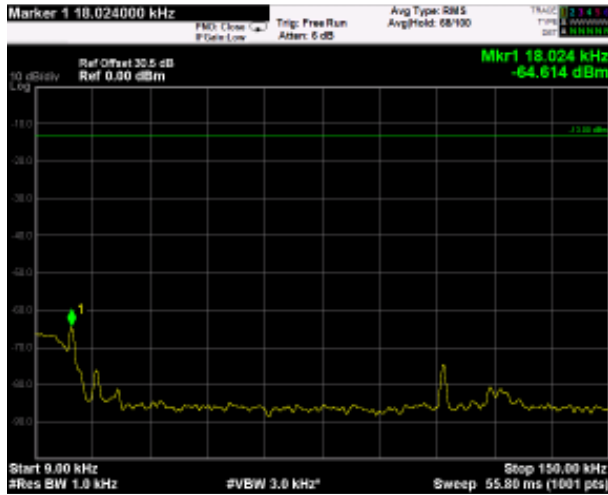

**9kHz-150kHz**

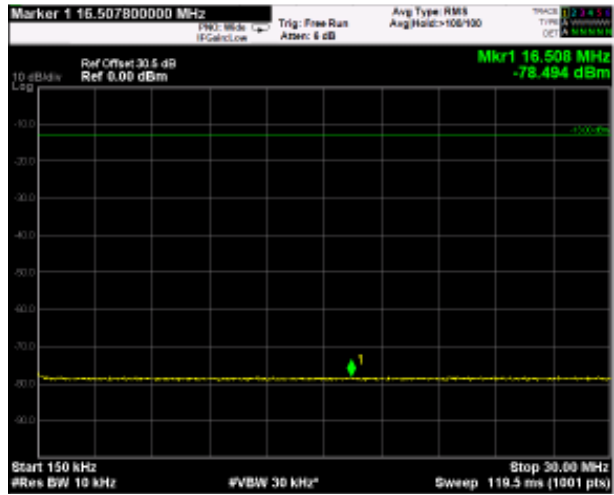

**150kHz-30MHz**

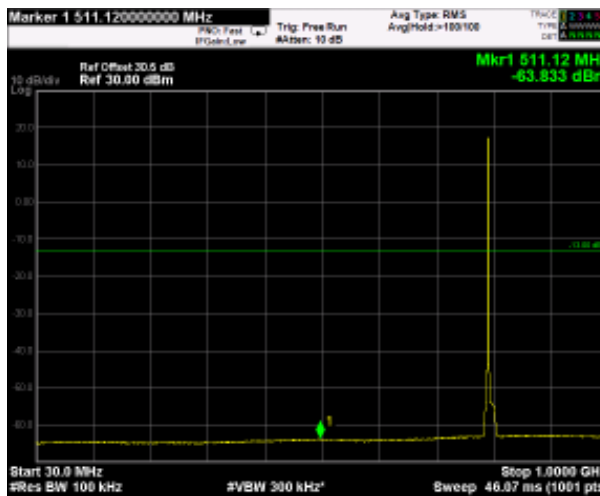

**30MHz-1GHz**

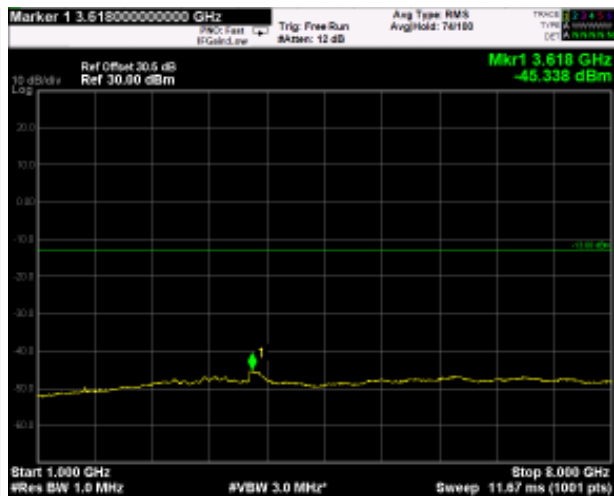

**1GHz-8GHz**



Spurious emissions at antenna terminal: 90.543(e)(1)

Special notes

On all frequencies between 763–775 MHz and 793–805 MHz, by a factor not less than  $76 + 10 \log(P)$  dB in a 6.25 kHz band segment, for base and fixed stations

$76 + 10 \log P (W) = 76 + 10 \log 0,40W = 72$   
 $P (W) = 0,40W = 26 \text{ dBm}$   
 $\rightarrow \text{limit: } 26 - 72 = -46 \text{ dBm/6,25kHz}$

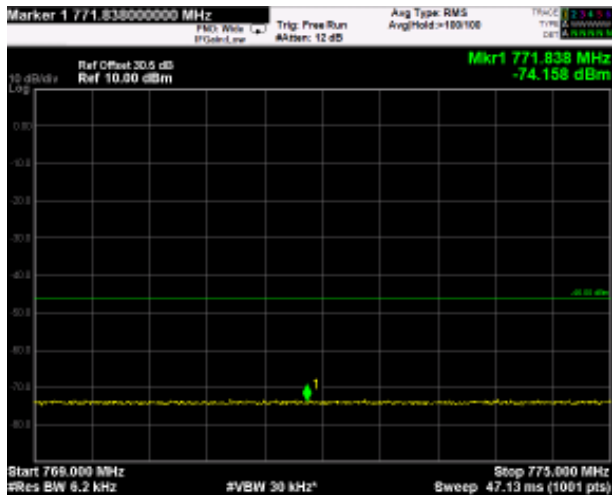

769MHz-775MHz

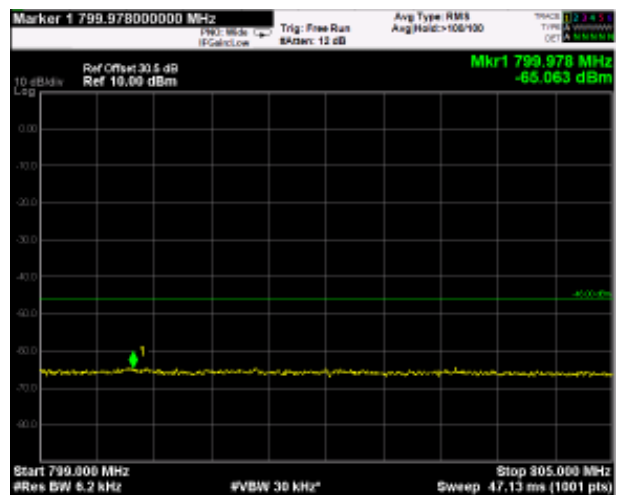

799MHz-805MHz

## Clause 90.543(e), 90.219(e)(3) Field strength of spurious radiation

### § 90.543(e)

For operations in the 758-768 MHz and the 788-798 MHz bands, the power of any emission outside the licensee's frequency band(s) of operation shall be attenuated below the transmitter power (P) within the licensed band(s) of operation, measured in watts, in accordance with the following:

- (1) On all frequencies between 769-775 MHz and 799-805 MHz, by a factor not less than  $76 + 10 \log (P)$  dB in a 6.25 kHz band segment, for base and fixed stations.
- (2) On all frequencies between 769-775 MHz and 799-805 MHz, by a factor not less than  $65 + 10 \log (P)$  dB in a 6.25 kHz band segment, for mobile and portable stations.
- (3) On any frequency between 775-788 MHz, above 805 MHz, and below 758 MHz, by at least  $43 + 10 \log (P)$  dB.
- (4) Compliance with the provisions of paragraphs (e)(1) and (2) of this section is based on the use of measurement instrumentation such that the reading taken with any resolution bandwidth setting should be adjusted to indicate spectral energy in a 6.25 kHz segment.
- (5) Compliance with the provisions of paragraph (e)(3) of this section is based on the use of measurement instrumentation employing a resolution bandwidth of 100 kHz or greater. However, in the 100 kHz bands immediately outside and adjacent to the frequency block, a resolution bandwidth of 30 kHz may be employed.

### § 90.219(e)(3)

Spurious emissions from a signal booster must not exceed  $-13$  dBm within any 100 kHz measurement bandwidth.

### § 2.1053 Measurements required: Field strength of spurious radiation.

- (a) Measurements shall be made to detect spurious emissions that may be radiated directly from the cabinet, control circuits, power leads, or intermediate circuit elements under normal conditions of installation and operation. Curves or equivalent data shall be supplied showing the magnitude of each harmonic and other spurious emission. For this test, single sideband, independent sideband, and controlled carrier transmitters shall be modulated under the conditions specified in paragraph (c) of §2.1049, as appropriate. For equipment operating on frequencies below 890 MHz, an open field test is normally required, with the measuring instrument antenna located in the far-field at all test frequencies. In the event it is either impractical or impossible to make open field measurements (e.g. a broadcast transmitter installed in a building) measurements will be accepted of the equipment as installed. Such measurements must be accompanied by a description of the site where the measurements were made showing the location of any possible source of reflections which might distort the field strength measurements. Information submitted shall include the relative radiated power of each spurious emission with reference to the rated power output of the transmitter, assuming all emissions are radiated from halfwave dipole antennas.
- (b) The measurements specified in paragraph (a) of this section shall be made for the following equipment:
  - (1) Those in which the spurious emissions are required to be 60 dB or more below the mean power of the transmitter.
  - (2) All equipment operating on frequencies higher than 25 MHz.
  - (3) All equipment where the antenna is an integral part of, and attached directly to the transmitter.
  - (4) Other types of equipment as required, when deemed necessary by the Commission.

Test date: 15-03-10

Test results: Pass

**Special notes**

- The spectrum was searched from 30 MHz to the 10<sup>th</sup> harmonic.
- The EUT was measured on three orthogonal axis.
- All measurements were performed at a distance of 3 m.
- Only the worst data presented in the test report.

**Special notes**

The results are the same both with maximum and minimum pass-band of the digital filter: the bandwidth of the signal is lower than minimum pass-band.

**Test data**

The D.U.T. was positioned according to the radiated emissions set-up

The D.U.T. antenna connector was terminated by a 50  $\Omega$  shielded dummy load.

The spectrum was searched from 30 MHz to 1 GHz (RBW 100 kHz) & 1 GHz (RBW 1 MHz) to the tenth harmonic of the carrier.

There were no emissions detected above the noise floor which was at least 20 dB below the specification limit.

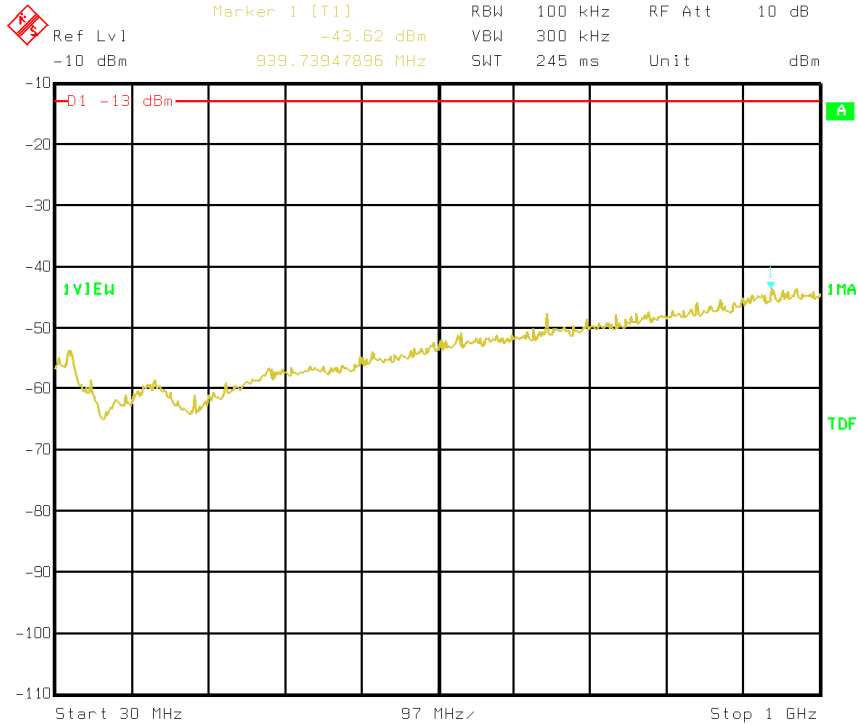

30MHz-1GHz - H Pol

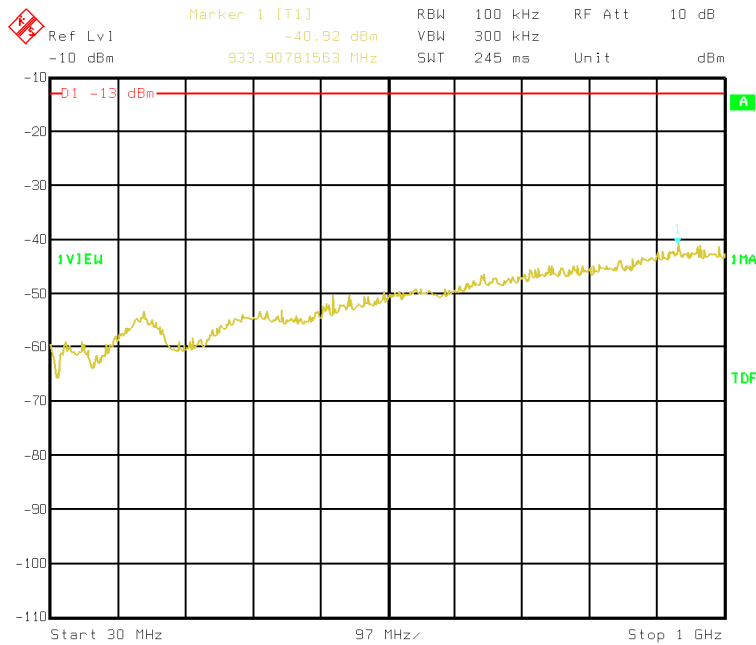

30MHz-1GHz - V Pol

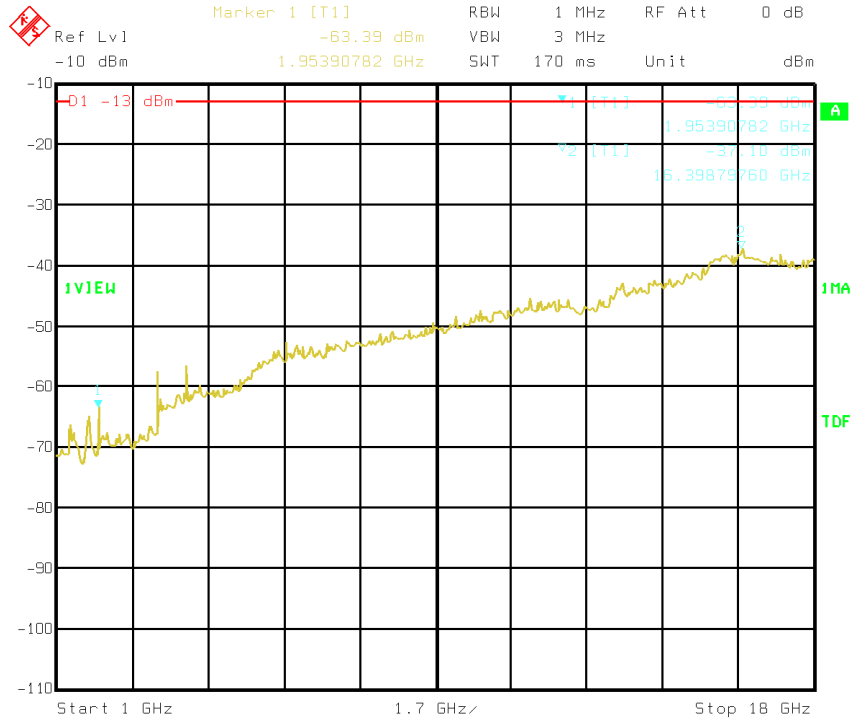

1GHz-18GHz – H Pol

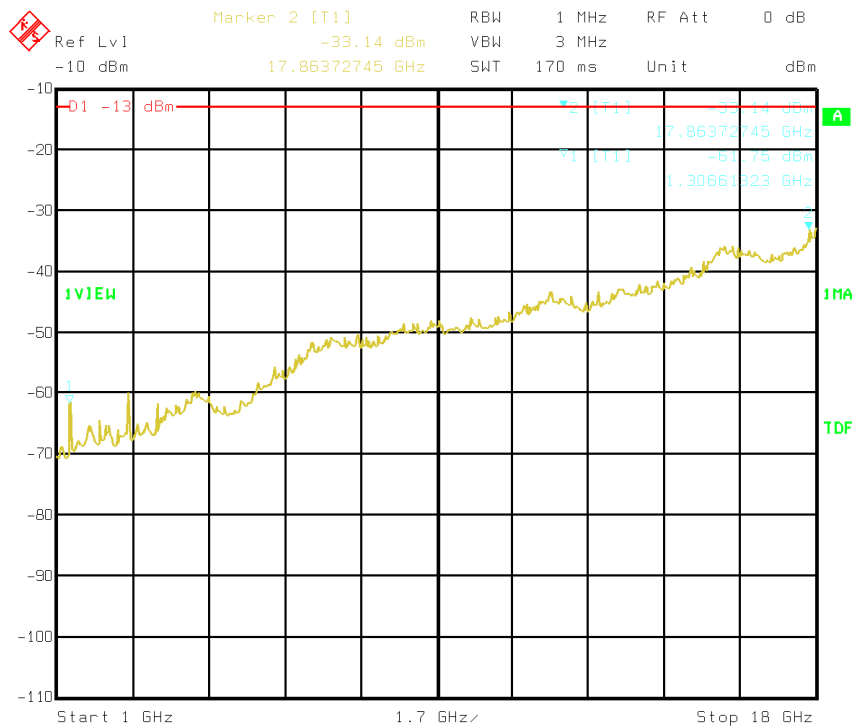

1GHz-18GHz – V Pol

### Clause 90.543(f) Radiated spurious emissions within 1559–1610 MHz band

#### § 90.543(f)

For operations in the 763-775 MHz and , 793-805 MHz bands, all emissions including harmonics in the band 1559–1610 MHz shall be limited to  $-70$  dBW/MHz equivalent isotropically radiated power (EIRP) for wideband signals, and  $-80$  dBW EIRP for discrete emissions of less than 700 Hz bandwidth. For the purpose of equipment authorization, a transmitter shall be tested with an antenna that is representative of the type that will be used with the equipment in normal operation

Note:

Method of measurement according to TIA-603-C (EIRP in GNSS band: 1.556 to 1.610 GHz) .  
 $\Delta$  Band = 51 MHz, Correction Factor calculated at central band 1604.5 MHz. in Fraunhofer Region.

Test date: 15-03-10

Test results: Pass

#### Special notes

- The spectrum was searched from 1559–1610 MHz.
- All measurements were performed using a peak detector.
- The measurements were performed at the distance of 3 m.
- RBW was set to 1 MHz and VBW was wider than RBW

Result of U.L. 29 dBm, 795.5 MHz,

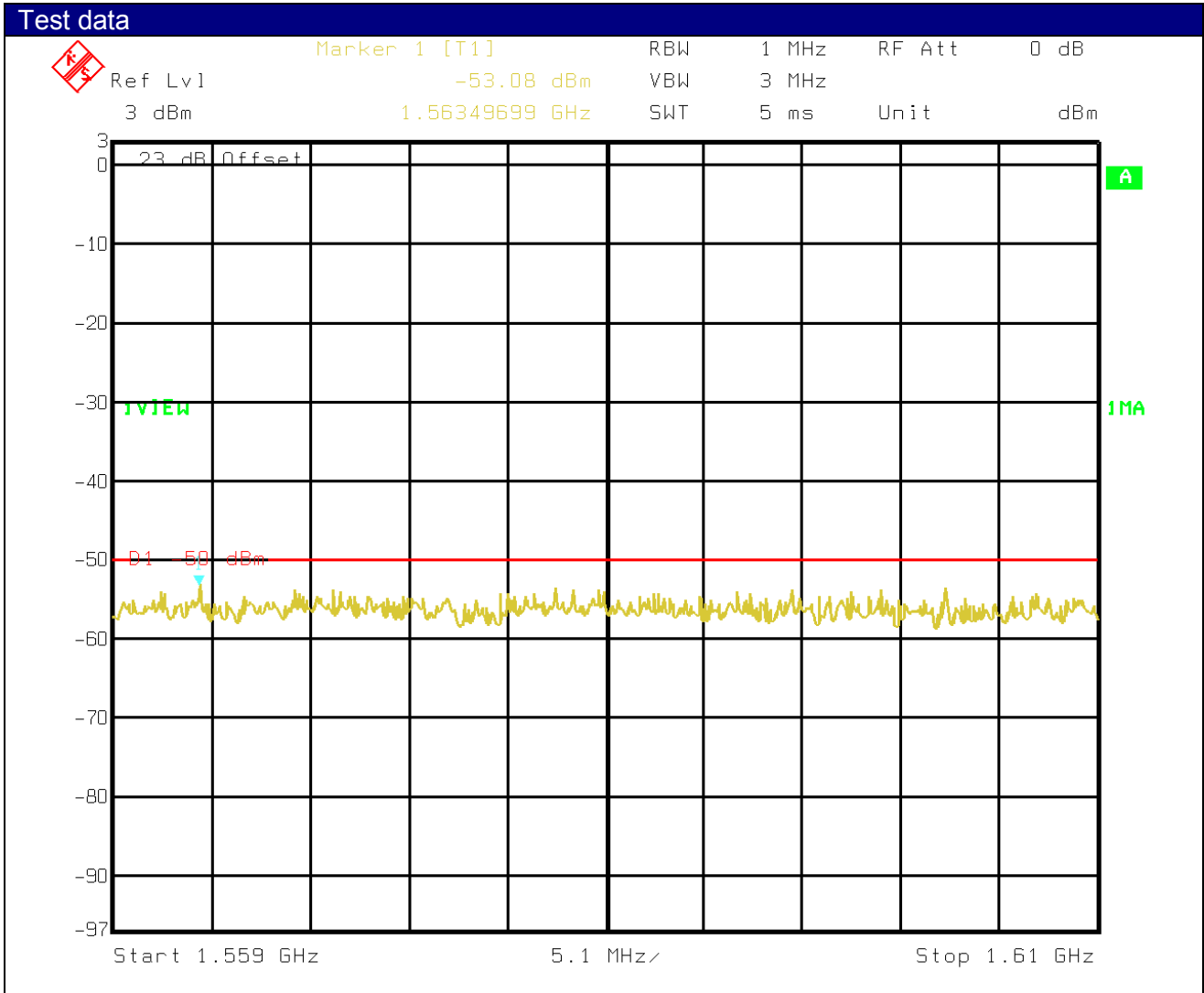

Spurious emissions measurement results:				
Frequency (MHz)	Polarization. V/H	Result Eirp (dBm)	Limit eirp (dBm)	Margin (dB)
1563.49	V(max. eirp)	-53.08	-50	-3.08

Limit used for discrete emissions: -80 dBw = -50 dBm

## Clause 90.219(e)(2) Noise Figure

**§ 90.219(e)(2)**  
 The noise figure of a signal booster must not exceed 9 dB in either direction.

Test date: 2015-03-10  
 Test results: Pass

**Special notes**  
 To demonstrate compliance with these requirement on whole band, maximum pass-band of the digital filter is applied.

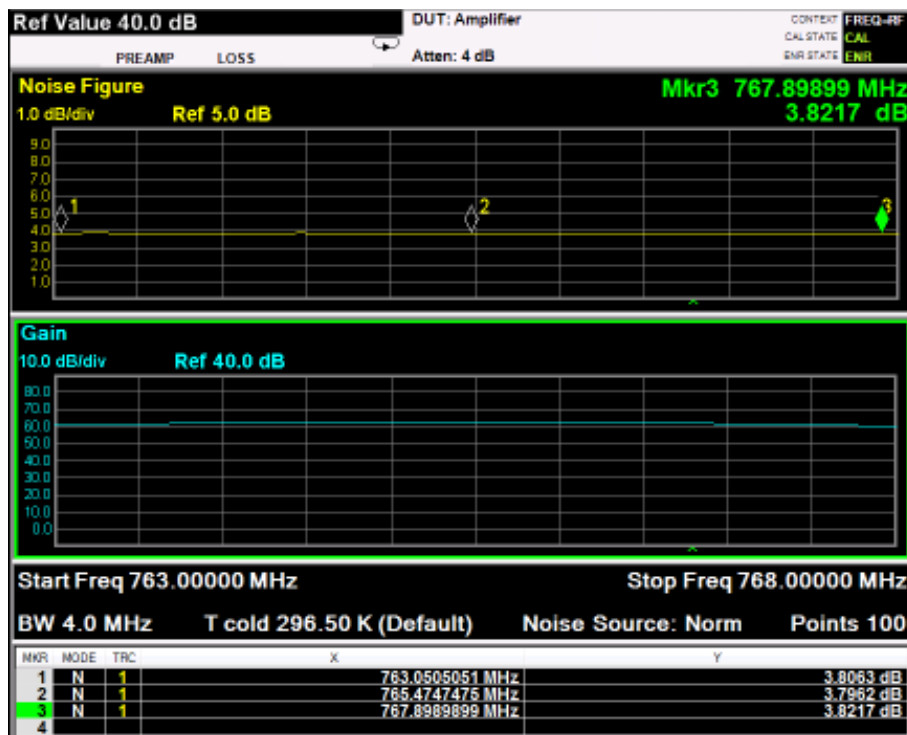



**Clause 935210 D02v02r01 Appendix D.3 (i) Intermodulation**

Intermodulation – Test all modulation types [TDMA, CDMA, and FM (covers GSM and F1D)]

(1) For part 90 boosters, apply the requirements of § 90.219(d) and (e).

(2) For other boosters: (i) CW signal rather than typical signal is acceptable (for FM).

(ii) At maximum drive level, for each modulation: one test with three tones, or two tests (high-band edge, low- band edge) with two tones

(iii) Limit usually is -13 dBm conducted.

(iv) Not needed for Single Channel systems.

(v) Combination of modulation types not needed.

Test date: [2015-03-10](#)

Test results: [Pass](#)

**Special notes**

The results are the same both with maximum and minimum pass-band of the digital filter for measures outside the pass-band.

**Mod. iDEN (QAM) (Down-link)**

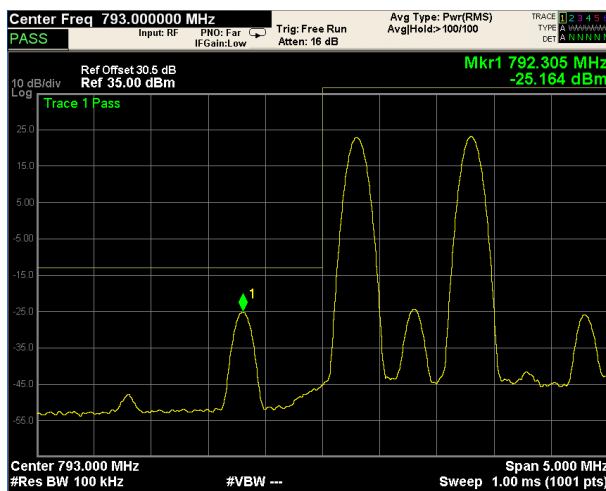

Low Band Edge

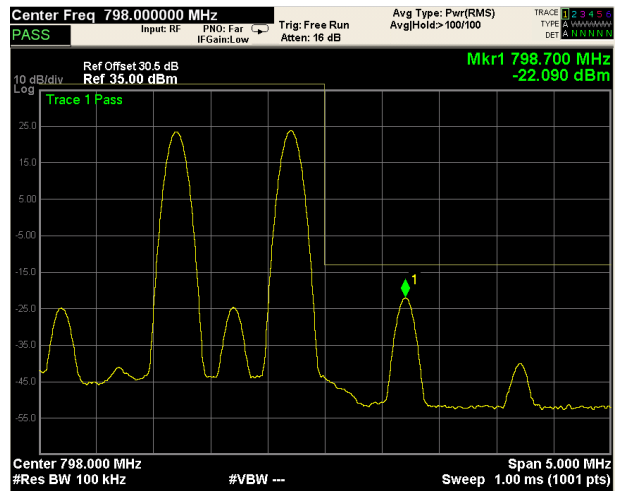

High Band Edge

### Clause 935210 D02v02r01 (D.3)(I) Out of band rejection

Out of Band Rejection – Test for rejection of out of band signals.  
Filter frequency response plots are acceptable.

Test date: 2015-03-10

Test results: Pass

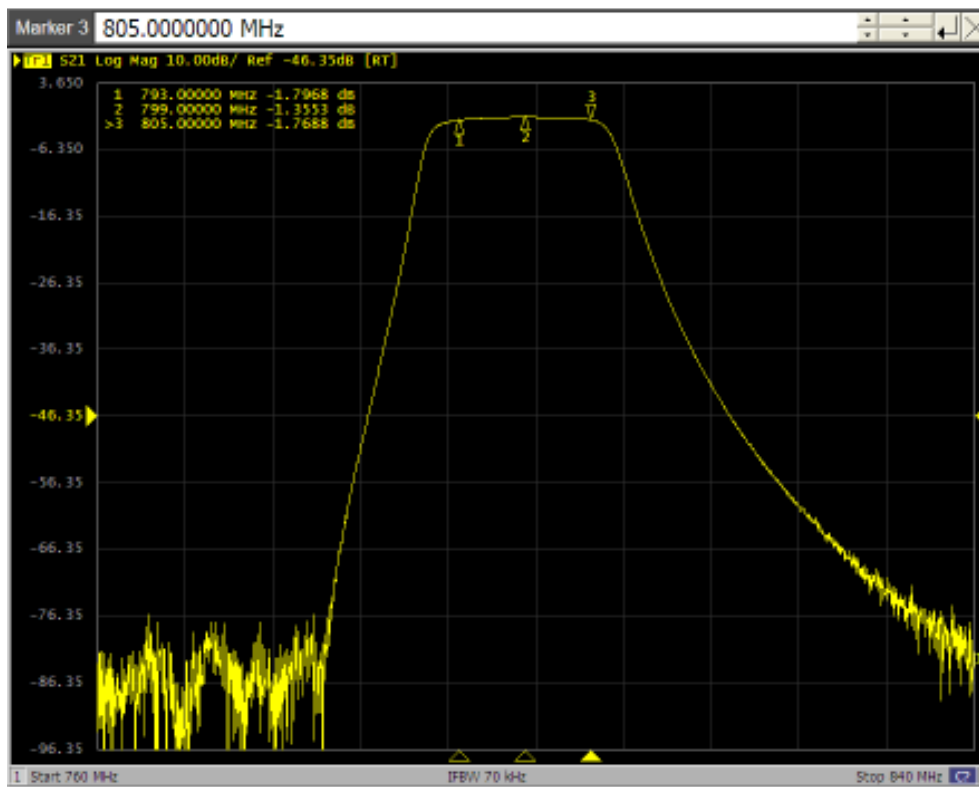

## Appendix B: Block diagrams of test set-ups

### Radiated emissions set-up

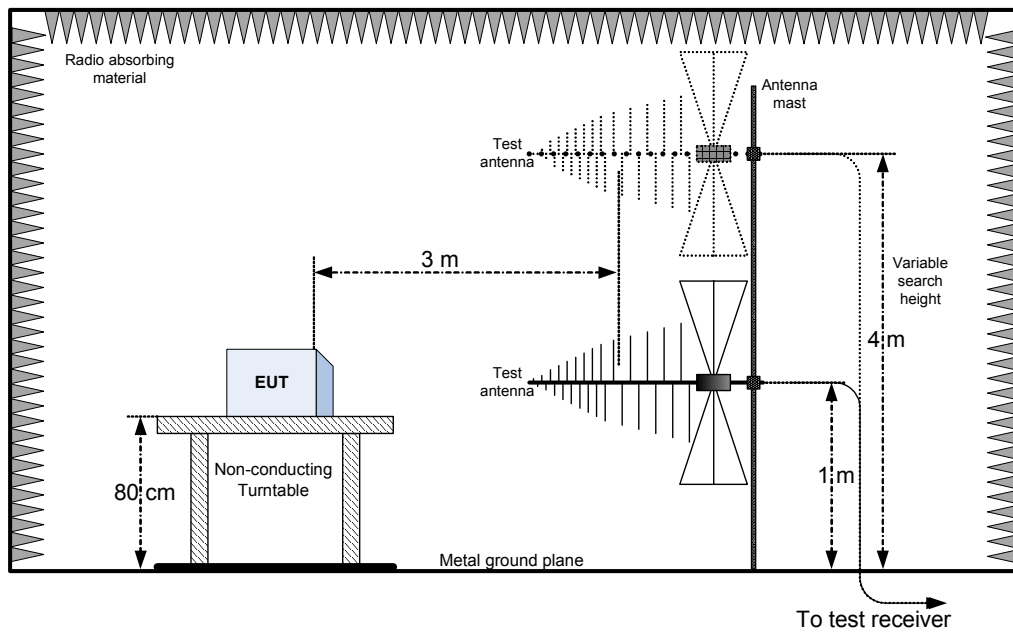

### Substitution method set-up

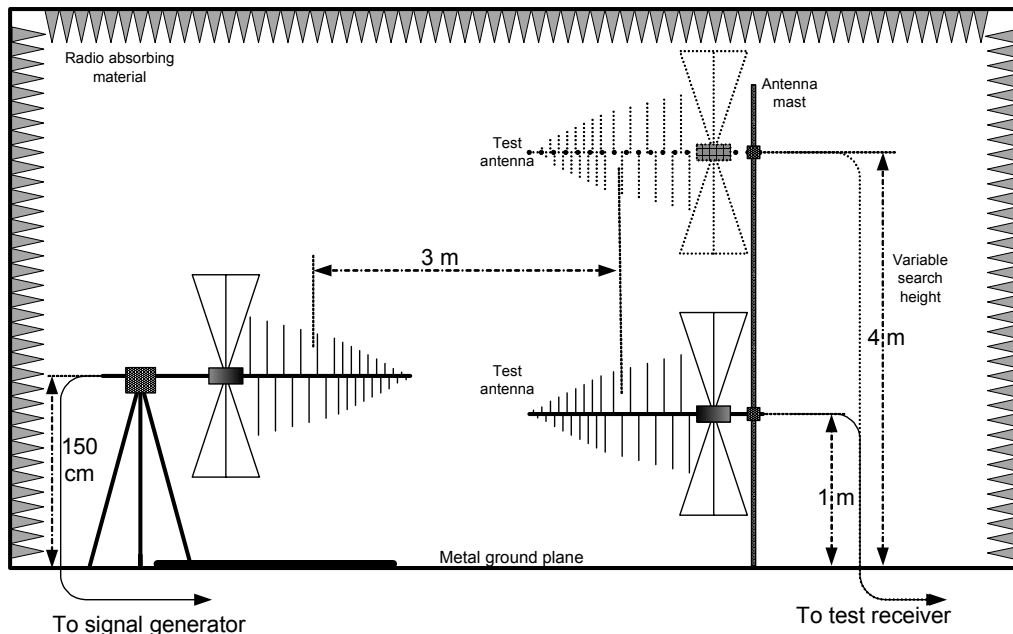

## Appendix C: EUT Photos

### Photo Set up





Photo EUT







## Label EUT

TEKO TELECOM  
MODEL: TDFE-7F  
FCC ID: XM2-DFE7F

**WARNING. This is NOT a CONSUMER device. This is a 90.219 Class B signal booster. It is designed for installation by FCC LICENSEES and QUALIFIED INSTALLERS. You MUST have an FCC LICENSE or express consent of an FCC Licensee to operate this device. You MUST register Class B signal boosters (as defined in 47 CFR 90.219) online at [www.fcc.gov/signal-boosters/registration](http://www.fcc.gov/signal-boosters/registration). Unauthorized use may result in significant forfeiture penalties, including penalties in excess of \$100,000 for each continuing violation.**