

TEST REPORT

Test report no.: 1-4835/22-02-04-A

BNetzA-CAB-02/21-102

Testing laboratory

CTC advanced GmbH

Untertuerkheimer Strasse 6 – 10

66117 Saarbruecken / Germany

Phone: + 49 681 5 98 - 0

Fax: + 49 681 5 98 - 9075

Internet: <https://www.ctcadvanced.com>

e-mail: mail@ctcadvanced.com

Accredited Testing Laboratory:

The testing laboratory (area of testing) is accredited according to DIN EN ISO/IEC 17025 (2018-03) by the Deutsche Akkreditierungsstelle GmbH (DAkkS)

The accreditation is valid for the scope of testing procedures as stated in the accreditation certificate starting with the registration number: D-PL-12076-01.

Applicant

Ingenico

9 Avenue de la Gare – Rovaltain TGV

26958 Valence Cedex 9 / FRANCE

Phone: -/-

Contact: Nicolas Jacquemont

e-mail: nicolas.jacquemont@ingenico.com

Manufacturer

Ingenico

9 Avenue de la Gare – Rovaltain TGV

26958 Valence Cedex 9 / FRANCE

Test standard/s

FCC - Title 47 CFR Part 15 FCC - Title 47 of the Code of Federal Regulations; Chapter I; Part 15 - Radio frequency devices

RSS - 247 Issue 2 Digital Transmission Systems (DTSS), Frequency Hopping Systems (FHSs) and Licence - Exempt Local Area Network (LE-LAN) Devices

For further applied test standards please refer to section 3 of this test report.

Test Item

Kind of test item: **Payment Terminal**

Model name: **Move/5000**

FCC ID: **XKB-M5CL4GWBTV2**

ISED certification number: **2586D-M5CL4GWBTV2**

Frequency: 5150 MHz to 5350 MHz & 5470 MHz to 5850 MHz

Technology tested: IEEE 802.11 (W-LAN)

Antenna: Integrated antenna

Power supply: 3.6 V DC by battery; AC/ DC Adaptor PSM0SE-050D, 50/60 Hz

Temperature range: -10°C to +55°C

This test report is electronically signed and valid without handwritten signature. For verification of the electronic signatures, the public keys can be requested at the testing laboratory.

Test report authorized:

Marco Bertolino
Lab Manager
Radio Communications

Test performed:

David Lang
Lab Manager
Radio Communications

1 Table of contents

| | | |
|--------|--|----|
| 1 | Table of contents | 2 |
| 2 | General information | 4 |
| 2.1 | Notes and disclaimer | 4 |
| 2.2 | Application details | 4 |
| 2.3 | Test laboratories sub-contracted | 4 |
| 3 | Test standard/s, references and accreditations | 5 |
| 4 | Reporting statements of conformity – decision rule | 6 |
| 5 | Test environment | 6 |
| 6 | Test item..... | 7 |
| 6.1 | General description | 7 |
| 6.2 | Additional information | 7 |
| 7 | Description of the test setup..... | 8 |
| 7.1 | Shielded semi anechoic chamber | 9 |
| 7.2 | Shielded fully anechoic chamber..... | 10 |
| 7.3 | Radiated measurements > 18 GHz..... | 11 |
| 7.4 | Conducted measurements with peak power meter & spectrum analyzer | 12 |
| 7.5 | AC conducted | 13 |
| 8 | Sequence of testing | 14 |
| 8.1 | Sequence of testing radiated spurious 9 kHz to 30 MHz | 14 |
| 8.2 | Sequence of testing radiated spurious 30 MHz to 1 GHz | 15 |
| 8.3 | Sequence of testing radiated spurious 1 GHz to 18 GHz | 16 |
| 8.4 | Sequence of testing radiated spurious above 18 GHz | 17 |
| 9 | Measurement uncertainty | 18 |
| 10 | Summary of measurement results | 19 |
| 11 | Additional comments | 20 |
| 12 | Measurement results | 22 |
| 12.1 | Identify worst case data rate | 22 |
| 12.2 | Antenna gain..... | 23 |
| 12.3 | Duty cycle | 25 |
| 12.4 | Maximum output power..... | 26 |
| 12.4.1 | Maximum output power according to FCC requirements | 26 |
| 12.4.2 | Maximum output power according to ISED requirements..... | 28 |
| 12.5 | Power spectral density | 32 |
| 12.5.1 | Power spectral density according to FCC requirements..... | 32 |
| 12.5.2 | Power spectral density according to ISED requirements | 35 |
| 12.6 | Minimum emission bandwidth for the band 5.725-5.85 GHz..... | 38 |
| 12.7 | Spectrum bandwidth / 26 dB bandwidth..... | 39 |
| 12.8 | Occupied bandwidth / 99% emission bandwidth | 42 |
| 12.9 | Band edge compliance radiated..... | 45 |
| 12.10 | Spurious emissions radiated below 30 MHz..... | 49 |
| 12.11 | Spurious emissions radiated 30 MHz to 1 GHz | 61 |

| | | |
|-------|---|----|
| 12.12 | Spurious emissions radiated 1 GHz to 40 GHz | 70 |
| 12.13 | Spurious emissions conducted < 30 MHz..... | 91 |
| 13 | Observations | 94 |
| 14 | Glossary | 94 |
| 15 | Document history..... | 95 |
| 16 | Accreditation Certificate – D-PL-12076-01-04..... | 95 |
| 17 | Accreditation Certificate – D-PL-12076-01-05..... | 96 |

2 General information

2.1 Notes and disclaimer

The test results of this test report relate exclusively to the test item specified in this test report. CTC advanced GmbH does not assume responsibility for any conclusions and generalizations drawn from the test results with regard to other specimens or samples of the type of the equipment represented by the test item.

The test report may only be reproduced or published in full. Reproduction or publication of extracts from the report requires the prior written approval of CTC advanced GmbH.

The testing service provided by CTC advanced GmbH has been rendered under the current "General Terms and Conditions for CTC advanced GmbH".

CTC advanced GmbH will not be liable for any loss or damage resulting from false, inaccurate, inappropriate or incomplete product information provided by the customer.

Under no circumstances does the CTC advanced GmbH test report include any endorsement or warranty regarding the functionality, quality or performance of any other product or service provided.

Under no circumstances does the CTC advanced GmbH test report include or imply any product or service warranties from CTC advanced GmbH, including, without limitation, any implied warranties of merchantability, fitness for purpose, or non-infringement, all of which are expressly disclaimed by CTC advanced GmbH.

All rights and remedies regarding vendor's products and services for which CTC advanced GmbH has prepared this test report shall be provided by the party offering such products or services and not by CTC advanced GmbH. In no case this test report can be considered as a Letter of Approval.

This test report is electronically signed and valid without handwritten signature. For verification of the electronic signatures, the public keys can be requested at the testing laboratory.

This test report replaces the test report with the number 1-4835/22-02-04 and dated 2022-12-08.

2.2 Application details

Date of receipt of order: 2022-08-04

Date of receipt of test item: 2022-08-01

Start of test:* 2022-08-09

End of test:* 2022-12-02

Person(s) present during the test: -/-

*Date of each measurement, if not shown in the plot, can be requested. Dates are stored in the measurement software.

2.3 Test laboratories sub-contracted

None

3 Test standard/s, references and accreditations

| Test standard | Date | Description |
|---|---------------|--|
| FCC - Title 47 CFR Part 15 | -/- | FCC - Title 47 of the Code of Federal Regulations; Chapter I; Part 15 - Radio frequency devices |
| RSS - 247 Issue 2 | February 2017 | Digital Transmission Systems (DTSs), Frequency Hopping Systems (FHSs) and Licence - Exempt Local Area Network (LE-LAN) Devices |
| RSS - Gen Issue 5 incl. Amendment 1 & 2 | February 2021 | Spectrum Management and Telecommunications Radio Standards Specification - General Requirements for Compliance of Radio Apparatus |

| Guidance | Version | Description |
|----------------------|---------|---|
| KDB 789033 D02 | v02r01 | Guidelines for Compliance Testing of Unlicensed National Information Infrastructure (U-NII) Devices - Part 15, Subpart E |
| ANSI C63.4-2014 | -/- | American National Standard for Methods of Measurement of Radio-Noise Emissions from Low-Voltage Electrical and Electronic Equipment in the Range of 9 kHz to 40 GHz |
| ANSI C63.10-2013 | -/- | American National Standard of Procedures for Compliance Testing of Unlicensed Wireless Devices |
| UNII: KDB 905462 D02 | v02 | Compliance measurement procedures for unlicensed - national information infrastructure devices operating in the 5250 - 5350 MHz and 5470 - 5725 MHz bands incorporating dynamic frequency selection |

| Accreditation | Description | |
|------------------|---|---|
| D-PL-12076-01-04 | Telecommunication and EMC Canada https://www.dakks.de/as/ast/d/D-PL-12076-01-04e.pdf |   Deutsche Akkreditierungsstelle D-PL-12076-01-04 |
| D-PL-12076-01-05 | Telecommunication FCC requirements https://www.dakks.de/as/ast/d/D-PL-12076-01-05e.pdf |   Deutsche Akkreditierungsstelle D-PL-12076-01-05 |

ISED Testing Laboratory Recognized Listing Number: DE0001
FCC designation number: DE0002

4 Reporting statements of conformity – decision rule

Only the measured values related to their corresponding limits will be used to decide whether the equipment under test meets the requirements of the test standards listed in chapter 3.

The measurement uncertainty is mentioned in this test report, see chapter 9, but is not taken into account - neither to the limits nor to the measurement results. Measurement results with a smaller margin to the corresponding limits than the measurement uncertainty have a potential risk of more than 5% that the decision might be wrong."

measured value, measurement uncertainty, verdict

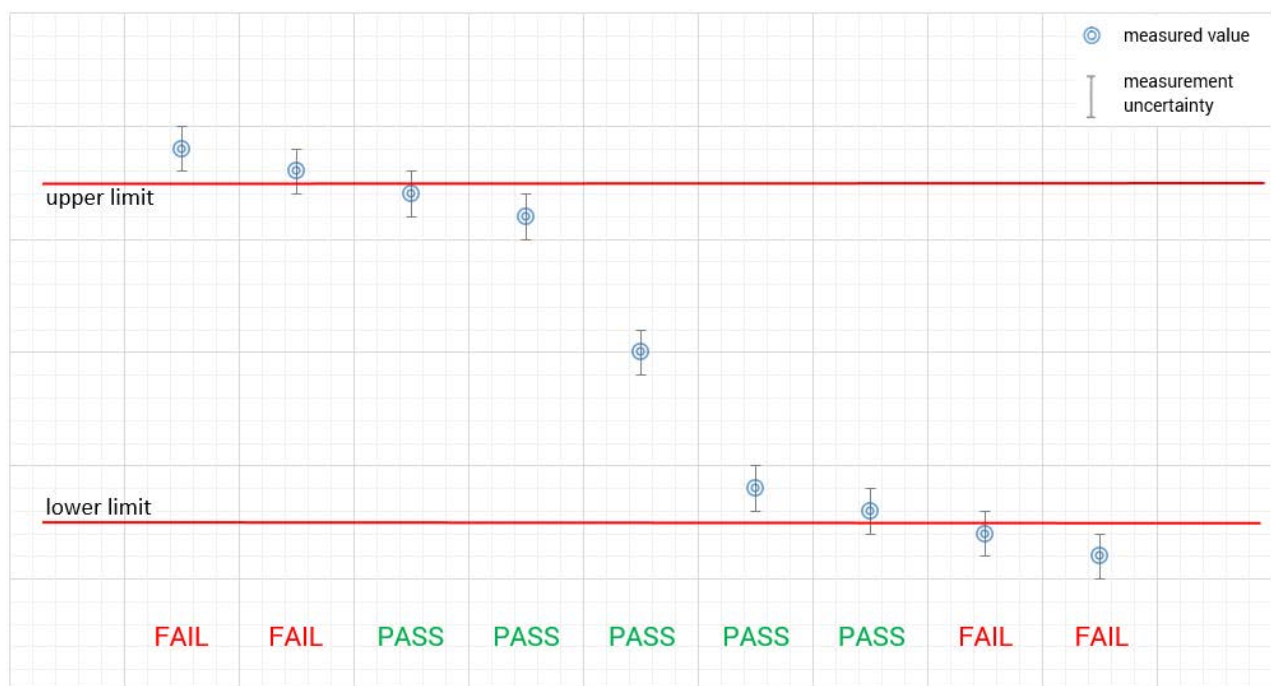

5 Test environment

| | | |
|---------------------------|--|---|
| Temperature | : T_{nom} T_{max} T_{min} | +20 °C during room temperature tests No testing under extreme temperature conditions required! No testing under extreme temperature conditions required! |
| Relative humidity content | : | 55 % |
| Barometric pressure | : | 1021 hpa |
| Power supply | : V_{nom} V_{max} V_{min} | 3.6 V DC by battery; AC/ DC Adaptor PSM0SE-050D, 50/60 Hz No testing under extreme voltage conditions required! No testing under extreme voltage conditions required! |

6 Test item

6.1 General description

| | | |
|----------------------------|---|---|
| Kind of test item | : | Payment Terminal |
| Model name | : | Move/5000 |
| HMN | : | -/- |
| PMN | : | Move/5000 |
| HVIN | : | Move/5000 CL/4G/WiFi/BT V2 |
| FVIN | : | -/- |
| S/N serial number | : | Rad. 220977303201297624453696 (Move 5000) Cond. 222597303201301626781904 (Move 5000) |
| Hardware status | : | NXP IWP416 |
| Software status | : | OS050621++_HTB0308 |
| Firmware status | : | -/- |
| Frequency band | : | 5150 MHz to 5350 MHz & 5470 MHz to 5850 MHz |
| Type of radio transmission | : | OFDM |
| Use of frequency spectrum | : | |
| Type of modulation | : | CCK, (D)BPSK, (D)QPSK, 16 – QAM, 64 – QAM |
| Number of channels | : | 5 GHz: 24 (20 MHz), 11 (40 MHz) |
| Antenna | : | Integrated antenna |
| Power supply | : | 3.6 V DC by battery; AC/ DC Adaptor PSM0SE-050D, 50/60 Hz |
| Temperature range | : | -10°C to +55°C |

6.2 Additional information

The content of the following annexes is defined in the QA. It may be that not all of the listed annexes are necessary for this report, thus some values in between may be missing.

Test setup and EUT photos are included in test report:

- 1-4835/22-02-02_AnnexA
- 1-4835/22-02-02_AnnexB
- 1-4835/22-02-02_AnnexD

7 Description of the test setup

Typically, the calibrations of the test apparatus are commissioned to and performed by an accredited calibration laboratory. The calibration intervals are determined in accordance with the DIN EN ISO/IEC 17025. In addition to the external calibrations, the laboratory executes comparison measurements with other calibrated test systems or effective verifications. Weekly chamber inspections and range calibrations are performed. Where possible, RF generating and signaling equipment as well as measuring receivers and analyzers are connected to an external high-precision 10 MHz reference (GPS-based or rubidium frequency standard).

In order to simplify the identification of the equipment used at some special tests, some items of test equipment and ancillaries can be provided with an identifier or number in the equipment list below (Lab/Item).

Each block diagram listed can contain several test setup configurations. All devices belonging to a test setup are identified with the same letter syntax. For example: Column Setup and all devices with an A.

Agenda: Kind of Calibration

| | | | |
|------|--|-----|--|
| k | calibration / calibrated | EK | limited calibration |
| ne | not required (k, ev, izw, zw not required) | zw | cyclical maintenance (external cyclical maintenance) |
| ev | periodic self verification | izw | internal cyclical maintenance |
| Ve | long-term stability recognized | g | blocked for accredited testing |
| vlk! | Attention: extended calibration interval | | |
| NK! | Attention: not calibrated | *) | next calibration ordered / currently in progress |

7.1 Shielded semi anechoic chamber

The radiated measurements are performed in vertical and horizontal plane in the frequency range from 30 MHz to 1 GHz in semi-anechoic chambers. The EUT is positioned on a non-conductive support with a height of 0.80 m above a conductive ground plane that covers the whole chamber. The receiving antennas are conform to specifications ANSI C63. These antennas can be moved over the height range between 1.0 m and 4.0 m in order to search for maximum field strength emitted from EUT. The measurement distances between EUT and receiving antennas are indicated in the test setups for the various frequency ranges. For each measurement, the EUT is rotated in all three axes until the maximum field strength is received. The wanted and unwanted emissions are received by spectrum analyzers where the detector modes and resolution bandwidths over various frequency ranges are set according to requirement ANSI C63.

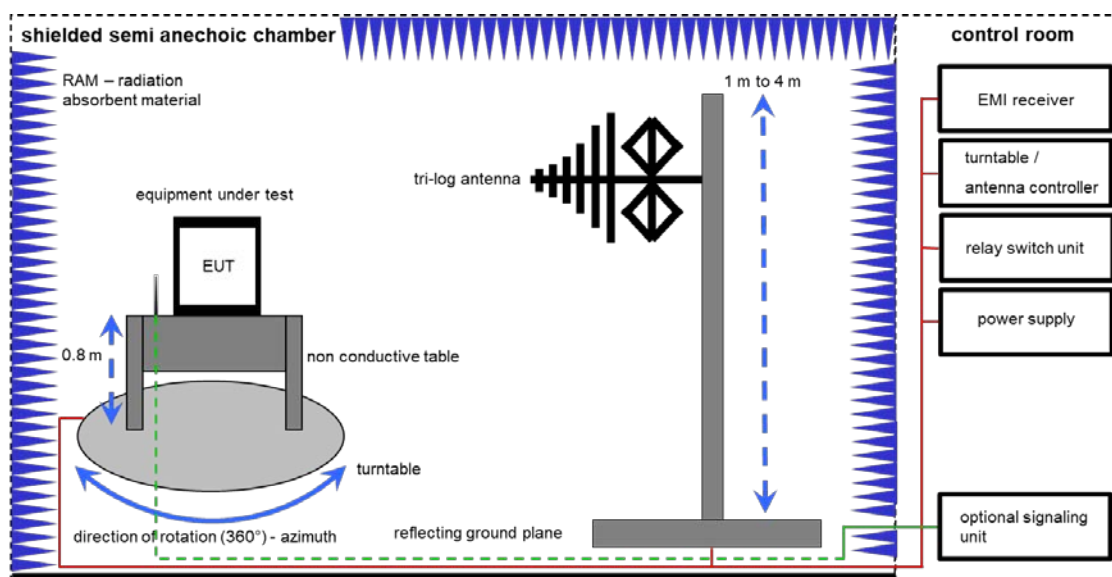

Measurement distance: tri-log antenna 10 meter
EMC32 software version: 10.59.00

$$FS = UR + CL + AF$$

(FS-field strength; UR-voltage at the receiver; CL-loss of the cable; AF-antenna factor)

Example calculation:

$$FS [dB\mu V/m] = 12.35 [dB\mu V/m] + 1.90 [dB] + 16.80 [dB/m] = 31.05 [dB\mu V/m] (35.69 \mu V/m)$$

Equipment table:

| No. | Setup | Equipment | Type | Manufacturer | Serial No. | INV. No. | Kind of Calibration | Last Calibration | Next Calibration |
|-----|-------|---|------------|-----------------------------|-----------------|-----------|---------------------|------------------|------------------|
| 1 | A | Semi anechoic chamber | 3000023 | MWB AG | -/- | 300000551 | ne | -/- | -/- |
| 2 | A | Analyzer-Reference-System (Harmonics and Flicker) | ARS 16/1 | SPS | A3509 07/0 0205 | 300003314 | vIKI! | 29.12.2021 | 31.12.2023 |
| 3 | A | Antenna Tower | Model 2175 | ETS-Lindgren | 64762 | 300003745 | izw | -/- | -/- |
| 4 | A | Positioning Controller | Model 2090 | ETS-Lindgren | 64672 | 300003746 | izw | -/- | -/- |
| 5 | A | TRILOG Broadband Test-Antenna 30 MHz - 3 GHz | VULB9163 | Schwarzbeck Mess-Elektronik | 295 | 300003787 | vIKI! | 12.04.2021 | 30.04.2023 |
| 6 | A | Turntable | 2089-4.0 | EMCO | -/- | 300004394 | ne | -/- | -/- |
| 7 | A | PC | TecLine | F+W | -/- | 300004388 | ne | -/- | -/- |
| 8 | A | EMI Test Receiver | ESR3 | Rohde & Schwarz | 102587 | 300005771 | k | 20.05.2022 | 19.05.2023 |

7.2 Shielded fully anechoic chamber

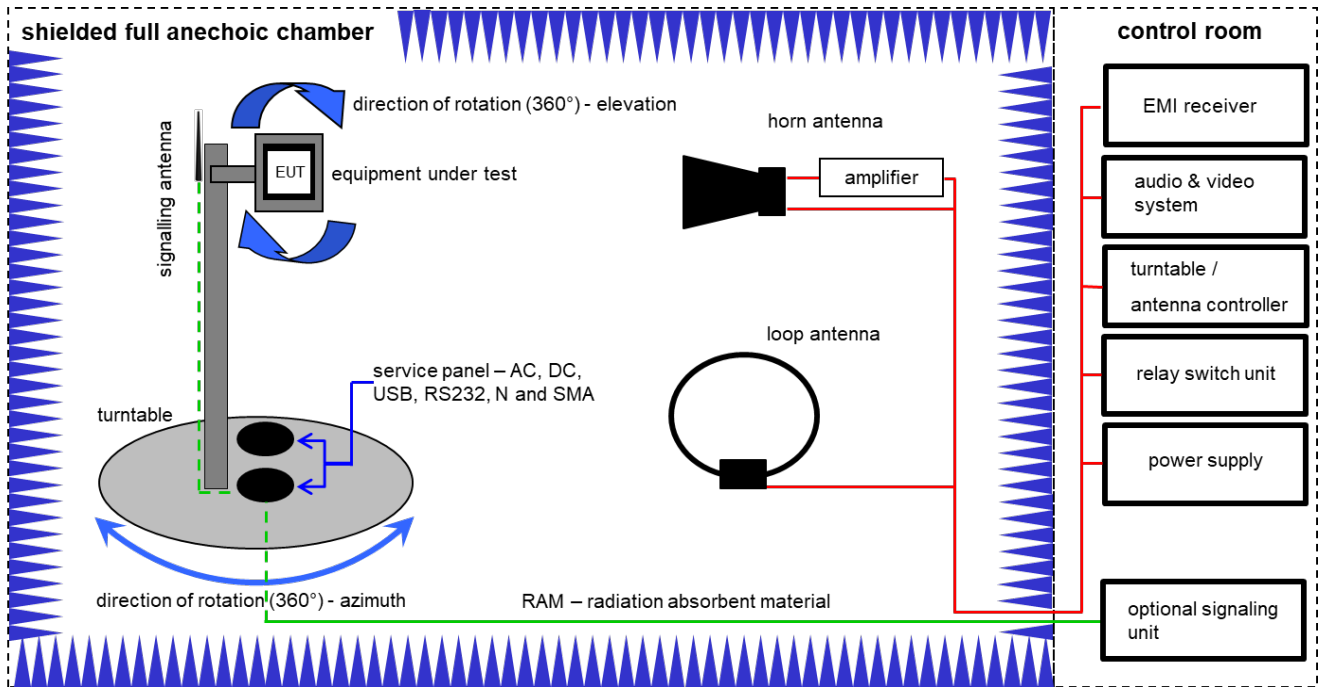

Measurement distance: horn antenna 3 meter; loop antenna 3 meter / 1 meter

$$FS = UR + CA + AF$$

(FS-field strength; UR-voltage at the receiver; CA-loss of the signal path; AF-antenna factor)

Example calculation:

$$FS \text{ [dB}\mu\text{V/m]} = 40.0 \text{ [dB}\mu\text{V/m]} + (-35.8) \text{ [dB]} + 32.9 \text{ [dB/m]} = 37.1 \text{ [dB}\mu\text{V/m]} \text{ (71.61 } \mu\text{V/m)}$$

Equipment table:

| No. | Setup | Equipment | Type | Manufacturer | Serial No. | INV. No. | Kind of Calibration | Last Calibration | Next Calibration |
|-----|-------|--|-------------------------|----------------------|------------|-----------|---------------------|------------------|------------------|
| 1 | A, B | Active Loop Antenna 9 kHz to 30 MHz | 6502 | EMCO | 2210 | 300001015 | vKI! | 01.07.2021 | 31.07.2023 |
| 2 | A, B | Switch / Control Unit | 3488A | HP | * | 300000199 | ne | -/- | -/- |
| 3 | A, B | Double-Ridged Waveguide Horn Antenna 1-18.0GHz | 3115 | EMCO | 8812-3089 | 300000307 | vKI! | 11.02.2022 | 29.02.2024 |
| 4 | A, B | EMI Test Receiver 20Hz- 26,5GHz | ESU26 | R&S | 100037 | 300003555 | k | 09.12.2021 | 31.12.2022 |
| 5 | A, B | Highpass Filter | WHK1.1/15G-10SS | Wainwright | 3 | 300003255 | ev | -/- | -/- |
| 6 | A, B | Highpass Filter | WHKX7.0/18G-8SS | Wainwright | 19 | 300003790 | ne | -/- | -/- |
| 7 | A, B | Broadband Amplifier 0.5-18 GHz | CBLU5184540 | CERNEX | 22049 | 300004481 | ev | -/- | -/- |
| 8 | A, B | 4U RF Switch Platform | L4491A | Agilent Technologies | MY50000037 | 300004509 | ne | -/- | -/- |
| 9 | A, B | NEXIO EMV-Software | BAT EMC V3.21.0.32 | EMCO | -/- | 300004682 | ne | -/- | -/- |
| 10 | A, B | PC | ExOne | F+W | -/- | 300004703 | ne | -/- | -/- |
| 11 | A, B | RF-Amplifier | AMF-6F06001800-30-10P-R | NARDA-MITEQ Inc | 2011572 | 300005241 | ev | -/- | -/- |

7.3 Radiated measurements > 18 GHz

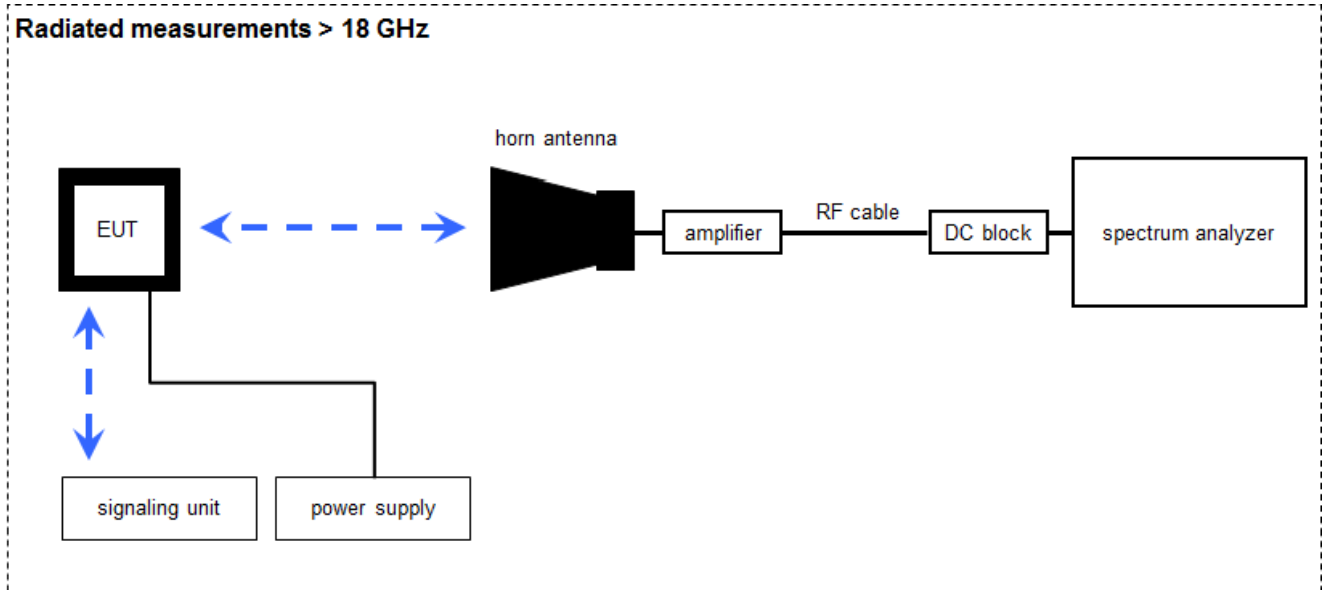

Measurement distance: horn antenna 50 cm

$$FS = UR + CA + AF$$

(FS-field strength; UR-voltage at the receiver; CA-loss signal path & distance correction; AF-antenna factor)

Example calculation:

$$FS [dB\mu V/m] = 40.0 [dB\mu V/m] + (-60.1) [dB] + 36.74 [dB/m] = 16.64 [dB\mu V/m] (6.79 \mu V/m)$$

Equipment table:

| No. | Setup | Equipment | Type | Manufacturer | Serial No. | INV. No. | Kind of Calibration | Last Calibration | Next Calibration |
|-----|-------|--|--------------------|----------------|------------------|-----------|---------------------|------------------|------------------|
| 1 | A | Microwave System Amplifier, 0.5-26.5 GHz | 83017A | HP | 00419 | 300002268 | ev | -/- | -/- |
| 2 | A | Std. Gain Horn Antenna 18.0-26.5 GHz | 638 | Narda | 01096 | 300000486 | vKI! | 17.01.2022 | 31.01.2024 |
| 3 | B | Std. Gain Horn Antenna 26.5-40.0 GHz | V637 | Narda | 82-16 | 300000510 | vKI! | 17.01.2022 | 31.01.2024 |
| 4 | A, B | Spectrum Analyzer 20 Hz - 50 GHz | FSU50 | R&S | 200012 | 300003443 | NK! | -/- | -/- |
| 5 | B | Broadband Low Noise Amplifier 18-50 GHz | CBL18503070-XX | CERNEX | 19338 | 300004273 | ev | -/- | -/- |
| 6 | A, B | Signal analyzer | FSV40 | Rohde&Schwarz | 101042 | 300004517 | k | 25.01.2022 | 31.01.2023 |
| 7 | A, B | RF-Cable | ST18/SMAM/SMAM /48 | Huber & Suhner | Batch no. 600918 | 400001182 | ev | -/- | -/- |
| 8 | A, B | DC-Blocker 0.1-40 GHz | 8141A | Inmet | -/- | 400001185 | ev | -/- | -/- |

7.4 Conducted measurements with peak power meter & spectrum analyzer

Conducted measurements normal conditions

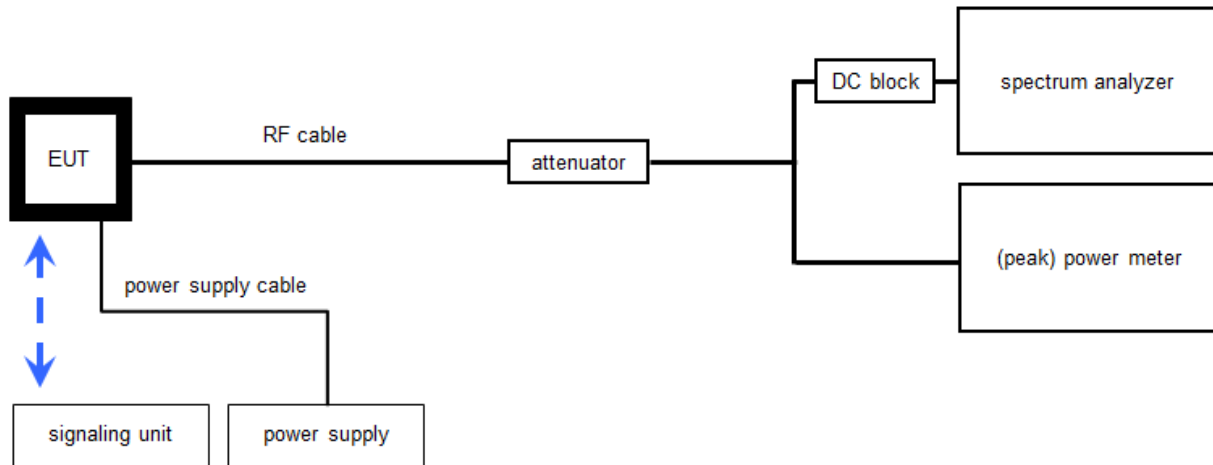

WLAN tester version: 1.1.13; LabView2015

OP = AV + CA
(OP-output power; AV-analyzer value; CA-loss signal path)

Example calculation:

OP [dBm] = 6.0 [dBm] + 11.7 [dB] = 17.7 [dBm] (58.88 mW)

Equipment table:

| No. | Setup | Equipment | Type | Manufacturer | Serial No. | INV. No. | Kind of Calibration | Last Calibration | Next Calibration |
|-----|-------|---|---|-------------------|------------------|-----------|---------------------|------------------|------------------|
| 1 | A | Signal analyzer | FSV40 | Rohde&Schwarz | 101353 | 300004819 | k | 10.12.2021 | 31.12.2022 |
| 2 | A | RF-Cable WLAN-Tester Port 1 | ST18/SMAm/SMAm /36 | Huber & Suhner | Batch no. 601494 | 400001216 | g | -/- | -/- |
| 3 | A | RF-Cable WLAN-Tester Analyzer | ST18/SMAm/SMAm /36 | Huber & Suhner | Batch no. 54876 | 400001220 | ev | -/- | -/- |
| 4 | A | Tester Software RadioStar (C.BER2 for BT Conformance) | Version 1.0.0.X | CTC advanced GmbH | 0001 | 400001380 | ne | -/- | -/- |
| 5 | A | Rack mounted PC | Precision 3930 Rack-Workstation i5-9500 CTO | Dell | J15D873 | 300006115 | ne | -/- | -/- |
| 6 | A | Switch matrix | RSM 004 TS | CTC advanced | 001 | 400001578 | ev | -/- | -/- |
| 7 | A | Signal analyzer | FSV40 | Rohde&Schwarz | 101353 | 300004819 | k | 10.12.2021 | 31.12.2022 |
| 8 | A | RF-Cable WLAN-Tester Port 1 | ST18/SMAm/SMAm /36 | Huber & Suhner | Batch no. 601494 | 400001216 | g | -/- | -/- |
| 9 | A | RF-Cable WLAN-Tester Analyzer | ST18/SMAm/SMAm /36 | Huber & Suhner | Batch no. 54876 | 400001220 | ev | -/- | -/- |
| 10 | A | Tester Software RadioStar (C.BER2 for BT Conformance) | Version 1.0.0.X | CTC advanced GmbH | 0001 | 400001380 | ne | -/- | -/- |

7.5 AC conducted

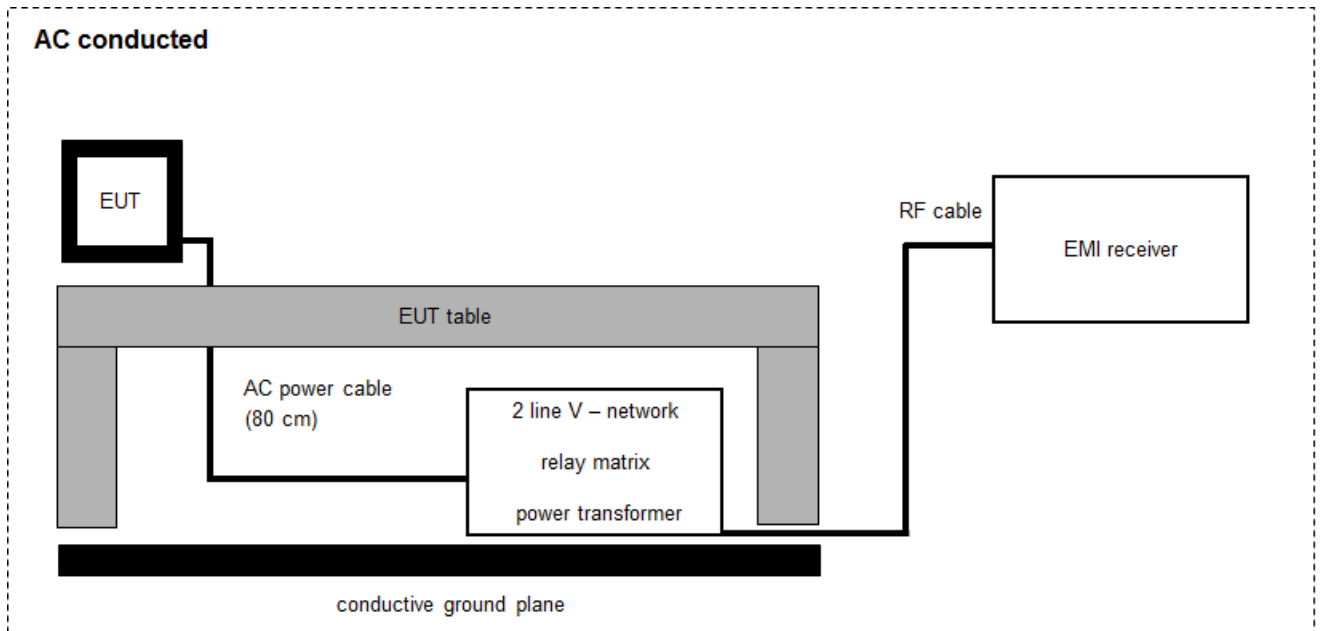

$$FS = UR + CF + VC$$

(FS-field strength; UR-voltage at the receiver; CR-loss of the cable and filter; VC-correction factor of the ISN)

Example calculation:

$$FS [dB\mu V/m] = 37.62 [dB\mu V/m] + 9.90 [dB] + 0.23 [dB] = 47.75 [dB\mu V/m] (244.06 \mu V/m)$$

Equipment table:

| No. | Setup | Equipment | Type | Manufacturer | Serial No. | INV. No. | Kind of Calibration | Last Calibration | Next Calibration |
|-----|-------|---|---------|-----------------|------------|-----------|---------------------|------------------|------------------|
| 1 | A | Two-line V-Network (LISN) 9 kHz to 30 MHz | ESH3-Z5 | Rohde & Schwarz | 892475/017 | 300002209 | vIKI! | 14.12.2021 | 31.12.2023 |
| 2 | A | RF-Filter-section | 85420E | HP | 3427A00162 | 300002214 | NK! | -/- | -/- |
| 3 | A | EMI Test Receiver | ESCI 3 | R&S | 100083 | 300003312 | k | 09.12.2021 | 31.12.2022 |
| 4 | A | Hochpass 150 kHz | EZ-25 | R&S | 100010 | 300003798 | ev | -/- | -/- |
| 5 | A | PC | Tecline | F+W | -/- | 300003532 | ne | -/- | -/- |

8 Sequence of testing

8.1 Sequence of testing radiated spurious 9 kHz to 30 MHz

Setup

- The equipment is set up to simulate normal operation mode as described in the user manual or defined by the manufacturer.
- If the EUT is a tabletop system, it is placed on a table with 0.8 m height.
- If the EUT is a floor standing device, it is placed directly on the turn table.
- Auxiliary equipment and cables are positioned to simulate normal operation conditions as described in ANSI C 63.4.
- The AC power port of the EUT (if available) is connected to a power outlet below the turntable.
- Measurement distance is 3 m (see ANSI C 63.4) – see test details.
- EUT is set into operation.

Premeasurement*

- The turntable rotates from 0° to 315° using 45° steps.
- The antenna height is 1 m.
- At each turntable position the analyzer sweeps with positive-peak detector to find the maximum of all emissions.

Final measurement

- Identified emissions during the pre-measurement are maximized by the software by rotating the turntable from 0° to 360°.
- Loop antenna is rotated about its vertical axis for maximum response at each azimuth about the EUT. (For certain applications, the loop antenna plane may also need to be positioned horizontally at the specified distance from the EUT)
- The final measurement is done in the position (turntable and elevation) causing the highest emissions with quasi-peak (as described in ANSI C 63.4).
- Final levels, frequency, measuring time, bandwidth, turntable position, correction factor, margin to the limit and limit will be recorded. A plot with the graph of the premeasurement and the limit is stored.

*Note: The sequence will be repeated three times with different EUT orientations.

8.2 Sequence of testing radiated spurious 30 MHz to 1 GHz

Setup

- The equipment is set up to simulate normal operation mode as described in the user manual or defined by the manufacturer.
- If the EUT is a tabletop system, a table with 0.8 m height is used, which is placed on the ground plane.
- If the EUT is a floor standing device, it is placed on the ground plane with insulation between both.
- Auxiliary equipment and cables are positioned to simulate normal operation conditions as described in ANSI C 63.4.
- The AC power port of the EUT (if available) is connected to a power outlet below the turntable.
- Measurement distance is 10 m or 3 m (see ANSI C 63.4) – see test details.
- EUT is set into operation.

Premeasurement

- The turntable rotates from 0° to 315° using 45° steps.
- The antenna is polarized vertical and horizontal.
- The antenna height changes from 1 m to 3 m.
- At each turntable position, antenna polarization and height the analyzer sweeps three times in peak to find the maximum of all emissions.

Final measurement

- The final measurement is performed for at least six highest peaks according to the requirements of the ANSI C63.4.
- Based on antenna and turntable positions at which the peak values are measured the software maximize the peaks by changing turntable position $\pm 45^\circ$ and antenna height between 1 and 4 m.
- The final measurement is done with quasi-peak detector (as described in ANSI C 63.4).
- Final levels, frequency, measuring time, bandwidth, antenna height, antenna polarization, turntable angle, correction factor, margin to the limit and limit are recorded. A plot with the graph of the premeasurement with marked maximum final results and the limit is stored.

8.3 Sequence of testing radiated spurious 1 GHz to 18 GHz

Setup

- The equipment is set up to simulate normal operation mode as described in the user manual or defined by the manufacturer.
- If the EUT is a tabletop system, a 2-axis positioner with 1.5 m height is used.
- If the EUT is a floor standing device, it is placed directly on the turn table.
- Auxiliary equipment and cables are positioned to simulate normal operation conditions as described in ANSI C 63.4.
- The AC power port of the EUT (if available) is connected to a power outlet below the turntable.
- Measurement distance is 3 m (see ANSI C 63.4) – see test details.
- EUT is set into operation.

Premeasurement

- The turntable rotates from 0° to 315° using 45° steps.
- The antenna is polarized vertical and horizontal.
- The antenna height is 1.5 m.
- At each turntable position and antenna polarization the analyzer sweeps with positive peak detector to find the maximum of all emissions.

Final measurement

- The final measurement is performed for at least six highest peaks according to the requirements of the ANSI C63.4.
- Based on antenna and turntable positions at which the peak values are measured the software maximizes the peaks by rotating the turntable from 0° to 360°. This measurement is repeated for different EUT-table positions (0° to 150° in 30°-steps) and for both antenna polarizations.
- The final measurement is done in the position (turntable, EUT-table and antenna polarization) causing the highest emissions with Peak and RMS detector (as described in ANSI C 63.4).
- Final levels, frequency, measuring time, bandwidth, turntable position, EUT-table position, antenna polarization, correction factor, margin to the limit and limit are recorded. A plot with the graph of the premeasurement with marked maximum final results and the limit is stored.

8.4 Sequence of testing radiated spurious above 18 GHz

Setup

- The equipment is set up to simulate normal operation mode as described in the user manual or defined by the manufacturer.
- Auxiliary equipment and cables are positioned to simulate normal operation conditions as described in ANSI C 63.4.
- The AC power port of the EUT (if available) is connected to a power outlet.
- The measurement distance is as appropriate (e.g. 0.5 m).
- The EUT is set into operation.

Premeasurement

- The test antenna is handheld and moved carefully over the EUT to cover the EUT's whole sphere and different polarizations of the antenna.

Final measurement

- The final measurement is performed at the position and antenna orientation causing the highest emissions with Peak and RMS detector (as described in ANSI C 63.4).
- Final levels, frequency, measuring time, bandwidth, correction factor, margin to the limit and limit are recorded. A plot with the graph of the premeasurement and the limit is stored.

9 Measurement uncertainty

| Measurement uncertainty | | |
|--|-------------------------------------|-----------|
| Test case | Uncertainty | |
| Antenna gain | ± 3 dB | |
| Power spectral density | ± 1.56 dB | |
| DTS bandwidth | ± 100 kHz (depends on the used RBW) | |
| Occupied bandwidth | ± 100 kHz (depends on the used RBW) | |
| Maximum output power conducted | ± 1.56 dB | |
| Detailed spurious emissions @ the band edge - conducted | ± 1.56 dB | |
| Band edge compliance radiated | ± 3 dB | |
| Spurious emissions conducted | > 3.6 GHz | ± 1.56 dB |
| | > 7 GHz | ± 1.56 dB |
| | > 18 GHz | ± 2.31 dB |
| | ≥ 40 GHz | ± 2.97 dB |
| Spurious emissions radiated below 30 MHz | ± 3 dB | |
| Spurious emissions radiated 30 MHz to 1 GHz | ± 3 dB | |
| Spurious emissions radiated 1 GHz to 12.75 GHz | ± 3.7 dB | |
| Spurious emissions radiated above 12.75 GHz | ± 4.5 dB | |
| Spurious emissions conducted below 30 MHz (AC conducted) | ± 2.6 dB | |

10 Summary of measurement results

| | |
|-------------------------------------|--|
| <input checked="" type="checkbox"/> | No deviations from the technical specifications were ascertained |
| <input type="checkbox"/> | There were deviations from the technical specifications ascertained |
| <input type="checkbox"/> | This test report is only a partial test report. The content and verdict of the performed test cases are listed below. |

| TC Identifier | Description | Verdict | Date | Remark |
|---------------|--|-----------|------------|--------|
| RF-Testing | CFR Title 47 Part 15 RSS 247, Issue 2 | See table | 2023-01-11 | -/- |

| Test specification clause | Test case | C | NC | NA | NP | Remark |
|-----------------------------------|--|-------------------------------------|--------------------------|-------------------------------------|--------------------------|-------------------------------|
| -/- | Output power verification (cond.) | -/- | | | | Declared |
| -/- | Antenna gain | -/- | | | | See section 12.2 |
| U-NII Part 15 | Duty cycle | -/- | | | | -/- |
| §15.407(a) RSS - 247 (6.2.x.1) | Maximum output power (conducted & radiated) | <input checked="" type="checkbox"/> | <input type="checkbox"/> | <input type="checkbox"/> | <input type="checkbox"/> | -/- |
| §15.407(a) RSS - 247 (6.2.x.1) | Power spectral density | <input checked="" type="checkbox"/> | <input type="checkbox"/> | <input type="checkbox"/> | <input type="checkbox"/> | -/- |
| RSS - 247 (6.2.4.1) | Spectrum bandwidth 6dB bandwidth | <input checked="" type="checkbox"/> | <input type="checkbox"/> | <input type="checkbox"/> | <input type="checkbox"/> | -/- |
| §15.407(a) RSS - 247 (6.2.x.2) | Spectrum bandwidth 26dB bandwidth | <input checked="" type="checkbox"/> | <input type="checkbox"/> | <input type="checkbox"/> | <input type="checkbox"/> | -/- |
| RSS Gen clause 6.6 | Spectrum bandwidth 99% bandwidth | -/- | | | | -/- |
| §15.205 RSS - 247 (6.2.x.2) | Band edge compliance radiated | <input checked="" type="checkbox"/> | <input type="checkbox"/> | <input type="checkbox"/> | <input type="checkbox"/> | -/- |
| §15.407(b) RSS - 247 (6.2.x.2) | TX spurious emissions radiated | <input checked="" type="checkbox"/> | <input type="checkbox"/> | <input type="checkbox"/> | <input type="checkbox"/> | -/- |
| §15.109 RSS-Gen | RX spurious emissions radiated | <input type="checkbox"/> | <input type="checkbox"/> | <input checked="" type="checkbox"/> | <input type="checkbox"/> | -/- |
| §15.209(a) RSS-Gen | Spurious emissions radiated < 30 MHz | <input checked="" type="checkbox"/> | <input type="checkbox"/> | <input type="checkbox"/> | <input type="checkbox"/> | -/- |
| §15.107(a) §15.207 | Spurious emissions conducted emissions < 30 MHz | <input checked="" type="checkbox"/> | <input type="checkbox"/> | <input type="checkbox"/> | <input type="checkbox"/> | -/- |
| §15.407 RSS - 247 (6.3) | DFS | -/- | | | | See report 1-4835/22-02-11 |

Notes:

| | | | |
|---------------------|--------------------------|---------------------------|--------------------------|
| C: Compliant | NC: Not compliant | NA: Not applicable | NP: Not performed |
|---------------------|--------------------------|---------------------------|--------------------------|

11 Additional comments

Reference documents: DFS report: 1-4835/22-02-11
 1-4835_22-02-04_Annex_MR_A_1.pdf (M5000)
 1-4835_22-02-10_Annex_MR_A_1.pdf (M3500)
 Radio Wifi agreement procedure.pdf

Special test descriptions: None

Configuration descriptions: None

EUT selection: Only one device available
 Devices selected by the customer
 Devices selected by the laboratory (Randomly)

Provided channels:

Channels with 20 MHz channel bandwidth:

| U-NII-1 & U-NII-2A (5150 MHz to 5250 MHz & 5250 MHz to 5350 MHz) channel number & center frequency | | | | | | | | |
|---|-------------|-------------|------|-------------|-------------|-------------|------|-------------|
| channel | 36 | 40 | 44 | 48 | 52 | 56 | 60 | 64 |
| f _c / MHz | 5180 | 5200 | 5220 | 5240 | 5260 | 5280 | 5300 | 5320 |

| U-NII-2C (5470 MHz to 5725 MHz) channel number & center frequency | | | | | | | | | | | |
|--|-------------|------|------|------|------|-------------|------|------|------|------|-------------|
| channel | 100 | 104 | 108 | 112 | 116 | 120 | 124 | 128 | 132 | 136 | 140 |
| f _c / MHz | 5500 | 5520 | 5540 | 5560 | 5580 | 5600 | 5620 | 5640 | 5660 | 5680 | 5700 |

| U-NII-3 (5725 MHz to 5850 MHz) channel number & center frequency | | | | | |
|---|-------------|------|-------------|------|-------------|
| channel | 149 | 153 | 157 | 161 | 165 |
| f _c / MHz | 5745 | 5765 | 5785 | 5805 | 5825 |

Channels with 40 MHz channel bandwidth:

| U-NII-1 & U-NII-2A (5150 MHz to 5250 MHz & 5250 MHz to 5350 MHz) channel number & center frequency | | | | |
|---|-------------|-------------|-------------|-------------|
| channel | 38 | 46 | 54 | 62 |
| f _c / MHz | 5190 | 5230 | 5270 | 5310 |

| U-NII-2C (5470 MHz to 5725 MHz) channel number & center frequency | | | | |
|--|-------------|------|-------------|------|
| channel | 102 | 110 | 118 | 126 |
| f _c / MHz | 5510 | 5550 | 5590 | 5630 |

| U-NII-3 (5725 MHz to 5850 MHz) channel number & center frequency | |
|---|-------------|
| channel | 151 |
| f _c / MHz | 5755 |

Note: The channels used for the tests were marked in bold in the list.

- Test mode:
- Iperf was used to generate necessary channel load during DFS measurements
 - Special software is used.
EUT is transmitting pseudo random data by itself

Antennas and transmit operating modes:

- Operating mode 1 (single antenna)
 - Equipment with 1 antenna,
 - Equipment with 2 diversity antennas operating in switched diversity mode by which at any moment in time only 1 antenna is used,
 - Smart antenna system with 2 or more transmit/receive chains, but operating in a mode where only 1 transmit/receive chain is used)
- Operating mode 2 (multiple antennas, no beamforming)
 - Equipment operating in this mode contains a smart antenna system using two or more transmit/receive chains simultaneously but without beamforming.
- Operating mode 3 (multiple antennas, with beamforming)
 - Equipment operating in this mode contains a smart antenna system using two or more transmit/receive chains simultaneously with beamforming.
In addition to the antenna assembly gain (G), the beamforming gain (Y) may have to be taken into account when performing the measurements.

12 Measurement results

12.1 Identify worst case data rate

Worst case data rates declared by the manufacturer.

| OFDM – mode | Modulation scheme / bandwidth | | | | | |
|------------------|-------------------------------|-----------------|----------------|-----------------|----------------|-----------------|
| | U-NII-1 & U-NII-2A | | U-NII-2C | | U-NII-3 | |
| | lowest channel | highest channel | lowest channel | highest channel | lowest channel | highest channel |
| a – mode | 6Mbit/s | 6Mbit/s | 6Mbit/s | 6Mbit/s | 6Mbit/s | 6Mbit/s |
| n/ac HT20 – mode | MCS0 | MCS0 | MCS0 | MCS0 | MCS0 | MCS0 |
| n/ac HT40 – mode | MCS0 | MCS0 | MCS0 | MCS0 | MCS0 | MCS |

12.2 Antenna gain

Description:

The antenna gain of the complete system is calculated by the difference of radiated power in EIRP and the conducted power of the module.

Measurement parameters:

| Measurement parameter | |
|--------------------------|---|
| External result file(s) | 1-4835_22-02-04_Annex_MR_A_1.pdf (M5000) 1-4835_22-02-10_Annex_MR_A_1.pdf (M3500) Peak OP 3MHz/3MHz |
| Test setup: | See chapter 7.2 – A (radiated) See chapter 7.4 – A (conducted) |
| Measurement uncertainty: | See chapter 9 |

Limits:

| Antenna Gain |
|---|
| 6 dBi / > 6 dBi output power and power density reduction required |

Results: Move 3500

| U-NII-1 (5150 MHz to 5250 MHz) | Antenna gain | | |
|-------------------------------------|----------------|----------------|-----------------|
| | Lowest channel | Middle channel | Highest channel |
| Conducted power / dBm @ 3 MHz RBW | 13.1 | -/- | 14.1 |
| Radiated power / dBm @ 3 MHz RBW | 15.1 | -/- | 14.0 |
| Gain / dBi (calculated or declared) | -2.0 | -/- | -0.1 |

| U-NII-2A (5250 MHz to 5350 MHz) | Antenna gain | | |
|-------------------------------------|----------------|----------------|-----------------|
| | Lowest channel | Middle channel | Highest channel |
| Conducted power / dBm @ 3 MHz RBW | 14.1 | -/- | 14.1 |
| Radiated power / dBm @ 3 MHz RBW | 15.1 | -/- | 14.5 |
| Gain / dBi (calculated or declared) | 1.0 | -/- | 0.4 |

| U-NII-2C (5470 MHz to 5725 MHz) | Antenna gain | | |
|-------------------------------------|----------------|----------------|-----------------|
| | Lowest channel | Middle channel | Highest channel |
| Conducted power / dBm @ 3 MHz RBW | 12.4 | 12.5 | 12.5 |
| Radiated power / dBm @ 3 MHz RBW | 12.8 | 14.1 | 12.7 |
| Gain / dBi (calculated or declared) | 0.4 | 1.6 | 0.2 |

| U-NII-3 (5725 MHz to 5850 MHz) | Antenna gain | | |
|-------------------------------------|----------------|----------------|-----------------|
| | Lowest channel | Middle channel | Highest channel |
| Conducted power / dBm @ 3 MHz RBW | 12.5 | -/- | 12.4 |
| Radiated power / dBm @ 3 MHz RBW | 13.6 | -/- | 13.0 |
| Gain / dBi (calculated or declared) | 1.1 | -/- | 0.6 |

Results: Move 5000

| U-NII-1 (5150 MHz to 5250 MHz) | Antenna gain | | |
|-------------------------------------|----------------|----------------|-----------------|
| | Lowest channel | Middle channel | Highest channel |
| Conducted power / dBm @ 3 MHz RBW | 14.1 | -/- | 13.6 |
| Radiated power / dBm @ 3 MHz RBW | 14.3 | -/- | 14.4 |
| Gain / dBi (calculated or declared) | 0.2 | -/- | 0.8 |

| U-NII-2A (5250 MHz to 5350 MHz) | Antenna gain | | |
|-------------------------------------|----------------|----------------|-----------------|
| | Lowest channel | Middle channel | Highest channel |
| Conducted power / dBm @ 3 MHz RBW | 13.6 | -/- | 13.7 |
| Radiated power / dBm @ 3 MHz RBW | 14.2 | -/- | 14.5 |
| Gain / dBi (calculated or declared) | 0.6 | -/- | 0.8 |

| U-NII-2C (5470 MHz to 5725 MHz) | Antenna gain | | |
|-------------------------------------|----------------|----------------|-----------------|
| | Lowest channel | Middle channel | Highest channel |
| Conducted power / dBm @ 3 MHz RBW | 11.8 | -/- | 11.4 |
| Radiated power / dBm @ 3 MHz RBW | 13.5 | -/- | 14.4 |
| Gain / dBi (calculated or declared) | 1.7 | -/- | 3.0 |

| U-NII-3 (5725 MHz to 5850 MHz) | Antenna gain | | |
|-------------------------------------|----------------|----------------|-----------------|
| | Lowest channel | Middle channel | Highest channel |
| Conducted power / dBm @ 3 MHz RBW | 11.6 | -/- | 11.5 |
| Radiated power / dBm @ 3 MHz RBW | 15.5 | -/- | 14.7 |
| Gain / dBi (calculated or declared) | 3.9 | -/- | 3.2 |

12.3 Duty cycle

Description:

The duty cycle is necessary to compute the maximum power during an actual transmission. The shown plots and values are to show an example of the measurement procedure. The real value is measured direct during the power measurement or power density measurement. The correction value is shown in each plot of these measurements.

Measurement:

| Measurement parameter | |
|---------------------------------|--|
| According to: KDB789033 D02, B. | |
| External result file(s) | 1-4835_22-02-04_Annex_MR_A_1.pdf FCC Part 15.407 Max Output Power and PSD |
| Used test setup: | See chapter 6.4 – A |
| Measurement uncertainty: | See chapter 9 |

Results:

Duty cycle and correction factor:

| OFDM – mode | Calculation method | | | |
|------------------|--|----------------------------|------------|-------------------|
| | $T_{on} (D2_{plot}) * 100 / T_{complete} (D3_{plot}) = \text{duty cycle}$ $10 * \log(\text{duty cycle}) = \text{correction factor}$ | | | |
| | $T_{on} (D2_{plot})$ | $T_{complete} (D3_{plot})$ | Duty cycle | Correction factor |
| a – mode | -/- | -/- | 100% | 0dB |
| n/ac HT20 – mode | -/- | -/- | 100% | 0dB |
| n/ac HT40 – mode | -/- | -/- | 100% | 0dB |

12.4 Maximum output power

12.4.1 Maximum output power according to FCC requirements

Description:

Measurement of the maximum output power conducted

Measurement:

| Measurement parameter | |
|-------------------------------------|--|
| According to: KDB789033 D02, E.2.e. | |
| External result file(s) | 1-4835_22-02-04_Annex_MR_A_1.pdf FCC Part 15.407 Max Output Power and PSD |
| Used test setup: | See chapter 7.4 – A |
| Measurement uncertainty: | See chapter 9 |

Limits:

| Radiated output power | Conducted output power for mobile equipment |
|--------------------------------------|--|
| Conducted power + 6 dBi antenna gain | 250mW 5.150-5.250 GHz The lesser one of 250mW or 11 dBm + 10 log Bandwidth 5.250-5.350 GHz 250mW or 11 dBm + 10 log Bandwidth 5.470-5.725 GHz (where Bandwidth is the 26dB Bandwidth [MHz]) 1W 5.725-5.85 GHz |

Results:

| a-mode | Maximum output power conducted [dBm] | | |
|--------|--------------------------------------|----------------|-----------------|
| | U-NII-1 (5150 MHz to 5250 MHz) | | |
| | Lowest channel | Middle channel | Highest channel |
| | 10.4 | 10.5 | 10.7 |
| | U-NII-2A (5250 MHz to 5350 MHz) | | |
| | Lowest channel | Middle channel | Highest channel |
| | 10.7 | 10.8 | 10.8 |
| | U-NII-2C (5470 MHz to 5725 MHz) | | |
| | Lowest channel | Middle channel | Highest channel |
| | 8.6 | 8.8 | 8.6 |
| | U-NII-3 (5725 MHz to 5850 MHz) | | |
| | Lowest channel | Middle channel | Highest channel |
| | 8.9 | 8.9 | 8.8 |

Results:

| | | | |
|-----------|--------------------------------------|----------------|-----------------|
| n/ac HT20 | Maximum output power conducted [dBm] | | |
| | U-NII-1 (5150 MHz to 5250 MHz) | | |
| | Lowest channel | Middle channel | Highest channel |
| | 9.7 | 9.8 | 10.0 |
| | U-NII-2A (5250 MHz to 5350 MHz) | | |
| | Lowest channel | Middle channel | Highest channel |
| | 10.0 | 10.1 | 10.0 |
| | U-NII-2C (5470 MHz to 5725 MHz) | | |
| | Lowest channel | Middle channel | Highest channel |
| | 7.8 | 8.0 | 7.8 |
| | U-NII-3 (5725 MHz to 5850 MHz) | | |
| | Lowest channel | Middle channel | Highest channel |
| 8.0 | 8.1 | 8.0 | |

Results:

| | | | |
|-----------|--------------------------------------|-----------------|-----------------|
| n/ac HT40 | Maximum output power conducted [dBm] | | |
| | U-NII-1 (5150 MHz to 5250 MHz) | | |
| | Lowest channel | Highest channel | |
| | 8.4 | 8.6 | |
| | U-NII-2A (5250 MHz to 5350 MHz) | | |
| | Lowest channel | Highest channel | |
| | 8.5 | 8.4 | |
| | U-NII-2C (5470 MHz to 5725 MHz) | | |
| | Lowest channel | Middle channel | Highest channel |
| | 6.1 | 6.3 | 6.2 |
| | U-NII-3 (5725 MHz to 5850 MHz) | | |
| | Lowest channel | Highest channel | |
| 6.3 | 6.4 | | |

12.4.2 Maximum output power according to ISED requirements

Description:

Measurement of the maximum output power conducted + radiated

Measurement:

| Measurement parameter | |
|--------------------------|---|
| External result file(s) | 1-4835_22-02-04_Annex_MR_A_1.pdf ISED Max Output Power and PSD |
| Used test setup: | See chapter 7.4 – A |
| Measurement uncertainty: | See chapter 9 |

Limits:

| Radiated output power | Conducted output power for mobile equipment |
|---|---|
| The lesser one of 200 mW or 10 dBm + 10 log Bandwidth 5.150-5.250 GHz 1 W or 17 dBm + 10 log Bandwidth 5.250-5.350 GHz 1 W or 17 dBm + 10 log Bandwidth 5.470-5.725 GHz (where Bandwidth is the 99% Bandwidth [MHz]) Conducted power + 6dBi antenna gain 5.725-5.825 GHz | The lesser one of 250mW or 11 dBm + 10 log Bandwidth 5.250-5.350 GHz 250mW or 11 dBm + 10 log Bandwidth 5.470-5.725 GHz (where Bandwidth is the 99% Bandwidth [MHz]) 1W 5.725-5.825 GHz |

Results:

| | | | |
|--|--|-----------------|-----------------|
| a | Maximum output power [dBm] | | |
| | U-NII-1 (5150 MHz to 5250 MHz) | | |
| | Lowest channel | Middle channel | Highest channel |
| | Conducted | | |
| | 10.4 | 10.4 | 10.6 |
| | Radiated (calculated – see chapter antenna gain) | | |
| | 10.6 | 11.2 | 11.4 |
| | U-NII-2A (5250 MHz to 5350 MHz) | | |
| | Lowest channel | Middle channel | Highest channel |
| | Conducted | | |
| | 10.6 | 10.7 | 10.7 |
| | Radiated (calculated – see chapter antenna gain) | | |
| | 11.2 | 11.5 | 11.5 |
| | U-NII-2C (5470 MHz to 5725 MHz) | | |
| | Lowest channel | Middle channel | Highest channel |
| | Conducted | | |
| | 8.5 | 8.7 | 8.5 |
| | Radiated (calculated – see chapter antenna gain) | | |
| | 10.2 | 11.7 | 11.5 |
| | U-NII-3 (5725 MHz to 5850 MHz) | | |
| Lowest channel | Middle channel | Highest channel | |
| Conducted | | | |
| 8.7 | 8.8 | 8.7 | |
| Radiated (calculated – see chapter antenna gain) | | | |
| 12.6 | 12.7 | 11.9 | |

Results:

| | | | |
|--|--|----------------|-----------------|
| n/ac HT20 | Maximum output power [dBm] | | |
| | U-NII-1 (5150 MHz to 5250 MHz) | | |
| | Lowest channel | Middle channel | Highest channel |
| | Conducted | | |
| | 9.6 | 9.7 | 9.9 |
| | Radiated (calculated – see chapter antenna gain) | | |
| | 9.8 | 10.5 | 10.7 |
| | U-NII-2A (5250 MHz to 5350 MHz) | | |
| | Lowest channel | Middle channel | Highest channel |
| | Conducted | | |
| | 9.9 | 10.0 | 9.9 |
| | Radiated (calculated – see chapter antenna gain) | | |
| | 10.5 | 10.8 | 10.7 |
| | U-NII-2C (5470 MHz to 5725 MHz) | | |
| | Lowest channel | Middle channel | Highest channel |
| | Conducted | | |
| | 7.7 | 7.9 | 7.7 |
| | Radiated (calculated – see chapter antenna gain) | | |
| | 9.4 | 10.9 | 10.7 |
| | U-NII-3 (5725 MHz to 5850 MHz) | | |
| | Lowest channel | Middle channel | Highest channel |
| Conducted | | | |
| 7.9 | 8.0 | 7.9 | |
| Radiated (calculated – see chapter antenna gain) | | | |
| 11.8 | 11.9 | 11.1 | |

Results:

| | | | |
|--|--|----------------|-----------------|
| n/ac HT40 | Maximum output power [dBm] | | |
| | U-NII-1 (5150 MHz to 5250 MHz) | | |
| | Lowest channel | | Highest channel |
| | Conducted | | |
| | 8.3 | | 8.5 |
| | Radiated (calculated – see chapter antenna gain) | | |
| | 8.5 | | 9.3 |
| | U-NII-2A (5250 MHz to 5350 MHz) | | |
| | Lowest channel | | Highest channel |
| | Conducted | | |
| | 8.4 | | 8.3 |
| | Radiated (calculated – see chapter antenna gain) | | |
| | 9.0 | | 9.1 |
| | U-NII-2C (5470 MHz to 5725 MHz) | | |
| | Lowest channel | Middle channel | Highest channel |
| | Conducted | | |
| | 6.1 | 6.3 | 6.1 |
| | Radiated (calculated – see chapter antenna gain) | | |
| | 7.8 | 9.3 | 9.1 |
| | U-NII-3 (5725 MHz to 5850 MHz) | | |
| | Lowest channel | | Highest channel |
| Conducted | | | |
| 6.3 | | 6.3 | |
| Radiated (calculated – see chapter antenna gain) | | | |
| 10.2 | | 9.5 | |

12.5 Power spectral density

12.5.1 Power spectral density according to FCC requirements

Description:

Measurement of the power spectral density of a digital modulated system. The measurement is repeated at the lowest, middle and highest channel.

Measurement:

| Measurement parameter | |
|---------------------------------|--|
| According to: KDB789033 D02, F. | |
| External result file(s) | 1-4835_22-02-04_Annex_MR_A_1.pdf FCC Part 15.407 Max Output Power and PSD |
| Used test setup: | See chapter 7.4 – A |
| Measurement uncertainty: | See chapter 9 |

Limits:

| Power Spectral Density |
|---|
| power spectral density conducted ≤ 11 dBm in any 1 MHz band (band 5150 – 5250 MHz) |
| power spectral density conducted ≤ 11 dBm in any 1 MHz band (band 5250 – 5350 MHz) |
| power spectral density conducted ≤ 11 dBm in any 1 MHz band (band 5470 – 5725 MHz) |
| power spectral density conducted ≤ 30 dBm in any 500 kHz band (band 5725 – 5850 MHz) |

Results:

| a | Power spectral density (dBm/1MHz or dBm/500kHz) | | |
|---|---|----------------|-----------------|
| | U-NII-1 (5150 MHz to 5250 MHz) | | |
| | Lowest channel | Middle channel | Highest channel |
| | -0.9 | -0.8 | -0.6 |
| | U-NII-2A (5250 MHz to 5350 MHz) | | |
| | Lowest channel | Middle channel | Highest channel |
| | -0.6 | -0.5 | -0.5 |
| | U-NII-2C (5470 MHz to 5725 MHz) | | |
| | Lowest channel | Middle channel | Highest channel |
| | -2.7 | -2.5 | -2.7 |
| | U-NII-3 (5725 MHz to 5850 MHz) | | |
| | Lowest channel | Middle channel | Highest channel |
| | -5.4 | -5.3 | -5.5 |

Results:

| n/ac HT20 | Power spectral density (dBm/1MHz or dBm/500kHz) | | |
|-----------|---|----------------|-----------------|
| | U-NII-1 (5150 MHz to 5250 MHz) | | |
| | Lowest channel | Middle channel | Highest channel |
| | -1.8 | -1.7 | -1.6 |
| | U-NII-2A (5250 MHz to 5350 MHz) | | |
| | Lowest channel | Middle channel | Highest channel |
| | -1.6 | -1.5 | -1.5 |
| | U-NII-2C (5470 MHz to 5725 MHz) | | |
| | Lowest channel | Middle channel | Highest channel |
| | -3.7 | -3.5 | -3.7 |
| | U-NII-3 (5725 MHz to 5850 MHz) | | |
| | Lowest channel | Middle channel | Highest channel |
| | -6.4 | -6.3 | -6.5 |

Results:

| | | | |
|-----------|---|----------------|-----------------|
| n/ac HT40 | Power spectral density (dBm/1MHz or dBm/500kHz) | | |
| | U-NII-1 (5150 MHz to 5250 MHz) | | |
| | Lowest channel | | Highest channel |
| | -6.0 | | -5.7 |
| | U-NII-2A (5250 MHz to 5350 MHz) | | |
| | Lowest channel | | Highest channel |
| | -5.9 | | -5.9 |
| | U-NII-2C (5470 MHz to 5725 MHz) | | |
| | Lowest channel | Middle channel | Highest channel |
| | -8.2 | -8.1 | -8.0 |
| | U-NII-3 (5725 MHz to 5850 MHz) | | |
| | Lowest channel | | Highest channel |
| | -10.9 | | -11.0 |

12.5.2 Power spectral density according to ISED requirements

Description:

Measurement of the power spectral density of a digital modulated system. The measurement is repeated at the lowest, middle and highest channel.

Measurement:

| Measurement parameter | |
|--------------------------|---|
| External result file(s) | 1-4835_22-02-04_Annex_MR_A_1.pdf ISED Max Output Power and PSD |
| Used test setup: | See chapter 7.4 – A |
| Measurement uncertainty: | See chapter 9 |

Limits:

| Power Spectral Density |
|---|
| power spectral density e.i.r.p. ≤ 10 dBm in any 1 MHz band (band 5150 – 5250 MHz) |
| power spectral density conducted ≤ 11 dBm in any 1 MHz band (band 5250 – 5350 MHz) |
| power spectral density conducted ≤ 11 dBm in any 1 MHz band (band 5470 – 5725 MHz) |
| power spectral density conducted ≤ 30 dBm in any 500 kHz band (band 5725 – 5850 MHz) |

Results:

| | | | |
|------|--|----------------|-----------------|
| a | Power spectral density (dBm/1MHz or dBm/500kHz) | | |
| | U-NII-1 (5150 MHz to 5250 MHz) | | |
| | Lowest channel | Middle channel | Highest channel |
| | Conducted | | |
| | -0.9 | -0.8 | -0.6 |
| | Radiated (calculated – see chapter antenna gain) | | |
| | -2.9 | -0.9 | -0.7 |
| | U-NII-2A (5250 MHz to 5350 MHz) | | |
| | Lowest channel | Middle channel | Highest channel |
| | -0.6 | -0.5 | -0.5 |
| | U-NII-2C (5470 MHz to 5725 MHz) | | |
| | Lowest channel | Middle channel | Highest channel |
| | -2.7 | -2.5 | -2.7 |
| | U-NII-3 (5725 MHz to 5850 MHz) | | |
| | Lowest channel | Middle channel | Highest channel |
| -5.4 | -5.3 | -5.5 | |

Results:

| | | | |
|-----------|--|----------------|-----------------|
| n/ac HT20 | Power spectral density (dBm/1MHz or dBm/500kHz) | | |
| | U-NII-1 (5150 MHz to 5250 MHz) | | |
| | Lowest channel | Middle channel | Highest channel |
| | Conducted | | |
| | -1.8 | -1.7 | -1.6 |
| | Radiated (calculated – see chapter antenna gain) | | |
| | -3.0 | -1.8 | -1.7 |
| | U-NII-2A (5250 MHz to 5350 MHz) | | |
| | Lowest channel | Middle channel | Highest channel |
| | -1.6 | -1.5 | -1.5 |
| | U-NII-2C (5470 MHz to 5725 MHz) | | |
| | Lowest channel | Middle channel | Highest channel |
| | -3.7 | -3.5 | -3.7 |
| | U-NII-3 (5725 MHz to 5850 MHz) | | |
| | Lowest channel | Middle channel | Highest channel |
| -6.4 | -6.3 | -6.5 | |

Results:

| | | | |
|-----------|--|----------------|-----------------|
| n/ac HT40 | Power spectral density (dBm/1MHz or dBm/500kHz) | | |
| | U-NII-1 (5150 MHz to 5250 MHz) | | |
| | Lowest channel | | Highest channel |
| | Conducted | | |
| | -6.0 | | -5.8 |
| | Radiated (calculated – see chapter antenna gain) | | |
| | -8.0 | | -5.9 |
| | U-NII-2A (5250 MHz to 5350 MHz) | | |
| | Lowest channel | | Highest channel |
| | -5.9 | | -6.0 |
| | U-NII-2C (5470 MHz to 5725 MHz) | | |
| | Lowest channel | Middle channel | Highest channel |
| | -8.2 | -8.1 | -8.1 |
| | U-NII-3 (5725 MHz to 5850 MHz) | | |
| | Lowest channel | | Highest channel |
| | -10.9 | | -11.0 |

12.6 Minimum emission bandwidth for the band 5.725-5.85 GHz

Description:

Measurement of the 6 dB bandwidth of the modulated signal.

Measurement:

| Measurement parameter | |
|-----------------------------------|--|
| According to: KDB789033 D02, C.2. | |
| External result file(s) | 1-4835_22-02-04_Annex_MR_A_1.pdf FCC Part 15.407 & ISED Minimum Emission BW |
| Used test setup: | See chapter 7.4 – A |
| Measurement uncertainty: | See chapter 9 |

Limits:

| FCC | ISED |
|---|------|
| The minimum 6 dB bandwidth shall be at least 500 kHz. | |

Results:

| | | | |
|---|--------------------------------|----------------|-----------------|
| a | 6 dB emission bandwidth (MHz) | | |
| | U-NII-3 (5725 MHz to 5850 MHz) | | |
| | Lowest channel | Middle channel | Highest channel |
| | 16.6 | 16.6 | 16.6 |

Results:

| | | | |
|-----------|--------------------------------|----------------|-----------------|
| n/ac HT20 | 6 dB emission bandwidth (MHz) | | |
| | U-NII-3 (5725 MHz to 5850 MHz) | | |
| | Lowest channel | Middle channel | Highest channel |
| | 17.8 | 17.7 | 17.7 |

Results:

| | | |
|-----------|--------------------------------|-----------------|
| n/ac HT40 | 6 dB emission bandwidth (MHz) | |
| | U-NII-3 (5725 MHz to 5850 MHz) | |
| | Lowest channel | Highest channel |
| | 36.5 | 36.5 |

12.7 Spectrum bandwidth / 26 dB bandwidth

Description:

Measurement of the 26 dB bandwidth of the modulated signal.

Measurement:

| Measurement parameter | |
|-----------------------------------|---|
| According to: KDB789033 D02, C.1. | |
| External result file(s) | 1-4835_22-02-04_Annex_MR_A_1.pdf FCC Part 15.407 & ISED Bandwidths |
| Used test setup: | see chapter 7.4 – A |
| Measurement uncertainty: | See chapter 9 |

Limits:

| Spectrum Bandwidth – 26 dB Bandwidth |
|---|
| <p>IC: Any unwanted emissions that fall into the band 5250-5350 MHz shall be attenuated below the channel power by at least 26 dB, when measured using a resolution bandwidth between 1 and 5% of the occupied bandwidth (i.e. 99% bandwidth), above 5250 MHz. The 26 dB bandwidth may fall into the 5250-5350 MHz band; however, if the occupied bandwidth also falls within the 5250-5350 MHz band, the transmission is considered as intentional and the devices shall comply with all requirements in the band 5250-5350 MHz including implementing dynamic frequency selection (DFS) and TPC, on the portion of the emission that resides in the 5250-5350 MHz band.</p> <p>FCC: Radar Detection Function of Dynamic Frequency Selection (DFS). U-NII devices operating with any part of its 26 dB emission bandwidth in the 5.25-5.35 GHz and 5.47-5.725 GHz bands shall employ a DFS radar detection mechanism to detect the presence of radar systems and to avoid co-channel operation with radar systems.</p> |

Results:

| | | | |
|--------|---------------------------------|----------------|-------------------|
| a | 26 dB bandwidth (MHz) | | |
| | U-NII-1 (5150 MHz to 5250 MHz) | | |
| | Lowest channel | Middle channel | Highest channel |
| | 20.1 | 20.1 | 20.1 |
| | Lowest frequency | | Highest frequency |
| | 5170.1 | | 5250.1*(5248.4) |
| | U-NII-2A (5250 MHz to 5350 MHz) | | |
| | Lowest channel | Middle channel | Highest channel |
| | 20.1 | 20.0 | 20.0 |
| | U-NII-2C (5470 MHz to 5725 MHz) | | |
| | Lowest channel | Middle channel | Highest channel |
| | 20.0 | 20.0 | 20.0 |
| | U-NII-3 (5725 MHz to 5850 MHz) | | |
| | Lowest channel | Middle channel | Highest channel |
| | 20.1 | 20.1 | 20.1 |
| | Lowest frequency | | Highest frequency |
| 5735.1 | | 5835.2 | |

Results:

| | | | |
|-----------|---------------------------------|----------------|-------------------|
| n/ac HT20 | 26 dB bandwidth (MHz) | | |
| | U-NII-1 (5150 MHz to 5250 MHz) | | |
| | Lowest channel | Middle channel | Highest channel |
| | 20.2 | 20.2 | 20.3 |
| | Lowest frequency | | Highest frequency |
| | 5170 | | 5250.2*(5248.9) |
| | U-NII-2A (5250 MHz to 5350 MHz) | | |
| | Lowest channel | Middle channel | Highest channel |
| | 20.3 | 20.3 | 20.3 |
| | U-NII-2C (5470 MHz to 5725 MHz) | | |
| | Lowest channel | Middle channel | Highest channel |
| | 20.3 | 20.2 | 20.3 |
| | U-NII-3 (5725 MHz to 5850 MHz) | | |
| | Lowest channel | Middle channel | Highest channel |
| | 20.2 | 20.2 | 20.2 |
| | Lowest frequency | | Highest frequency |
| 5735 | | 5835 | |

Results:

| | | | |
|-----------|---------------------------------|----------------|-------------------|
| n/ac HT40 | 26 dB bandwidth (MHz) | | |
| | U-NII-1 (5150 MHz to 5250 MHz) | | |
| | Lowest channel | | Highest channel |
| | 40.8 | | 40.8 |
| | Lowest frequency | | Highest frequency |
| | 5170.0 | | 5250.5* (5248.3) |
| | U-NII-2A (5250 MHz to 5350 MHz) | | |
| | Lowest channel | | Highest channel |
| | 40.9 | | 40.9 |
| | U-NII-2C (5470 MHz to 5725 MHz) | | |
| | Lowest channel | Middle channel | Highest channel |
| | 40.6 | 40.7 | 40.8 |
| | U-NII-3 (5725 MHz to 5850 MHz) | | |
| | Lowest channel | | Highest channel |
| | 40.8 | | 40.8 |
| | Lowest frequency | | Highest frequency |
| 5734.7 | | 5815.5 | |

12.8 Occupied bandwidth / 99% emission bandwidth

Description:

Measurement of the 99% bandwidth of the modulated signal acc. RSS-GEN.

Measurement:

| Measurement parameter | |
|--------------------------|---|
| External result file(s) | 1-4835_22-02-04_Annex_MR_A_1.pdf FCC Part 15.407 & ISED Bandwidths |
| Test setup: | See sub clause 7.4 – A |
| Measurement uncertainty: | See chapter 9 |

Usage:

| | |
|--|------|
| -/- | ISED |
| OBW is necessary for Emission Designator | |

Results:

| | | | |
|-------|---------------------------------|----------------|-----------------|
| a | 99% bandwidth (kHz) | | |
| | U-NII-1 (5150 MHz to 5250 MHz) | | |
| | Lowest channel | Middle channel | Highest channel |
| | 16833 | 16833 | 16833 |
| | U-NII-2A (5250 MHz to 5350 MHz) | | |
| | Lowest channel | Middle channel | Highest channel |
| | 16833 | 16833 | 16833 |
| | U-NII-2C (5470 MHz to 5725 MHz) | | |
| | Lowest channel | Middle channel | Highest channel |
| | 16833 | 16833 | 16833 |
| | U-NII-3 (5725 MHz to 5850 MHz) | | |
| | Lowest channel | Middle channel | Highest channel |
| 16833 | 16833 | 16833 | |

Results:

| | | | |
|-----------|---------------------------------|----------------|-----------------|
| n/ac HT20 | 99% bandwidth (kHz) | | |
| | U-NII-1 (5150 MHz to 5250 MHz) | | |
| | Lowest channel | Middle channel | Highest channel |
| | 17732 | 17732 | 17732 |
| | U-NII-2A (5250 MHz to 5350 MHz) | | |
| | Lowest channel | Middle channel | Highest channel |
| | 17732 | 17732 | 17732 |
| | U-NII-2C (5470 MHz to 5725 MHz) | | |
| | Lowest channel | Middle channel | Highest channel |
| | 17732 | 17732 | 17732 |
| | U-NII-3 (5725 MHz to 5850 MHz) | | |
| | Lowest channel | Middle channel | Highest channel |
| 17732 | 17732 | 17732 | |

Results:

| | | | |
|-----------|---------------------------------|----------------|-----------------|
| n/ac HT40 | 99% bandwidth (kHz) | | |
| | U-NII-1 (5150 MHz to 5250 MHz) | | |
| | Lowest channel | | Highest channel |
| | 36264 | | 36264 |
| | U-NII-2A (5250 MHz to 5350 MHz) | | |
| | Lowest channel | | Highest channel |
| | 36264 | | 36264 |
| | U-NII-2C (5470 MHz to 5725 MHz) | | |
| | Lowest channel | Middle channel | Highest channel |
| | 36264 | 36264 | 36264 |
| | U-NII-3 (5725 MHz to 5850 MHz) | | |
| | Lowest channel | | Highest channel |
| | 36264 | | 36264 |

12.9 Band edge compliance radiated

Description:

Measurement of the radiated band edge compliance. The EUT is turned in the position that results in the maximum level at the band edge. Then a sweep over the corresponding restricted band is performed. The EUT is set to the lowest channel for the lower restricted band and to the highest channel for the upper restricted band. Measurement distance is 3m.

Measurement:

| Measurement parameter | |
|--------------------------|------------------------|
| Detector: | Peak / RMS |
| Sweep time: | Auto |
| Resolution bandwidth: | 1 MHz |
| Video bandwidth: | ≥ 3 x RBW |
| Span: | See plots! |
| Trace mode: | Max Hold |
| Test setup: | See sub clause 7.2 – A |
| Measurement uncertainty: | See chapter 9 |

Limits:

| Band Edge Compliance Radiated |
|--|
| In any 100 kHz bandwidth outside the frequency band in which the spread spectrum or digitally modulated intentional radiator is operating, the radio frequency power that is produced by the intentional radiator shall be at least 20 dB below that in the 100 kHz bandwidth within the band that contains the highest level of the desired power, based on either an RF conducted or a radiated measurement. Attenuation below the general limits specified in Section 15.209(a) is not required. In addition, radiated emissions which fall in the restricted bands, as defined in Section 15.205(a), must also comply with the radiated emission limits specified in Section 15.209(a) (see Section 5.205(c)). |
| 74 dBµV/m (peak) 54 dBµV/m (average) |

Result:

| Scenario | Band Edge Compliance Radiated [dBµV/m] |
|-----------|---|
| band edge | < 74 dBµV/m (peak) < 54 dBµV/m (average) |

Plots:

Plot 1: lower band edge; U-NII-1; lowest channel; 20 MHz channel bandwidth

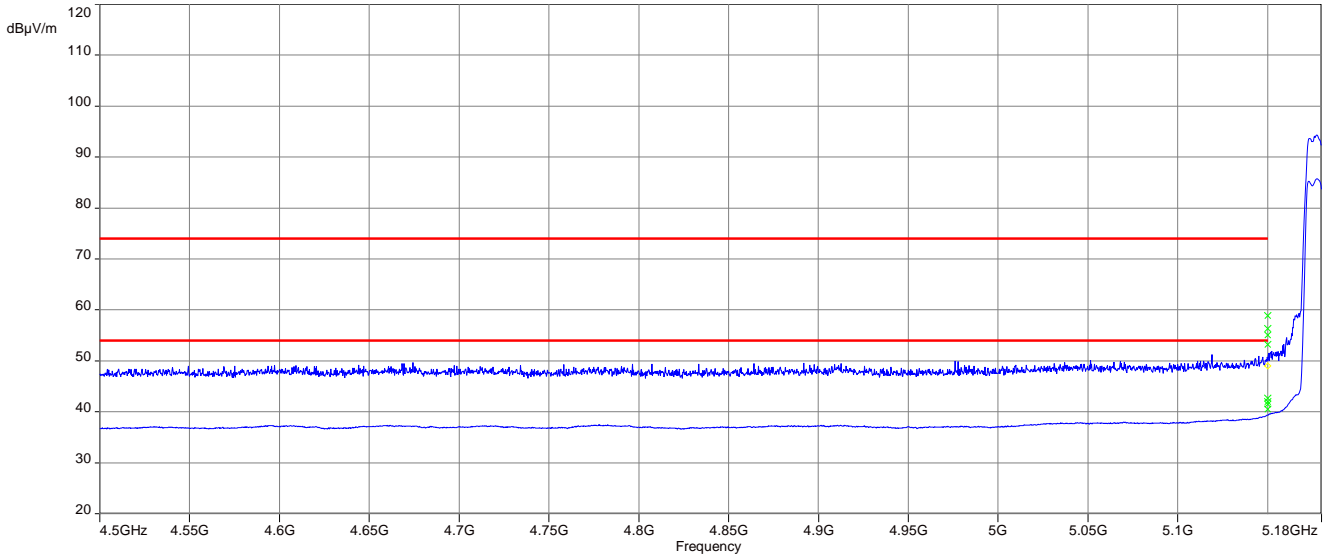

Plot 2: upper band edge; U-NII-2A; highest channel; 20 MHz channel bandwidth

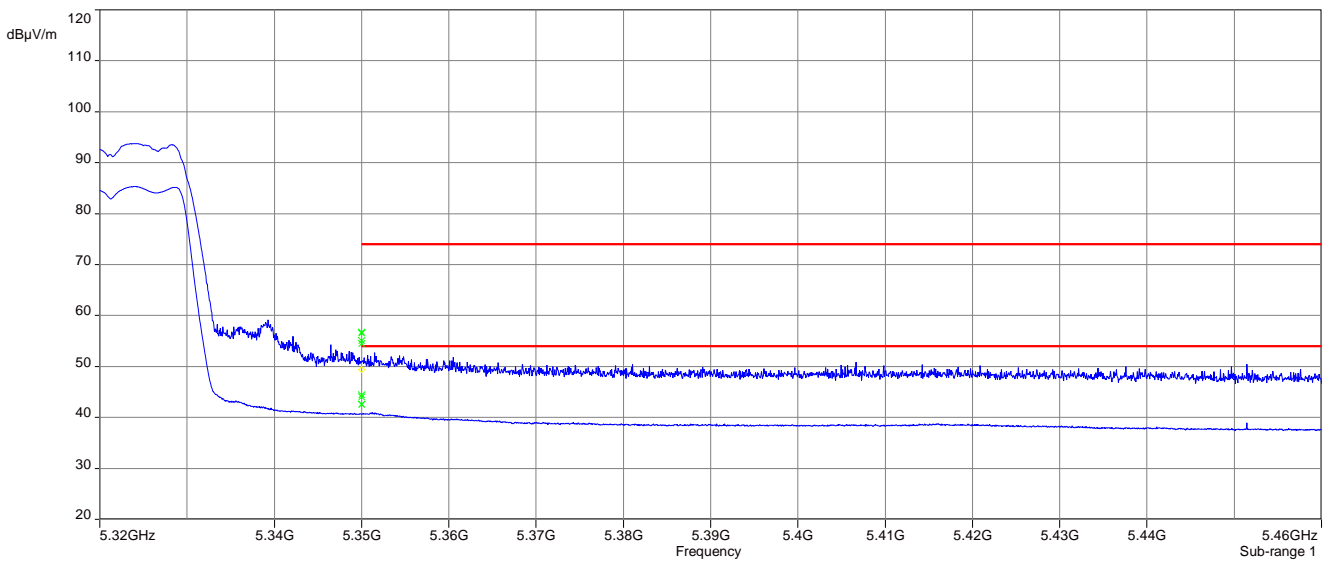

Plot 3: lower band edge; U-NII-2C; lowest channel; 20 MHz channel bandwidth

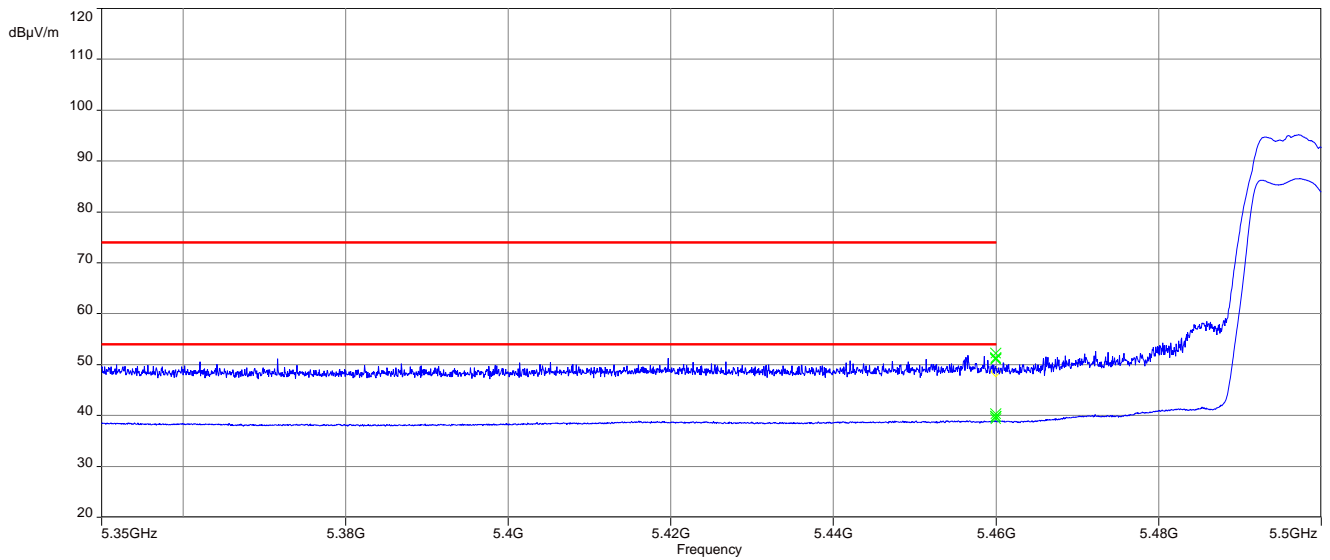

Plot 4: lower band edge; U-NII-1; lowest channel; 40 MHz channel bandwidth

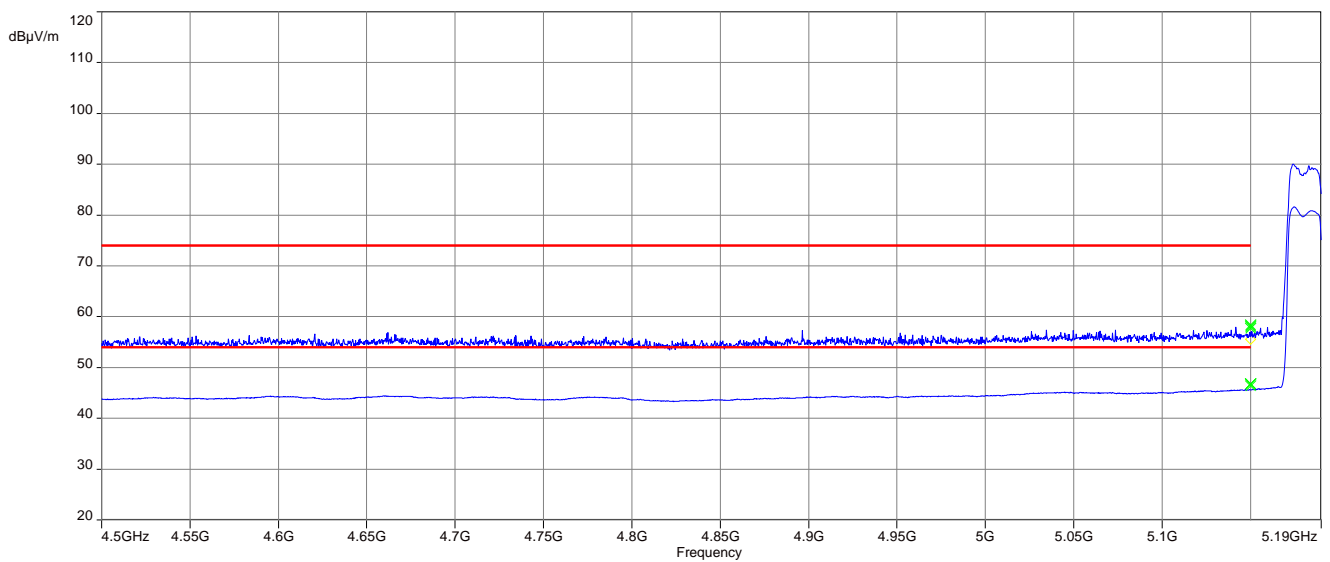

Plot 5: upper band edge; U-NII-2A; highest channel; 40 MHz channel bandwidth

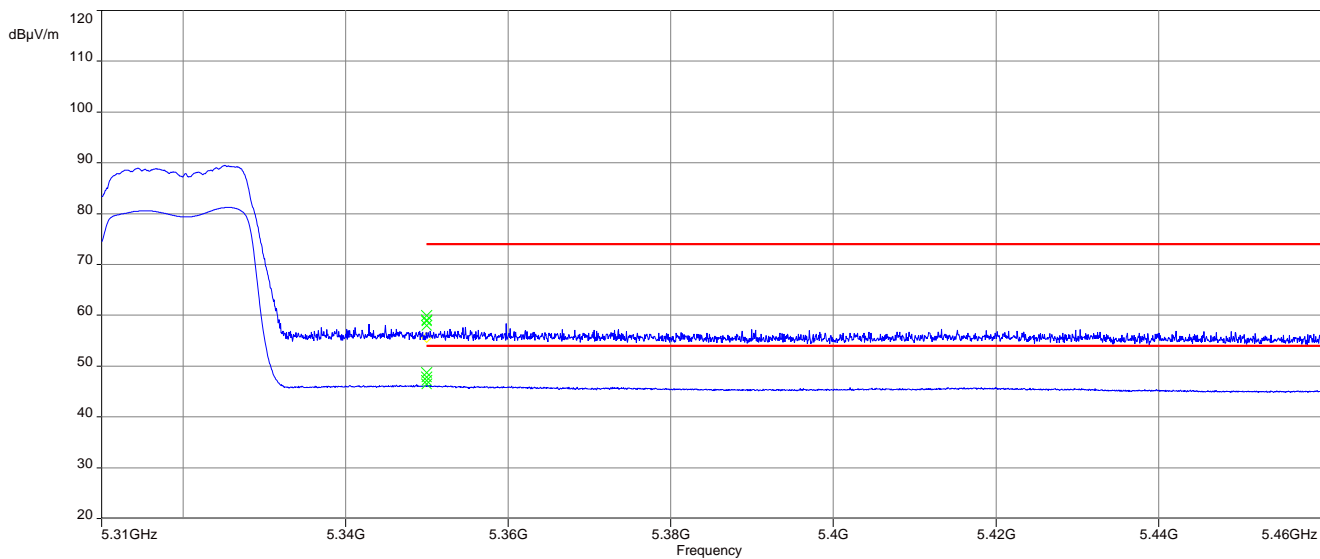

Plot 6: lower band edge; U-NII-2C; lowest channel; 40 MHz channel bandwidth

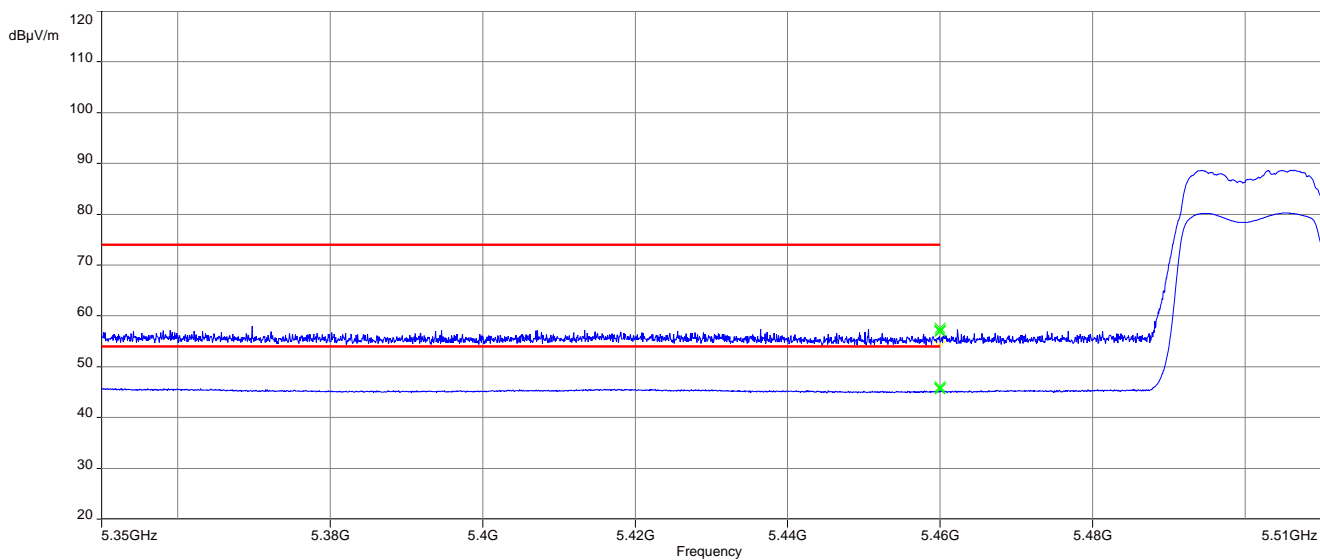

12.10 Spurious emissions radiated below 30 MHz

Description:

Measurement of the radiated spurious emissions in transmit mode below 30 MHz. The limits are re-calculated to a measurement distance of 3 m with 40 dB/decade according CFR Part 2.

Measurement:

| Measurement parameter | |
|--------------------------|--|
| Detector: | Peak / Quasi Peak |
| Sweep time: | Auto |
| Video bandwidth: | F < 150 kHz: 200 Hz F > 150 kHz: 9 kHz |
| Resolution bandwidth: | F < 150 kHz: 1 kHz F > 150 kHz: 100 kHz |
| Span: | 9 kHz to 30 MHz |
| Trace mode: | Max Hold |
| Test setup: | See sub clause 6.2 – C |
| Measurement uncertainty: | See chapter 9 |

Limits:

| Spurious Emissions Radiated < 30 MHz | | |
|--------------------------------------|-------------------------|----------------------|
| Frequency (MHz) | Field Strength (dBµV/m) | Measurement distance |
| 0.009 – 0.490 | 2400/F(kHz) | 300 |
| 0.490 – 1.705 | 24000/F(kHz) | 30 |
| 1.705 – 30.0 | 30 | 30 |

Results:

| Spurious Emissions Radiated < 30 MHz [dBµV/m] | | |
|---|----------|----------------|
| F [MHz] | Detector | Level [dBµV/m] |
| All detected emissions are more than 20 dB below the limit. | | |

Plots: 20 MHz channel bandwidth

Plot 1: 9 kHz to 30 MHz, U-NII-1; lowest channel

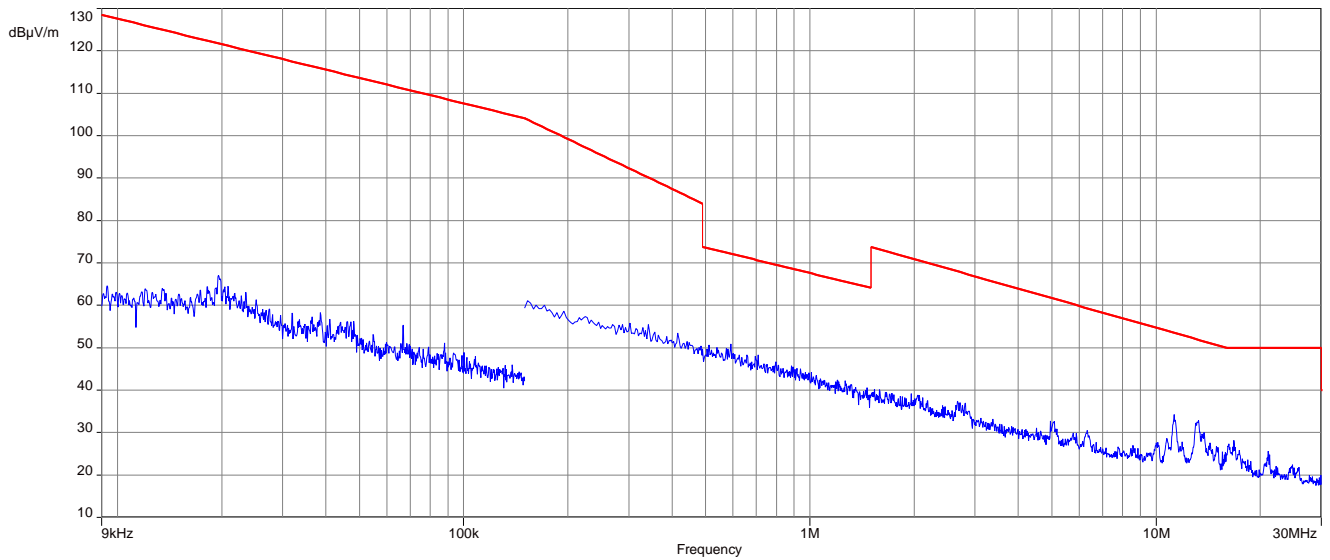

Plot 2: 9 kHz to 30 MHz, U-NII-1; middle channel

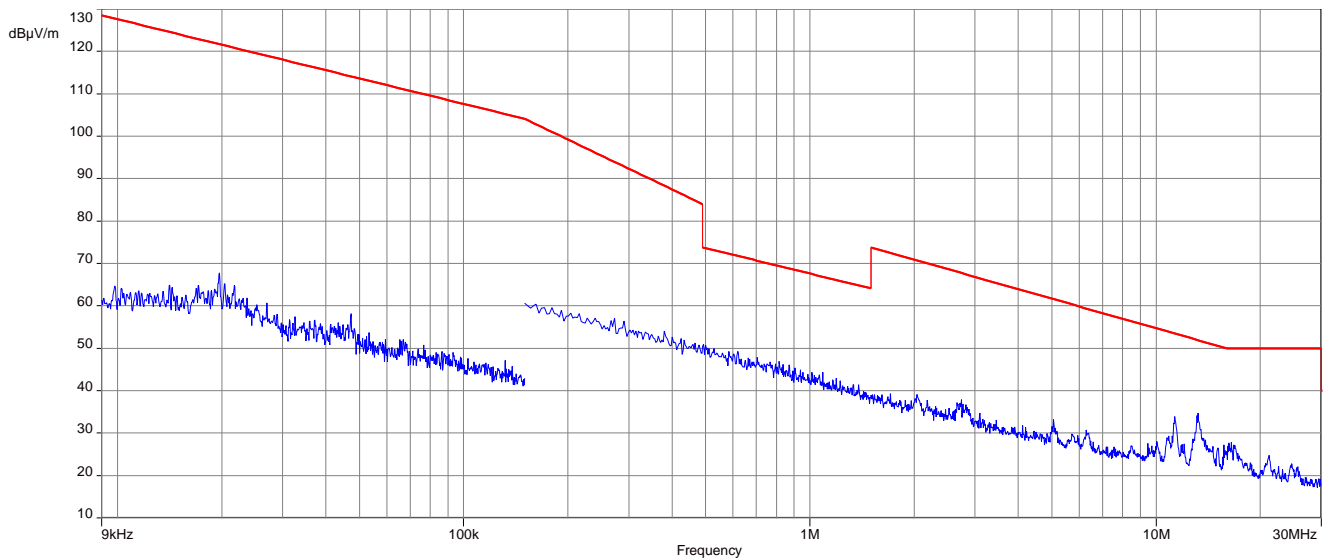

Plot 3: 9 kHz to 30 MHz, U-NII-1; highest channel

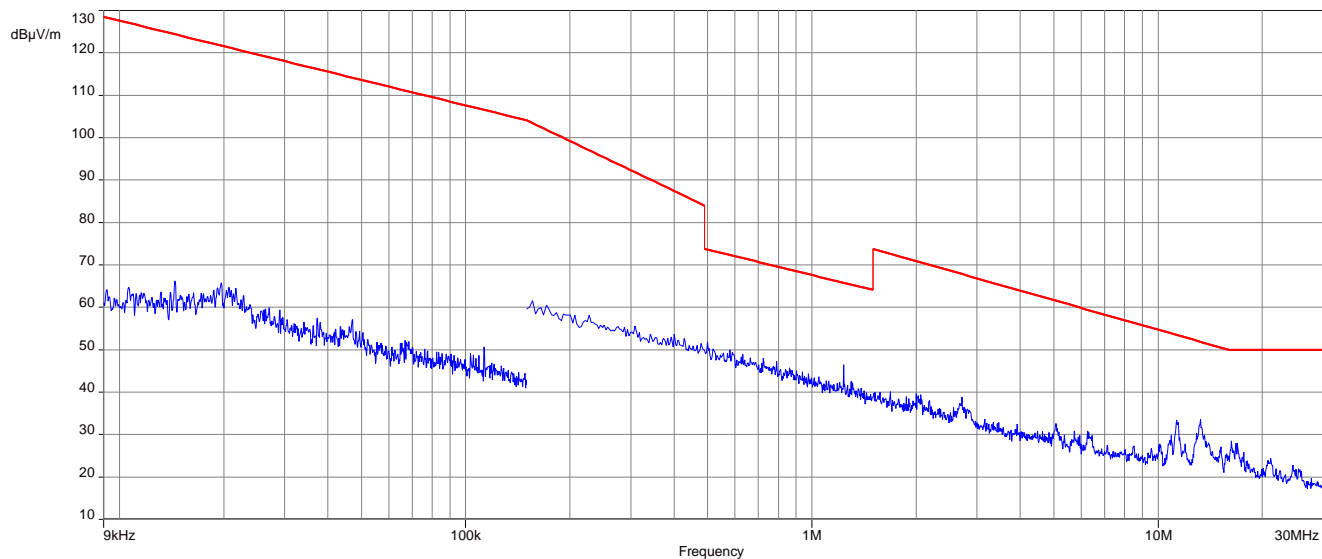

Plot 4: 9 kHz to 30 MHz, U-NII-2A; lowest channel

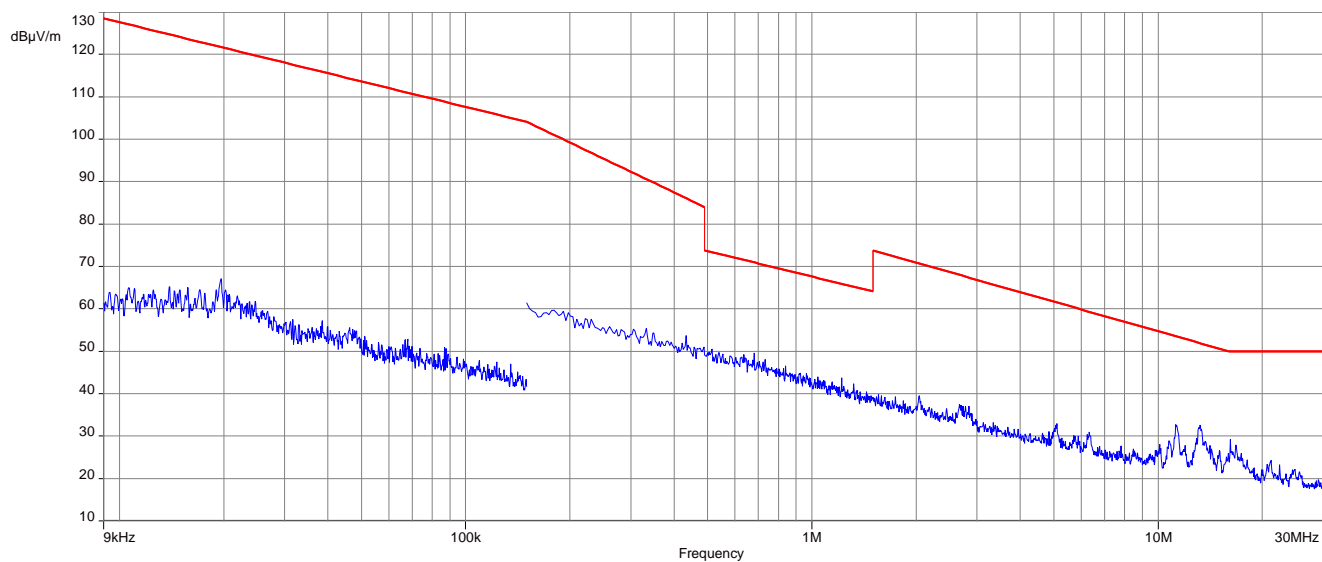

Plot 5: 9 kHz to 30 MHz, U-NII-2A; middle channel

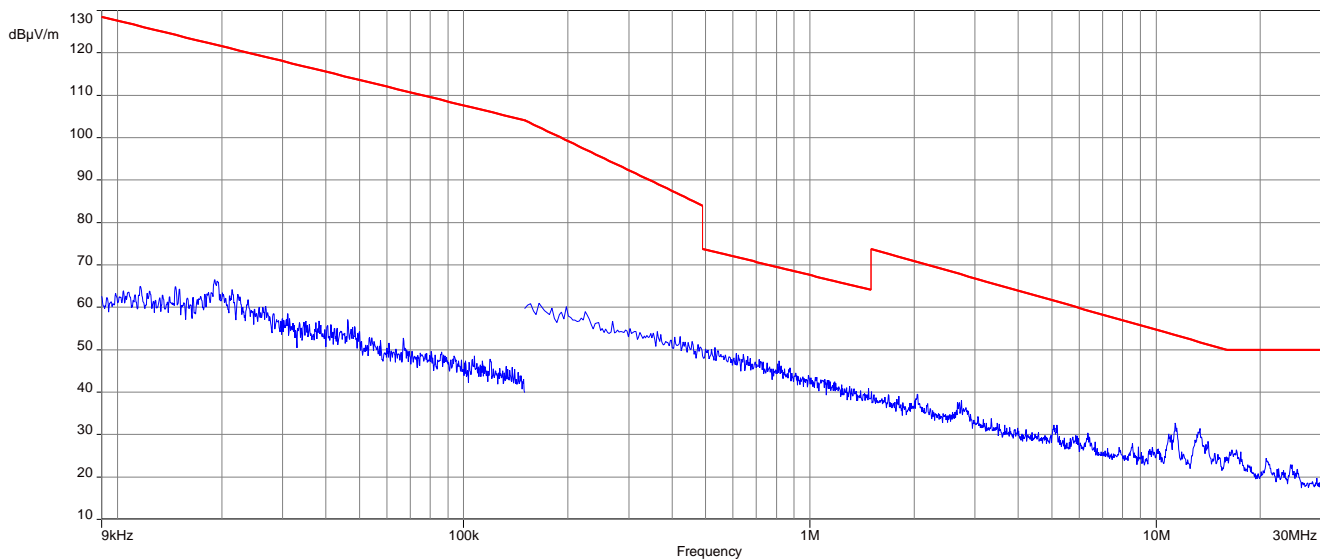

Plot 6: 9 kHz to 30 MHz, U-NII-2A; highest channel

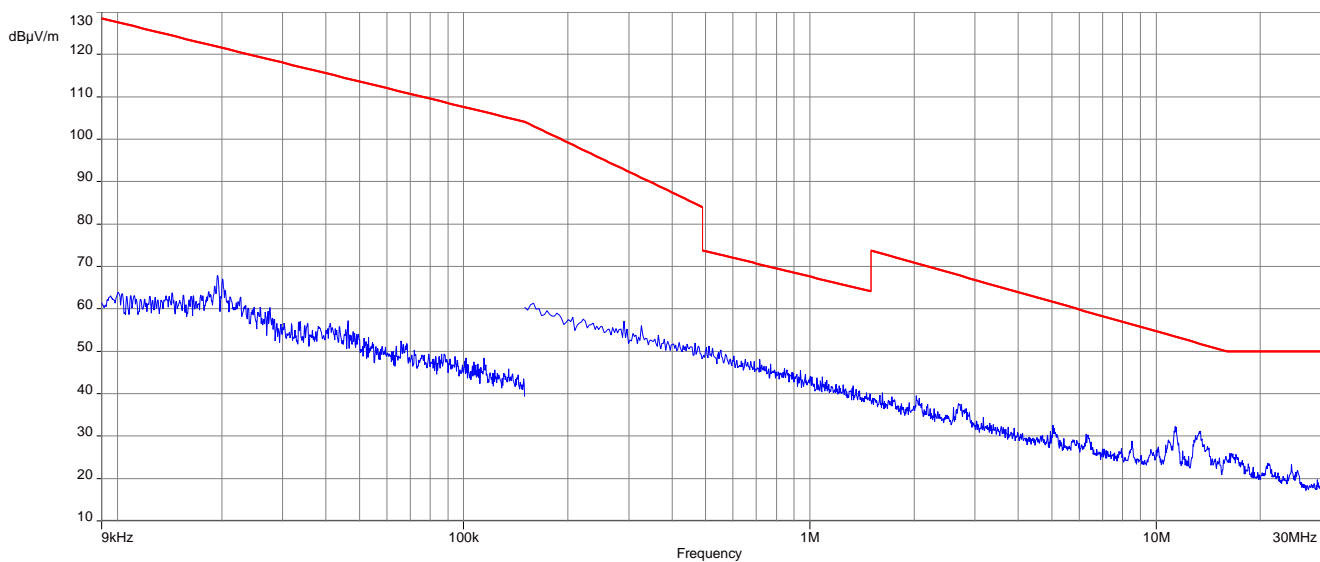

Plot 7: 9 kHz to 30 MHz, U-NII-2C; lowest channel

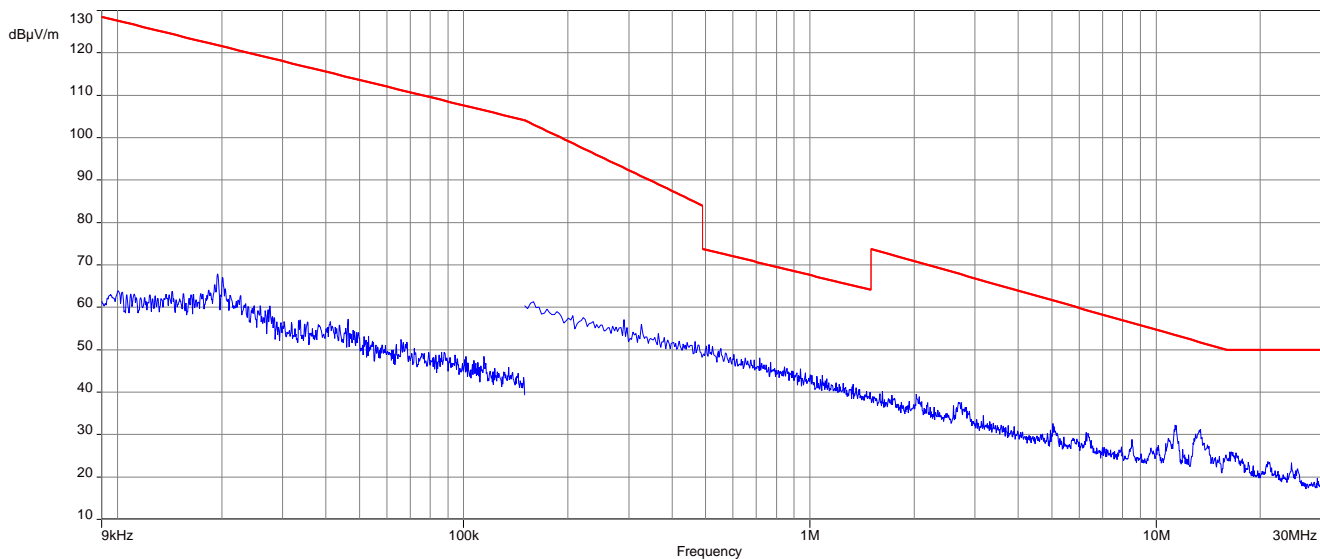

Plot 8: 9 kHz to 30 MHz, U-NII-2C; middle channel

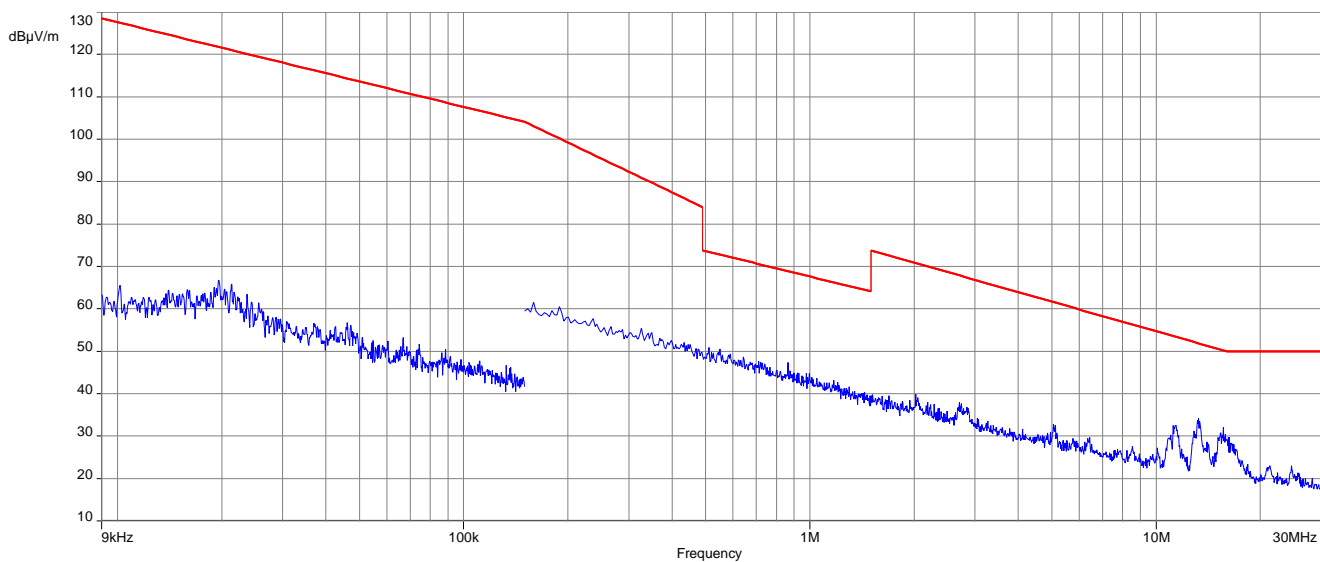

Plot 9: 9 kHz to 30 MHz, U-NII-2C; highest channel

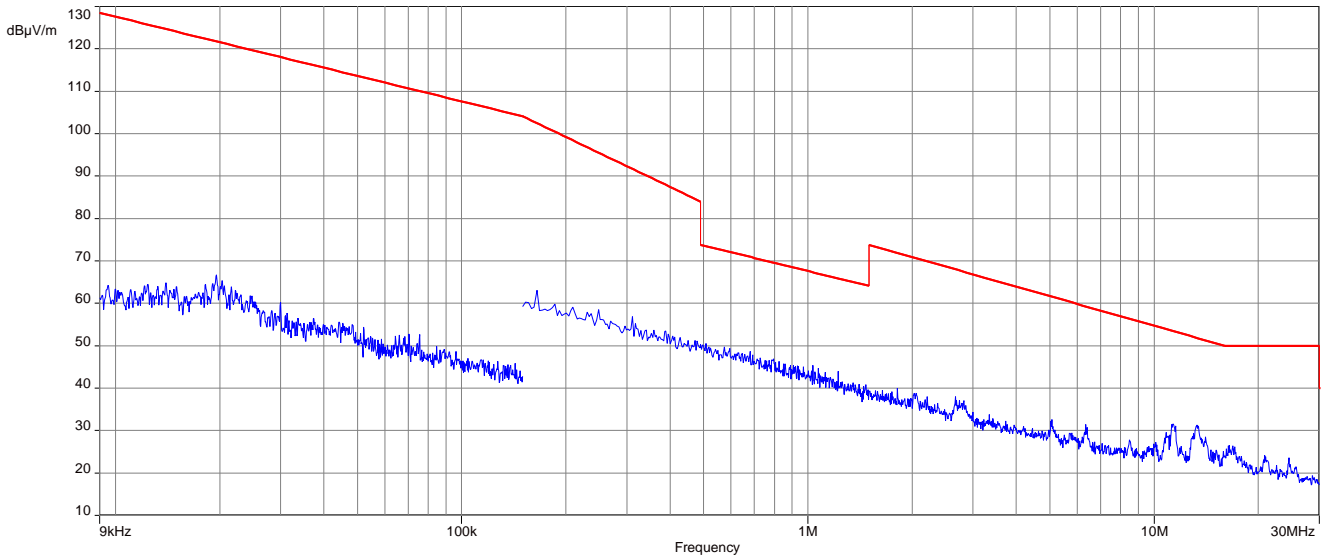

Plot 10: 9 kHz to 30 MHz, U-NII-3; lowest channel

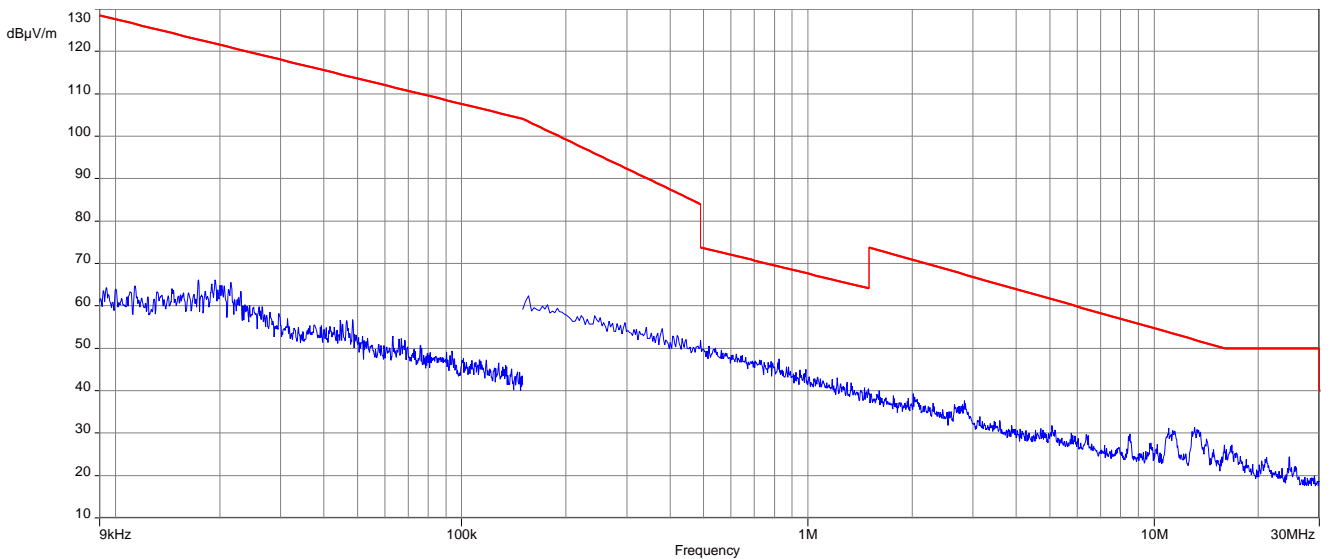

Plot 11: 9 kHz to 30 MHz, U-NII-3; middle channel

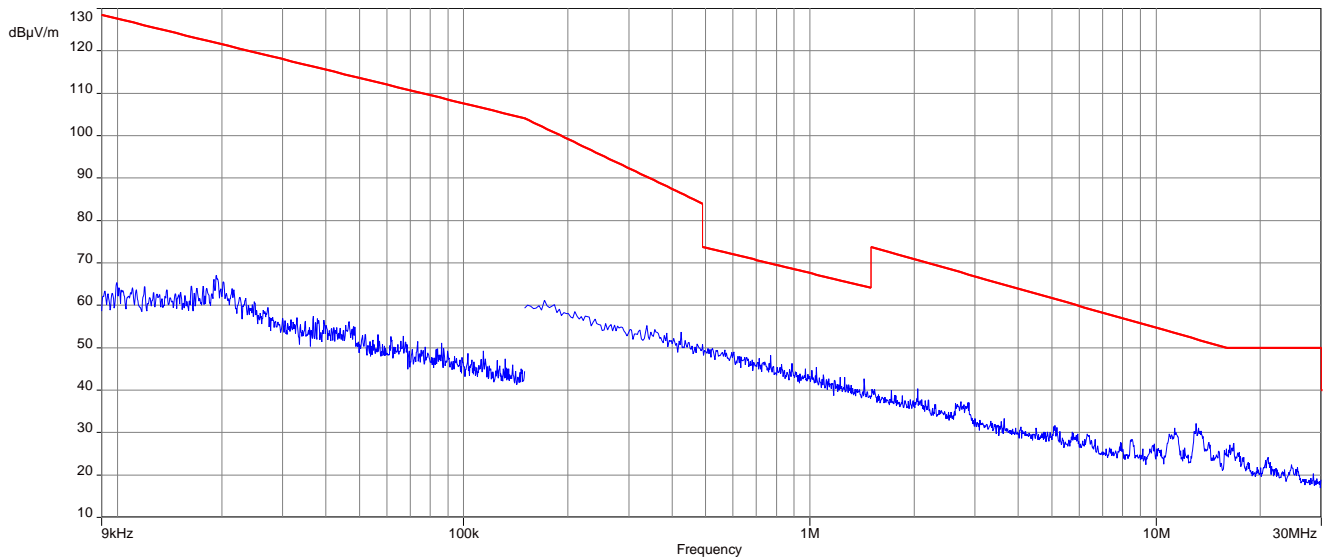

Plot 12: 9 kHz to 30 MHz, U-NII-3; highest channel

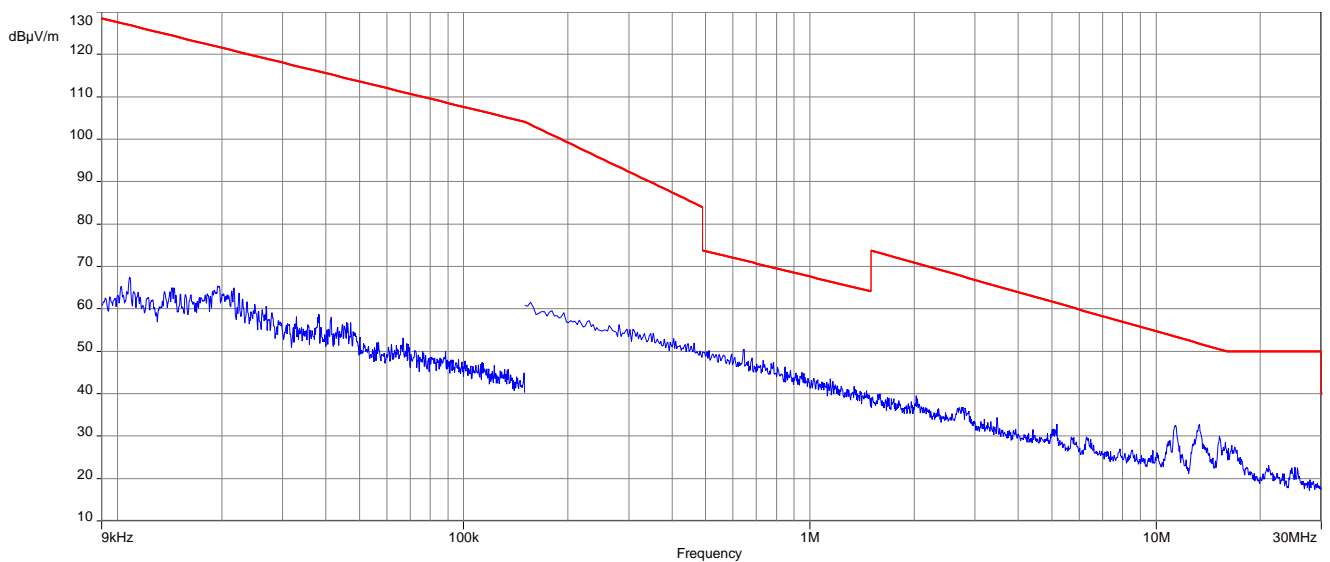

Plots: 40 MHz channel bandwidth

Plot 1: 9 kHz to 30 MHz, U-NII-1; lowest channel

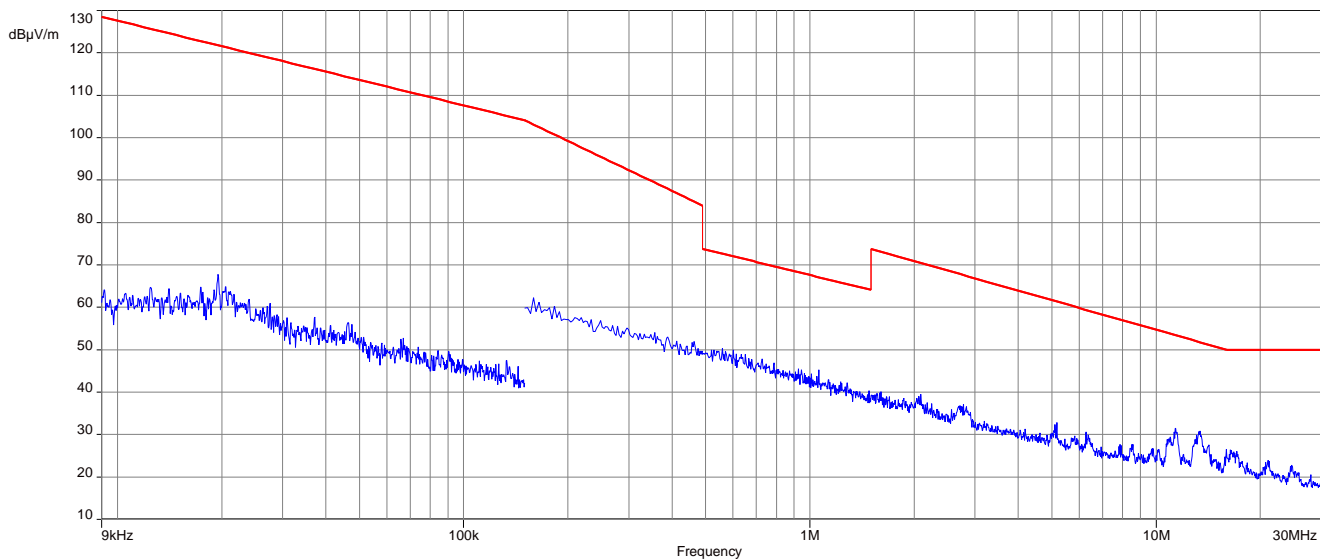

Plot 2: 9 kHz to 30 MHz, U-NII-1; highest channel

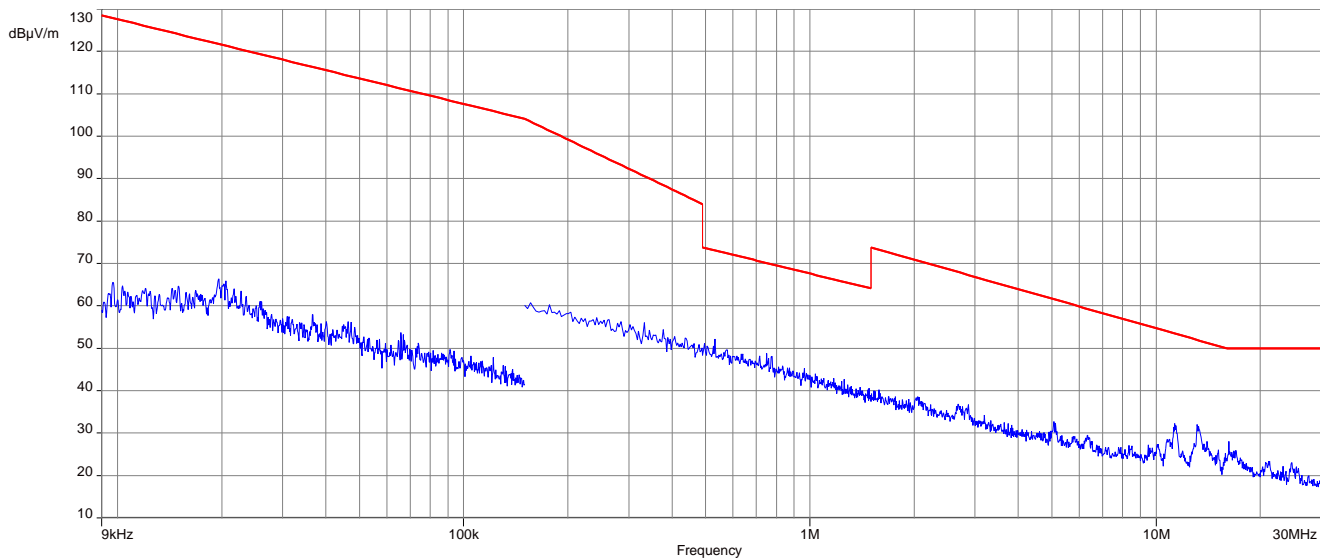

Plot 3: 9 kHz to 30 MHz, U-NII-2A; lowest channel

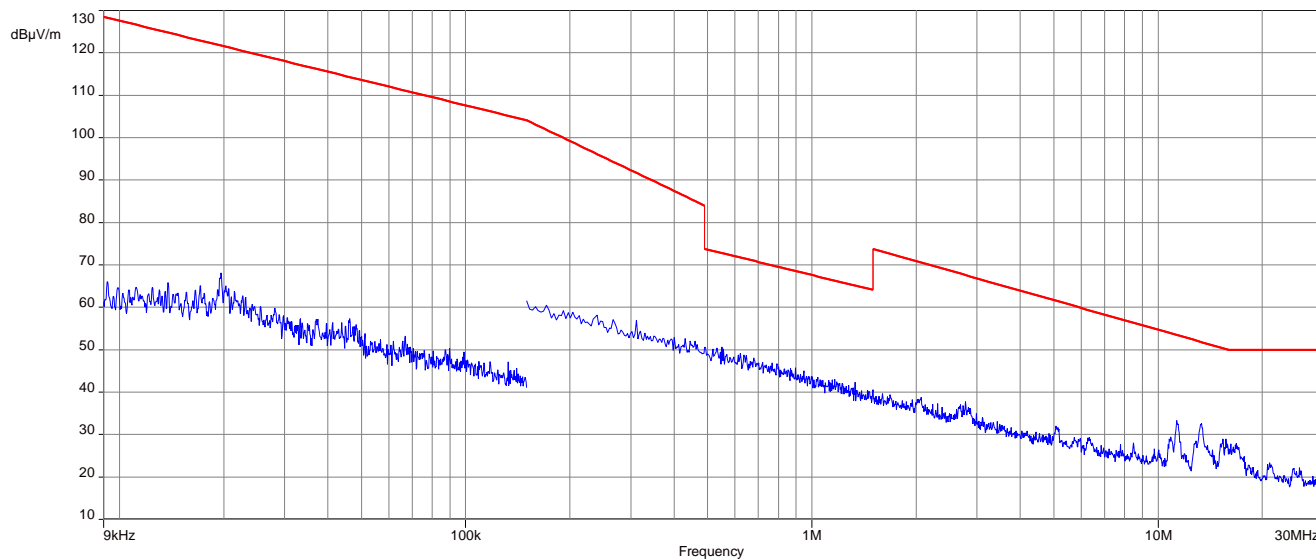

Plot 4: 9 kHz to 30 MHz, U-NII-2A; highest channel

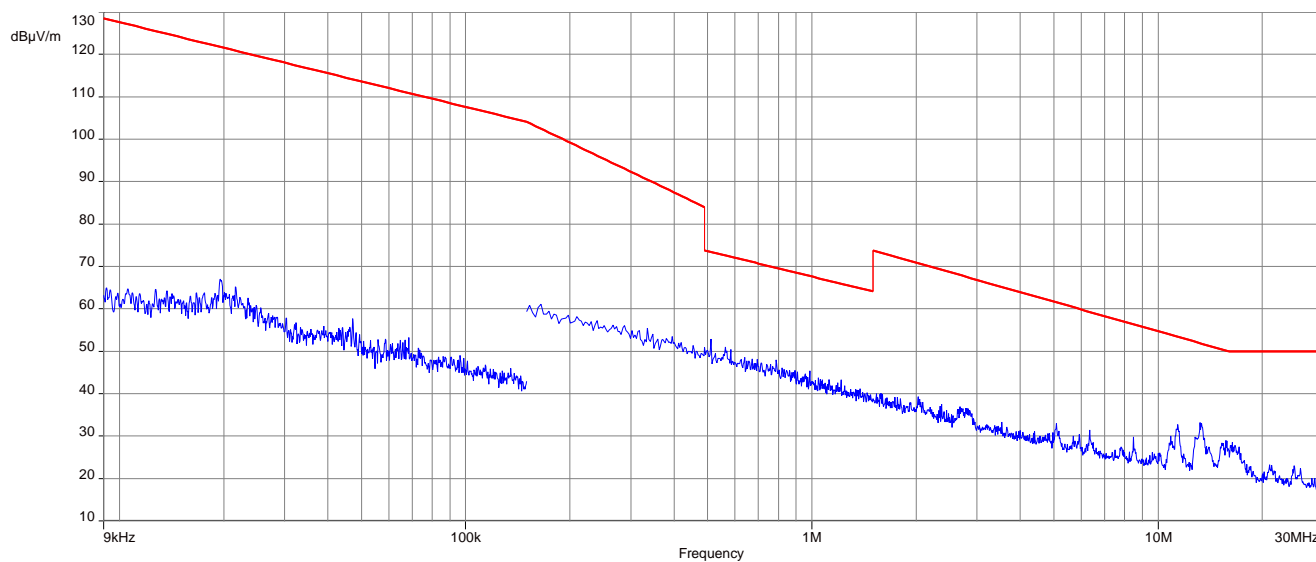

Plot 5: 9 kHz to 30 MHz, U-NII-2C; lowest channel

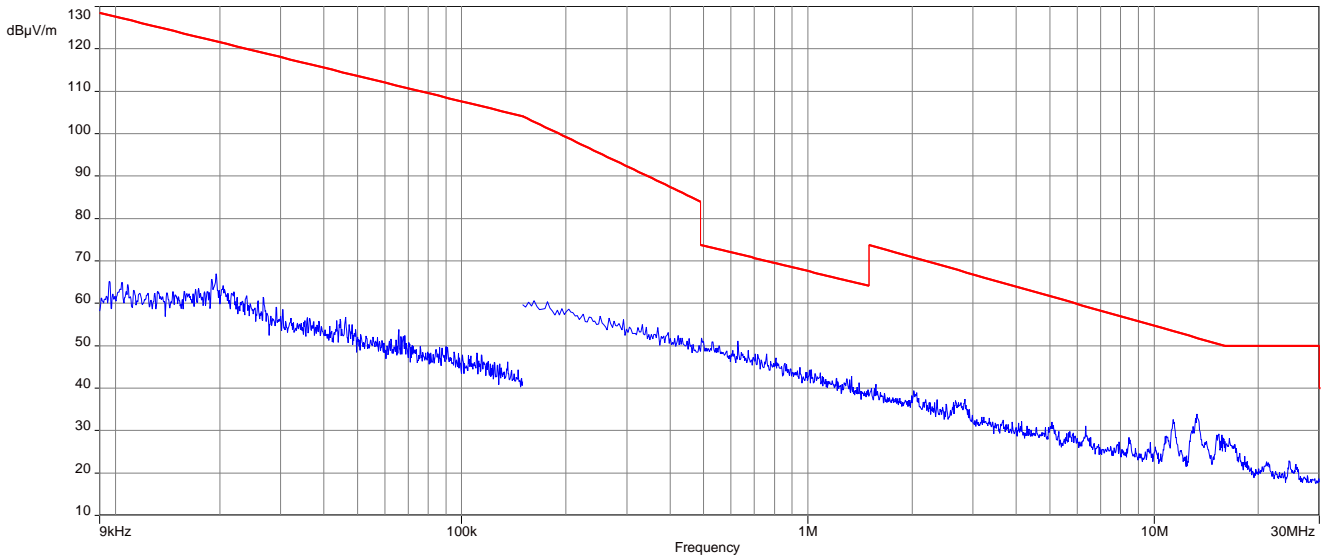

Plot 6: 9 kHz to 30 MHz, U-NII-2C; middle channel

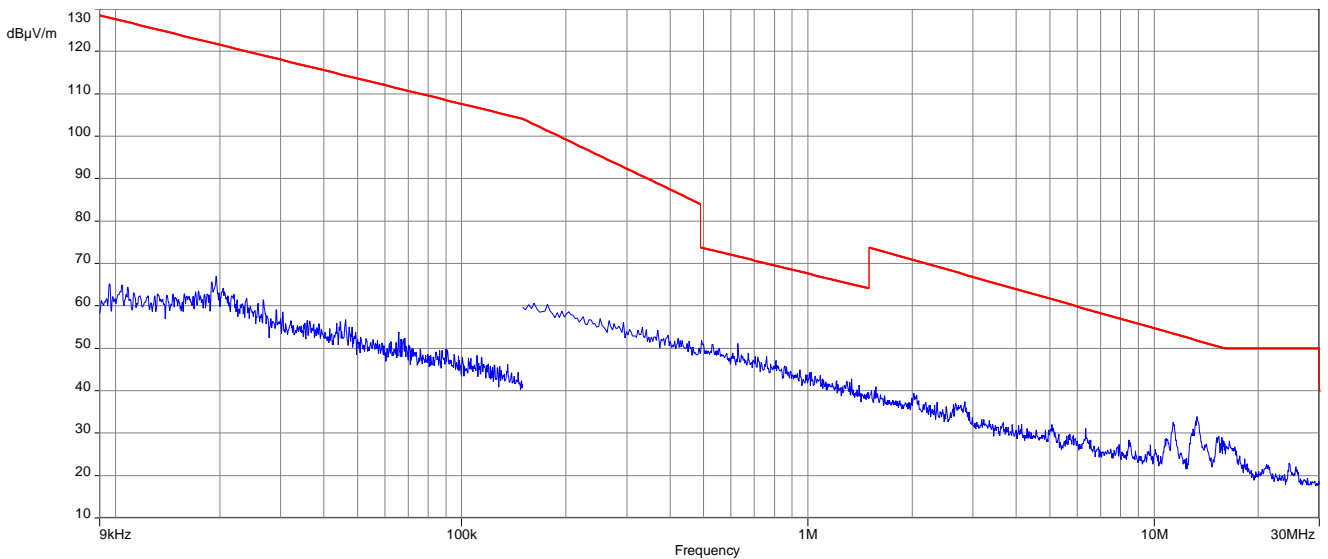

Plot 7: 9 kHz to 30 MHz, U-NII-2C; highest channel

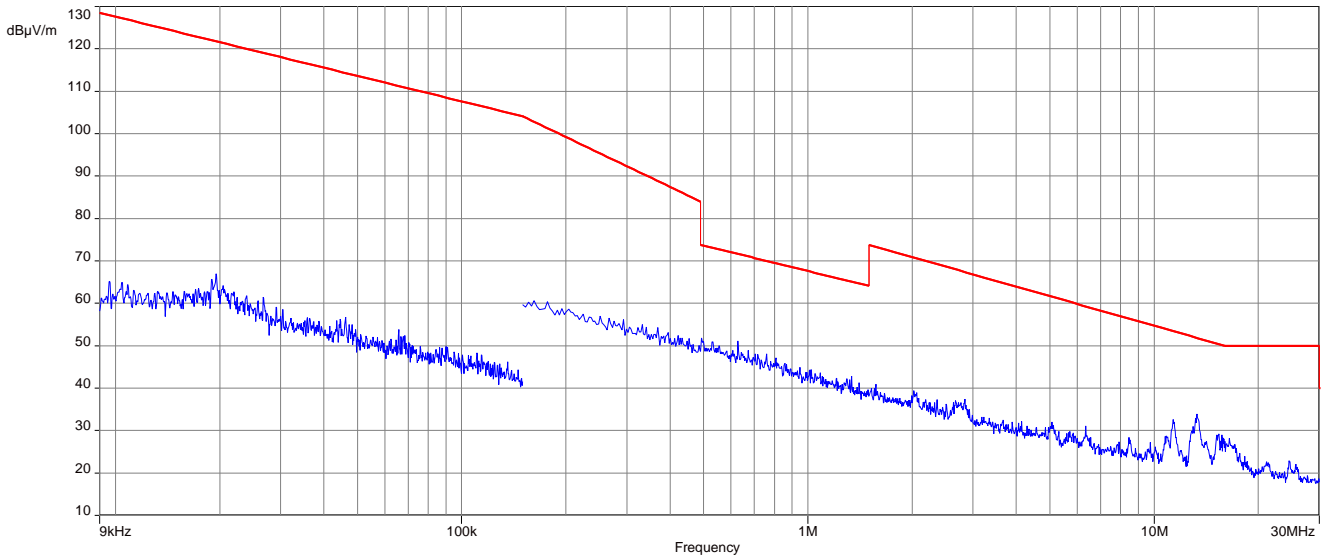

Plot 8: 9 kHz to 30 MHz, U-NII-3; lowest channel

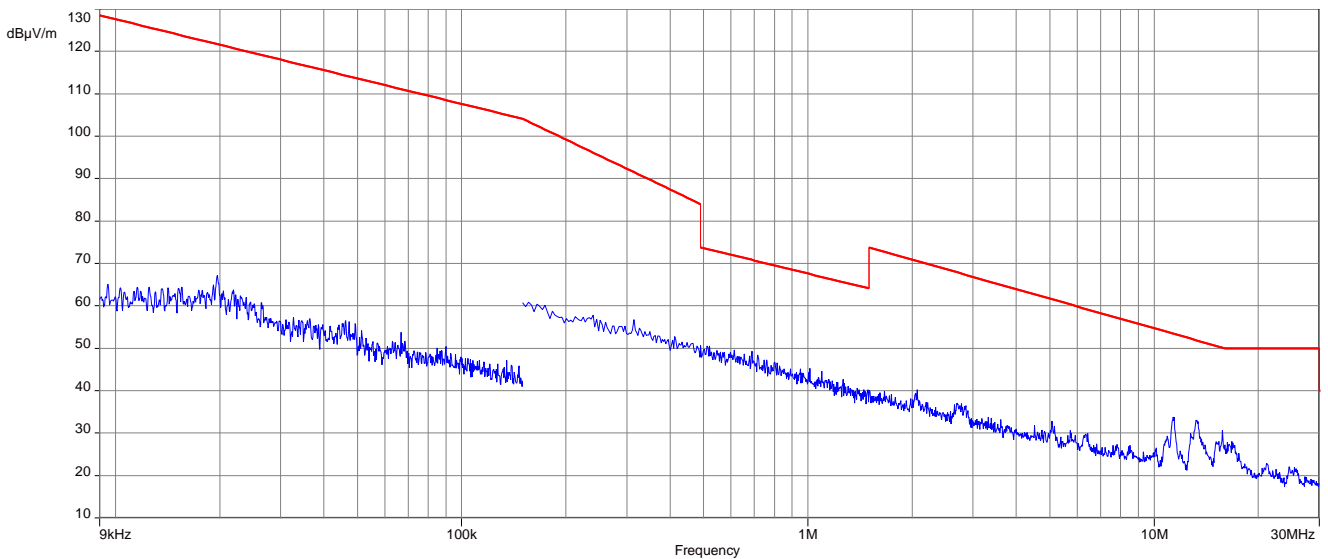

Plot 9: 9 kHz to 30 MHz, U-NII-3; highest channel

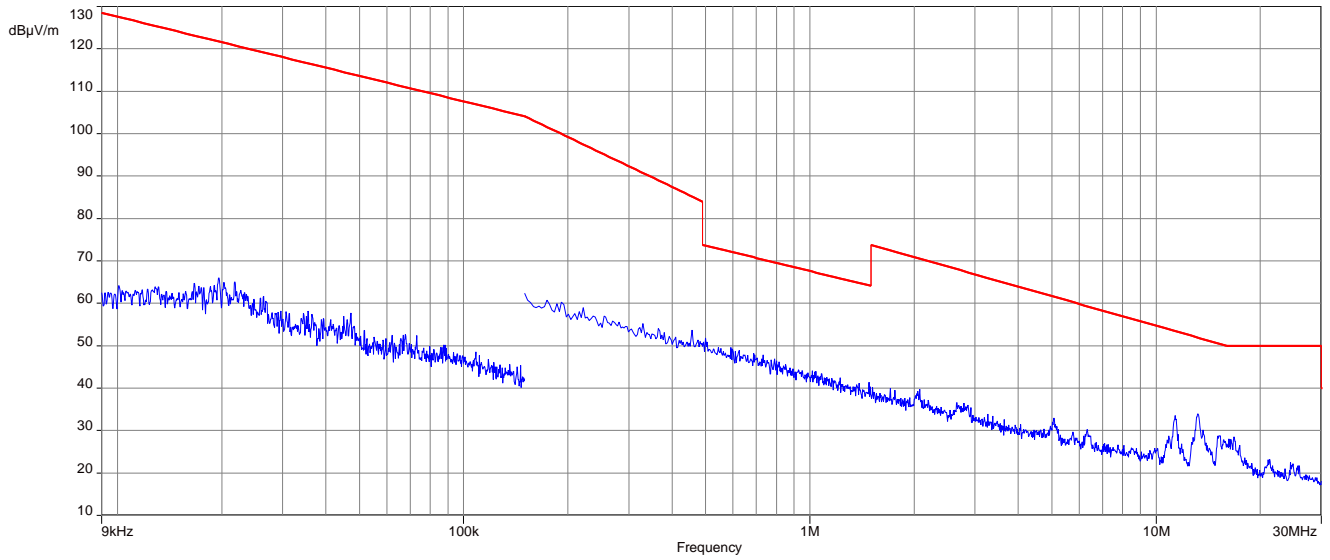

12.11 Spurious emissions radiated 30 MHz to 1 GHz

Description:

Measurement of the radiated spurious emissions and cabinet radiations below 1 GHz.

Measurement:

| Measurement parameter | |
|--------------------------|------------------------|
| Detector: | Quasi Peak |
| Sweep time: | Auto |
| Resolution bandwidth: | 120 kHz |
| Video bandwidth: | 500 kHz |
| Span: | 30 MHz to 1 GHz |
| Test setup: | See sub clause 7.1 – A |
| Measurement uncertainty: | See chapter 9 |

Limits:

| TX Spurious Emissions Radiated | | |
|--------------------------------|-------------------------|----------------------|
| §15.209 / RSS-247 | | |
| Frequency (MHz) | Field Strength (dBµV/m) | Measurement distance |
| 30 - 88 | 30.0 | 10 |
| 88 – 216 | 33.5 | 10 |
| 216 – 960 | 36.0 | 10 |
| Above 960 | 54.0 | 3 |
| §15.407 | | |
| Outside the restricted bands! | -27 dBm / MHz | |

Plots: 20 MHz channel bandwidth

Plot 1: 30 MHz to 1 GHz; vertical & horizontal polarization; U-NII-1 (worst case)

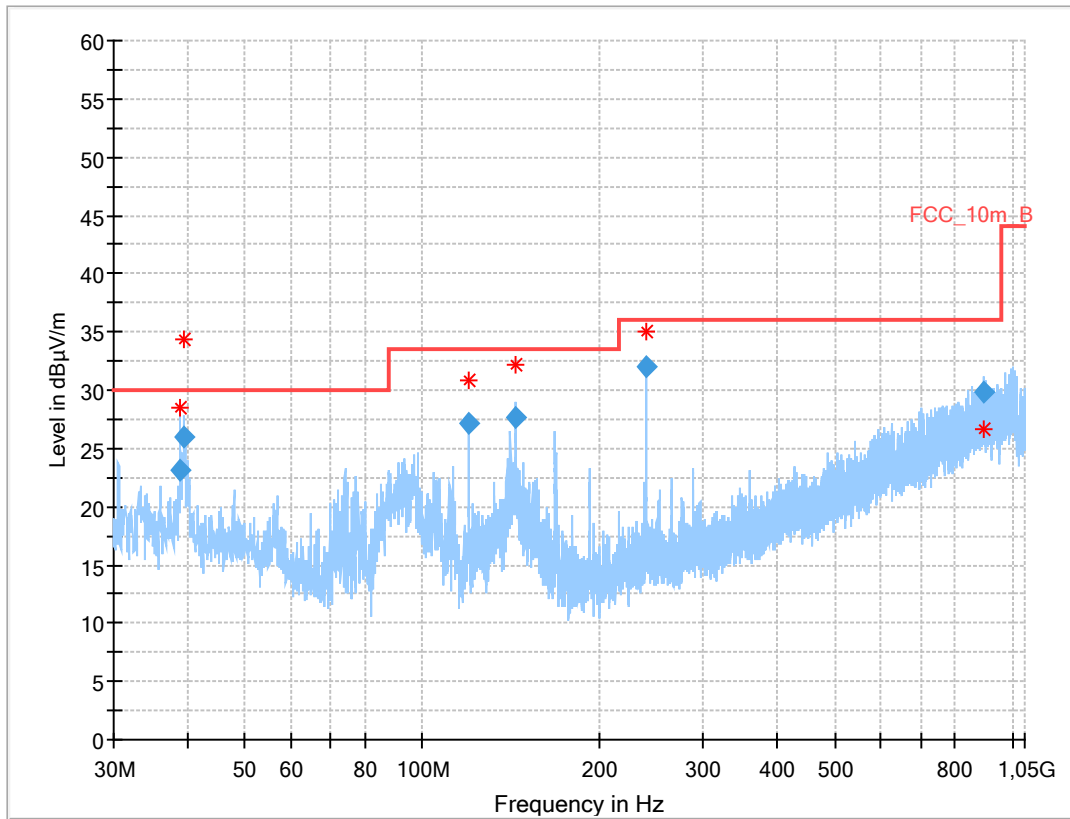

Results:

| Frequency (MHz) | QuasiPeak (dBµV/m) | Limit (dBµV/m) | Margin (dB) | Meas. Time (ms) | Bandwidth (kHz) | Height (cm) | Pol | Azimuth (deg) | Corr. (dB) |
|-----------------|--------------------|----------------|-------------|-----------------|-----------------|-------------|-----|---------------|------------|
| 38.942 | 23.08 | 30.0 | 6.9 | 1000 | 120.0 | 145.0 | V | -9 | 15 |
| 39.486 | 25.90 | 30.0 | 4.1 | 1000 | 120.0 | 137.0 | V | 210 | 15 |
| 120.009 | 27.21 | 33.5 | 6.3 | 1000 | 120.0 | 98.0 | V | 307 | 11 |
| 144.128 | 27.71 | 33.5 | 5.8 | 1000 | 120.0 | 114.0 | V | 1 | 10 |
| 239.988 | 31.96 | 36.0 | 4.0 | 1000 | 120.0 | 110.0 | V | 13 | 14 |
| 897.701 | 29.79 | 36.0 | 6.2 | 1000 | 120.0 | 188.0 | V | 52 | 25 |

Plot 2: 30 MHz to 1 GHz; vertical & horizontal polarization; U-NII-2A (worst case)

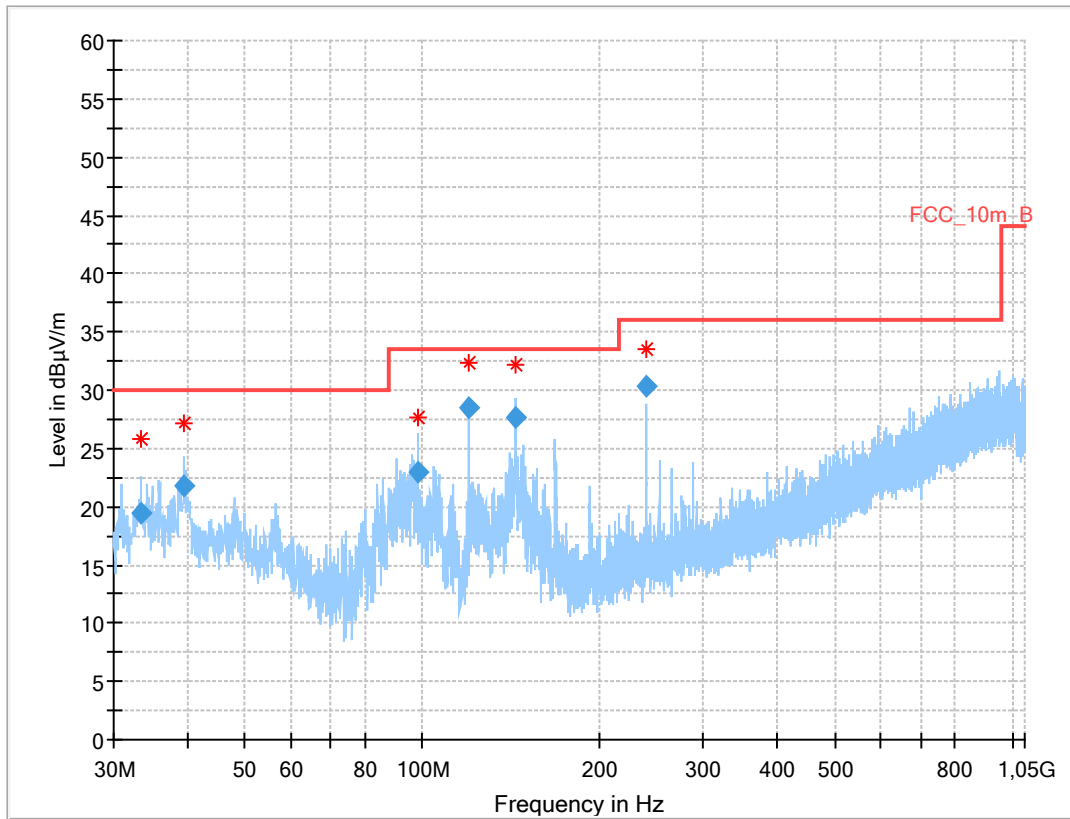

Results:

| Frequency (MHz) | QuasiPeak (dBµV/m) | Limit (dBµV/m) | Margin (dB) | Meas. Time (ms) | Bandwidth (kHz) | Height (cm) | Pol | Azimuth (deg) | Corr. (dB) |
|-----------------|--------------------|----------------|-------------|-----------------|-----------------|-------------|-----|---------------|------------|
| 33.497 | 19.40 | 30.0 | 10.6 | 1000 | 120.0 | 171.0 | V | 156 | 14 |
| 39.512 | 21.80 | 30.0 | 8.2 | 1000 | 120.0 | 147.0 | V | 64 | 15 |
| 98.435 | 22.91 | 33.5 | 10.6 | 1000 | 120.0 | 113.0 | V | 188 | 13 |
| 120.001 | 28.48 | 33.5 | 5.0 | 1000 | 120.0 | 98.0 | V | 294 | 11 |
| 144.114 | 27.69 | 33.5 | 5.8 | 1000 | 120.0 | 98.0 | V | -35 | 10 |
| 240.011 | 30.30 | 36.0 | 5.7 | 1000 | 120.0 | 126.0 | V | 55 | 14 |

Plot 3: 30 MHz to 1 GHz; vertical & horizontal polarization; U-NII-2C (worst case)

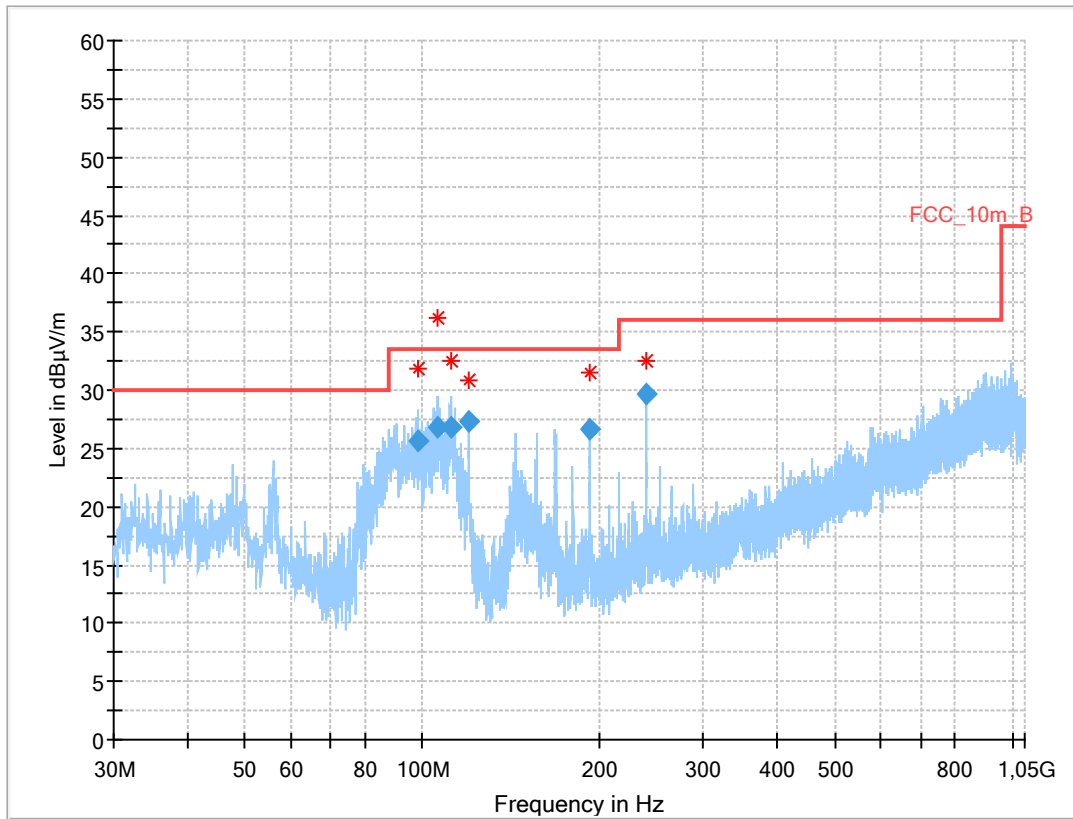

Results:

| Frequency (MHz) | QuasiPeak (dBµV/m) | Limit (dBµV/m) | Margin (dB) | Meas. Time (ms) | Bandwidth (kHz) | Height (cm) | Pol | Azimuth (deg) | Corr. (dB) |
|-----------------|--------------------|----------------|-------------|-----------------|-----------------|-------------|-----|---------------|------------|
| 98.409 | 25.56 | 33.5 | 7.9 | 1000 | 120.0 | 112.0 | V | 127 | 13 |
| 106.567 | 26.82 | 33.5 | 6.7 | 1000 | 120.0 | 144.0 | V | 23 | 14 |
| 111.629 | 26.76 | 33.5 | 6.7 | 1000 | 120.0 | 195.0 | V | 112 | 13 |
| 120.021 | 27.32 | 33.5 | 6.2 | 1000 | 120.0 | 153.0 | V | 117 | 11 |
| 191.994 | 26.66 | 33.5 | 6.8 | 1000 | 120.0 | 133.0 | V | 307 | 12 |
| 239.999 | 29.64 | 36.0 | 6.4 | 1000 | 120.0 | 102.0 | V | 189 | 14 |

Plot 4: 30 MHz to 1 GHz; vertical & horizontal polarization; U-NII-3 (worst case)

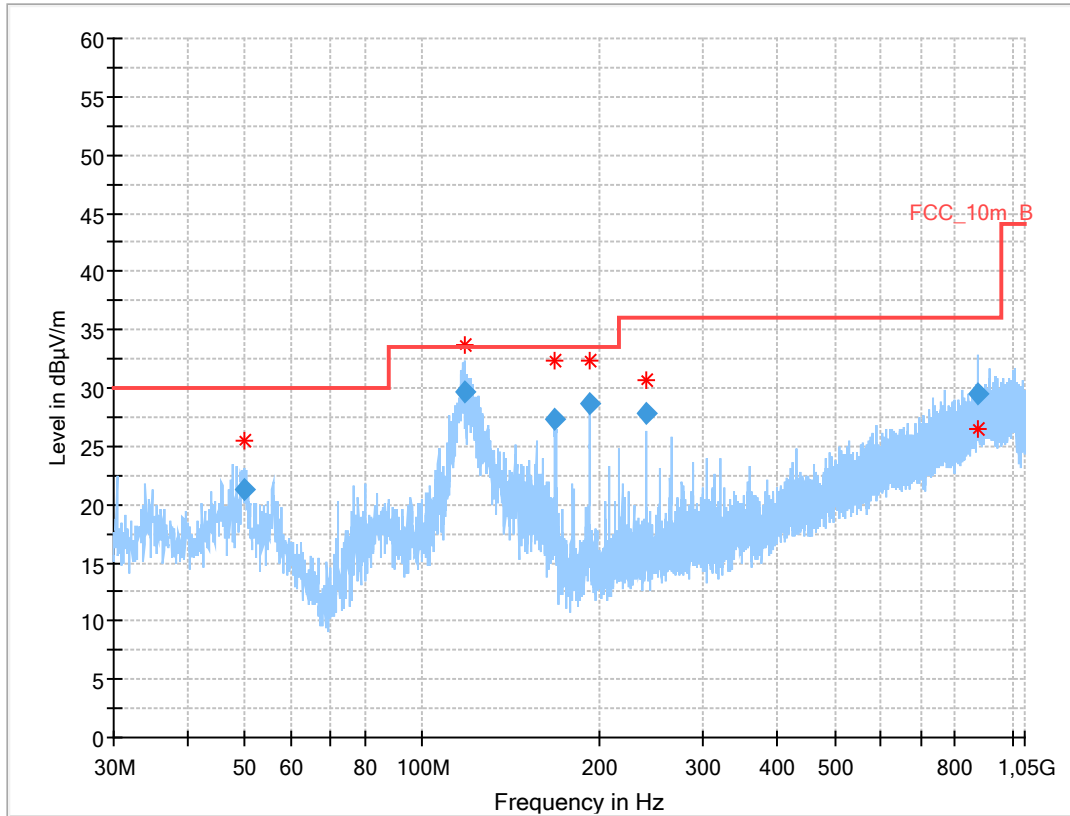

Results:

| Frequency (MHz) | QuasiPeak (dBµV/m) | Limit (dBµV/m) | Margin (dB) | Meas. Time (ms) | Bandwidth (kHz) | Height (cm) | Pol | Azimuth (deg) | Corr. (dB) |
|-----------------|--------------------|----------------|-------------|-----------------|-----------------|-------------|-----|---------------|------------|
| 49.999 | 21.26 | 30.0 | 8.7 | 1000 | 120.0 | 116.0 | V | -37 | 16 |
| 117.660 | 29.61 | 33.5 | 3.9 | 1000 | 120.0 | 152.0 | V | 55 | 12 |
| 168.126 | 27.38 | 33.5 | 6.1 | 1000 | 120.0 | 104.0 | V | -34 | 11 |
| 191.984 | 28.60 | 33.5 | 4.9 | 1000 | 120.0 | 98.0 | V | -34 | 12 |
| 240.009 | 27.77 | 36.0 | 8.2 | 1000 | 120.0 | 105.0 | V | 127 | 14 |
| 874.337 | 29.51 | 36.0 | 6.5 | 1000 | 120.0 | 195.0 | H | -26 | 25 |

Plots: 40 MHz channel bandwidth

Plot 1: 30 MHz to 1 GHz; vertical & horizontal polarization; U-NII-1 (worst case)

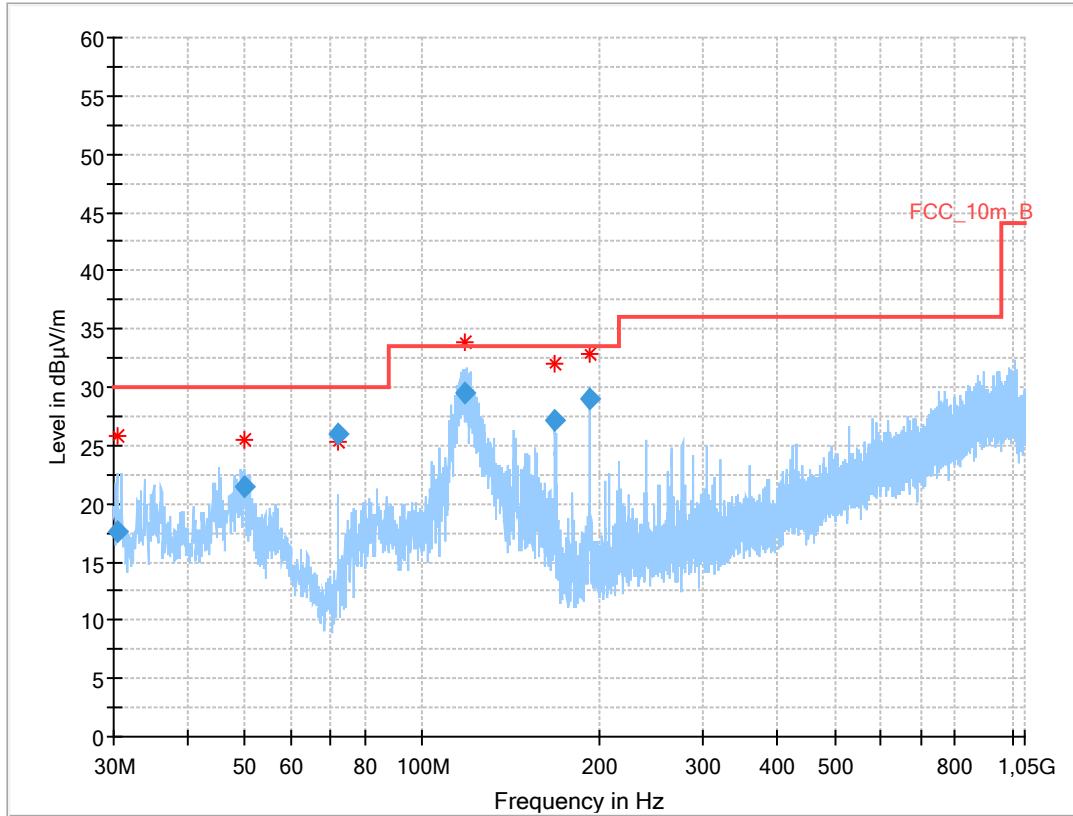

Results:

| Frequency (MHz) | QuasiPeak (dBµV/m) | Limit (dBµV/m) | Margin (dB) | Meas. Time (ms) | Bandwidth (kHz) | Height (cm) | Pol | Azimuth (deg) | Corr. (dB) |
|-----------------|--------------------|----------------|-------------|-----------------|-----------------|-------------|-----|---------------|------------|
| 30.491 | 17.63 | 30.0 | 12.4 | 1000 | 120.0 | 98.0 | V | 53 | 13 |
| 49.874 | 21.51 | 30.0 | 8.5 | 1000 | 120.0 | 101.0 | V | -35 | 16 |
| 72.018 | 26.00 | 30.0 | 4.0 | 1000 | 120.0 | 195.0 | V | 307 | 9 |
| 117.693 | 29.50 | 33.5 | 4.0 | 1000 | 120.0 | 159.0 | V | 52 | 12 |
| 168.103 | 27.20 | 33.5 | 6.3 | 1000 | 120.0 | 111.0 | V | -32 | 11 |
| 192.001 | 29.01 | 33.5 | 4.5 | 1000 | 120.0 | 109.0 | V | -34 | 12 |

Plot 2: 30 MHz to 1 GHz; vertical & horizontal polarization; U-NII-2A (worst case)

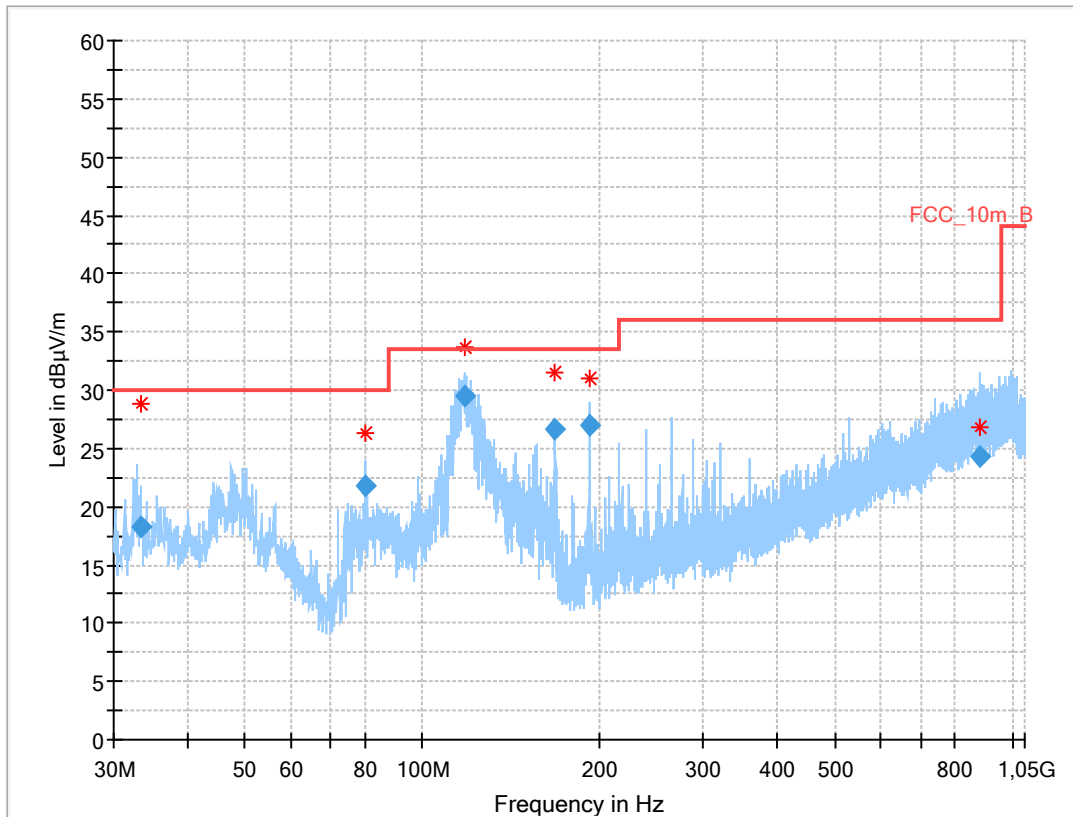

Results:

| Frequency (MHz) | QuasiPeak (dBµV/m) | Limit (dBµV/m) | Margin (dB) | Meas. Time (ms) | Bandwidth (kHz) | Height (cm) | Pol | Azimuth (deg) | Corr. (dB) |
|-----------------|--------------------|----------------|-------------|-----------------|-----------------|-------------|-----|---------------|------------|
| 33.450 | 18.30 | 30.0 | 11.7 | 1000 | 120.0 | 177.0 | V | 238 | 14 |
| 79.986 | 21.73 | 30.0 | 8.3 | 1000 | 120.0 | 165.0 | V | 127 | 8 |
| 117.929 | 29.50 | 33.5 | 4.0 | 1000 | 120.0 | 154.0 | V | 56 | 12 |
| 167.956 | 26.70 | 33.5 | 6.8 | 1000 | 120.0 | 98.0 | V | -32 | 11 |
| 192.016 | 27.05 | 33.5 | 6.5 | 1000 | 120.0 | 102.0 | V | 151 | 12 |
| 879.549 | 24.35 | 36.0 | 11.7 | 1000 | 120.0 | 114.0 | H | 232 | 25 |

Plot 3: 30 MHz to 1 GHz; vertical & horizontal polarization; U-NII-2C (worst case)

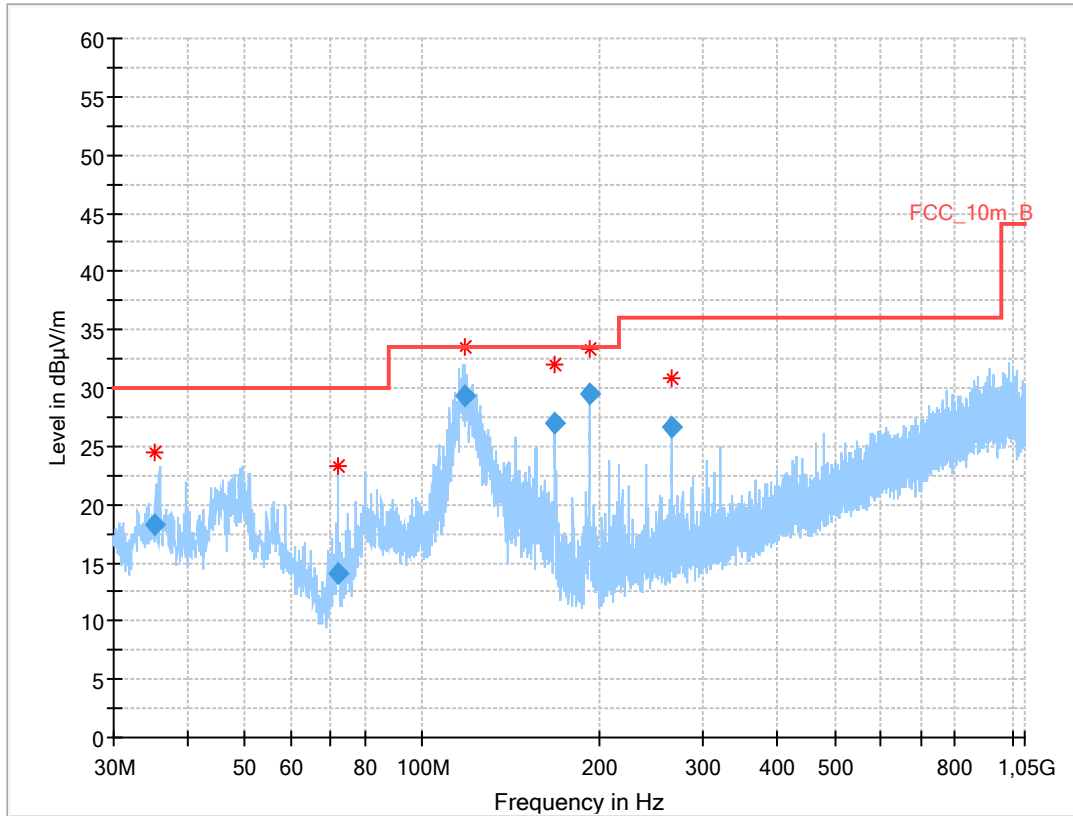

Results:

| Frequency (MHz) | QuasiPeak (dBµV/m) | Limit (dBµV/m) | Margin (dB) | Meas. Time (ms) | Bandwidth (kHz) | Height (cm) | Pol | Azimuth (deg) | Corr. (dB) |
|-----------------|--------------------|----------------|-------------|-----------------|-----------------|-------------|-----|---------------|------------|
| 35.324 | 18.29 | 30.0 | 11.7 | 1000 | 120.0 | 149.0 | V | 164 | 14 |
| 71.990 | 14.00 | 30.0 | 16.0 | 1000 | 120.0 | 143.0 | V | 251 | 9 |
| 118.041 | 29.34 | 33.5 | 4.2 | 1000 | 120.0 | 153.0 | V | 65 | 12 |
| 168.078 | 27.01 | 33.5 | 6.5 | 1000 | 120.0 | 105.0 | V | -32 | 11 |
| 191.992 | 29.54 | 33.5 | 4.0 | 1000 | 120.0 | 117.0 | V | -36 | 12 |
| 264.052 | 26.58 | 36.0 | 9.4 | 1000 | 120.0 | 101.0 | V | 142 | 14 |

Plot 4: 30 MHz to 1 GHz; vertical & horizontal polarization; U-NII-3 (worst case)

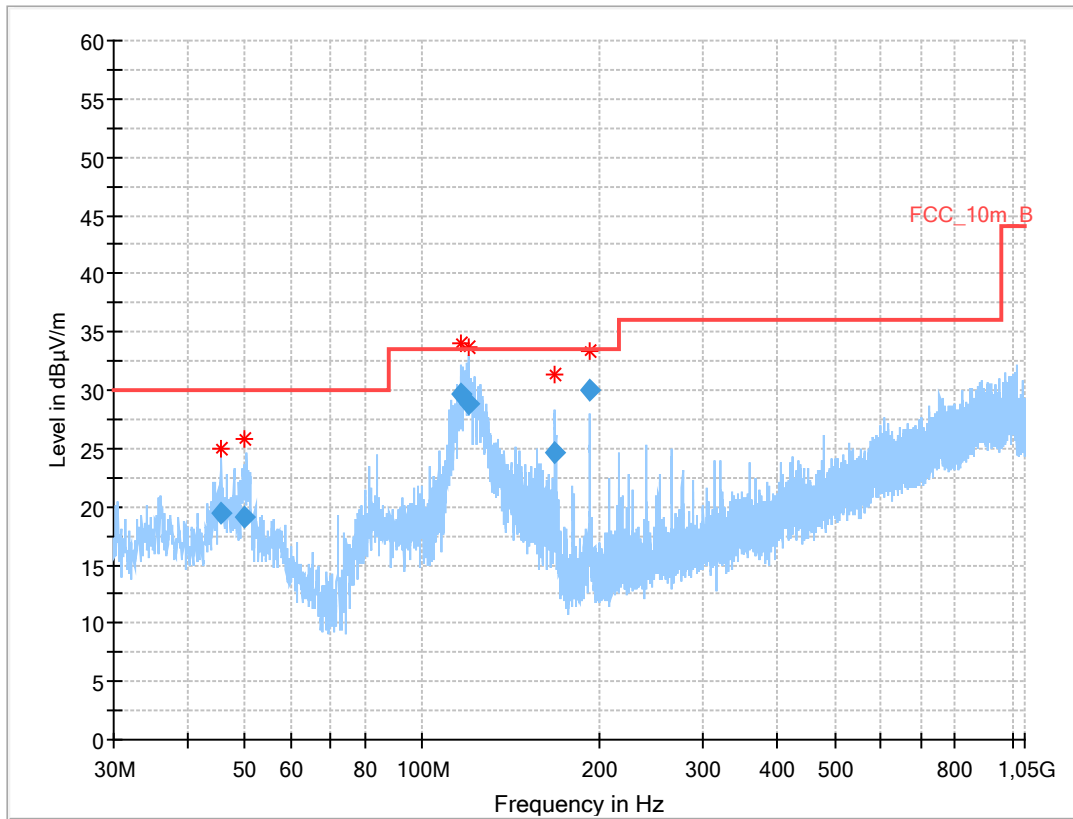

Results:

| Frequency (MHz) | QuasiPeak (dBµV/m) | Limit (dBµV/m) | Margin (dB) | Meas. Time (ms) | Bandwidth (kHz) | Height (cm) | Pol | Azimuth (deg) | Corr. (dB) |
|-----------------|--------------------|----------------|-------------|-----------------|-----------------|-------------|-----|---------------|------------|
| 45.698 | 19.45 | 30.0 | 10.6 | 1000 | 120.0 | 139.0 | V | 181 | 16 |
| 49.975 | 19.09 | 30.0 | 10.9 | 1000 | 120.0 | 113.0 | V | -37 | 16 |
| 116.471 | 29.69 | 33.5 | 3.8 | 1000 | 120.0 | 186.0 | V | 37 | 12 |
| 119.985 | 28.77 | 33.5 | 4.7 | 1000 | 120.0 | 145.0 | V | 37 | 11 |
| 168.004 | 24.71 | 33.5 | 8.8 | 1000 | 120.0 | 144.0 | V | -15 | 11 |
| 191.998 | 29.95 | 33.5 | 3.6 | 1000 | 120.0 | 105.0 | V | -36 | 12 |

12.12 Spurious emissions radiated 1 GHz to 40 GHz

Description:

Measurement of the radiated spurious emissions and cabinet radiations from 1 GHz to 40 GHz.

Measurement:

| Measurement parameter | |
|--------------------------|--|
| Detector: | Peak above 1 GHz / RMS |
| Sweep time: | Auto |
| Resolution bandwidth: | 1 MHz |
| Video bandwidth: | 3 MHz |
| Span: | 1 GHz to 40 GHz |
| Trace mode: | Max Hold / Average with 100 counts + 20 log (1 / X) for duty cycle lower than 100 % |
| Test setup: | See sub clause 7.2 – A, 7.3 – A, 7.3 – B |
| Measurement uncertainty: | See chapter 9 |

Limits:

| TX Spurious Emissions Radiated | | |
|--------------------------------|-------------------------|----------------------|
| §15.209 / RSS-247 | | |
| Frequency (MHz) | Field Strength (dBµV/m) | Measurement distance |
| Above 960 | 54.0 | 3 |
| §15.407 | | |
| Outside the restricted bands! | -27 dBm / MHz | |

Results: 20 MHz channel bandwidth

| TX Spurious Emissions Radiated [dBµV/m] / dBm | | | | | | | | |
|---|----------|----------------|---|----------|----------------|---|----------|----------------|
| U-NII-1 (5150 MHz to 5250 MHz) | | | | | | | | |
| Lowest channel | | | Middle channel | | | Highest channel | | |
| F [MHz] | Detector | Level [dBµV/m] | F [MHz] | Detector | Level [dBµV/m] | F [MHz] | Detector | Level [dBµV/m] |
| | Peak | | 15600 | Peak | 52.0 | | Peak | |
| | AVG | | | AVG | 42.2 | | AVG | |
| | Peak | | | Peak | | | Peak | |
| | AVG | | | AVG | | | AVG | |
| For emissions above 18 GHz please take look at the plots. | | | For emissions above 18 GHz please take look at the plots. | | | For emissions above 18 GHz please take look at the plots. | | |

| TX Spurious Emissions Radiated [dBµV/m] / dBm | | | | | | | | |
|---|----------|----------------|---|----------|----------------|---|----------|----------------|
| U-NII-2A (5250 MHz to 5350 MHz) | | | | | | | | |
| Lowest channel | | | Middle channel | | | Highest channel | | |
| F [MHz] | Detector | Level [dBµV/m] | F [MHz] | Detector | Level [dBµV/m] | F [MHz] | Detector | Level [dBµV/m] |
| | Peak | | | Peak | | 10638 | Peak | 59.1 |
| | AVG | | | AVG | | | AVG | 48.8 |
| | Peak | | | Peak | | 15958 | Peak | 53.7 |
| | AVG | | | AVG | | | AVG | 41.0 |
| For emissions above 18 GHz please take look at the plots. | | | For emissions above 18 GHz please take look at the plots. | | | For emissions above 18 GHz please take look at the plots. | | |

| TX Spurious Emissions Radiated [dBµV/m] / dBm | | | | | | | | |
|---|----------|----------------|---|----------|----------------|---|----------|----------------|
| U-NII-2C (5470 MHz to 5725 MHz) | | | | | | | | |
| Lowest channel | | | Middle channel | | | Highest channel | | |
| F [MHz] | Detector | Level [dBµV/m] | F [MHz] | Detector | Level [dBµV/m] | F [MHz] | Detector | Level [dBµV/m] |
| | Peak | | | Peak | | | Peak | |
| | AVG | | | AVG | | | AVG | |
| | Peak | | | Peak | | | Peak | |
| | AVG | | | AVG | | | AVG | |
| For emissions above 18 GHz please take look at the plots. | | | For emissions above 18 GHz please take look at the plots. | | | For emissions above 18 GHz please take look at the plots. | | |

| TX Spurious Emissions Radiated [dBµV/m] / dBm | | | | | | | | |
|---|----------|----------------|---|----------|----------------|---|----------|----------------|
| U-NII-3 (5725 MHz to 5850 MHz) | | | | | | | | |
| Lowest channel | | | Middle channel | | | Highest channel | | |
| F [MHz] | Detector | Level [dBµV/m] | F [MHz] | Detector | Level [dBµV/m] | F [MHz] | Detector | Level [dBµV/m] |
| | Peak | | | Peak | | | Peak | |
| | AVG | | | AVG | | | AVG | |
| | Peak | | | Peak | | | Peak | |
| | AVG | | | AVG | | | AVG | |
| For emissions above 18 GHz please take look at the plots. | | | For emissions above 18 GHz please take look at the plots. | | | For emissions above 18 GHz please take look at the plots. | | |

Results: 40 MHz channel bandwidth

| TX Spurious Emissions Radiated [dBµV/m] / dBm | | | | | | | | |
|---|----------|----------------|---|----------|----------------|---|----------|----------------|
| U-NII-1 (5150 MHz to 5250 MHz) | | | | | | | | |
| Lowest channel | | | Middle channel | | | Highest channel | | |
| F [MHz] | Detector | Level [dBµV/m] | F [MHz] | Detector | Level [dBµV/m] | F [MHz] | Detector | Level [dBµV/m] |
| | Peak | | | Peak | | | Peak | |
| | AVG | | | AVG | | | AVG | |
| | Peak | | | Peak | | | Peak | |
| | AVG | | | AVG | | | AVG | |
| For emissions above 18 GHz please take look at the plots. | | | For emissions above 18 GHz please take look at the plots. | | | For emissions above 18 GHz please take look at the plots. | | |

| TX Spurious Emissions Radiated [dBµV/m] / dBm | | | | | | | | |
|---|----------|----------------|---|----------|----------------|---|----------|----------------|
| U-NII-2A (5250 MHz to 5350 MHz) | | | | | | | | |
| Lowest channel | | | Middle channel | | | Highest channel | | |
| F [MHz] | Detector | Level [dBµV/m] | F [MHz] | Detector | Level [dBµV/m] | F [MHz] | Detector | Level [dBµV/m] |
| | Peak | | | Peak | | | Peak | |
| | AVG | | | AVG | | | AVG | |
| | Peak | | | Peak | | | Peak | |
| | AVG | | | AVG | | | AVG | |
| For emissions above 18 GHz please take look at the plots. | | | For emissions above 18 GHz please take look at the plots. | | | For emissions above 18 GHz please take look at the plots. | | |

| TX Spurious Emissions Radiated [dBµV/m] / dBm | | | | | | | | |
|---|----------|----------------|---|----------|----------------|---|----------|----------------|
| U-NII-2C (5470 MHz to 5725 MHz) | | | | | | | | |
| Lowest channel | | | Middle channel | | | Highest channel | | |
| F [MHz] | Detector | Level [dBµV/m] | F [MHz] | Detector | Level [dBµV/m] | F [MHz] | Detector | Level [dBµV/m] |
| | Peak | | | Peak | | | Peak | |
| | AVG | | | AVG | | | AVG | |
| | Peak | | | Peak | | | Peak | |
| | AVG | | | AVG | | | AVG | |
| For emissions above 18 GHz please take look at the plots. | | | For emissions above 18 GHz please take look at the plots. | | | For emissions above 18 GHz please take look at the plots. | | |

| TX Spurious Emissions Radiated [dBµV/m] / dBm | | | | | | | | |
|---|----------|----------------|---|----------|----------------|---|----------|----------------|
| U-NII-3 (5725 MHz to 5850 MHz) | | | | | | | | |
| Lowest channel | | | Middle channel | | | Highest channel | | |
| F [MHz] | Detector | Level [dBµV/m] | F [MHz] | Detector | Level [dBµV/m] | F [MHz] | Detector | Level [dBµV/m] |
| | Peak | | | Peak | | | Peak | |
| | AVG | | | AVG | | | AVG | |
| | Peak | | | Peak | | | Peak | |
| | AVG | | | AVG | | | AVG | |
| For emissions above 18 GHz please take look at the plots. | | | For emissions above 18 GHz please take look at the plots. | | | For emissions above 18 GHz please take look at the plots. | | |

Plots: 20 MHz channel bandwidth

Plot 1: 1 GHz to 18 GHz; vertical & horizontal polarization; U-NII-1; lowest channel

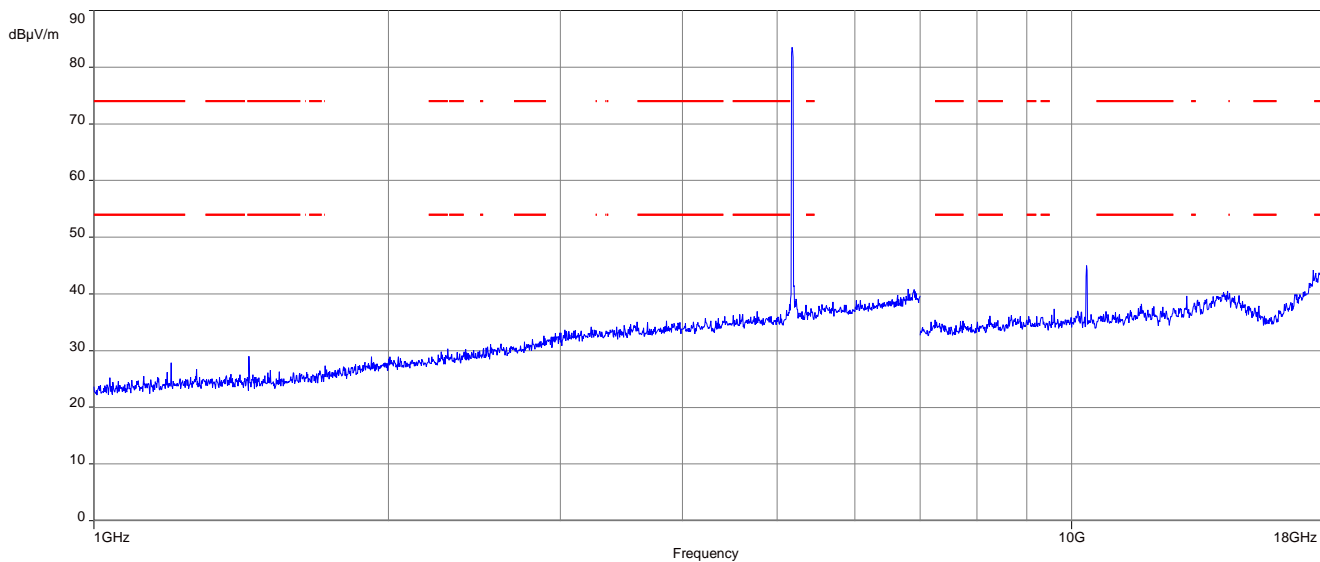

Plot 2: 1 GHz to 18 GHz; vertical & horizontal polarization; U-NII-1; middle channel

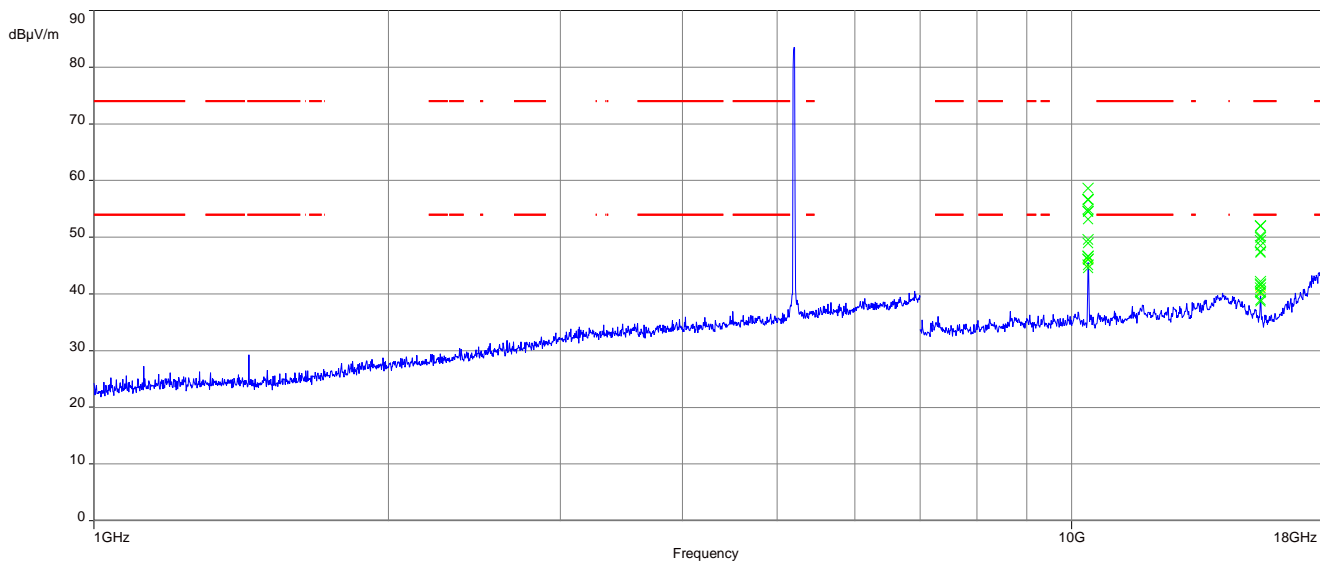

Plot 3: 1 GHz to 18 GHz; vertical & horizontal polarization; U-NII-1; highest channel

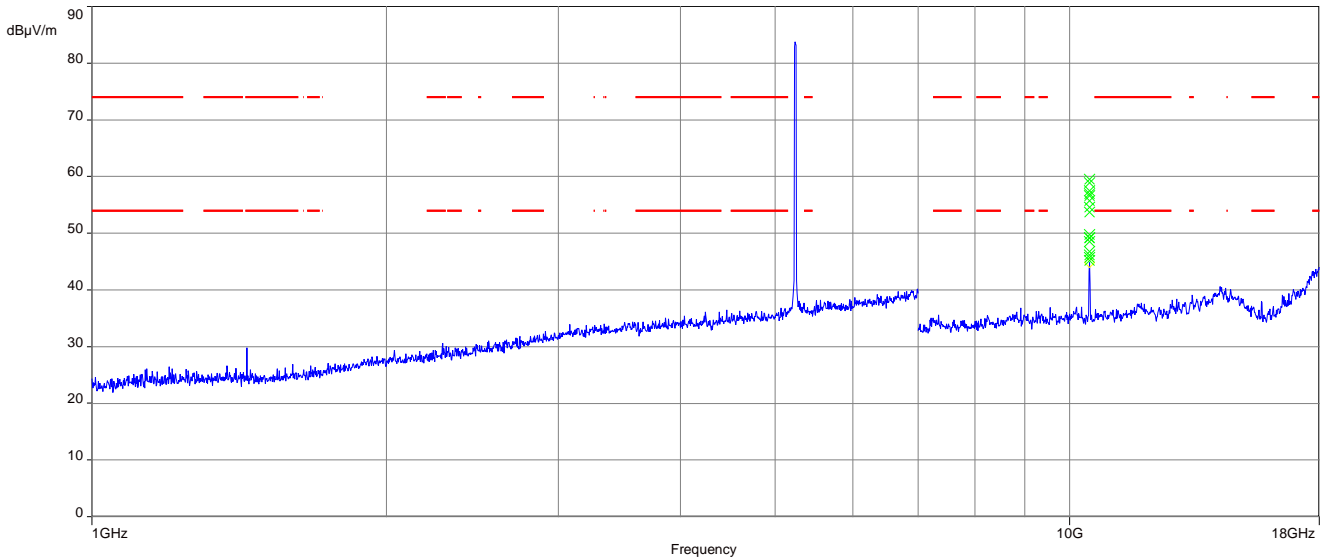

Plot 4: 18 GHz to 40 GHz; vertical & horizontal polarization; U-NII-1; all channels

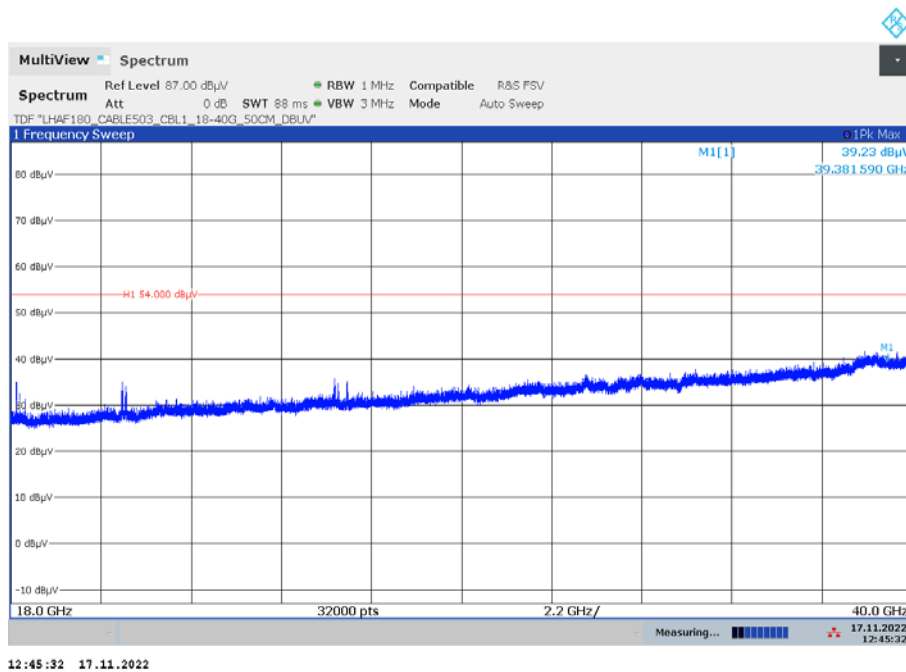

Plot 5: 1 GHz to 18 GHz; vertical & horizontal polarization; U-NII-2A; lowest channel

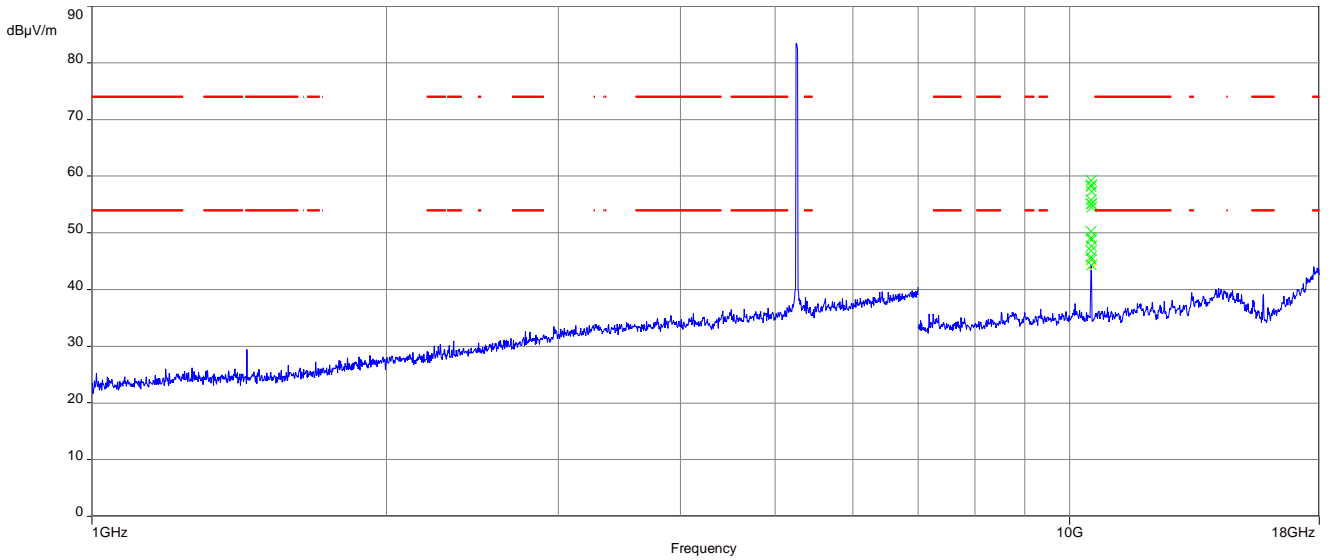

Plot 6: 1 GHz to 18 GHz; vertical & horizontal polarization; U-NII-2A; middle channel

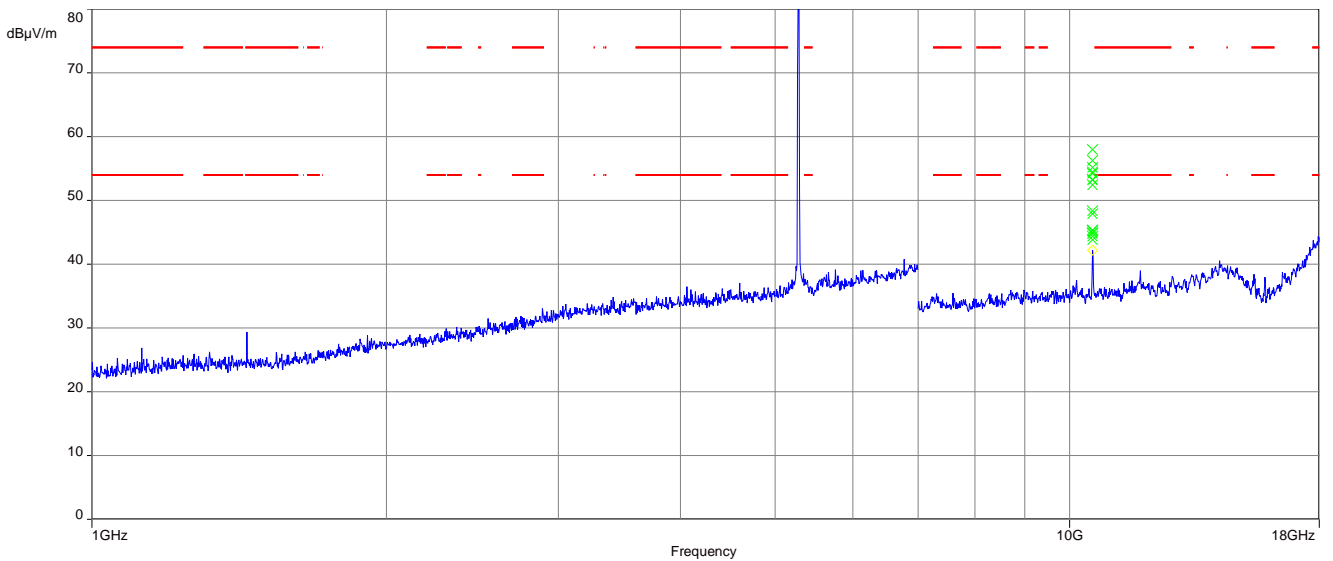

Plot 7: 1 GHz to 18 GHz; vertical & horizontal polarization; U-NII-2A; highest channel

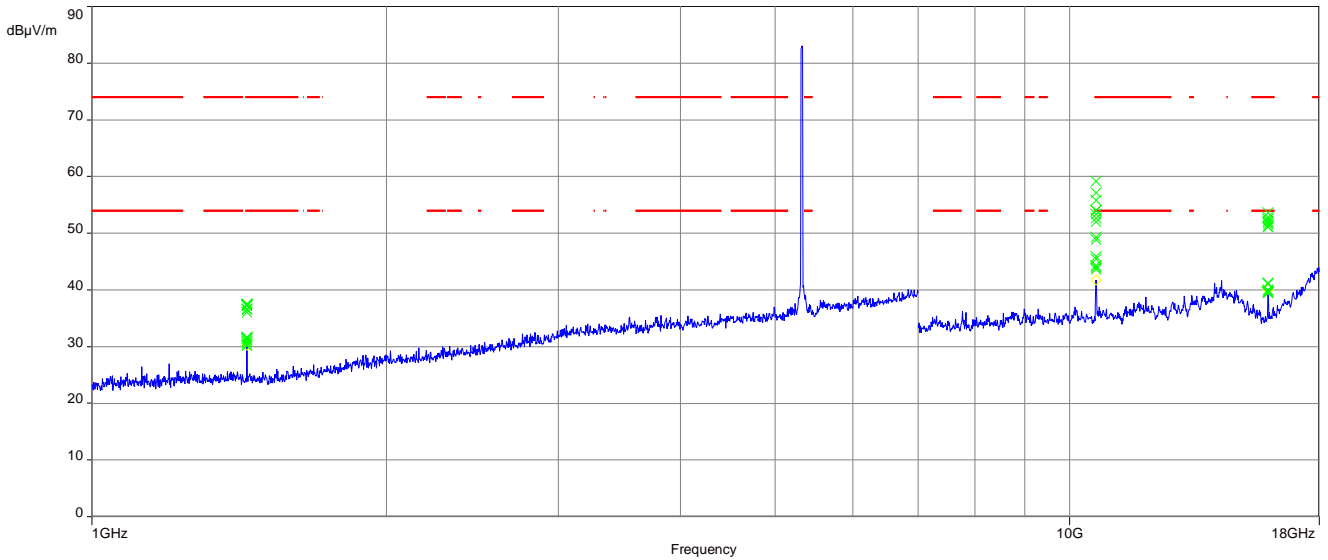

Plot 8: 18 GHz to 40 GHz; vertical & horizontal polarization; U-NII-2A; all channels

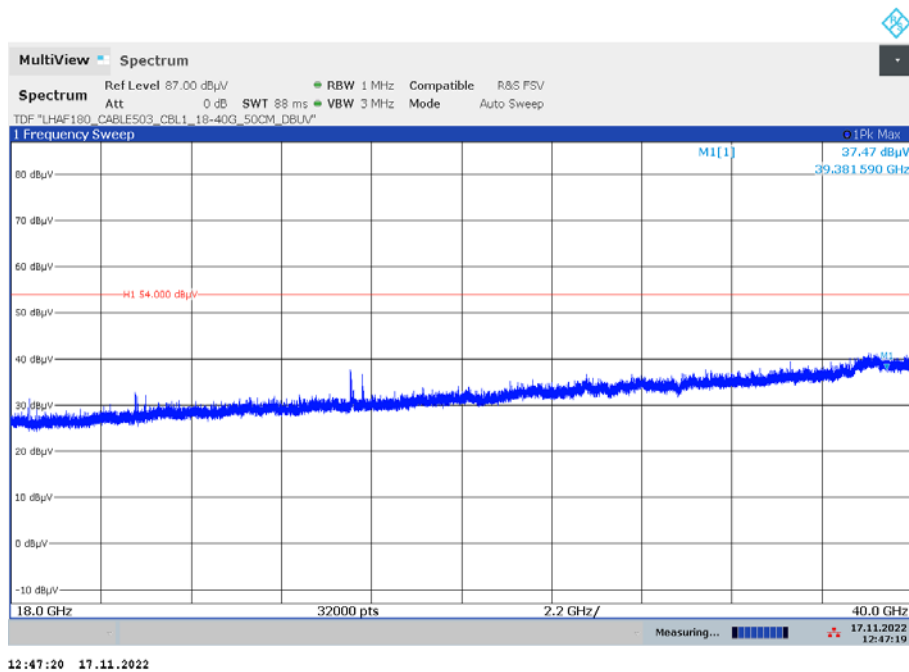

Plot 9: 1 GHz to 18 GHz; vertical & horizontal polarization; U-NII-2C; lowest channel

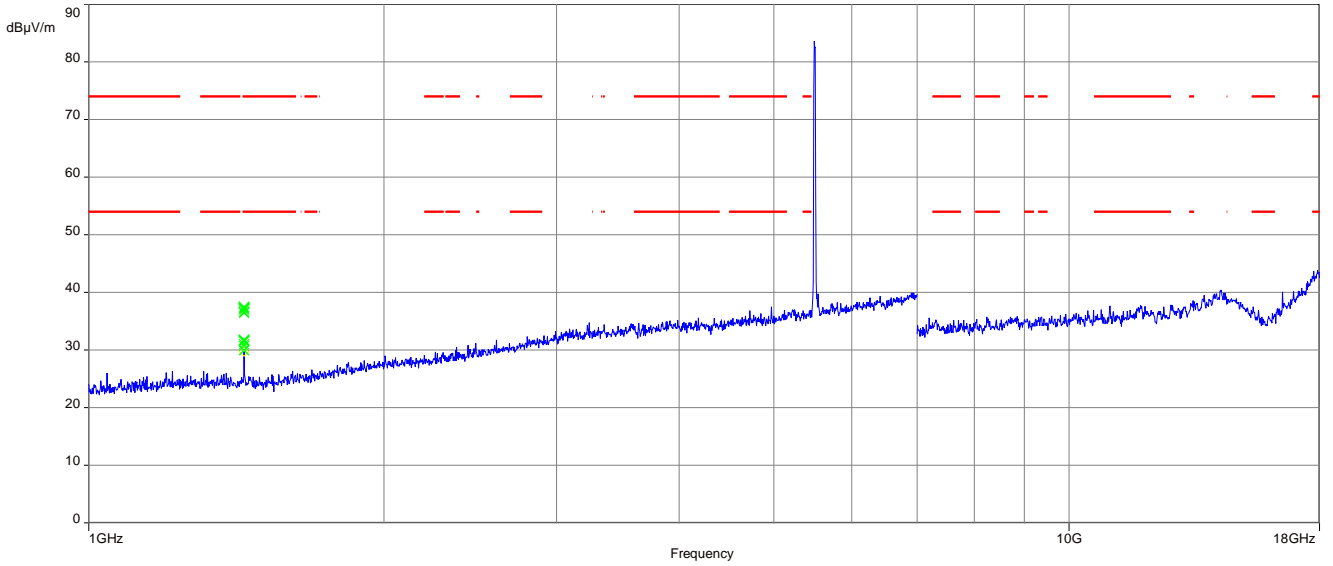

Plot 10: 1 GHz to 18 GHz; vertical & horizontal polarization; U-NII-2C; middle channel

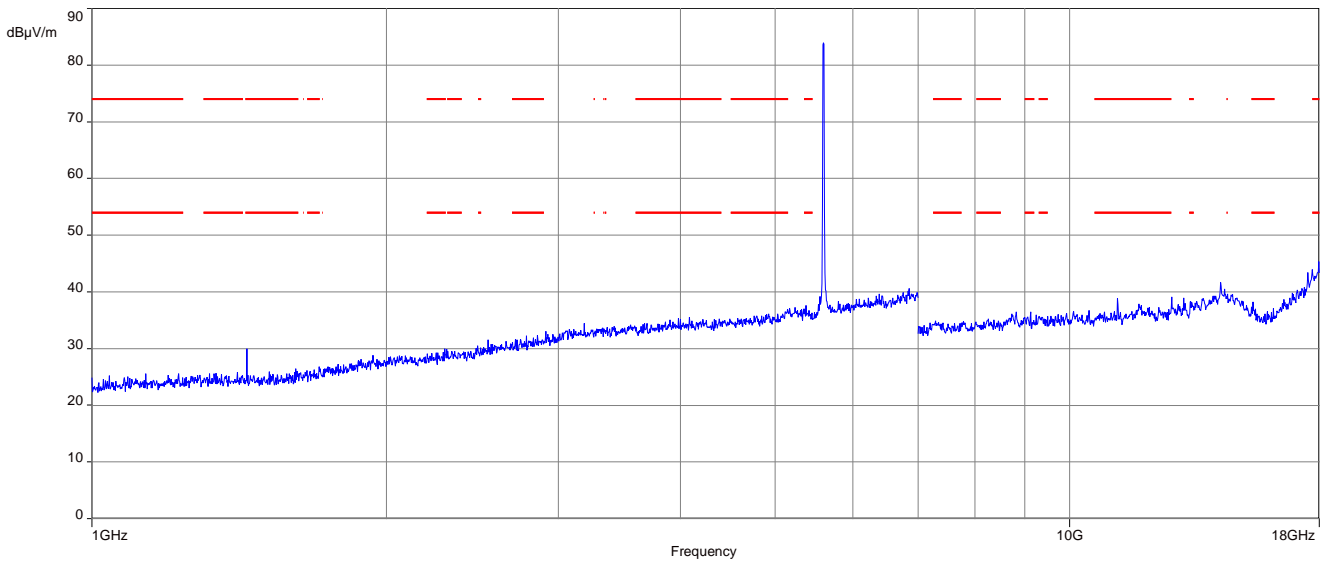

Plot 11: 1 GHz to 18 GHz; vertical & horizontal polarization; U-NII-2C; highest channel

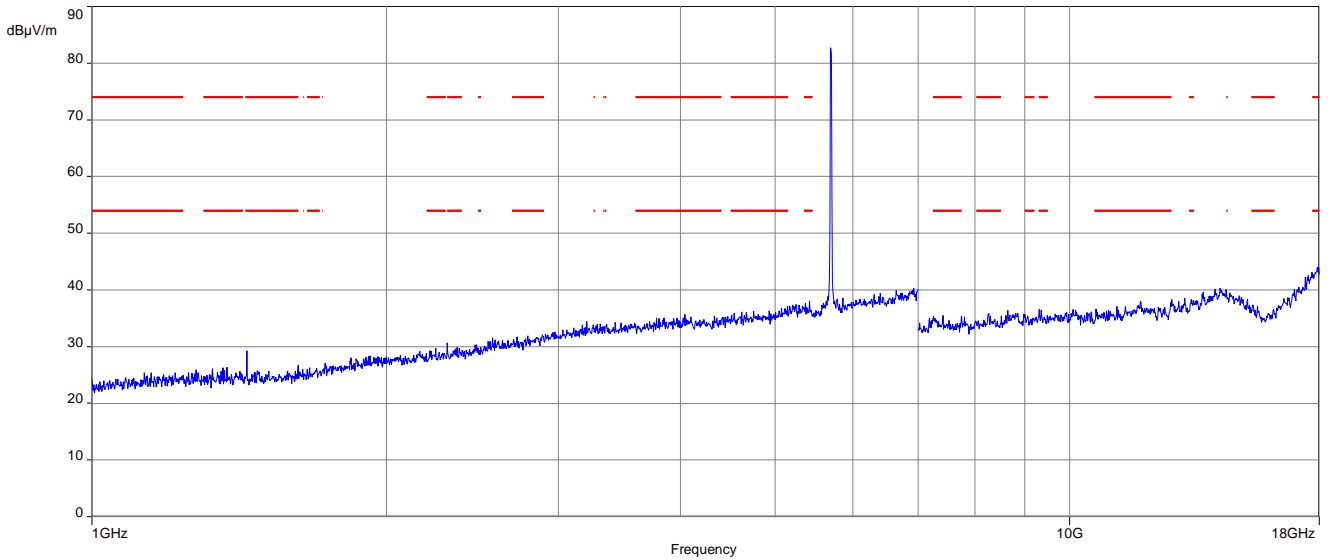

Plot 12: 18 GHz to 40 GHz; vertical & horizontal polarization; U-NII-2C; all channels

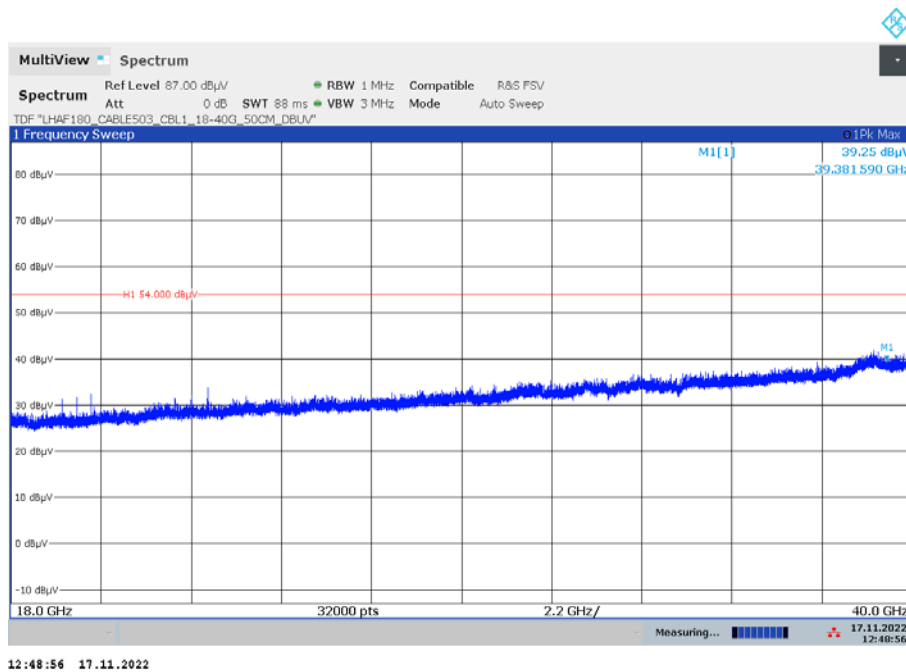

Plot 13: 1 GHz to 18 GHz; vertical & horizontal polarization; U-NII-3; lowest channel

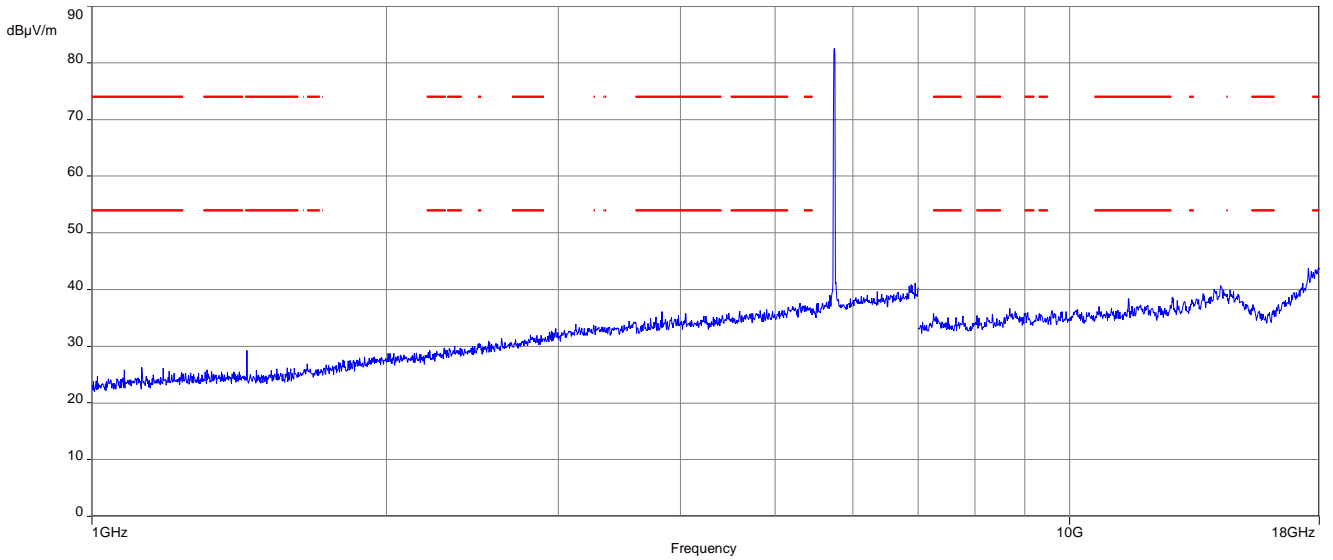

Plot 14: 1 GHz to 18 GHz; vertical & horizontal polarization; U-NII-3; middle channel

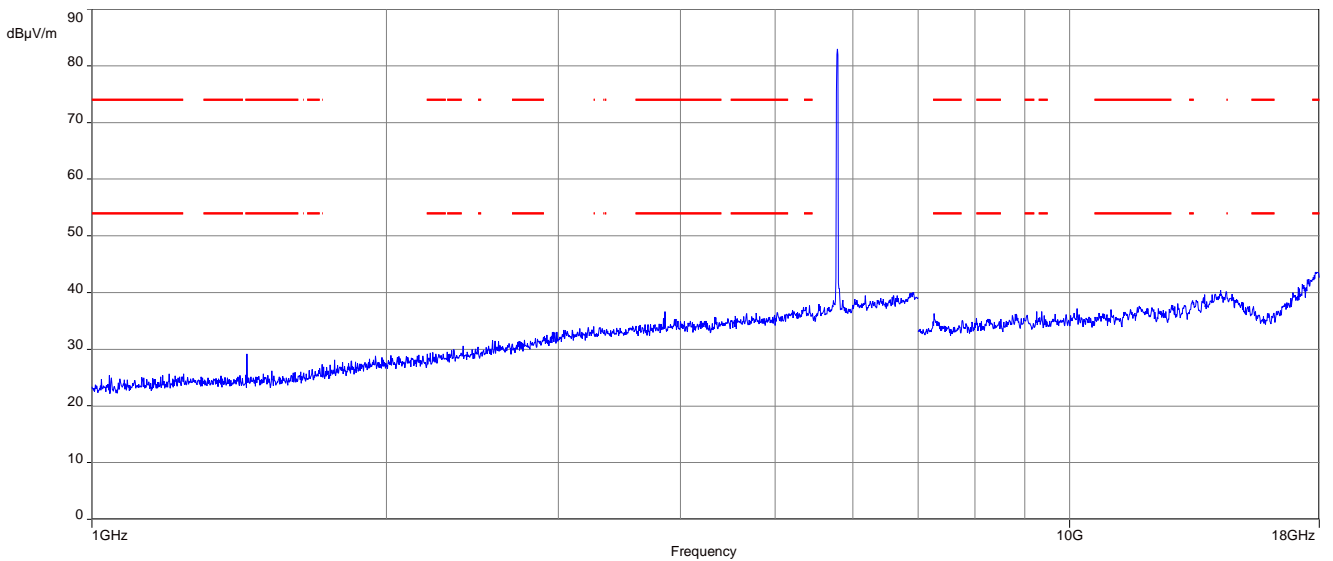

Plot 15: 1 GHz to 18 GHz; vertical & horizontal polarization; U-NII-3; highest channel

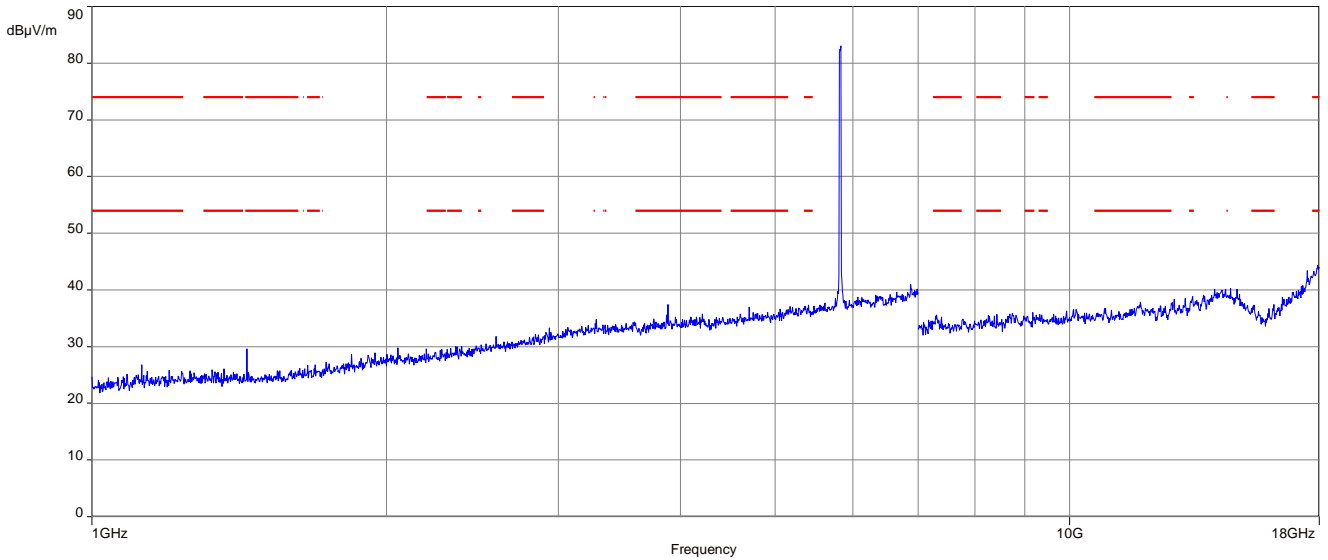

Plot 16: 18 GHz to 40 GHz; vertical & horizontal polarization; U-NII-3; all channels

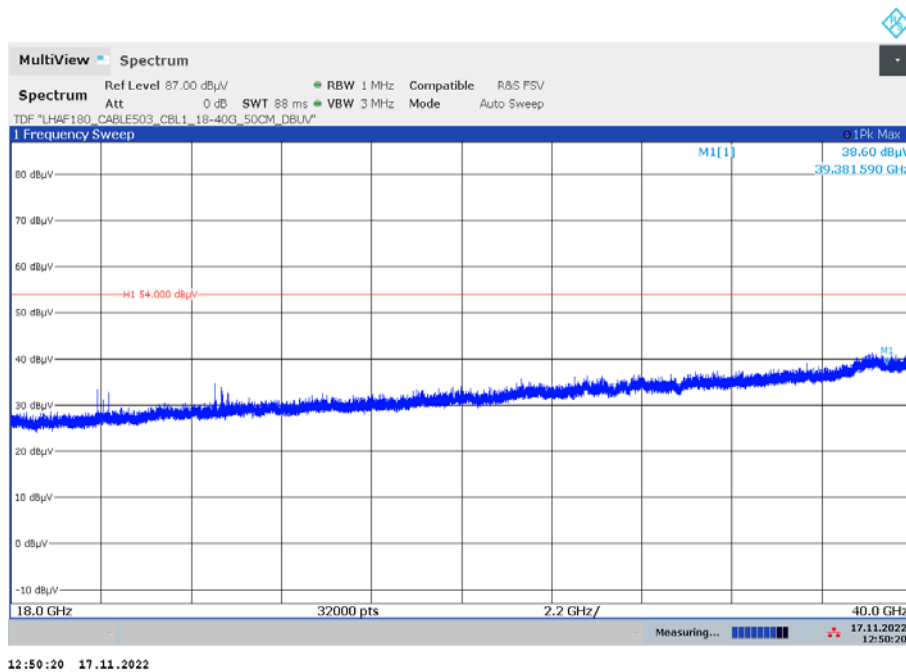

Plots: 40 MHz channel bandwidth

Plot 1: 1 GHz to 18 GHz; vertical & horizontal polarization; U-NII-1; lowest channel

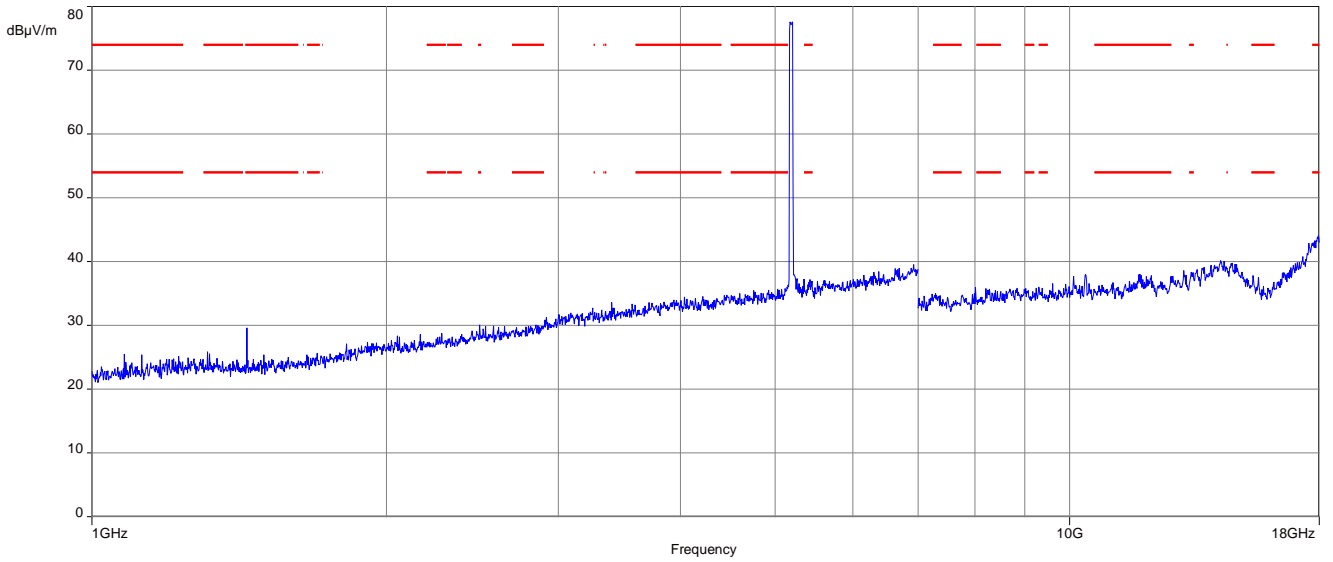

Plot 2: 1 GHz to 18 GHz; vertical & horizontal polarization; U-NII-1; highest channel

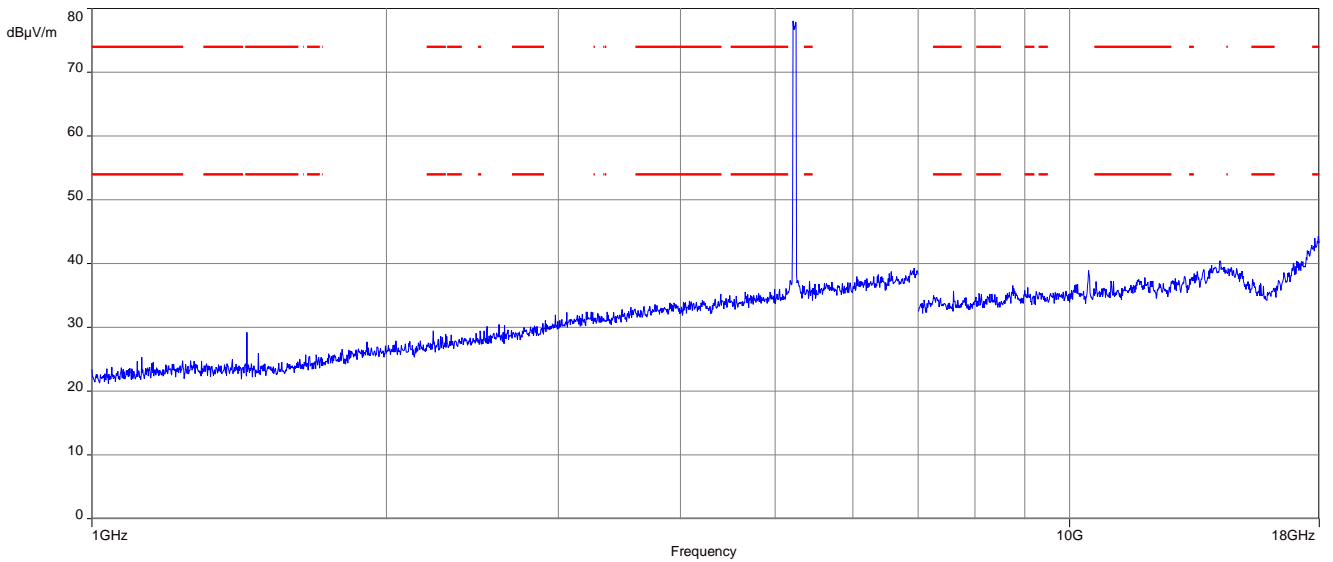

Plot 3: 18 GHz to 40 GHz; vertical & horizontal polarization; U-NII-1; all channels

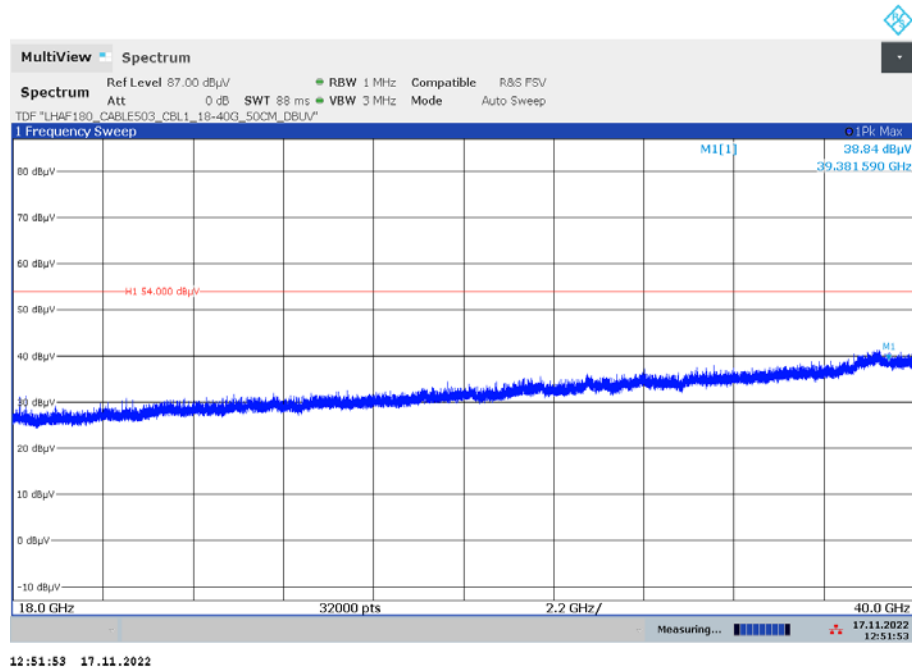

Plot 4: 1 GHz to 18 GHz; vertical & horizontal polarization; U-NII-2A; lowest channel

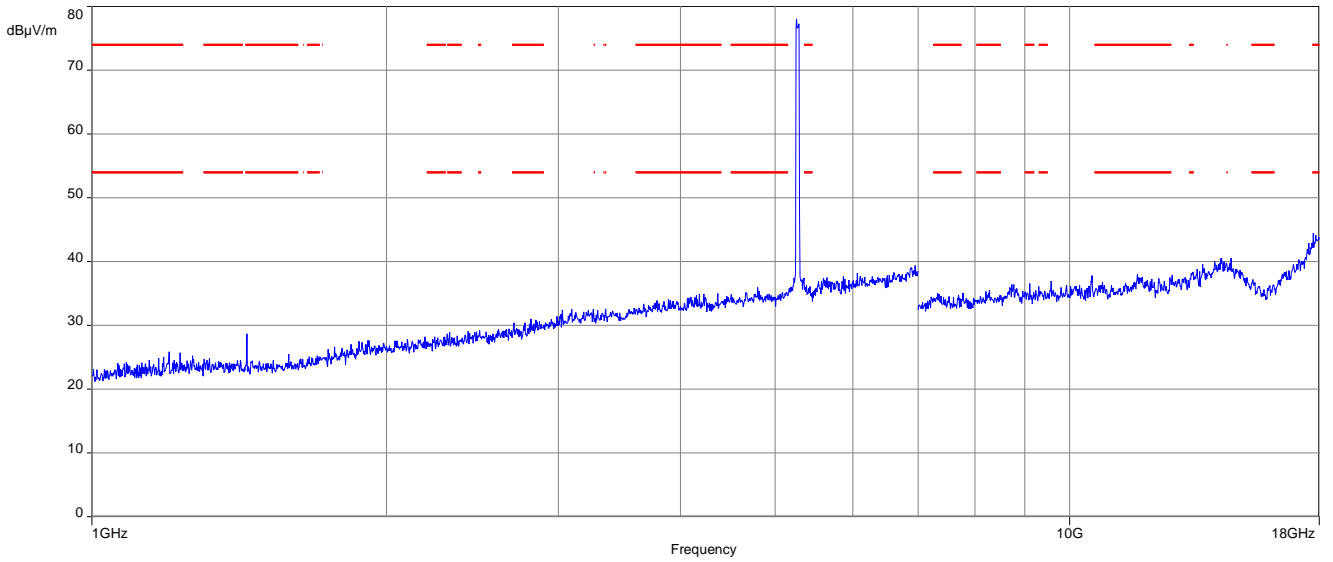

Plot 5: 1 GHz to 18 GHz; vertical & horizontal polarization; U-NII-2A; highest channel

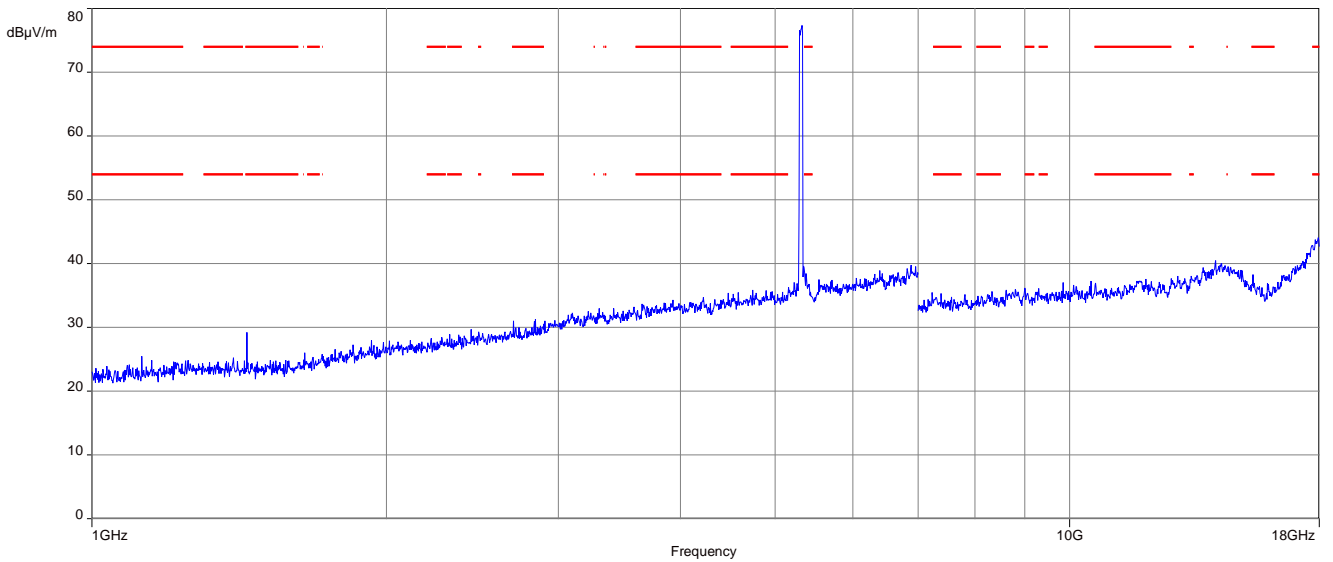

Plot 6: 18 GHz to 40 GHz; vertical & horizontal polarization; U-NII-2A; all channels

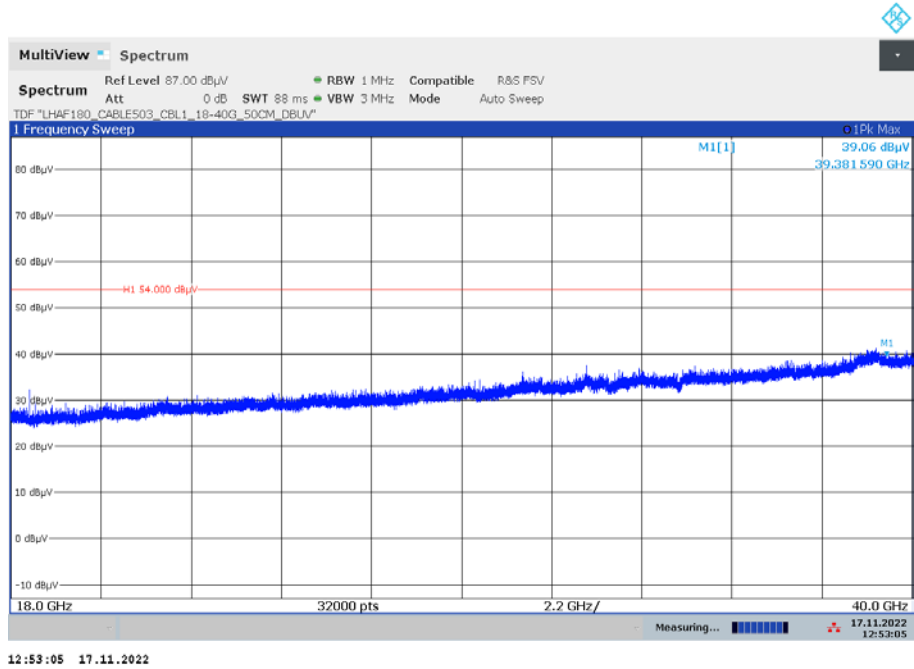

Plot 7: 1 GHz to 18 GHz; vertical & horizontal polarization; U-NII-2C; lowest channel

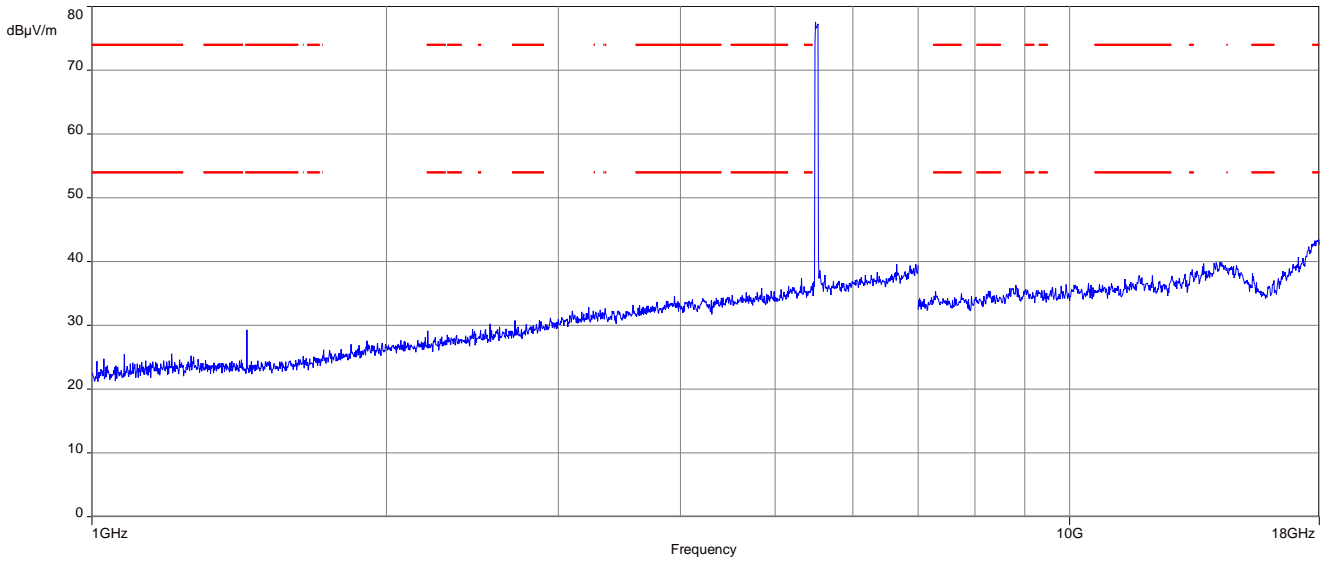

Plot 8: 1 GHz to 18 GHz; vertical & horizontal polarization; U-NII-2C; middle channel

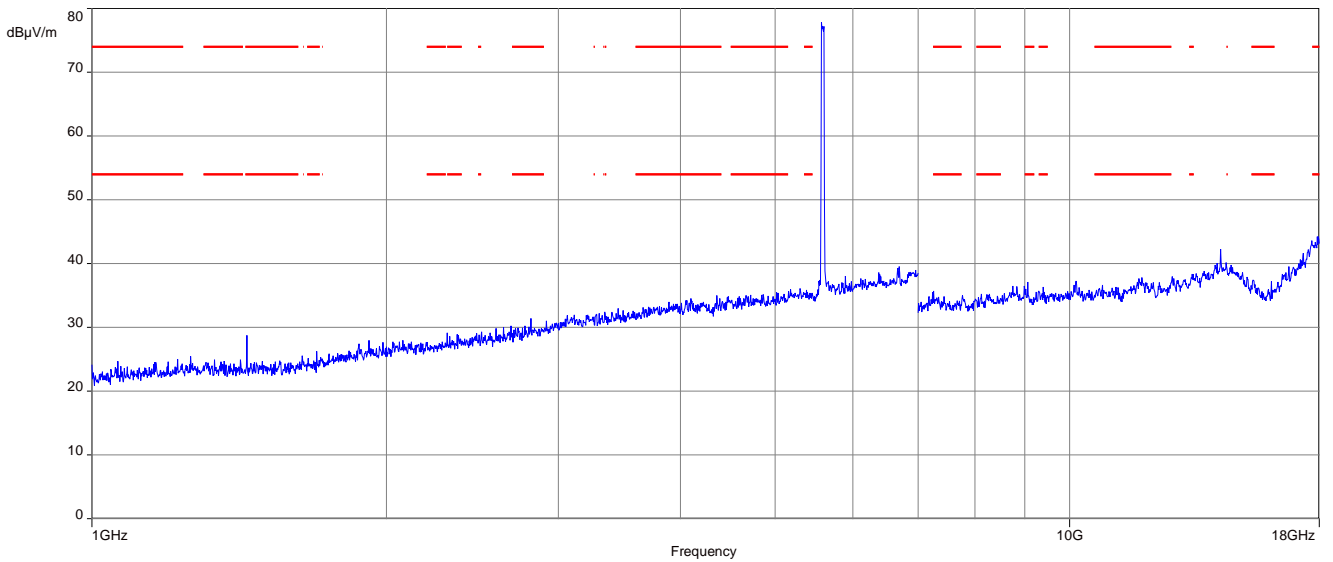

Plot 9: 1 GHz to 18 GHz; vertical & horizontal polarization; U-NII-2C; highest channel

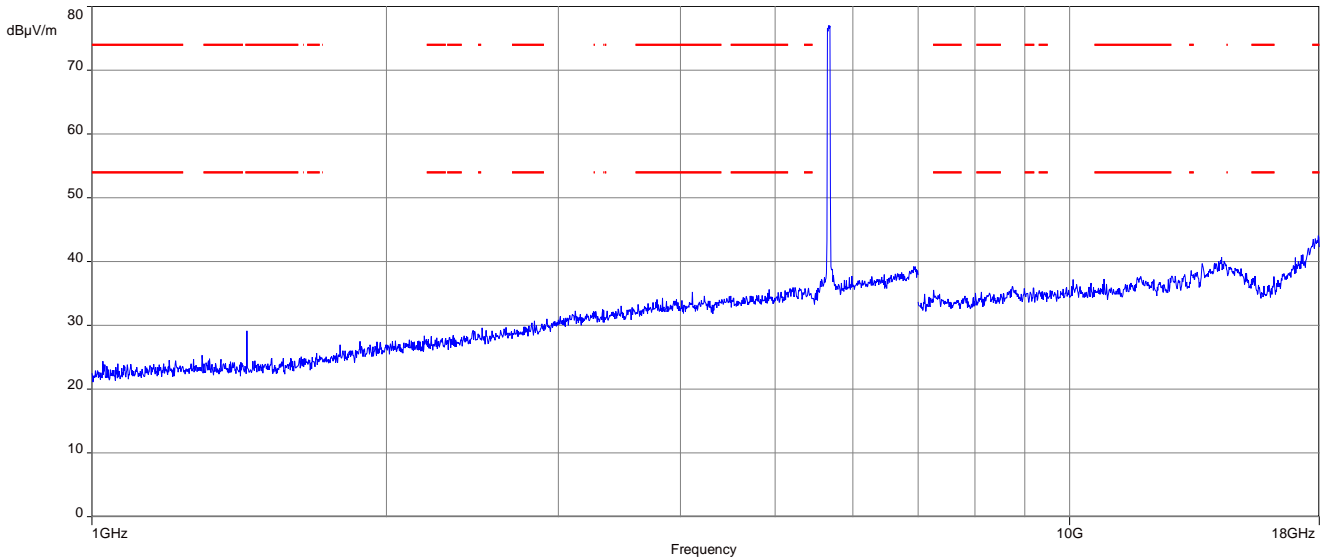

Plot 10: 18 GHz to 40 GHz; vertical & horizontal polarization; U-NII-2C; all channels

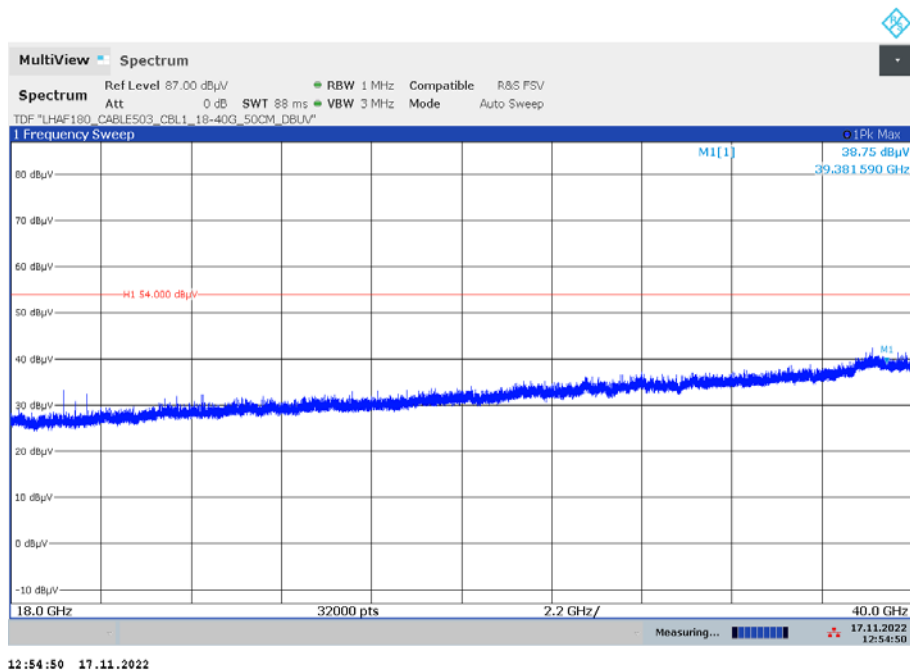

Plot 11: 1 GHz to 18 GHz; vertical & horizontal polarization; U-NII-3; lowest channel

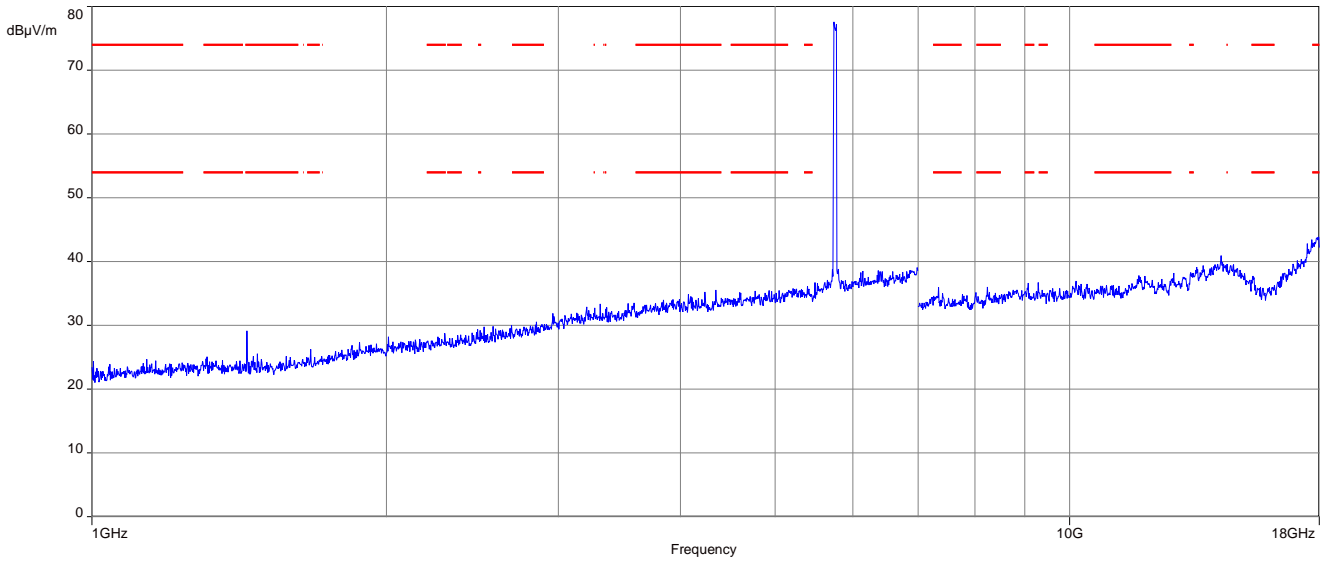

Plot 12: 1 GHz to 18 GHz; vertical & horizontal polarization; U-NII-3; highest channel

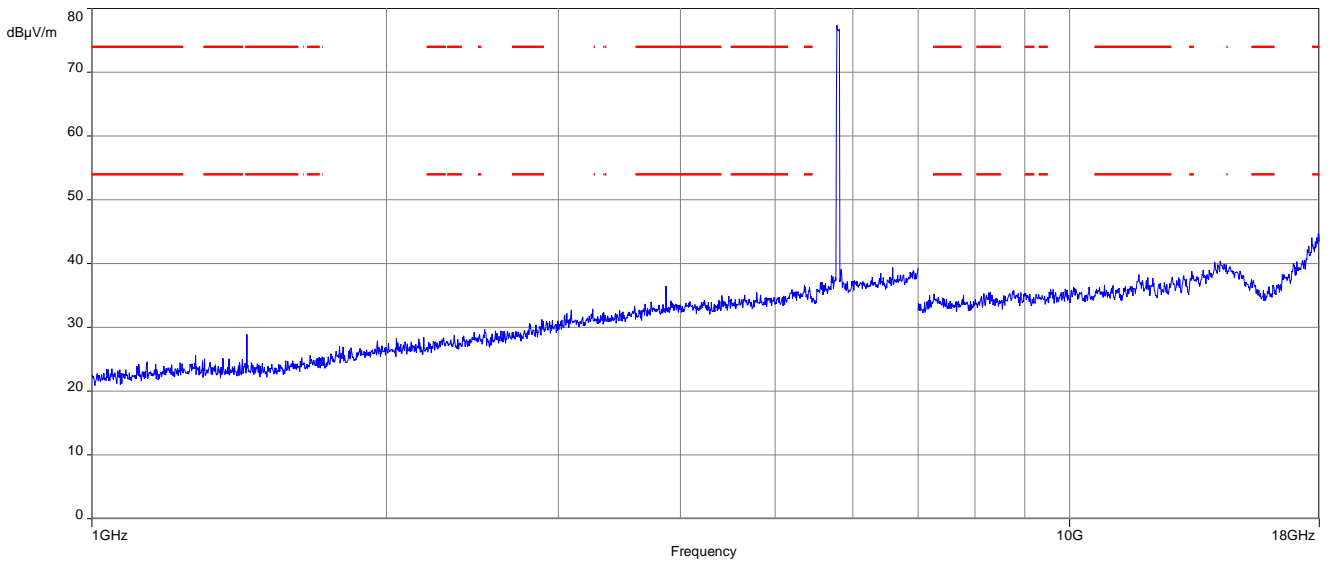

Plot 13: 18 GHz to 40 GHz; vertical & horizontal polarization; U-NII-3; all channels

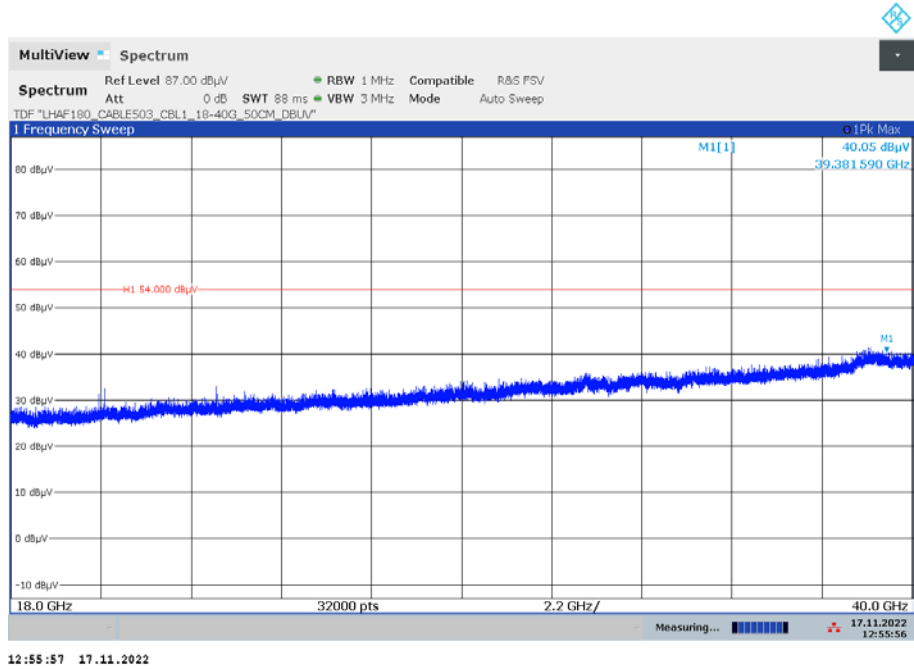

12.13 Spurious emissions conducted < 30 MHz

Description:

Measurement of the conducted spurious emissions in transmit mode below 30 MHz. The EUT is set to middle channel. If critical peaks are found the lowest channel and the highest channel will be measured too. Both power lines, phase and neutral line, are measured. Found peaks are re-measured with average and quasi peak detection to show compliance to the limits.

Measurement:

| Measurement parameter | |
|--------------------------|-----------------------------|
| Detector: | Peak - Quasi Peak / Average |
| Sweep time: | Auto |
| Video bandwidth: | 9 kHz |
| Resolution bandwidth: | 100 kHz |
| Span: | 150 kHz to 30 MHz |
| Trace mode: | Max Hold |
| Test setup: | See sub clause 7.2 – B |
| Measurement uncertainty: | See chapter 9 |

Limits:

| Spurious Emissions Conducted < 30 MHz | | |
|---------------------------------------|---------------------|------------------|
| Frequency (MHz) | Quasi-Peak (dBµV/m) | Average (dBµV/m) |
| 0.15 – 0.5 | 66 to 56* | 56 to 46* |
| 0.5 – 5 | 56 | 46 |
| 5 – 30.0 | 60 | 50 |

*Decreases with the logarithm of the frequency

Results:

| Spurious Emissions Conducted < 30 MHz [dBµV/m] | | |
|---|----------|----------------|
| F [MHz] | Detector | Level [dBµV/m] |
| All detected emissions are more than 20 dB below the limit. | | |
| | | |

Plots: Move 5000

Plot 1: 150 kHz to 30 MHz, phase line

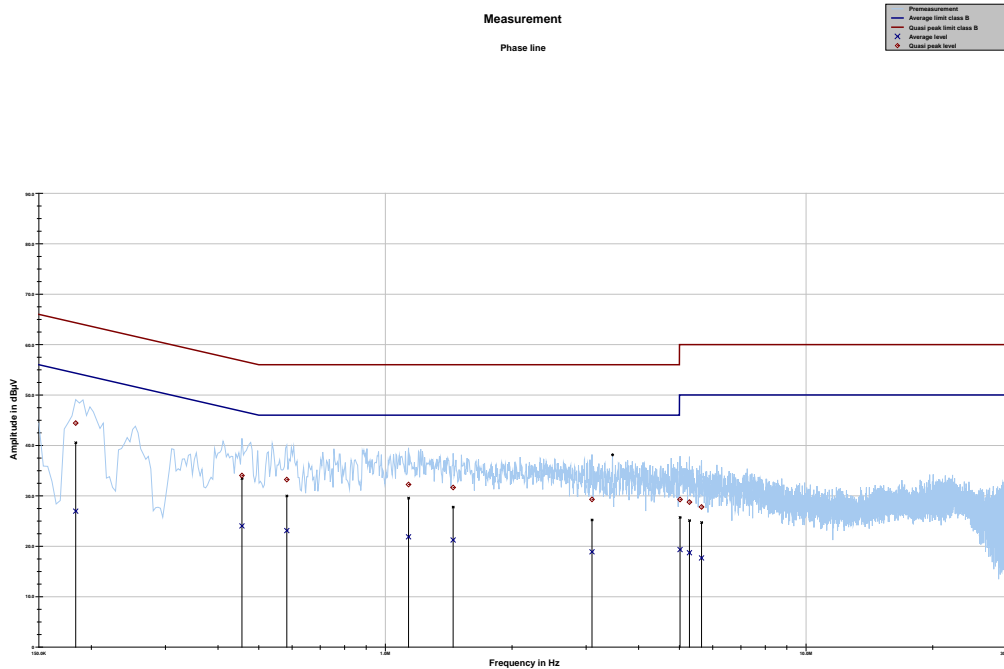

Project ID: 4835_02_03

| Frequency MHz | Quasi peak level dBµV | Margin quasi peak dB | Limit QP dBµV | Average level dBµV | Margin average dB | Limit AV dBµV |
|------------------|-----------------------------|----------------------------|------------------|--------------------------|-------------------------|------------------|
| 0.183581 | 44.43 | 19.90 | 64.322 | 26.97 | 28.07 | 55.041 |
| 0.455962 | 34.04 | 22.72 | 56.766 | 24.03 | 23.23 | 47.258 |
| 0.582825 | 33.22 | 22.78 | 56.000 | 23.11 | 22.89 | 46.000 |
| 1.135050 | 32.24 | 23.76 | 56.000 | 21.87 | 24.13 | 46.000 |
| 1.448475 | 31.66 | 24.34 | 56.000 | 21.24 | 24.76 | 46.000 |
| 3.097688 | 29.28 | 26.72 | 56.000 | 18.90 | 27.10 | 46.000 |
| 5.015550 | 29.28 | 30.72 | 60.000 | 19.34 | 30.66 | 50.000 |
| 5.280469 | 28.76 | 31.24 | 60.000 | 18.71 | 31.29 | 50.000 |
| 5.642400 | 27.80 | 32.20 | 60.000 | 17.68 | 32.32 | 50.000 |

Plot 2: 150 kHz to 30 MHz, neutral line

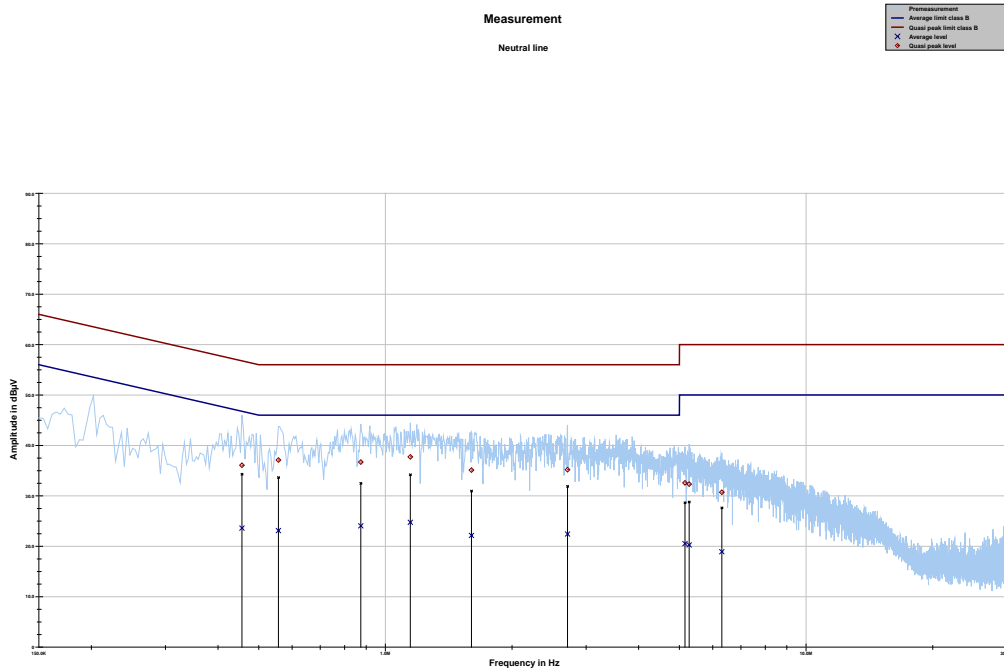

Project ID: 4835_02_03

| Frequency MHz | Quasi peak level dBµV | Margin quasi peak dB | Limit QP dBµV | Average level dBµV | Margin Average dB | Limit AV dBµV |
|------------------|-----------------------------|----------------------------|------------------|--------------------------|-------------------------|------------------|
| 0.455962 | 36.07 | 20.70 | 56.766 | 23.61 | 23.65 | 47.258 |
| 0.556706 | 37.10 | 18.90 | 56.000 | 23.10 | 22.90 | 46.000 |
| 0.873862 | 36.70 | 19.30 | 56.000 | 24.05 | 21.95 | 46.000 |
| 1.146244 | 37.72 | 18.28 | 56.000 | 24.75 | 21.25 | 46.000 |
| 1.601456 | 35.11 | 20.89 | 56.000 | 22.14 | 23.86 | 46.000 |
| 2.709637 | 35.18 | 20.82 | 56.000 | 22.42 | 23.58 | 46.000 |
| 5.153606 | 32.58 | 27.42 | 60.000 | 20.52 | 29.48 | 50.000 |
| 5.273006 | 32.32 | 27.68 | 60.000 | 20.26 | 29.74 | 50.000 |
| 6.306563 | 30.71 | 29.29 | 60.000 | 18.92 | 31.08 | 50.000 |

13 Observations

No observations except those reported with the single test cases have been made.

14 Glossary

| | |
|------------------|--|
| EUT | Equipment under test |
| DUT | Device under test |
| UUT | Unit under test |
| FCC | Federal Communications Commission |
| FCC ID | Company Identifier at FCC |
| IC | Industry Canada |
| PMN | Product marketing name |
| HMN | Host marketing name |
| HVIN | Hardware version identification number |
| FVIN | Firmware version identification number |
| EMC | Electromagnetic Compatibility |
| HW | Hardware |
| SW | Software |
| Inv. No. | Inventory number |
| S/N or SN | Serial number |
| C | Compliant |
| NC | Not compliant |
| NA | Not applicable |
| NP | Not performed |
| PP | Positive peak |
| QP | Quasi peak |
| AVG | Average |
| OC | Operating channel |
| OCW | Operating channel bandwidth |
| OBW | Occupied bandwidth |
| OOB | Out of band |
| DFS | Dynamic frequency selection |
| CAC | Channel availability check |
| OP | Occupancy period |
| NOP | Non occupancy period |
| DC | Duty cycle |
| CW | Clean wave |
| MC | Modulated carrier |
| WLAN | Wireless local area network |
| RLAN | Radio local area network |
| DSSS | Dynamic sequence spread spectrum |
| OFDM | Orthogonal frequency division multiplexing |
| FHSS | Frequency hopping spread spectrum |

15 Document history

| Version | Applied changes | Date of release |
|---------|---------------------------|-----------------|
| -/- | Initial release | 2022-12-08 |
| A | Move/3500 results removed | 2023-01-11 |

16 Accreditation Certificate – D-PL-12076-01-04

| first page | last page |
|---|--|
|  <p>DAkKS Deutsche Akkreditierungsstelle</p> <p>Deutsche Akkreditierungsstelle GmbH</p> <p>Entrusted according to Section 8 subsection 1 AkkStelleG in connection with Section 1 subsection 1 AkkStelleGBV Signatory to the Multilateral Agreements of EA, ILAC and IAF for Mutual Recognition</p> <p>Accreditation </p> <p>The Deutsche Akkreditierungsstelle GmbH attests that the testing laboratory CTC advanced GmbH Untertürkheimer Straße 6-10, 66117 Saarbrücken is competent under the terms of DIN EN ISO/IEC 17025:2018 to carry out tests in the following fields: Telecommunication (TC) and Electromagnetic Compatibility (EMC) for Canadian Standards</p> <p>The accreditation certificate shall only apply in connection with the notice of accreditation of 09.06.2020 with the accreditation number D-PL-12076-01. It comprises the cover sheet, the reverse side of the cover sheet and the following annex with a total of 07 pages.</p> <p>Registration number of the certificate: D-PL-12076-01-04</p> <p>Frankfurt am Main, 09.06.2020</p> <p>by order  Head of Division</p> <p><small>The certificate together with its annex reflects the status at the time of the date of issue. The current status of the scope of accreditation can be found in the database of accredited bodies of Deutsche Akkreditierungsstelle GmbH. https://www.dakks.de/en/content/accredited-bodies-dakks See notes internal.</small></p> |  <p>Deutsche Akkreditierungsstelle GmbH</p> <p>Office Berlin Spittelmarkt 10 10117 Berlin</p> <p>Office Frankfurt am Main Europa-Allee 52 60327 Frankfurt am Main</p> <p>Office Braunschweig Bundesallee 100 38116 Braunschweig</p> <p>The publication of extracts of the accreditation certificate is subject to the prior written approval by Deutsche Akkreditierungsstelle GmbH (DAKKS). Exempted is the unchanged form of separate disseminations of the cover sheet by the conformity assessment body mentioned overleaf.</p> <p>No impression shall be made that the accreditation also extends to fields beyond the scope of accreditation attested by DAKKS.</p> <p>The accreditation was granted pursuant to the Act on the Accreditation Body (AkkStelleG) of 31 July 2009 (Federal Law Gazette I p. 2625) and the Regulation (EC) No 765/2008 of the European Parliament and of the Council of 9 July 2008 setting out the requirements for accreditation and market surveillance relating to the marketing of products (Official Journal of the European Union L 218 of 9 July 2008, p. 30). DAKKS is a signatory to the Multilateral Agreements for Mutual Recognition of the European co-operation for Accreditation (EA), International Accreditation Forum (IAF) and International Laboratory Accreditation Cooperation (ILAC). The signatories to these agreements recognise each other's accreditations.</p> <p>The up-to-date state of membership can be retrieved from the following websites: EA: www.european-accreditation.org ILAC: www.ilac.org IAF: www.iaf.nu</p> |

Note: The current certificate annex is published on the websites (link see below).

<https://www.dakks.de/files/data/as/pdf/D-PL-12076-01-04e.pdf>

OR

https://ctcadvanced.com/app/uploads/2020/06/D-PL-12076-01-04_Canada_TCEMC.pdf

17 Accreditation Certificate – D-PL-12076-01-05

| first page | last page | | | |
|---|---|--|--|--|
|  <p>Deutsche Akkreditierungsstelle GmbH</p> <p>Entrusted according to Section 8 subsection 1 AkkStelleG in connection with Section 1 subsection 1 AkkStelleGBV Signatory to the Multilateral Agreements of EA, ILAC and IAF for Mutual Recognition</p> <p>Accreditation </p> <p>The Deutsche Akkreditierungsstelle GmbH attests that the testing laboratory CTC advanced GmbH Untertürkheimer Straße 6-10, 66117 Saarbrücken is competent under the terms of DIN EN ISO/IEC 17025:2018 to carry out tests in the following fields: Telecommunication (FCC Requirements)</p> <p>The accreditation certificate shall only apply in connection with the notice of accreditation of 09.06.2020 with the accreditation number D-PL-12076-01. It comprises the cover sheet, the reverse side of the cover sheet and the following annex with a total of 05 pages. Registration number of the certificate: D-PL-12076-01-05</p> <p>Frankfurt am Main, 09.06.2020  by ordg/ Dipl.-Ing. (FH) Alf Egner Head of Division</p> <p><small>The certificate together with its annex reflects the status at the time of the date of issue. The current status of the scope of accreditation can be found in the database of accredited bodies of Deutsche Akkreditierungsstelle GmbH. https://www.dakks.de/en/content/accredited-bodies-dakks See notes on final sheet.</small></p> | <p>Deutsche Akkreditierungsstelle GmbH</p> <table border="0"> <tr> <td>Office Berlin Spittelmarkt 10 10117 Berlin</td> <td>Office Frankfurt am Main Europa-Allee 52 60327 Frankfurt am Main</td> <td>Office Braunschweig Bundesallee 100 38116 Braunschweig</td> </tr> </table> <p>The publication of extracts of the accreditation certificate is subject to the prior written approval by Deutsche Akkreditierungsstelle GmbH (DAkKS). Exempted is the unchanged form of separate disseminations of the cover sheet by the conformity assessment body mentioned overleaf.</p> <p>No impression shall be made that the accreditation also extends to fields beyond the scope of accreditation attested by DAkKS.</p> <p>The accreditation was granted pursuant to the Act on the Accreditation Body (AkkStelleG) of 31 July 2009 (Federal Law Gazette I p. 2625) and the Regulation (EC) No 765/2008 of the European Parliament and of the Council of 9 July 2008 setting out the requirements for accreditation and market surveillance relating to the marketing of products (Official Journal of the European Union L 218 of 9 July 2008, p. 30). DAkKS is a signatory to the Multilateral Agreements for Mutual Recognition of the European co-operation for Accreditation (EA), International Accreditation Forum (IAF) and International Laboratory Accreditation Cooperation (ILAC). The signatories to these agreements recognise each other's accreditations.</p> <p>The up-to-date state of membership can be retrieved from the following websites: EA: www.european-accreditation.org ILAC: www.ilac.org IAF: www.iaf.nu</p> | Office Berlin Spittelmarkt 10 10117 Berlin | Office Frankfurt am Main Europa-Allee 52 60327 Frankfurt am Main | Office Braunschweig Bundesallee 100 38116 Braunschweig |
| Office Berlin Spittelmarkt 10 10117 Berlin | Office Frankfurt am Main Europa-Allee 52 60327 Frankfurt am Main | Office Braunschweig Bundesallee 100 38116 Braunschweig | | |

Note: The current certificate annex is published on the websites (link see below).

<https://www.dakks.de/files/data/as/pdf/D-PL-12076-01-05e.pdf>

or

https://ctcadvanced.com/app/uploads/2020/06/D-PL-12076-01-05_TCB_USA.pdf

END OF TEST REPORT