



IPA280-01P1802



Contents

1. Introduction	4
2. Unpacking	5
3. Recommendations	6
3.1. Security	6
3.2. Security of your terminal	6
3.3. EC standard compliance marking	6
3.4. FCC & IC compliance	7
3.4.1. FCC Statement	7
3.4.2. RF Radiation Exposure Statement	7
3.4.3. FCC Hearing-Aid Compatibility (HAC) Regulations for Wireless Devices	8
3.5. Water protection	9
3.6. Main Characteristics	10
4. Installation and connection	11
4.1. Battery	11
4.2. Installing the SPM part on the iPA280 terminal	12
4.3. Installing SPM SAM	13
4.4. Installing PDA SAM and SIM	13
4.5. Installing Micro SD Memory	14
4.6. Installing paper roll	15
4.7. Connections	15
4.8. Positioning the terminal	16
5. Daily use	17
5.1. iPA Keypad functions	17
5.2. Touch screen stylus	18
5.3. LED Display	18
5.4. Other keys	19
5.5. Card insertion	21
5.5.1. Reading a magnetic card	21
5.5.2. Reading a smart card	21
5.5.3. Reading Contactless Card	22
5.5.4. Reading Contactless Payment card	22

5.6. Product Setup	23
5.6.1. Login sequence	23
5.6.2. Main System	24
5.7. Networking	25
5.7.1. Wireless network	25
5.7.1.1. Bluetooth	25
5.7.1.2. Wi-Fi	26
5.7.1.3. GPRS connection	27
5.7.2. Ethernet	28
5.7.3. Phone	29
5.7.4. Factory Reset	31
5.7.5. Language	32
5.7.6. System Info	32
5.7.7. Date Time Setting	33
5.7.8. Barcode Reader	33
5.7.9. Hotkey	36
5.8. Power modes (connected and mobile)	36
5.8.1. Charging the battery	36
5.8.2. Normal mode	36
5.8.3. Standby mode	36
5.8.4. Reduced Power modes	37
5.8.5. Deep sleep	37
5.9. Camera	37
6. Maintenance	38
6.1. Paper roll	38
6.2. Cleaning of the terminal	38
6.3. Transport and storage	39
6.4. Troubleshooting	39
6.5. Environment (WEEE, Batteries and Packaging)	39
7. Extensions and accessories	40
7.1. Cradles	40
7.2. Holster	41
7.3. Pistol	42
8. Eula terms	43
9. Additional terms CE	45

1. Introduction

Thank you for choosing a payment terminal Ingenico.

We recommend to read carefully this user guide : It provides the necessary information about safety precautions, unpacking, installation, and maintenance of your terminal.



WARRANTY / SECURITY

To benefit from the guarantee-related product, and to respect the security, we ask you to use only accessories delivered in box with the product, or original Ingenico accessories, entrusting maintenance operations only to an authorized person.

Failure to comply with these instructions will void the manufacturer's responsibility.

The IPA-280 terminal concept is :

PDA Module



SPM Module

(Security Payment Module)



This symbol indicates an important Warning.



This symbol indicates a piece of advice.

2. Unpacking



ADVICE

Carefully preserve the packaging of the iPA280. It must be re-used whenever the terminal is shipped.

According to the model, the following items are included in the iPA280 box (including optional accessories):

- The iPA280 terminal
- The charging unit (including region specific power plug)
- The Paper roll
- The battery pack
- The user guide
- SPM Lock pin screws x2



Power Adaptor



Power Plug Adapter



EU/US adapter



Paper roll (in bag)



Paper roll



Battery



User guide



Smart Card Rubber cover and chord



Stylus



SPM lock pin screws x2



USB cable



The power supply unit provided with your equipment is specially designed for Ingenico iPA280 terminals. Do not use any other power supply.

3. Recommendations

3.1. Security

Power on/Power down

To power on or power down the iPA280 press End (red) key on PDA module key pad.

Electrical power supply network

Provide an electrical outlet:

- Located near the equipment and easily accessible
- Which meets the standards and regulations in the country of use.
- The terminal iPA280 can be connected to a power distribution system of the IT type.

3.2. Security of your terminal

Upon receipt of your terminal you should check for signs of tampering of the equipment. It is strongly advised that these checks are performed regularly after receipt. You should check, for example: that there is no evidence of unusual wires that have been connected to any ports on your terminal or associated equipment, or any other part of your terminal. Such checks would provide warning of any unauthorised modifications to your terminal, and other suspicious behaviour of individuals that have access to your terminal.

You are strongly advised to ensure that privileged access to your terminal is only granted to staff that have been independently verified as being trustworthy.

3.3. EC standard compliance marking

EC standard compliance marking certifies that the product stipulated below: **iPA280**.

- complies with the basic requirements of European Directive 1999/5/CE, known as the «**R&TTE Directive**» concerning Radio Frequency equipment and telecommunications terminals with respect to:
 - Health and safety protection of the user and all other persons
 - EMC protection
- conforms to the following harmonized standards :
 - IEC/EN 60950-1 : Electrical safety of data processing equipment including electrical office equipment. Issue DEC 2001
 - EN 55022 : Data processing equipment – Radio electric disturbance characteristics - Limits and measurement methods. Issue 1998 / A1-2000/A2-2003
 - EN 55024: Data processing equipment – Immunity characteristics - Limits and measurement methods. Issue 1998 + A1- 2001 + A2- 2003
- complies with the following specification:
 - EN 301511 : Harmonized stand for mobile
 - EN 300328 : (BT + Wi-Fi) Electromagnetic compatibility and Radio Spectrum
 - EN 300330 : NFC Electromagnetic compatibility and Radio Spectrum

3.4. FCC & IC compliance

FCC & IC has a specific naming.

The references uses for FCC & IC certifications are:

- IC:2586D-IPA280NWMDM
- FCCID:XKBIPA280NEWMODEM

3.4.1. FCC Statement

Federal Communications Commission (FCC) Statement

15.21

You are cautioned that changes or modifications not expressly approved by the part responsible for compliance could void the user's authority to operate the equipment.

15.105(b)

This equipment has been tested and found to comply with the limits for a Class B digital device, pursuant to part 15 of the FCC rules. These limits are designed to provide reasonable protection against harmful interference in a residential installation. This equipment generates, uses and can radiate radio frequency energy and, if not installed and used in accordance with the instructions, may cause harmful interference to radio communications. However, there is no guarantee that interference will not occur in a particular installation. If this equipment does cause harmful interference to radio or television reception, which can be determined by turning the equipment off and on, the user is encouraged to try to correct the interference by one or more of the following measures:

- Reorient or relocate the receiving antenna.
- Increase the separation between the equipment and receiver.
- Connect the equipment into an outlet on a circuit different from that to which the receiver is connected.
- Consult the dealer or an experienced radio/TV technician for help.

This device complies with Part 15 of the FCC Rules. Operation is subject to the following two conditions:

- 1) This device may not cause harmful interference and
- 2) This device must accept any interference received, including interference that may cause undesired operation of the device.

3.4.2. RF Radiation Exposure Statement

For body worn operation, this device has been tested and meets RF exposure guidelines when used with an accessory that contains no metal and that positions the device a minimum of 1.5 cm from the body. Use of other accessories may not ensure compliance with RF exposure guidelines.

Annex

Suggested text for the notice indicating compliance with this standard:

This Class [B] digital apparatus complies with Canadian ICES-003.



CAUTION

The user is cautioned that any changes or modification not approved by INGENICO could void user's authority to operate the equipment.

This device complies with Industry Canada licence- exempt RSS standard(s).

Operation is subject to the following two conditions:

(1) This device may not cause interference.

(2) This device must accept any interference,

including interference that may cause

undesired operation of the device.

3.5. Water protection

SAM support lid

The SAM sliding lid located under the terminal (see chapter “Installation SAM”) must be in place during normal operation of the terminal.



Headphone lid

The headphone lid is located on the side of the terminal must be in place during normal operation of the terminal

SD Card and micro USB OTG lid

The SD card and USB OTG lid is located on the side of the terminal must be in place during normal operation of the terminal



Cable lid



The cable lid is located under the terminal (see chapter “Installing the iPA280”) must be in place during normal operation of the terminal.

SPM Smart Card Rubber Cover

A cover for the smart card connector entrance is attached to the side of the PDA. It must be placed on the connector when the smart card reader is not used in order to protect against unwanted liquid or dust.



3.6. Main Characteristics

The main technical characteristics of the terminal Ingenico iPA280 are:

Terminal

Weight	about 590 g with paper roll, SPM and battery
Size (with foot in middle position)	190 x 86(75) x 42(39) mm (l x w x h)
Micro SD slot	1
operating bands	BT:2402-2480MHz WLAN:2412-2462MHz for US used 2412-2472MHz for EU used WWAN:900/1800MHz for EU used 850/1900MHz for US used

SPM part

Weight	160 g
Dimensions	140 x 86x 20 mm (l x w x h)

Cable length

Power block cable	approx 1,3 m
-------------------	--------------

Display

Type	Graphical TFT color
Display area (active zone)	3.5"
Number of pixels	480 x 640
Technology	Transflective
Backlight	LED
Brightness	180 cd/m ²
Contrast	1:1500
Number of colors	262k

Operating conditions

Charging temperature range	0°C to 40°C
Operating temperature range	-10°C to 50°C
Max relative humidity	5% to 90%, not condensing

Storage conditions

Storage temperature	-20°C, +60°C
Max relative humidity	5% to 90°C

4. Installation and connection



CAUTION: Before to start, make sure you have removed the protective film battery.

4.1. Battery

To access the battery follow the instructions below:

- Open the battery compartment using the slide levers in the direction shown **1** and follow the procedure illustrated by arrows on illustration.



- Position the battery pack, making sure the battery contacts are aligned with the contacts in the compartment, as shown in the following illustration.
- Place the battery pack into the battery bay and press the battery securely into the compartment.
- Close the device by fitting back the SPM (see section 4.2)



WARNING! There is a risk of fire and burns if the battery pack is handled improperly.

DO NOT disassemble, crush, puncture, short external contacts, or dispose the battery pack in fire or water.

DO NOT attempt to open or service the battery pack. Dispose of used batteries according to local recycling guidelines in your area.

A backup battery cell is embedded into your device to prevent data loss during exchange of the removable battery pack.

4.2. Installing the SPM part on the iPA280 terminal

The USB connection is located on the rear of the terminal.



The indications below show you how to connect the SPM part to the iPA280 terminal.

- Insert the SPM part to connect the USB connector, then slide down, then lock it using the two side levers. User can secure the SPM assembly using two standard screws (size: M1.6xL3 delivered with the unit) as indicated in the picture.
- The screws prevent too easy access to the battery, SIM and SAMs. A tool has to be used to remove the SPM in that case.



- The SPM is now connected to the iPA280

4.3. Installing SPM SAM



CAUTION :

Before to start, switch off the terminal.

The SPM has two slots for SAM cards. They are placed in the rear of the SPM side, (see procedure for opening 4.1). (The location of modules are engraved in compartment)

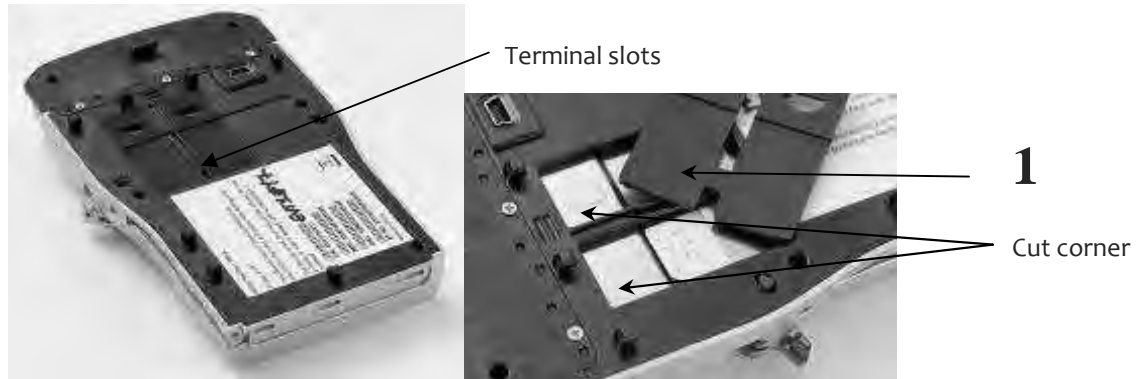

When introducing a SAM in its slot, be sure to put the cut corner as indicated on marking.

- Lift the protective caps **1** and introduce the module in its slot to the end until you hear a click.



To remove SAM, we suggest you to use a piece of adhesive previously pasted on both sides of the SAM as shown here below

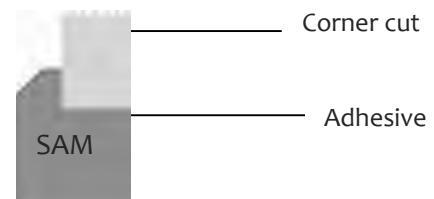

4.4. Installing PDA SAM and SIM

The PDA side has two slots for SIM cards and two slots for SAM cards. They are placed inside the battery compartment, in the rear of the terminal (see procedure to opening 4.1).

- Lift the battery, as shown in the following illustration.
- Slots of module are located under the battery; insert the card module in its slot. Make sure you put the cut corner as indicated on marking.
- Put the battery back (see procedure 4.1).

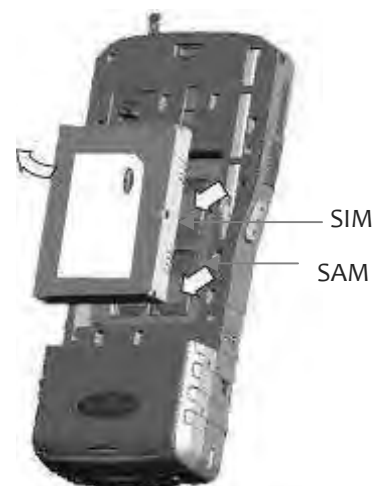

- The position of SIM and SAM slots are indicated in the following picture.

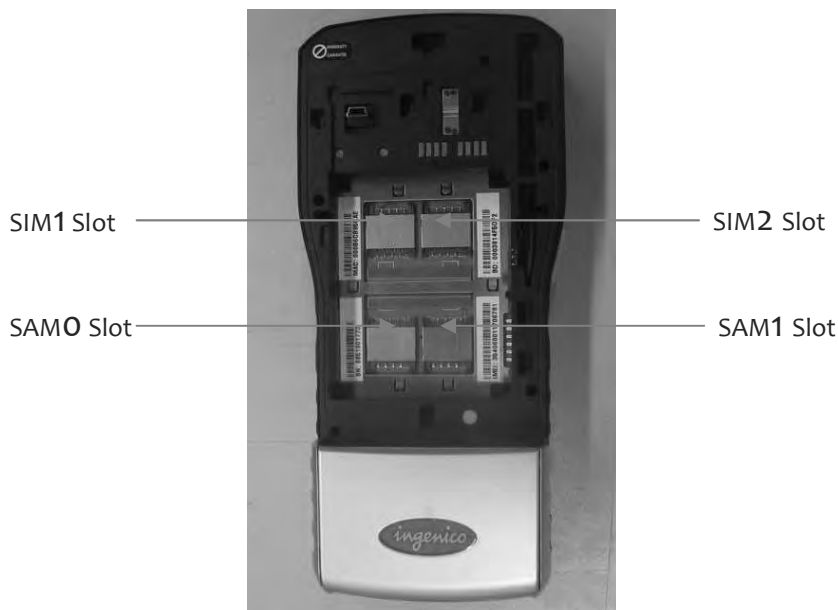

4.5. Installing Micro SD Memory

- Micro SD Memory slot is located at the right side of the terminal.
- Insert completely the micro SD memory card in the slot.



Be careful of the insertion direction. See the illustration below

- To remove the Micro SD Memory Card, push on it with your nails or stylus.



MicroSD Memory slot



4.6. Installing paper roll



CAUTION: Use only paper approved by the manufacturer (width diameter 57 mm). Use of unsuitable paper is likely to damage the printer of your terminal (see characteristics in “Maintenance chapter 5.5.4”). When opening, closing and installing the paper inside the slot, the user should be careful of the metal cutting edge.

Don't touch the thermal printer head.



- Open the paper compartment by lifting the cover on the front face and pull the cover to the rear of the terminal.

Cover



ATTENTION

Do not force the cover against stop edge.

- Insert the paper roll in the compartment.



Make sure that GPRS antenna is located in its protective film.

- Unroll the paper out of the compartment and hold it in bottom position as illustrated.
- Maintain the paper and close the cover.
- Press in the middle of the cover to close it.

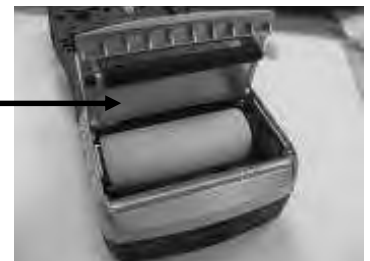

Correct position

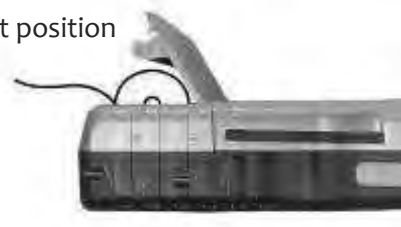

4.7. Connections

- Establishing Device-PC Connection
 - Installing Microsoft ActiveSync

In order to exchange data between your computer and iPA280, Microsoft ActiveSync must be installed on your computer. Use the data and power cable that comes with your device to connect the device to your computer.

NOTE: If you have a previous version of the Microsoft ActiveSync installed in your computer, uninstall it first before installing the latest version of Microsoft ActiveSync.

o Connecting the Device to Your Computer

1. After ActiveSync has been installed, connect the plug of data and charge cable to the universal connector at the bottom of your device.

2. Plug the other end of the USB charging cable into a USB port on your computer.

3. Turn the device on.

4. ActiveSync starts automatically and configure the USB port to work with the iPA280. The New Partnership setup wizard will automatically start.

NOTE: If ActiveSync does not start automatically, click Start Programs Microsoft ActiveSync.

If a message appears indicating that it is unable to detect a connection, click the Cancel button and manually configure the communication settings.

4.8. Positioning the terminal

Place the terminal away from any heat source and protected from dust, vibrations and electromagnetic radiations (away from video terminals, PC, anti-shoplifting barriers ...).

5. Daily use

5.1. iPA Keypad functions



- 1 NAVIGATION keys in the menus
- 2 FUNCTION keys F
- 3 CANCEL key (red)
- 4 CLEAR key (yellow)
- 5 VALIDATION key (green)



- 1 Soft key :
 - Left Soft key : Corresponding to left menu
 - Right Soft key : Corresponding to right menu
 - Center Soft key: Application specified
- 2 Programmable key
- 3 Navigation key :
 - 4 Navigation directions
 - 1 Select (center) / OK
- 4 Send/End :
 - Send (green):
Select Press: opens the phone dialer application
Press (while a call is coming in): Answer the call
Press and Hold (when on a call): goes to speakerphone
 - End (red) :
Press (when in a call): ends a call
Press (while a call is coming in): Ignore the call
Press : Suspend/resume the device
Press and Hold: Turn the device off.
- 5 Functions key (4) : These key can be set on main system, but cannot be launched from main system
- 6 Alphanumeric key (12)

5.2. Touch screen stylus

- Remove the stylus from its holder.
- Hold the stylus as you hold a pencil.
- To make a choice from a menu, lightly tap the tip of the stylus on that choice.



5.3. LED Display

Behaviour of LED on PDA side

2 LEDs for communications, batteries and SPM

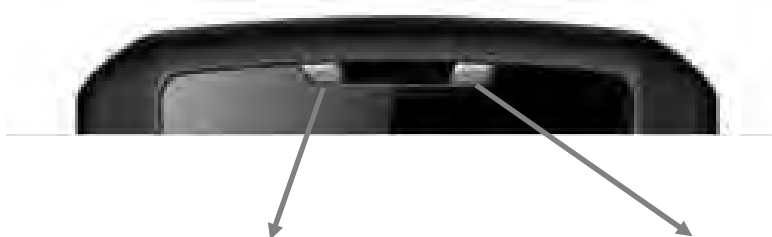

		Left LED	Right LED
Battery	Charging		RED
	Charged		GREEN
	Low		RED-Flash (*) System power < 15% : 0.3 s on / 1.7 s off Printer power low : 0.3 s on / 0.55 s off Printer power cut off: 0.3 s on / 0.3 s off
Communication	Blue Tooth	BLUE – Flash On 0.5 s / Off 5 s	
	WiFi	BLUE – Flash On 0.5 s / Off 5 s	
	GSM GPRS		GREEN – Flash (*) On 2s
SPM	Powered ON	YELLOW	

(*) If SIM inserted and device registered, only GSM GPRS information available

The low battery led has a higher priority than green. In case of low battery, only red led is flashed

5.4. Other keys

ON/OFF

ON/OFF Key



- Press and Hold: turns the device off. Touch panel is not able to wake-up the device.
- Press and Hold when the device is in OFF mode: turns the device on with behavior similar to soft reset.
- Short Press: suspend/resume of the device.

Volume

Volume Key



- When phone call is active, press to increase or decrease the phone volume.
- When phone call is not active, press to increase or decrease the PDA volume.

Reset

Reset Key



- You may have to perform a reset if the device freezes (i.e., device no longer responds to the buttons or tapping on the screen).
- A soft reset allows your device to get a fresh start, similar to rebooting a computer. This will restart your device. All records and entries are retained after a soft reset. Unsaved data in open programs may be lost in some cases.
- Lightly press the tip of the stylus to the reset button located on the rear of the device.

5.5. Card insertion

5.5.1. Reading a magnetic card

- Insert the card manually in the Magnetic stripe card slot, magstripe from right side to left side or from left to right side.

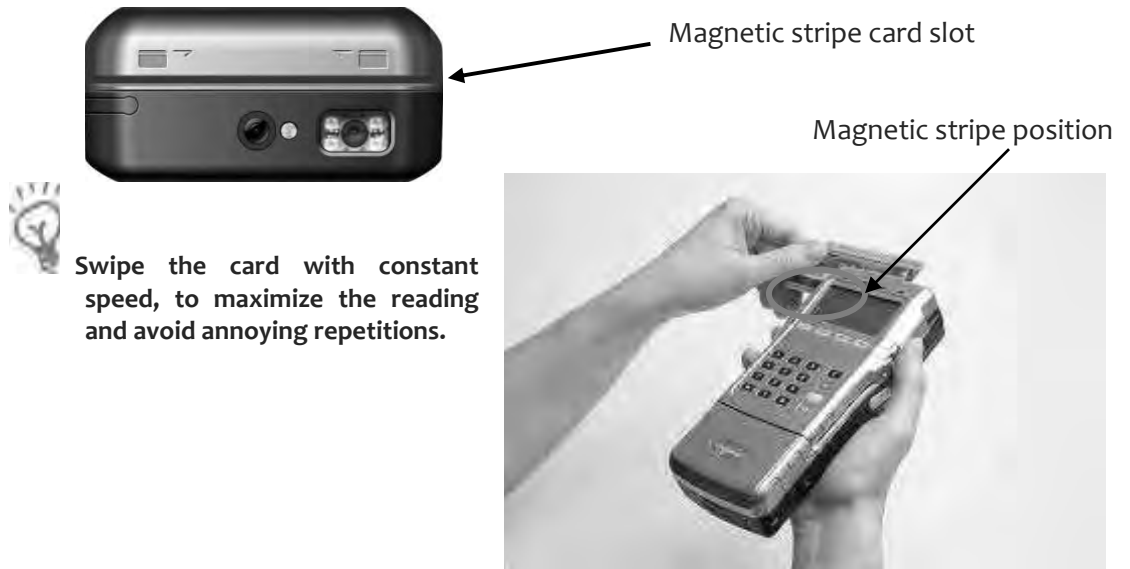

5.5.2. Reading a smart card

- Turn to SPM right side, take out the smart card rubber and insert the Smart card to the end of the slot, chip facing up, to read the card information.



5.5.3. Reading Contactless Card

- PDA contactless is dedicated for user ID, transportation tickets and cards controls, RFID labels reading, loyalty cards reading, ...
It is not meant to be used for contactless payment



5.5.4. Reading Contactless Payment card

- SPM contactless is dedicated to contactless payment.



As the contactless antenna is placed around the display and keypads, the contactless card must be presented in front of Contactless logo between the screen to perform the transaction.

The 4 green LEDs indicate that the transaction is completed.

5.6. Product Setup

This section describes the way to setup the main product features using basic mode and Main System mode

Please refer to your applications documentation for automatic enabling of features

5.6.1. Login sequence

After powering on the device (connect the power ON/OFF button on top of the device. This sequence will also happen after inserting a charged battery) the following screens are chained:

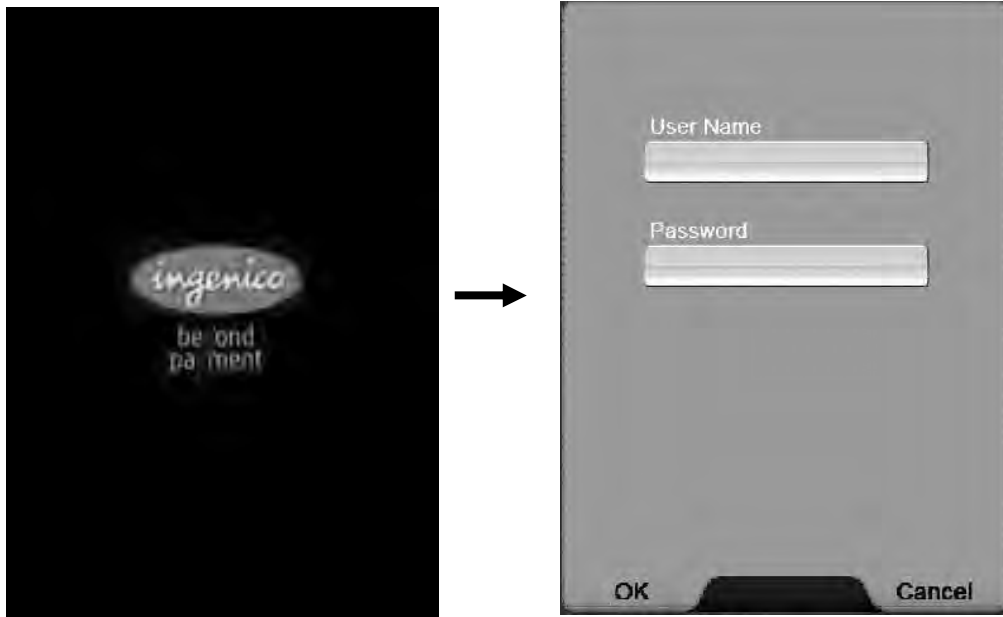

CAUTION

Do not press the green key until password and username are entered.

A username and a password should be introduced (hit the sensitive area)

Default username: admin
Default password: admin



Do not forget to change the password after first login.



If you are the administrator, the following screen is displayed:



If no user name and password are entered, the product reverts into user mode. Once a selection is done it will be entered by default on the next boot

Once the final application selected by the administrator is installed, this application is automatically launched at device power up.

5.6.2. Main System

- When the power off device is plugged in with the power cord, the boot screen with Ingenico logo is shown.
- After several seconds the next system selection screen will automatically be displayed. The user can select one of WinCE OS, Main System or 3rd Party Systems from here.
- After click the selection of the Main System, the Phone Dialer screen will be shown.



5.7. Networking

5.7.1. Wireless network

You can use Connectivity menu to select the desired Wireless Networking function.



5.7.1.1. Bluetooth



- Click the BT button in Connectivity menu to turn on/off Bluetooth function.
- Click one of item in Untrusted or Trused list in BT menu to select the desired Bluetooth device to be connected.



5.7.1.2. Wi-Fi



- Click the Wi-Fi button in the Connectivity menu to turn on/off Wi-Fi function.
- Click one of item in Wi-Fi List in Wi-Fi menu to select the desired Wi-Fi device to be connected.



- Double click the selected item in Wi-Fi List to display the Wi-Fi Information as in the following screen.



5.7.1.3. GPRS connection



- Click the GPRS button in the Connectivity menu.
- Enter the PIN number from SIM card and click OK button in the next two screens.



- Enter a random data in the 'Enter Connection Name' box and 'internet' in the 'Access Name' box and click OK button to enable GPRS connection function.

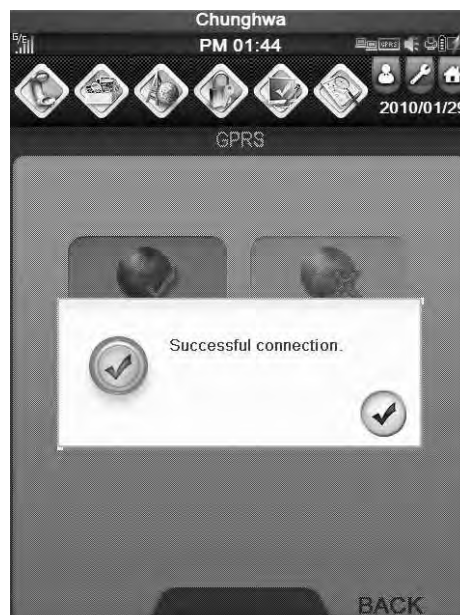

5.7.2. Ethernet



- Click the Ethernet button in the Connectivity menu.
- Enter IP Address and Default Gateway in the boxes of the dialog and click OK button to the next screen.



- Enter DNS and WINS in the boxes of the dialog and click OK button to enable Ethernet function.



5.7.3. Phone

The iPA280 has an integrated phone keypad, which allows you to make, receive, and send messages via the built-in module.

NOTE: Make sure you insert the SIM card properly. To open the Phone screen, do one of the following.

1. Tap Phone on the bottom left corner of the screen.
2. Press Talk/Send button.

Press Cancel button when you want to exit the Phone Dialer screen.

The Phone Dialer screen opens. From here you can create Speed Dials, get the Call History and customize phone settings.

NOTE: If your SIM card is protected by a PIN code, input the password before you can use the phone. Tap the antenna signal icon on the upper right corner of the screen. Tap Wireless Manager and turn on phone function.



- Click the Speed Dialler button  in Phone Dialler menu to go to Speed Dialler screen.



- Click the Call History button  in Phone Dialler menu to go to Call History screen.



- Click the Dialer button  in Phone Dialer menu to make the phone and to get the dialing Phone Dialer screen.



During the dialing status, the iPA280 can still use WLAN/BT/RFID at the same time.

5.7.4. Factory Reset

- Click the button  to get the Factory Reset screen. Click OK button to have the device system back to the factory setting.



5.7.5. Language



- Click the button to get the Language screen. Select the desired language and click OK button to change the language in the device.



5.7.6. System Info



- Click the button to get the System Info screen.



5.7.7. Date Time Setting

- Click the button  to get the Time Setting screen.



5.7.8. Barcode Reader

- Press Right and Left scanner trigger buttons to activate the barcode scanner.
- LED indicates the battery charging and barcode scanning status.
 - Green - Battery is fully charged, or barcode scanning process is completed without error.
 - Red - Battery is charging, barcode scanner is fired/activated.

- Barcode scanner setting :

- Click the button  to get the System menu.



- Click the button  to get the Barcode menu.



- List the format that supported by default barcode firmware as below.

Factory default can read	<ol style="list-style-type: none"> 1. Code39 2. Code128/GS1-128 3. DataMatrix 4. EAN/UPC
Symbology can read	<ol style="list-style-type: none"> 1. Code39 2. Code128/GS1-128 3. DataMatrix 4. EAN/UPC 5. Aztec 6. Codabar 7. Code11 8. Code93 9. EAN add on 2 10. Interleave 2 of 5 11. Matrix 2 of 5 12. Plessey 13. GS1 DataBar 14. Standard 2 of 5 15. Telepen 16. QRCode 17. Maxicode 18. MicroPDF417
PARAF can read	<ol style="list-style-type: none"> 19. PARAF code
TriopticNCodablock can read	<ol style="list-style-type: none"> 1. Code39 2. Code128/GS1-128 3. DataMatrix 4. EAN/UPC 20. Trioptic 21. Codablock F

5.7.9. Hotkey

- Click the button  to get the Hotkey setting screen.



5.8. Power modes (connected and mobile)

5.8.1. Charging the battery

- Before using iPA280 for the first time, you need to charge it for about 16 hours.
- After that, you can charge the iPA280 4 hours to recharge the battery to full capacity.
- Charge the iPA280 using the data and power cable or the docking station.



CAUTION! Operating the iPA280 for the first time without the AC adapter, and without fully charging the backup battery may result in loss of data stored in RAM memory. When the main battery is removed, the backup battery retains date and time for at least 10 minutes.

5.8.2. Normal mode

- Device is on and running. It is receiving full power from the system and is delivering full functionality to the user.
- LCD is on. If in the talking mode LED is in fast flash mode, others LED flashes in green every 2 seconds

5.8.3. Standby mode

- Device is partially powered, tap the screen or hit a key to wake up.
- LCD is off and LED flashes in green every 2 seconds.

5.8.4. Reduced Power modes

- Device is partially powered, with device-initiated wake up or user initiative wake up. A device in this mode is sleeping but capable of raising the system power state on its own. It consumes only enough power to be able to do so.
- LCD is off and LED flashes in green every 2 seconds.

5.8.5. Deep sleep

- Device has no power. A device in Deep Sleep mode should not be consuming any significant power. Some peripheral busses require static terminations that intrinsically use non-zero power when a device is physically connected to the bus.
- LCD is off and LED flashes in green every 2 seconds.

5.9. Camera

iPA280 integrate a 3M pixel with Auto focus camera for taking photos and videos.

6. Maintenance



ATTENTION

Before making any operations of maintenance in the terminal, make sure that the power supply is disconnected.

6.1. Paper roll

Characteristics	Precisions
Type	Reference: TF50-KR2 (NPI)
Colour	White
Length	Around 7 M (depending on paper roll type)
Width	58 mm
Diameter	24.7m/m +0.5m/m-0.5m/m

- The thermal paper can be deteriorated by poor storage conditions, so we recommend you to avoid:
 - storage in hot wet places (near to air-conditioner, humidity higher than 85%)
 - exposure to sunlight or ultraviolet for long periods
 - contact with organic solvents (solvent type adhesive)
 - direct contact with materials containing plasticizers (PVC transparent folders or envelopes)
 - direct contact with «diaz» papers
 - direct contact with water
 - Rubbing or pressing the paper too strongly



CAUTION

In order to benefit from the complete guarantee of the product, **only heat sensitized paper approved by the manufacturer can be used.**

6.2. Cleaning of the terminal

First of all, unplug all the wires from the terminal.

Good rules for proper cleaning of the terminal are:

- Use a soft cloth that is very slightly soaked with soapy water to clean the outside of the terminal.
- Do not clean the electrical connections.
- Do not use in any case, solvents, detergents or abrasive products: Those materials might damage the plastic or electrical contacts.
- Avoid exposing the terminal to the direct rays of the sun.
- Do not put anything into the slot of the smart card reader

6.3. Transport and storage

- Use the original packaging for any unit stored.
- Disconnect all cables from the terminal during the transport.

6.4. Troubleshooting

The terminal does not turn on or does not connect:

- Check the power supply cable
- Check for electrical power network

The terminal fails to establish a GPRS connection

- Check Section 5.9.3
- Get support from technical

Cards are not read

- Check that the magnetic card is passed correctly (with magnetic band directed to the exterior of the terminal)
- Swipe again the card with the magnetic stripe movement constant and rapid
- Verify that the magnetic strip is not damaged, grooved or cracked
- Make sure you have inserted correctly the smart card into the smart card reader and remove the card only after the transaction

The ticket is not printed

- Check the presence and proper positioning of the paper roll on the iPA280
Possibly adjust the paper roll following instructions present in it's manual
- Check the type of paper used (thermal paper must be used)

6.5. Environment (WEEE, Batteries and Packaging)

This product is labeled in accordance with European Directives 2002/96/EC concerning Waste Electrical and Electronic Equipment (WEEE) and 2006/66/EC concerning Batteries and Accumulators. Those provisions are requiring producers and manufacturers to become liable for take-back, treatment and recycling upon end of life of equipment and batteries.



The associated symbol means that WEEE and waste batteries must not be thrown away but collected separately and recycled.

Ingenico ensures that efficient collection and recycling schemes are set-up for WEEE and batteries according to the local regulation of your country. Please contact your retailers for more detailed information about the compliance solution in place for disposing of your old product and used batteries.

Packaging waste must also be collected separately to assure a proper disposal and recycling.

Please note that proper recycling of the electrical and electronic equipment and waste batteries will ensure safety of human health and environment.

7. Extensions and accessories

7.1. Cradles

- Charging the Battery with the cradle:
 - Plug the AC adapter cable into the power jack on the cradle, then connect the AC adapter into an electrical outlet.
 - Before slide the device into cradle, remove the grommet of the terminal (see location on illustration) in order to establish the connection with cradle.
 - The connection is secure when the bottom edge of the device is aligned with the cradle, and the LED indicator on the device lights up red.

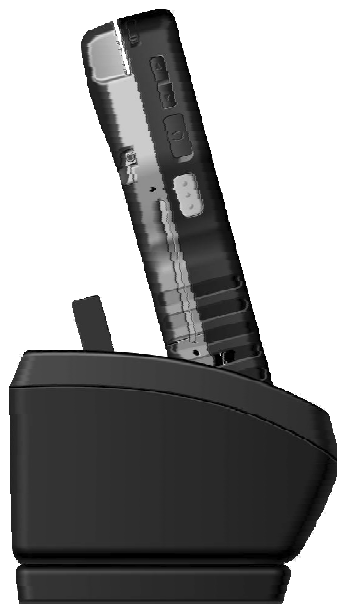

7.2. Holster

- The Holster can hold two paper rolls on both side. The front pocket can hold a iPA280 battery.

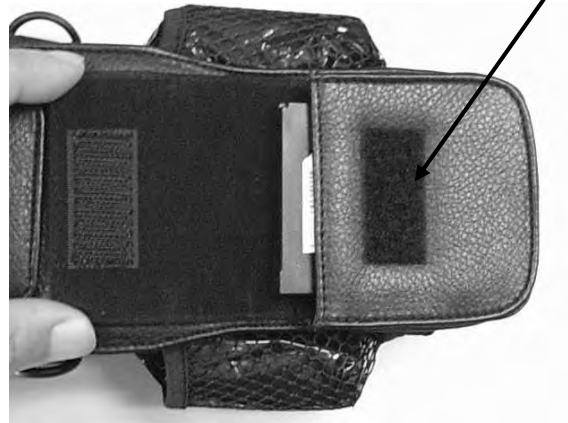
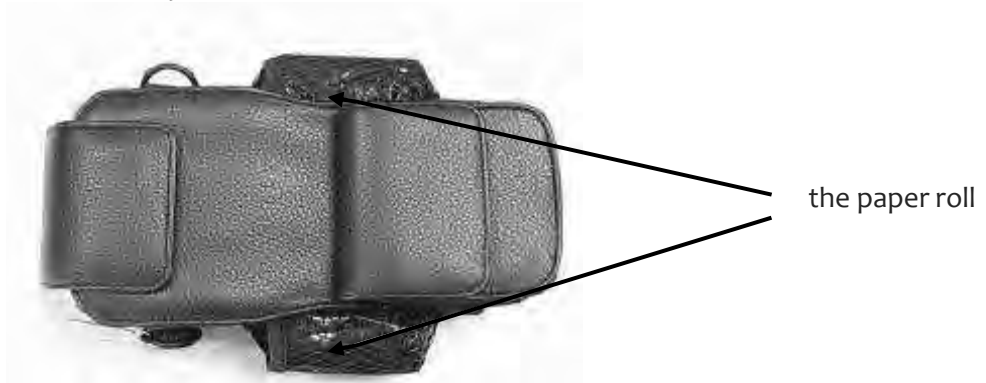

7.3. Pistol

- Pistol Grip handle (for inventory management purpose), Data capture through trigger, Easy snap on PDA.



- To install the pistol on PDA, remove the SPM part (see section 4.1), and slide the pistol in the PDA part, as illustrated by arrows on the illustration.



8. Eula terms

COMPANY shall sublicense the Licensed Product to end users by means of a EULA. COMPANY shall provide clear notice to Embedded System customers before or at the time of purchase that the Embedded System contains software that is subject to a license and that customer must agree to that license before it may use the Embedded System. COMPANY shall distribute the EULA in a manner that forms a contract binding the end user to the EULA terms under applicable law. The EULA shall contain (A) the following terms, and (B) any additional EULA terms set forth by MS in the Additional Provisions for the Licensed Product. COMPANY may include terms in the EULA that are additional or alternative to those set forth below, so long as they are no less protective of MS than the terms set forth below. COMPANY shall substitute its name for the bracketed text [COMPANY] in the EULA text. If permitted by COMPANY's other software suppliers for a particular COMPANY Embedded System, COMPANY may substitute for the word "MS" the term "[COMPANY's] software suppliers".

- You have acquired a device ("DEVICE") that includes software licensed by [COMPANY] from an affiliate of Microsoft Corporation ("MS"). Those installed software products of MS origin, as well as associated media, printed materials, and "online" or electronic documentation ("SOFTWARE") are protected by international intellectual property laws and treaties. Manufacturer, MS and its suppliers (including Microsoft Corporation) own the title, copyright, and other intellectual property rights in the SOFTWARE. The SOFTWARE is licensed, not sold. All rights reserved.
- **[APPROVED ALTERNATIVE TEXT IF COMPANY DOES NOT MENTION MS IN THE EULA TEXT:** "You have acquired a device ("DEVICE") which includes software licensed by [COMPANY] from one or more software licensors ("[COMPANY's] Software Suppliers"). Such software products, as well as associated media, printed materials, and "online" or electronic documentation ("SOFTWARE") are protected by international intellectual property laws and treaties. The SOFTWARE is licensed, not sold. All rights reserved."**"]**
- This EULA is valid and grants the end-user rights ONLY if the SOFTWARE is genuine and a genuine Certificate of Authenticity for the SOFTWARE is included. For more information on identifying whether your software is genuine, please see <http://www.microsoft.com/piracy/howtotell>.
- IF YOU DO NOT AGREE TO THIS END USER LICENSE AGREEMENT ("EULA"), DO NOT USE THE DEVICE OR COPY THE SOFTWARE. INSTEAD, PROMPTLY CONTACT [COMPANY] FOR INSTRUCTIONS ON RETURN OF THE UNUSED DEVICE(S) FOR A REFUND. **ANY USE OF THE SOFTWARE, INCLUDING BUT NOT LIMITED TO USE ON THE DEVICE, WILL CONSTITUTE YOUR AGREEMENT TO THIS EULA (OR RATIFICATION OF ANY PREVIOUS CONSENT).**
- **GRANT OF SOFTWARE LICENSE.** This EULA grants you the following license:
 - You may use the SOFTWARE only on the DEVICE.
 - Restricted Functionality. You are licensed to use the SOFTWARE to provide only the limited functionality (specific tasks or processes) for which the DEVICE has been designed and marketed by [COMPANY]. This license specifically prohibits any other use of the software programs or functions, or inclusion of additional software programs or functions that do not directly support the limited functionality on the DEVICE. Notwithstanding the foregoing, you may install or enable on a DEVICE, systems utilities, resource management or similar software solely for the purpose of administration, performance enhancement and/or preventive maintenance of the DEVICE.
 - If you use the DEVICE to access or utilize the services or functionality of Microsoft Windows Server products (such as Microsoft Windows Server 2003), or use the DEVICE to permit workstation or computing devices to access or utilize the services or functionality of Microsoft Windows Server products, you may be required to obtain a Client Access License for the DEVICE and/or each such workstation or computing device. Please refer to the end user license agreement for your Microsoft Windows Server product for additional information.
 - **NOT FAULT TOLERANT.** THE SOFTWARE IS NOT FAULT TOLERANT. [COMPANY] HAS INDEPENDENTLY DETERMINED HOW TO USE THE SOFTWARE IN THE DEVICE, AND MS HAS RELIED UPON [COMPANY] TO CONDUCT SUFFICIENT TESTING TO DETERMINE THAT THE SOFTWARE IS SUITABLE FOR SUCH USE.
 - **NO WARRANTIES FOR THE SOFTWARE.** THE SOFTWARE is provided "AS IS" and with all faults. THE ENTIRE RISK AS TO SATISFACTORY QUALITY, PERFORMANCE, ACCURACY, AND EFFORT (INCLUDING LACK OF NEGLIGENCE) IS WITH YOU. ALSO, THERE IS NO WARRANTY AGAINST INTERFERENCE WITH YOUR ENJOYMENT OF THE SOFTWARE OR AGAINST INFRINGEMENT. **IF YOU HAVE RECEIVED ANY WARRANTIES REGARDING THE DEVICE OR THE SOFTWARE, THOSE WARRANTIES DO NOT ORIGINATE FROM, AND ARE NOT BINDING ON, MS.**
 - **No Liability for Certain Damages.** EXCEPT AS PROHIBITED BY LAW, MS SHALL HAVE NO LIABILITY FOR ANY INDIRECT, SPECIAL, CONSEQUENTIAL OR INCIDENTAL DAMAGES ARISING FROM OR IN CONNECTION WITH THE USE OR PERFORMANCE OF THE SOFTWARE. THIS LIMITATION SHALL APPLY EVEN IF ANY REMEDY FAILS OF ITS ESSENTIAL PURPOSE. IN

NO EVENT SHALL MS BE LIABLE FOR ANY AMOUNT IN EXCESS OF U.S. TWO HUNDRED FIFTY DOLLARS (U.S.\$250.00).

- **Restricted Uses.** The SOFTWARE is not designed or intended for use or resale in hazardous environments requiring fail-safe performance, such as in the operation of nuclear facilities, aircraft navigation or communication systems, air traffic control, or other devices or systems in which a malfunction of the SOFTWARE would result in foreseeable risk of injury or death to the operator of the device or system, or to others.
- **Limitations on Reverse Engineering, Decompilation, and Disassembly.** You may not reverse engineer, decompile, or disassemble the SOFTWARE, except and only to the extent that such activity is expressly permitted by applicable law notwithstanding this limitation.
- **SOFTWARE as a Component of the DEVICE - Transfer.** This license may not be shared, transferred to or used concurrently on different computers. The SOFTWARE is licensed with the DEVICE as a single integrated product and may only be used with the DEVICE. If the SOFTWARE is not accompanied by a DEVICE, you may not use the SOFTWARE. You may permanently transfer all of your rights under this EULA only as part of a permanent sale or transfer of the DEVICE, provided you retain no copies of the SOFTWARE. If the SOFTWARE is an upgrade, any transfer must also include all prior versions of the SOFTWARE. This transfer must also include the Certificate of Authenticity label. The transfer may not be an indirect transfer, such as a consignment. Prior to the transfer, the end user receiving the SOFTWARE must agree to all the EULA terms.
- **Consent to Use of Data.** You agree that MS, Microsoft Corporation and their affiliates may collect and use technical information gathered in any manner as part of product support services related to the SOFTWARE. MS, Microsoft Corporation and their affiliates may use this information solely to improve their products or to provide customized services or technologies to you. MS, Microsoft Corporation and their affiliates may disclose this information to others, but not in a form that personally identifies you.
- **Internet Gaming/Update Features.** If the SOFTWARE provides, and you choose to utilize, the Internet gaming or update features within the SOFTWARE, it is necessary to use certain computer system, hardware, and software information to implement the features. By using these features, you explicitly authorize MS, Microsoft Corporation and/or their designated agent to use this information solely to improve their products or to provide customized services or technologies to you. MS or Microsoft Corporation may disclose this information to others, but not in a form that personally identifies you.
- **Internet-Based Services Components.** The SOFTWARE may contain components that enable and facilitate the use of certain Internet-based services. You acknowledge and agree that MS, Microsoft Corporation or their affiliates may automatically check the version of the SOFTWARE and/or its components that you are utilizing and may provide upgrades or supplements to the SOFTWARE that may be automatically downloaded to your DEVICE. Microsoft Corporation or their affiliates do not use these features to collect any information that will be used to identify you or contact you. For more information about these features, please see the privacy statement at <http://go.microsoft.com/fwlink/?LinkId=25243>.
- **Links to Third Party Sites.** You may link to third party sites through the use of the SOFTWARE. The third party sites are not under the control of MS or Microsoft Corporation, and MS or Microsoft are not responsible for the contents of any third party sites, any links contained in third party sites, or any changes or updates to third party sites. MS or Microsoft Corporation is not responsible for webcasting or any other form of transmission received from any third party sites. MS or Microsoft Corporation are providing these links to third party sites to you only as a convenience, and the inclusion of any link does not imply an endorsement by MS or Microsoft Corporation of the third party site.
- **Notice Regarding Security.** To help protect against breaches of security and malicious software, periodically back up your data and system information, use security features such as firewalls, and install and use security updates.
- **No Rental/Commercial Hosting.** You may not rent, lease, lend or provide commercial hosting services with the SOFTWARE to others.
- **Separation of Components.** The SOFTWARE is licensed as a single product. Its component parts may not be separated for use on more than one computer.
- **Additional Software/Services.** This EULA applies to updates, supplements, add-on components, product support services, or Internet-based services components ("Supplemental Components"), of the SOFTWARE that you may obtain from [COMPANY], MS, Microsoft Corporation or their subsidiaries after the date you obtain your initial copy of the SOFTWARE, unless you accept updated terms or another agreement governs. If other terms are not provided along with such Supplemental Components and the Supplemental Components are provided to you by MS, Microsoft Corporation or their subsidiaries then you will be licensed by such entity under the same terms and conditions of this EULA, except that (i) MS, Microsoft Corporation or their subsidiaries providing the Supplemental Components will be the licensor with respect to such Supplemental Components in lieu of the "COMPANY" for the purposes of the EULA, and (ii) TO THE MAXIMUM EXTENT PERMITTED BY APPLICABLE LAW, THE SUPPLEMENTAL COMPONENTS AND ANY (IF ANY) SUPPORT SERVICES RELATED TO THE SUPPLEMENTAL COMPONENTS ARE PROVIDED AS IS AND WITH ALL FAULTS. ALL OTHER DISCLAIMERS, LIMITATION OF DAMAGES, AND SPECIAL PROVISIONS PROVIDED BELOW AND/OR OTHERWISE WITH THE SOFTWARE SHALL APPLY TO SUCH SUPPLEMENTAL COMPONENTS. MS, Microsoft Corporation or their subsidiaries reserve the right to discontinue any Internet-based services provided to you or made available to you through the use of the SOFTWARE.

- **Recovery Media.** If SOFTWARE is provided by [COMPANY] on separate media and labeled “Recovery Media” you may use the Recovery Media solely to restore or reinstall the SOFTWARE originally installed on the DEVICE.
- **Backup Copy.** You may make one (1) backup copy of the SOFTWARE. You may use this backup copy solely for your archival purposes and to reinstall the SOFTWARE on the DEVICE. Except as expressly provided in this EULA or by local law, you may not otherwise make copies of the SOFTWARE, including the printed materials accompanying the SOFTWARE. You may not loan, rent, lend or otherwise transfer the backup copy to another user.
- **End User Proof of License.** If you acquired the SOFTWARE on a DEVICE, or on a compact disc or other media, a genuine Microsoft “Proof of License”/Certificate of Authenticity label with a genuine copy of the SOFTWARE identifies a licensed copy of the SOFTWARE. To be valid, the label must be affixed to the DEVICE, or appear on [COMPANY’S] software packaging. If you receive the label separately other than from [COMPANY], it is invalid. You should keep the label on the DEVICE or packaging to prove that you are licensed to use the SOFTWARE.
- **Product Support.** Product support for the SOFTWARE is not provided by MS, Microsoft Corporation, or their affiliates or subsidiaries. For product support, please refer to [COMPANY] support number provided in the documentation for the DEVICE. Should you have any questions concerning this EULA, or if you desire to contact [COMPANY] for any other reason, please refer to the address provided in the documentation for the DEVICE.
- **Termination.** Without prejudice to any other rights, [COMPANY] may terminate this EULA if you fail to comply with the terms and conditions of this EULA. In such event, you must destroy all copies of the SOFTWARE and all of its component parts.
- **EXPORT RESTRICTIONS.** You acknowledge that SOFTWARE is subject to U.S. and European Union export jurisdiction. You agree to comply with all applicable international and national laws that apply to the SOFTWARE, including the U.S. Export Administration Regulations, as well as end-user, end-use and destination restrictions issued by U.S. and other governments. For additional information see <http://www.microsoft.com/exporting/>.

9. Additional terms CE

FOR RUNTIME LICENSES FOR :

Product Name and Version	Applicable Additional Terms
Microsoft® Windows® CE Operating System for Embedded Systems, Version 3.0 with Add-on Pack Runtime	(1), (3), (4), (5), (14), (16), (21), (22), (25), (28), (41)
Microsoft® Windows® CE Operating System for Embedded Systems, Professional Version 3.0 with Add-on Pack Runtime	(1), (3), (4), (6), (14), (16), (21), (22), (25), (28), (41)
Microsoft® Windows® CE .NET Operating System for Embedded Systems, Version 4.0 Runtime	(1), (3), (4), (7), (14), (16), (17), (20), (22), (29), (41)
Microsoft® Windows® CE .NET Operating System for Embedded Systems, Professional Version 4.0 Runtime	(1), (3), (4), (8), (14), (16), (17), (22), (29), (36), (41)
Microsoft® Windows® CE .NET Operating System for Embedded Systems Version 4.1 Runtime	(1), (3), (4), (9), (14), (16), (18), (19), (22), (30), (41)
Microsoft® Windows® CE .NET Operating System for Embedded Systems, Professional Version 4.1 Runtime	(1), (3), (4), (10), (14), (16), (18), (19), (22), (30), (41)
Microsoft® Windows® CE .NET Operating System for Embedded Systems, Professional Plus Version 4.1 Runtime	(1), (3), (4), (11), (14), (16), (18), (19), (22), (30), (41)
Microsoft® Windows® CE .NET Operating System for Embedded Systems, Core Version 4.2 Runtime	(1), (3), (4), (14), (15), (16), (19), (22), (26), (31), (41)
Microsoft® Windows® CE .NET Core Version 4.2 Field Upgrade	(1), (2), (3), (4), (14), (15), (16), (19), (22), (26), (31), (41)
Microsoft® Windows® CE .NET Operating System for Embedded Systems, Professional version 4.2 Runtime	(1), (3), (4), (12), (14), (15), (16), (19), (22), (31), (41)
Microsoft® Windows® CE .NET Professional Version 4.2 Field Upgrade	(1), (2), (3), (4), (12), (14), (15), (16), (19), (22), (31), (41)
Microsoft® Windows® CE .NET Operating System for Embedded Systems, Professional Plus Version 4.2 Runtime	(1), (3), (4), (13), (14), (15), (16), (19), (22), (31), (41)
Microsoft® Windows® CE .NET Professional Plus Version 4.2 Field Upgrade	(1), (2), (3), (4), (13), (14), (15), (16), (19), (22), (31), (41)

Microsoft® Windows® CE Operating System For Embedded Systems, Core Version 5.0 Runtime	(1), (3), (4), (14), (15), (16), (22), (23), (26), (32), (41), (44), (48), (52)
Microsoft® Windows® CE Core Version 5.0 Field Upgrade	(1), (2), (3), (4), (14), (15), (16), (22), (23), (26), (32), (41), (44), (48), (52)
Microsoft® Windows® CE Operating System For Embedded Systems, Core PLUS Version 5.0 Runtime (ESD)	(1), (3), (4), (14), (15), (16), (22), (23), (26), (32), (41), (44), (48), (52)
Microsoft® Windows® CE Operating System For Embedded Systems, Professional Version 5.0 Runtime	(1), (3), (4), (12), (14), (15), (16), (22), (23), (26), (32), (41), (44), (46), (47), (48), (52), (53)
Microsoft® Windows® CE Professional Version 5.0 Field Upgrade	(1), (2), (3), (4), (12), (14), (15), (16), (22), (23), (26), (32), (41), (44), (46), (47), (48), (52), (53)
Microsoft® Windows® CE Operating System For Embedded Systems, Professional Plus Version 5.0 Runtime	(1), (3), (4), (13), (14), (15), (16), (22), (23), (26), (32), (41), (44), (46), (47), (48), (52), (53)
Microsoft® Windows® CE Professional Plus Version 5.0 Field Upgrade	(1), (2), (3), (4), (13), (14), (15), (16), (22), (23), (26), (32), (41), (44), (46), (47), (48), (52), (53)
Windows® CE Operating System for Embedded Systems, Version 5.0 Runtime for Set Top Boxes	(1), (3), (4), (14), (15), (16), (22), (23), (26), (32), (41), (43), (44), (48), (52)
Windows® Embedded NavReady™ (C5C) Runtime (ESD)	(1), (3), (4), (14), (15), (16), (22), (23), (24), (26), (32), (38), (39), (40), (41), (44), (48), (52)
Windows® Embedded NavReady™ (C5F) Runtime (ESD)	(1), (3), (4), (14), (15), (16), (22), (23), (24), (26), (32), (37), (38), (39), (41), (44), (48), (52)
Windows® Embedded CE 6.0 Operating System Core Runtime	(1), (3), (4), (14), (15), (16), (22), (23), (26), (27), (33), (41), (44), (48), (52)
Windows® Embedded CE 6.0 Operating System Core Field Upgrade	(1), (2), (3), (4), (14), (15), (16), (22), (23), (26), (27), (33), (41), (44), (48), (52)
Windows® Embedded CE 6.0 Operating System Core PLUS Runtime	(1), (3), (4), (14), (15), (16), (22), (23), (26), (27), (33), (41), (44), (48), (52)
Windows® Embedded CE 6.0 Operating System Core PLUS Field Upgrade	(1), (2), (3), (4), (14), (15), (16), (22), (23), (26), (27), (33), (41), (44), (48), (52)
Windows® Embedded CE 6.0 Operating System Professional Runtime	(1), (3), (4), (14), (15), (16), (22), (23), (33), (35), (41), (44), (46), (47), (48), (49), (50), (51), (52), (53)
Windows® Embedded CE 6.0 Operating System Professional Field Upgrade	(1), (2), (3), (4), (14), (15), (16), (22), (23), (26), (33), (35), (41), (44), (46), (47), (48), (49), (50), (51), (52), (53)
Windows® Embedded CE 6.0 Operating System Runtime for Set Top Boxes	(1), (3), (4), (14), (15), (16), (22), (23), (26), (27), (33), (41), (43), (44), (48), (52)
Windows® Embedded CE 6.0 for Networked Projectors	(1), (3), (4), (14), (15), (16), (22), (23), (26), (27), (33), (34), (41), (44), (48), (52)
Windows® CE5.0 (C5G)	(1), (3), (4), (16), (22), (23), (26), (32), (41), (42), (44), (45), (47), (48), (49), (52), (53)
Windows® Embedded CE (C6G)	(1), (3), (4), (16), (22), (23), (26), (27), (33), (41), (42), (44), (45), (47), (48), (49), (50), (51), (52), (53)

The following ATs (formerly ALTs) apply to the Products (formerly Licensed Products) as indicated above and are in addition to terms of Company's Microsoft OEM Customer License Agreement for Embedded Systems ("Agreement"). Capitalized terms used below and not otherwise defined have the meaning set forth in the General Terms and Conditions of the Agreement. The applicable ATs shall supersede any inconsistent terms in the Agreement.

1. Eligibility

In order to obtain runtime licenses, Company must have

(a) previously obtained either the **Microsoft Windows CE Platform Builder Kit, version 3.0a**, **Microsoft Windows CE .NET Platform Builder, version 4.0**, **Microsoft Windows CE .NET Platform Builder, version 4.1**, **Microsoft Windows CE .NET Platform Builder, version 4.2**, **Microsoft Windows CE Platform Builder, Version 5.0**, or **Windows Embedded CE 6.0 Toolkit** and

(b) a valid, current Agreement.

2. Field Upgrade

Company may not license this Product unless Company has in effect a Microsoft OEM Customer License Agreement for Field Upgrades, and Company has acquired at least one Product runtime license for the purpose of accessing the Runtime Key. Each calendar month and in accordance with MS Distributor's instructions, Company shall report and pay MS Distributor the applicable amount for the combined total number of copies of MS Binaries downloaded as part of a Field Upgrade Image pursuant to section 2(e) of the Microsoft OEM Customer License Agreement for Field Upgrades, during the immediately preceding calendar month.

3. No License Terms Required

(a) Company is not required to provide License Terms with this Product.

(b) From time to time, MS and/or MSCORP may make Updates or Supplemental Code available for distribution with an Embedded System.

The license terms for that code may require that Company include License Terms with its Embedded System. In that case, if Company distributes that code, then Company must distribute those License Terms.

4. Agreement Section 2(b) Doesn't Apply

Notwithstanding anything to the contrary in the Agreement, section 2(b) of the Agreement does not apply to this Product.

5. No License to Distribute Pocket Word

The runtime license for this Product does not include a license to distribute the Pocket Word application.

6. License Included to Distribute Pocket Word

The runtime license for this Product does include a license to distribute the Pocket Word application.

7. No License to Distribute Microsoft WordPad

The runtime license for this Product does not include a license to distribute Microsoft WordPad.

8. License Included to Distribute Microsoft WordPad

The runtime license for this Product does include a license to distribute Microsoft WordPad.

9. No License to Distribute Microsoft WordPad or File Viewers

The runtime license for this Product does not include a license to distribute any of the following applications: Microsoft WordPad or any of the Microsoft File Viewers.

10. License Included to Distribute Microsoft WordPad, But Not Microsoft File Viewers

The runtime license for this Product does include a license to distribute Microsoft WordPad but does not include a license to distribute any of the Microsoft File Viewers.

11. License Included to Distribute Microsoft WordPad, and Microsoft File Viewers

The runtime license for this Product does include a license to distribute Microsoft WordPad and one or more of the Microsoft File Viewers.

12. Redistributables Distribution Restriction

The Deliverables for this Product include a folder labeled "REDISTRIBUTABLES". Company may distribute all of those files except the Microsoft File Viewers.

13. Redistributables Distribution

The Deliverables for this Product include a folder labeled "REDISTRIBUTABLES". Company may distribute all of those files.

14. Systems Management Server Client Software

(a) Company may include in Embedded System software or protocols that enable the Embedded System to connect to and access applications from a server. This includes the Systems Management Server client software and terminal services protocols (such as Remote Desktop Protocol or Independent Computer Architecture). If an Embedded System includes this software, then at any one time, a maximum of 10 devices may connect to, access and use services of the Product on the Embedded System solely for remote access (including connection sharing). The ten connection limit applies to devices that access the software indirectly through "multiplexing" or other software or hardware that pools connections. Company shall advise its End Users of this limit.

(b) Each End User must obtain any client access licenses required to connect to a server as described in this AT.

15. Server Message Block ("SMB")

Company may include in an Embedded System the Server Message Block protocol for file and print services. Any Embedded System that includes SMB must include:

- One 32-bit processor,
- No more than 512 MB RAM, and
- No more than 200 GB of shared storage.

Any such Embedded System must not include hot swap memory or clustering functions.

Also, a maximum of 10 devices at any one time may connect to, access and use the file and print services of the Product on the Embedded System. For the Core, Core PLUS, NavReady, C5G, C6G, and Networked Projectors Versions of this Product, no more than two devices may connect to, access and use the file services at any one time.

These connection limits apply to devices that access the software indirectly through “multiplexing” or other software or hardware that pools connections. Company shall advise its End Users of the limits in this AT.

16. ActiveSync and Windows Mobile Device Center

Company may obtain the appropriate ActiveSync files or Windows Mobile Device Center files (“Files”) for use with this Product. Company may distribute those Files solely to enable data synchronization between the Embedded System and an End User’s personal computer. Company must meet the following requirements.

(a) Company may only obtain and distribute the Files that are compatible with the Product.

- ActiveSync Version 3.1 is compatible with Windows CE 3.0 products.
- ActiveSync Version 3.5 is compatible with Windows CE 3.0, CE .NET 4.0, CE .NET 4.1 and CE .NET 4.2 products.
- ActiveSync Version 3.7 is compatible with Windows CE .NET 4.2, CE 5.0 and Windows Embedded NavReady products.
- ActiveSync Version 4.2 is compatible with Windows Embedded CE 6.0 products.
- ActiveSync Version 4.5 is compatible with Windows Embedded CE 6.0 products.
- Windows Mobile Device Center is compatible with Windows Embedded CE 6.0 products (for Windows Vista)

(b) Company shall obtain the Active Sync files from an MS Distributor. For Windows CE .NET 4.2 and CE 5.0 products, Company may download the ActiveSync files from ECE. ActiveSync Version 4.2, Active Sync Version 4.5 and Windows Mobile Device Center are included in Windows Embedded CE 6.0.

(c) Company shall distribute the Files on a Companion CD or via download.

(1) If Company distributes the Files on a Companion CD, Company must meet the following requirements:

(i) Company may either reproduce the files on its premises using Company employees, or order reproduction from an MS Distributor. When using an MS Distributor, Company must provide its master CD along with the CD label artwork, and Company must distribute the Companion CD in the form and packaging as received from the MS Distributor. Company must own or maintain effective licenses for any non-Microsoft software included on a Companion CD.

(ii) A Companion CD shall not include any MS logo, copyright or trademark on the media or on its packaging. The media label may identify the Files, e.g., “This [CD/DVD] contains Microsoft ActiveSync Version [number]” or “This [CD/DVD] contains Microsoft Windows Mobile Device Center Version [number]”

(iii) Company may either include the Companion CD in the Embedded System packaging or provide it on a standalone basis to End Users.

(2) If Company distributes the Files via download, then Company must clearly state the purpose of the Files and the Embedded Systems with which End Users may use them.

(d) Company shall not change, obscure or omit any Files. Company shall not transfer or copy any Files to any media (other than Companion CDs).

(e) Company is not required to include all language versions of the Files on the Companion CD. Company must, however, include all of the files for each language version of the Files that Company distributes.

(f) Company shall provide clear notice to each End User of the system requirements for the personal computers on which the End User will use the Files.

(g) Company is solely responsible for testing the Files with its Embedded Systems. MS has not conducted tests or quality reviews to ensure that the Files function as described in the Files display information, online help files, or otherwise, when used in conjunction with the Embedded System or an Image.

(h) Company represents and warrants that it owns all right, title and interest in the Company Binaries, and it has all necessary rights to authorize the MS Distributor to replicate them. Company shall defend, indemnify and hold harmless MS, its Suppliers and its affiliates, from and against any and all third party claims or demands, or any other liability or damages whatsoever arising from the replication, licensing, distribution, or use of the Company Software. If Company distributes the Files to an End User that already has the Files, then Company shall distribute those Files at no charge other than a reasonable charge for materials, shipping and handling costs.

17. No Distribution of Preview Files

Company may not include in the Image, nor distribute in any manner, any .NET Compact Framework Technology Preview files, as defined in the Deliverables, (“Preview Files”). Company should refer to the Deliverables documentation for instructions on limited permitted use of the Preview Files.

18. No Distribution of .NET Compact Framework Beta Files

The Product may include .NET Compact Framework Beta files. Company may not include those files in an Image or otherwise distribute them.

19. Microsoft Visual Studio .NET Professional, Trial Version

The Deliverables may include Microsoft Visual Studio .NET Professional, Trial Version. Company may use that software only in accordance with its End User License Terms.

20. No COAs for Microsoft® Windows® CE .NET Operating System For Embedded Systems, Version 4.0 Runtime

There are no COAs for this Product. Company may acquire and use the COAs for Microsoft® Windows® CE .NET Operating System For Embedded Systems, Version 4.1 Runtime for runtimes based on this Product.

21. No Deliverables

(a) Company has previously received the Deliverables for this Product. MS will not provide any additional copies under the Agreement.

(b) Company's rights to use the Deliverables will be governed by the applicable End User License Terms. Those rights may be effective during and after the term of this License Agreement.

22. eMbedded Visual

(a) The Deliverables for this Product include the following software tools:

- eMbedded Visual Tools 3.0 (eVT 3.0); or

- eMbedded Visual C++ (eVC++).

Company may only use these tools to create a software application that runs with this Product. Such use must be under the terms of the applicable End User License Terms.

(b) MS grants to Company a non-exclusive, limited, world-wide, royalty-free license to reproduce and install any eVT 3.0 or eVC++ application created by Company in accordance with the applicable End User License Terms. Company may distribute such applications with the MS Binaries.

23. Error Reporting Functions

If an Image includes the error reporting functions of this Product, then Company must ensure that those functions will operate only if the End User activates them. Company shall not enable those functions by default. Company may only implement those functions with MS' standard error report dialog. If the Embedded System does not include a user interface, then Company must use MS' standard error report dialog intended for a client device without a user interface.

24. GPS

This Product is designed solely for use in global positioning system (GPS) devices.

The Embedded System must:

(a) Have an integrated, hardware based, global positioning satellite radio signal receiver that is not removable by the End User.

(b) Be sold to the End User for use as a GPS handheld as one of its main functions.

25. No COAs

There are no COAs for this Product. Company still must report distribution of, and pay royalties for, this Product as required by this License Agreement.

26. Certain Features Not Included

The table below lists many features included in Windows CE Licensed Products. The name of this Licensed Product is at the top of one of the columns in the table below. Each feature marked with an "x" in that column is not included in Company's license for this Licensed Product.

Feature Category:		CE Core (all versions)	CE 5.0 Core Plus	NavReady (C5C)	NavReady (C5F)	CE 5.0 (C5G) and CE 5.0 for Set Top Boxes	CE 5.0 Pro	CE 6.0 Core Plus	CE 6.0 (C6G) and CE 6.0 for Set Top Boxes	CE 6.0 for Networked Projectors
General	ActiveSync (Inbox Sync)	x	x	x	x	x		x	x	x
	ActiveSync (Pocket Outlook Database Sync)	x	x	x	x	x		x	x	x
	AV Renderer Sample	x	x	x	x			x		
	AYGShell API Set	x	x	x	x	x		x		x
	Bluetooth LAP and Configuration Utility	x	x	x	x	x				
	Help	x	x	x	x			x		x
	Inbox	x	x	x	x	x		x	x	
	Pocket Outlook Object Model API	x	x	x	x	x		x	x	
	RAS/PPTP Server	x	x	x	x	x				
	Remote Desktop Protocol (RDP) and subcomponents	x	x	x	x	x		x	x	
	Standard SDK for Windows CE (AYG)	x	x	x	x	x		x	x	
Standard SDK for Windows Embedded CE (AYG)	x	x	x	x	x	x	x	x		

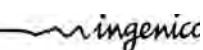

	Transcriber Handwriting Recognition Engine and Application and subcomponents	x	x	x	x	x		x	x	
	Windows Messenger	x	x	x	x			x		
	Windows Thin Client Shell	x	x	x	x	x		x	x	
	QQ Messenger	x	x	x	x	x	x	x		x
	Adobe Flash Lite	x	x	x	x	x	x	x		x
Viewers	Microsoft Excel Viewer	x	x	x	x	x	x	x		
	Microsoft Image Viewer	x	x	x	x	x	x	x		
	Microsoft PowerPoint Viewer	x	x	x	x	x	x	x		
	Microsoft Word Viewer	x	x	x	x	x	x	x		
Media	Streaming Media Playback	x	x	x	x			x		
	Windows Media Player (OCX)	x	x	x	x			x		
	Windows Media Player (WMP) application	x	x	x	x			x		
	WMA, WM V, and MP3 streaming	x	x	x	x			x		
	Windows Media Player OCX 7	x	x	x	x	x	x	x		
Other	Digital Video Recorder (DVR) Engine	x	x	x	x	x		x	x	x
	Graphical Shell (AYG shell, thin client)	x	x	x	x	x		x	x	x
	Internet Explorer and subcomponents	x	x	x	x			x		
	Internet Explorer (Pocket IE)	x	x	x	x			x	x	x
	Networked Media Device user interface (NMD UI)	x	x	x	x			x		
	Speech Recognition Engine	x	x	x	x	x		x	x	x
	Windows Network Projector and subcomponents	x	x	x	x	x	x	x	x	
	Web Services on Devices (WSD) and sub components	x	x	x	x	x	x			
Video over IP calling	x	x	x	x	x	x	x	x	x	
User Interface	SideShow	x		x				x	x	x
	Local Search for Devices	x	x			x	x	x	x	x
	MSN Direct Library	x	x	x		x	x	x	x	x
	Advanced Audio Distribution Profile (A2DP)	x	x	x		x	x	x	x	x
	Hands Free Profile (HFP)	x	x	x		x	x	x	x	x
	Audio/Video Remote Control Profile (AVRCP)	x	x	x		x	x	x	x	x
	Pairing Service	x	x			x	x	x	x	x
	Connection Manager	x	x			x	x	x		x
Silverlight for Windows Embedded	x	x	x	x	x	x	x		x	
Gestures	x	x	x	x	x	x	x		x	

This Document is Copyright © 2012 by INGENICO Group. INGENICO retains full copyright ownership, rights and protection in all material contained in this document. The recipient can receive this document on the condition that he will keep the document confidential and will not use its contents in any form or by any means, except as agreed beforehand, without the prior written permission of INGENICO. Moreover, nobody is authorized to place this document at the disposal of any third party without the prior written permission of INGENICO. If such permission is granted, it will be subject to the condition that the recipient ensures that any other recipient of this document, or information contained therein, is held responsible to INGENICO for the confidentiality of that information.

Care has been taken to ensure that the content of this document is as accurate as possible. INGENICO however declines any responsibility for inaccurate, incomplete or outdated information. The contents of this document may change from time to time without prior notice, and do not create, specify, modify or replace any new or prior contractual obligations agreed upon in writing between INGENICO and the user. INGENICO is not responsible for any use of this device, which would be non consistent with the present document.

All trademarks used in this document remain the property of their rightful owners

