



LCIE



Accreditation
N°1-1633
Scope available on
www.cofrac.fr

Template : December 14th, 2022

TEST REPORT

N°: 18348762-787335-B (FILE#4712035)

Version: 01

Subject Electromagnetic compatibility tests according to the standards:
FCC CFR 47 Part 15.225 & ANSI C63.10
RSS 210 & RSS-Gen

Issued to **INGENICO**
9 avenue de la gare – Rovaltain TGV BP25156
26958 - VALENCE Cedex 9
France

Apparatus under test

↪ Product	Payment terminal
↪ Trade mark	INGENICO
↪ Manufacturer	INGENICO
↪ Model under test	Desk/2600
↪ Serial number	230587317081327729816918
↪ FCCID	XKB-D2600CLW
↪ IC	2586D-D2600CLW

Conclusion See Test Program chapter

Test date	March 17, 2023 to March 20, 2023
Test location	LCIE Grenoble
FCC Test site	FR0008 - 197516 (MOI)
ISED Test site	6500A (MOI)
Sample receipt date	March 16, 2023
Composition of document	37 pages
Document issued on	April 26, 2023

Written by :
Akram HAKKARI
Tests operator

Approved by
Majid MOURZAGH
Technical manager

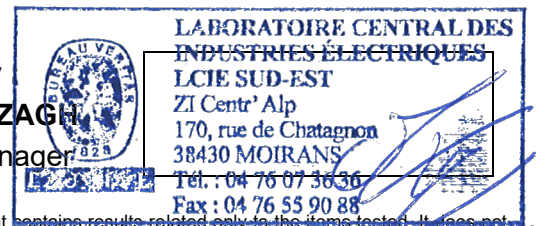

This document shall not be reproduced, except in full, without the written approval of the LCIE. This document contains results related only to the items tested. It does not imply the conformity of the whole production to the items tested. Unless otherwise specified or rule defined by the test method, the decision of conformity doesn't take into account the uncertainty of measures. This document doesn't anticipate any certification decision. The COFRAC accreditation attests the technical capability of the testing laboratory for the only tests covered by the accreditation. If some tests mentioned in this report are carried out outside the framework of COFRAC accreditation, they are indicated by the symbol

LCIE
Laboratoire Central des Industries Electriques
Une société Bureau Veritas

Z.I Centr'alp
170, Rue de Chatagnon
38430 Moirans
FRANCE

Tél. + 33 4 76 07 36 36
contact@lcie.fr
www.lcie.fr



PUBLICATION HISTORY

Version	Date	Author	Modification
01	April 26, 2023	Akram HAKKARI	Creation of the document

Each new edition of this test report replaces and cancels the previous edition. The control of the old editions of report is under responsibility of client.



L C I E

SUMMARY

1.	TEST PROGRAM	4
2.	EQUIPMENT UNDER TEST: CONFIGURATION (DECLARED BY PROVIDER).....	5
3.	OCCUPIED BANDWIDTH.....	11
4.	20DB EMISSION BANDWIDTH	14
5.	FREQUENCY TOLERANCE.....	17
6.	FIELD STRENGTH WITHIN THE BAND 13.110-14.010MHZ	20
7.	FIELD STRENGTH OUTSIDE OF THE BANDS 13.110-14.010 MHZ.....	27
8.	UNCERTAINTIES CHART	37



1. TEST PROGRAM

References

- 47 CFR Part 15.225 (2022)
- RSS 210 Issue 10
- RSS Gen Issue 5
- ANSI C63.10 (2013)

Radio requirement:

Clause - Test Description		Test result - Comments
Occupied Bandwidth	<i>ISED</i>	PASS
20dB Bandwidth	<i>FCC & ISED</i>	PASS
Frequency Tolerance	<i>FCC & ISED</i>	PASS
Field strength within the band [13.110-14.010] MHz	<i>FCC & ISED</i>	PASS
Field strength outside of the bands [13.110-14.010] MHz	<i>FCC & ISED</i>	PASS
Receiver Radiated Emissions	<i>ISED</i>	PASS(2)

This table is a summary of test report, see conclusion of each clause of this test report for detail.

(1) Limited program

(2) Testing covered the receive mode, and receiver spurious emissions are considered to be the same as transmitter.

PASS: EUT complies with standard's requirement

FAIL: EUT does not comply with standard's requirement

NA: Not Applicable

NP: Test Not Performed

2. EQUIPMENT UNDER TEST: CONFIGURATION (DECLARED BY PROVIDER)



2.1. HARDWARE IDENTIFICATION (EUT AND AUXILIARIES):

Equipment under test (EUT):

Model under test:	Desk/2600
Serial Number:	230587317081327729816918
	
	
Dimensions:	8cm x 6cm x 18cm (Length x Width x Height)
Type:	Table-Top

Power supply:

All test are performed with Supply 3 and battery worst case

Name	Type	Rating	Reference / Sn	Comments
Supply1	AC	100-240VAC 0.2A 50-60Hz OUTPUT 5V 1A 5W	PHIHONG AM05R-050CK	/
				
Supply2	AC	100-240VAC 0.2A 50-60Hz OUTPUT 5V 1A 5W	PHIHONG AM05x-050D	/
				
Supply3	AC	100-240VAC 50/60Hz 0.2A OUTPUT 5V 1A 5W	Ktec KSA-5L-050100D5	/
				
Supply4	Battery	3.7Vdc Li-Ion 500mAH /1.85Wh	Springower Technology Model 562542	/



L C I E

Inputs/outputs - Cable:

Access	Type	Length used (m)	Declared <3m	Shielded	Comments
Supply1	AC	1.2	Yes	No	/
Supply2	AC	1.2	Yes	No	/
Supply3	AC	1.2	Yes	No	/
RJ 45	Ethernet	3	/	/	/
USB	USB C	0.5	/	/	/
USB	USB B	3	/	/	/
USB	USB A	3	/	/	/

Auxiliary equipment used during test:

Type	Reference	Sn	Comments
LAPTOP	DELL E4750	/	/
ROUTER	ASUS RT-AC68U	/	/
USB C Adaptor	MAGIC BOX Eth/USB	230577317571324829797915	/



Equipment information (declaration of provider):

Type:	RFID		
Frequency band:	[13.553 to 13.567] MHz		
Number of Channel:	1		
Antenna Type:	Internal		
Transmit chains:	1		
Receiver chains:	1		
Operating temperature range:	T _{min} :	-10 °C	
	T _{nom} :	20°C	
	T _{max} :	60 °C	
Operating voltage:	V _{min} (85% Vnom):	85 VAC	
	V _{nom} :	230 VAC	
	V _{max} (115% Vnom):	276 VAC	

Antenna Characteristic			
Antenna reference	Gain (dBi)	Frequency Band (MHz)	Impedance(Ω)
PCB	0	13.56	50

Hardware information			
Highest internal frequency (PLL, Quartz, Clock, Microprocessor...):	F_{Highest}:	6000	MHz
Firmware (if applicable):	V:	150051	
Software (if applicable):	V:	031600	

2.2. RUNNING MODE

Test mode	Description of test mode
Test mode 1	Permanent emission with modulation on a fixed channel in the data rate that produced the highest power. Tests are performed with "TAG".
Test mode 2	Permanent reception

Test	Running mode
Occupied Bandwidth	Test mode 1
20dB Emission Bandwidth	Test mode 1
Frequency Tolerance	Test mode 1
Field strength within the band 13.110-14.010MHz	Test mode 1
Field strength outside of the bands 13.110-14.010 MHz	Test mode 1
Receiver Radiated Emissions	Test mode 2 (1)

(1) The test can't be performed because the transmitter and receiver are operating at the same frequency and the transmitter cannot be switched off as the carrier is used as receiver injection signal

2.3. EQUIPMENT LABELLING

Label
 <p>The image shows a white equipment label for an ingenico device. The label contains the following information: <ul style="list-style-type: none"> Brand: ingenico PN: TCD70813277A SN: 230587317081327729816918 Product: Desk/2600 CL/WI-FI IMEI: (partially visible) Wifi: 101EDA5A1EA5 QR code with number 08 Made in: Vietnam HVN: DES26AA1-AA02 Rating: 5V --- 1.0A CE mark and a crossed-out wheeled bin symbol. </p>

2.4. EQUIPMENT MODIFICATIONS DURING THE TESTS

None



2.5. FIELD STRENGTH CALCULATION

The field strength is calculated by adding the Antenna Factor and Cable Factor, and subtracting the Amplifier Gain (if any) from the measured reading. The basic equation with a sample calculation is as follow:

$$FS = RA + AF + CF - AG$$

Where:

FS = Field Strength

RA = Receiver Amplitude

AF = Antenna Factor

CF = Cable Factor

AG = Amplifier Gain

Example:

Assume a receiver reading of 52.5dB μ V is obtained. The antenna factor of 7.4 and a cable factor of 1.1 are added. The amplifier gain of 29dB is subtracted, giving a field strength of 32 dB μ V/m.

$$FS = 52.5 + 7.4 + 1.1 - 29 = 32 \text{ dB}\mu\text{V/m}$$

The 32 dB μ V/m value can be mathematically converted to its corresponding level in μ V/m.

$$\text{Level in } \mu\text{V/m} = \text{Common Antilogarithm } [(32\text{dB}\mu\text{V/m})/20] = 39.8 \mu\text{V/m}$$

2.6. TEST DISTANCE EXTRAPOLATION – FCC/ISED

The field strength is extrapolated to the new measurement distance using formula from FCC Part15.31 (f) and §6.5-6.6 RSS-GEN:

Below 30MHz,

$$FS_{\text{limit}} = FS_{\text{max}} - 40 \log \left(\frac{d_{\text{limit}}}{d_{\text{measure}}} \right)$$

Above 30MHz,

$$FS_{\text{limit}} = FS_{\text{max}} - 20 \log \left(\frac{d_{\text{limit}}}{d_{\text{measure}}} \right)$$

Where:

FS_{limit} is the calculation of field strength at the limit distance, expressed in dB μ V/m

FS_{max} is the measured field strength, expressed in dB μ V/m

d_{measure} is the distance of the measurement point from the EUT

d_{limit} is the reference limit distance

2.7. CALIBRATION DATE

The calibration intervals are extended at 12+2 months. This extended interval is based on the fact that there is sufficient calibration data to statistically establish a trend or based on experience of use of the test equipment to assure good measurement results for a longer period.

3. OCCUPIED BANDWIDTH

3.1. TEST CONDITIONS

Date of test : March 20, 2023
Test performed by : Akram HAKKARI
Relative humidity (%) : 30
Ambient temperature (°C) : 21

3.2. TEST SETUP

The Equipment Under Test is installed in a climatic chamber.
Measurement is performed with a spectrum analyzer in radiated method.

The EUT is turned ON, the center frequency of the spectrum analyzer is set to the fundamental frequency. The captured power is measured and recorded; the measurement is repeated until all frequencies required were complete.

Test Procedure:

- RSS-Gen Issue 5 § 6.7
 - RBW used in the range of 1% to 5% of the anticipated emission bandwidth
 - Set the video bandwidth (VBW) $\geq 3 \times$ RBW.
 - Detector = Peak.
 - Trace mode = Max Hold.
 - Sweep = Auto couple.
 - Allow the trace to stabilize.
 - OBW 99% function of spectrum analyzer used

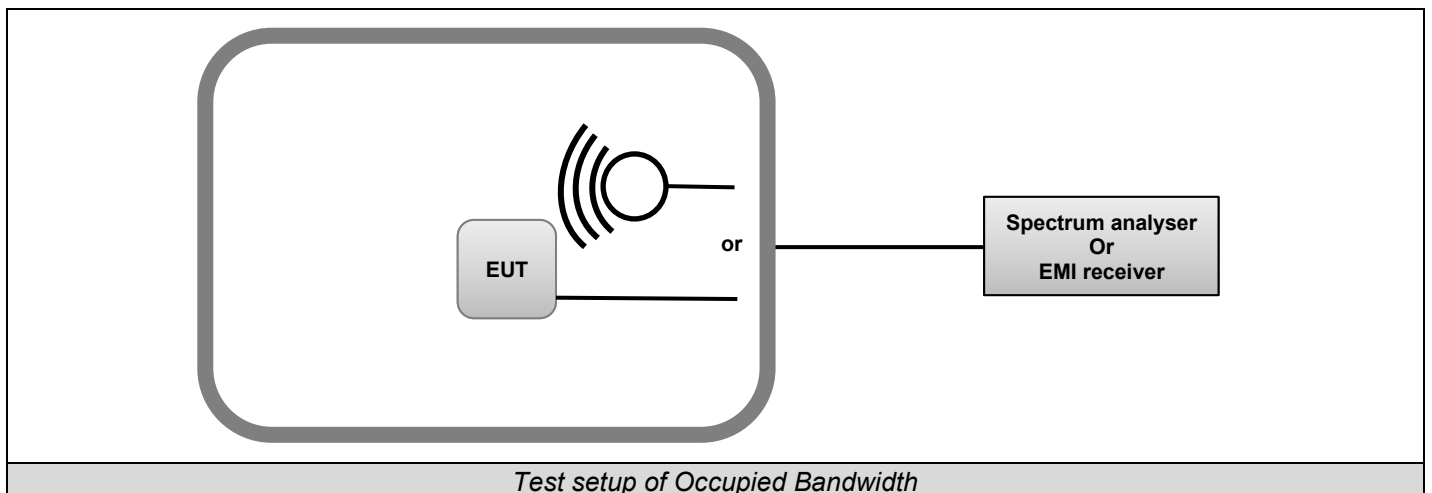

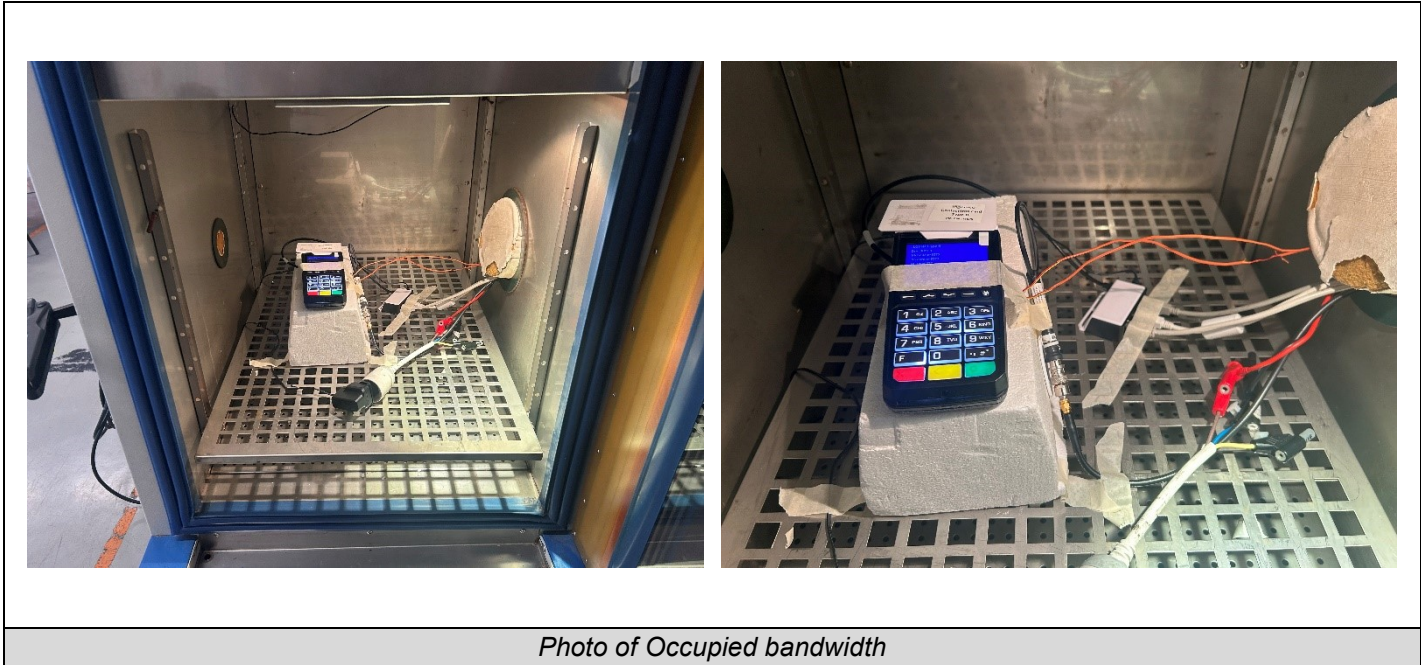

3.3. LIMIT

None

3.4. TEST EQUIPMENT LIST

TEST EQUIPMENT USED					
Description	Manufacturer	Model	Identifier	Cal_Date	Cal_Due
AC source 1kW	KEYSIGHT	AC6802A	A7042305		
Antenna Loop (near field)	ELECTRO-METRICS	EM-6993	C2040215	09/22	09/25
Attenuator 10dB	AEROFLEX	_	A7122267	08/21	08/23
Cable SMA 2m	_	6GHz	A5329637	05/22	05/24
Climatic chamber	BIA CLIMATIC	CL 6-25	D1022117	01/23	01/25
Data Logger (CEM1)	AGILENT	34970A	A6440083	11/20	03/23
Multimeter - CEM	FLUKE	87	A1240251	03/21	03/23
Spectrum Analyzer 9kHz - 6GHz	ROHDE & SCHWARZ	FSL6	A2642020	10/22	10/24
Thermo-hygrometer (PM1/2/3)	KIMO	HQ 210	B4206022	01/21	01/23

Note: In our quality system, the test equipment calibration due is more & less 2 months

3.5. DIVERGENCE, ADDITION OR SUPPRESSION ON THE TEST SPECIFICATION

None

3.6. RESULTS

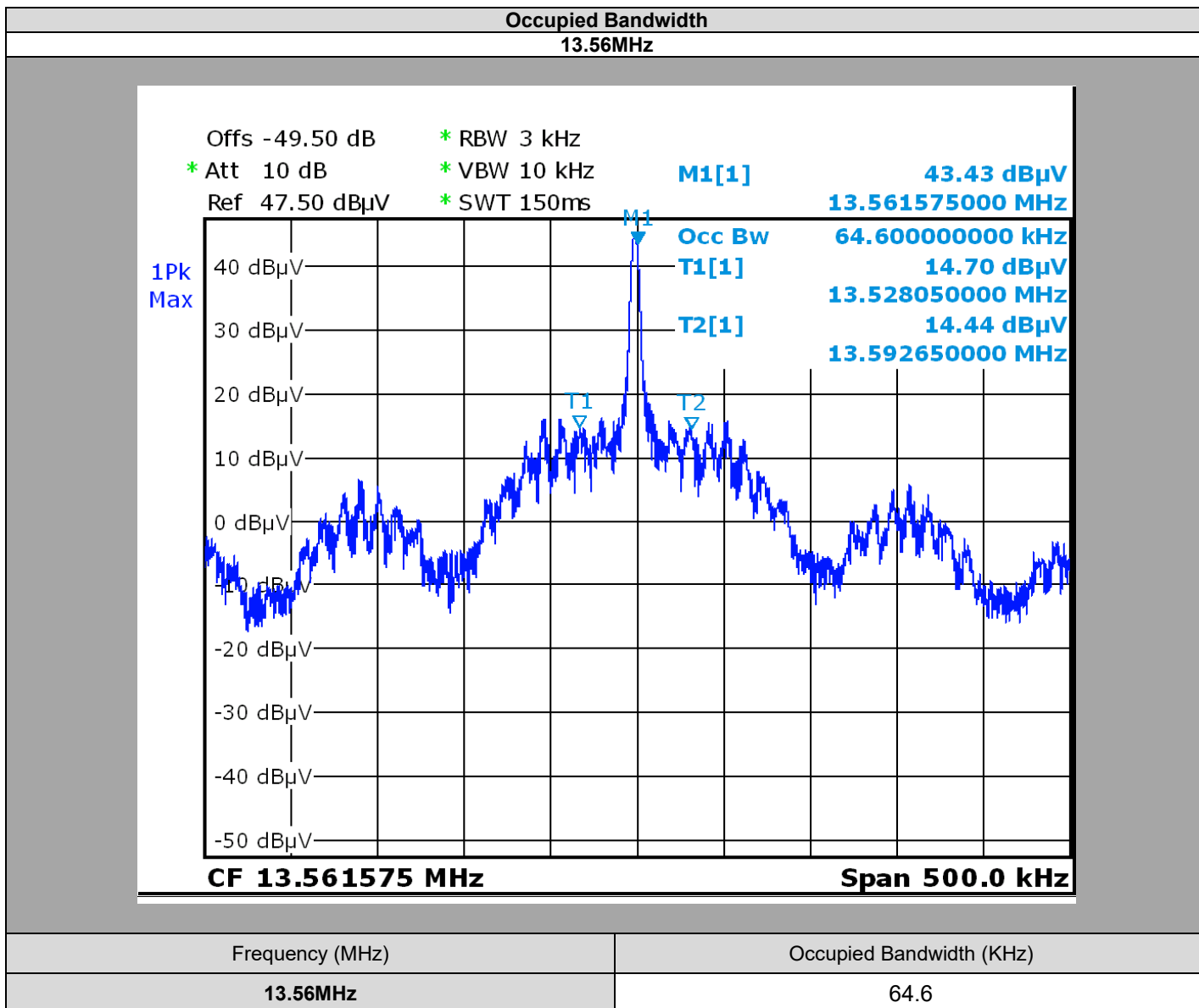

3.7. CONCLUSION

Occupied Channel Bandwidth measurement performed on the sample of the product **Desk/2600**, Sn: **230587317081327729816918**, in configuration and description presented in this test report, show levels **compliant** to the **RSS-GEN** limits.

4. 20dB EMISSION BANDWIDTH

4.1. TEST CONDITIONS

Date of test : March 20, 2023
 Test performed by : Majid MOURZAGH
 Relative humidity (%) : 30
 Ambient temperature (°C) : 21

4.2. TEST SETUP

The Equipment Under Test is installed in a climatic chamber.
 Measurement is performed with a spectrum analyzer in radiated method.

Test Procedure:

ANSI C63.10 § 6.9.2:

The EUT is turn ON; levels have been corrected to be in compliant with the Peak Output Power measured; and using the MaxHold function, the frequency separation of two frequencies that were attenuated 20dB from the Peak Output Power level. A delta marker is used to measure the frequency difference as the emission bandwidth.

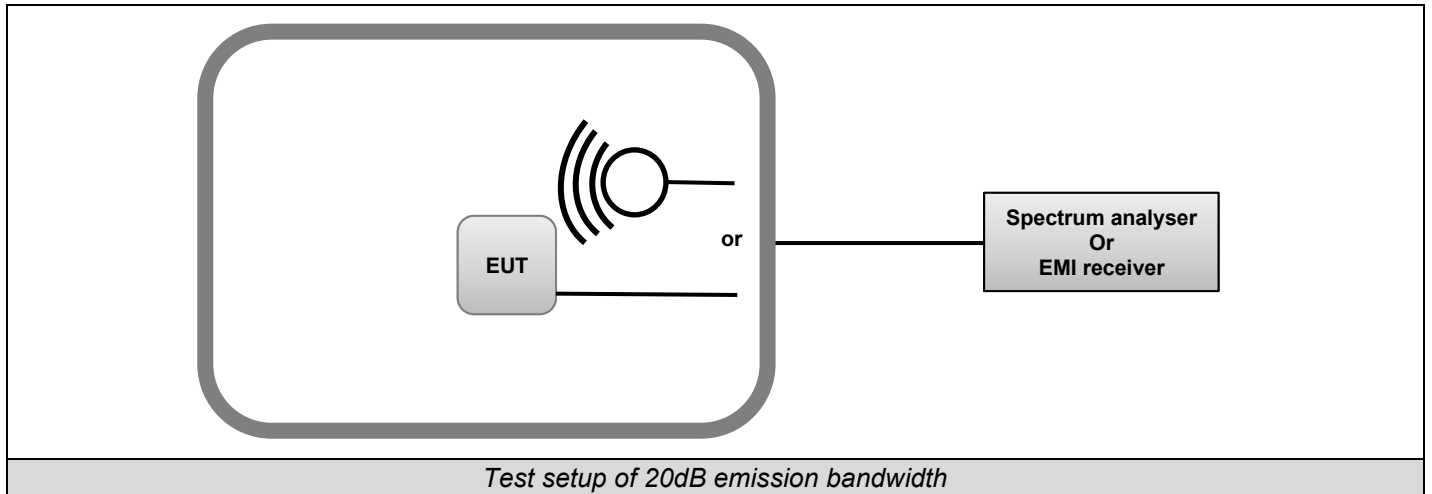

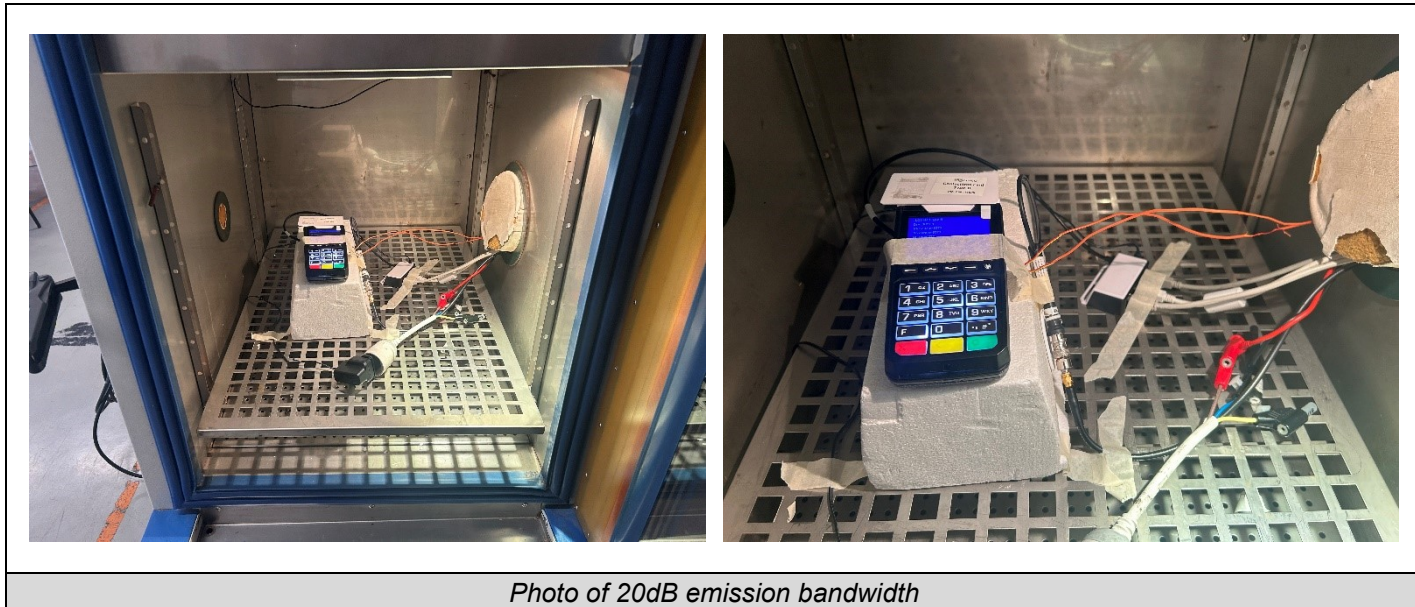

4.3. LIMIT

No Limit

4.4. TEST EQUIPMENT LIST

TEST EQUIPMENT USED					
Description	Manufacturer	Model	Identifier	Cal_Date	Cal_Due
AC source 1kW	KEYSIGHT	AC6802A	A7042305		
Antenna Loop (near field)	ELECTRO-METRICS	EM-6993	C2040215	09/22	09/25
Attenuator 10dB	AEROFLEX	-	A7122267	08/21	08/23
Cable SMA 2m	-	6GHz	A5329637	05/22	05/24
Climatic chamber	BIA CLIMATIC	CL 6-25	D1022117	01/23	01/25
Data Logger (CEM1)	AGILENT	34970A	A6440083	11/20	03/23
Multimeter - CEM	FLUKE	87	A1240251	03/21	03/23
Spectrum Analyzer 9kHz - 6GHz	ROHDE & SCHWARZ	FSL6	A2642020	10/22	10/24
Thermo-hygrometer (PM1/2/3)	KIMO	HQ 210	B4206022	01/21	01/23

Note: In our quality system, the test equipment calibration due is more & less 2 months

4.5. DIVERGENCE, ADDITION OR SUPPRESSION ON THE TEST SPECIFICATION

None



4.6. RESULTS

Frequency (MHz)	20 dB Bandwidth (kHz)
13.56	2.683

Graph

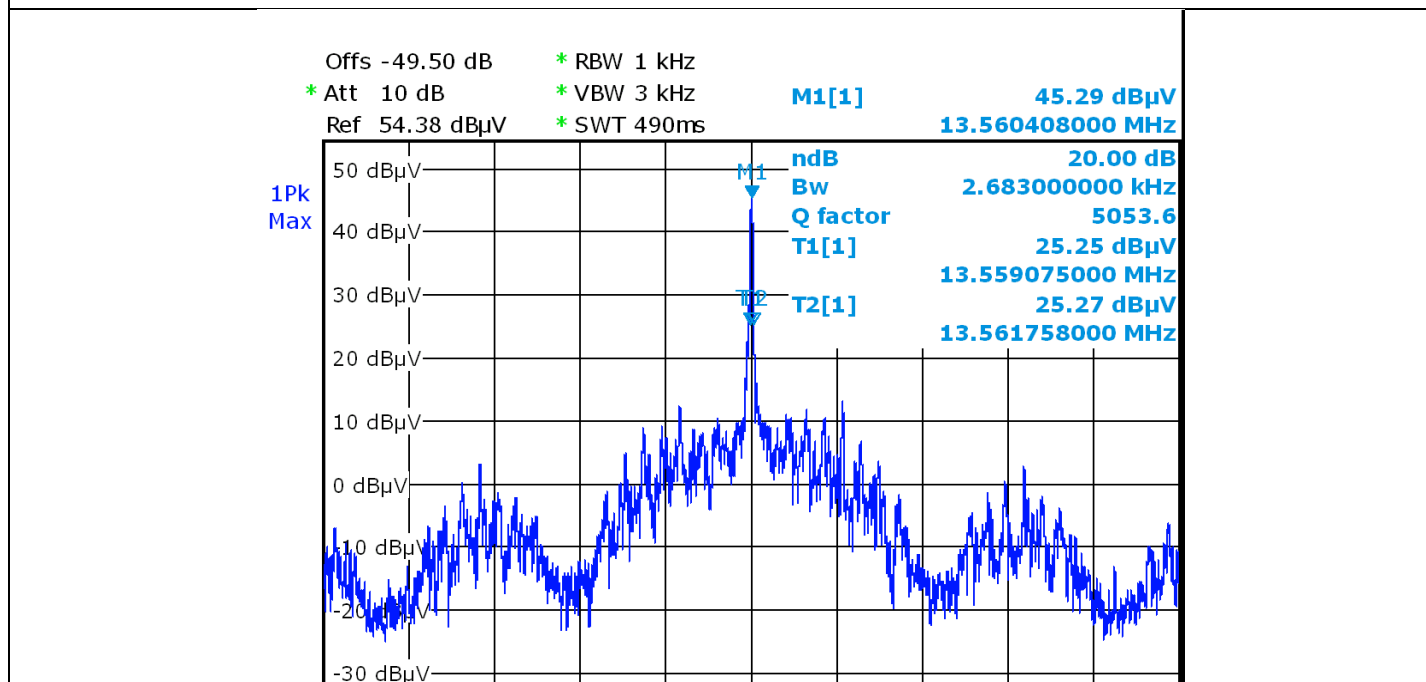

4.7. CONCLUSION

20dB Emission Bandwidth measurement performed on the sample of the product **Desk/2600**, Sn: **230587317081327729816918**, in configuration and description presented in this test report, show levels **compliant** to the **47 CFR PART 15.225 & RSS 210** limits.

5. FREQUENCY TOLERANCE

5.1. TEST CONDITIONS

Date of test : March 20, 2023
Test performed by : Akram HAKKARI
Relative humidity (%) : 30
Ambient temperature (°C) : 21

5.2. TEST SETUP

The Equipment Under Test is installed in a climatic chamber.
Measurement is performed with a spectrum analyzer in radiated method.

Test Procedure:

ANSI C63.10 § 6.8

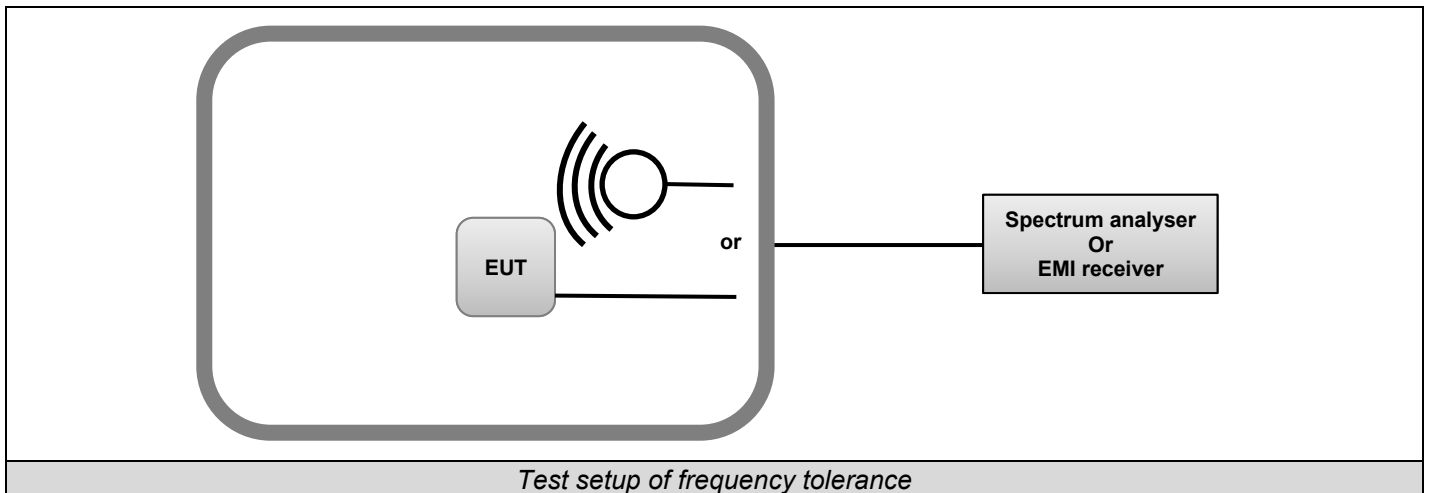

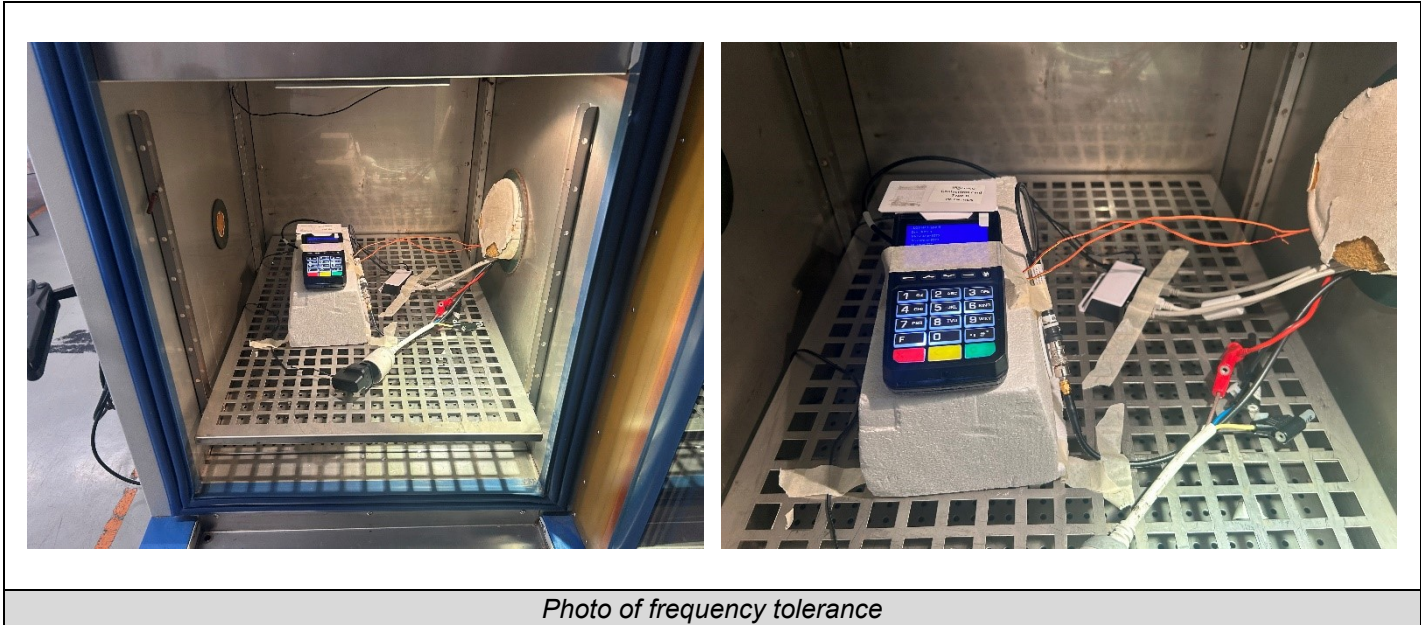

5.3. LIMIT

±0.01% (± 100ppm)

5.4. TEST EQUIPMENT LIST

TEST EQUIPMENT USED					
Description	Manufacturer	Model	Identifier	Cal_Date	Cal_Due
AC source 1kW	KEYSIGHT	AC6802A	A7042305		
Antenna Loop (near field)	ELECTRO-METRICS	EM-6993	C2040215	09/22	09/25
Attenuator 10dB	AEROFLEX	—	A7122267	08/21	08/23
Cable SMA 2m	—	6GHz	A5329637	05/22	05/24
Climatic chamber	BIA CLIMATIC	CL 6-25	D1022117	01/23	01/25
Data Logger (CEM1)	AGILENT	34970A	A6440083	11/20	03/23
Multimeter - CEM	FLUKE	87	A1240251	03/21	03/23
Spectrum Analyzer 9kHz - 6GHz	ROHDE & SCHWARZ	FSL6	A2642020	10/22	10/24
Thermo-hygrometer (PM1/2/3)	KIMO	HQ 210	B4206022	01/21	01/23

Note: In our quality system, the test equipment calibration due is more & less 2 months

5.5. DIVERGENCE, ADDITION OR SUPPRESSION ON THE TEST SPECIFICATION

None



5.6. RESULTS

EUT activation:	Startup					
Voltage:	Vnom					
Temperature:	0°C	10°C	20°C	30°C	40°C	50°C
Frequency (MHz)	13.5603817	13.5603799	13.5604107	13.5604078	13.5603632	13.5603904
Frequency Drift (%)	0.0028%	0.0028%	0.0030%	0.0030%	0.0027%	0.0029%
EUT activation:	2min					
Voltage:	Vnom					
Temperature:	0°C	10°C	20°C	30°C	40°C	50°C
Frequency (MHz)	13.5603817	13.5603799	13.5604124	13.5603187	13.5603595	13.5604013
Frequency Drift (%)	0.0028%	0.0028%	0.0030%	0.0024%	0.0027%	0.0030%
EUT activation:	5min					
Voltage:	Vnom					
Temperature:	0°C	10°C	20°C	30°C	40°C	50°C
Frequency (MHz)	13.5603835	13.560378	13.5604052	13.5604223	13.5603631	13.5604177
Frequency Drift (%)	0.0028%	0.0028%	0.0030%	0.0031%	0.0027%	0.0031%
EUT activation:	10min					
Voltage:	Vnom					
Temperature:	0°C	10°C	20°C	30°C	40°C	50°C
Frequency (MHz)	13.5603835	13.5606253	13.5604014	13.5606133	13.5603795	13.5604413
Frequency Drift (%)	0.0028%	0.0046%	0.0030%	0.0045%	0.0028%	0.0033%

Temperature	Tnom		
Voltage:	Vmin	Vnom	Vmax
Frequency (MHz)	13.56041235	13.56041069	13.56040711
Frequency Drift (%)	0.0030%	0.0030%	0.0030%

5.7. CONCLUSION

Frequency tolerance measurement performed on the sample of the product **Desk/2600**, Sn: **230587317081327729816918**, in configuration and description presented in this test report, show levels **compliant** to the **47 CFR PART 15.225 & RSS 210** limits.



6. FIELD STRENGTH WITHIN THE BAND 13.110-14.010MHZ

6.1. TEST CONDITIONS

Date of test : March 17, 2023
Test performed by : Akram HAKKARI
Relative humidity (%) : 37
Ambient temperature (°C) : 21

6.2. TEST SETUP

The Equipment Under Test is installed **on an Open Area Test Site..**
Measurement is performed with a spectrum analyzer in **radiated method.**

Test Procedure:

ANSI C63.10

The EUT is placed **on an open area test site.** Distance between measuring antenna and the EUT is **10m.** Test is performed in parallel, perpendicular, and ground parallel axis with a loop antenna below 30MHz. Measurement bandwidth was 9kHz between 150kHz & 30MHz. The level has been maximized by the turntable rotation of 360 degrees range on all axis of EUT used in normal configuration. Antenna height search was performed from 1 to 4m. The EUT is place at **0.8m.**

Ambient temperature: 16.3 °C
Relative humidity: 29 %

Note: It is impracticable to carry out tests under normal condition as specified in standard.

When measurement with test fixture is used, the power level calibration of the spectrum analyzer shall then be related to the power level or field strength measured with temperature during OATS measure taking in consideration in climatic chamber. The calculation will be used to calculate the absolute level of the sideband power.

Frequency band 13.110-14.010MHz

Following plots show radiated emission level in the frequency band 13.110-14.010MHz with a RBW of 9kHz and a quasi-peak detector. The graphs are obtained with a measuring receiver.



L C I E

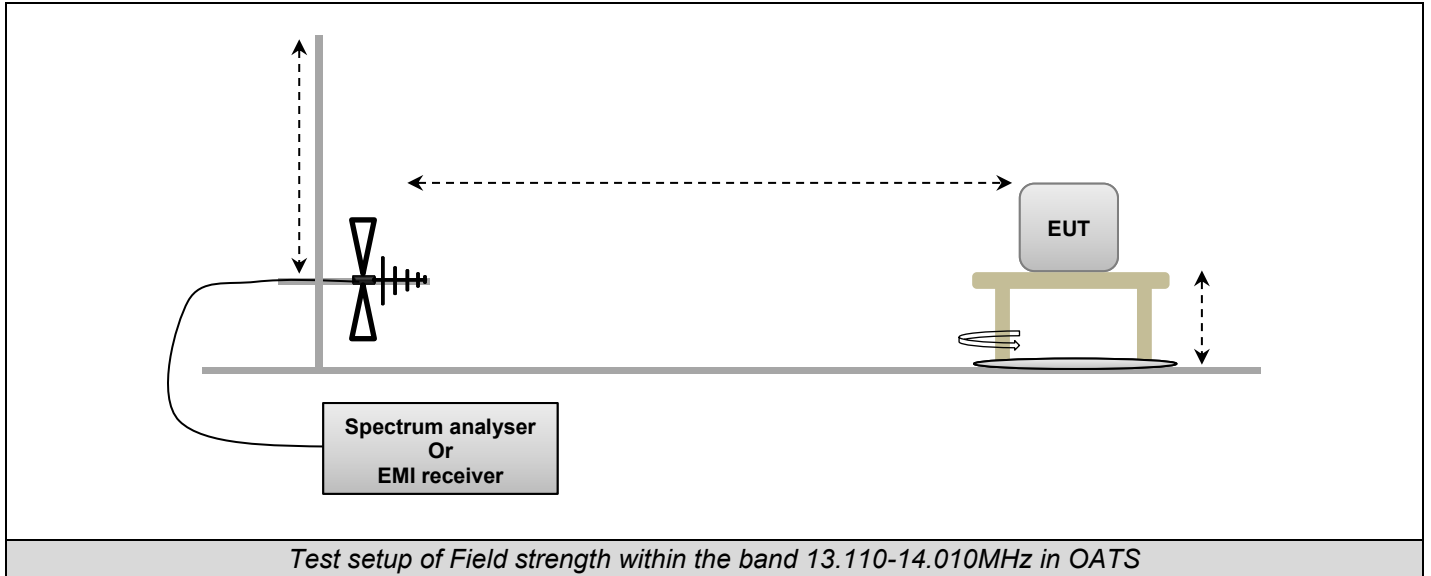
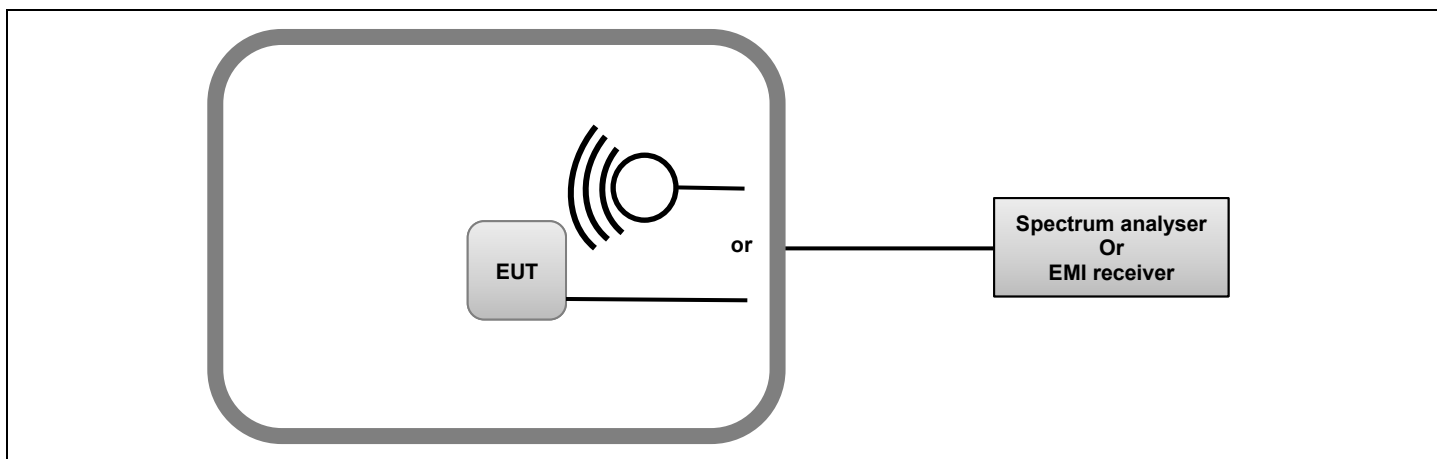



Photo of Field strength within the band 13.110-14.010MHz in OATS



Test setup of Field strength within the band 13.110-14.010MHz in Climatic Chamber



Photo of Field strength within the band 13.110-14.010MHz in Climatic Chamber



6.3. LIMIT

Frequency (MHz)	Field strength ($\mu\text{V/m}$) @30m	Field strength ($\text{dB}\mu\text{V/m}$) @30m
13.553-13.567	15 848	84.0
13.410-13.553 13.567-13.710	334.0	50.5
13.110-13.410 13.710-14.010	106.0	40.5
Below 13.110MHz Above 14.010MHz	30.0	29.5

6.4. TEST EQUIPMENT LIST

TEST EQUIPMENT USED					
Description	Manufacturer	Model	Identifier	Cal_Date	Cal_Due
Antenna Mat (OATS)	ETS Lingren	2071-2	F2000392		
Cable (OATS)	—	1GHz	A5329623	09/22	09/23
Emission Cable	RADIALEX		A5329061	08/22	08/23
OATS	—	—	F2000409	07/22	07/23
RADIO ERP_EIRP	LCIE SUD EST	v4	L2000034		
Receiver 20Hz – 8GHz	ROHDE & SCHWARZ	ESU8	A2642019	03/23	03/25
Rehausse Table C1/OATS	LCIE	—	F2000512		
Table C1/OATS	LCIE	—	F2000445		
Thermo-hygrometer (PM1/2/3)	KIMO	HQ 210	B4206022	01/21	05/23
Turntable (OATS)	ETS Lingren	Model 2187	F2000403		
Turntable / Mast controller (OATS)	ETS Lingren	Model 2066	F2000372		
Antenna loop	ELECTRO-METRICS	EM-6879	C2040294	08/22	08/24
AC source 1kW	KEYSIGHT	AC6802A	A7042305		
Antenna Loop (near field)	ELECTRO-METRICS	EM-6993	C2040215	09/22	09/25
Attenuator 10dB	AEROFLEX	—	A7122267	08/21	08/23
Cable SMA 2m	—	6GHz	A5329637	05/22	05/24
Climatic chamber	BIA CLIMATIC	CL 6-25	D1022117	01/23	01/25
Multimeter - CEM	FLUKE	87	A1240251	03/21	03/23
Spectrum Analyzer 9kHz - 6GHz	ROHDE & SCHWARZ	FSL6	A2642020	10/22	10/24
Data Logger (CEM1)	AGILENT	34970A	A6440083	11/20	03/23

Note: In our quality system, the test equipment calibration due is more & less 2 months

6.5. DIVERGENCE, ADDITION OR SUPPRESSION ON THE TEST SPECIFICATION

None

6.6. RESULTS

6.6.1. Results on OATS test conditions:

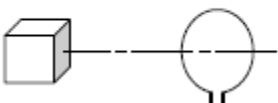
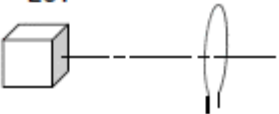
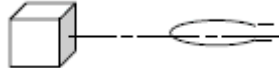
Frequency (MHz)	QPeak Limit (dB μ V/m) @ 30m	QPeak (dB μ V/m) @ 30m	Margin (Mes-Lim) (dB)	Angle Table (deg)	Pol Ant.	Ht Ant. (cm)	Correc. Factor (dB)	Comments
13.56	84.0	45.3	-38.7	180	0	120	36.5	/
<div style="display: flex; justify-content: space-around; align-items: flex-end;"> <div style="text-align: center;"> <p>EUT</p>  <p>Parallel Axis (0°)</p> </div> <div style="text-align: center;"> <p>EUT</p>  <p>Perpendicular Axis (90°)</p> </div> <div style="text-align: center;"> <p>EUT</p>  <p>Ground Parallel Axis (180°)</p> </div> </div>								

Note: Measure have been done at 10m distance and corrected according to requirements of 15.209.e) ($M@30m = M@10m - 19.1dB$)



L C I E

6.6.2. Results under Normal condition

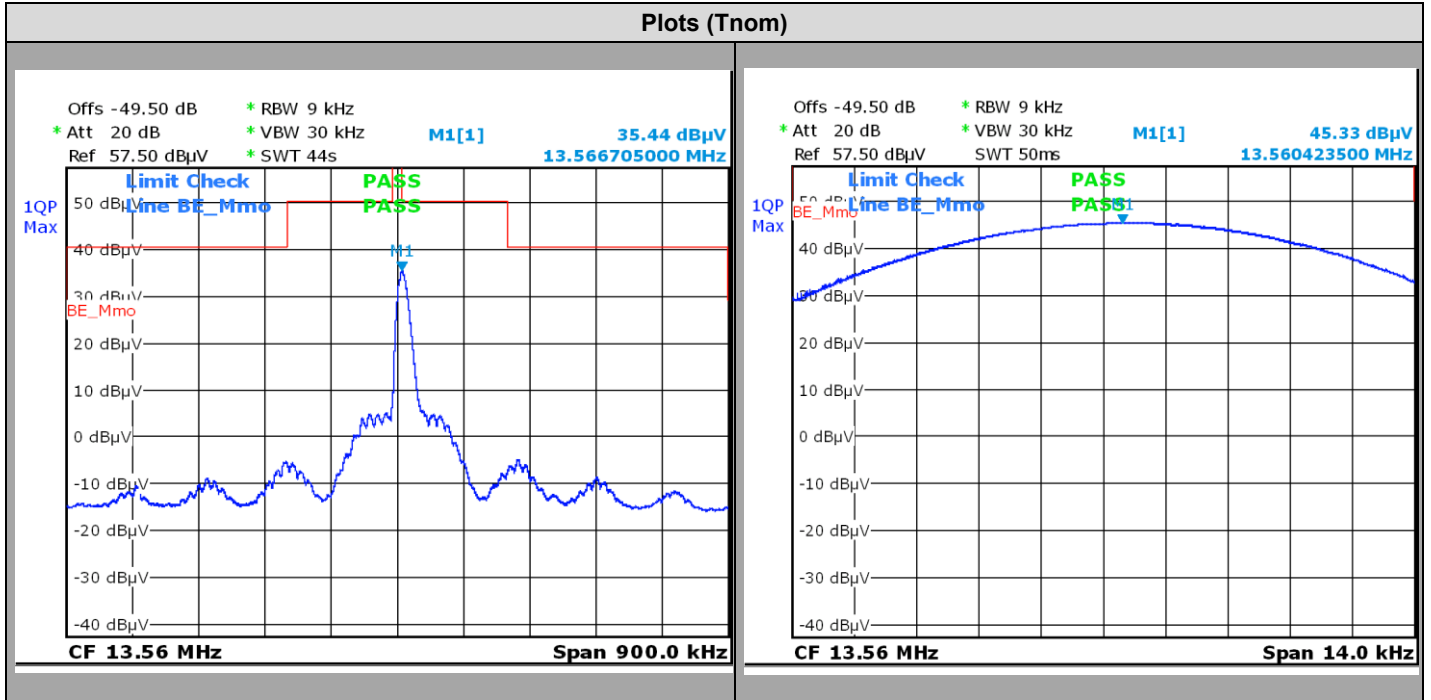

6.7. CONCLUSION

Field strength within the band 13.110-14.010MHz measurement performed on the sample of the product **Desk/2600**, Sn: **230587317081327729816918**, in configuration and description presented in this test report, show levels **compliant** to the **47 CFR PART 15.225 & RSS 210** limits.



7. FIELD STRENGTH OUTSIDE OF THE BANDS 13.110-14.010 MHz

7.1. TEST CONDITIONS

Date of test : March 17, 2023
 Test performed by : Akram HAKKARI
 Relative humidity (%) : 37
 Ambient temperature (°C) : 21

7.2. TEST SETUP

Test procedure:

ANSI C63.10 & FCC Part 15 subpart C

Following frequency ranges, test setup parameters are different and specified in this table:

Frequency range:	9kHz to 30MHz	
Test:	Pre-Characterization	Qualification
Antenna Polarization:	Parallel, Perpendicular and Ground parallel	
Antenna Height:	1m	1m
Antenna Type:	Loop	
RBW Filter:	200Hz below 150kHz / 9kHz above 150kHz	
Maximization:	Turntable rotation of 360 degrees range	
EUT height:	0.8m	0.8m
Test site:	Full Anechoic Chamber	Open Aera Test Site
Distance EUT - Antenna:	3m	10m
Detector:	Peak	QPeak

Frequency range:	30MHz to 1GHz	
Test:	Pre-Characterization	Qualification
Antenna Polarization:	Horizontal and Vertical	
Antenna Height:	Centered on EUT (§6.6.5 ANSI C63-10)	Varied from 1m to 4m
Antenna Type:	Biconical & Bi-Log	
RBW Filter:	120kHz	
Maximization:	Turntable rotation of 360 degrees range	
EUT height:	1.5m	0.8m
Test site:	Full Anechoic Chamber	Open Aera Test Site
Distance EUT - Antenna:	3m	10m
Detector:	Peak	QPeak



L C I E

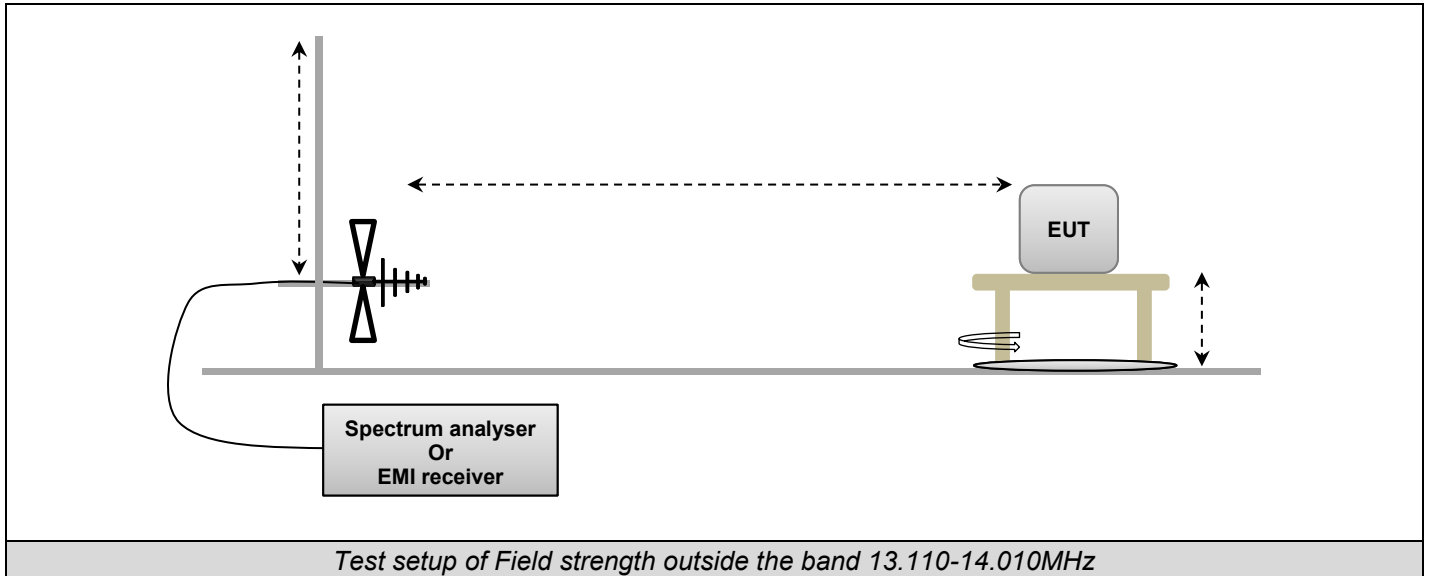

Same setup is used in semi anechoic chamber during pre-characterization, with a distance of 3m between EUT and antenna.

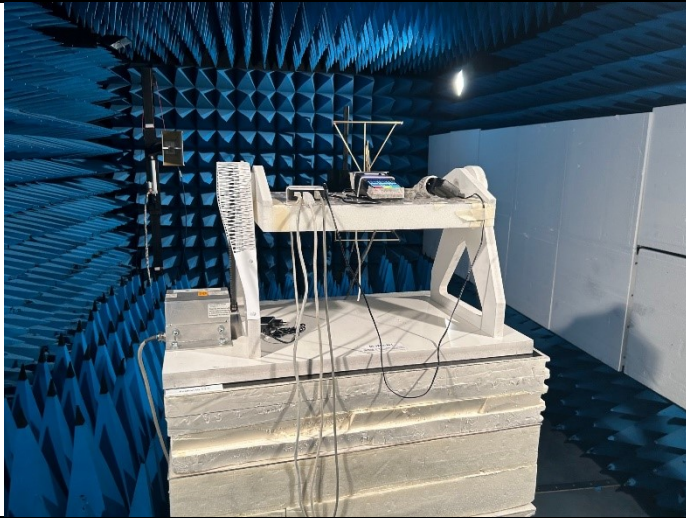

Axis XY on FAR

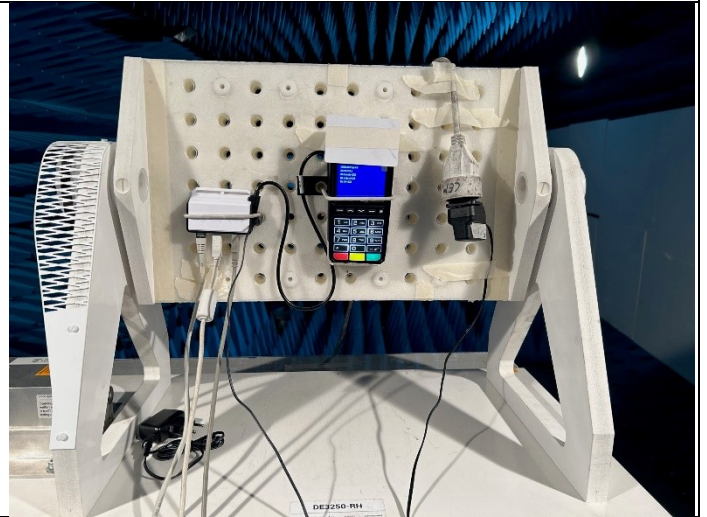
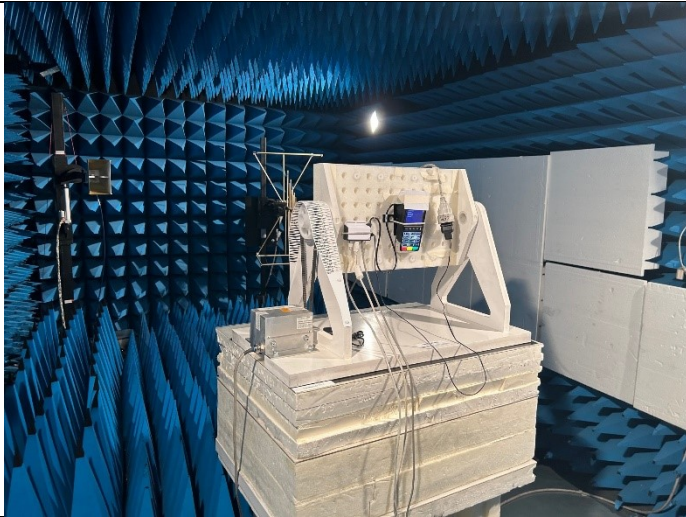

Axis Z on FAR

Photo of Field strength outside the band 13.110-14.010MHz on FAR



L C I E



Photo of Field strength outside the band 13.110-14.010MHz in OATS



7.3. LIMIT

Measure at 300m		
Frequency range	Level	Detector
9kHz-490kHz	67.6dB μ V/m /F(kHz)	QPeak
Measure at 30m		
Frequency range	Level	Detector
490kHz-1.705MHz	87.6dB μ V/m /F(kHz)	QPeak
1.705MHz-30MHz	29.5dB μ V/m	QPeak
Measure at 3m		
Frequency range	Level	Detector
30MHz to 88MHz	40dB μ V/m	QPeak
88MHz to 216MHz	43.5dB μ V/m	QPeak
216MHz to 960MHz	46B μ V/m	QPeak
960MHz to 1000MHz	54dB μ V/m	QPeak
Above 1000MHz	74dB μ V/m	Peak
	54dB μ V/m	Average



LCIE

7.4. TEST EQUIPMENT LIST

TEST EQUIPMENT USED					
Description	Manufacturer	Model	Identifier	Cal_Date	Cal_Due
Amplifier 10MHz - 18GHz	LCIE SUD EST	–	A7102082	05/22	05/24
Antenna Bi-log	AH System	SAS-521-7	C2040180	02/21	02/23
Antenna horn 18GHz	EMCO	3115	C2042029	03/22	03/25
Antenna loop	ELECTRO-METRICS	EM-6879	C2040294	08/22	08/24
BAT EMC	NEXIO	v3.21.0.32	L1000115		
Cable 0.75m	-	18GHz	A5329900	08/22	08/24
Comb EMR HF	YORK	CGE01	A3169114		
CONTROLLER	INNCO	CO3000	D3044034		
Filtre 0.8GHz-18GHz	PASTERNAK	PE87FL1018	A7484075	12/22	12/24
Multimeter - CEM	FLUKE	189	A1240171	09/21	09/23
Rehausse Table C3	LCIE	–	F2000511		
Rehausse Table C3	LCIE	–	F2000507		
Semi-Anechoic chamber #3 (BF)	SIEPEL	–	D3044017_BF	04/22	04/25
Semi-Anechoic chamber #3 (VSWR)	SIEPEL	–	D3044017_VSWR	04/22	04/25
SMA Cable 18GHz 0.5m	TELEDYNE	18GHz	A5330059	02/23	02/24
SMA Cable 18GHz 0.5m	TELEDYNE	18GHz	A5330060	02/23	02/24
SMA Cable 18GHz 0.6m	TELEDYNE	18GHz	A5330055	02/23	02/24
SMA Cable 18GHz 3.5m	TELEDYNE	18GHz	A5330058	02/23	02/24
SMA Cable 18GHz 6m	TELEDYNE	18GHz	A5330057	02/23	02/24
Spectrum analyzer	ROHDE & SCHWARZ	FSU 26	A4060058	09/21	09/23
Table C3	LCIE	–	F2000461		
Thermo-hygrometer (PM1/2/3)	KIMO	HQ 210	B4206022	01/21	05/23
TILT	INNCO	TILT	D3044033		
Turntable chamber (Cage#3)	ETS Lingren	Model 2165	F2000371		
Turntable controller (Cage#3)	ETS Lingren	Model 2090	F2000444		
Antenna Mat (OATS)	ETS Lingren	2071-2	F2000392		
Biconic Antenna	EATON	94455-1	C2040234	03/21	03/23
Cable (OATS)	–	1GHz	A5329623	09/22	09/23
Emission Cable	CABELTEL	6GHz	A5329069	05/22	05/23
Emission Cable	MICRO-COAX	1GHz	A5329656	08/22	08/23
Emission Cable	RADIALEX		A5329061	08/22	08/23
OATS	–	–	F2000409	07/22	07/23
Table C1/OATS	LCIE	–	F2000445		
Turntable (OATS)	ETS Lingren	Model 2187	F2000403		

Note: In our quality system, the test equipment calibration due is more & less 2 months



7.5. DIVERGENCE, ADDITION OR SUPPRESSION ON THE TEST SPECIFICATION

None

7.6. RESULTS

7.6.1. 9kHz to 30MHz

Graphs – Pre characterization:

Graph identifier	Polarization	Mode	Channel	EUT position	Comments
Emr# 1	0°/90°	TX	Cmid	Axis XY/Z	See the following results
Emr# 2	180°	TX	Cmid	Axis XY/Z	See the following results

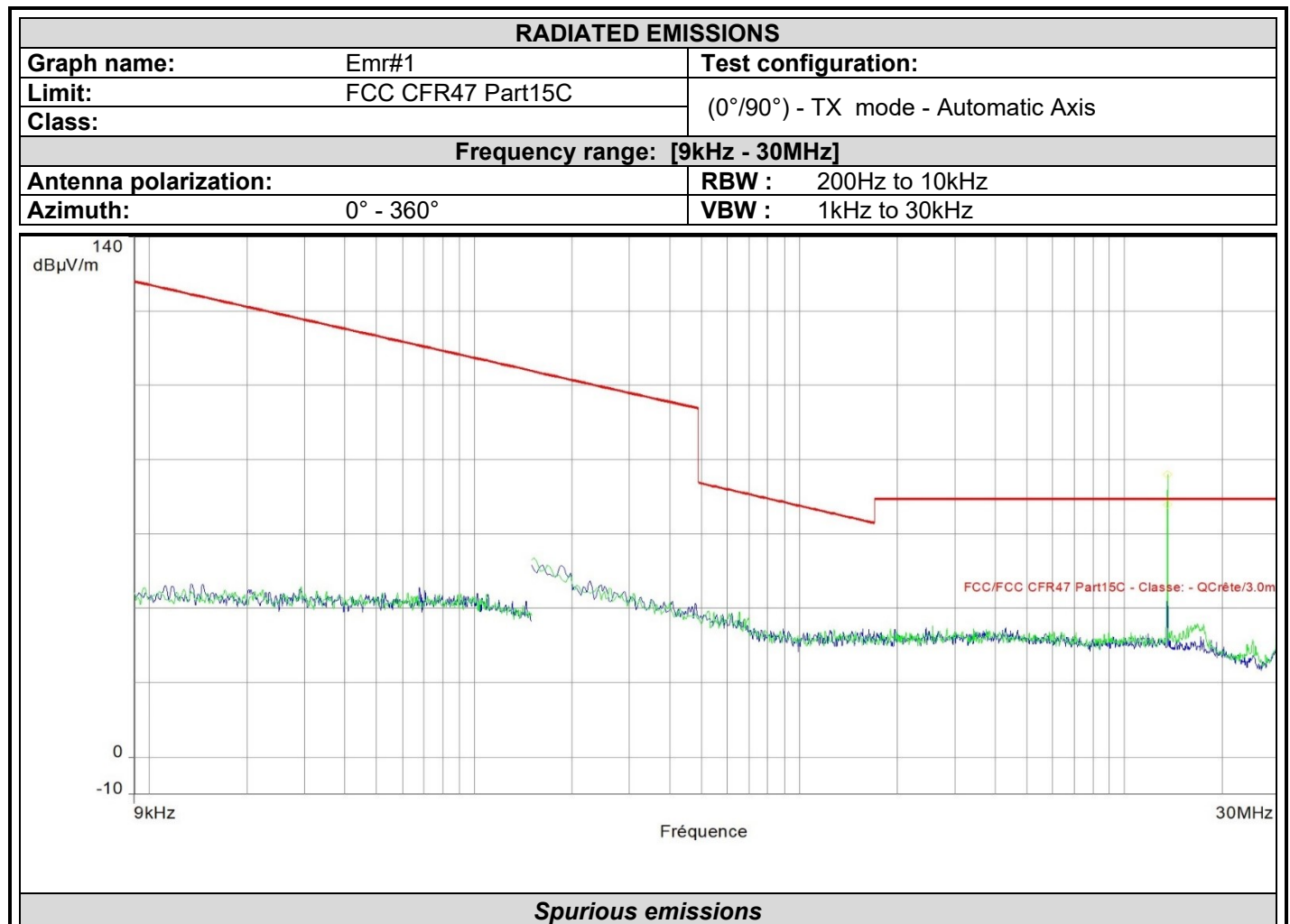

Frequency (MHz)	Peak (dBµV/m)	Lim.Q-Peak (dBµV/m)	Polarization	Correction (dB)
13.562*	76.0	/	90°	38.9
13.562*	68.0	/	0°	38.9

*Carrier frequency



L C I E

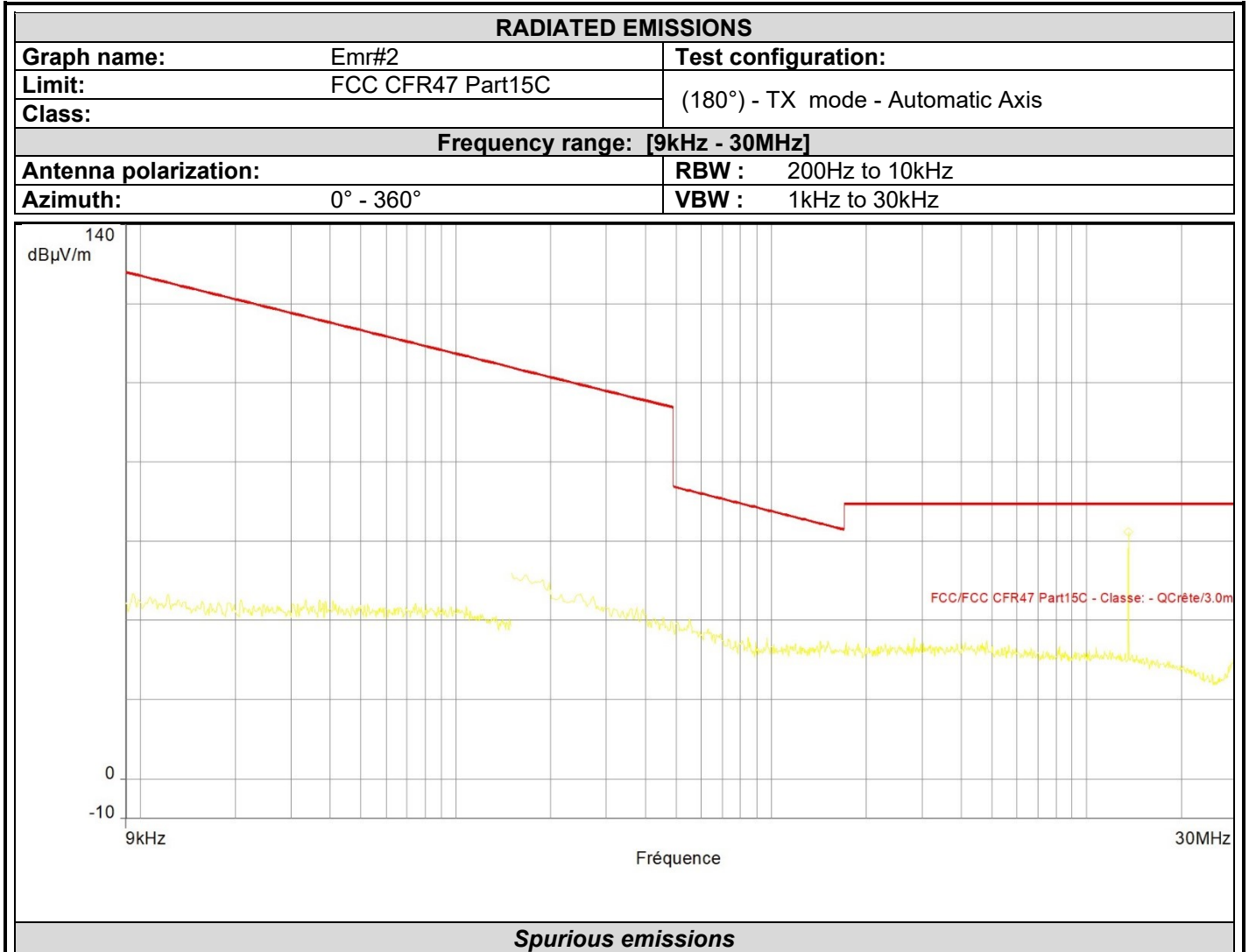

Frequency (MHz)	Peak (dBµV/m)	Lim.Peak (dBµV/m)	Lim.Avg (dBµV/m)	Lim.Q-Peak (dBµV/m)	Polarization	Correction (dB)
13.562*	62.3			69.5	180°	38.9

*Carrier frequency



7.6.2. 30MHz to 1GHz

Graphs – Pre characterization:

Graph identifier	Polarization	Mode	Channel	EUT position	Comments
Emr# 3	H/V	TX	Cmid	Axis XYZ	See the following results

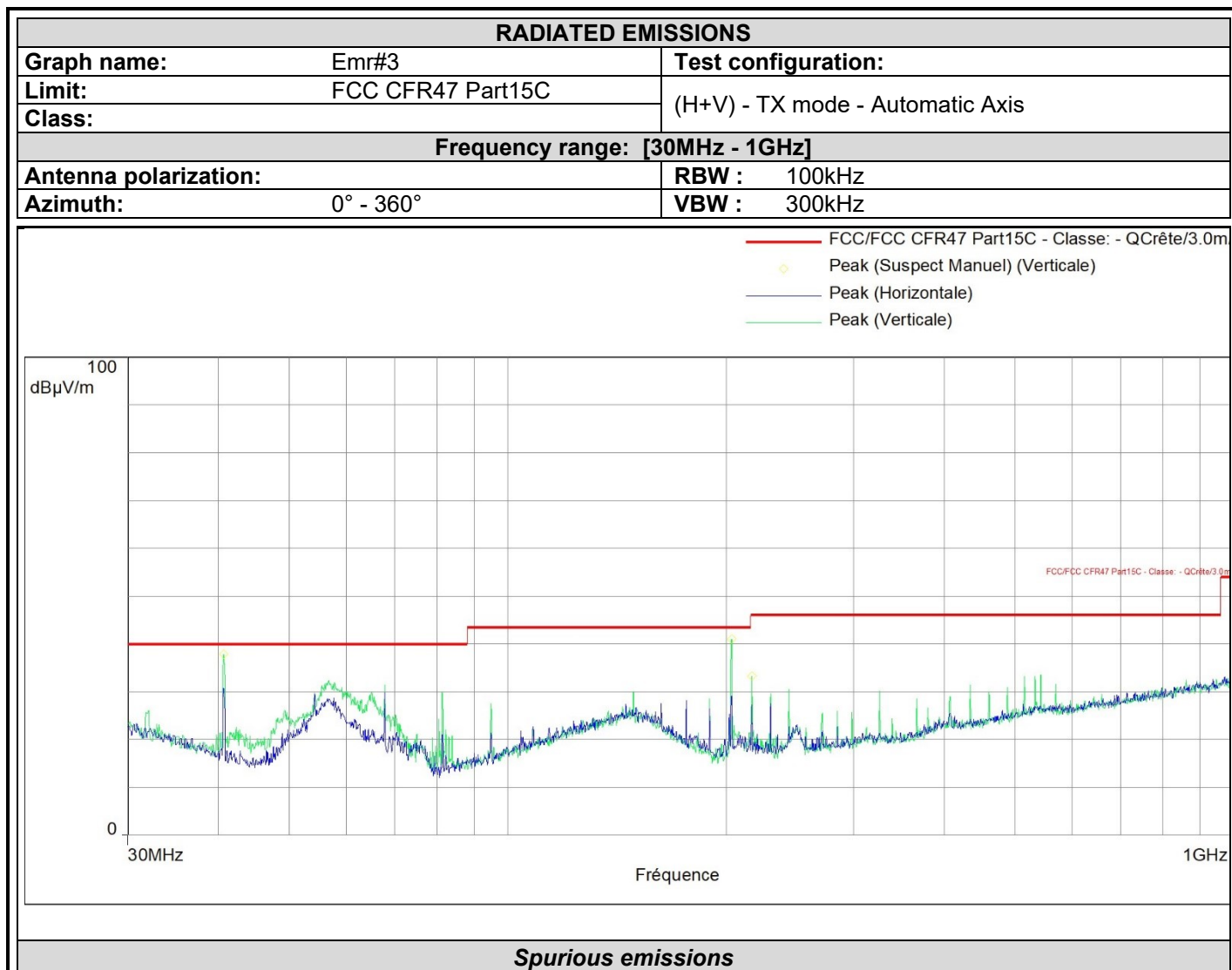

Frequency (MHz)	Peak (dBµV/m)	Lim.Q-Peak (dBµV/m)	Polarization	Correction (dB)
40.670	38.0	40.0	Vertical	16.0
203.436	41.1	43.5	Vertical	13.8
216.919	33.3	46.0	Vertical	13.9



L C I E

Final measurement:

Test Frequency (MHz)	Meter Reading dB(μ V)	Detector (Pk/QP/Av)	Polarity (V/H)	Azimuth (Degrees)	Antenna Height (cm)	Gain/Loss Factor (dB)	Transducer Factor (dB)	Level (dB μ V/m)	Limit (dB μ V/m)	Margin (dB)
40.6800	24.6	QP	V	0	100	-	14.4	39.0	40.0	-1.0
203.4000	28.0	QP	V	0	110	-	12.3	40.3	43.5	-3.2
216.9600	23.4	QP	V	0	110	-	12.9	36.3	46.0	-9.7

7.7. CONCLUSION

Field strength outside of the bands 13.110-14.010 MHz measurement performed on the sample of the product **Desk/2600**, Sn: **230587317081327729816918**, in configuration and description presented in this test report, show levels **compliant** to the **47 CFR PART 15.225 & RSS-Gen** limits.



8. UNCERTAINTIES CHART

<i>Kind of measurement</i>	<i>Wide uncertainty laboratory</i>
Occupied Channel Bandwidth	±2.8 %
Humidity	±3.2 %
Power Spectral Density, Conducted	±1.7 dB
Radio frequency	±0.3 ppm
RF power, conducted	±1.2 dB
RF power, radiated (Full anechoic chamber above 1GHz)	±3.7 dB
RF power, radiated (Semi anechoic chamber & open test site)	±5.6 dB
Spurious emission, conducted	±2.3 dB
Spurious emission, radiated (Full anechoic chamber above 1GHz)	±3.8 dB
Spurious emission, radiated (Semi anechoic chamber & open test site)	±5.7 dB
Temperature	±0.75 °C
Time	±2.3 %
Voltage	±1.7 %

The uncertainty values calculated by the laboratory are lower than limit uncertainty values defined by the CISPR. The conformity of the sample is directly established by the applicable limit values. This table includes all uncertainties maximum feasible for testing in the laboratory, whether or not made in this report.