



## TEST REPORT

Test report no.: 1-1765/21-01-02-A

BNetzA-CAB-02/21-102

### Testing laboratory

**CTC advanced GmbH**  
Untertuerkheimer Strasse 6 – 10  
66117 Saarbruecken / Germany  
Phone: + 49 681 5 98 - 0  
Fax: + 49 681 5 98 - 9075  
Internet: <https://www.ctcadvanced.com>  
e-mail: [mail@ctcadvanced.com](mailto:mail@ctcadvanced.com)

#### Accredited Testing Laboratory:

The testing laboratory (area of testing) is accredited according to DIN EN ISO/IEC 17025 (2018-03) by the Deutsche Akkreditierungsstelle GmbH (DAkkS). The accreditation is valid for the scope of testing procedures as stated in the accreditation certificate starting with the registration number: D-PL-12076-01.

### Applicant

**Ingenico Group**  
9 Avenue de la Gare Rovaltain  
26958 Valence Cedex 9 / FRANCE  
Phone: -/-  
Contact: Nicolas Jacquemont  
e-mail: [nicolas.jacquemont@ingenico.com](mailto:nicolas.jacquemont@ingenico.com)

### Manufacturer

**Ingenico Group**  
9 Avenue de la Gare Rovaltain  
26958 Valence Cedex 9 / FRANCE

### Test standard/s

FCC - Title 47 CFR Part 15    FCC - Title 47 of the Code of Federal Regulations; Chapter I; Part 15 - Radio frequency devices  
RSS - 210 Issue 10        Spectrum Management and Telecommunications Radio Standards Specification - Licence-Exempt Radio Apparatus: Category I Equipment

For further applied test standards please refer to section 3 of this test report.

### Test Item

**Kind of test item:**        **Payment Terminal**  
**Model name:**            **Self/8000 CL**  
**FCC ID:**                  **XKB-SELF8CL**  
**IC:**                         **2586D-SELF8CL**  
**Frequency:**              13.56 MHz  
**Technology tested:**     RFID  
**Antenna:**                Integrated antenna  
**Power supply:**         4.25 V to 5.75 V DC by external power supply  
**Temperature range:**    -20°C to +55°C

This test report is electronically signed and valid without handwritten signature. For verification of the electronic signatures, the public keys can be requested at the testing laboratory.

### Test report authorized:

Christoph Schneider  
Lab Manager  
Radio Communications

### Test performed:

Hans-Joachim Wolsdorfer  
Lab Manager  
Radio Communications

## 1 Table of contents

1	Table of contents .....	2
2	General information .....	3
2.1	Notes and disclaimer.....	3
2.2	Application details.....	3
2.3	Test laboratories sub-contracted.....	3
3	Test standard/s, references and accreditations .....	4
4	Reporting statements of conformity – decision rule .....	5
5	Test environment .....	6
6	Test item.....	6
6.1	General description .....	6
6.2	Additional information.....	6
7	Description of the test setup.....	7
7.1	Shielded semi anechoic chamber .....	8
7.2	Shielded fully anechoic chamber .....	10
7.3	AC conducted .....	11
7.4	Conducted measurements normal.....	12
7.5	Frequency error .....	13
8	Sequence of testing .....	14
8.1	Sequence of testing radiated spurious 9 kHz to 30 MHz .....	14
8.2	Sequence of testing radiated spurious 30 MHz to 1 GHz.....	15
9	Measurement uncertainty .....	16
10	Summary of measurement results.....	17
11	Additional comments .....	18
12	Measurement results .....	19
12.1	Occupied bandwidth.....	19
12.2	Field strength of the fundamental.....	21
12.3	Field strength of the harmonics and spurious .....	22
12.4	Conducted limits .....	25
12.5	Frequency error .....	28
13	Observations .....	30
14	Glossary .....	31
15	Document history .....	32
16	Accreditation Certificate – D-PL-12076-01-04 .....	32
17	Accreditation Certificate – D-PL-12076-01-05 .....	33

## 2 General information

### 2.1 Notes and disclaimer

The test results of this test report relate exclusively to the test item specified in this test report. CTC advanced GmbH does not assume responsibility for any conclusions and generalizations drawn from the test results with regard to other specimens or samples of the type of the equipment represented by the test item.

The test report may only be reproduced or published in full. Reproduction or publication of extracts from the report requires the prior written approval of CTC advanced GmbH.

The testing service provided by CTC advanced GmbH has been rendered under the current "General Terms and Conditions for CTC advanced GmbH".

CTC advanced GmbH will not be liable for any loss or damage resulting from false, inaccurate, inappropriate or incomplete product information provided by the customer.

Under no circumstances does the CTC advanced GmbH test report include any endorsement or warranty regarding the functionality, quality or performance of any other product or service provided.

Under no circumstances does the CTC advanced GmbH test report include or imply any product or service warranties from CTC advanced GmbH, including, without limitation, any implied warranties of merchantability, fitness for purpose, or non-infringement, all of which are expressly disclaimed by CTC advanced GmbH.

All rights and remedies regarding vendor's products and services for which CTC advanced GmbH has prepared this test report shall be provided by the party offering such products or services and not by CTC advanced GmbH. In no case this test report can be considered as a Letter of Approval.

This test report is electronically signed and valid without handwritten signature. For verification of the electronic signatures, the public keys can be requested at the testing laboratory.

**This test report replaces the test report with the number 1-1765/21-01-02 and dated 2021-03-10.**

### 2.2 Application details

Date of receipt of order:	2021-01-25
Date of receipt of test item:	2021-02-19
Start of test:*	2021-02-22
End of test:*	2021-02-26
Person(s) present during the test:	-/-

\*Date of each measurement, if not shown in the plot, can be requested. Dates are stored in the measurement software.

### 2.3 Test laboratories sub-contracted

None

### 3 Test standard/s, references and accreditations

Test standard	Date	Description
FCC - Title 47 CFR Part 15	-/-	FCC - Title 47 of the Code of Federal Regulations; Chapter I; Part 15 - Radio frequency devices
RSS - 210 Issue 10	December 2019	Spectrum Management and Telecommunications Radio Standards Specification - Licence-Exempt Radio Apparatus: Category I Equipment
RSS - Gen Issue 5 incl. Amendment 1	March 2019	Spectrum Management and Telecommunications Radio Standards Specification - General Requirements for Compliance of Radio Apparatus

Guidance	Version	Description
ANSI C63.4-2014	-/-	American National Standard for Methods of Measurement of Radio-Noise Emissions from Low-Voltage Electrical and Electronic Equipment in the Range of 9 kHz to 40 GHz
ANSI C63.10-2013	-/-	American National Standard of Procedures for Compliance Testing of Unlicensed Wireless Devices

Accreditation	Description		
D-PL-12076-01-04	Telecommunication and EMC Canada <a href="https://www.dakks.de/as/ast/d/D-PL-12076-01-04e.pdf">https://www.dakks.de/as/ast/d/D-PL-12076-01-04e.pdf</a>		Deutsche Akkreditierungsstelle D-PL-12076-01-04
D-PL-12076-01-05	Telecommunication FCC requirements <a href="https://www.dakks.de/as/ast/d/D-PL-12076-01-05e.pdf">https://www.dakks.de/as/ast/d/D-PL-12076-01-05e.pdf</a>		Deutsche Akkreditierungsstelle D-PL-12076-01-05

#### 4 Reporting statements of conformity – decision rule

Only the measured values related to their corresponding limits will be used to decide whether the equipment under test meets the requirements of the test standards listed in chapter 3.

The measurement uncertainty is mentioned in this test report, see chapter 9, but is not taken into account - neither to the limits nor to the measurement results. Measurement results with a smaller margin to the corresponding limits than the measurement uncertainty have a potential risk of more than 5% that the decision might be wrong."

measured value, measurement uncertainty, verdict

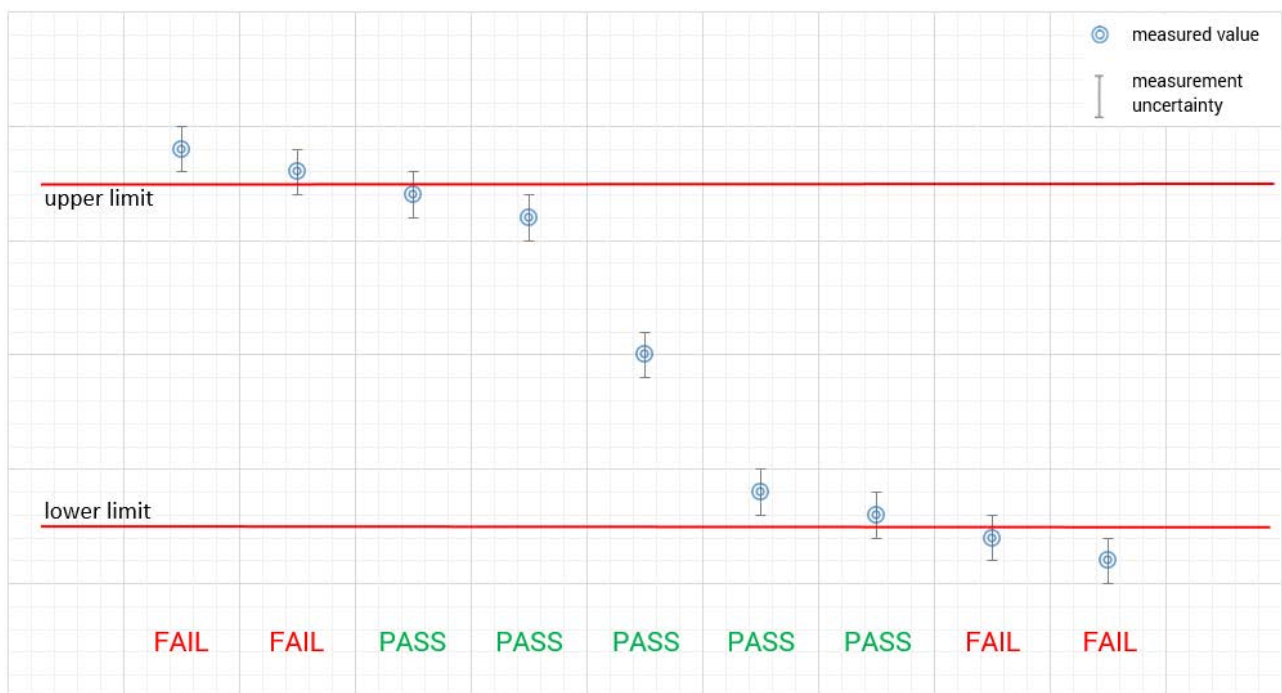

## 5 Test environment

Temperature	:	$T_{nom}$ +22 °C during room temperature tests $T_{max}$ +55 °C during high temperature tests $T_{min}$ -20 °C during low temperature tests
Relative humidity content	:	55 %
Barometric pressure	:	1021 hpa
Power supply	:	$V_{nom}$ 5.0 V DC by external power supply $V_{max}$ 5.75 V $V_{min}$ 4.25 V

## 6 Test item

### 6.1 General description

Kind of test item	:	Payment Terminal
Model name	:	Self/8000 CL
HMN	:	-/-
PMN	:	Self/8000
HVIN	:	Self/8000 CL
FVIN	:	-/-
S/N serial number	:	Rad. 203657317011197518968268 AC Cond. 203567317011197518824388
Hardware status	:	V2
Software status	:	OS0130
Firmware status	:	N/A
Frequency band	:	13.56 MHz
Type of radio transmission	:	modulated carrier
Use of frequency spectrum	:	
Type of modulation	:	ASK
Number of channels	:	1
Antenna	:	Integrated antenna
Power supply	:	4.25 V to 5.75 V DC by external power supply
Temperature range	:	-20°C to +55°C

### 6.2 Additional information

The content of the following annexes is defined in the QA. It may be that not all of the listed annexes are necessary for this report, thus some values in between may be missing. AC conducted measurement has been performed with a modified sample with RFID antenna terminated.

Test setup and EUT photos are included in test report:

- 1-1765/21-01-02\_AnnexA
- 1-1765/21-01-02\_AnnexB
- 1-1765/21-01-02\_AnnexD

## 7 Description of the test setup

Typically, the calibrations of the test apparatus are commissioned to and performed by an accredited calibration laboratory. The calibration intervals are determined in accordance with the DIN EN ISO/IEC 17025. In addition to the external calibrations, the laboratory executes comparison measurements with other calibrated test systems or effective verifications. Weekly chamber inspections and range calibrations are performed. Where possible, RF generating and signaling equipment as well as measuring receivers and analyzers are connected to an external high-precision 10 MHz reference (GPS-based or rubidium frequency standard).

In order to simplify the identification of the equipment used at some special tests, some items of test equipment and ancillaries can be provided with an identifier or number in the equipment list below (Lab/Item).

### **Agenda:** Kind of Calibration

k	calibration / calibrated	EK	limited calibration
ne	not required (k, ev, izw, zw not required)	zw	cyclical maintenance (external cyclical maintenance)
ev	periodic self verification	izw	internal cyclical maintenance
Ve	long-term stability recognized	g	blocked for accredited testing
vlk!	Attention: extended calibration interval		
NK!	Attention: not calibrated	*)	next calibration ordered / currently in progress

## 7.1 Shielded semi anechoic chamber

The radiated measurements are performed in vertical and horizontal plane in the frequency range from 30 MHz to 1 GHz in semi-anechoic chambers. The EUT is positioned on a non-conductive support with a height of 0.80 m above a conductive ground plane that covers the whole chamber. The receiving antennas are conform to specifications ANSI C63. These antennas can be moved over the height range between 1.0 m and 4.0 m in order to search for maximum field strength emitted from EUT. The measurement distances between EUT and receiving antennas are indicated in the test setups for the various frequency ranges. For each measurement, the EUT is rotated in all three axes until the maximum field strength is received. The wanted and unwanted emissions are received by spectrum analyzers where the detector modes and resolution bandwidths over various frequency ranges are set according to requirement ANSI C63.

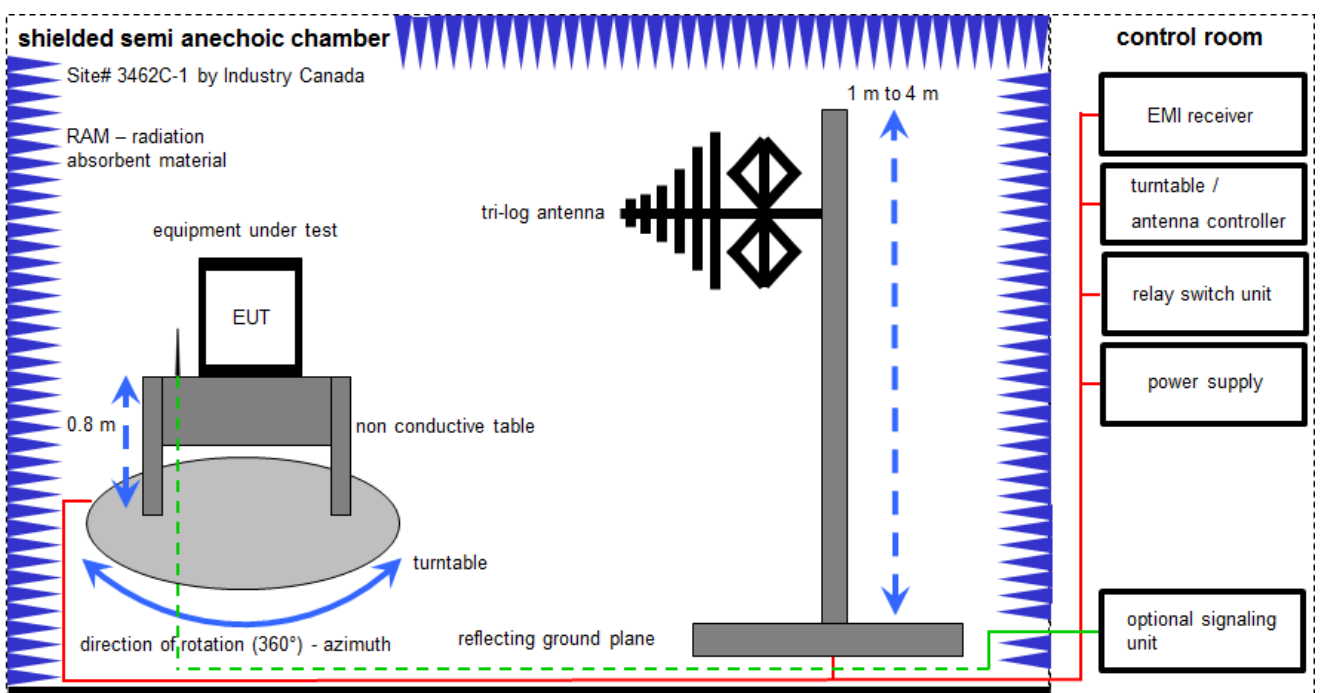

Measurement distance: tri-log antenna 10 meter  
EMC32 software version: 10.59.00

$$FS = UR + CL + AF$$

(FS-field strength; UR-voltage at the receiver; CL-loss of the cable; AF-antenna factor)

Example calculation:

$$FS [dB\mu V/m] = 12.35 [dB\mu V/m] + 1.90 [dB] + 16.80 [dB/m] = 31.05 [dB\mu V/m] (35.69 \mu V/m)$$



**Equipment table:**

No.	Lab / Item	Equipment	Type	Manufacturer	Serial No.	INV. No.	Kind of Calibration	Last Calibration	Next Calibration
1	A	Semi anechoic chamber	3000023	MWB AG		300000551	ne	-/-	-/-
2	A	Analyzer-Reference-System (Harmonics and Flicker)	ARS 16/1	SPS	A3509 07/0 0205	300003314	vKI!	17.01.2020	16.01.2022
3	A	Antenna Tower	Model 2175	ETS-Lindgren	64762	300003745	izw	-/-	-/-
4	A	Positioning Controller	Model 2090	ETS-Lindgren	64672	300003746	izw	-/-	-/-
5	A	Turntable Interface-Box	Model 105637	ETS-Lindgren	44583	300003747	izw	-/-	-/-
6	A	TRILOG Broadband Test-Antenna 30 MHz - 3 GHz	VULB9163	Schwarzbeck Mess - Elektronik	295	300003696	vKI!	04.09.2019	03.09.2021
7	A	Turntable	2089-4.0	EMCO		300004394	ne	-/-	-/-
8	A	PC	TecLine	F+W		300004388	ne	-/-	-/-
9	A	EMI Test Receiver	ESR3	Rohde & Schwarz	102587	300005771	k	10.12.2020	09.06.2022

## 7.2 Shielded fully anechoic chamber

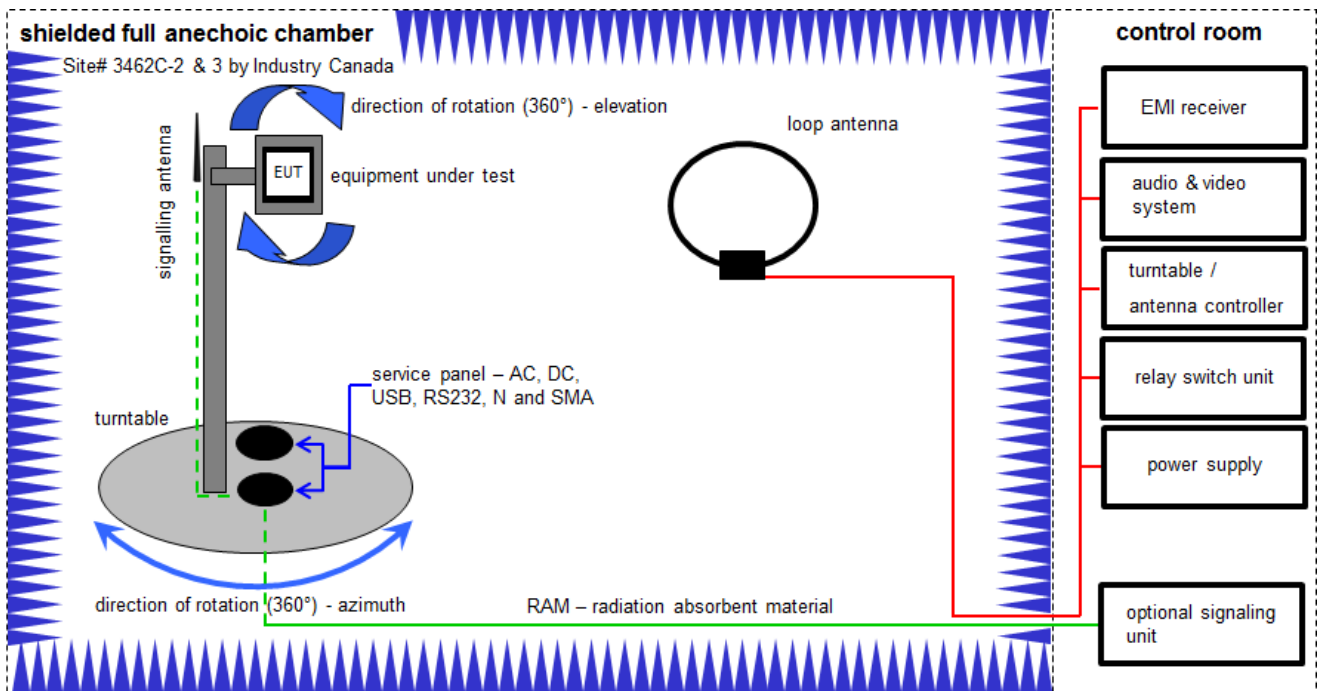

Measurement distance: loop antenna 3 meter

$$FS = UR + CA + AF$$

(FS-field strength; UR-voltage at the receiver; CA-loss of the signal path; AF-antenna factor)

Example calculation:

$$FS \text{ [dB}\mu\text{V/m]} = 40.0 \text{ [dB}\mu\text{V/m]} + (-35.8) \text{ [dB]} + 32.9 \text{ [dB/m]} = 37.1 \text{ [dB}\mu\text{V/m]} \text{ (71.61 } \mu\text{V/m)}$$

### Equipment table:

No.	Lab / Item	Equipment	Type	Manufacturer	Serial No.	INV. No.	Kind of Calibration	Last Calibration	Next Calibration
1	A	DC power supply, 60Vdc, 50A, 1200 W	6032A	HP	2818A03450	300001040	vIKI!	09.12.2020	08.12.2023
2	A	Active Loop Antenna 9 kHz to 30 MHz	6502	EMCO	2210	300001015	vIKI!	13.06.2019	12.06.2021
3	A	Anechoic chamber	FAC 3/5m	MWB / TDK	87400/02	300000996	ev	-/-	-/-
4	A	EMI Test Receiver 20Hz- 26,5GHz	ESU26	R&S	100037	300003555	k	11.12.2020	10.12.2021
5	A	4U RF Switch Platform	L4491A	Agilent Technologies	MY50000037	300004509	ne	-/-	-/-
6	A	NEXIO EMV-Software	BAT EMC V3.20.0.17	EMCO		300004682	ne	-/-	-/-
7	A	PC	ExOne	F+W		300004703	ne	-/-	-/-

### 7.3 AC conducted

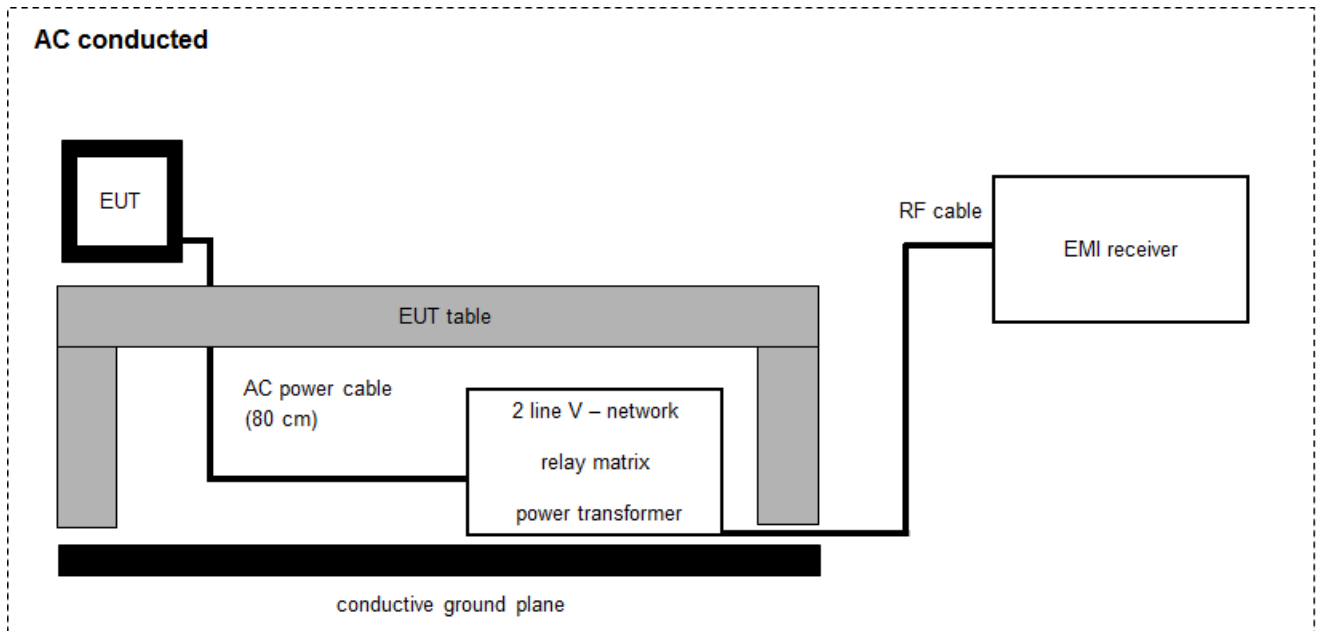

$$FS = UR + CF + VC$$

(FS-field strength; UR-voltage at the receiver; CR-loss of the cable and filter; VC-correction factor of the ISN)

Example calculation:

$$FS [dB\mu V/m] = 37.62 [dB\mu V/m] + 9.90 [dB] + 0.23 [dB] = 47.75 [dB\mu V/m] (244.06 \mu V/m)$$

**Equipment table:**

No.	Lab / Item	Equipment	Type	Manufacturer	Serial No.	INV. No.	Kind of Calibration	Last Calibration	Next Calibration
1	A	Two-line V-Network (LISN) 9 kHz to 30 MHz	ESH3-Z5	Rohde & Schwarz	892475/017	300002209	vIKI!	11.12.2019	10.12.2021
2	A	RF-Filter-section	85420E	HP	3427A00162	300002214	NK!	-/-	-/-
3	A	EMI Test Receiver	ESCI 3	R&S	100083	300003312	k	09.12.2020	08.12.2021
4	A	Analyzer-Reference-System (Harmonics and Flicker)	ARS 16/1	SPS	A3509 07/0 0205	300003314	vIKI!	17.01.2020	16.01.2022
5	A	Hochpass 150 kHz	EZ-25	R&S	100010	300003798	ev	-/-	-/-
6	A	PC	TecLine	F+W		300003532	ne	-/-	-/-

## 7.4 Conducted measurements normal

### Conducted measurements normal conditions

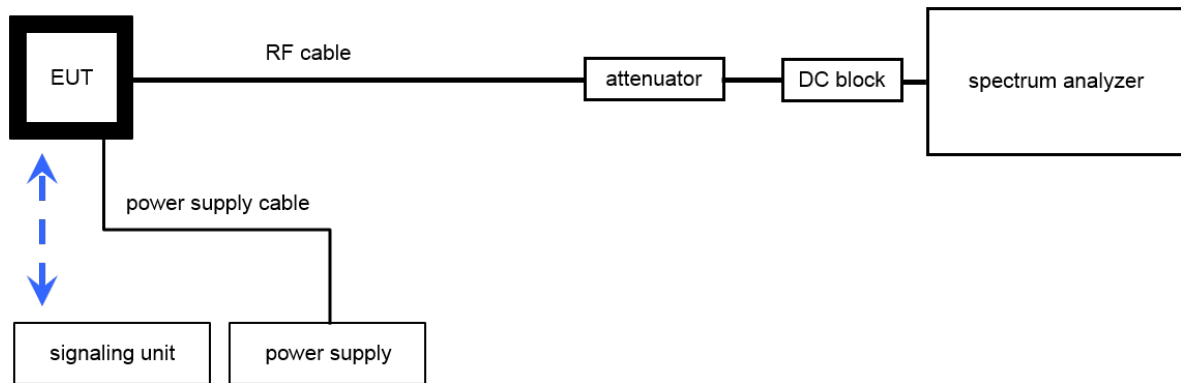

OP = AV + CA  
(OP-output power; AV-analyzer value; CA-loss signal path)

Example calculation:

OP [dBm] = 6.0 [dBm] + 11.7 [dB] = 17.7 [dBm] (58.88 mW)

### Equipment table:

No.	Lab / Item	Equipment	Type	Manufacturer	Serial No.	INV. No.	Kind of Calibration	Last Calibration	Next Calibration
1	A	Loop Antenna	- / -	ZEG TS Steinfurt	- / -	400001208	ev	- / -	- / -
2	A	Spectrum Analyzer	FSV30	Rohde & Schwarz	104365	300005923	k	16.12.2020	15.12.2021

## 7.5 Frequency error

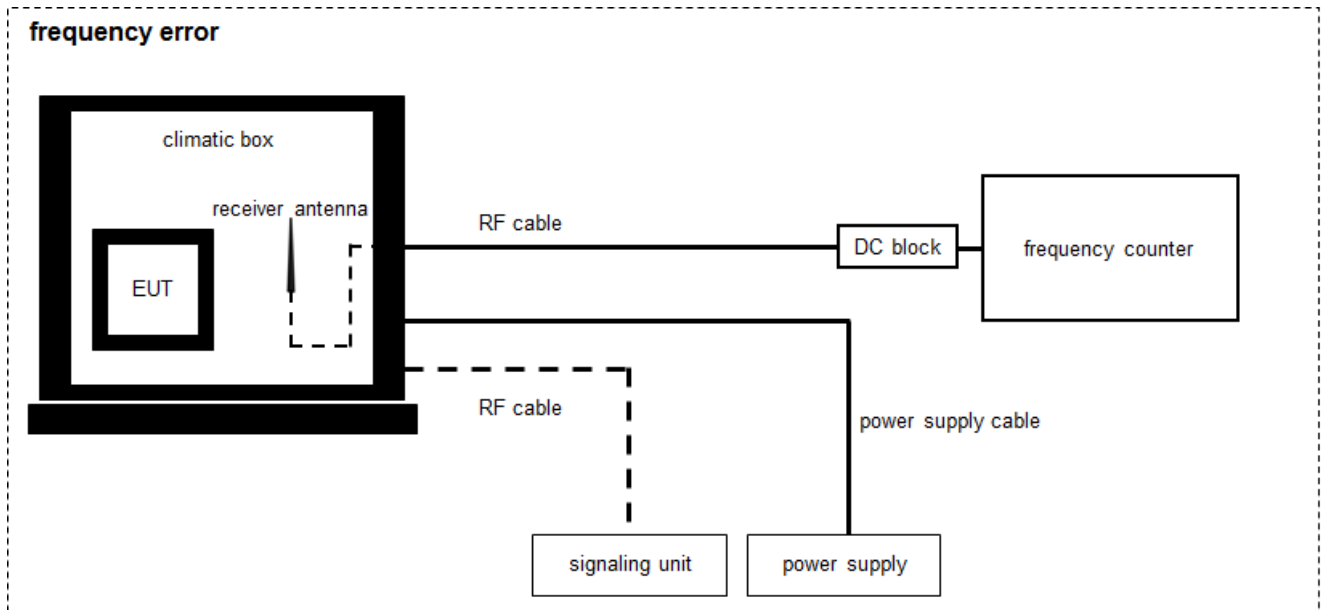

### Equipment table:

No.	Lab / Item	Equipment	Type	Manufacturer	Serial No.	INV. No.	Kind of Calibration	Last Calibration	Next Calibration
1	A	Loop Antenna	- / -	ZEG TS Steinfurt	- / -	400001208	ev	- / -	- / -
2	A	Temperature Test Chamber	VT 4011	Voetsch Industrietechnik	58566230600010	300005363	ev	08.05.2020	07.05.2022
3	A	Spectrum Analyzer	FSV30	Rohde & Schwarz	104365	300005923	k	16.12.2020	15.12.2021
4	A	Power Supply	HMP2020	Rohde & Schwarz	101961	300006102	k	04.08.2020	03.08.2022

## 8 Sequence of testing

### 8.1 Sequence of testing radiated spurious 9 kHz to 30 MHz

#### Setup

- The equipment is set up to simulate normal operation mode as described in the user manual or defined by the manufacturer.
- If the EUT is a tabletop system, it is placed on a table with 0.8 m height.
- If the EUT is a floor standing device, it is placed directly on the turn table.
- Auxiliary equipment and cables are positioned to simulate normal operation conditions as described in ANSI C 63.4.
- The AC power port of the EUT (if available) is connected to a power outlet below the turntable.
- Measurement distance is 3 m (see ANSI C 63.4) – see test details.
- EUT is set into operation.

#### Premeasurement\*

- The turntable rotates from 0° to 315° using 45° steps.
- The antenna height is 1 m.
- At each turntable position the analyzer sweeps with positive-peak detector to find the maximum of all emissions.

#### Final measurement

- Identified emissions during the pre-measurement are maximized by the software by rotating the turntable from 0° to 360°.
- Loop antenna is rotated about its vertical axis for maximum response at each azimuth about the EUT. (For certain applications, the loop antenna plane may also need to be positioned horizontally at the specified distance from the EUT)
- The final measurement is done in the position (turntable and elevation) causing the highest emissions with quasi-peak (as described in ANSI C 63.4).
- Final levels, frequency, measuring time, bandwidth, turntable position, correction factor, margin to the limit and limit will be recorded. A plot with the graph of the premeasurement and the limit is stored.

\*Note: The sequence will be repeated three times with different EUT orientations.

## 8.2 Sequence of testing radiated spurious 30 MHz to 1 GHz

### Setup

- The equipment is set up to simulate normal operation mode as described in the user manual or defined by the manufacturer.
- If the EUT is a tabletop system, a table with 0.8 m height is used, which is placed on the ground plane.
- If the EUT is a floor standing device, it is placed on the ground plane with insulation between both.
- Auxiliary equipment and cables are positioned to simulate normal operation conditions as described in ANSI C 63.4.
- The AC power port of the EUT (if available) is connected to a power outlet below the turntable.
- Measurement distance is 10 m or 3 m (see ANSI C 63.4) – see test details.
- EUT is set into operation.

### Premeasurement

- The turntable rotates from 0° to 315° using 45° steps.
- The antenna is polarized vertical and horizontal.
- The antenna height changes from 1 m to 3 m.
- At each turntable position, antenna polarization and height the analyzer sweeps three times in peak to find the maximum of all emissions.

### Final measurement

- The final measurement is performed for at least six highest peaks according to the requirements of the ANSI C63.4.
- Based on antenna and turntable positions at which the peak values are measured the software maximize the peaks by changing turntable position  $\pm 45^\circ$  and antenna height between 1 and 4 m.
- The final measurement is done with quasi-peak detector (as described in ANSI C 63.4).
- Final levels, frequency, measuring time, bandwidth, antenna height, antenna polarization, turntable angle, correction factor, margin to the limit and limit are recorded. A plot with the graph of the premeasurement with marked maximum final results and the limit is stored.

## 9 Measurement uncertainty

Measurement uncertainty	
Test case	Uncertainty
Occupied bandwidth	± used RBW
Field strength of the fundamental	± 3 dB
Field strength of the harmonics and spurious	± 3 dB
Receiver spurious emissions and cabinet radiations	± 3 dB
Conducted limits	± 2.6 dB



## 10 Summary of measurement results

<input checked="" type="checkbox"/>	No deviations from the technical specifications were ascertained
<input type="checkbox"/>	There were deviations from the technical specifications ascertained
<input type="checkbox"/>	This test report is only a partial test report. The content and verdict of the performed test cases are listed below.

TC Identifier	Description	Verdict	Date	Remark
RF-Testing	CFR Part 15 RSS 210 Issue 10 RSS Gen Issue 5	See table!	2021-03-15	-/-

Test specification clause	Test case	Temperature conditions	Power source conditions	C	NC	NA	NP	Remark
RSS Gen Issue 5	Occupied bandwidth	Nominal	Nominal	<input checked="" type="checkbox"/>	<input type="checkbox"/>	<input type="checkbox"/>	<input type="checkbox"/>	-/-
§ 15.225 (a) RSS 210 Issue 10	Field strength of the fundamental	Nominal	Nominal	<input checked="" type="checkbox"/>	<input type="checkbox"/>	<input type="checkbox"/>	<input type="checkbox"/>	-/-
§ 15.209 & § 15.225 (b-d)	Field strength of the harmonics and spurious	Nominal	Nominal	<input checked="" type="checkbox"/>	<input type="checkbox"/>	<input type="checkbox"/>	<input type="checkbox"/>	-/-
§ 15.109	Receiver spurious emissions and cabinet radiations	Nominal	Nominal	<input type="checkbox"/>	<input type="checkbox"/>	<input checked="" type="checkbox"/>	<input type="checkbox"/>	-/-
§15.107 §15.207	Conducted limits	Nominal	Nominal	<input checked="" type="checkbox"/>	<input type="checkbox"/>	<input type="checkbox"/>	<input type="checkbox"/>	-/-
§ 15.225 (a) RSS 210 Issue 10	Frequency tolerance	Normal & extreme conditions	Normal & extreme conditions	<input checked="" type="checkbox"/>	<input type="checkbox"/>	<input type="checkbox"/>	<input type="checkbox"/>	-/-

**Note:**

- C Compliant
- NC Not compliant
- NA Not applicable
- NP Not performed

## 11 Additional comments

Reference documents: None

Special test descriptions: Safety\_EMG\_agreement\_procedure SELF8000.pdf

Configuration descriptions: None

## 12 Measurement results

### 12.1 Occupied bandwidth

#### Measurement:

The emission bandwidth (x dB) is defined as the frequency range between two points, one above and one below the carrier frequency, at which the spectral density of the emission is attenuated x dB below the maximum in-band spectral density of the modulated signal.

Measurement parameters	
Detector:	Peak
Resolution bandwidth:	1 % – 5 % of the occupied bandwidth
Video bandwidth:	≥ 3x RBW
Trace mode:	Max hold
Analyser function:	99 % power function
Used equipment:	See chapter 7.4 A
Measurement uncertainty:	See chapter 9

#### Limit:

IC
for RSP-100 test report coversheet only

#### Result:

99% emission bandwidth
501.166 kHz

**Plot:**

**Plot 1: 99 % emission bandwidth**

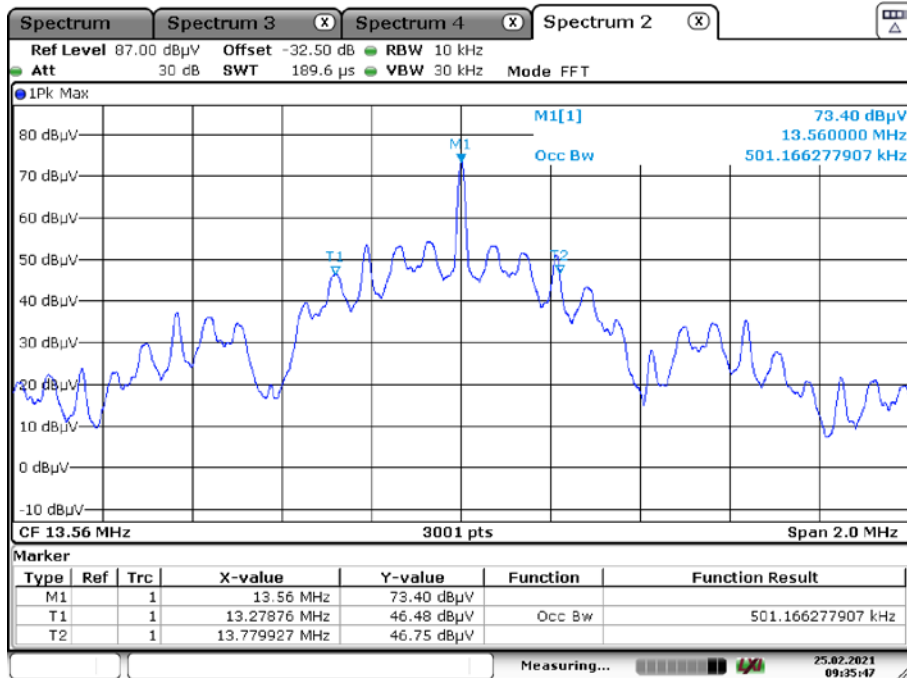

Date: 25.FEB.2021 09:35:48

## 12.2 Field strength of the fundamental

### Measurement:

The maximum detected field strength for the carrier signal.

Measurement parameters	
Detector:	average
Resolution bandwidth:	120 kHz
Video bandwidth:	≥ 3x RBW
Trace mode:	Max hold
Used equipment:	See chapter 7.2 A
Measurement uncertainty:	See chapter 9

### Limit:

FCC & IC		
Frequency (MHz)	Field strength (µV/m)	Measurement distance (m)
13.553 to 13.567	15,848 (84 dBµV/m)	30

### Recalculation:

According to ANSI C63.10		
Frequency	Formula	Correction value
13.56 MHz	$FS_{limit} = FS_{max} - 40 \log\left(\frac{d_{nearfield}}{d_{measure}}\right) - 20 \log\left(\frac{d_{limit}}{d_{nearfield}}\right)$ <p> <math>FS_{limit}</math> is the calculation of field strength at the limit distance, expressed in dBµV/m  <math>FS_{max}</math> is the measured field strength, expressed in dBµV/m  <math>d_{nearfield}</math> is the <math>\lambda/2\pi</math> distance  <math>d_{measure}</math> is the distance of the measurement point from EUT  <math>d_{limit}</math> is the reference limit distance                 </p>	-21.4 from 3m to 30m

### Result:

Field strength of the fundamental		
Frequency	13.56 MHz	
Distance	@ 3 m	@ 30 m
Measured / calculated value	73.44dBµV/m	52.04dBµV/m

### 12.3 Field strength of the harmonics and spurious

**Measurement:**

The maximum detected field strength for the harmonics and spurious.

Measurement parameters	
Detector:	Quasi peak / average or peak (worst case – pre-scan)
Resolution bandwidth:	F < 150 kHz: 200 Hz 150 kHz < F < 30 MHz: 9 kHz 30 MHz < F < 1 GHz: 120 kHz
Video bandwidth:	F < 150 kHz: 1 kHz 150 kHz < F < 30 MHz: 100 kHz 30 MHz < F < 1 GHz: 300 kHz
Trace mode:	Max hold
Used equipment:	See chapter 7.1 A & 7.2 A & 7.3 A
Measurement uncertainty:	See chapter 9

**Limit:**

FCC & IC		
Frequency (MHz)	Field strength (dBµV/m)	Measurement distance (m)
0.009 – 0.490	2400/F(kHz)	300
0.490 – 1.705	24000/F(kHz)	30
1.705 – 30	30 (29.5 dBµV/m)	30
30 – 88	100 (40 dBµV/m)	3
88 – 216	150 (43.5 dBµV/m)	3
216 – 960	200 (46 dBµV/m)	3

**Note:** For a reduced measurement distance, please take a look at the limit line and the ANSI C63.10-2013 sub clause 6.4 radiated emissions from unlicensed wireless devices below 30 MHz.

**Result:**

Detected emissions			
Frequency (MHz)	Detector	Resolution bandwidth (kHz)	Detected value (dBµV/m @ 3m)
see table below plots			

**Plots:**

**Plot 1: 9 kHz – 30 MHz, magnetic emissions**

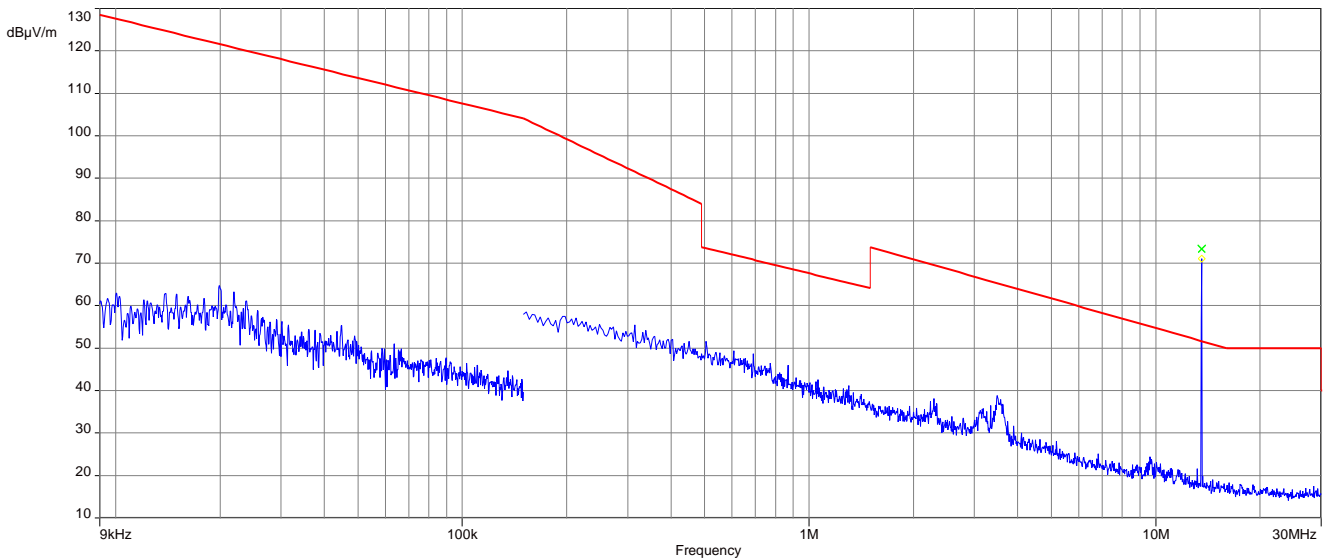

**Plot 2: Spectrum mask (the limits are recalculated according to the ANSI C63.10-2013 sub clause 6.4)**

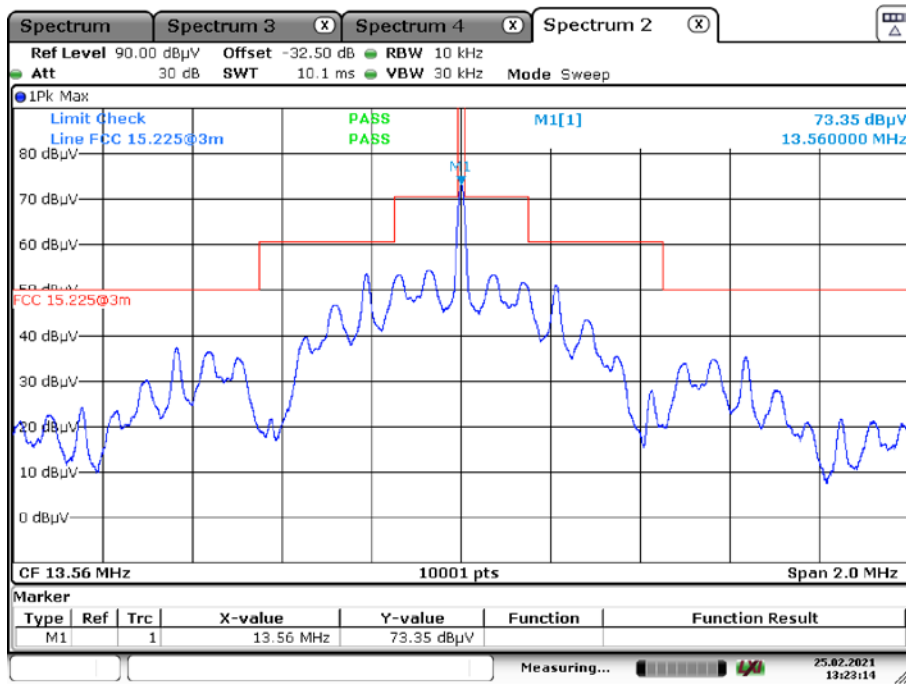

**Plot 3:** 30 MHz – 1 GHz, vertical and horizontal polarisation

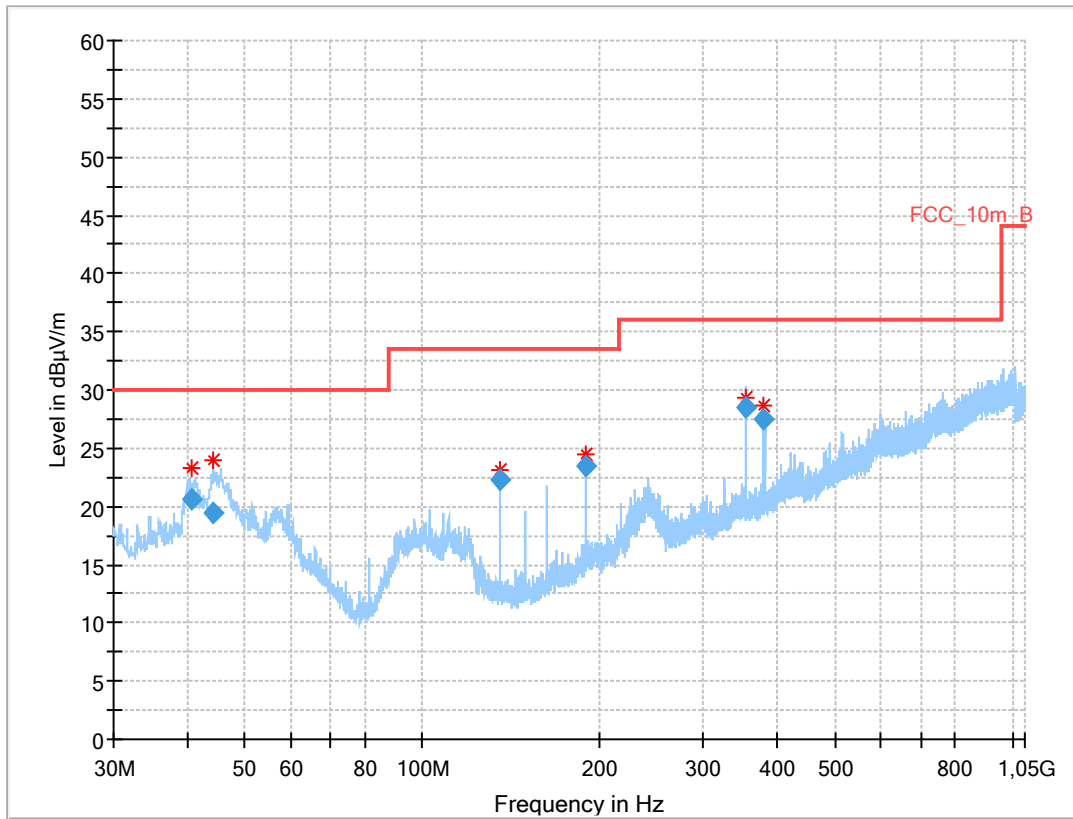

Frequency (MHz)	QuasiPeak (dBµV/m)	Limit (dBµV/m)	Margin (dB)	Meas. Time (ms)	Bandwidth (kHz)	Height (cm)	Pol	Azimuth (deg)	Corr. (dB/m)
40.697	20.58	30.0	9.4	1000	120.0	101.0	V	247	13
44.294	19.49	30.0	10.5	1000	120.0	98.0	V	-8	14
135.606	22.37	33.5	11.1	1000	120.0	98.0	V	202	9
189.855	23.42	33.5	10.1	1000	120.0	98.0	V	250	11
352.569	28.46	36.0	7.5	1000	120.0	105.0	V	247	16
379.700	27.42	36.0	8.6	1000	120.0	98.0	V	-22	16



## 12.4 Conducted limits

### Measurement:

Measurement of the conducted spurious emissions for an intentional radiator that is designed to be connected to the public utility (AC) power line.

Measurement parameters	
Detector:	Quasi peak / average or peak (worst case – pre-scan)
Resolution bandwidth:	F < 150 kHz: 200 Hz F > 150 kHz: 9 kHz
Video bandwidth:	F < 150 kHz: 1 kHz F > 150 kHz: 100 kHz
Trace mode:	Max hold
Used equipment:	See chapter 7.3 A
Measurement uncertainty:	See chapter 9

### Limit:

FCC & IC		
Frequency (MHz)	Quasi-peak (dB $\mu$ V/m)	Average (dB $\mu$ V/m)
0.15 – 0.5	66 to 56*	56 to 46*
0.5 – 5	56	46
5 – 30.0	60	50

### Result:

see table below plots

**Plots:**

**Plot 1:** 150 kHz to 30 MHz, phase line

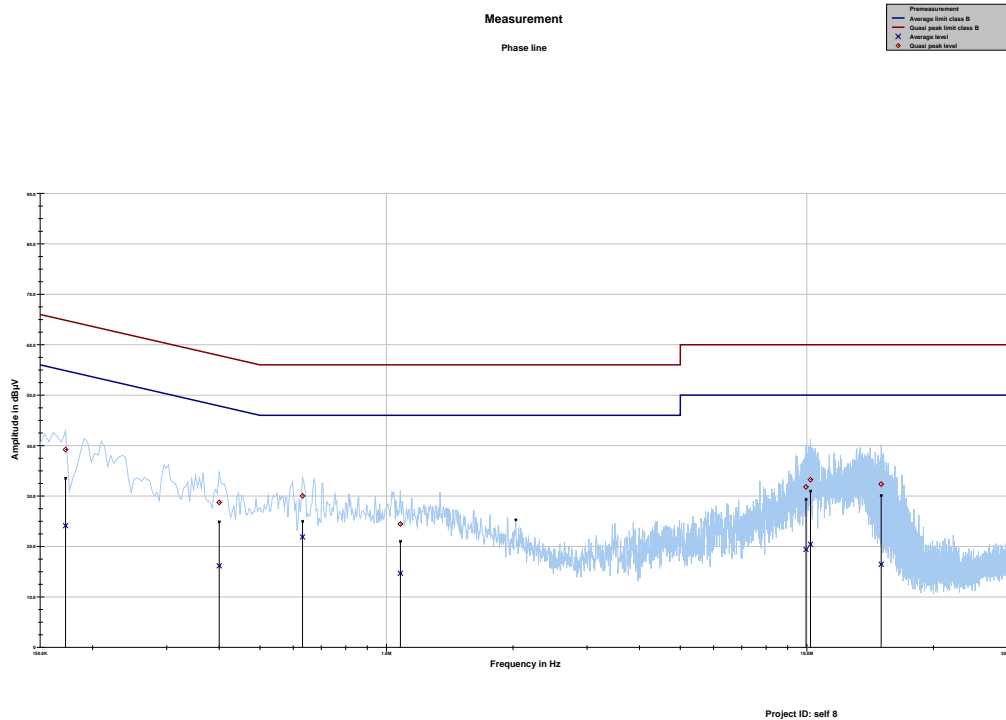

Frequency	Quasi peak level	Margin quasi peak	Limit QP	Average level	Margin average	Limit AV
MHz	dBµV	dB	dBµV	dBµV	dB	dBµV
0.172387	39.21	25.64	64.845	24.13	31.23	55.360
0.399994	28.73	29.12	57.854	16.17	32.69	48.857
0.631331	30.03	25.97	56.000	21.88	24.12	46.000
1.079081	24.45	31.55	56.000	14.67	31.33	46.000
9.955725	31.79	28.21	60.000	19.39	30.61	50.000
10.198256	33.23	26.77	60.000	20.43	29.57	50.000
15.026494	32.35	27.65	60.000	16.46	33.54	50.000

**Plot 2:** 150 kHz to 30 MHz, neutral line

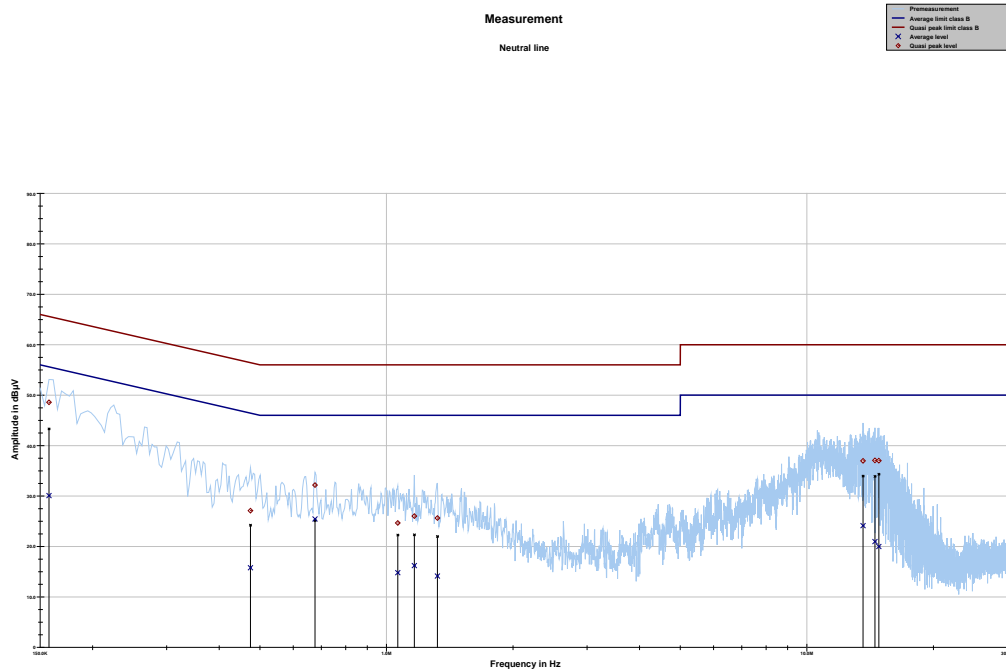

Project ID: self 8

Frequency	Quasi peak level	Margin quasi peak	Limit QP	Average level	Margin Average	Limit AV
MHz	dBµV	dB	dBµV	dBµV	dB	dBµV
0.157463	48.58	17.01	65.597	30.08	25.71	55.787
0.474619	27.10	29.34	56.433	15.78	30.94	46.725
0.676106	32.17	23.83	56.000	25.46	20.54	46.000
1.064156	24.66	31.34	56.000	14.79	31.21	46.000
1.164900	26.02	29.98	56.000	16.21	29.79	46.000
1.321613	25.64	30.36	56.000	14.14	31.86	46.000
13.604888	36.97	23.03	60.000	24.12	25.88	50.000
14.519044	37.05	22.95	60.000	20.96	29.04	50.000
14.832469	37.01	22.99	60.000	19.98	30.02	50.000

## 12.5 Frequency error

### Measurement:

The maximum detected field strength for the spurious.

Measurement parameters	
Detector:	Peak detector
Resolution bandwidth:	10 Hz / 100 Hz
Video bandwidth:	> RBW
Trace mode:	Max hold
Used equipment:	See chapter 7.5 A
Measurement uncertainty:	See chapter 9

### Limit:

FCC & IC
<p>The frequency tolerance of the carrier signal shall be maintained within +/- 0.01% of the operating frequency over a temperature variation of -20 degrees to +50 degrees C at normal supply voltage, and for a variation in the primary supply voltage from 85% to 115% of the rated supply voltage at a temperature of 20 degrees C. (<math>\pm 1.356</math> kHz)</p> <p>Carrier frequency stability shall be maintained to <math>\pm 0.01\%</math> (<math>\pm 100</math> ppm)</p>

**Result:** Temperature variation

Frequency tolerance			
Measured frequency (MHz)	Frequency error (kHz)	Conditions	Result
13.560373	0.373	-20 °C & 100% voltage	compliant
13.560445	0.445	-10 °C & 100% voltage	compliant
13.560445	0.445	0 °C & 100% voltage	compliant
13.560427	0.427	+10 °C & 100% voltage	compliant
13.560400	0.400	+20 °C & 100% voltage	compliant
13.560358	0.358	+30 °C & 100% voltage	compliant
13.560319	0.319	+40 °C & 100% voltage	compliant
13.560268	0.268	+50 °C & 100% voltage	compliant

**Result:** Voltage variation

Frequency tolerance			
Measured frequency (MHz)	Frequency error (kHz)	Conditions	Result
13.560209	0.209	+20 °C & 85% voltage	compliant
13.560400	0.400	+20 °C & 100% voltage	compliant
13.560210	0.210	+20 °C & 115% voltage	compliant

## 13 Observations

No observations except those reported with the single test cases have been made.

## 14 Glossary

<b>EUT</b>	Equipment under test
<b>DUT</b>	Device under test
<b>UUT</b>	Unit under test
<b>GUE</b>	GNSS User Equipment
<b>ETSI</b>	European Telecommunications Standards Institute
<b>EN</b>	European Standard
<b>FCC</b>	Federal Communications Commission
<b>FCC ID</b>	Company Identifier at FCC
<b>IC</b>	Industry Canada
<b>PMN</b>	Product marketing name
<b>HMN</b>	Host marketing name
<b>HVIN</b>	Hardware version identification number
<b>FVIN</b>	Firmware version identification number
<b>EMC</b>	Electromagnetic Compatibility
<b>HW</b>	Hardware
<b>SW</b>	Software
<b>Inv. No.</b>	Inventory number
<b>S/N or SN</b>	Serial number
<b>C</b>	Compliant
<b>NC</b>	Not compliant
<b>NA</b>	Not applicable
<b>NP</b>	Not performed
<b>PP</b>	Positive peak
<b>QP</b>	Quasi peak
<b>AVG</b>	Average
<b>OC</b>	Operating channel
<b>OCW</b>	Operating channel bandwidth
<b>OBW</b>	Occupied bandwidth
<b>OOB</b>	Out of band
<b>DFS</b>	Dynamic frequency selection
<b>CAC</b>	Channel availability check
<b>OP</b>	Occupancy period
<b>NOP</b>	Non occupancy period
<b>DC</b>	Duty cycle
<b>PER</b>	Packet error rate
<b>CW</b>	Clean wave
<b>MC</b>	Modulated carrier
<b>WLAN</b>	Wireless local area network
<b>RLAN</b>	Radio local area network
<b>DSSS</b>	Dynamic sequence spread spectrum
<b>OFDM</b>	Orthogonal frequency division multiplexing
<b>FHSS</b>	Frequency hopping spread spectrum
<b>GNSS</b>	Global Navigation Satellite System
<b>C/N<sub>0</sub></b>	Carrier to noise-density ratio, expressed in dB-Hz

## 15 Document history

Version	Applied changes	Date of release
-/-	Initial release	2021-03-10
A	Editorial changes, HMN removed	2021-03-15

## 16 Accreditation Certificate – D-PL-12076-01-04

first page	last page
 <p>Deutsche Akkreditierungsstelle GmbH</p> <p>Entrusted according to Section 8 subsection 1 AkkStelleG in connection with Section 1 subsection 1 AkkStelleGBV Signatory to the Multilateral Agreements of EA, ILAC and IAF for Mutual Recognition</p> <p><b>Accreditation</b> </p> <p>The Deutsche Akkreditierungsstelle GmbH attests that the testing laboratory <b>CTC advanced GmbH</b> Untertürkheimer Straße 6-10, 66117 Saarbrücken is competent under the terms of DIN EN ISO/IEC 17025:2018 to carry out tests in the following fields: <b>Telecommunication (TC) and Electromagnetic Compatibility (EMC) for Canadian Standards</b></p> <p>The accreditation certificate shall only apply in connection with the notice of accreditation of 09.06.2020 with the accreditation number D-PL-12076-01. It comprises the cover sheet, the reverse side of the cover sheet and the following annex with a total of 07 pages. Registration number of the certificate: <b>D-PL-12076-01-04</b></p> <p>Frankfurt am Main, 09.06.2020</p> <p>by order  Dipl.-Ing. (FH) Ralf Egner Head of Division</p> <p><small>The certificate together with its annex reflects the status at the time of the date of issue. The current status of the scope of accreditation can be found in the database of accredited bodies of Deutsche Akkreditierungsstelle GmbH. <a href="https://www.dakks.de/en/content/accredited-bodies-dakks">https://www.dakks.de/en/content/accredited-bodies-dakks</a> 16.04.2021 10:00:00</small></p>	<p>Deutsche Akkreditierungsstelle GmbH</p> <p>Office Berlin Spittelmarkt 10 10117 Berlin</p> <p>Office Frankfurt am Main Europa-Allee 52 60327 Frankfurt am Main</p> <p>Office Braunschweig Bundesallee 100 38116 Braunschweig</p> <p>The publication of extracts of the accreditation certificate is subject to the prior written approval by Deutsche Akkreditierungsstelle GmbH (DAkKS). Exempted is the unchanged form of separate disseminations of the cover sheet by the conformity assessment body mentioned overleaf.</p> <p>No impression shall be made that the accreditation also extends to fields beyond the scope of accreditation attested by DAkKS.</p> <p>The accreditation was granted pursuant to the Act on the Accreditation Body (AkkStelleG) of 31 July 2009 (Federal Law Gazette I p. 2625) and the Regulation (EC) No 765/2008 of the European Parliament and of the Council of 9 July 2008 setting out the requirements for accreditation and market surveillance relating to the marketing of products (Official Journal of the European Union L 218 of 9 July 2008, p. 30). DAkKS is a signatory to the Multilateral Agreements for Mutual Recognition of the European co-operation for Accreditation (EA), International Accreditation Forum (IAF) and International Laboratory Accreditation Cooperation (ILAC). The signatories to these agreements recognise each other's accreditations.</p> <p>The up-to-date state of membership can be retrieved from the following websites: EA: <a href="http://www.european-accreditation.org">www.european-accreditation.org</a> ILAC: <a href="http://www.ilac.org">www.ilac.org</a> IAF: <a href="http://www.iaf.org">www.iaf.org</a></p>

**Note: The current certificate annex is published on the website (link see below) of the Accreditation Body DAkKS or may be received by CTC advanced GmbH on request**

<https://www.dakks.de/as/ast/d/D-PL-12076-01-04e.pdf>



**17 Accreditation Certificate – D-PL-12076-01-05**

first page	last page			
 <p>Deutsche Akkreditierungsstelle GmbH</p> <p>Entrusted according to Section 8 subsection 1 AkkStelleG in connection with Section 1 subsection 1 AkkStelleGBV Signatory to the Multilateral Agreements of EA, ILAC and IAF for Mutual Recognition</p> <p><b>Accreditation</b> </p> <p>The Deutsche Akkreditierungsstelle GmbH attests that the testing laboratory <b>CTC advanced GmbH</b> Untertürkheimer Straße 6-10, 66117 Saarbrücken is competent under the terms of DIN EN ISO/IEC 17025:2018 to carry out tests in the following fields:</p> <p><b>Telecommunication (FCC Requirements)</b></p> <p>The accreditation certificate shall only apply in connection with the notice of accreditation of 09.06.2020 with the accreditation number D-PL-12076-01. It comprises the cover sheet, the reverse side of the cover sheet and the following annex with a total of 05 pages.</p> <p>Registration number of the certificate: <b>D-PL-12076-01-05</b></p> <p>Frankfurt am Main, 09.06.2020  by <b>Dipl.-Ing. (FH) Ralf Egnier</b> Head of Division</p> <p><small>The certificate together with its annex reflects the status at the time of the date of issue. The current status of the scope of accreditation can be found in the database of accredited bodies of Deutsche Akkreditierungsstelle GmbH. <a href="https://www.dakks.de/en/content/accredited-bodies-dakks">https://www.dakks.de/en/content/accredited-bodies-dakks</a> Site under review.</small></p>	<p>Deutsche Akkreditierungsstelle GmbH</p> <table border="0"> <tr> <td>Office Berlin Spittelmarkt 10 10117 Berlin</td> <td>Office Frankfurt am Main Europa-Allee 52 60327 Frankfurt am Main</td> <td>Office Braunschweig Bundesallee 100 38116 Braunschweig</td> </tr> </table> <p>The publication of extracts of the accreditation certificate is subject to the prior written approval by Deutsche Akkreditierungsstelle GmbH (DAkKS). Exempted is the unchanged form of separate disseminations of the cover sheet by the conformity assessment body mentioned overleaf.</p> <p>No impression shall be made that the accreditation also extends to fields beyond the scope of accreditation attested by DAkKS.</p> <p>The accreditation was granted pursuant to the Act on the Accreditation Body (AkkStelleG) of 31 July 2009 (Federal Law Gazette I p. 2625) and the Regulation (EC) No 765/2008 of the European Parliament and of the Council of 9 July 2008 setting out the requirements for accreditation and market surveillance relating to the marketing of products (Official Journal of the European Union L 218 of 9 July 2008, p. 30). DAkKS is a signatory to the Multilateral Agreements for Mutual Recognition of the European co-operation for Accreditation (EA), International Accreditation Forum (IAF) and International Laboratory Accreditation Cooperation (ILAC). The signatories to these agreements recognise each other's accreditations.</p> <p>The up-to-date state of membership can be retrieved from the following websites: EA: <a href="http://www.european-accreditation.org">www.european-accreditation.org</a> ILAC: <a href="http://www.ilac.org">www.ilac.org</a> IAF: <a href="http://www.iaf.nu">www.iaf.nu</a></p>	Office Berlin Spittelmarkt 10 10117 Berlin	Office Frankfurt am Main Europa-Allee 52 60327 Frankfurt am Main	Office Braunschweig Bundesallee 100 38116 Braunschweig
Office Berlin Spittelmarkt 10 10117 Berlin	Office Frankfurt am Main Europa-Allee 52 60327 Frankfurt am Main	Office Braunschweig Bundesallee 100 38116 Braunschweig		

**Note: The current certificate annex is published on the website (link see below) of the Accreditation Body DAkKS or may be received by CTC advanced GmbH on request**

<https://www.dakks.de/as/ast/d/D-PL-12076-01-05e.pdf>

##### END OF TEST REPORT #####