

CETECOM ICT Services is now

CTC | **advanced**
member of RWTÜV group

TEST REPORT

Test report no.: 1-2648/16-01-03



Deutsche
Akkreditierungsstelle
D-PL-12076-01-01

Testing laboratory

CTC advanced GmbH

Untertuerkheimer Strasse 6 – 10

66117 Saarbruecken / Germany

Phone: + 49 681 5 98 - 0

Fax: + 49 681 5 98 - 9075

Internet: <http://www.ctcadvanced.com>

e-mail: mail@ctcadvanced.com

Accredited Testing Laboratory:

The testing laboratory (area of testing) is accredited according to DIN EN ISO/IEC 17025 (2005) by the Deutsche Akkreditierungsstelle GmbH (DAkkS)

The accreditation is valid for the scope of testing procedures as stated in the accreditation certificate with the registration number: D-PL-12076-01-01

Applicant

Ingenico Group

9 Avenue de la Gare Rovaltain

26958 Valence Cedex 9 / FRANCE

Phone: -/-

Fax: -/-

Contact: Jean-Baptiste Palisse

e-mail: jean-baptiste.palisse@ingenico.com

Phone: +33 4 75 84 21 74

Manufacturer

Ingenico Group

9 Avenue de la Gare Rovaltain

26958 Valence Cedex 9 / FRANCE

Test standard/s

47 CFR Part 15	Title 47 of the Code of Federal Regulations; Chapter I; Part 15 - Radio frequency devices
RSS - 247 Issue 2	Digital Transmission Systems (DTSs), Frequency Hopping Systems (FHSs) and Licence - Exempt Local Area Network (LE-LAN) Devices
RSS - Gen Issue 4	Spectrum Management and Telecommunications Radio Standards Specifications - General Requirements and Information for the Certification of Radio Apparatus

For further applied test standards please refer to section 3 of this test report.

Test Item

Kind of test item:	Mobile payment terminal
Model name:	Move/5000 and Move/3500 CL/WiFi/BT/GPS/Camera of BCR
FCC ID:	XKB-M5000CLWIBT
IC:	2586D-M50CLWIBT
Frequency:	DTS band 2400 MHz to 2483.5 MHz
Technology tested:	WLAN (DSSS/b-mode; OFDM/g;n HT20 & 40-mode)
Antenna:	Integrated metallic frame antenna
Power supply:	115 V AC / 5 V DC by mains adapter PSM08A-0501-R 3.6 V DC by battery (F26402376)
Temperature range:	+10°C to +50°C



This test report is electronically signed and valid without handwriting signature. For verification of the electronic signatures, the public keys can be requested at the testing laboratory.

Test report authorized:

Stefan Bös
Lab Manager
Radio Communications & EMC

Test performed:

p.o.
Marco Bertolino
Lab Manager
Radio Communications & EMC

1 Table of contents

1	Table of contents	2
2	General information	3
2.1	Notes and disclaimer	3
2.2	Application details.....	3
2.3	Test laboratories sub-contracted	3
3	Test standard/s and references	4
4	Test environment.....	5
5	Test item.....	5
5.1	General description.....	5
5.2	Additional information	5
6	Description of the test setup.....	6
6.1	Shielded semi anechoic chamber.....	7
6.2	Shielded fully anechoic chamber	8
6.3	Radiated measurements > 18 GHz.....	9
6.4	AC conducted	10
6.5	Conducted measurements with peak power meter & spectrum analyzer.....	11
7	Sequence of testing	12
7.1	Sequence of testing radiated spurious 9 kHz to 30 MHz.....	12
7.2	Sequence of testing radiated spurious 30 MHz to 1 GHz.....	13
7.3	Sequence of testing radiated spurious 1 GHz to 18 GHz	14
7.4	Sequence of testing radiated spurious above 18 GHz	15
8	Measurement uncertainty	16
9	Summary of measurement results	17
10	Additional comments	18
11	Measurement results.....	20
11.1	Antenna gain	20
11.2	Identify worst case data rate	23
11.3	Maximum output power.....	24
11.4	Duty cycle	25
11.5	Peak power spectral density	26
11.6	6 dB DTS bandwidth	40
11.7	Occupied bandwidth – 99% emission bandwidth.....	54
11.8	Occupied bandwidth – 20 dB bandwidth.....	68
11.9	Band edge compliance conducted	81
11.10	Spurious emissions conducted	87
11.11	Spurious emissions radiated below 30 MHz.....	111
11.12	Spurious emissions radiated 30 MHz to 1 GHz.....	118
11.13	Spurious emissions radiated above 1 GHz.....	129
11.14	Spurious emissions conducted below 30 MHz (AC conducted).....	141
12	Observations	144
Annex A	Document history	144
Annex B	Further information.....	144
Annex C	Accreditation Certificate	145

2 General information

2.1 Notes and disclaimer

The test results of this test report relate exclusively to the test item specified in this test report. CTC advanced GmbH does not assume responsibility for any conclusions and generalizations drawn from the test results with regard to other specimens or samples of the type of the equipment represented by the test item.

The test report may only be reproduced or published in full. Reproduction or publication of extracts from the report requires the prior written approval of CTC advanced GmbH.

The testing service provided by CTC advanced GmbH has been rendered under the current "General Terms and Conditions for CTC advanced GmbH".

CTC advanced GmbH will not be liable for any loss or damage resulting from false, inaccurate, inappropriate or incomplete product information provided by the customer.

Under no circumstances does the CTC advanced GmbH test report include any endorsement or warranty regarding the functionality, quality or performance of any other product or service provided.

Under no circumstances does the CTC advanced GmbH test report include or imply any product or service warranties from CTC advanced GmbH, including, without limitation, any implied warranties of merchantability, fitness for purpose, or non-infringement, all of which are expressly disclaimed by CTC advanced GmbH.

All rights and remedies regarding vendor's products and services for which CTC advanced GmbH has prepared this test report shall be provided by the party offering such products or services and not by CTC advanced GmbH. In no case this test report can be considered as a Letter of Approval.

This test report is electronically signed and valid without handwritten signature. For verification of the electronic signatures, the public keys can be requested at the testing laboratory.

2.2 Application details

Date of receipt of order:	2016-12-08
Date of receipt of test item:	2017-01-03
Start of test:	2017-01-04
End of test:	2017-03-22
Person(s) present during the test:	-/-

2.3 Test laboratories sub-contracted

None

3 Test standard/s and references

Test standard	Date	Description
47 CFR Part 15	-/-	Title 47 of the Code of Federal Regulations; Chapter I; Part 15 - Radio frequency devices
RSS - 247 Issue 2	February 2017	Digital Transmission Systems (DTSs), Frequency Hopping Systems (FHSs) and Licence - Exempt Local Area Network (LE-LAN) Devices
RSS - Gen Issue 4	November 2014	Spectrum Management and Telecommunications Radio Standards Specifications - General Requirements and Information for the Certification of Radio Apparatus

Guidance	Version	Description
DTS: KDB 558074 D01	v03r05	Guidance for Performing Compliance Measurements on Digital Transmission Systems (DTS) Operating Under §15.247
ANSI C63.4-2014	-/-	American national standard for methods of measurement of radio-noise emissions from low-voltage electrical and electronic equipment in the range of 9 kHz to 40 GHz
ANSI C63.10-2013	-/-	American national standard of procedures for compliance testing of unlicensed wireless devices

4 Test environment

Temperature	:	T _{nom} T _{max} T _{min}	+22 °C during room temperature tests No tests under extreme temperature conditions required. No tests under extreme temperature conditions required.
Relative humidity content	:		35 %
Barometric pressure	:		1021 hpa
Power supply	:	V _{nom} V _{max} V _{min}	115 V AC / 5 V DC by mains adapter PSM08A-050I-R 3.6 V DC by battery (F26402376) No tests under extreme voltage conditions required. No tests under extreme voltage conditions required.

5 Test item

5.1 General description

Kind of test item	:	Mobile payment terminal
Type identification	:	Move/5000 and Move/3500 CL/WiFi/BT/GPS/Camera of BCR
HMN	:	-/-
PMN	:	Move Series
HVIN	:	Move/5000 CL/WiFi/BT Move/3500 CL/WiFi/BT
FVIN	:	-/-
S/N serial number	:	Radiated unit: 163007333191035601212543 Conducted unit: 163007333191035601212543 (Both units have the same S/N label)
HW hardware status	:	01
SW software status	:	RF test mode
Frequency band	:	DTS band 2400 MHz to 2483.5 MHz (lowest channel 2412 MHz; highest channel 2462 MHz)
Type of radio transmission	:	DSSS, OFDM
Use of frequency spectrum	:	
Type of modulation	:	(D)BPSK, (D)QPSK, 16 – QAM, 64 – QAM
Number of channels	:	11 (20 MHz); 9 (40 MHz)
Antenna	:	Integrated metallic frame antenna
Power supply	:	115 V AC / 5 V DC by mains adapter PSM08A-050I-R 3.6 V DC by battery (F26402376)
Temperature range	:	+10°C to +50°C

5.2 Additional information

The content of the following annexes is defined in the QA. It may be that not all of the listed annexes are necessary for this report, thus some values in between may be missing.

Test setup- and EUT-photos are included in test report: 1-2648/16-01-01_AnnexA
 1-2648/16-01-01_AnnexB
 1-2648/16-01-01_AnnexD

6 Description of the test setup

Typically, the calibrations of the test apparatus are commissioned to and performed by an accredited calibration laboratory. The calibration intervals are determined in accordance with the DIN EN ISO/IEC 17025. In addition to the external calibrations, the laboratory executes comparison measurements with other calibrated test systems or effective verifications. Weekly chamber inspections and range calibrations are performed. Where possible, RF generating and signaling equipment as well as measuring receivers and analyzers are connected to an external high-precision 10 MHz reference (GPS-based or rubidium frequency standard).

In order to simplify the identification of the equipment used at some special tests, some items of test equipment and ancillaries can be provided with an identifier or number in the equipment list below (Lab/Item).

Agenda: Kind of Calibration

k	calibration / calibrated	EK	limited calibration
ne	not required (k, ev, izw, zw not required)	zw	cyclical maintenance (external cyclical maintenance)
ev	periodic self verification	izw	internal cyclical maintenance
Ve	long-term stability recognized	g	blocked for accredited testing
vlk!	Attention: extended calibration interval		
NK!	Attention: not calibrated	*)	next calibration ordered / currently in progress

6.1 Shielded semi anechoic chamber

The radiated measurements are performed in vertical and horizontal plane in the frequency range from 9 kHz to 1 GHz in semi-anechoic chambers. The EUT is positioned on a non-conductive support with a height of 0.80 m above a conductive ground plane that covers the whole chamber. The receiving antennas are conform to specifications ANSI C63. These antennas can be moved over the height range between 1.0 m and 4.0 m in order to search for maximum field strength emitted from EUT. The measurement distances between EUT and receiving antennas are indicated in the test setups for the various frequency ranges. For each measurement, the EUT is rotated in all three axes until the maximum field strength is received. The wanted and unwanted emissions are received by spectrum analyzers where the detector modes and resolution bandwidths over various frequency ranges are set according to requirement ANSI C63.

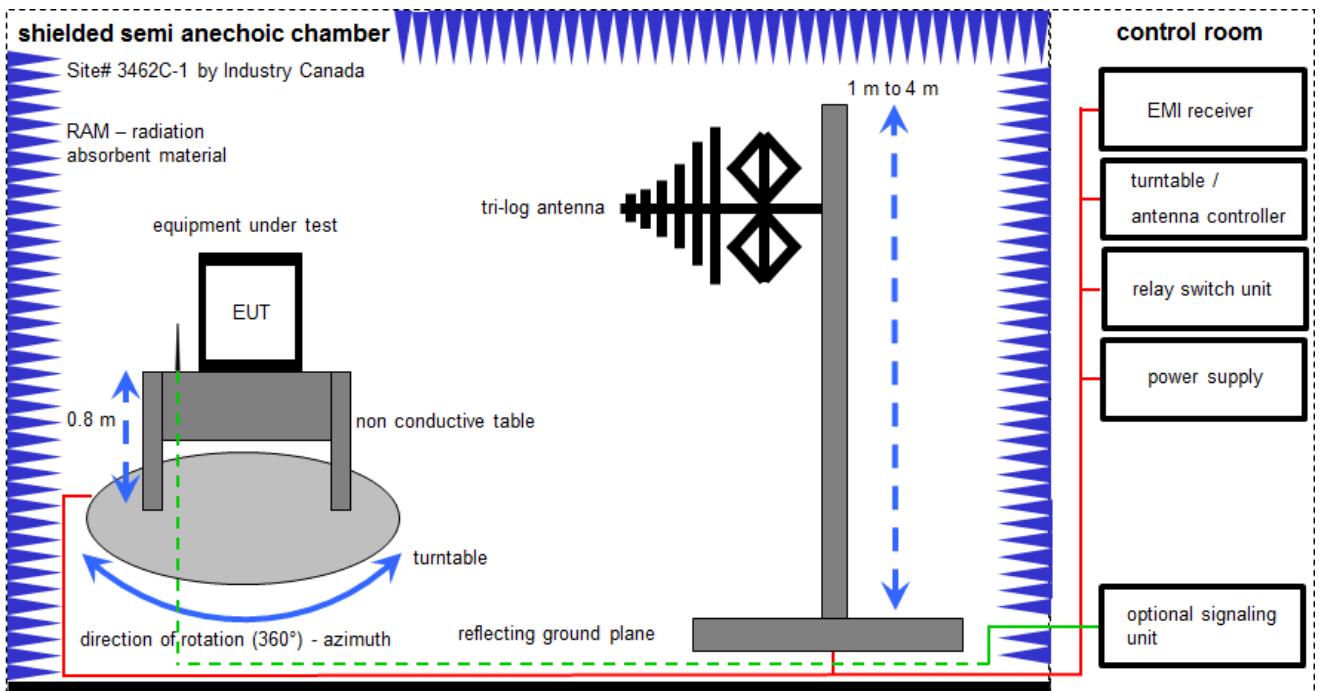

Measurement distance: tri-log antenna 10 meter

$$FS = UR + CL + AF$$

(FS-field strength; UR-voltage at the receiver; CL-loss of the cable; AF-antenna factor)

Example calculation:

$$FS [dB\mu V/m] = 12.35 [dB\mu V/m] + 1.90 [dB] + 16.80 [dB/m] = 31.05 [dB\mu V/m] (35.69 \mu V/m)$$

Equipment table:

No.	Lab / Item	Equipment	Type	Manufacturer	Serial No.	INV. No.	Kind of Calibration	Last Calibration	Next Calibration
1	A	Switch-Unit	3488A	HP	2719A14505	300000368	ev	-/-	-/-
2	A	Meßkabine 1	HF-Absorberhalle	MWB AG 300023	101042	300000551	ne	-/-	-/-
3	A	EMI Test Receiver	ESCI 3	R&S	100083	300003312	k	08.03.2016	08.03.2017
4								01.02.2017	31.01.2018
5	A	Analyzer-Reference-System (Harmonics and Flicker)	ARS 16/1	SPS	A3509 07/0 0205	300003314	Ve	02.02.2016	02.02.2018
6	A	Antenna Tower	Model 2175	ETS-Lindgren	64762	300003745	izw	-/-	-/-
7	A	Positioning Controller	Model 2090	ETS-Lindgren	64672	300003746	izw	-/-	-/-
8	A	Turntable Interface-Box	Model 105637	ETS-Lindgren	44583	300003747	izw	-/-	-/-
9	A	TRILOG Broadband Test-Antenna 30 MHz - 3 GHz	VULB9163	Schwarzbeck	295	300003787	k	25.04.2016	25.04.2018

6.2 Shielded fully anechoic chamber

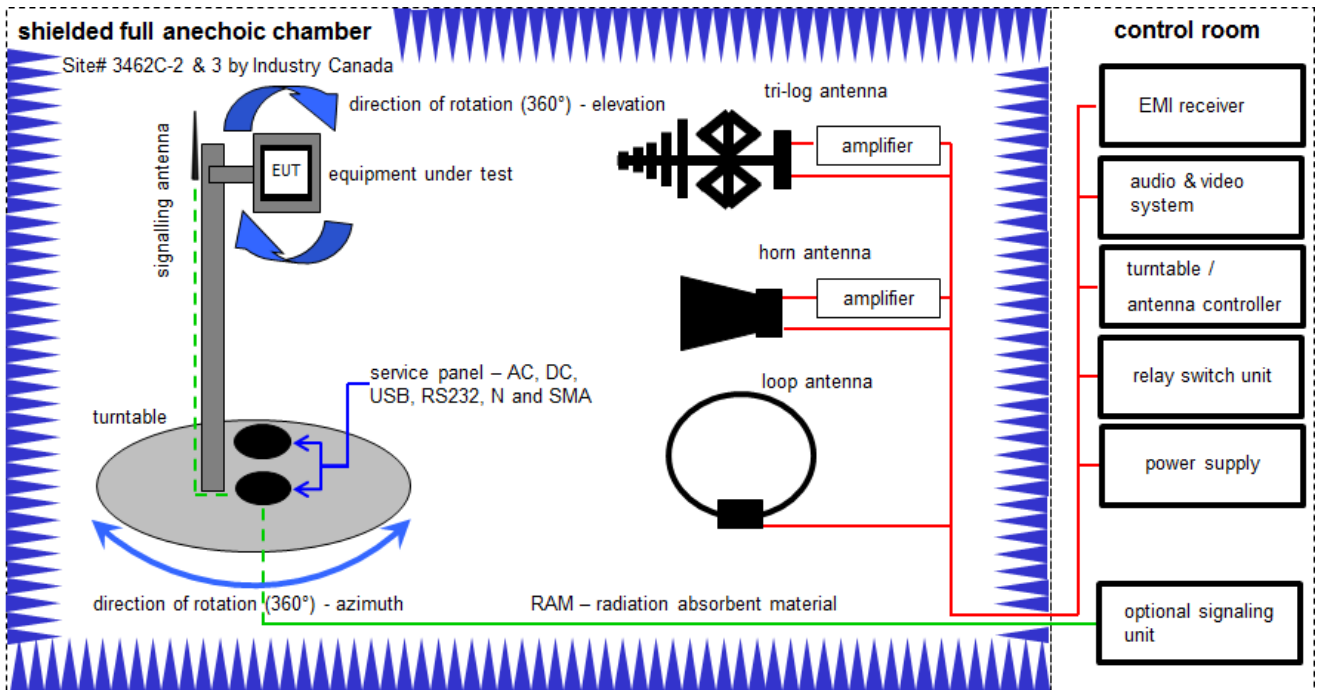

Measurement distance: tri-log antenna and horn antenna 3 meter; loop antenna 3 meter

$$FS = UR + CA + AF$$

(FS-field strength; UR-voltage at the receiver; CA-loss of the signal path; AF-antenna factor)

Example calculation:

$$FS [dB\mu V/m] = 40.0 [dB\mu V/m] + (-35.8) [dB] + 32.9 [dB/m] = 37.1 [dB\mu V/m] (71.61 \mu V/m)$$

Equipment table:

No.	Lab / Item	Equipment	Type	Manufacturer	Serial No.	INV. No.	Kind of Calibration	Last Calibration	Next Calibration
1	C	Active Loop Antenna 10 kHz to 30 MHz	6502	EMCO	2210	300001015	k	20.05.2015	20.05.2017
2	A	Double-Ridged Waveguide Horn Antenna 1-18,0GHz	3115	EMCO	9709-5290	300000212	k	13.08.2015	13.08.2017
3	A	Highpass Filter	WHK1.1/15G-10SS	Wainwright	37	400000148	ne	-/-	-/-
4	A	Highpass Filter	WHKX7.0/18G-8SS	Wainwright	18	300003789	ne	-/-	-/-
5	A	Band Reject Filter	WRCG2400/2483- 2375/2505-50/10SS	Wainwright	26	300003792	ne	-/-	-/-
6	B	TRILOG Broadband Test-Antenna 30 MHz - 3 GHz	VULB9163	Schwarzbeck	318	300003696	k	22.04.2014	22.04.2017
7	A, B	Broadband Amplifier 0.5-18 GHz	CBLU5184540	CERNEK	22051	300004483	ev	-/-	-/-
8	A, B, C	4U RF Switch Platform	L4491A	Agilent Technologies	MY50000032	300004510	ne	-/-	-/-
9	A, B, C	Messrechner und Monitor	Intel Core i3 3220/3,3 GHz, Prozessor	Huber & Suhner	2V2403033A54 21	300004591	ne	-/-	-/-
10	A, B, C	NEXIO EMV- Software	BAT EMC V3.16.0.49	EMCO	Batch no. 14844	300004682	ne	-/-	-/-
11	A, B, C	Anechoic chamber	ESH3-Z5	TDK	893045/004	300003726	ne	-/-	-/-
12	A, B, C	EMI Test Receiver 9kHz-26,5GHz	ESR26	R&S	101376	300005063	vIKI!	13.09.2016	13.03.2018

6.3 Radiated measurements > 18 GHz

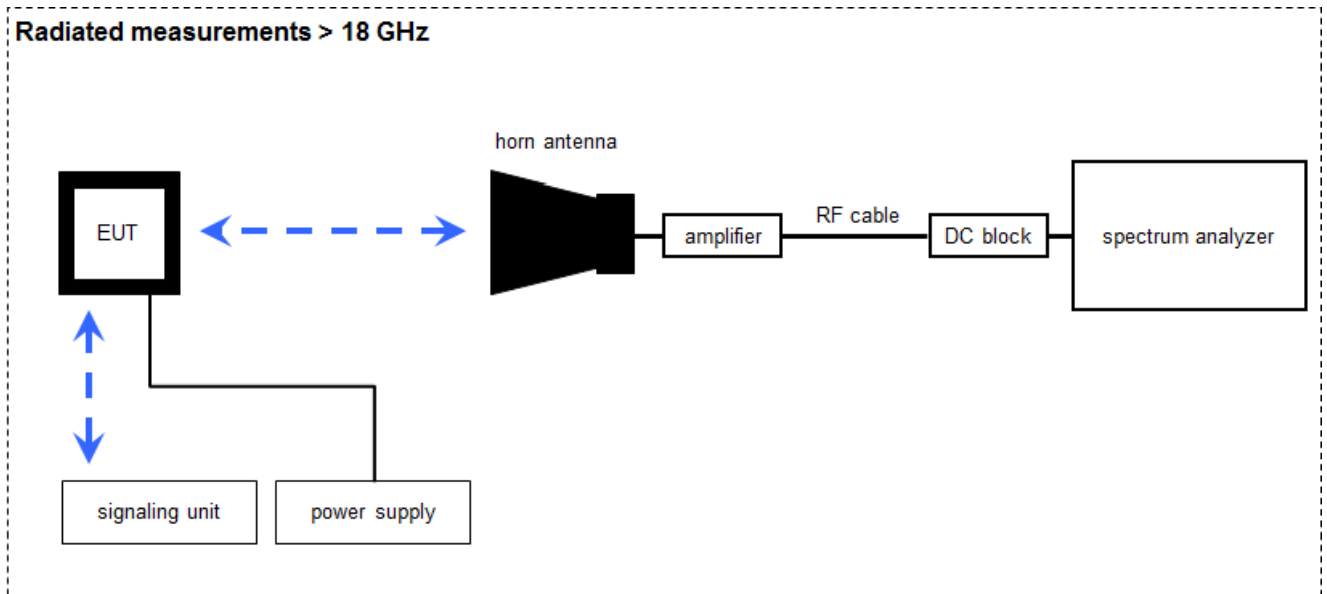

Measurement distance: horn antenna 50 cm

$$FS = U_R + CA + AF$$

(FS-field strength; U_R -voltage at the receiver; CA-loss signal path & distance correction; AF-antenna factor)

Example calculation:

$$FS [dB\mu V/m] = 40.0 [dB\mu V/m] + (-60.1) [dB] + 36.74 [dB/m] = 16.64 [dB\mu V/m] (6.79 \mu V/m)$$

Equipment table:

No.	Lab / Item	Equipment	Type	Manufacturer	Serial No.	INV. No.	Kind of Calibration	Last Calibration	Next Calibration
1	A	Std. Gain Horn Antenna 18.0 to 26.5 GHz	638	Narda	-/-	300000486	k	10.09.2015	10.09.2017
2	A	Signal Analyzer 40 GHz	FSV40	R&S	101042	300004517	k	27.01.2017	26.01.2018
3	A	Amplifier 2-40 GHz	JS32-02004000-57-5P	MITEQ	1777200	300004541	ev	-/-	-/-
4	A	RF-Cable	ST18/SMAm/SMAm/48	Huber & Suhner	Batch no. 600918	400001182	ev	-/-	-/-
5	A	RF-Cable	ST18/SMAm/SMAm/48	Huber & Suhner	Batch no. 127377	400001183	ev	-/-	-/-
6	A	DC-Blocker 0.1-40 GHz	8141A	Inmet	-/-	400001185	ev	-/-	-/-

6.4 AC conducted

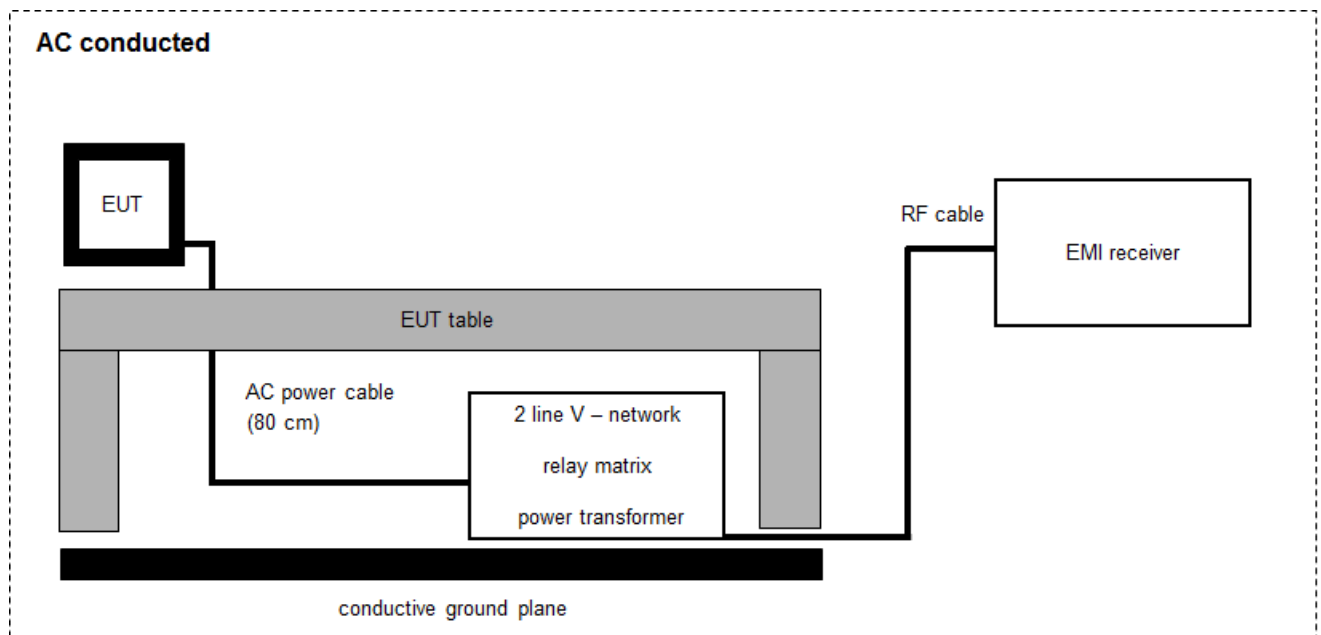

$$FS = UR + CF + VC$$

(FS-field strength; UR-voltage at the receiver; CR-loss of the cable and filter; VC-correction factor of the ISN)

Example calculation:

$$FS [dB\mu V/m] = 37.62 [dB\mu V/m] + 9.90 [dB] + 0.23 [dB] = 47.75 [dB\mu V/m] (244.06 \mu V/m)$$

Equipment table:

No.	Lab / Item	Equipment	Type	Manufacturer	Serial No.	INV. No.	Kind of Calibration	Last Calibration	Next Calibration
1	A	Two-line V-Network (LISN) 9 kHz to 30 MHz	ESH3-Z5	R&S	893045/004	300000584	k	31.01.2017	30.01.2018
2	A	RF-Filter-section	85420E	HP	3427A00162	300002214	k	-/-	-/-
3	A	EM-Injection Clamp	FCC-203i	emv	232	300000626	ev	-/-	-/-
4	A	AC-Spannungsquelle variabel	MV2616-V	EM-Test	0397-12	300003259	k	11.12.2015	11.12.2017
5	A	Hochpass 150 kHz	EZ-25	R&S	100010	300003798	ev	-/-	-/-
6	A	MXE EMI Receiver 20 Hz to 26,5 GHz	N9038A	Agilent Technologies	MY51210197	300004405	k	16.08.2016	16.08.2017

6.5 Conducted measurements with peak power meter & spectrum analyzer

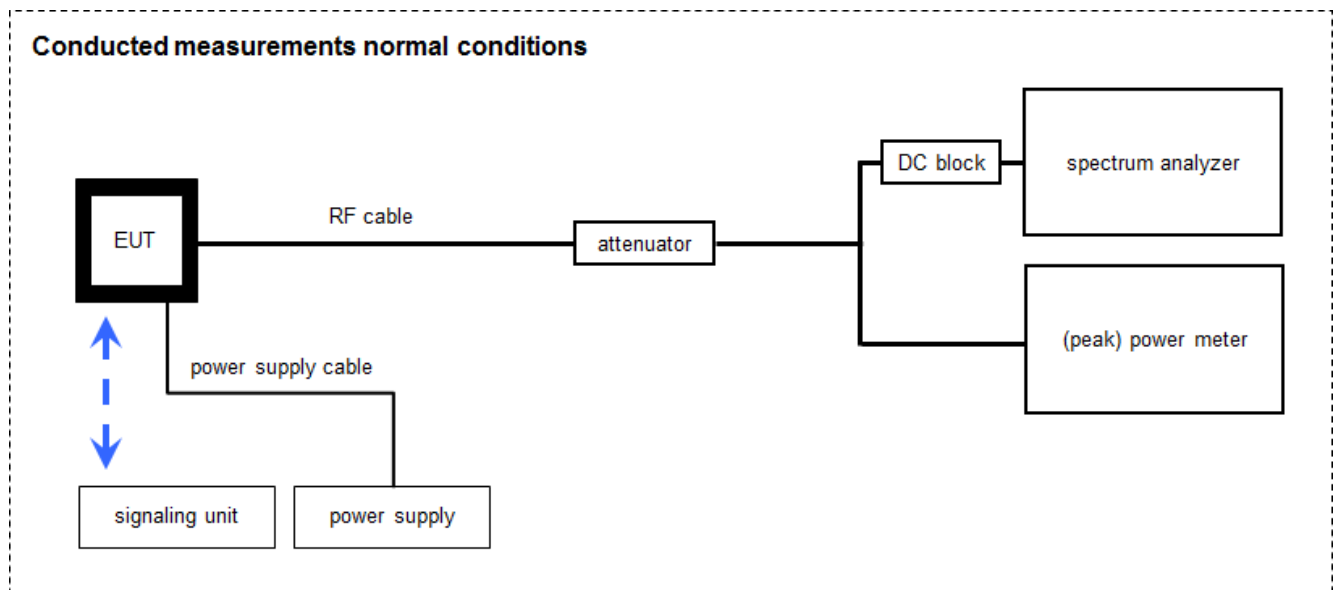

OP = AV + CA
 (OP-output power; AV-analyzer value; CA-loss signal path)

Example calculation:

OP [dBm] = 6.0 [dBm] + 11.7 [dB] = 17.7 [dBm] (58.88 mW)

Equipment table:

No.	Lab / Item	Equipment	Type	Manufacturer	Serial No.	INV. No.	Kind of Calibration	Last Calibration	Next Calibration
1	A, B	Switch / Control Unit	3488A	HP	2719A15013	300000151	ne	-/-	-/-
2	A, B	PC-WLAN Tester	Intel Core i3 3220/3,3 GHz, Prozessor	R&S	2V2403033A45 23	300004589	ne	-/-	-/-
3	A, B	Teststand	Teststand Custom Sequence Editor	National Instruments GmbH	2V2403033A45 23	300004590	ne	-/-	-/-
4	A	Wideband Power Sensor, 50 MHz to 18 GHz	NRP-Z81	R&S	102585	300004863	k	27.01.2017	26.01.2019
5	A, B	PowerSplitter/Combiner 150-6000MHz N-Type	ZB3PD-63-N+	Mini-Circuits	100010	400000451	ev	-/-	-/-
6	A, B	RF-Cable	ST18/SMAm/SMAm/60	Huber & Suhner	Batch no. 606844	400001181	ev	-/-	-/-
7	A, B	Coax Attenuator 10 dB 2W 0-40 GHz	MCL BW-K10-2W44+	Mini Circuits	Batch no. 606844	400001186	ev	-/-	-/-
8	B	DC-Blocker 0.1-40 GHz	8141A	Inmet	Batch no. 127377	400001185	ev	-/-	-/-
9	B	Signal Analyzer 40 GHz	FSV40	R&S	101042	300004517	k	27.01.2017	26.01.2018

7 Sequence of testing

7.1 Sequence of testing radiated spurious 9 kHz to 30 MHz

Setup

- The equipment is set up to simulate normal operation mode as described in the user manual or defined by the manufacturer.
- If the EUT is a tabletop system, a 2-axis positioner with 1.5 m height is used.
- If the EUT is a floor standing device, it is placed directly on the turn table.
- Auxiliary equipment and cables are positioned to simulate normal operation conditions as described in ANSI C 63.4.
- The AC power port of the EUT (if available) is connected to a power outlet below the turntable.
- Measurement distance is 3 m (see ANSI C 63.4) – see test details.
- EUT is set into operation.

Premeasurement

- The turntable rotates from 0° to 315° using 45° steps.
- The antenna height is 1.5 m.
- At each turntable position the analyzer sweeps with positive-peak detector to find the maximum of all emissions.

Final measurement

- Identified emissions during the premeasurement are maximized by the software by rotating the turntable from 0° to 360°. In case of the 2-axis positioner is used the elevation axis is also rotated from 0° to 360°.
- The final measurement is done in the position (turntable and elevation) causing the highest emissions with quasi-peak (as described in ANSI C 63.4).
- Final levels, frequency, measuring time, bandwidth, turntable position, correction factor, margin to the limit and limit will be recorded. A plot with the graph of the premeasurement and the limit is stored.

7.2 Sequence of testing radiated spurious 30 MHz to 1 GHz

Setup

- The equipment is set up to simulate normal operation mode as described in the user manual or defined by the manufacturer.
- If the EUT is a tabletop system, a table with 0.8 m height is used, which is placed on the ground plane.
- If the EUT is a floor standing device, it is placed on the ground plane with insulation between both.
- Auxiliary equipment and cables are positioned to simulate normal operation conditions as described in ANSI C 63.4.
- The AC power port of the EUT (if available) is connected to a power outlet below the turntable.
- Measurement distance is 10 m or 3 m (see ANSI C 63.4) – see test details.
- EUT is set into operation.

Premeasurement

- The turntable rotates from 0° to 315° using 45° steps.
- The antenna is polarized vertical and horizontal.
- The antenna height changes from 1 m to 3 m.
- At each turntable position, antenna polarization and height the analyzer sweeps three times in peak to find the maximum of all emissions.

Final measurement

- The final measurement is performed for at least six highest peaks according to the requirements of the ANSI C63.4.
- Based on antenna and turntable positions at which the peak values are measured the software maximize the peaks by changing turntable position $\pm 45^\circ$ and antenna height between 1 and 4 m.
- The final measurement is done with quasi-peak detector (as described in ANSI C 63.4).
- Final levels, frequency, measuring time, bandwidth, antenna height, antenna polarization, turntable angle, correction factor, margin to the limit and limit are recorded. A plot with the graph of the premeasurement with marked maximum final results and the limit is stored.

7.3 Sequence of testing radiated spurious 1 GHz to 18 GHz

Setup

- The equipment is set up to simulate normal operation mode as described in the user manual or defined by the manufacturer.
- If the EUT is a tabletop system, a 2-axis positioner with 1.5 m height is used.
- If the EUT is a floor standing device, it is placed directly on the turn table.
- Auxiliary equipment and cables are positioned to simulate normal operation conditions as described in ANSI C 63.4.
- The AC power port of the EUT (if available) is connected to a power outlet below the turntable.
- Measurement distance is 3 m (see ANSI C 63.4) – see test details.
- EUT is set into operation.

Premeasurement

- The turntable rotates from 0° to 315° using 45° steps.
- The antenna is polarized vertical and horizontal.
- The antenna height is 1.5 m.
- At each turntable position and antenna polarization the analyzer sweeps with positive peak detector to find the maximum of all emissions.

Final measurement

- The final measurement is performed for at least six highest peaks according to the requirements of the ANSI C63.4.
- Based on antenna and turntable positions at which the peak values are measured the software maximizes the peaks by rotating the turntable from 0° to 360°. This measurement is repeated for different EUT-table positions (0° to 150° in 30°-steps) and for both antenna polarizations.
- The final measurement is done in the position (turntable, EUT-table and antenna polarization) causing the highest emissions with Peak and RMS detector (as described in ANSI C 63.4).
- Final levels, frequency, measuring time, bandwidth, turntable position, EUT-table position, antenna polarization, correction factor, margin to the limit and limit are recorded. A plot with the graph of the premeasurement with marked maximum final results and the limit is stored.

7.4 Sequence of testing radiated spurious above 18 GHz

Setup

- The equipment is set up to simulate normal operation mode as described in the user manual or defined by the manufacturer.
- Auxiliary equipment and cables are positioned to simulate normal operation conditions as described in ANSI C 63.4.
- The AC power port of the EUT (if available) is connected to a power outlet.
- The measurement distance is as appropriate (e.g. 0.5 m).
- The EUT is set into operation.

Premeasurement

- The test antenna is handheld and moved carefully over the EUT to cover the EUT's whole sphere and different polarizations of the antenna.

Final measurement

- The final measurement is performed at the position and antenna orientation causing the highest emissions with Peak and RMS detector (as described in ANSI C 63.4).
- Final levels, frequency, measuring time, bandwidth, correction factor, margin to the limit and limit are recorded. A plot with the graph of the premeasurement and the limit is stored.

8 Measurement uncertainty

Measurement uncertainty	
Test case	Uncertainty
Antenna gain	± 3 dB
Power spectral density	± 1.5 dB
DTS bandwidth	± 100 kHz (depends on the used RBW)
Occupied bandwidth	± 100 kHz (depends on the used RBW)
Maximum output power	± 1.5 dB
Detailed spurious emissions @ the band edge - conducted	± 1.5 dB
Band edge compliance radiated	± 3 dB
Spurious emissions conducted	± 3 dB
Spurious emissions radiated below 30 MHz	± 3 dB
Spurious emissions radiated 30 MHz to 1 GHz	± 3 dB
Spurious emissions radiated 1 GHz to 12.75 GHz	± 3.7 dB
Spurious emissions radiated above 12.75 GHz	± 4.5 dB
Spurious emissions conducted below 30 MHz (AC conducted)	± 2.6 dB

9 Summary of measurement results

<input checked="" type="checkbox"/>	No deviations from the technical specifications were ascertained
<input type="checkbox"/>	There were deviations from the technical specifications ascertained
<input type="checkbox"/>	This test report is only a partial test report. The content and verdict of the performed test cases are listed below.

TC Identifier	Description	Verdict	Date	Remark
RF-Testing	CFR Part 15 RSS - 247, Issue 2	See table!	2017-03-23	-/-

Test specification clause	Test case	Guideline	Temperature conditions	Power source voltages	Mode	C	NC	NA	NP	Remark
§15.247(b)(4) RSS - 247 / 5.4 (d)	Antenna gain	-/-	Nominal	Nominal	DSSS		-/-			-/-
RSS - 247 / 6.0	Duty cycle	-/-	Nominal	Nominal	DSSS OFDM		-/-			-/-
§15.247(e) RSS - 247 / 5.2 (b)	Power spectral density	KDB 558074 DTS clause: 10.2	Nominal	Nominal	DSSS OFDM	<input checked="" type="checkbox"/>	<input type="checkbox"/>	<input type="checkbox"/>	<input type="checkbox"/>	-/-
§15.247(a)(2) RSS - 247 / 5.2 (a)	DTS bandwidth	KDB 558074 DTS clause: 8.1	Nominal	Nominal	DSSS OFDM	<input checked="" type="checkbox"/>	<input type="checkbox"/>	<input type="checkbox"/>	<input type="checkbox"/>	-/-
RSS Gen clause 4.6.1	Occupied bandwidth	-/-	Nominal	Nominal	DSSS OFDM	<input checked="" type="checkbox"/>	<input type="checkbox"/>	<input type="checkbox"/>	<input type="checkbox"/>	-/-
§15.247(b)(3) RSS - 247 / 5.4 (d)	Maximum output power	KDB 558074 DTS clause: 9.1.2	Nominal	Nominal	DSSS OFDM	<input checked="" type="checkbox"/>	<input type="checkbox"/>	<input type="checkbox"/>	<input type="checkbox"/>	-/-
§15.247(d) RSS - 247 / 5.5	Detailed spurious emissions @ the band edge - conducted	-/-	Nominal	Nominal	DSSS OFDM	<input checked="" type="checkbox"/>	<input type="checkbox"/>	<input type="checkbox"/>	<input type="checkbox"/>	-/-
§15.205 RSS - 247 / 5.5 RSS - Gen	Band edge compliance conducted and radiated	KDB 558074 DTS clause: 13.3.2 and clause 12.2.2	Nominal	Nominal	DSSS OFDM	<input checked="" type="checkbox"/>	<input type="checkbox"/>	<input type="checkbox"/>	<input type="checkbox"/>	-/-
§15.247(d) RSS - 247 / 5.5	TX spurious emissions conducted	KDB 558074 DTS clause: 11.1 & 11.2 11.3	Nominal	Nominal	DSSS OFDM	<input checked="" type="checkbox"/>	<input type="checkbox"/>	<input type="checkbox"/>	<input type="checkbox"/>	-/-
§15.209(a) RSS-Gen	TX spurious emissions radiated below 30 MHz	-/-	Nominal	Nominal	DSSS OFDM	<input checked="" type="checkbox"/>	<input type="checkbox"/>	<input type="checkbox"/>	<input type="checkbox"/>	-/-
§15.247(d) RSS - 247 / 5.5 RSS-Gen	TX spurious emissions radiated 30 MHz to 1 GHz	-/-	Nominal	Nominal	DSSS OFDM	<input checked="" type="checkbox"/>	<input type="checkbox"/>	<input type="checkbox"/>	<input type="checkbox"/>	-/-
§15.247(d) RSS - 247 / 5.5 RSS-Gen	TX spurious emissions radiated above 1 GHz	-/-	Nominal	Nominal	DSSS OFDM	<input checked="" type="checkbox"/>	<input type="checkbox"/>	<input type="checkbox"/>	<input type="checkbox"/>	-/-
§15.109 RSS-Gen	RX spurious emissions radiated 30 MHz to 1 GHz	-/-	Nominal	Nominal	RX / idle	<input checked="" type="checkbox"/>	<input type="checkbox"/>	<input type="checkbox"/>	<input type="checkbox"/>	-/-
§15.109 RSS-Gen	RX spurious emissions radiated above 1 GHz	-/-	Nominal	Nominal	RX / idle	<input checked="" type="checkbox"/>	<input type="checkbox"/>	<input type="checkbox"/>	<input type="checkbox"/>	-/-
§15.107(a) §15.207	Conducted emissions < 30 MHz	-/-	Nominal	Nominal	DSSS OFDM	<input checked="" type="checkbox"/>	<input type="checkbox"/>	<input type="checkbox"/>	<input type="checkbox"/>	-/-

Note: C = Compliant; NC = Not compliant; NA = Not applicable; NP = Not performed

10 Additional comments

Reference documents: Customer Questionnaire
 ICO-OPE-03994 Wifi_labtool_Radio_agreement_procedure
 ICO-OPE-04171 Wifi_DFS_Adaptivity_agreement_procedure

Special test descriptions: This test report is valid for both Move/3500 and Move/5000. Both systems use the identical RF parts. The only difference is the touch screen of the Move/5000 series. The different periphery electronics were tested with the worst case series (Move/5000) defined by the customer.

Used power settings for all tests:

Channel	1	2	3	4	5	6	7	8	9	10	11
11b	13	13	13	13	13	13	13	13	13	13	13
11g	14	15	16	16	16	16	16	16	16	16	14
11n-20	13	15	15	15	15	15	15	15	15	15	14
11n-40			10	11	12	13	13	12	10		

The tested devices don't have a designed conducted port for the measurements. The impedance of the output is optimized for the internal antenna. Therefore the impedance of the temporary port doesn't match with the expected 50 Ohm impedance of the test system. This causes lower test results of the conducted measurements. This offset will be considered as "mismatch correction factor" and calculated in chapter 11.1.

Configuration descriptions: None

- Test mode:
- No test mode available.
Iperf was used to ping another device with the largest support packet size
 - Special software is used.
EUT is transmitting pseudo random data by itself
- Antennas and transmit operating modes:
- Operating mode 1 (single antenna)
 - *Equipment with 1 antenna,*
 - *Equipment with 2 diversity antennas operating in switched diversity mode by which at any moment in time only 1 antenna is used,*
 - *Smart antenna system with 2 or more transmit/receive chains, but operating in a mode where only 1 transmit/receive chain is used)*
 - Operating mode 2 (multiple antennas, no beamforming)
 - *Equipment operating in this mode contains a smart antenna system using two or more transmit/receive chains simultaneously but without beamforming.*
 - Operating mode 3 (multiple antennas, with beamforming)
 - *Equipment operating in this mode contains a smart antenna system using two or more transmit/receive chains simultaneously with beamforming.
In addition to the antenna assembly gain (G), the beamforming gain (Y) may have to be taken into account when performing the measurements.*

11 Measurement results

11.1 Antenna gain

Measurement:

The antenna gain of the complete system is calculated by the difference of radiated power in EIRP and the conducted power of the module. For normal WLAN devices, the DSSS mode is used.

Measurement parameters:

Measurement parameter	
Detector:	Peak
Sweep time:	Auto
Resolution bandwidth:	3 MHz
Video bandwidth:	3 MHz
Trace mode:	Max hold

Limits:

FCC	IC
6 dBi / > 6 dBi output power and power density reduction required	

Results:

T _{nom}	V _{nom}	lowest channel 2412 MHz	middle channel 2437 MHz	highest channel 2462 MHz
Conducted power [dBm] Measured with DSSS modulation		4.6	3.7	3.8
Radiated power [dBm] Measured with DSSS modulation		10.3	9.4	9.5
Gain [dBi] Declared by manufacturer		0.0	0.0	0.0
mismatch correction factor [dB] Calculated		5.7	5.7	5.7

Plots: conducted power

Plot 1: low channel

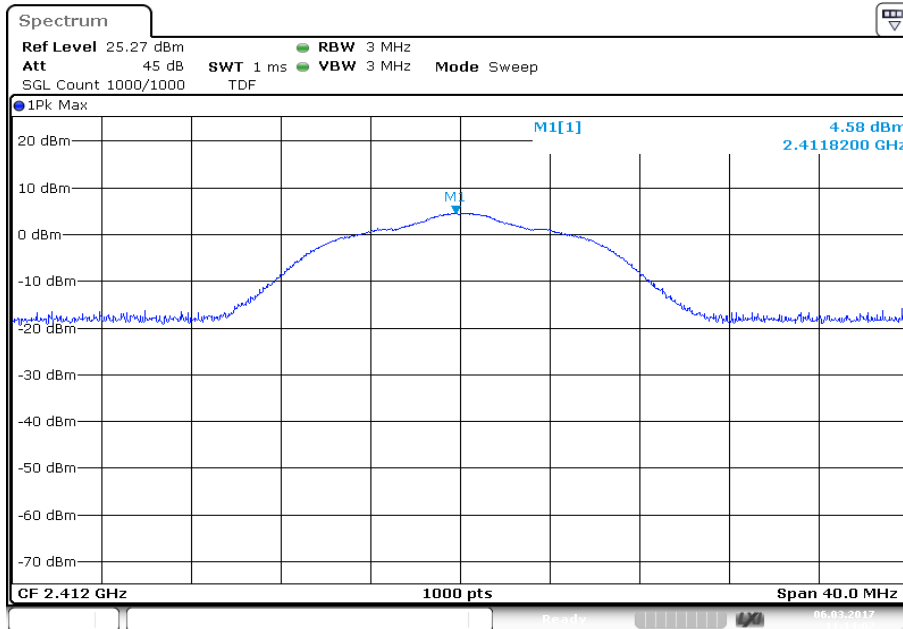

Date: 6.MAR.2017 11:14:02

Plot 2: mid channel

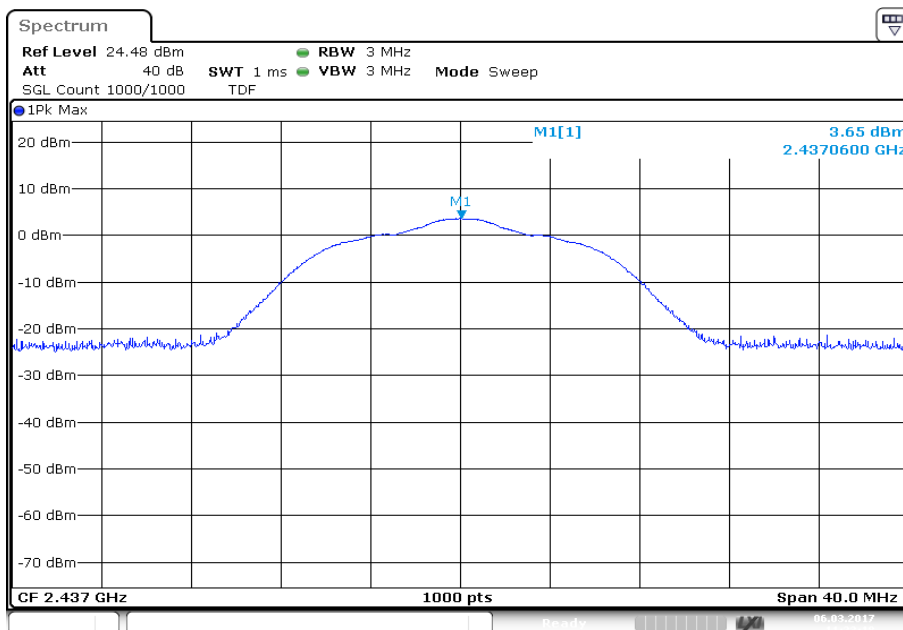

Date: 6.MAR.2017 11:23:19

Plot 3: high channel

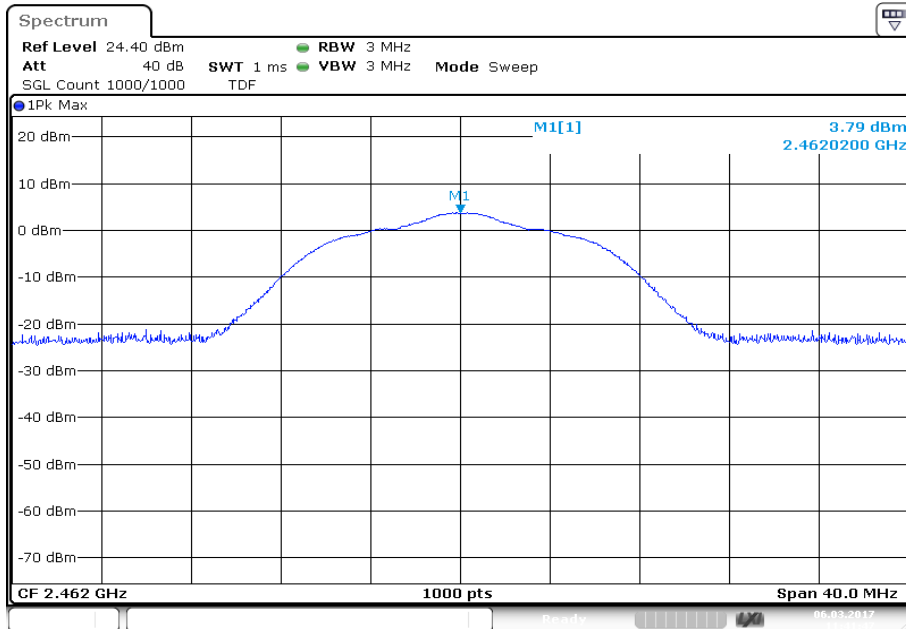

Date: 6.MAR.2017 11:41:47

11.2 Identify worst case data rate

Measurement:

All modes of the module will be measured with an average power meter or spectrum analyzer to identify the maximum transmission power.

In further tests only the identified worst case modulation scheme or bandwidth will be measured and this mode is used as representative mode for all other modulation schemes.

Additional the band edge compliance test will be performed in the lowest and highest modulation scheme.

Measurement parameters:

Measurement parameter	
Detector:	Peak
Sweep time:	Auto
Resolution bandwidth:	3 MHz
Video bandwidth:	3 MHz
Trace mode:	Max hold
Test setup:	See sub clause 6.5 – A
Measurement uncertainty:	-/-

Results:

Modulation	Modulation scheme / bandwidth
DSSS / b – mode	1 Mbit/s
OFDM / g – mode	6 Mbit/s
OFDM / n HT20 – mode	MCS0
OFDM / n HT40 – mode	MCS0

11.3 Maximum output power

Description:

Measurement of the maximum output power conducted and radiated. The measurements are performed using the data rate producing the highest conducted output power.

Measurement:

Measurement parameter	
According to DTS clause: 9.1.2	
Peak power meter	
Test setup:	See sub clause 6.5 – A
Measurement uncertainty	See sub clause 8

Limits:

FCC	IC
Conducted: 1.0 W – Antenna gain with max. 6 dBi	

Results:

Frequency	Maximum Output Power [dBm] incl. mismatch correction factor						
	2412 MHz	2417 MHz	2437 MHz	2457 MHz	2462 MHz		
Output power conducted DSSS / b – mode	13.4		12.6		12.4		
Output power conducted OFDM / g – mode	22.1	22.8	23.0	22.4	21.2		
Output power conducted OFDM / n HT20 – mode	22.0	21.9	21.6	22.0	21.3		
Frequency	2422 MHz	2427 MHz	2432 MHz	2437 MHz	2442 MHz	2447 MHz	2452 MHz
Output power conducted OFDM / n HT40 – mode	16.9	18.4	18.9	20.5	20.5	18.2	20.2

11.4 Duty cycle

Measurement parameters:

Measurement parameter	
Detector:	Peak
Sweep time:	Depends on the signal see plot
Resolution bandwidth:	10 MHz
Video bandwidth:	10 MHz
Trace mode:	Max hold
Test setup:	See sub clause 6.5 - A
Measurement uncertainty:	See sub clause 8

Limits:

FCC	IC
-/-	

Results:

T _{nom}	V _{nom}	All channels
DSSS / b – mode		100.0 % / 0.0 dB
OFDM / g – mode		100.0 % / 0.0 dB
OFDM / n HT20 – mode		100.0 % / 0.0 dB
OFDM / n HT40 – mode		100.0 % / 0.0 dB

11.5 Peak power spectral density

Description:

Measurement of the power spectral density of a digital modulated system. The measurement is repeated for both modulations at the lowest, middle and highest channel.

Measurement:

Measurement parameter	
According to DTS clause: 10.2	
Detector:	Positive Peak
Sweep time:	Auto
Resolution bandwidth:	100 kHz
Video bandwidth:	300 kHz
Span:	30 MHz
Trace mode:	Max hold (allow trace to fully stabilize)
Test setup:	See sub clause 6.5 – A
Measurement uncertainty	See sub clause 8

Limits:

FCC	IC
8 dBm / 3 kHz (conducted)	

Results:

Frequency	Peak power spectral density [dBm] incl. mismatch correction factor							
	2412 MHz	2417 MHz	2437 MHz	2457 MHz	2462 MHz			
DSSS / b – mode	-1.0		-1.3		-1.5			
OFDM / g – mode	-3.6	-2.7	-1.6	-0.1	-4.5			
OFDM / n HT20 – mode	-2.9	-3.0	-3.1	-2.5	-3.5			
Frequency	2422 MHz	2427 MHz	2432 MHz	2437 MHz	2442 MHz	2447 MHz	2452 MHz	
OFDM / n HT40 – mode	-12.2	-10.6	-10.1	-8.4	-8.0	-11.0	-8.9	

Plots: DSSS / b – mode

Plot 1: Channel 1

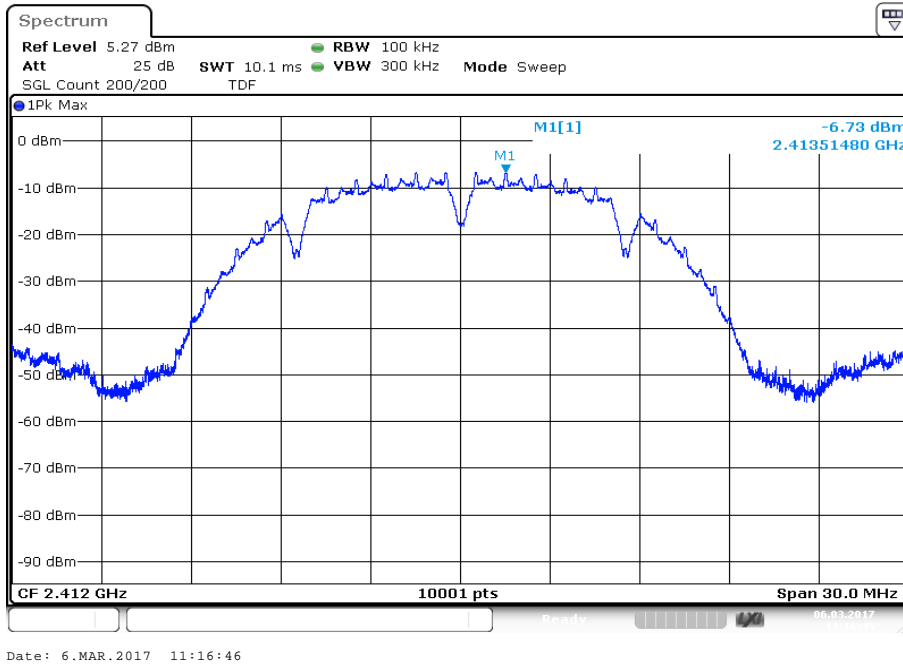

Plot 2: Channel 6

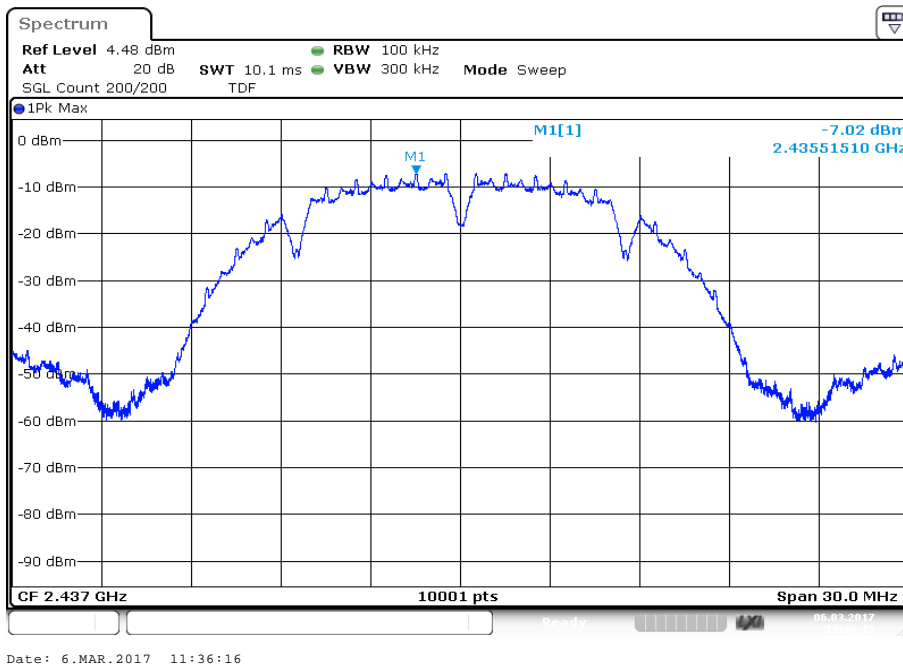

Plot 3: Channel 11

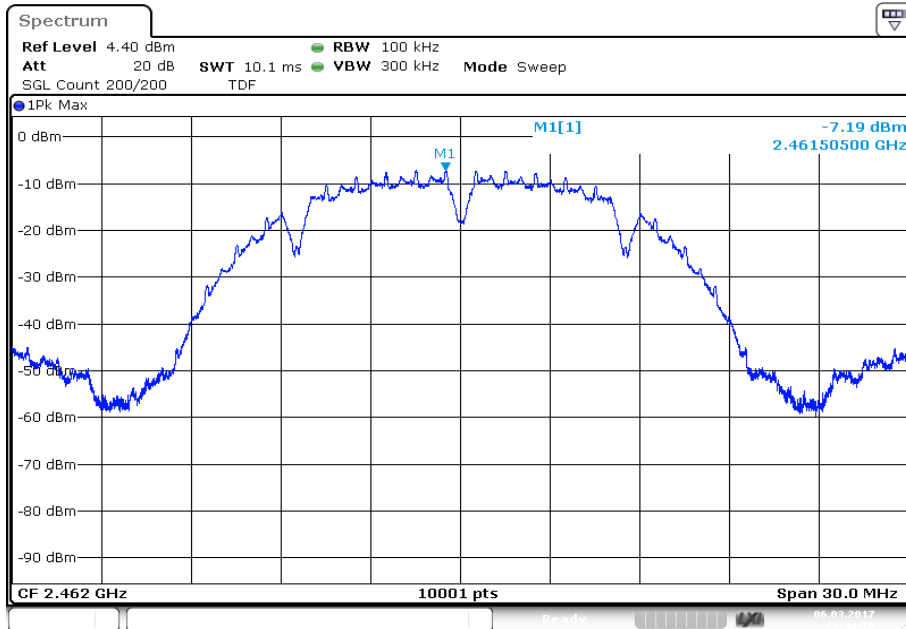

Plots: OFDM / g – mode

Plot 1: Channel 1

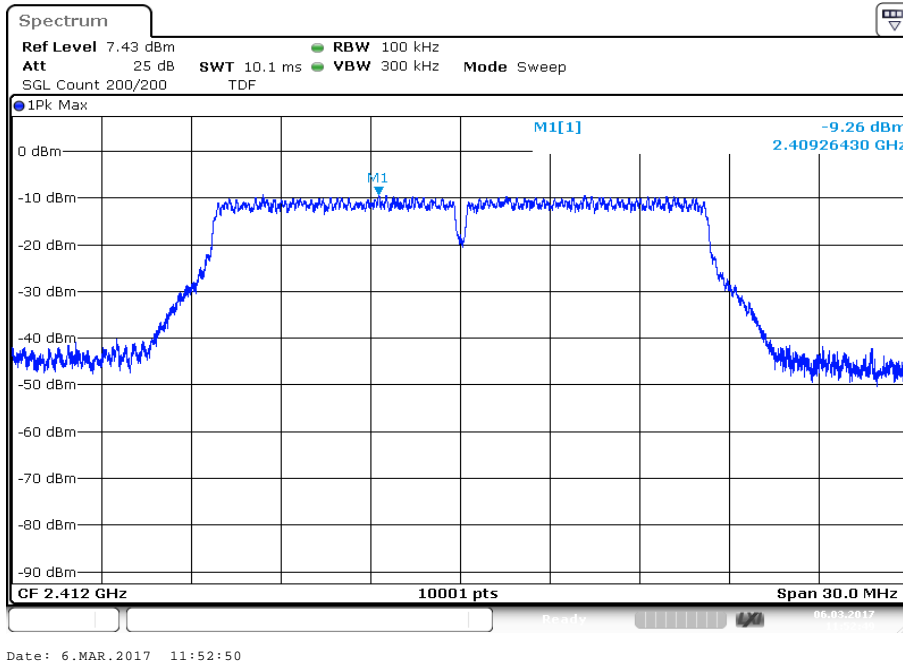

Plot 2: Channel 2

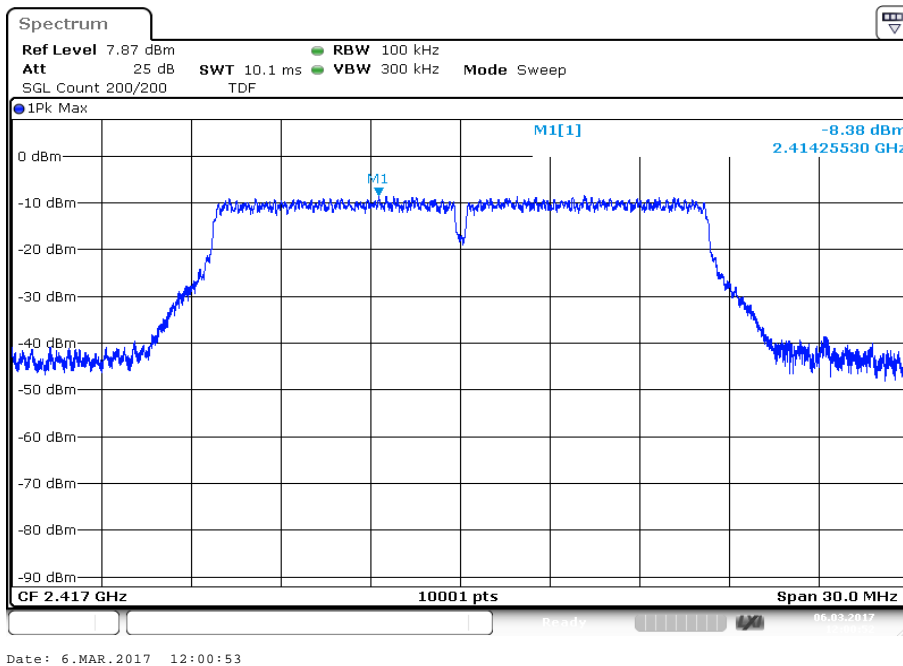

Plot 3: Channel 6

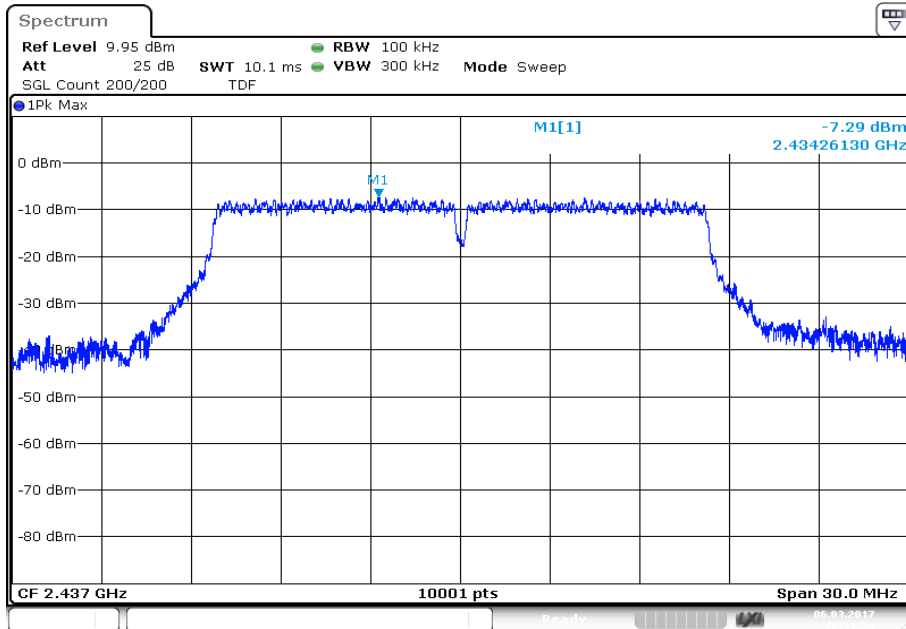

Date: 6.MAR.2017 12:11:24

Plot 4: Channel 10

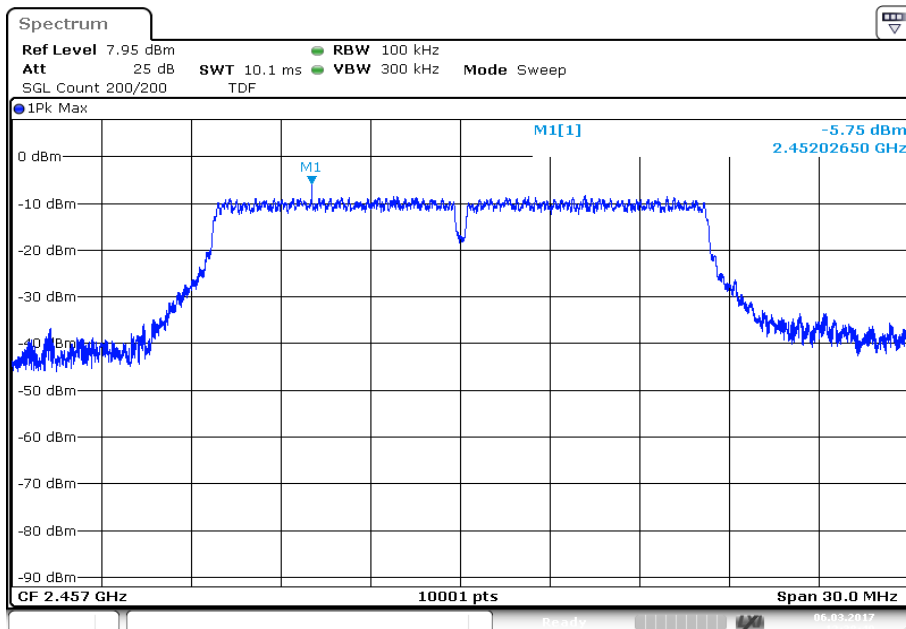

Date: 6.MAR.2017 12:38:40

Plot 5: Channel 11

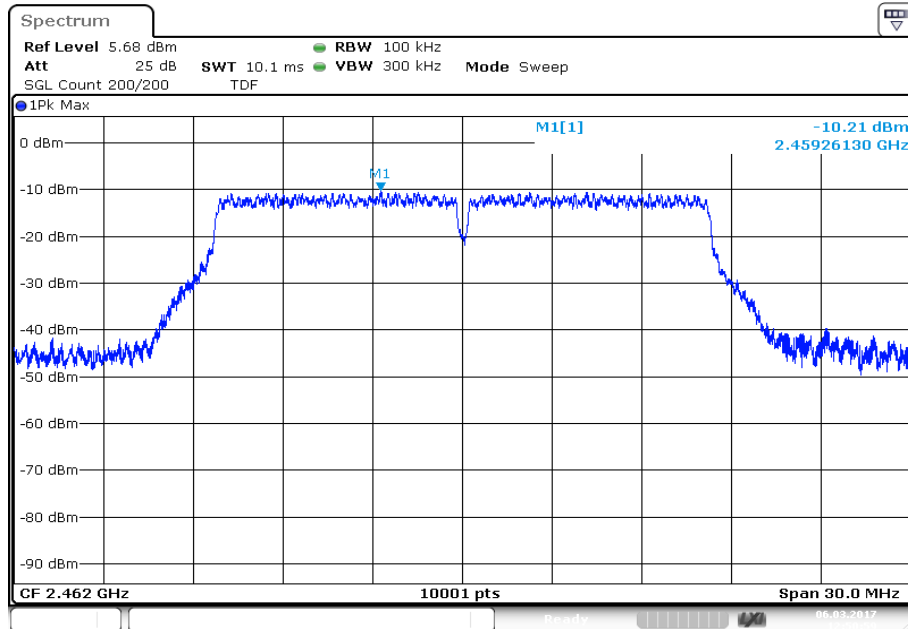

Date: 6.MAR.2017 12:51:00

Plot 3: Channel 6

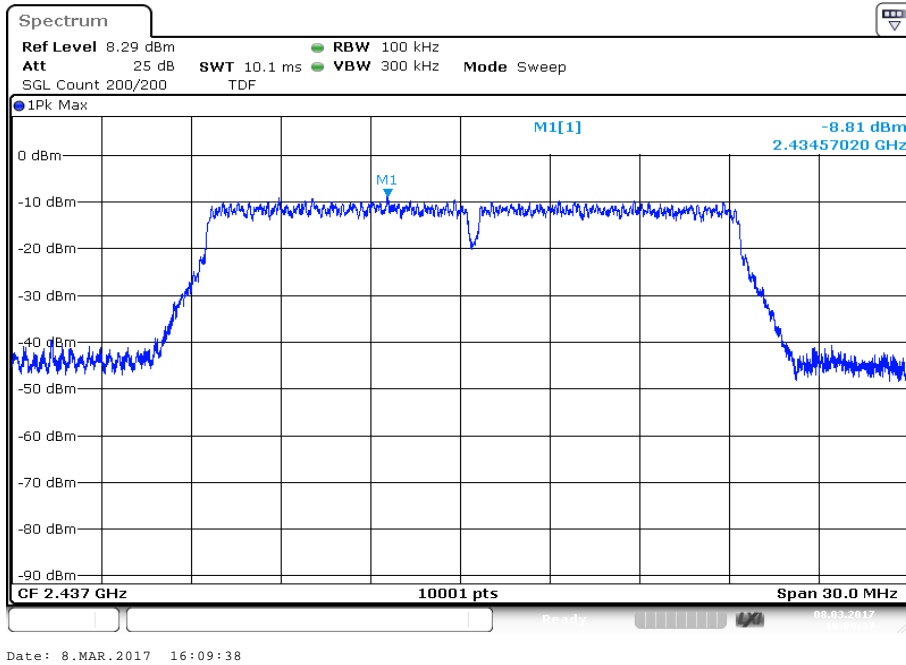

Plot 4: Channel 10

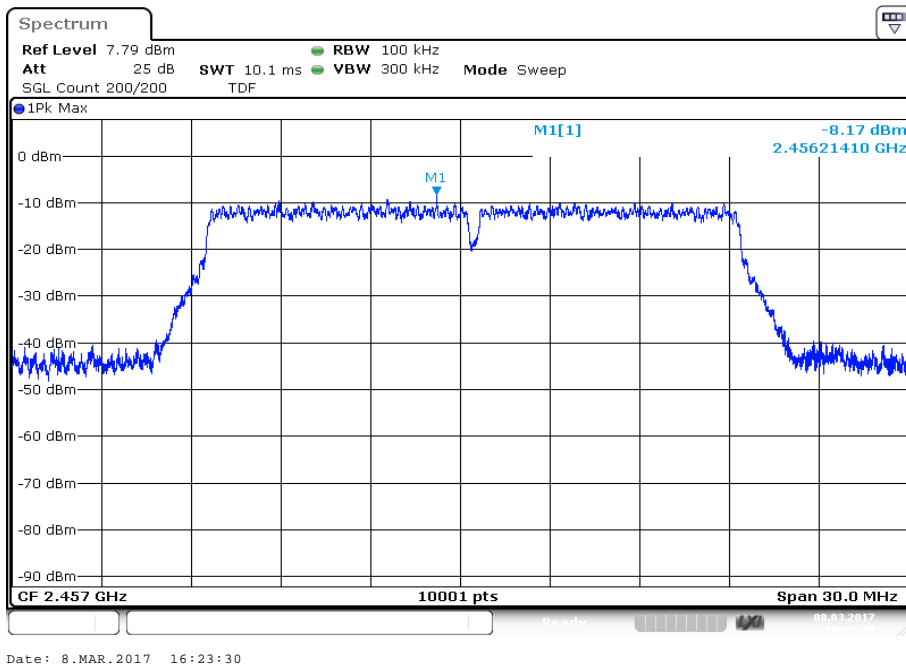

Plot 5: Channel 11

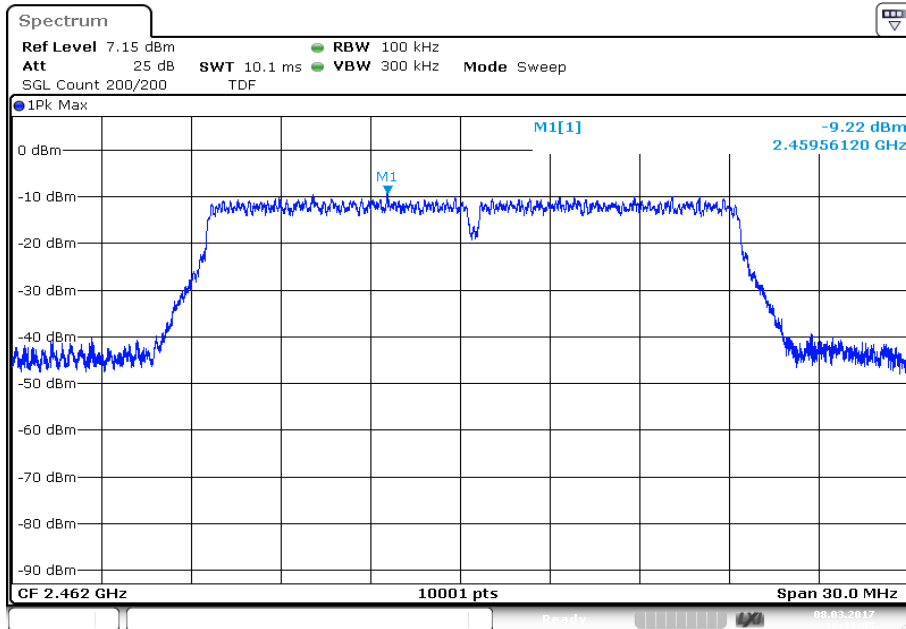

Date: 8.MAR.2017 16:31:05

Plot 7: Channel 9

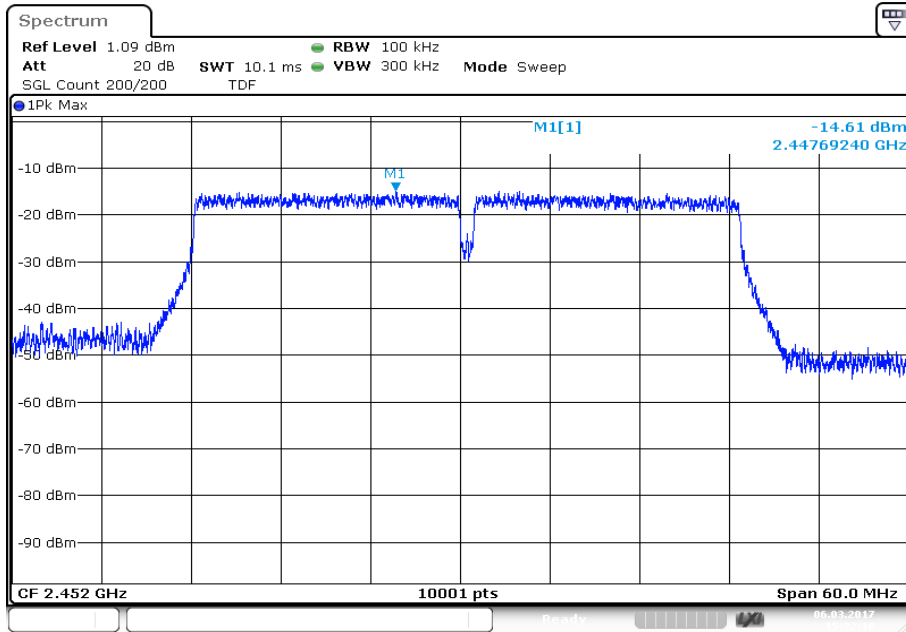

Date: 6.MAR.2017 15:32:18

11.6 6 dB DTS bandwidth

Description:

Measurement of the 6 dB bandwidth of the modulated signal.

Measurement:

Measurement parameter	
According to DTS clause: 8.1	
Detector:	Peak
Sweep time:	Auto
Resolution bandwidth:	100 kHz
Video bandwidth:	500 kHz
Span:	30 MHz / 50 MHz
Trace mode:	Single count with 200 counts
Test setup:	See sub clause 6.5 – A
Measurement uncertainty	See sub clause 8

Limits:

FCC	IC
Systems using digital modulation techniques may operate in the 2400–2483.5 MHz band. The minimum 6 dB bandwidth shall be at least 500 kHz.	

Results:

Frequency	6 dB DTS bandwidth [kHz]						
	2412 MHz	2417 MHz	2437 MHz	2457 MHz	2462 MHz		
DSSS / b – mode	10046		10046		10052		
OFDM / g – mode	16558	16552	16552	16567	16558		
OFDM / n HT20 – mode	17800	17806	17800	17614	17806		
Frequency	2422 MHz	2427 MHz	2432 MHz	2437 MHz	2442 MHz	2447 MHz	2452 MHz
OFDM / n HT40 – mode	36548	36524	36350	36554	36548	36554	36572

Plots: DSSS / b – mode

Plot 1: Channel 1

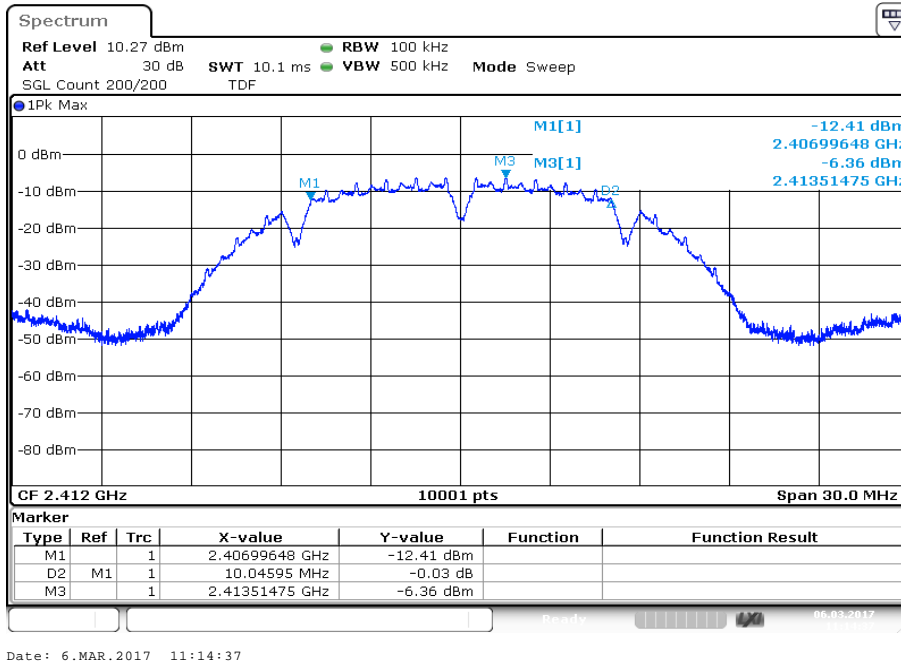

Plot 2: Channel 6

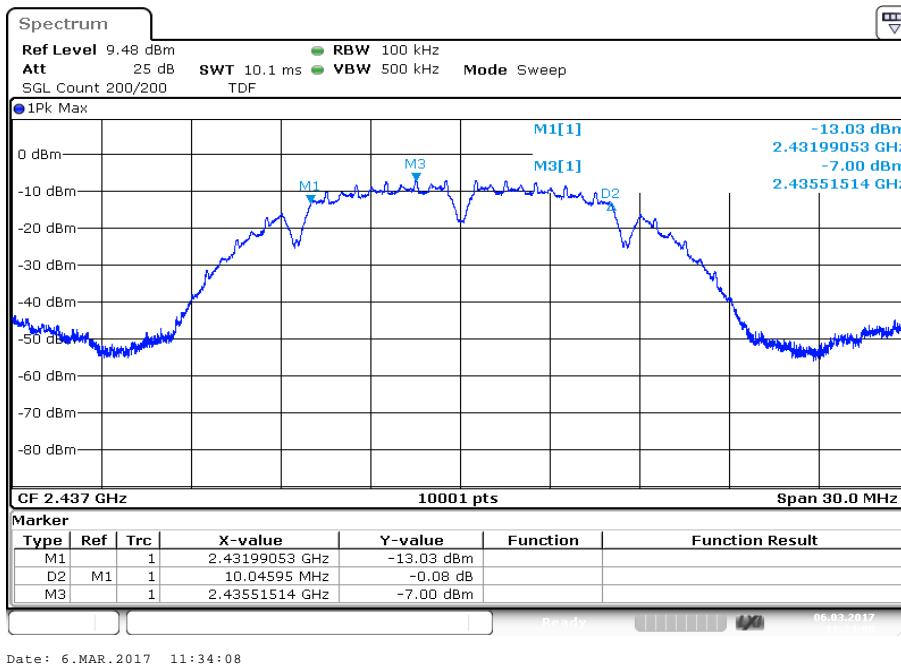

Plot 3: Channel 11

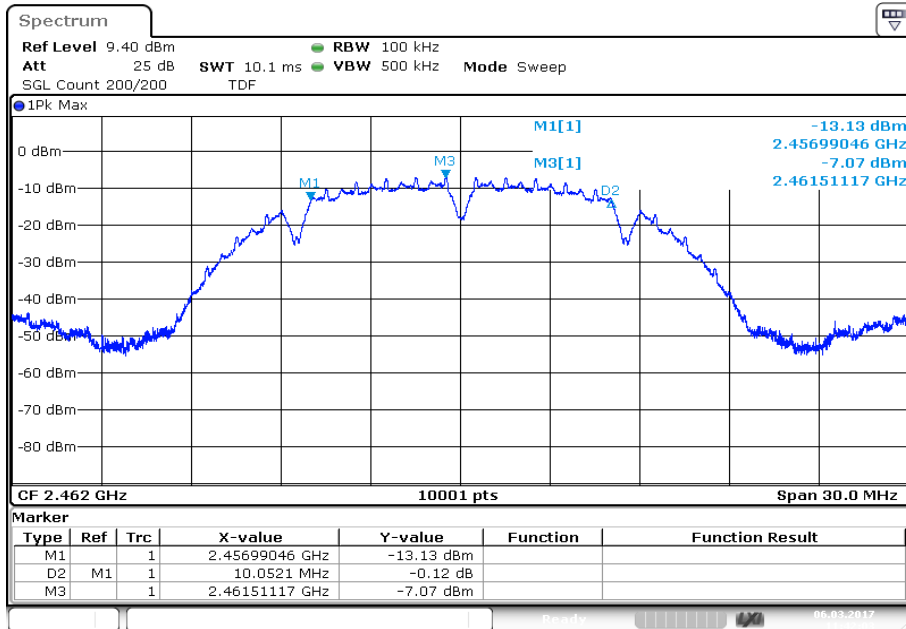

Plots: OFDM / g – mode

Plot 1: Channel 1

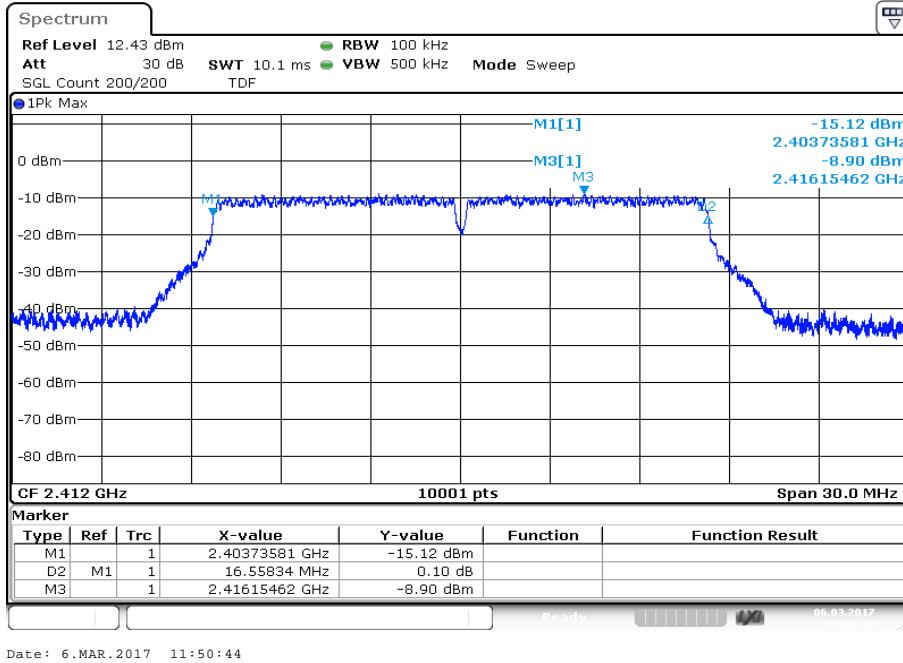

Plot 2: Channel 2

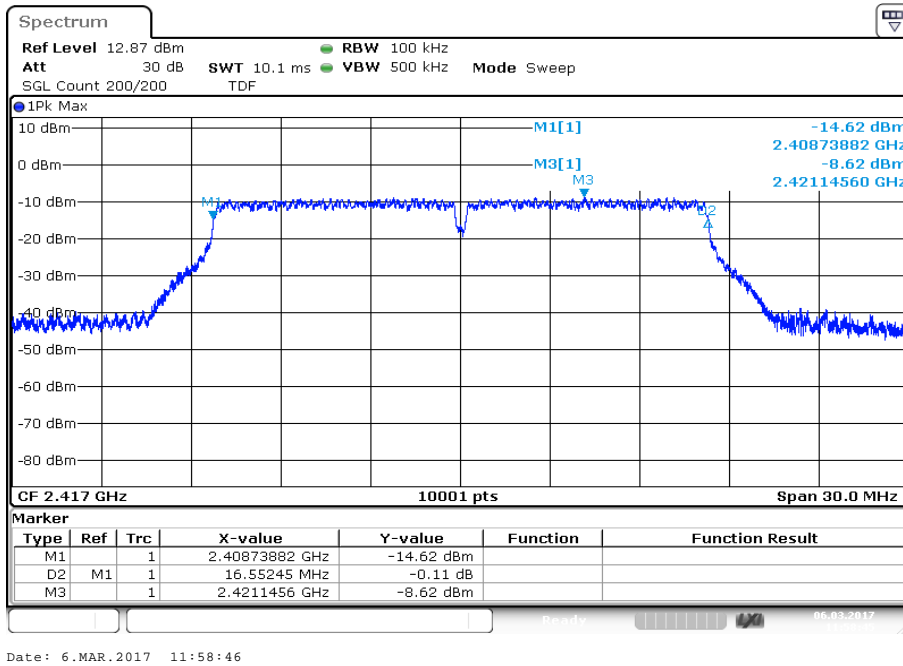

Plot 3: Channel 6

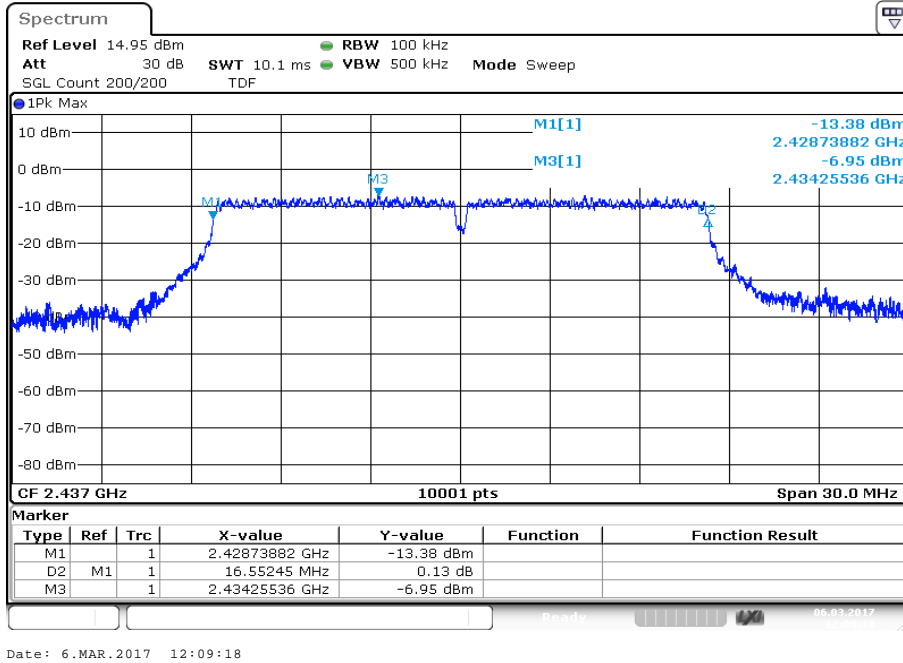

Plot 4: Channel 10

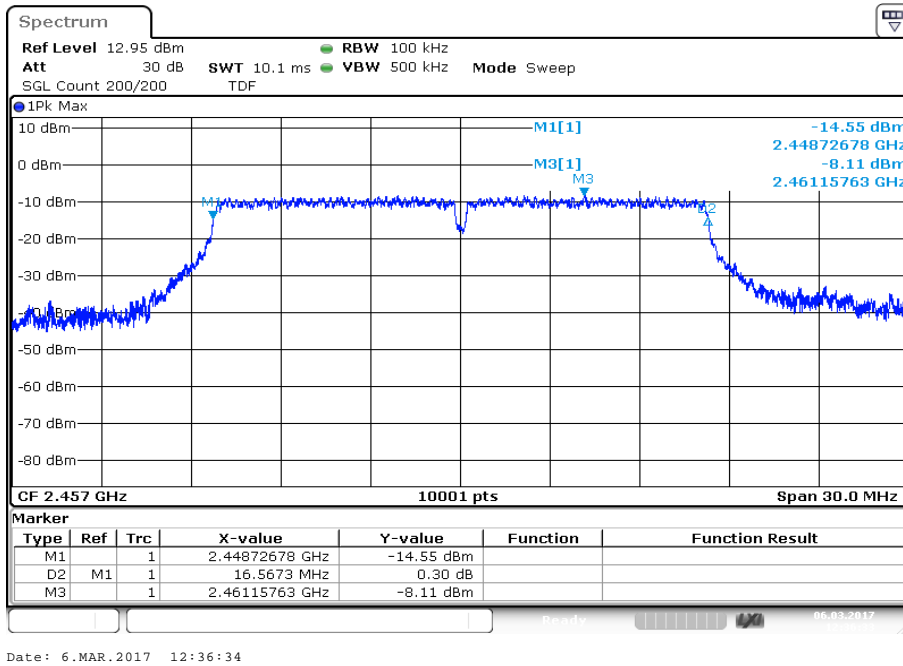

Plot 5: Channel 11

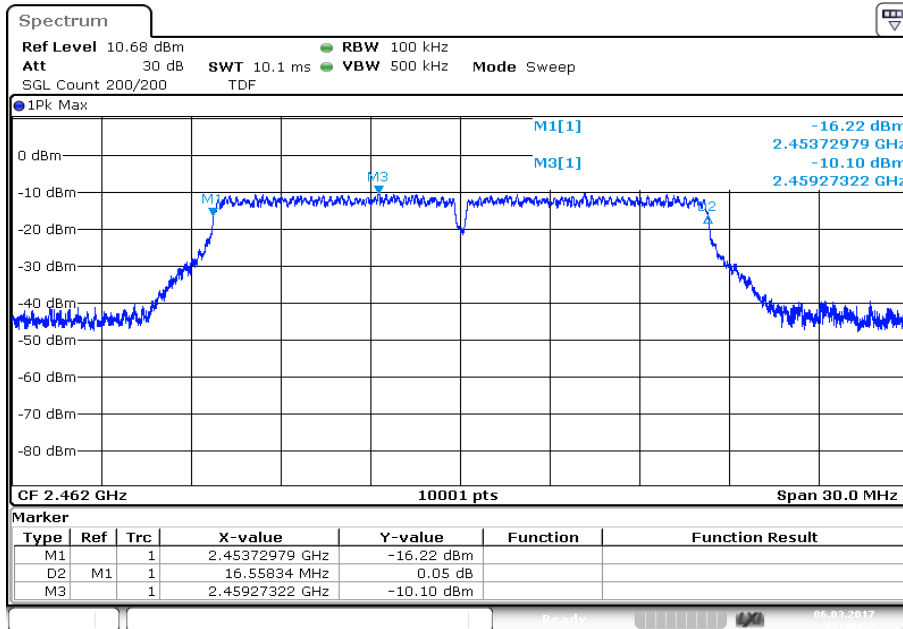

Date: 6.MAR.2017 12:48:52

Plots: OFDM / n HT20 – mode

Plot 1: Channel 1

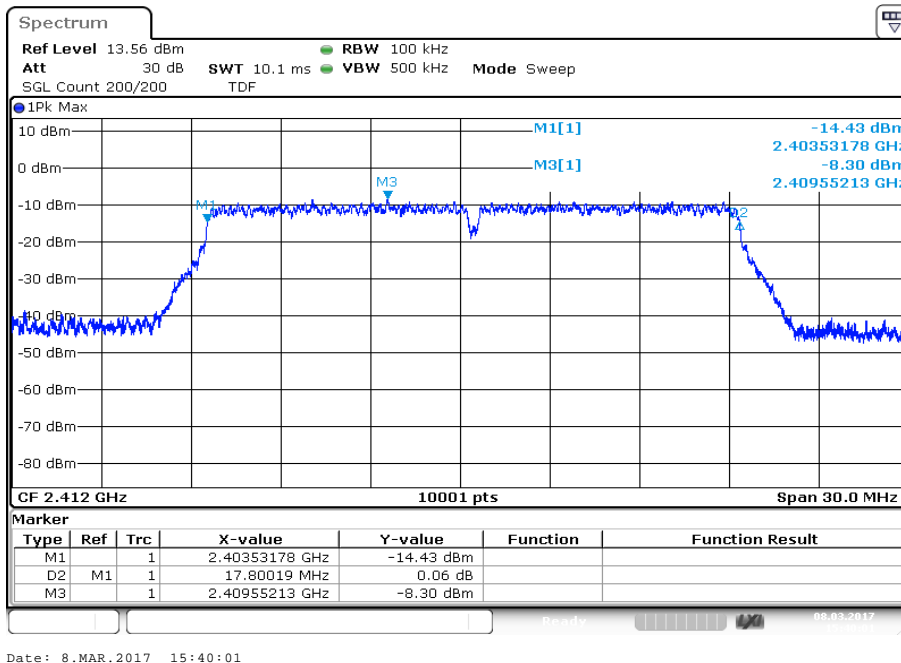

Plot 2: Channel 2

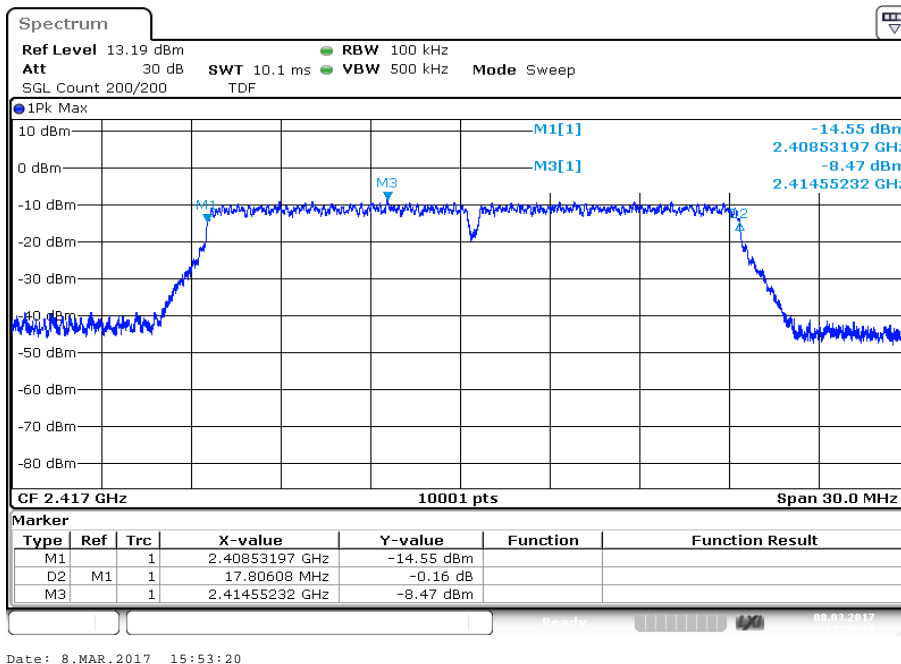

Plot 3: Channel 6

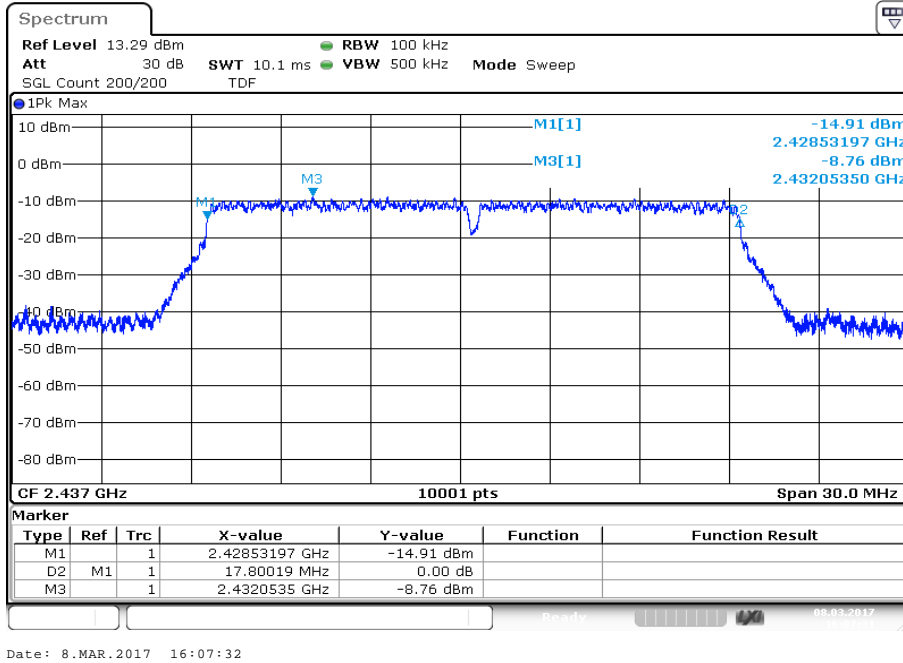

Plot 4: Channel 10

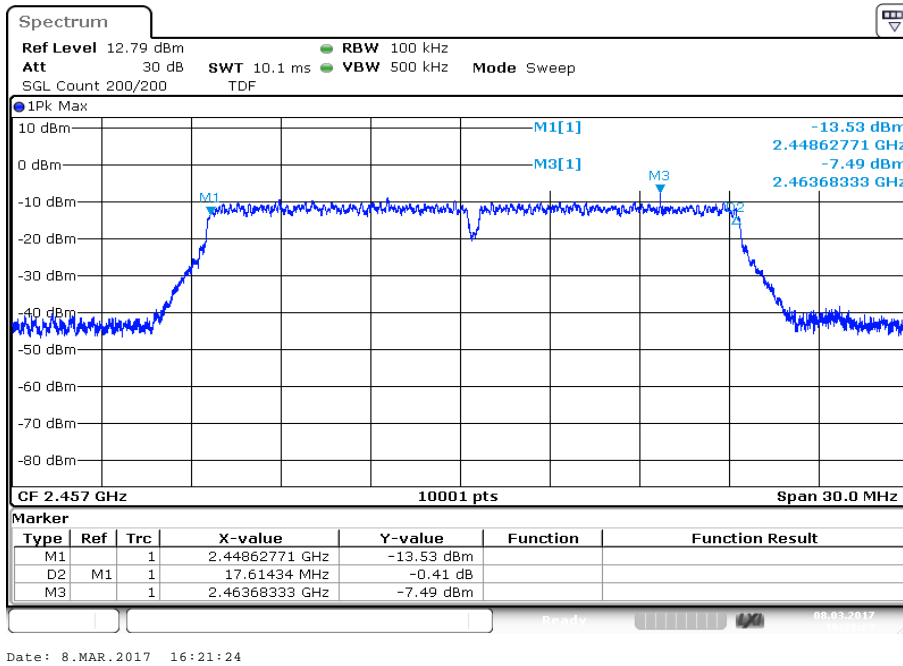

Plot 5: Channel 11

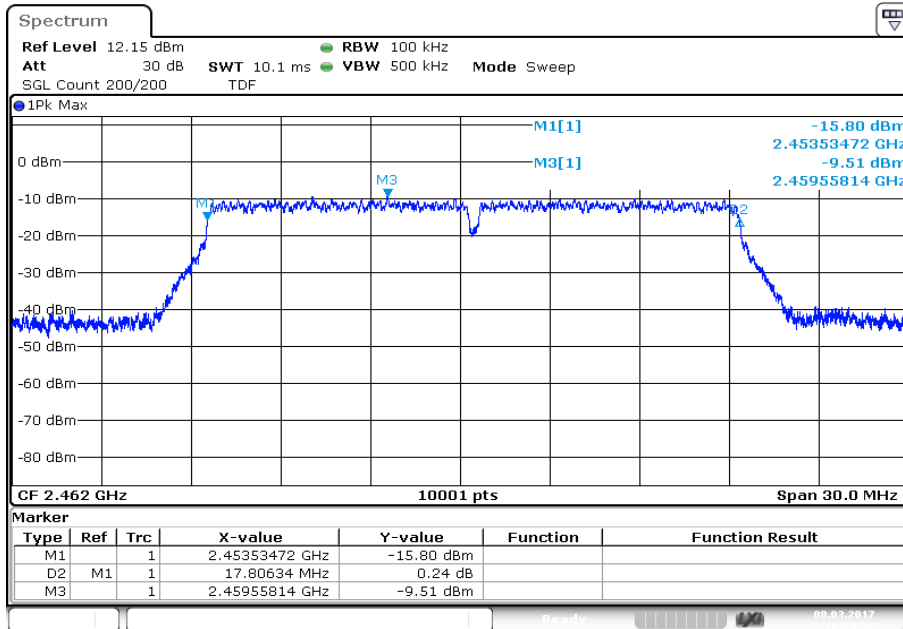

Date: 8.MAR.2017 16:28:58

Plots: OFDM / n HT40 – mode

Plot 1: Channel 3

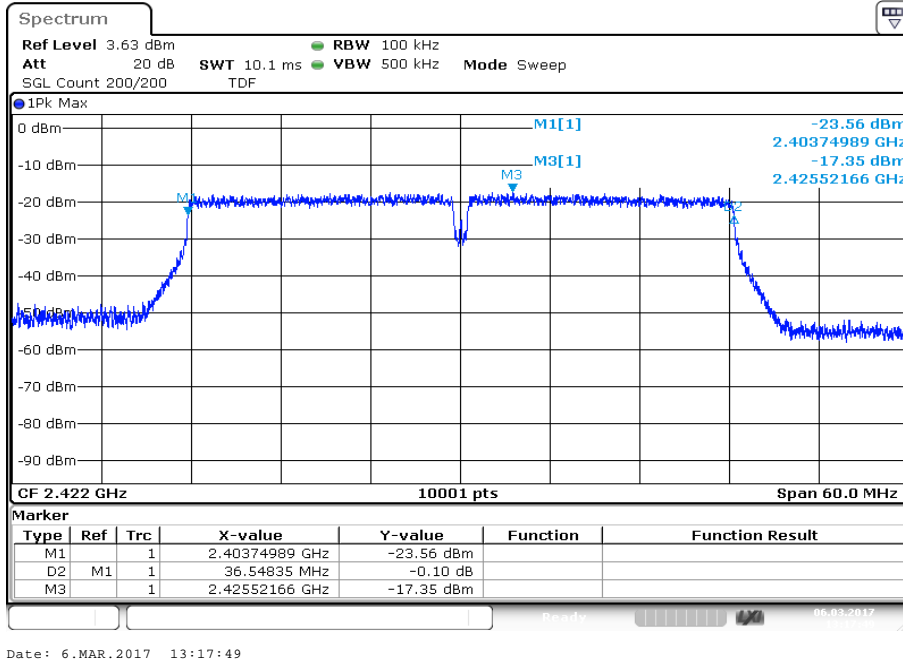

Plot 2: Channel 4

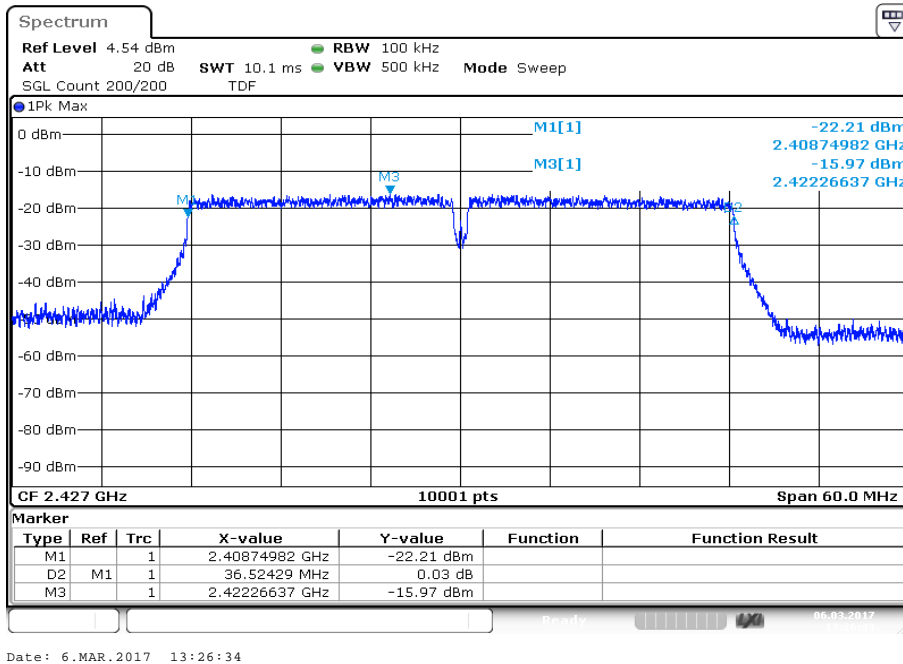

Plot 3: Channel 5

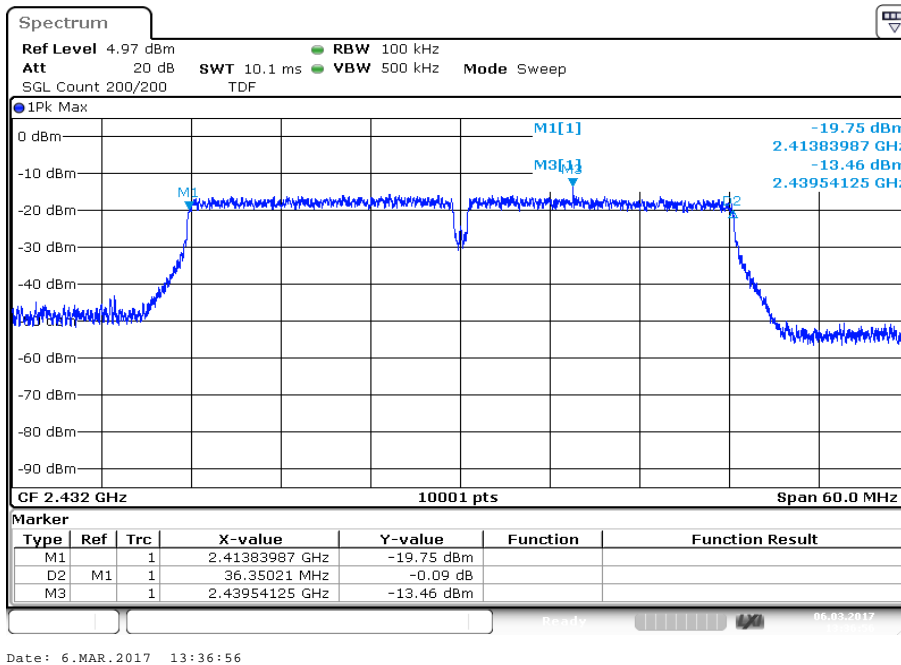

Plot 4: Channel 6

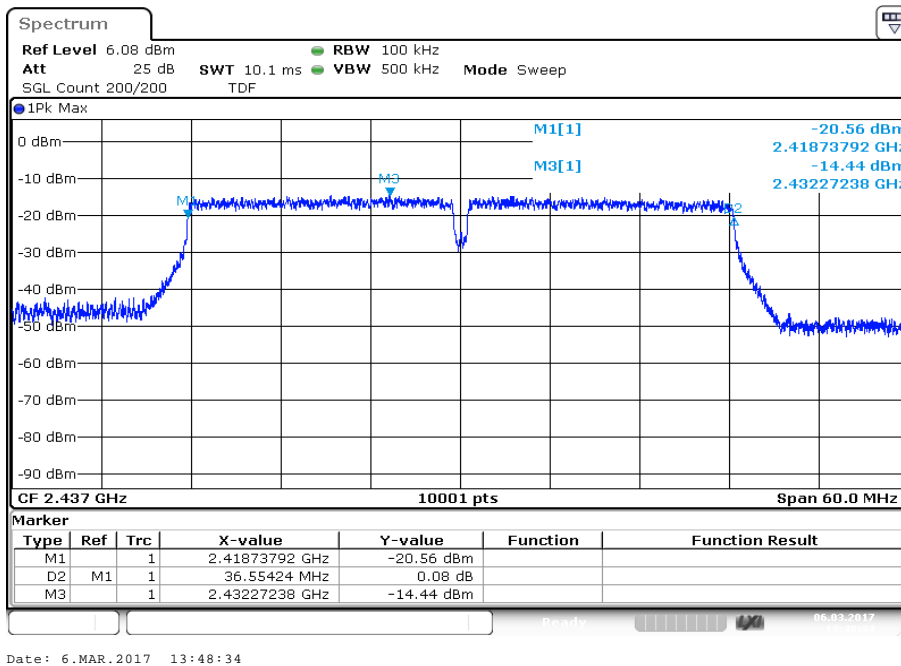

Plot 5: Channel 7

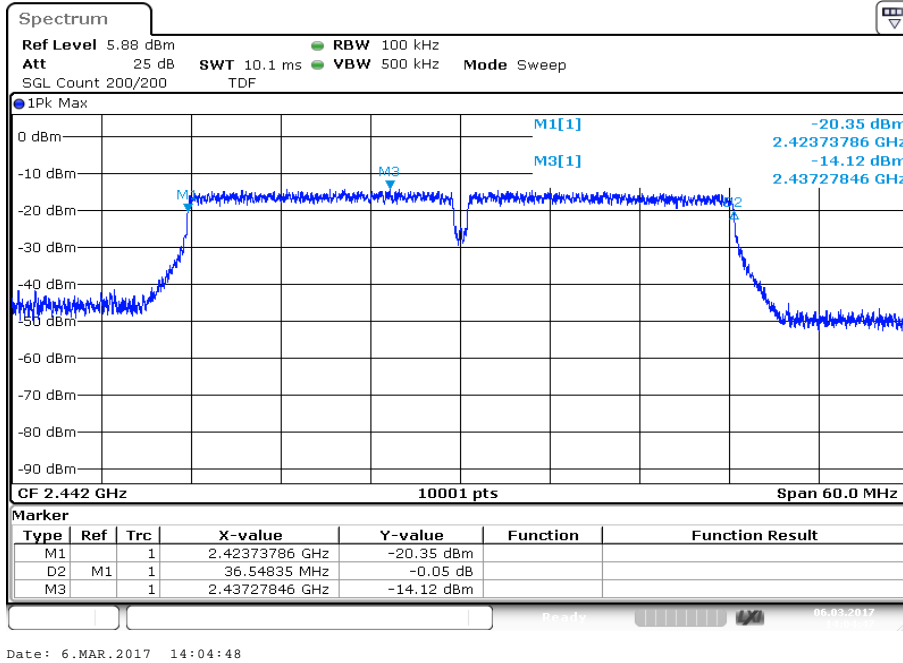

Plot 6: Channel 8

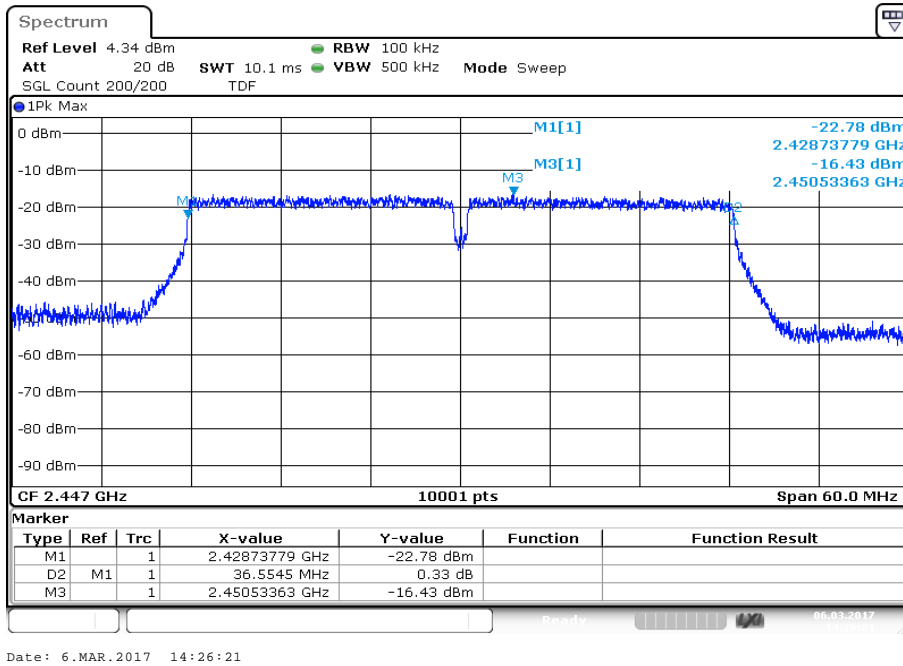

Plot 7: Channel 9

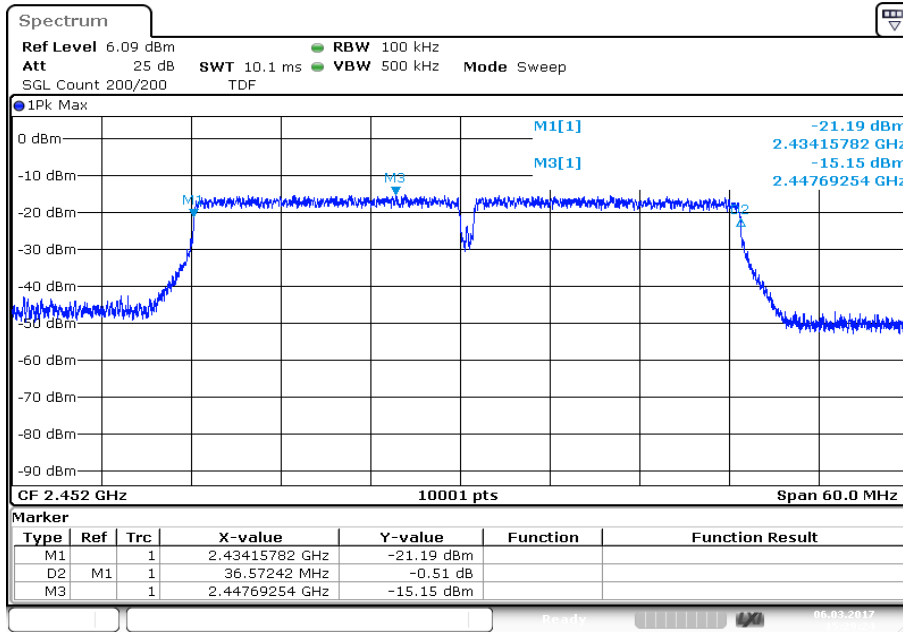

Date: 6.MAR.2017 15:29:24

11.7 Occupied bandwidth – 99% emission bandwidth

Description:

Measurement of the 99% bandwidth of the modulated signal acc. RSS-GEN.

Measurement:

Measurement parameter	
Detector:	Peak
Sweep time:	Auto
Resolution bandwidth:	300 kHz
Video bandwidth:	1 MHz
Span:	30 MHz / 50 MHz
Measurement procedure:	Measurement of the 99% bandwidth using the integration function of the analyzer
Trace mode:	Single count with 200 counts
Test setup:	See sub clause 6.5 – A
Measurement uncertainty	See sub clause 8

Usage:

-/-	IC
OBW is necessary for Emission Designator	

Results:

	99% bandwidth [kHz]						
Frequency	2412 MHz	2417 MHz	2437 MHz	2457 MHz	2462 MHz		
DSSS / b – mode	13751		13736				13772
OFDM / g – mode	16729	16768	16822	16840			16756
OFDM / n HT20 – mode	17902	17896	17908	17911			17914
Frequency	2422 MHz	2427 MHz	2432 MHz	2437 MHz	2442 MHz	2447 MHz	2452 MHz
OFDM / n HT40 – mode	36776	36770	36788	36842	36860	36896	36890

Plots: DSSS / b – mode

Plot 1: Channel 1

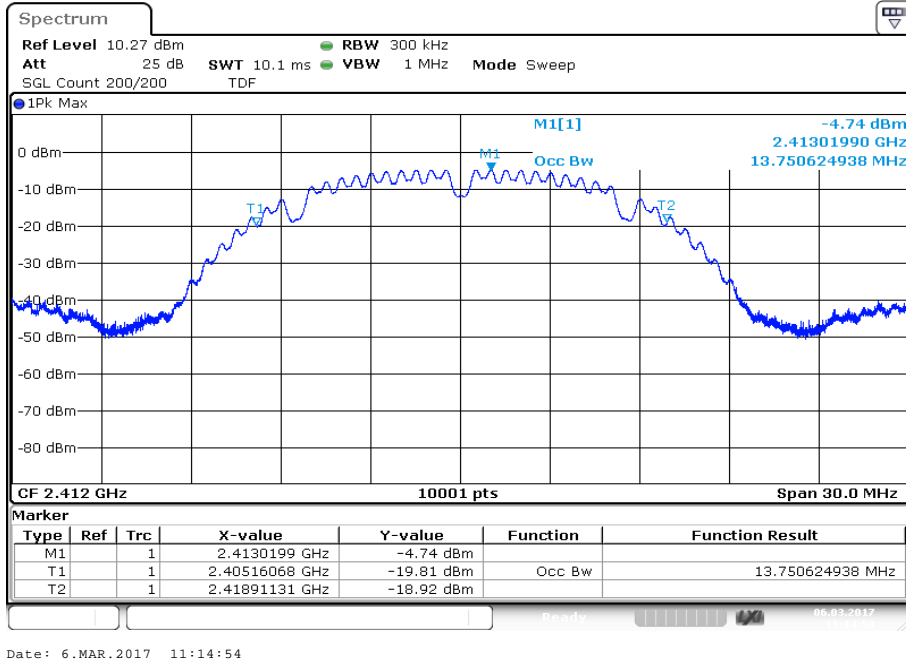

Plot 2: Channel 6

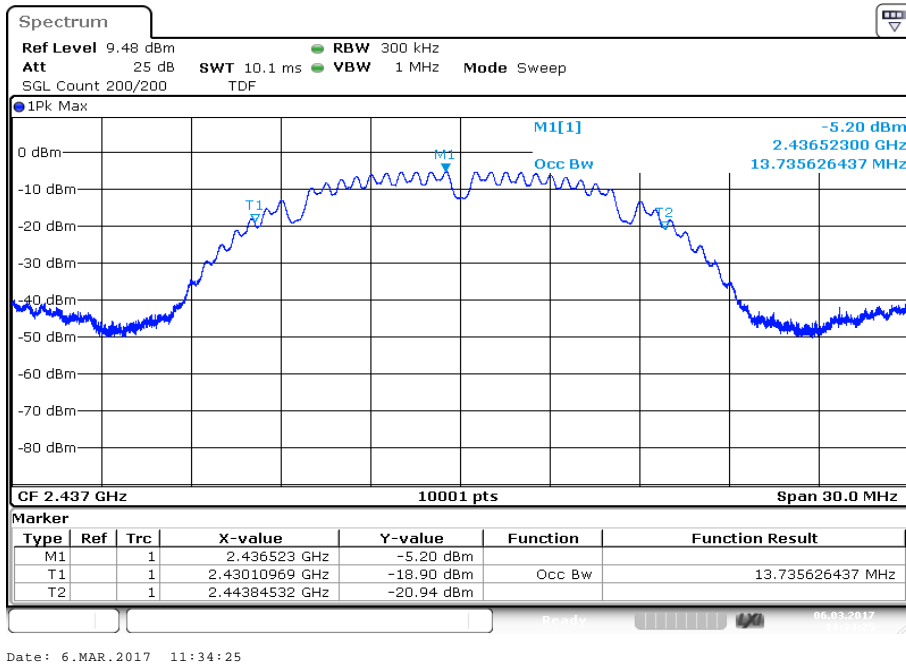

Plot 3: Channel 11

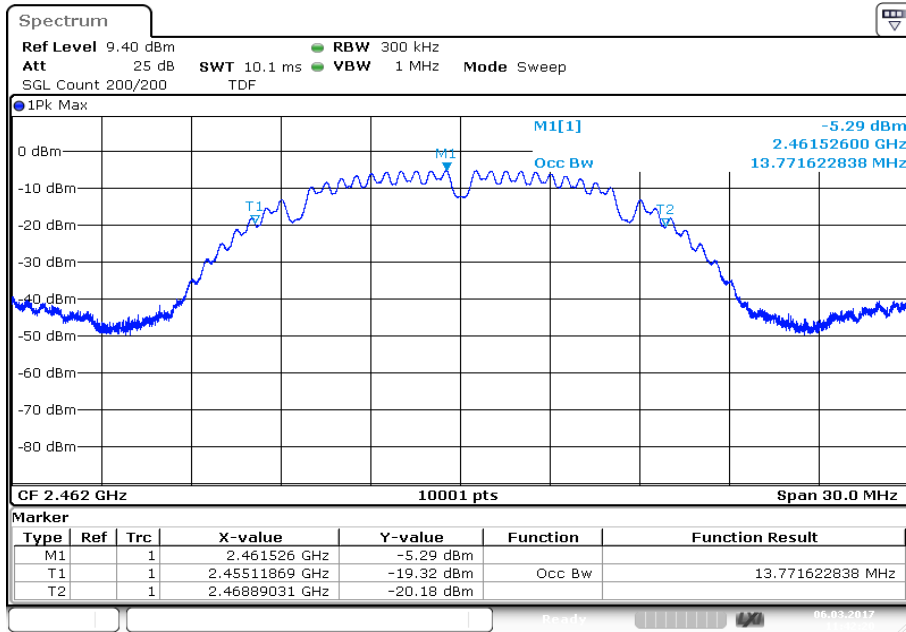

Date: 6.MAR.2017 11:42:20

Plots: OFDM / g – mode

Plot 1: Channel 1

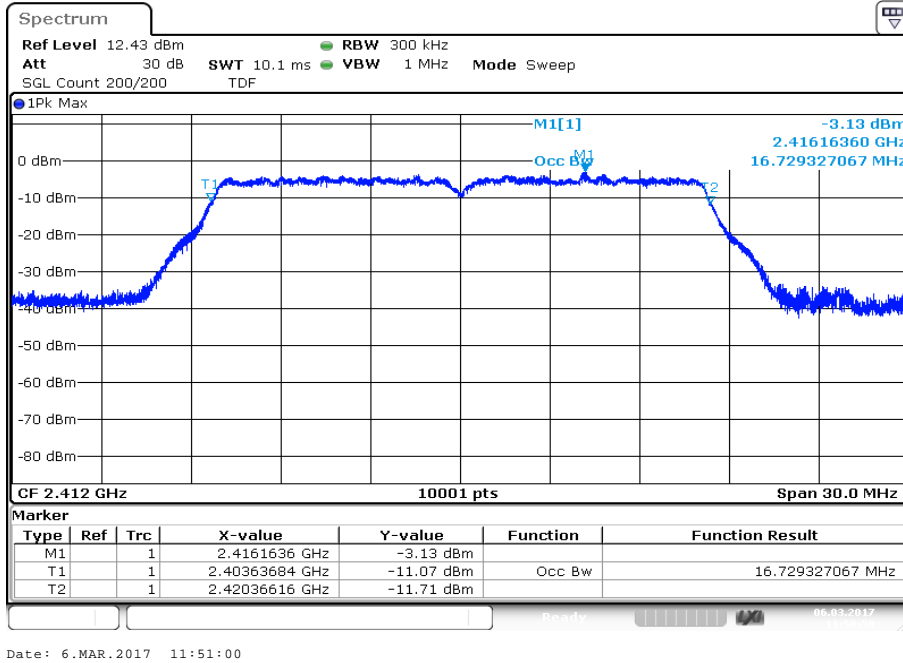

Plot 2: Channel 2

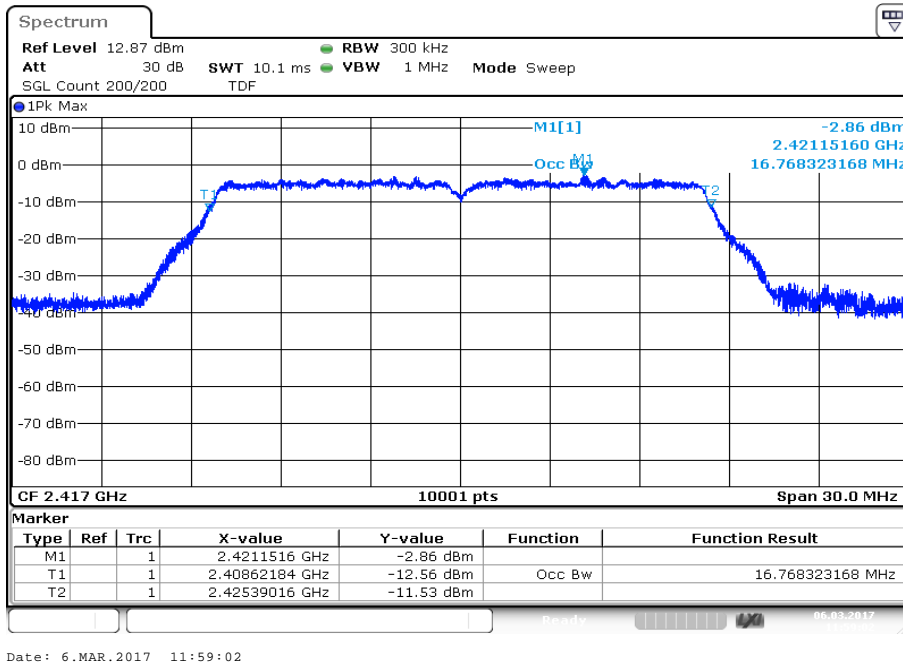

Plot 3: Channel 6

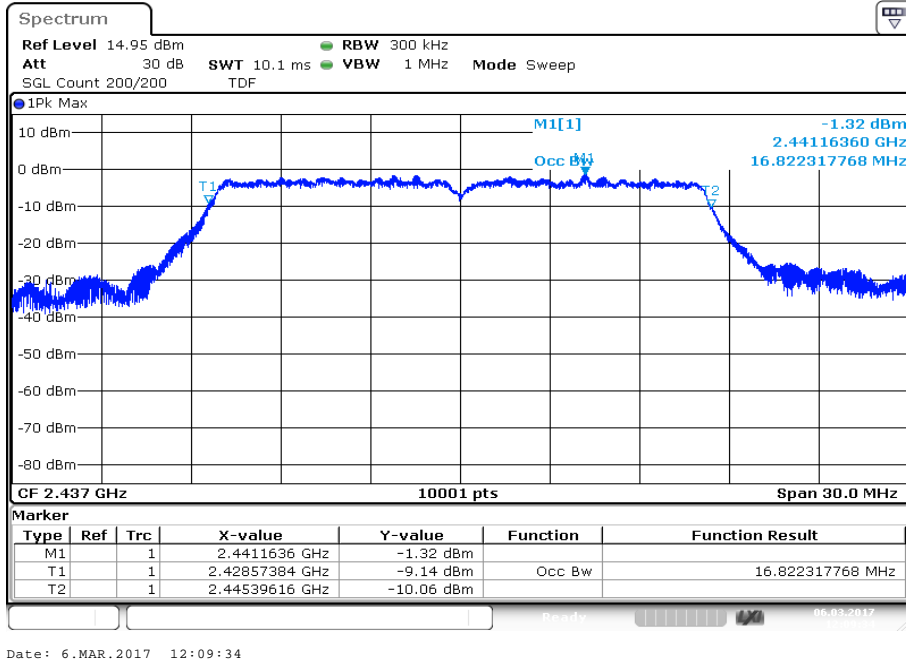

Plot 4: Channel 10

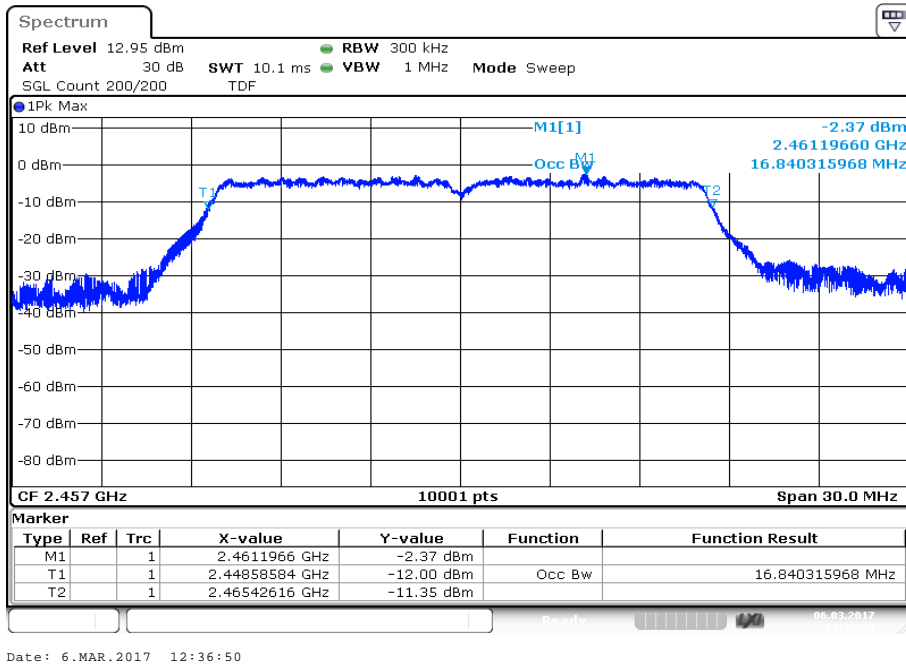

Plot 5: Channel 11

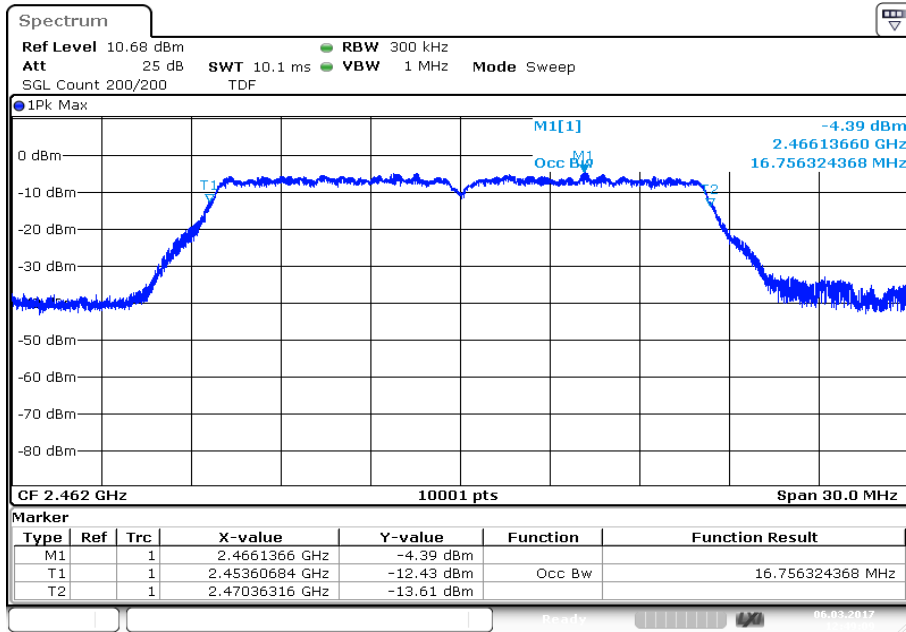

Date: 6.MAR.2017 12:49:09

Plots: OFDM / n HT20 – mode

Plot 1: Channel 1

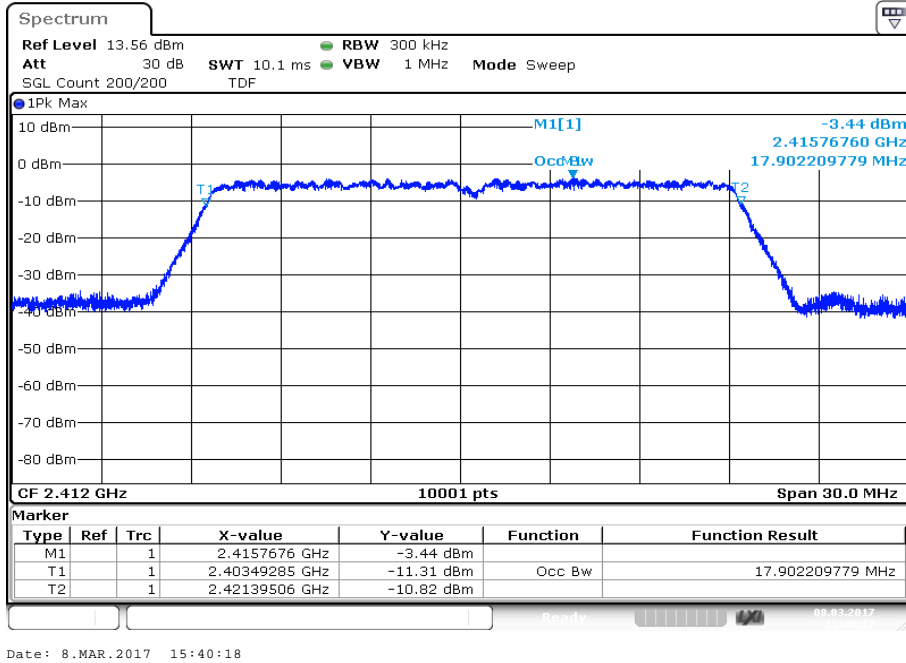

Plot 2: Channel 2

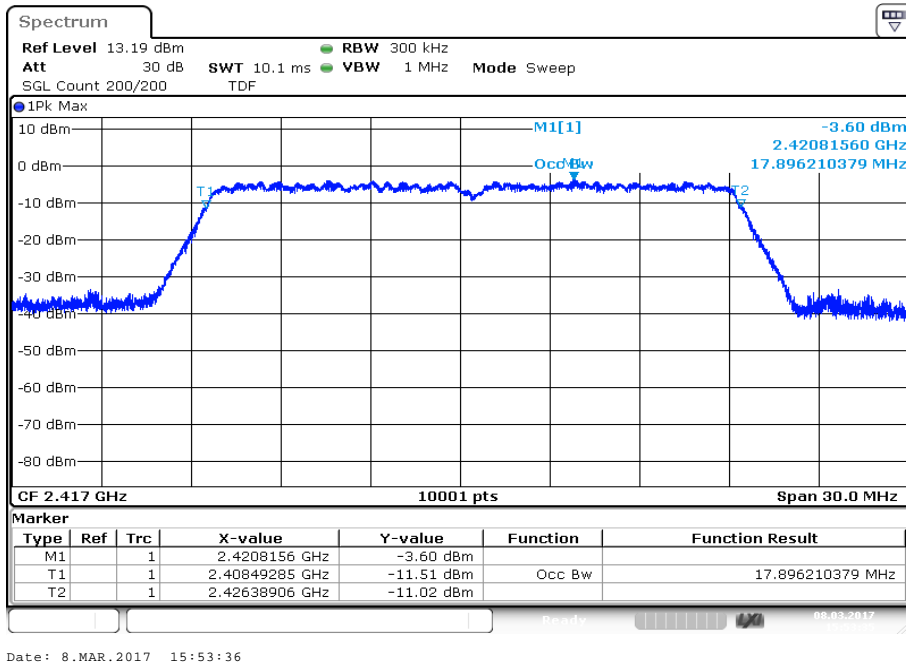

Plot 3: Channel 6

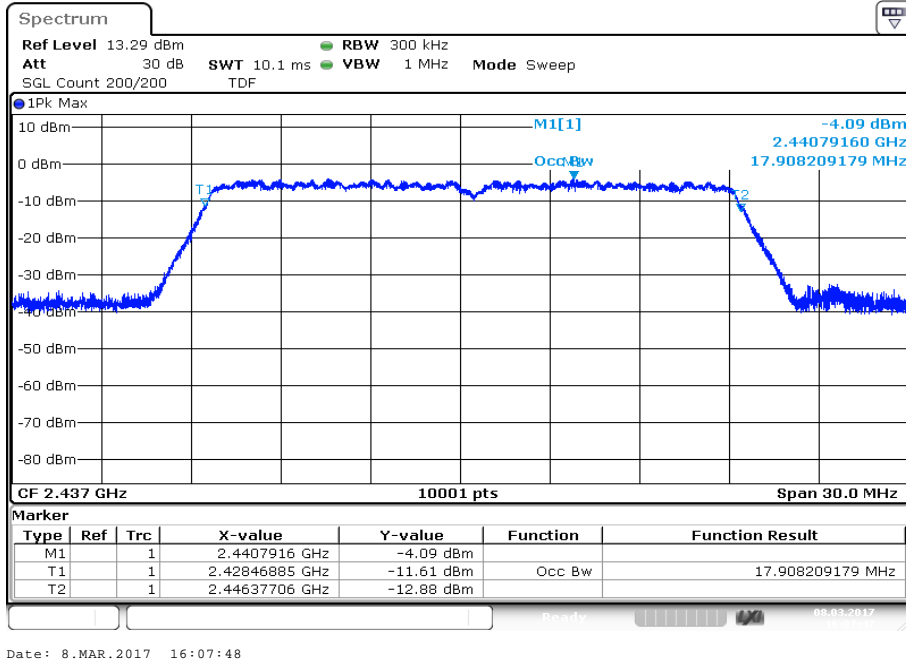

Plot 4: Channel 10

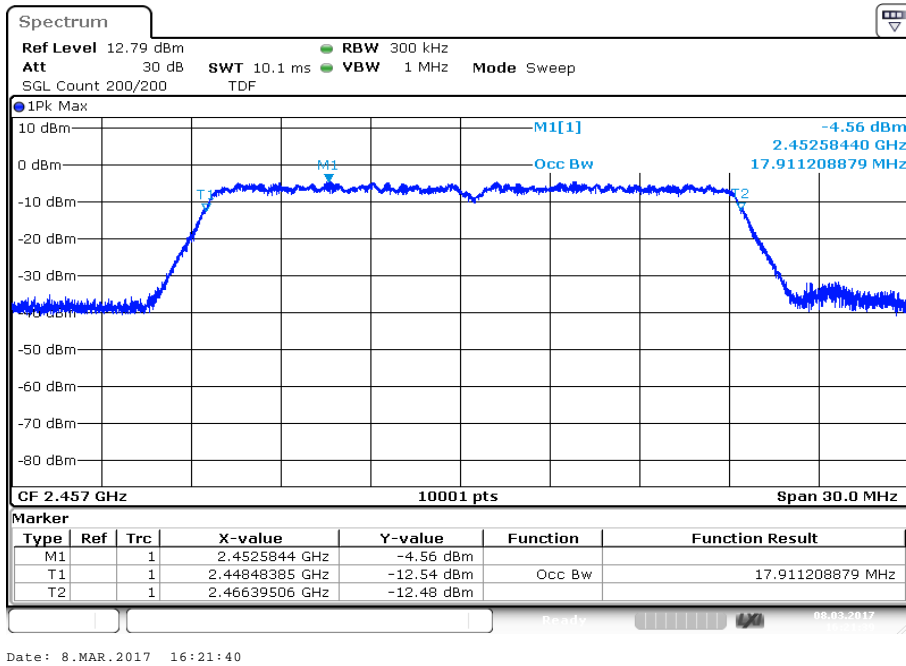

Plot 5: Channel 11

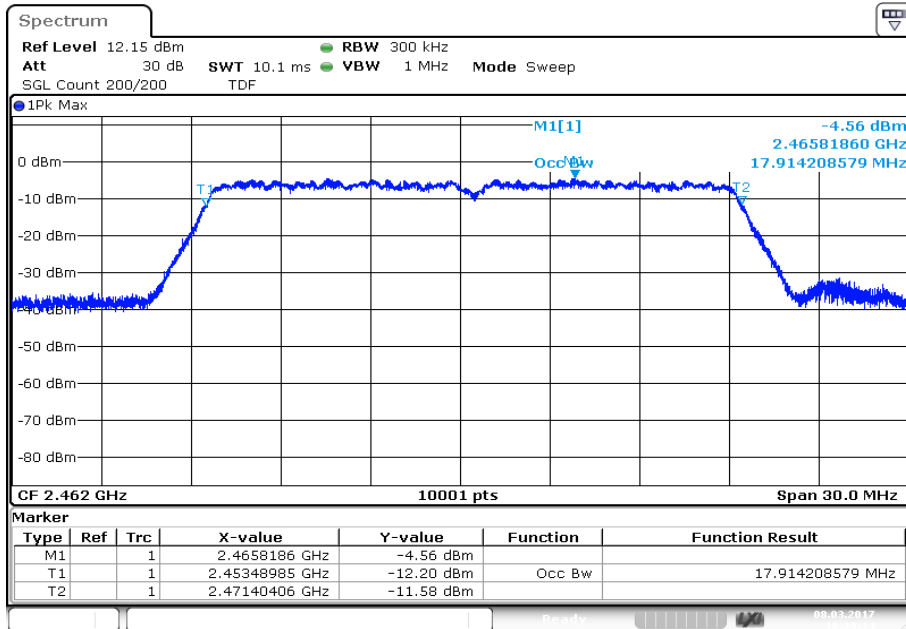

Date: 8.MAR.2017 16:29:15

Plots: OFDM / n HT40 – mode

Plot 1: Channel 3

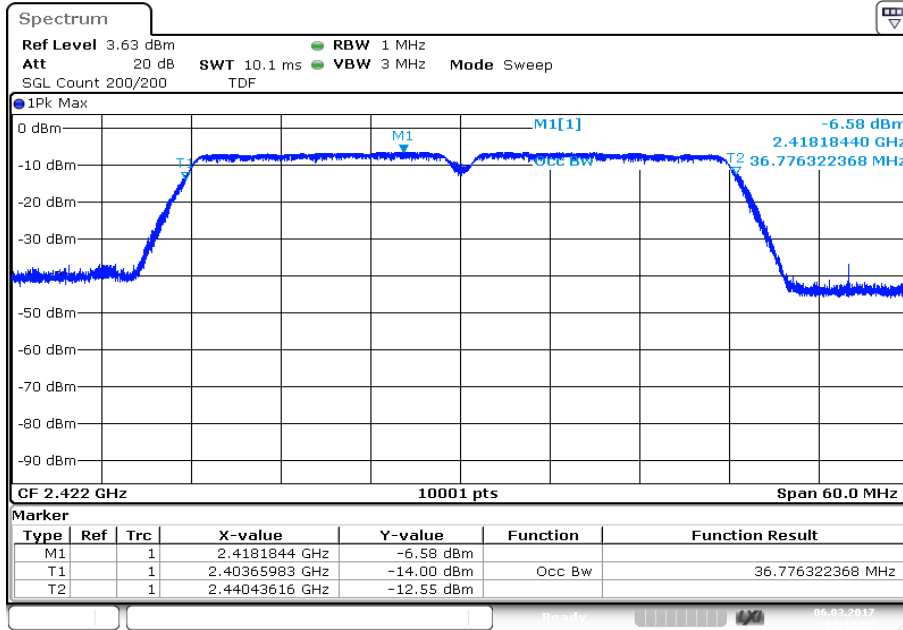

Plot 2: Channel 4

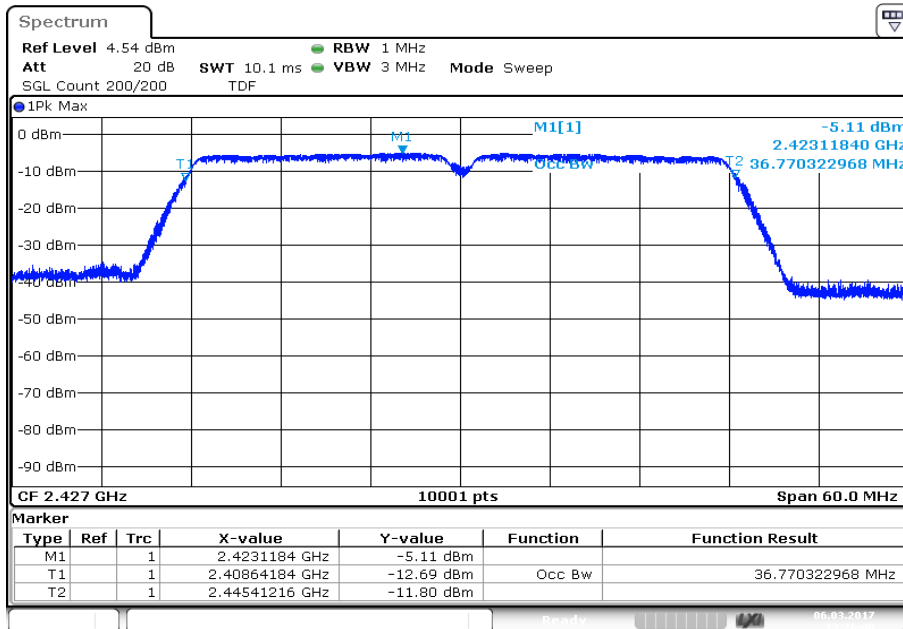

Plot 3: Channel 5

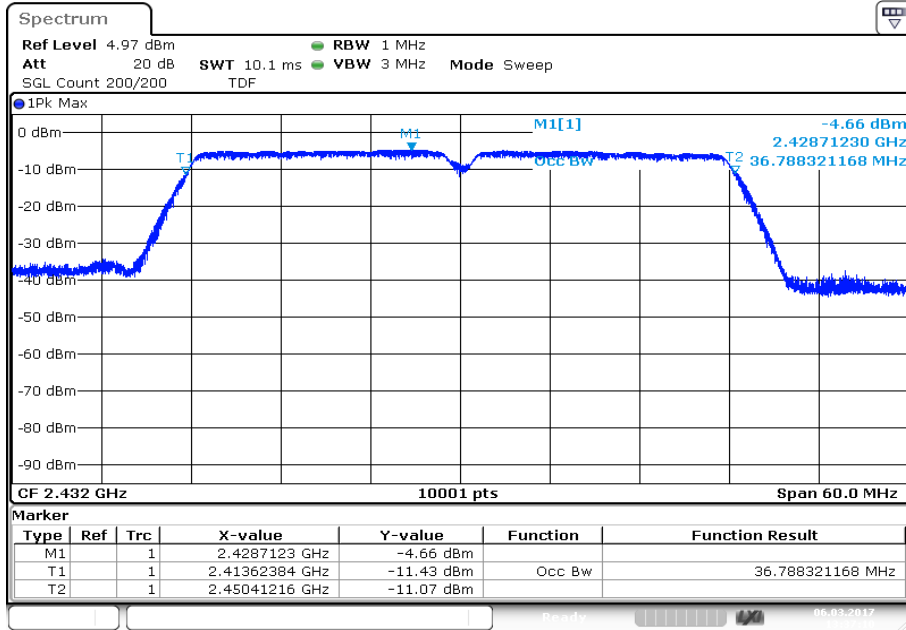

Date: 6.MAR.2017 13:37:11

Plot 4: Channel 6

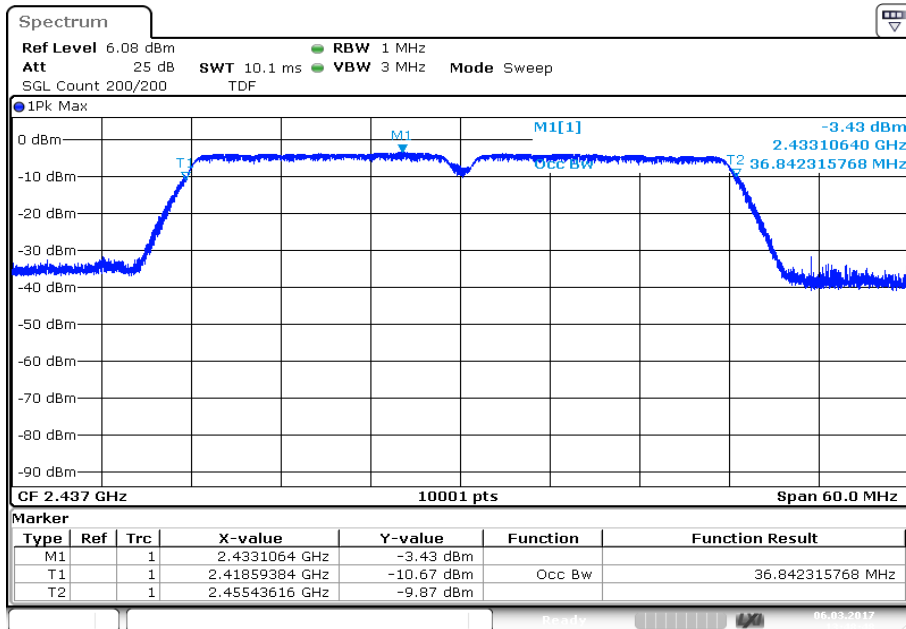

Date: 6.MAR.2017 13:48:48

Plot 5: Channel 7

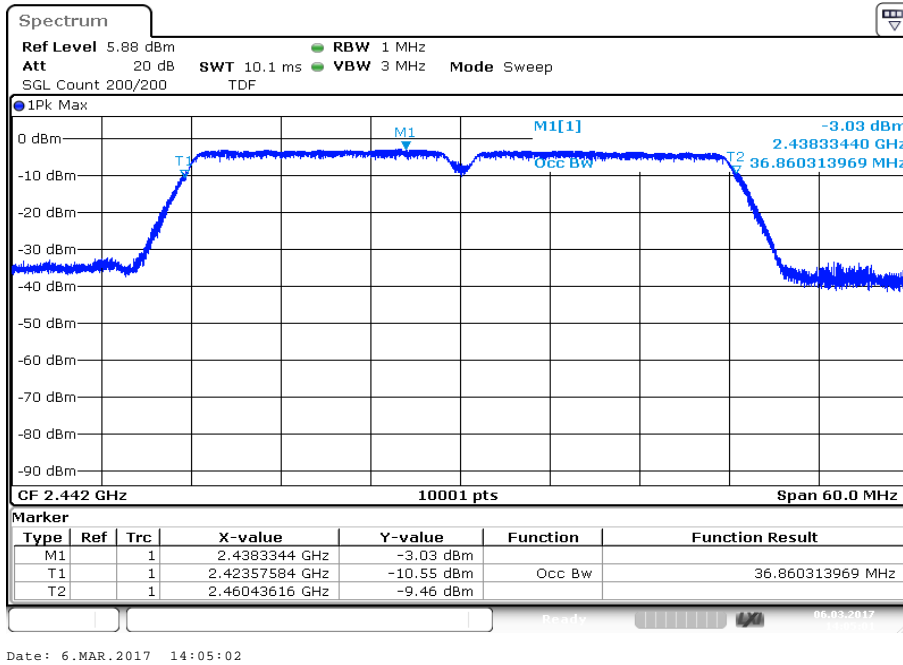

Plot 6: Channel 8

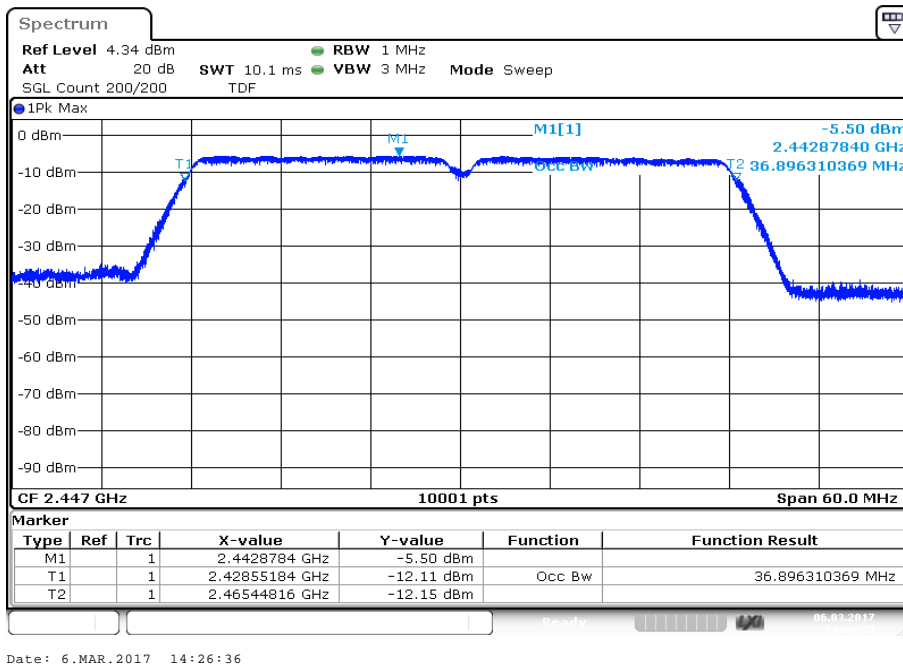

Plot 7: Channel 9

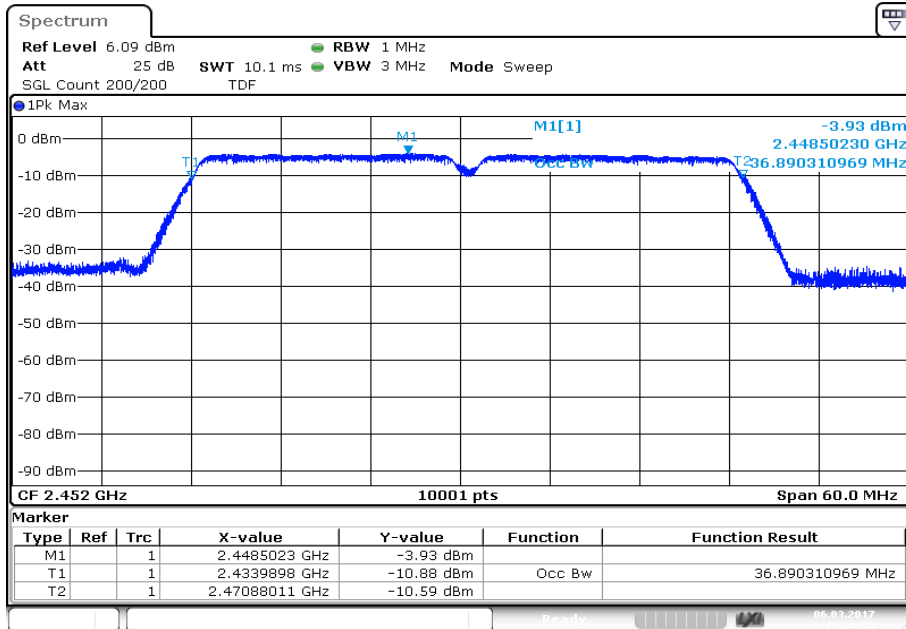

Date: 6.MAR.2017 15:29:38

11.8 Occupied bandwidth – 20 dB bandwidth

Description:

Measurement of the 20 dB bandwidth of the modulated carrier.

Measurement:

Measurement parameter	
Detector:	Peak
Sweep time:	Auto
Resolution bandwidth:	100 kHz
Video bandwidth:	500 kHz
Span:	30 MHz / 50 MHz
Trace mode:	Single count with min. 200 counts
Test setup:	See sub clause 6.5 – A
Measurement uncertainty	See sub clause 8

Usage:

-/-	IC
Within the used band!	

Results:

Frequency	20 dB bandwidth [MHz]						
	2412 MHz	2417 MHz	2437 MHz	2457 MHz	2462 MHz		
DSSS / b – mode	15.223		15.275		15.271		
OFDM / g – mode	18.259	18.403	18.484	18.490	18.472		
OFDM / n HT20 – mode	19.330	19.363	19.237	19.327	19.192		
Frequency	2422 MHz	2427 MHz	2432 MHz	2437 MHz	2442 MHz	2447 MHz	2452 MHz
OFDM / n HT40 – mode	38.276	38.234	38.294	38.276	38.270	38.282	38.492

Plots: DSSS / b – mode

Plot 1: Channel 1

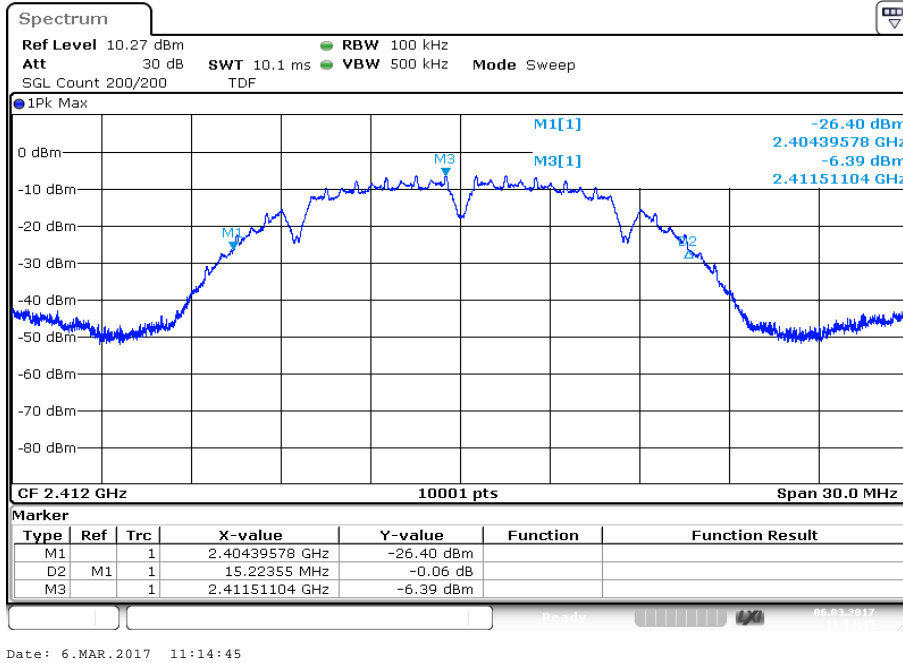

Plot 2: Channel 6

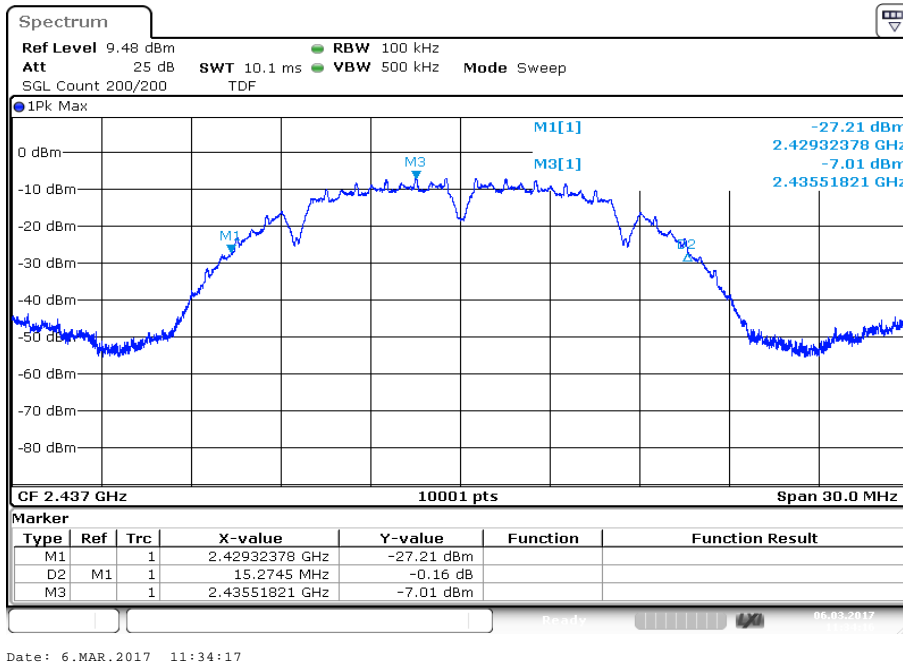

Plot 3: Channel 11

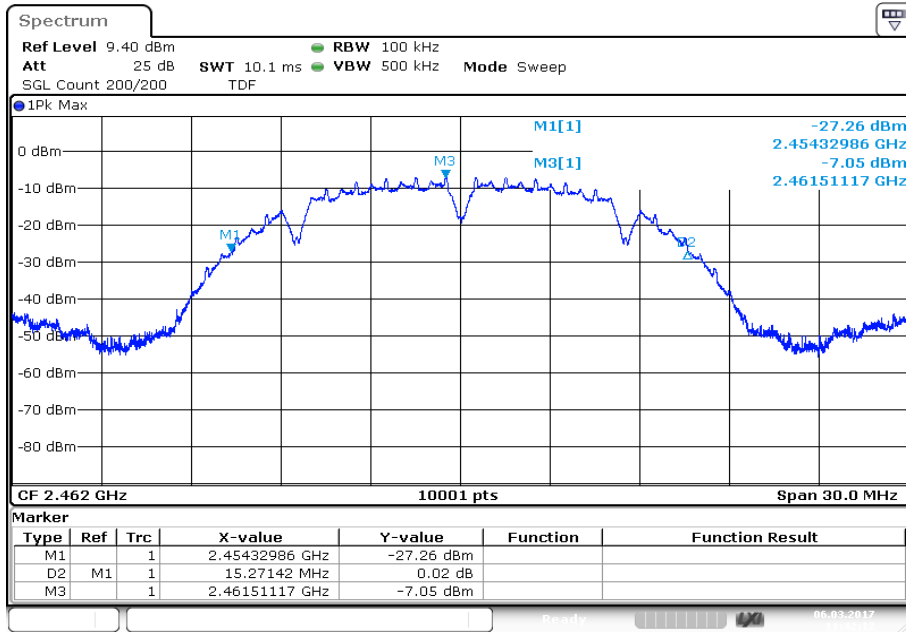

Plots: OFDM / g – mode

Plot 1: Channel 1

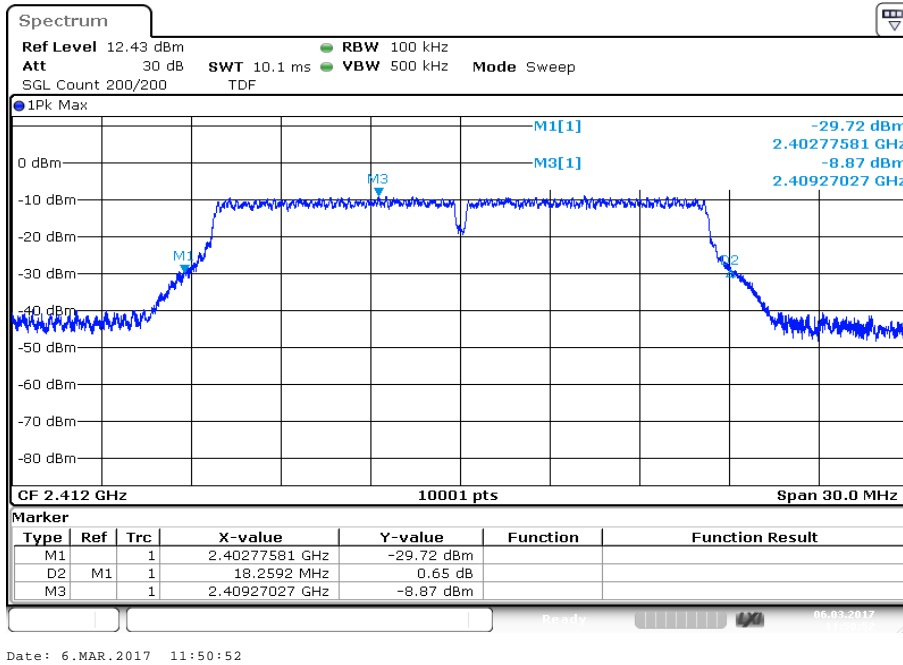

Plot 2: Channel 2

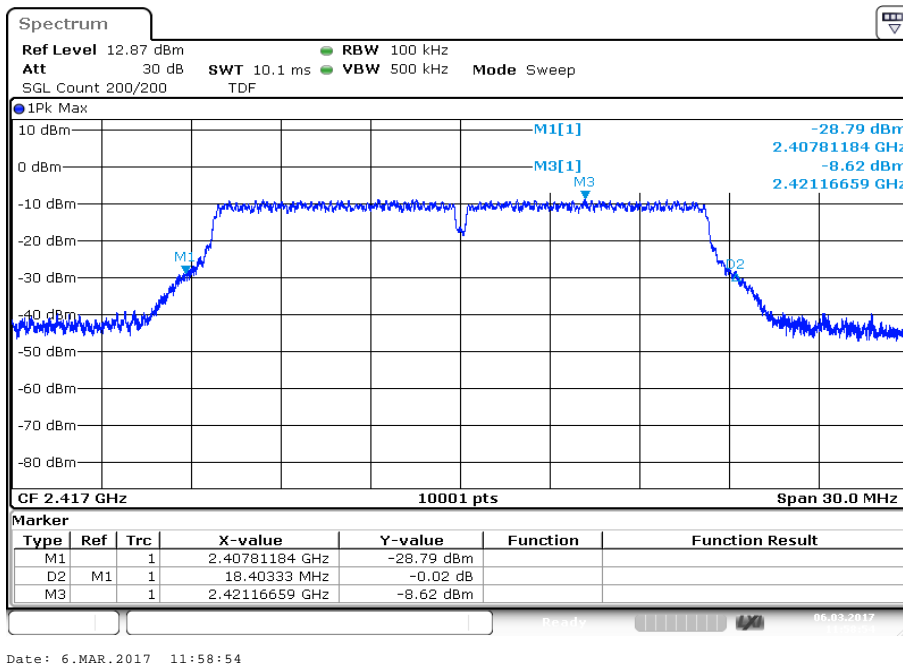

Plot 3: Channel 6

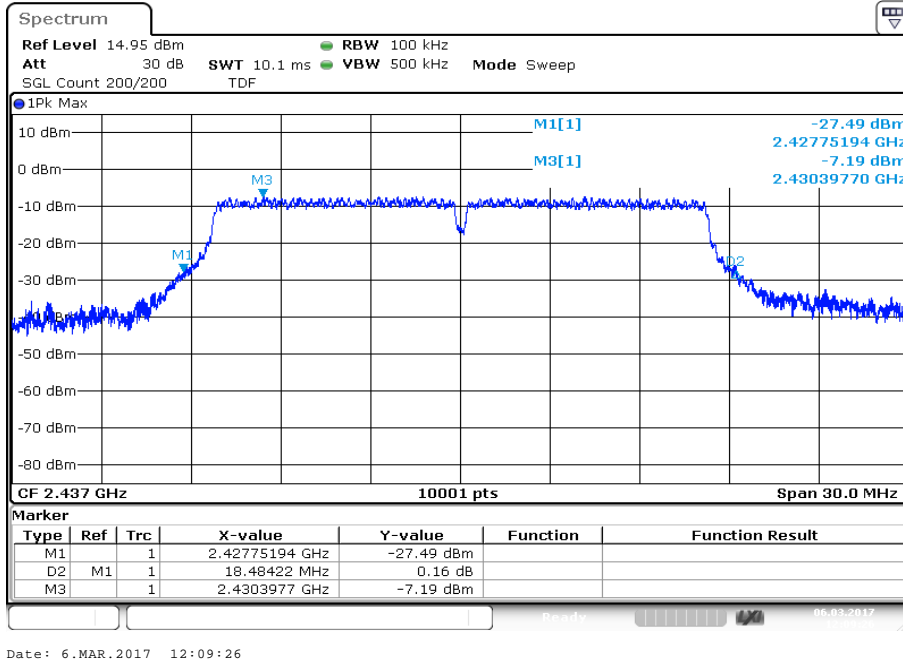

Plot 4: Channel 10

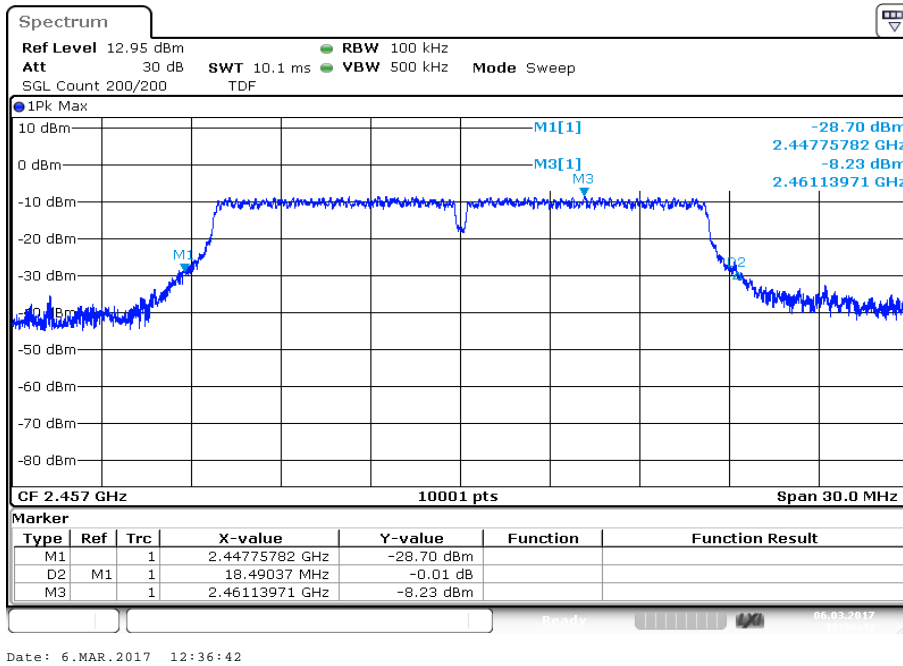

Plot 5: Channel 11

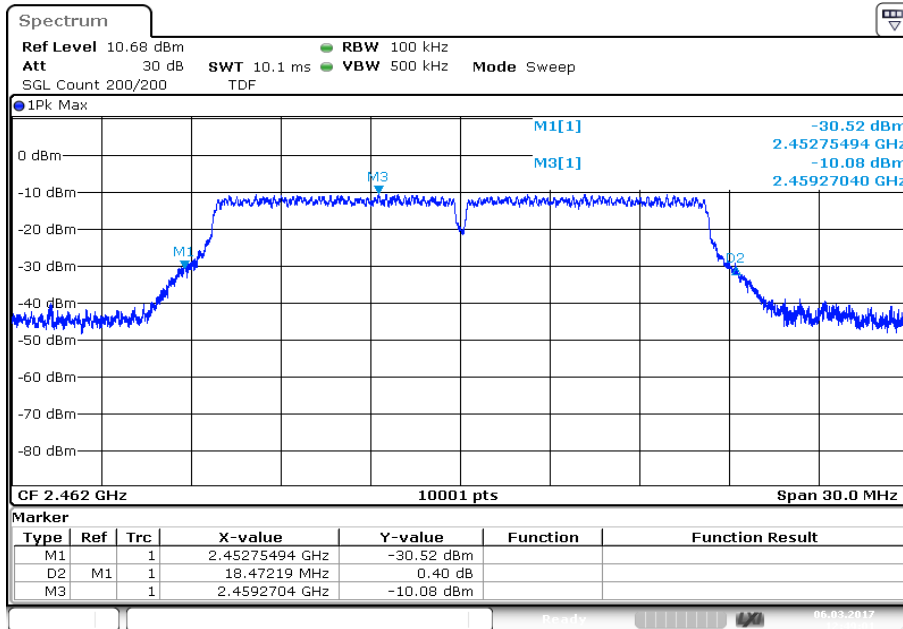

Date: 6.MAR.2017 12:49:01

Plots: OFDM / n HT20 – mode

Plot 1: Channel 1

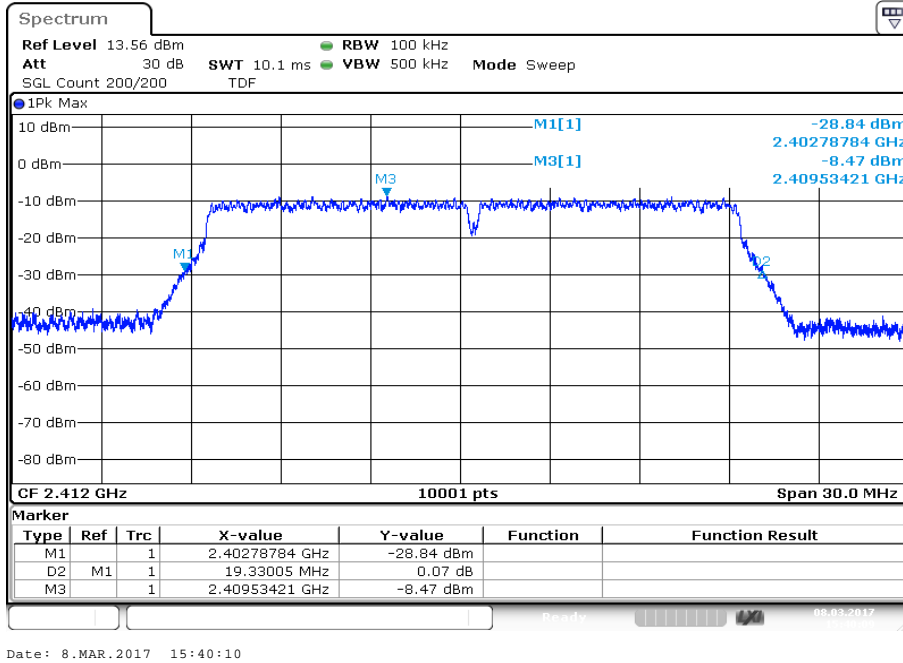

Plot 2: Channel 2

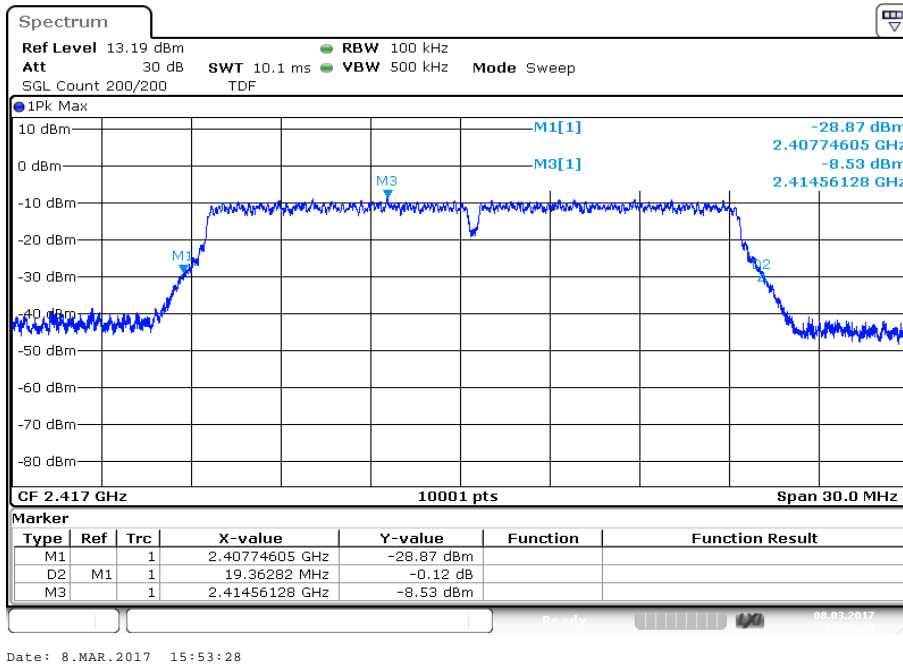

Plot 3: Channel 6

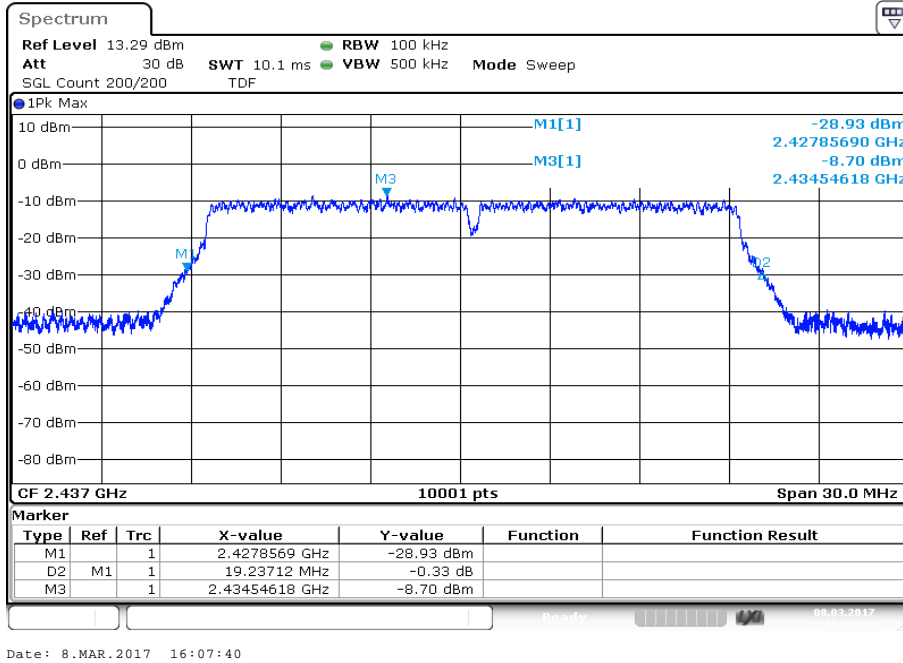

Plot 4: Channel 10

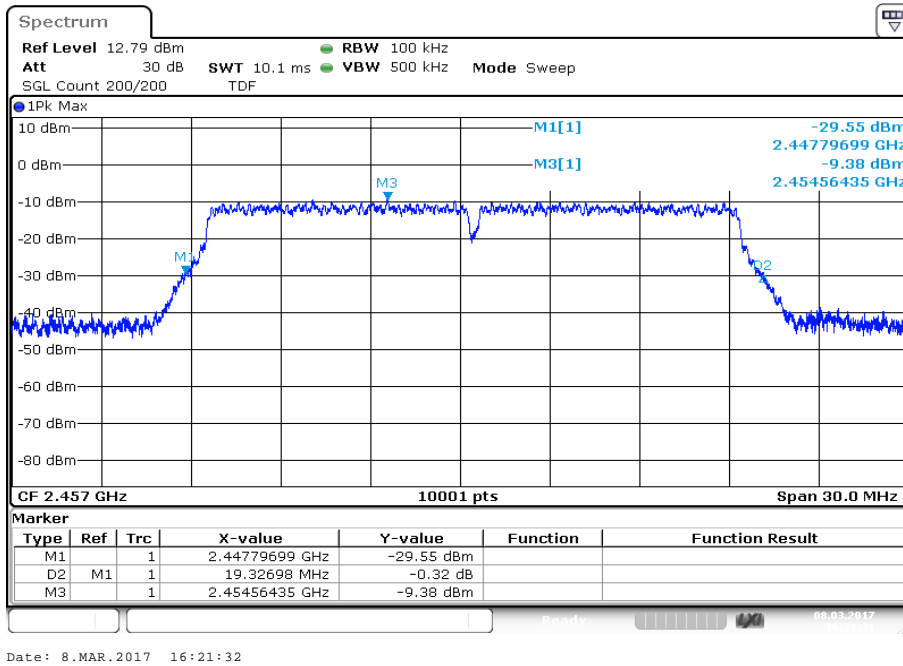

Plot 5: Channel 11

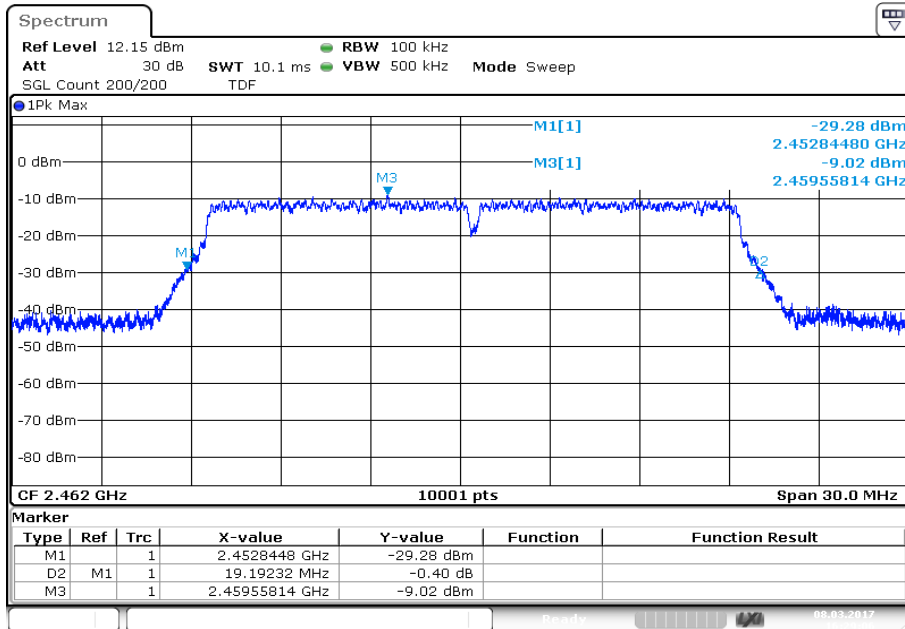

Date: 8.MAR.2017 16:29:07

Plots: OFDM / n HT40 – mode

Plot 1: Channel 3

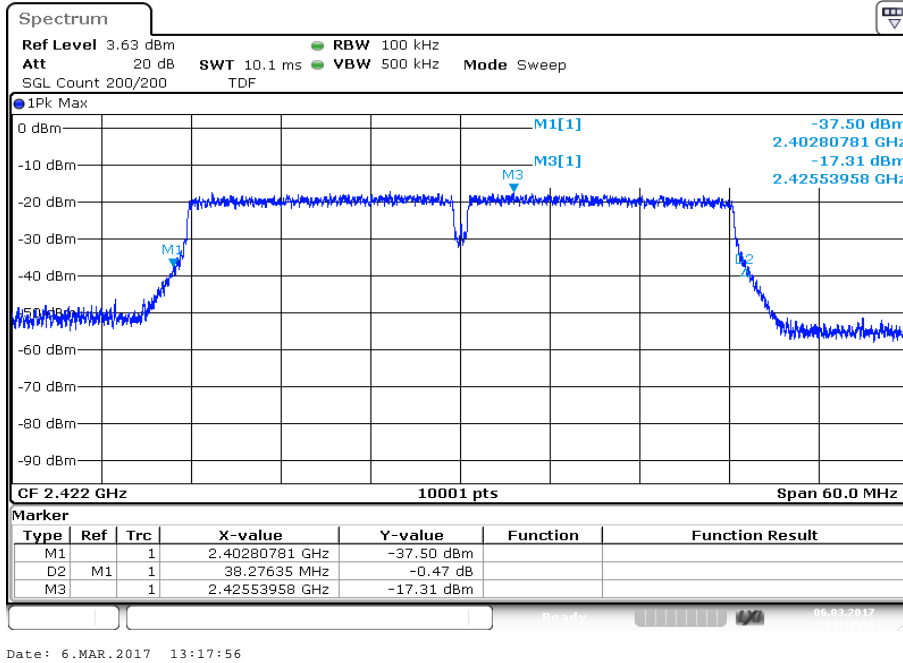

Plot 2: Channel 4

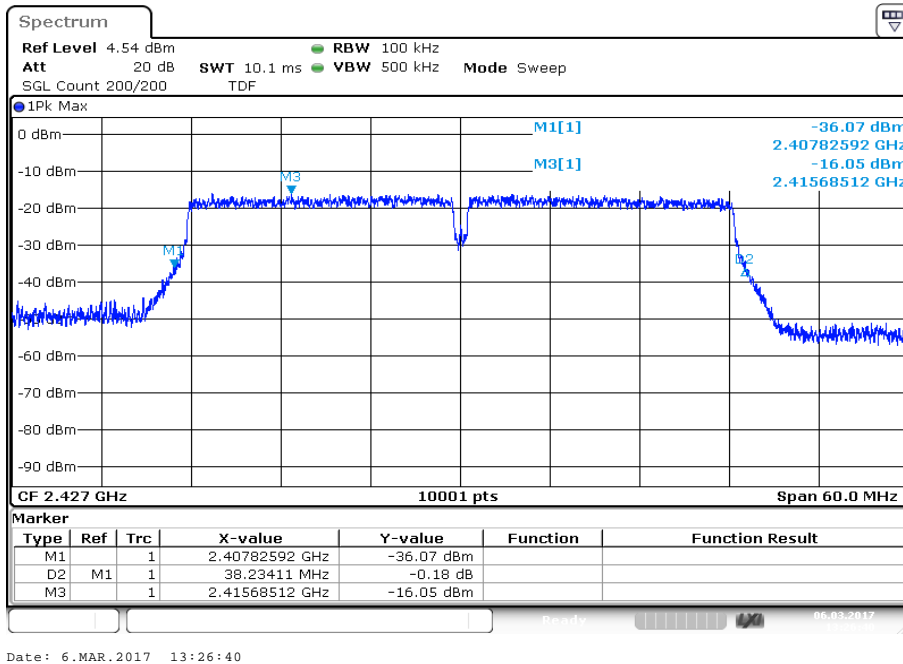

Plot 3: Channel 5

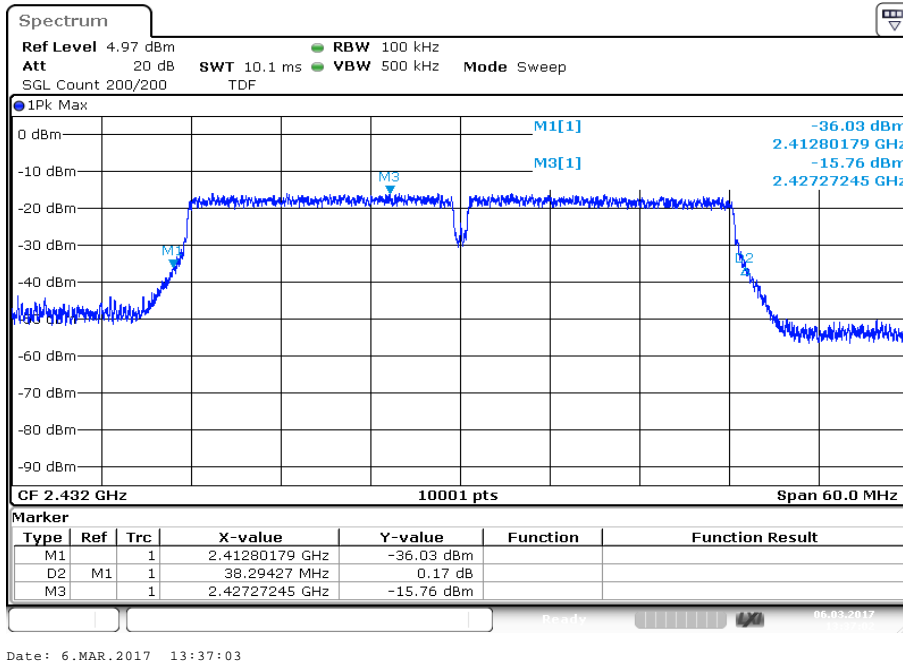

Plot 4: Channel 6

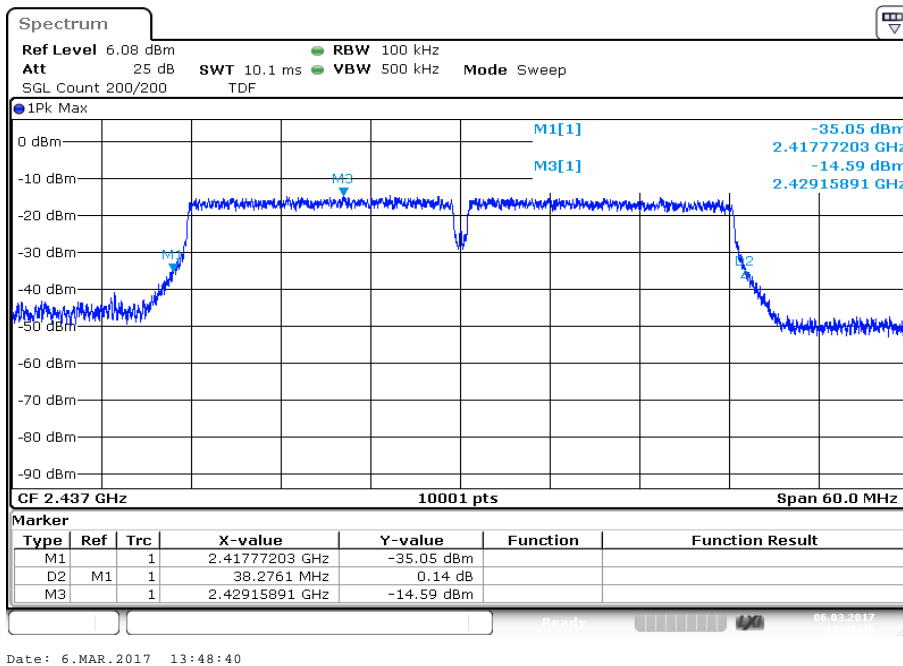

Plot 5: Channel 7

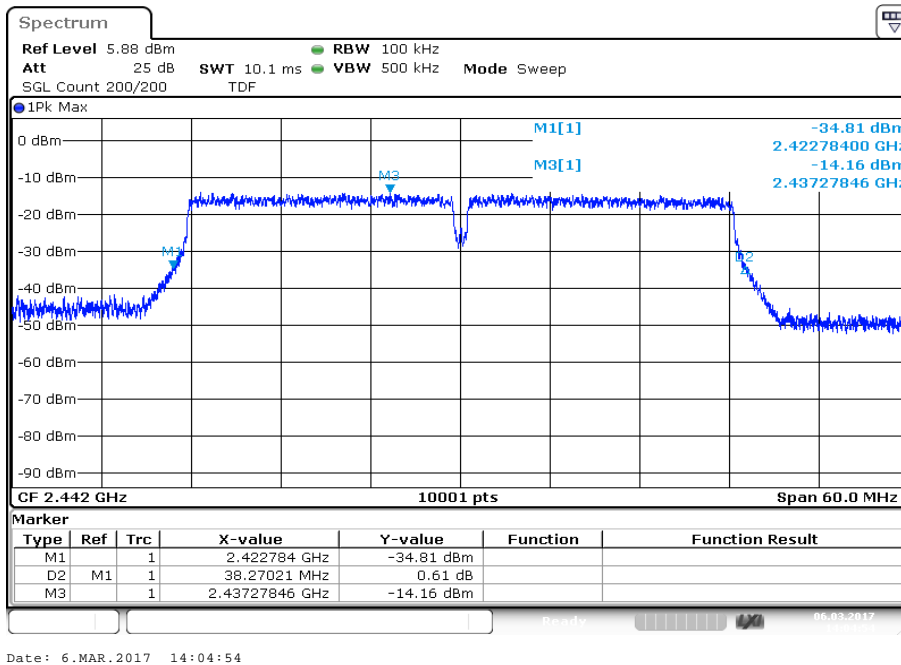

Plot 6: Channel 8

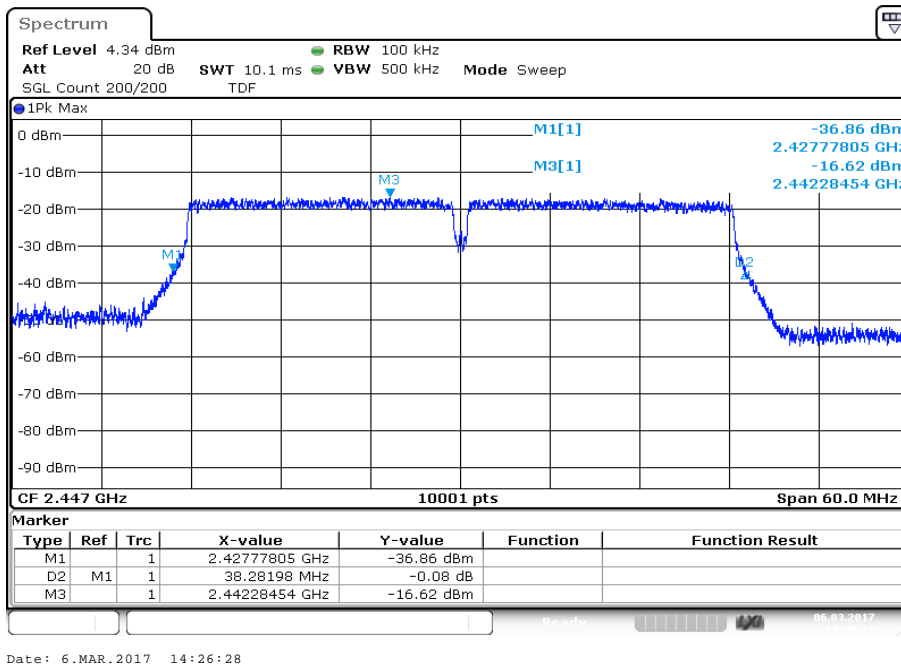

Plot 7: Channel 9

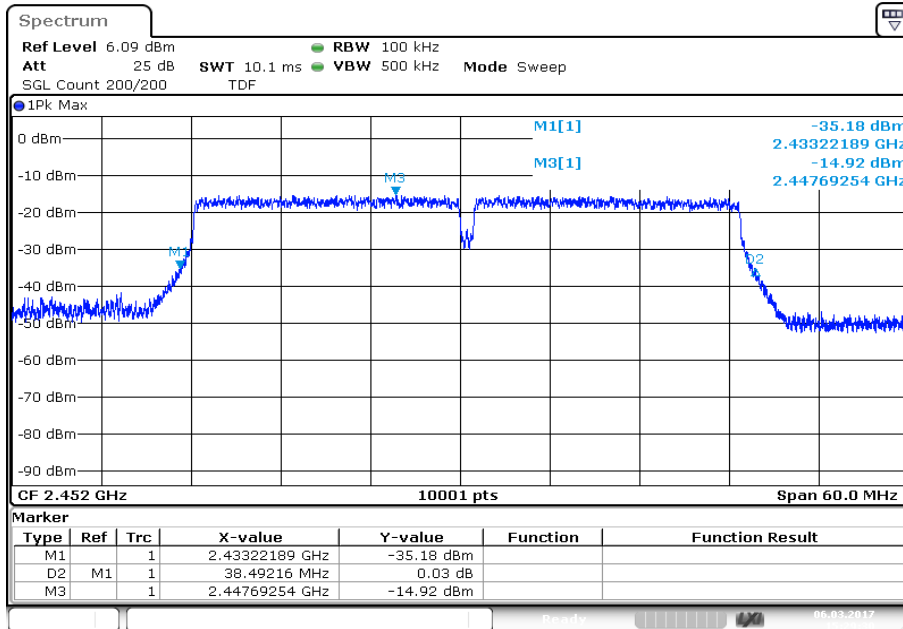

Date: 6.MAR.2017 15:29:31

11.9 Band edge compliance conducted

Description:

Measurement of the radiated band edge compliance with a conducted test setup.

Measurement:

Measurement parameter for measurements	
According to DTS clause: 13.3.2 and clause 12.2.2	
Detector:	RMS
Sweep time:	Auto
Resolution bandwidth:	100 kHz
Video bandwidth:	300 kHz
Span:	Lower band edge: 2388 MHz to 2390 MHz (2 MHz) Upper band edge: 2483.5 MHz to 2485.5 MHz (2 MHz)
Trace mode:	Trace average with 200 counts
Test setup:	See sub clause 6.5 – A
Measurement uncertainty	See sub clause 8

Limits:

FCC	IC
-41.26 dBm	

Results:

Scenario	Band edge compliance [dBm] (incl. mismatch correction factor and antenna gain)			
	DSSS / b – mode	OFDM / g – mode	OFDM / n HT20 – mode	OFDM / n HT40 – mode
Max. lower band edge power	-59.1	-44.2	-41.6	-46.0
Max. upper band edge power	-59.5	-47.6	-43.0	-44.6

Plots: DSSS / b – mode

Plot 1: Lower band edge

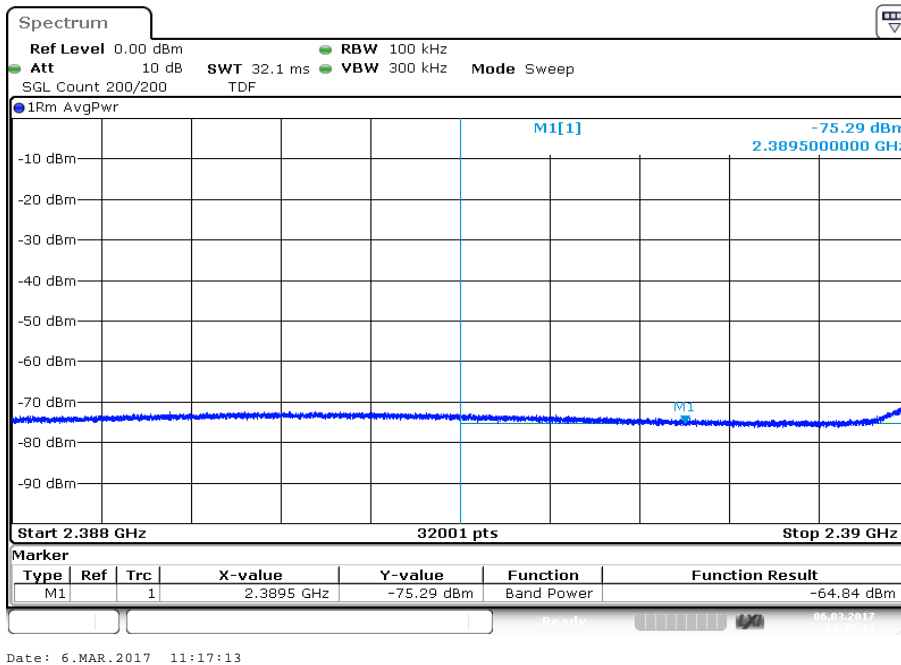

Plot 2: Upper band edge

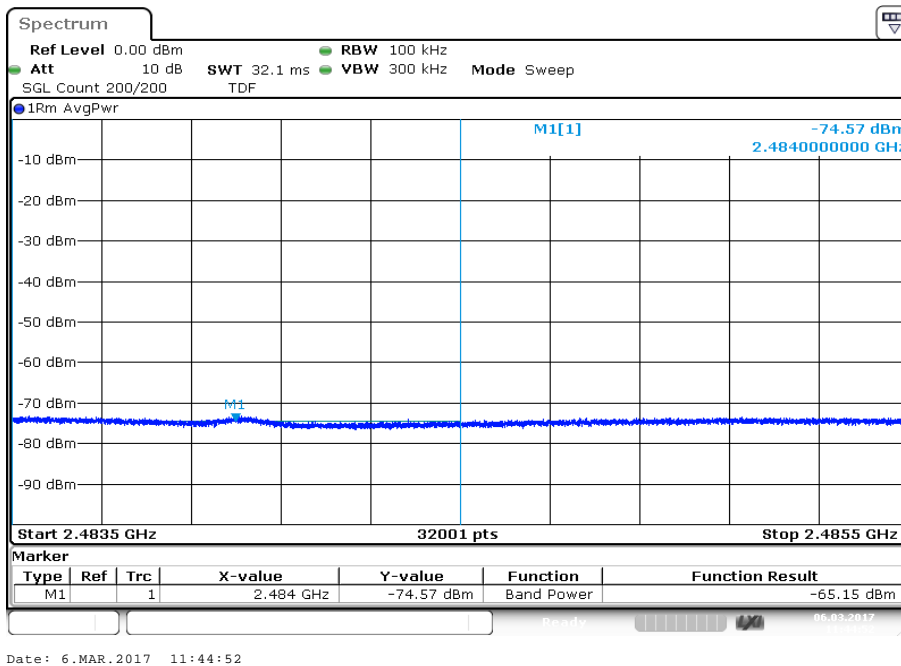

Plots: OFDM / g – mode

Plot 1: Lower band edge

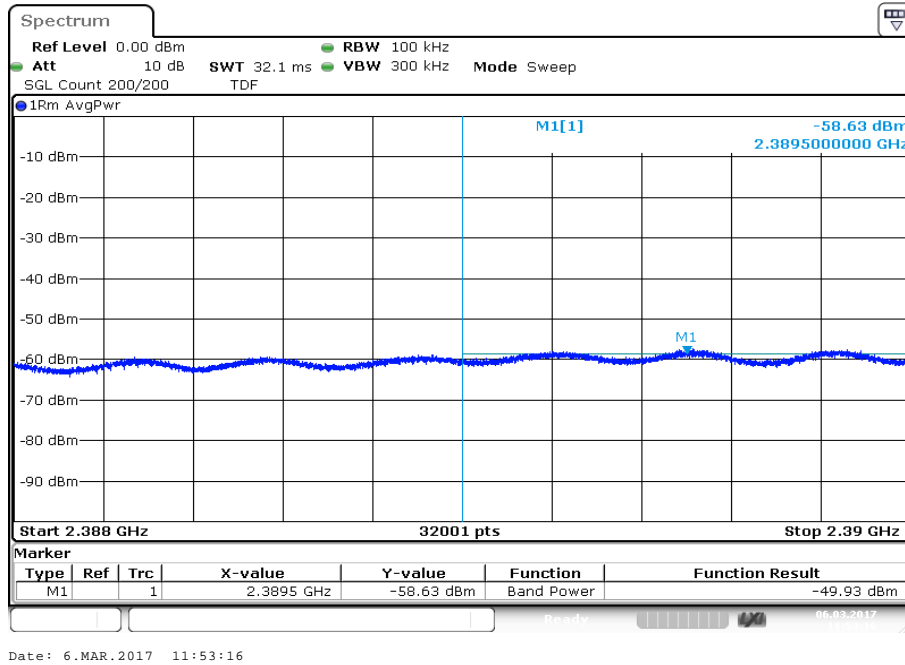

Plot 2: Upper band edge

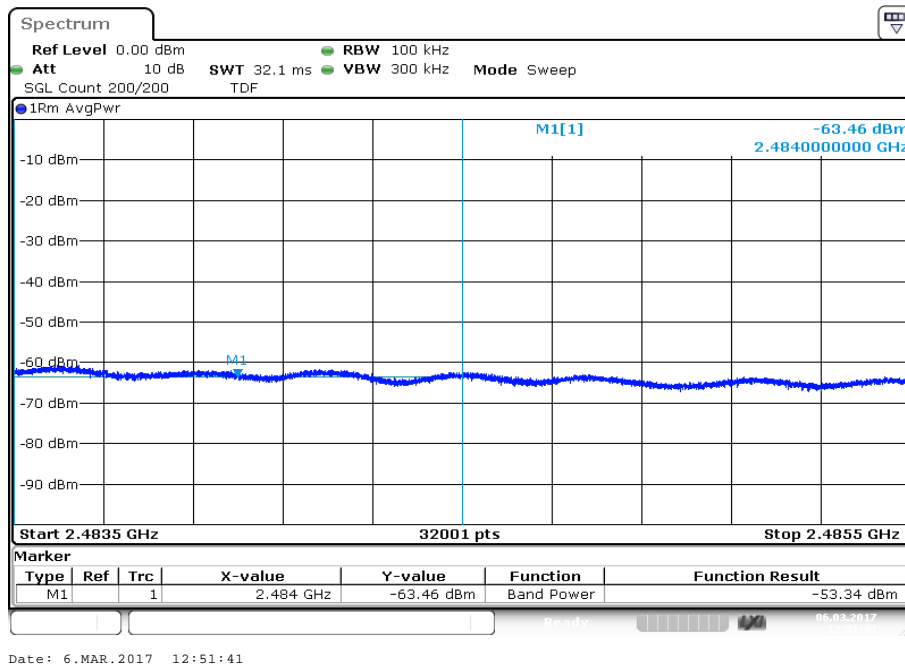

Plots: OFDM / n HT20 – mode

Plot 1: Lower band edge

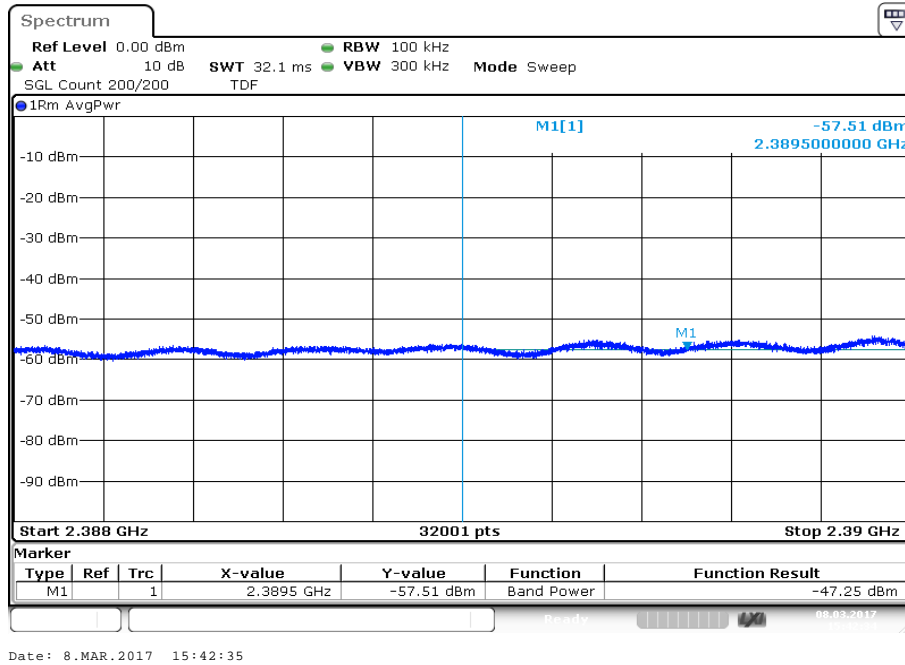

Plot 2: Upper band edge

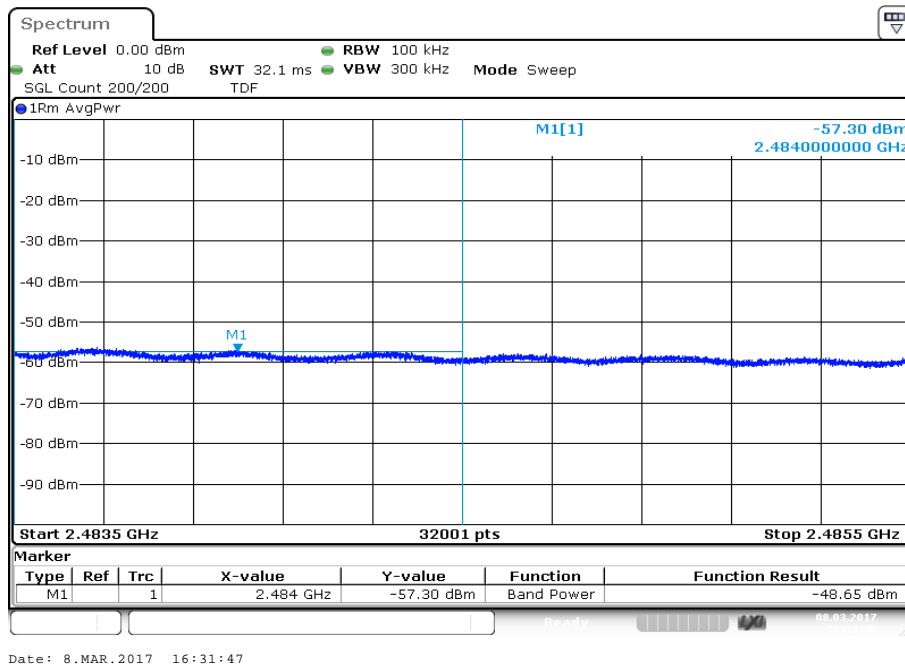

Plots: OFDM / n HT40 – mode

Plot 1: Lower band edge

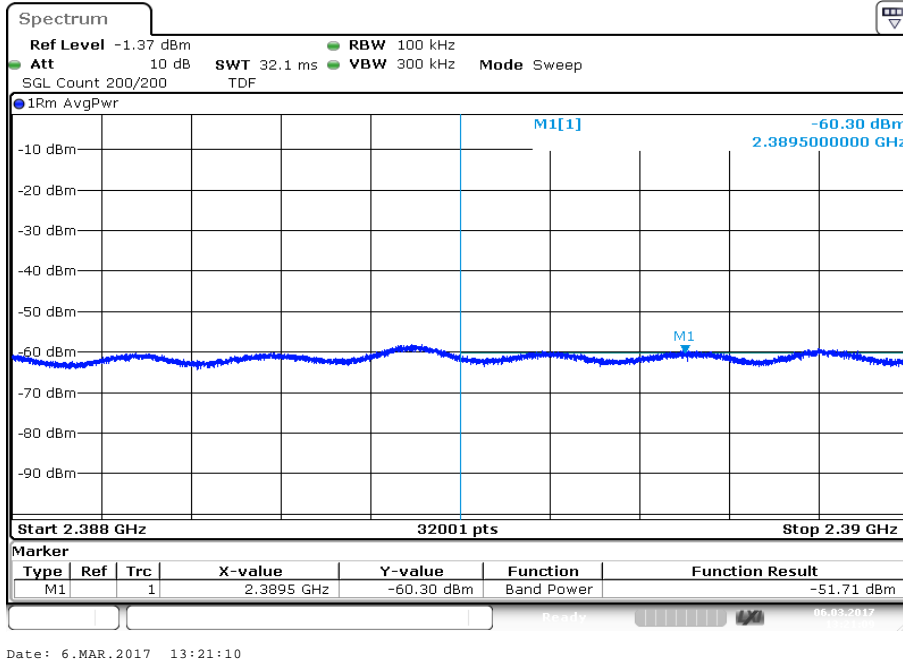

Plot 2: Upper band edge

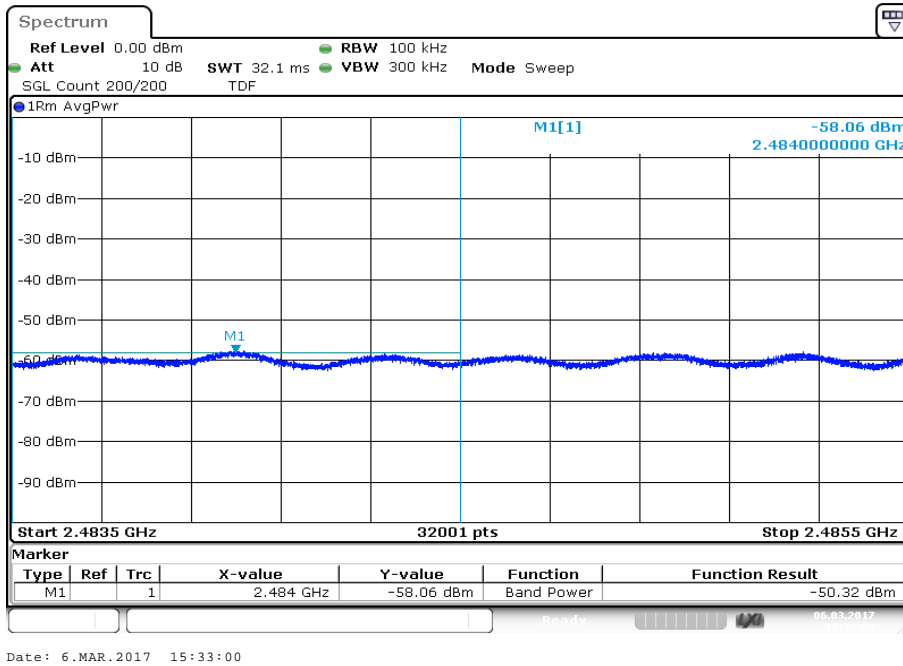

11.10 Spurious emissions conducted

Description:

Measurement of the conducted spurious emissions in transmit mode. The measurement is performed at channel 1, 6 and 11. The measurement is repeated for all modulations.

Measurement:

Measurement parameter	
Detector:	Peak
Sweep time:	Auto
Resolution bandwidth:	100 kHz
Video bandwidth:	500 kHz
Span:	9 kHz to 25 GHz
Trace mode:	Max Hold
Test setup:	See sub clause 6.5 – A
Measurement uncertainty	See sub clause 8

Limits:

FCC	IC
In any 100 kHz bandwidth outside the frequency band in which the spread spectrum or digitally modulated intentional radiator is operating, the radio frequency power that is produced by the intentional radiator shall be at least 30 dB below that in the 100 kHz bandwidth within the band that contains the highest level of the desired power, based on either an RF conducted or a radiated measurement. Attenuation below the general limits specified in Section 15.209(a) is not required	

Results: DSSS / b – mode

TX Spurious Emissions Conducted					
DSSS / b – mode					
f [MHz]		amplitude of emission [dBm]	limit max. allowed emission power	actual attenuation below frequency of operation [dB]	results
2412		-6.5	30 dBm		Operating frequency
All detected emissions are below the -20 dBc criteria.			-20 dBc (peak) -30 dBc (average)		compliant
2437		-6.9	30 dBm		Operating frequency
All detected emissions are below the -20 dBc criteria.			-20 dBc (peak) -30 dBc (average)		compliant
2462		-7.0	30 dBm		Operating frequency
All detected emissions are below the -20 dBc criteria.			-20 dBc (peak) -30 dBc (average)		compliant

Results: OFDM / g – mode

TX Spurious Emissions Conducted					
OFDM / g – mode					
f [MHz]		amplitude of emission [dBm]	limit max. allowed emission power	actual attenuation below frequency of operation [dB]	results
2412		-9.3	30 dBm		Operating frequency
All detected emissions are below the -20 dBc criteria.			-20 dBc (peak) -30 dBc (average)		compliant
2417		-8.0	30 dBm		Operating frequency
All detected emissions are below the -20 dBc criteria.			-20 dBc (peak) -30 dBc (average)		compliant
2437		-7.7	30 dBm		Operating frequency
All detected emissions are below the -20 dBc criteria.			-20 dBc (peak) -30 dBc (average)		compliant
2457		-8.4	30 dBm		Operating frequency
All detected emissions are below the -20 dBc criteria.			-20 dBc (peak) -30 dBc (average)		compliant
2462		-10.7	30 dBm		Operating frequency
All detected emissions are below the -20 dBc criteria.			-20 dBc (peak) -30 dBc (average)		compliant

Results: OFDM / n HT20 – mode

TX Spurious Emissions Conducted					
OFDM / n HT20 – mode					
f [MHz]		amplitude of emission [dBm]	limit max. allowed emission power	actual attenuation below frequency of operation [dB]	results
2412		-9.5	30 dBm		Operating frequency
All detected emissions are below the -20 dBc criteria.			-20 dBc (peak) -30 dBc (average)		compliant
2417		-8.9	30 dBm		Operating frequency
All detected emissions are below the -20 dBc criteria.			-20 dBc (peak) -30 dBc (average)		compliant
2437		-9.5	30 dBm		Operating frequency
All detected emissions are below the -20 dBc criteria.			-20 dBc (peak) -30 dBc (average)		compliant
2457		-9.4	30 dBm		Operating frequency
All detected emissions are below the -20 dBc criteria.			-20 dBc (peak) -30 dBc (average)		compliant
2462		-9.7	30 dBm		Operating frequency
All detected emissions are below the -20 dBc criteria.			-20 dBc (peak) -30 dBc (average)		compliant

Results: OFDM / n HT40 – mode

TX Spurious Emissions Conducted					
OFDM / n HT40 – mode					
f [MHz]		amplitude of emission [dBm]	limit max. allowed emission power	actual attenuation below frequency of operation [dB]	results
2422		-17.8	30 dBm		Operating frequency
All detected emissions are below the -20 dBc criteria.			-20 dBc (peak) -30 dBc (average)		compliant
2427		-17.0	30 dBm		Operating frequency
All detected emissions are below the -20 dBc criteria.			-20 dBc (peak) -30 dBc (average)		compliant
2432		-16.6	30 dBm		Operating frequency
All detected emissions are below the -20 dBc criteria.			-20 dBc (peak) -30 dBc (average)		compliant
2437		-14.5	30 dBm		Operating frequency
All detected emissions are below the -20 dBc criteria.			-20 dBc (peak) -30 dBc (average)		compliant
2442		-14.3	30 dBm		Operating frequency
All detected emissions are below the -20 dBc criteria.			-20 dBc (peak) -30 dBc (average)		compliant
2447		-17.0	30 dBm		Operating frequency
All detected emissions are below the -20 dBc criteria.			-20 dBc (peak) -30 dBc (average)		compliant
2452		-15.1	30 dBm		Operating frequency
All detected emissions are below the -20 dBc criteria.			-20 dBc (peak) -30 dBc (average)		compliant

Plots: DSSS / b – mode

Plot 1: Channel 1, up to 25 GHz

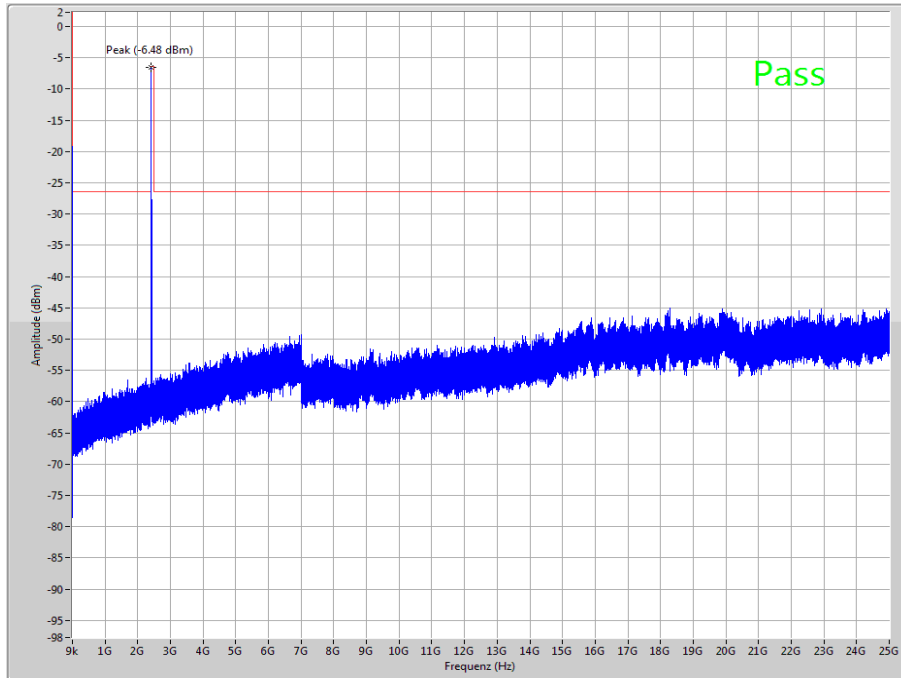

The peak at the beginning of the plot is the LO from the SA.

Plot 2: Channel 1, zoomed carrier

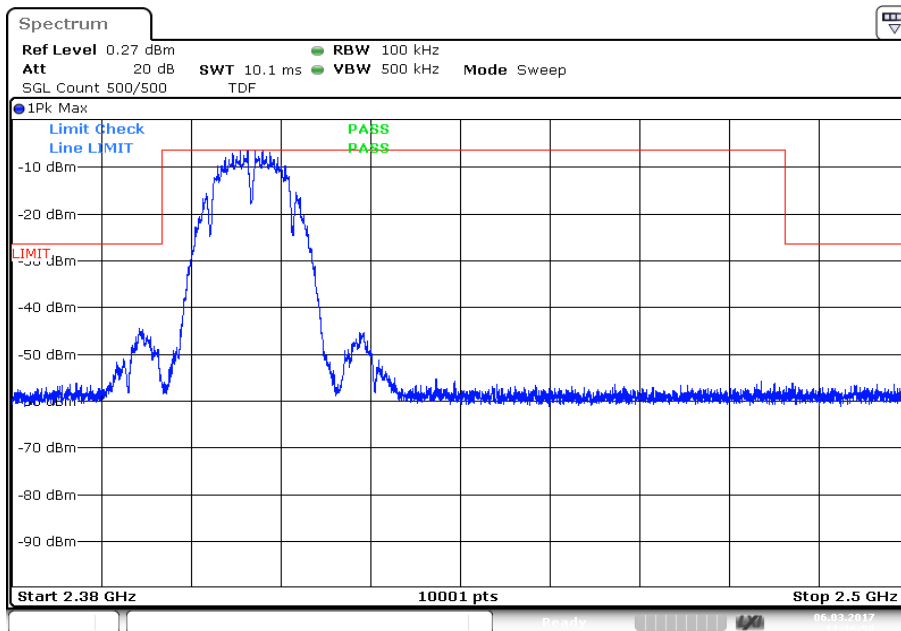

Date: 6.MAR.2017 11:16:58

Plot 3: Channel 6, up to 25 GHz

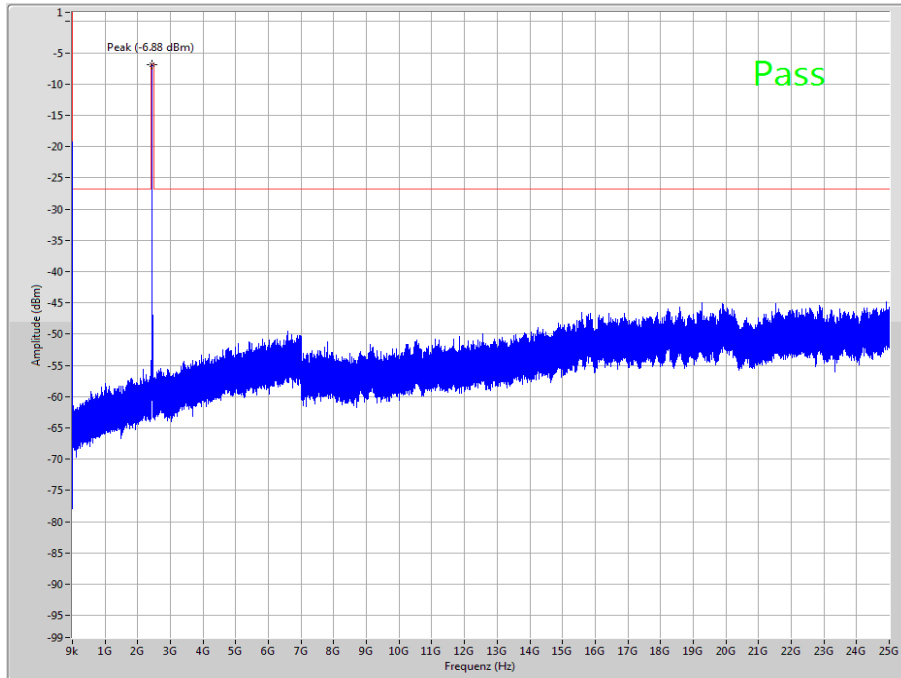

The peak at the beginning of the plot is the LO from the SA.

Plot 4: Channel 6, zoomed carrier

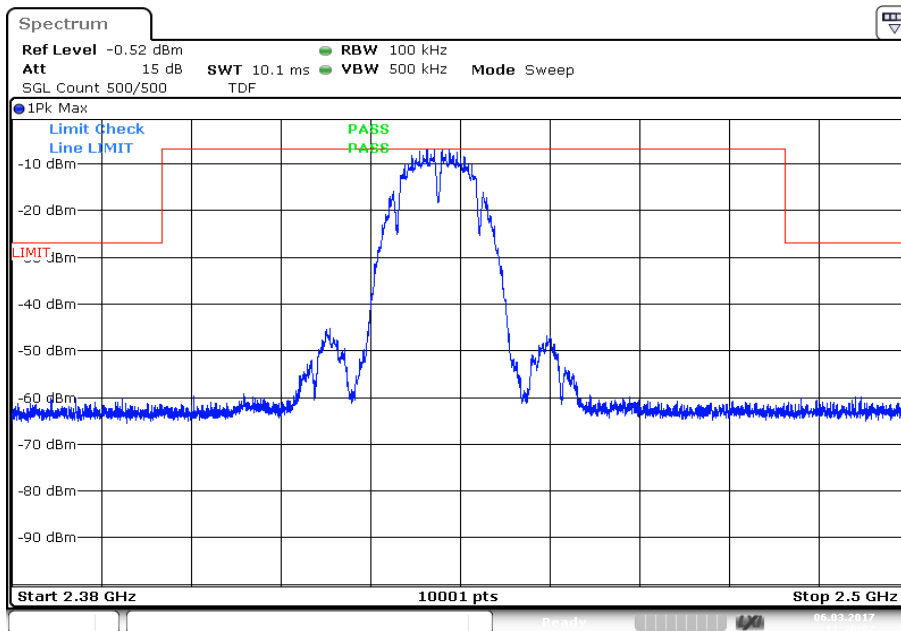

Plot 5: Channel 11, up to 25 GHz

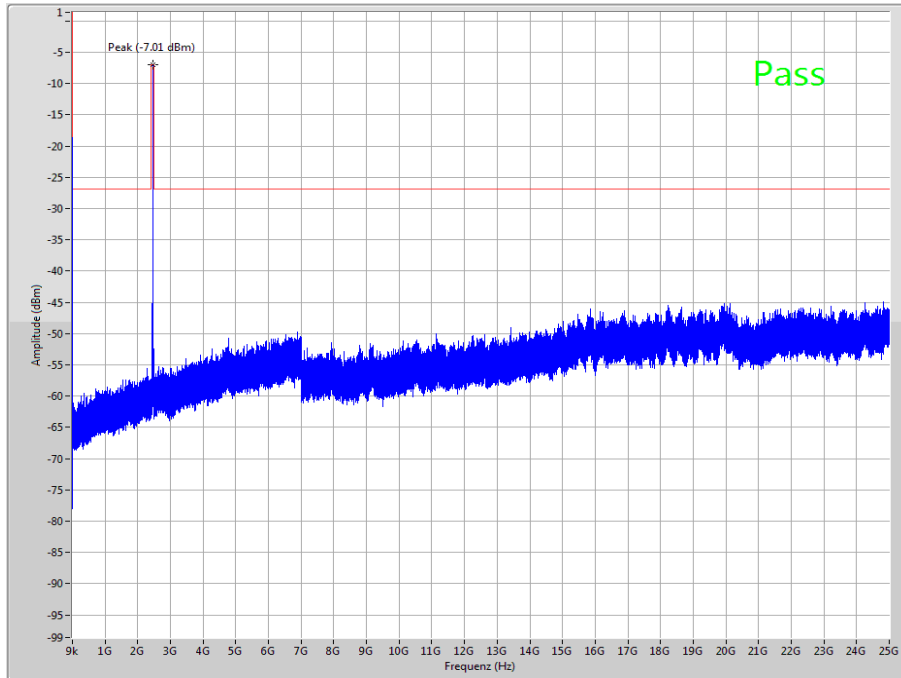

The peak at the beginning of the plot is the LO from the SA.

Plot 6: Channel 11, zoomed carrier

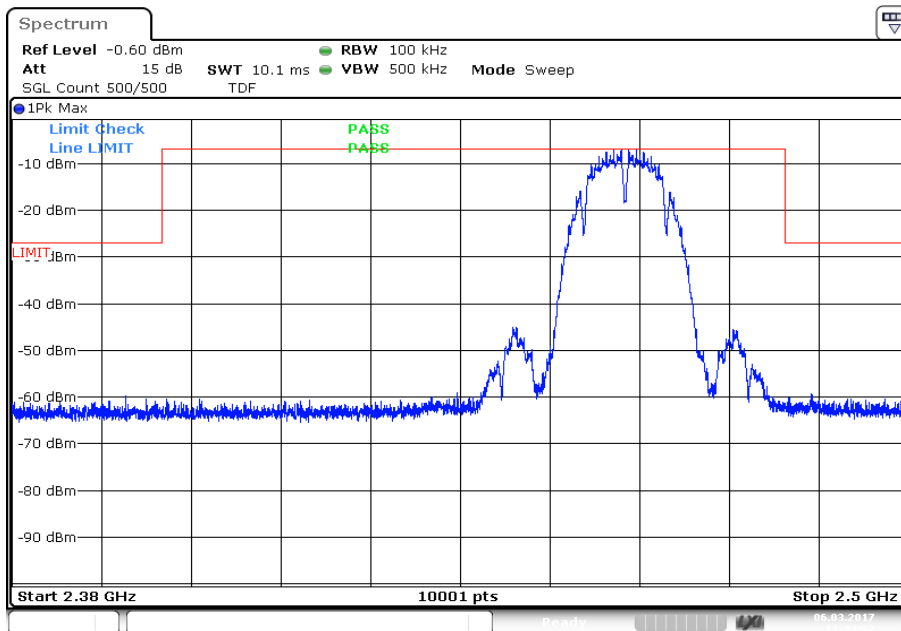

Plots: OFDM / g – mode

Plot 1: Channel 1, up to 25 GHz

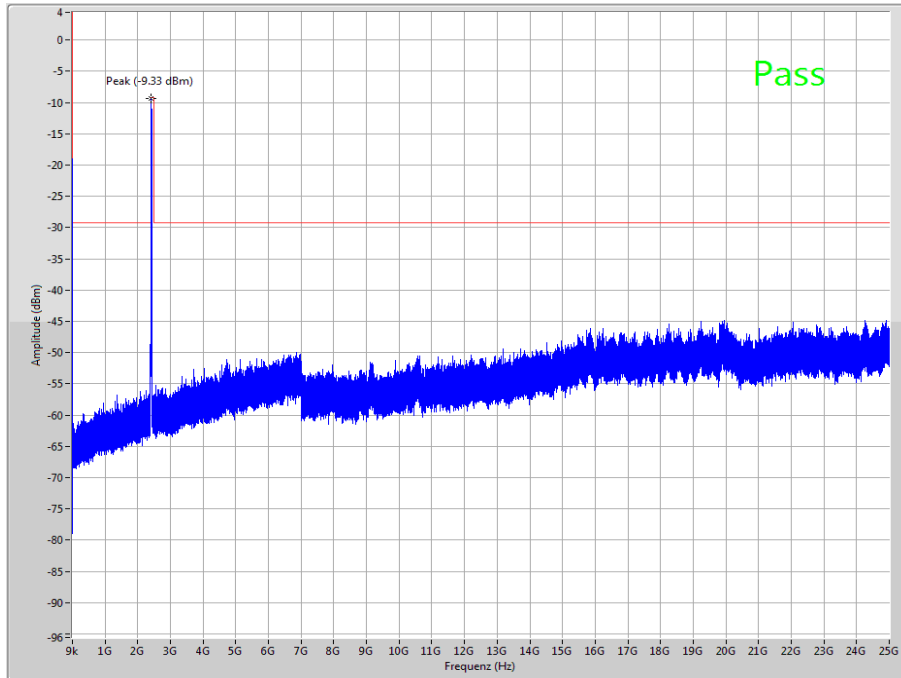

The peak at the beginning of the plot is the LO from the SA.

Plot 2: Channel 1, zoomed carrier

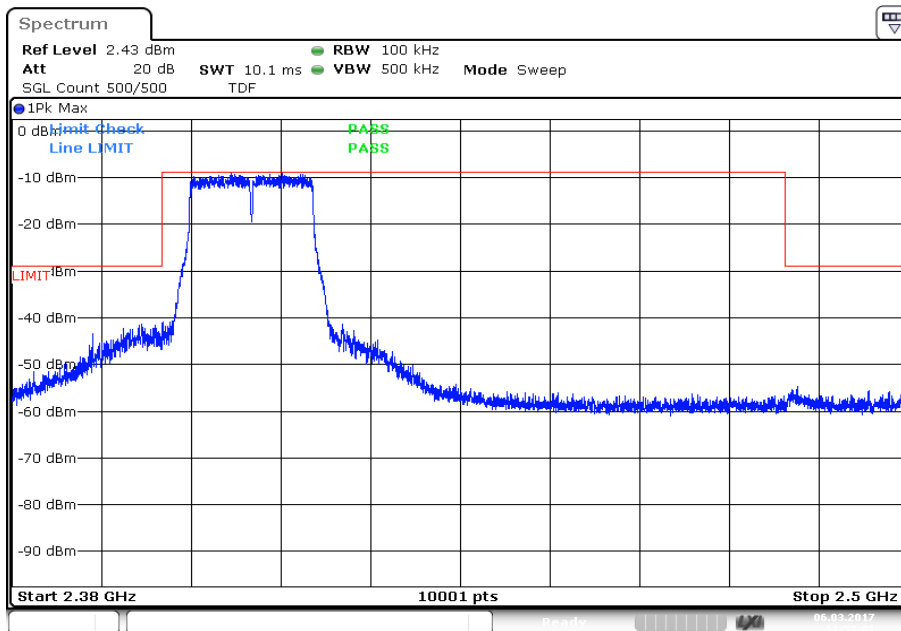

Date: 6.MAR.2017 11:53:02

Plot 3: Channel 2, up to 25 GHz

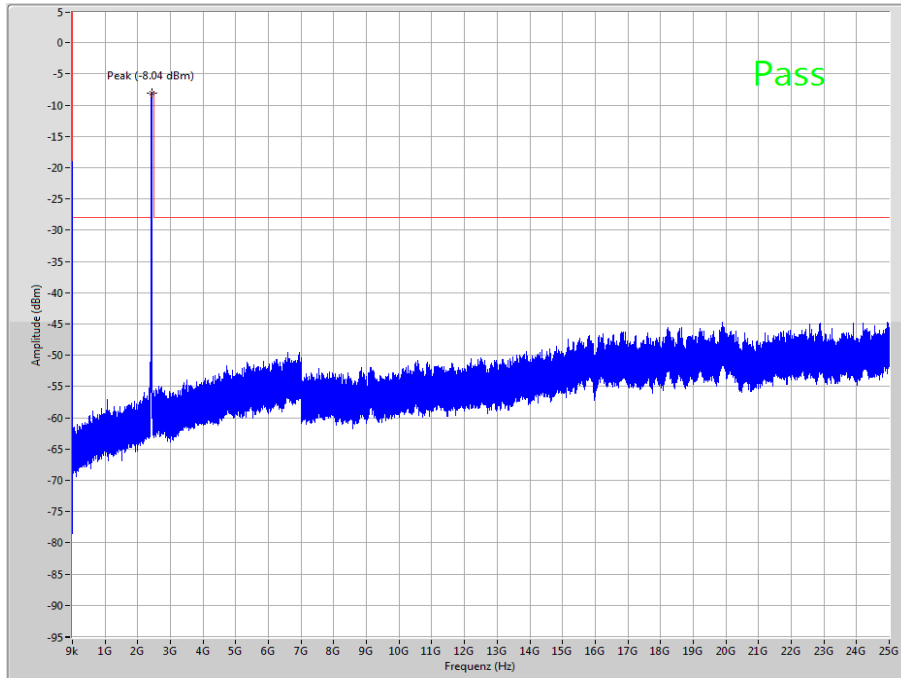

The peak at the beginning of the plot is the LO from the SA.

Plot 4: Channel 2, zoomed carrier

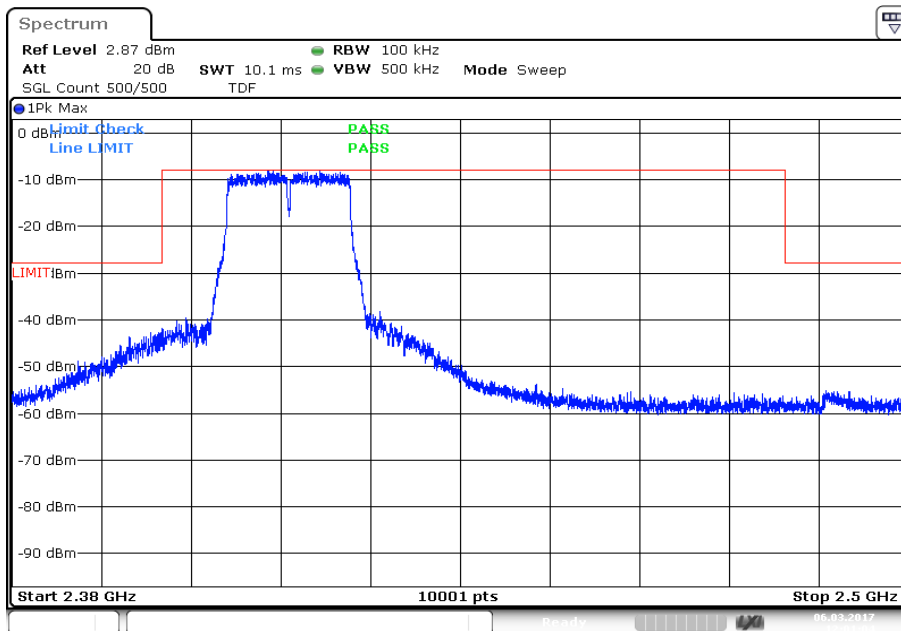

Date: 6.MAR.2017 12:01:04

Plot 5: Channel 6, up to 25 GHz

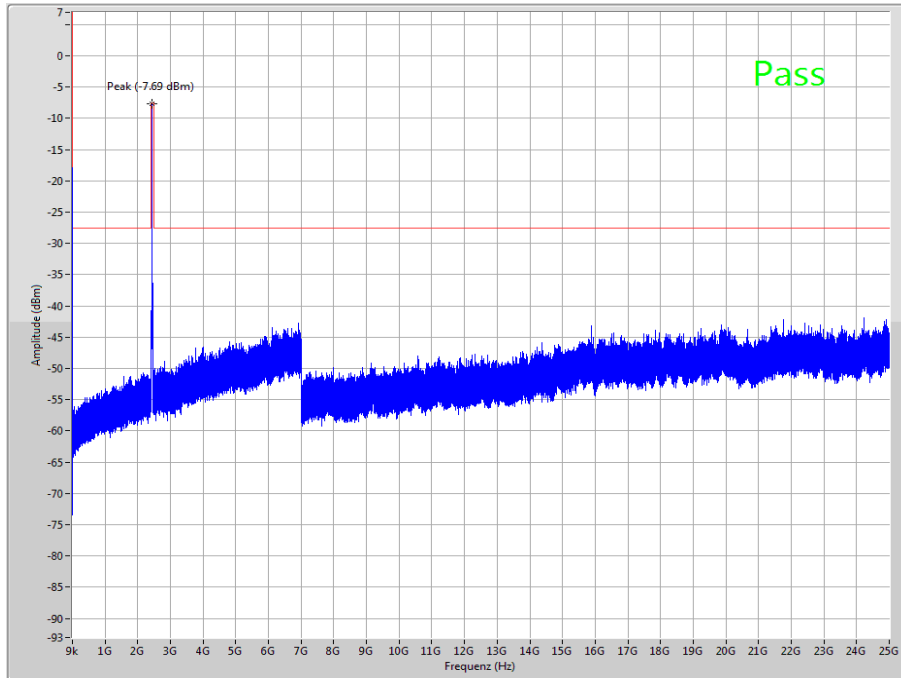

The peak at the beginning of the plot is the LO from the SA.

Plot 6: Channel 6, zoomed carrier

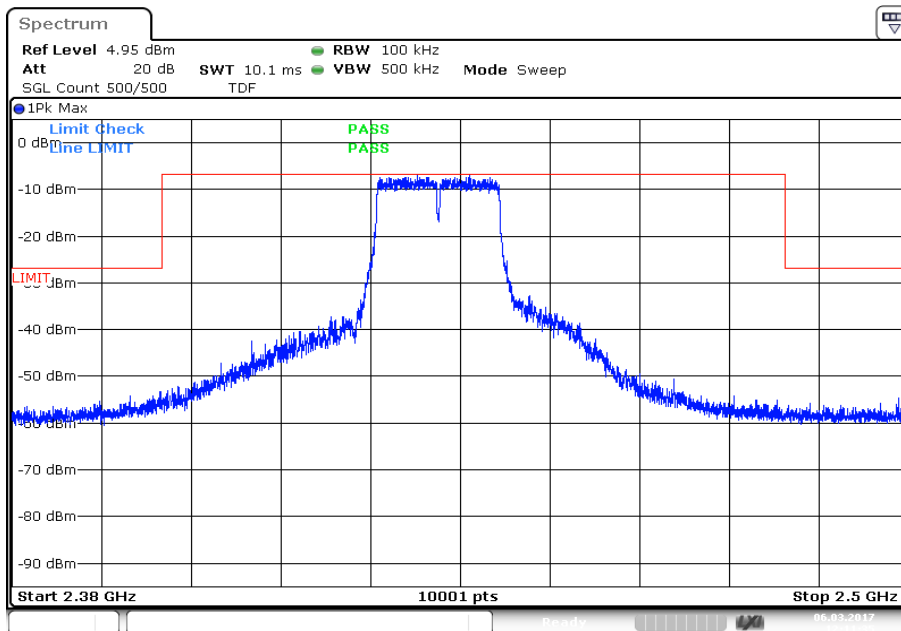

Date: 6.MAR.2017 12:11:36

Plot 7: Channel 10, up to 25 GHz

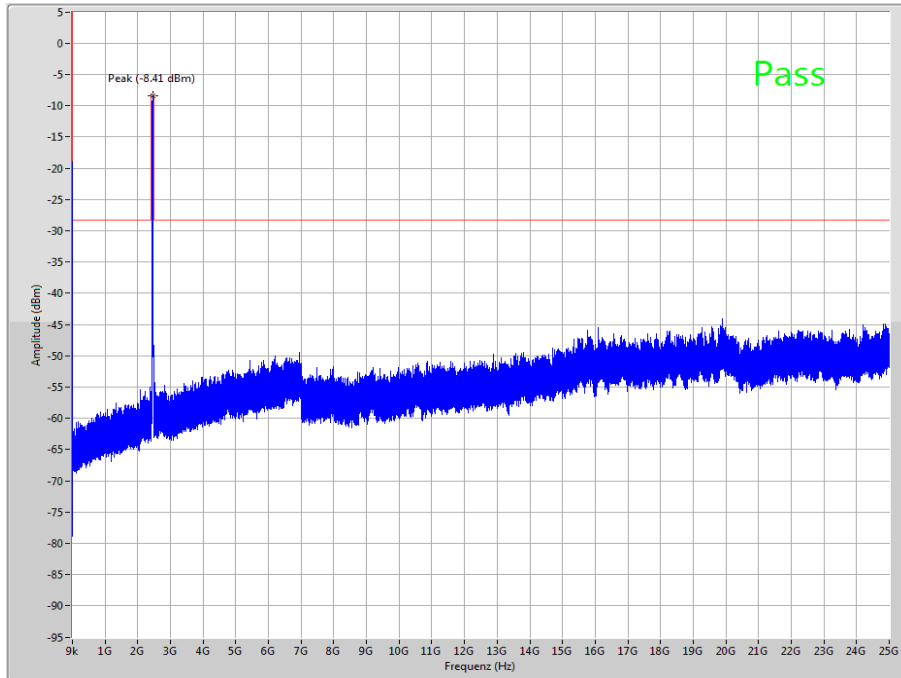

The peak at the beginning of the plot is the LO from the SA.

Plot 8: Channel 10, zoomed carrier

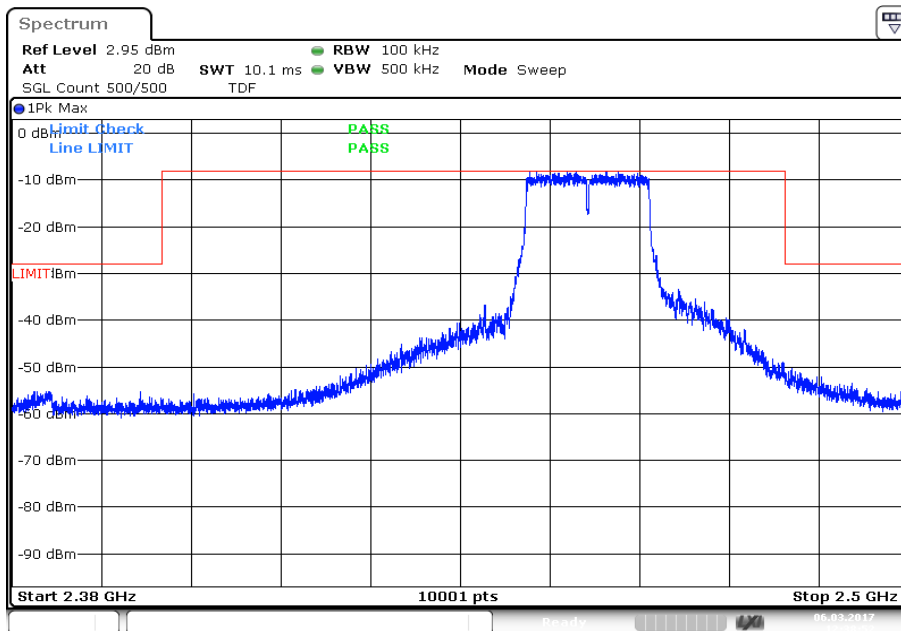

Plot 9: Channel 11, up to 25 GHz

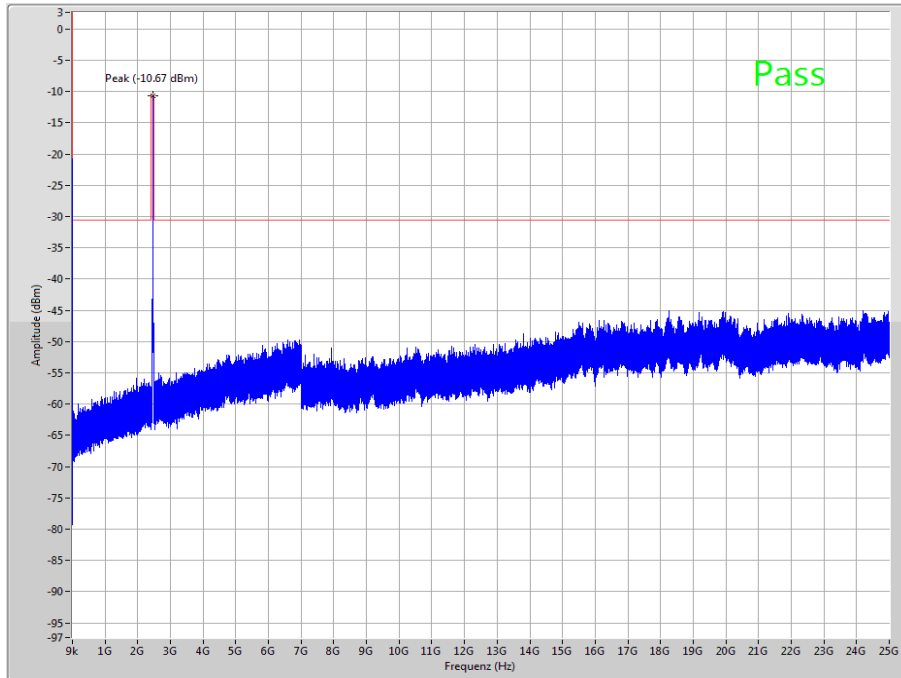

The peak at the beginning of the plot is the LO from the SA.

Plot 10: Channel 11, zoomed carrier

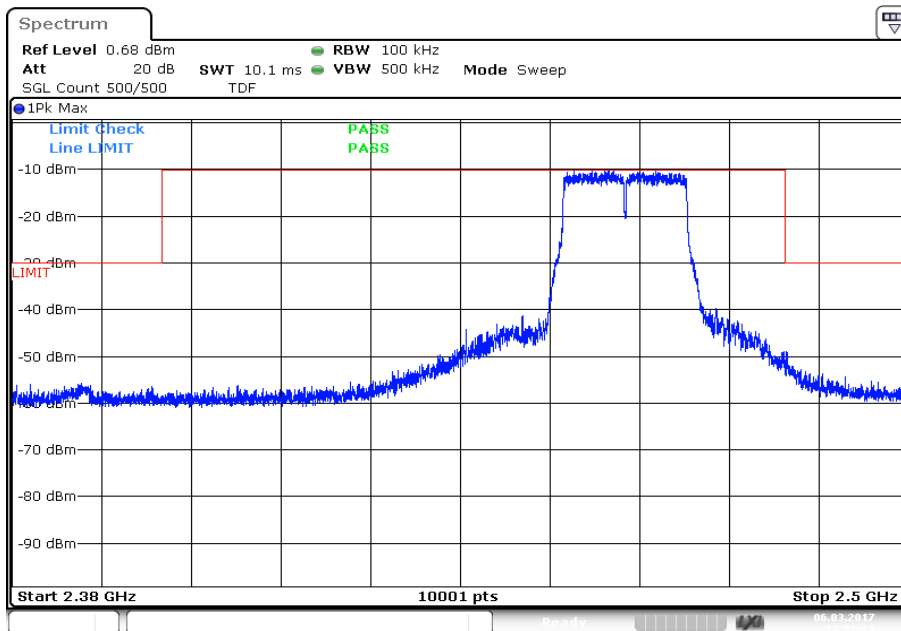

Plot 3: Channel 2, up to 25 GHz

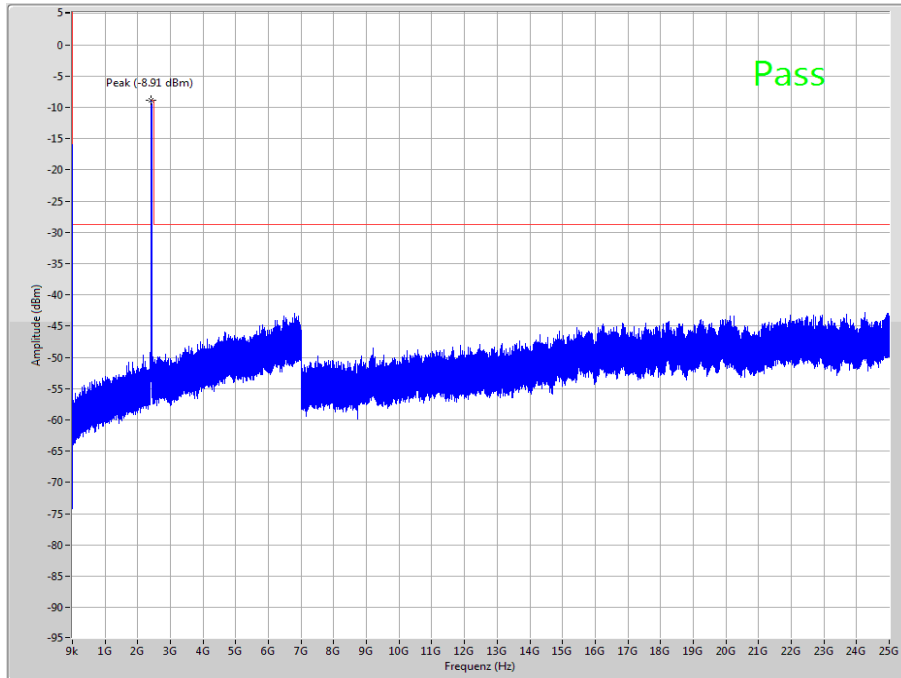

The peak at the beginning of the plot is the LO from the SA.

Plot 4: Channel 2, zoomed carrier

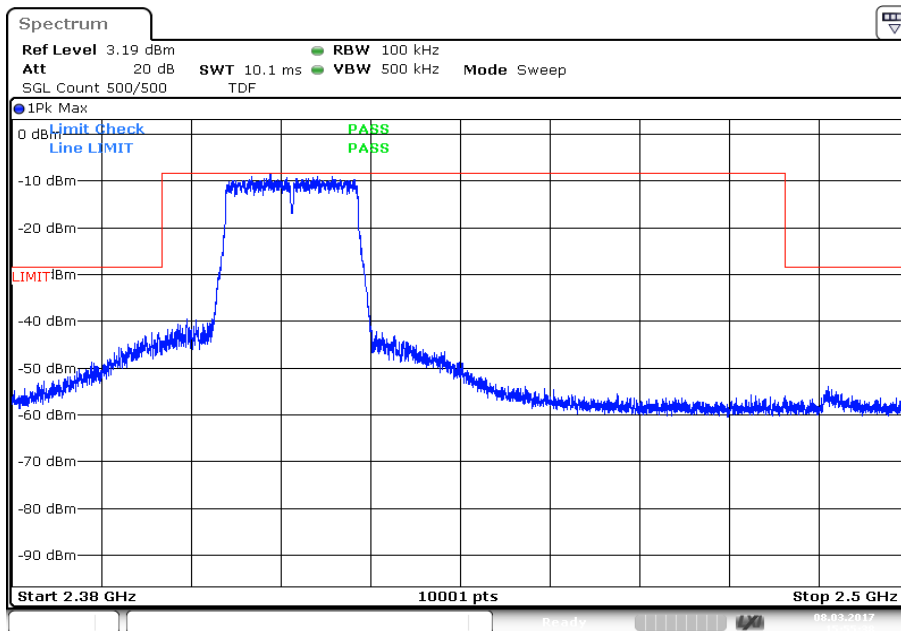

Plot 5: Channel 6, up to 25 GHz

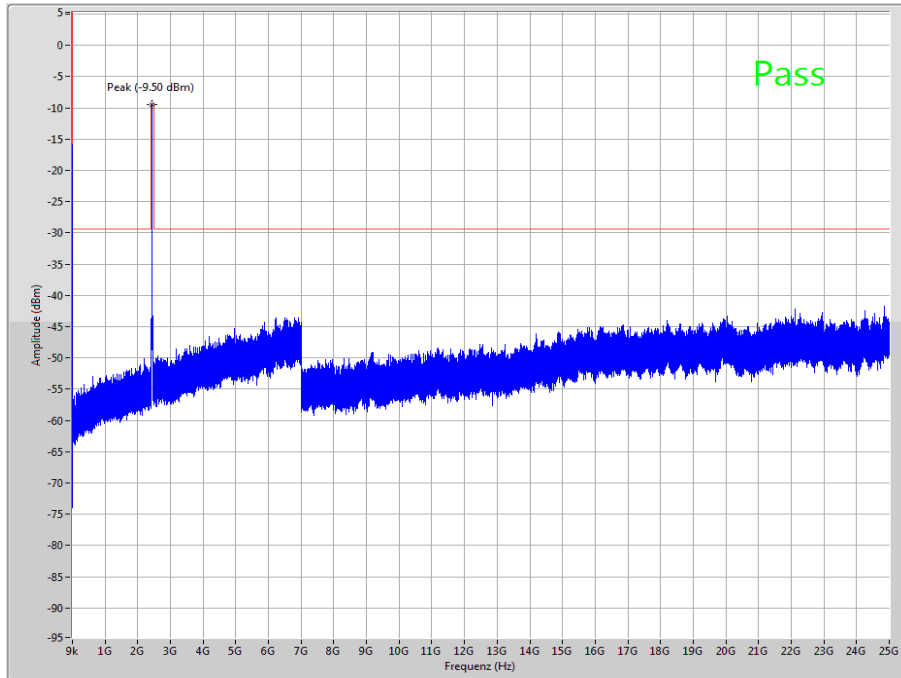

The peak at the beginning of the plot is the LO from the SA.

Plot 6: Channel 6, zoomed carrier

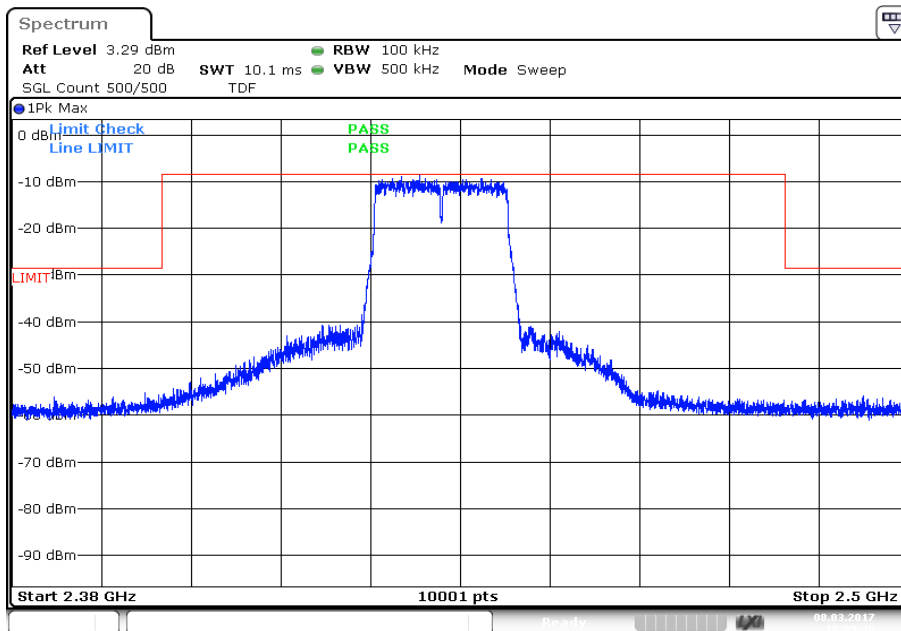

Plot 7: Channel 10, up to 25 GHz

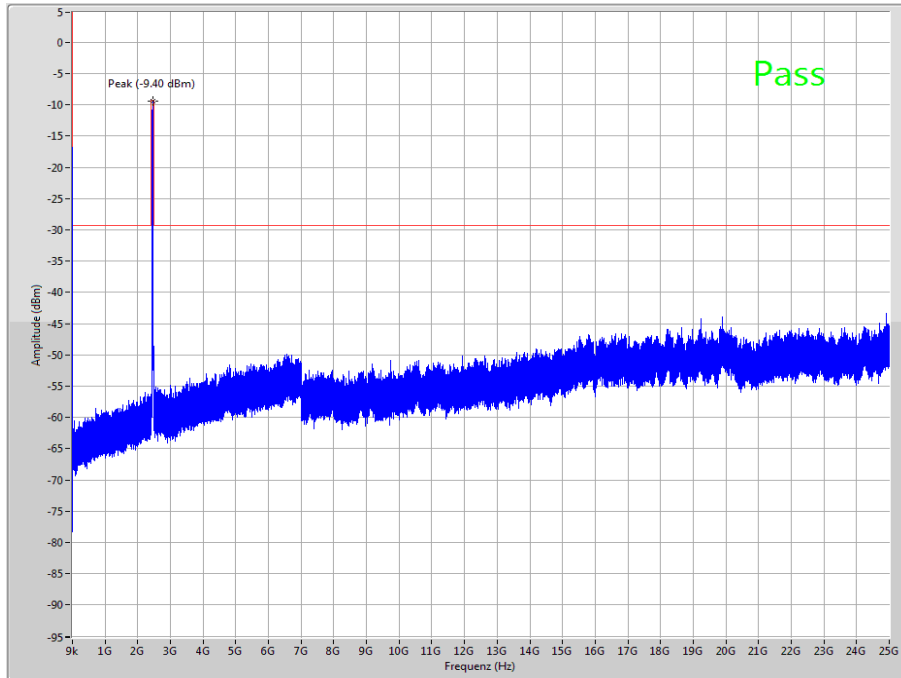

The peak at the beginning of the plot is the LO from the SA.

Plot 8: Channel 10, zoomed carrier

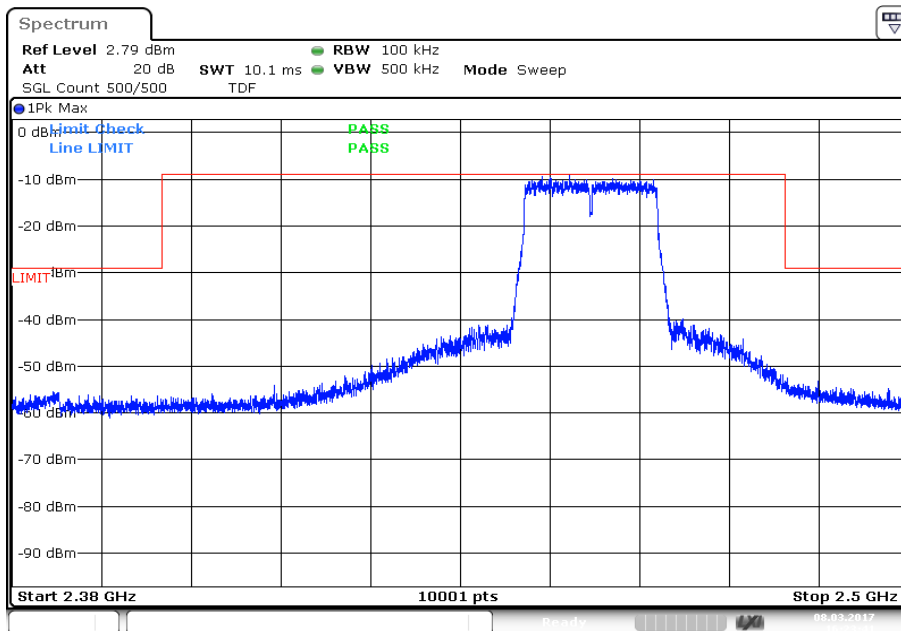

Plot 9: Channel 11, up to 25 GHz

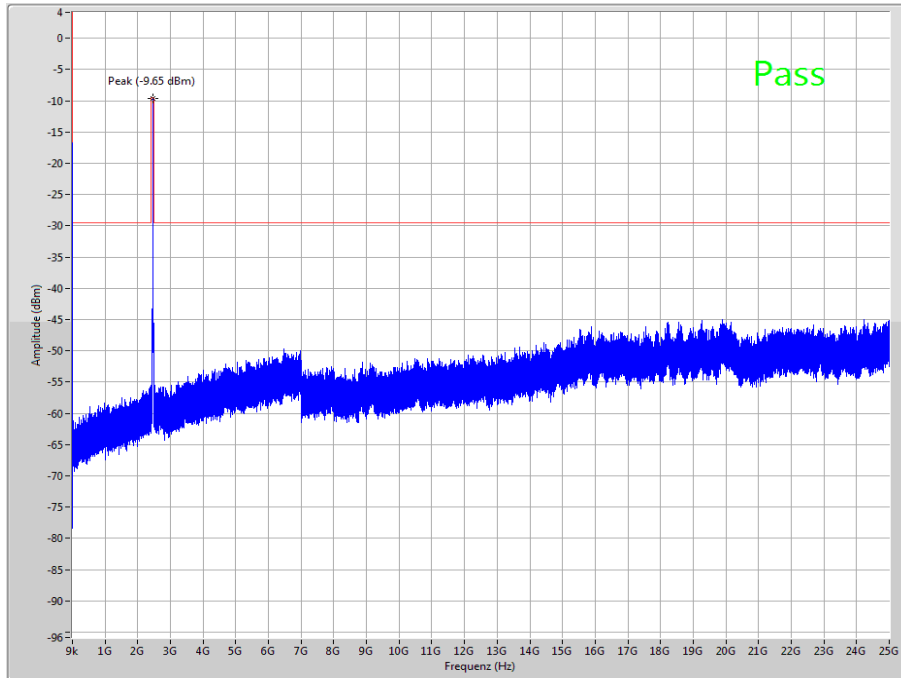

The peak at the beginning of the plot is the LO from the SA.

Plot 10: Channel 11, zoomed carrier

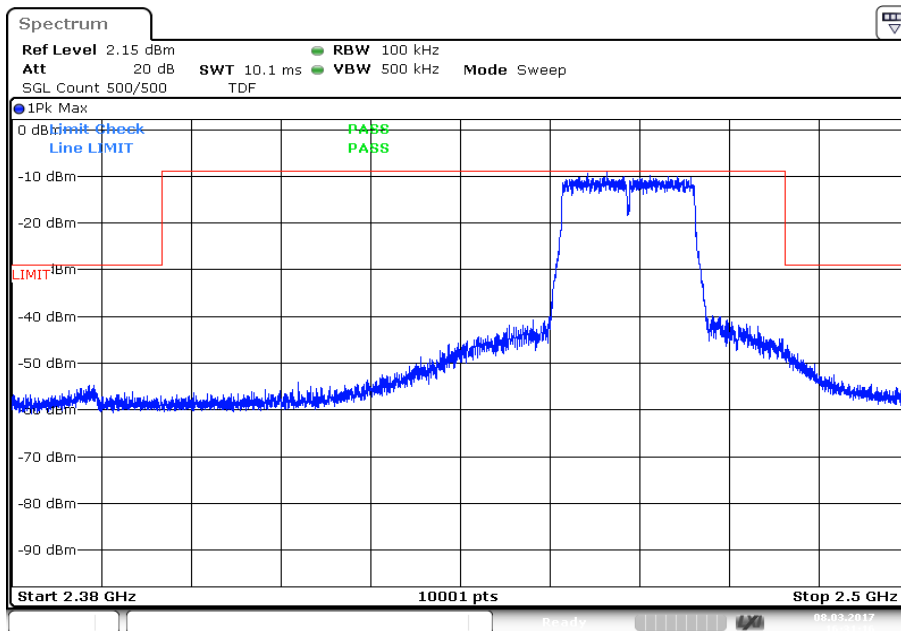

Date: 8.MAR.2017 16:31:17

Plots: OFDM / n HT 40 – mode

Plot 1: Channel 3, up to 25 GHz

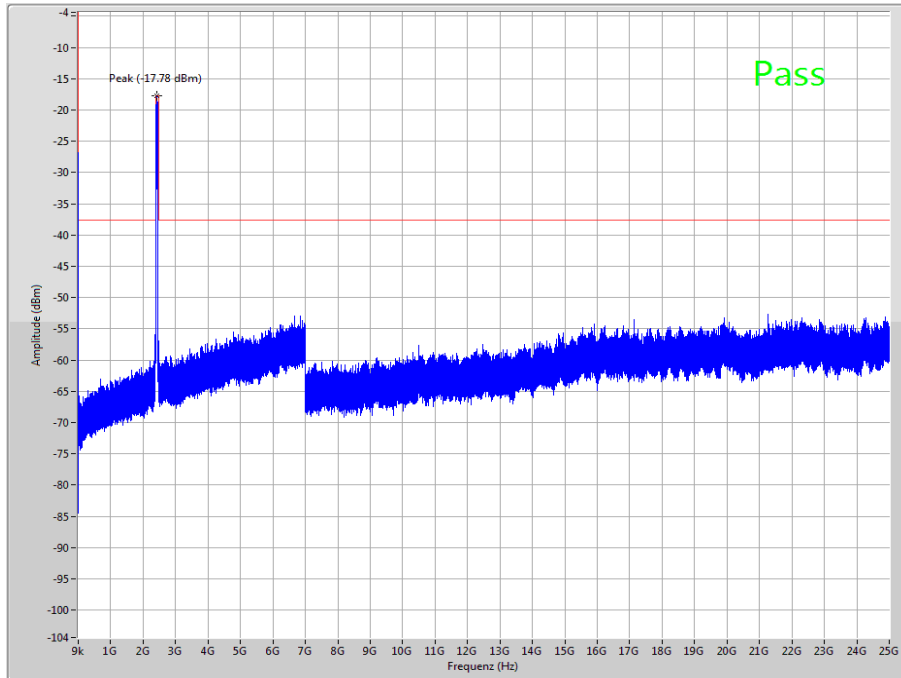

The peak at the beginning of the plot is the LO from the SA.

Plot 2: Channel 3, zoomed carrier

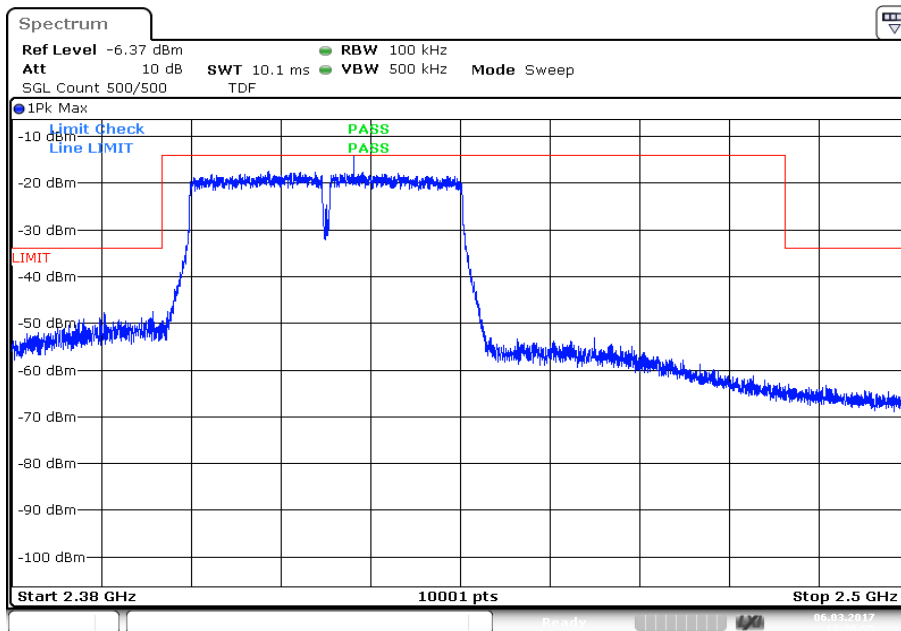

Date: 6.MAR.2017 13:20:55

Plot 3: Channel 4, up to 25 GHz

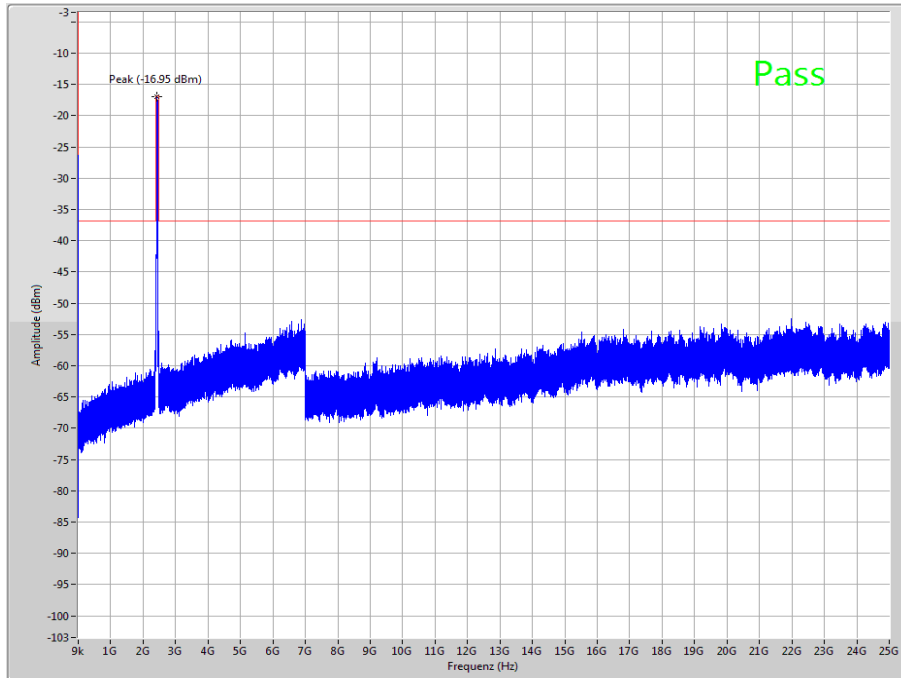

The peak at the beginning of the plot is the LO from the SA.

Plot 4: Channel 4, zoomed carrier

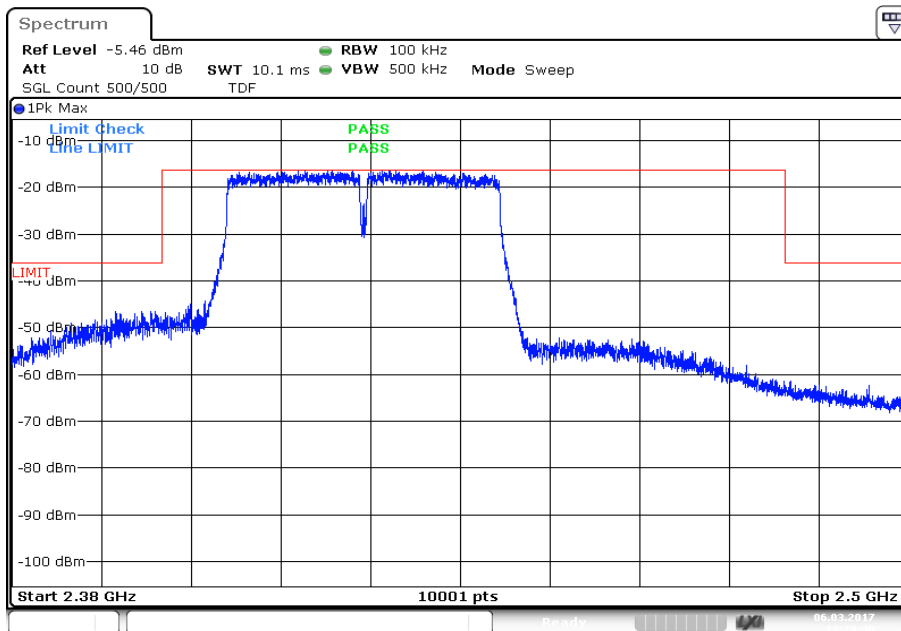

Plot 5: Channel 5, up to 25 GHz

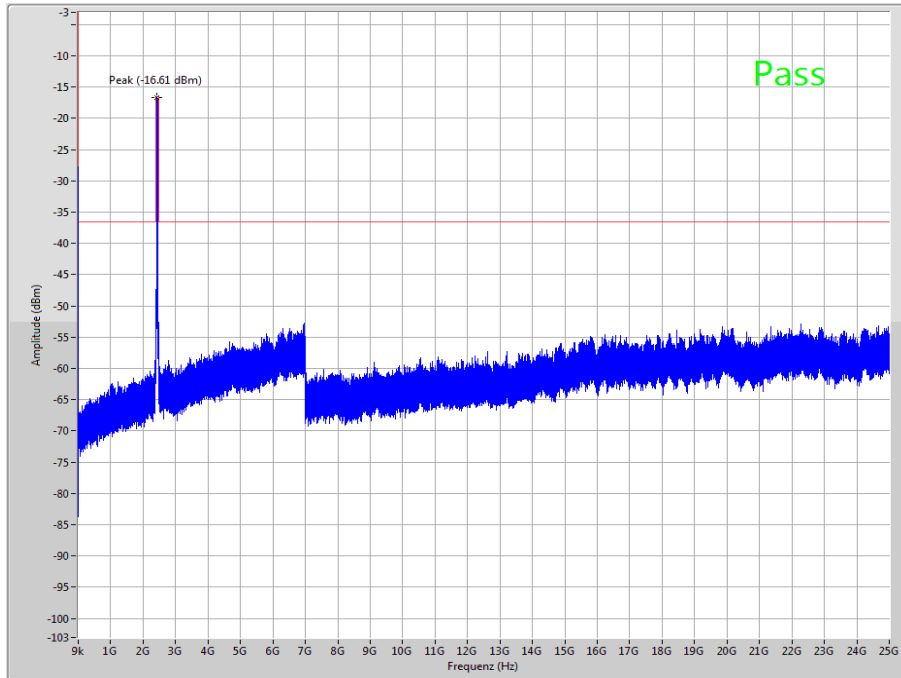

The peak at the beginning of the plot is the LO from the SA.

Plot 6: Channel 5, zoomed carrier

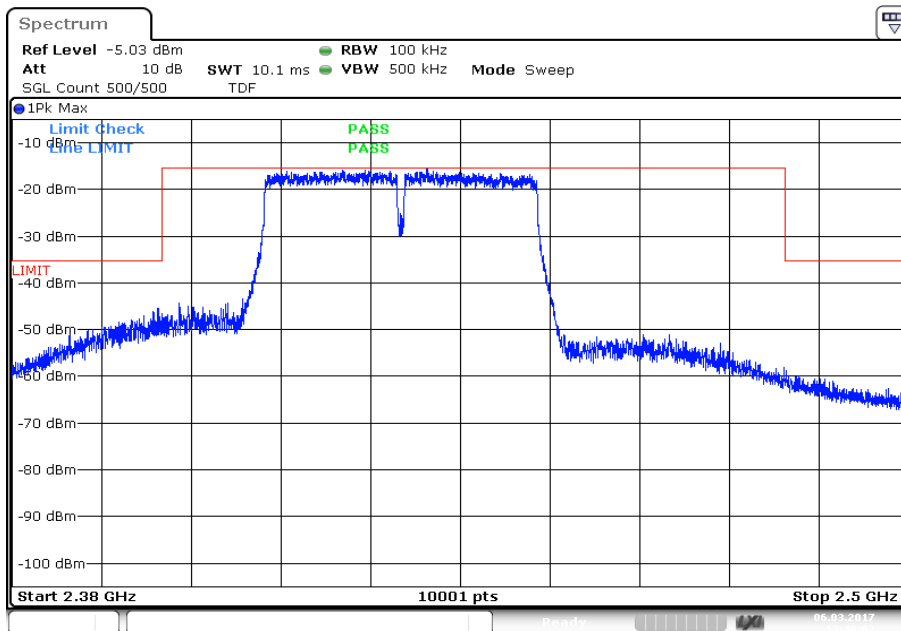

Date: 6.MAR.2017 13:40:03

Plot 7: Channel 6, up to 25 GHz

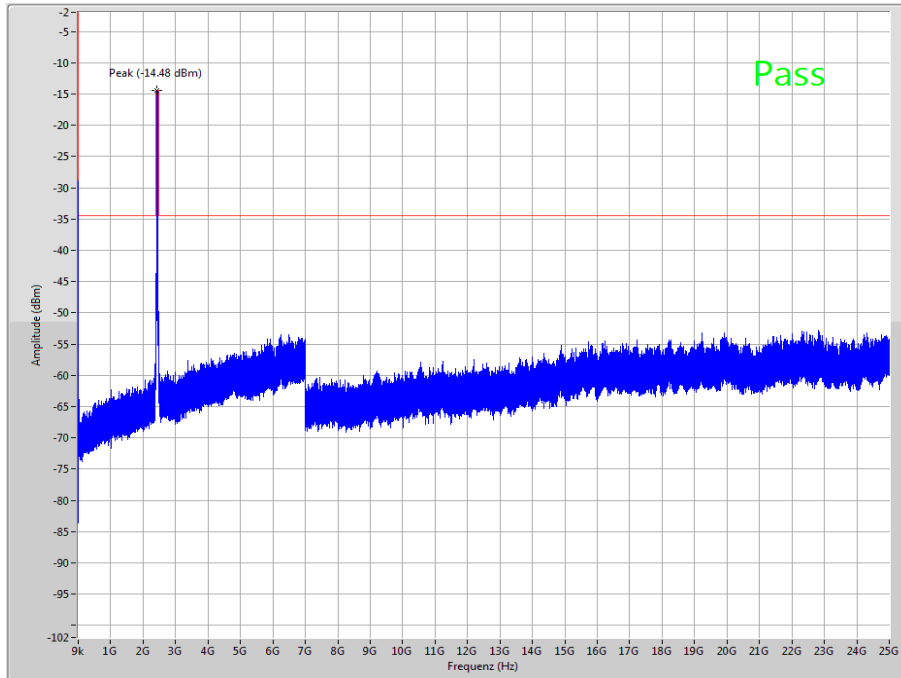

The peak at the beginning of the plot is the LO from the SA.

Plot 8: Channel 6, zoomed carrier

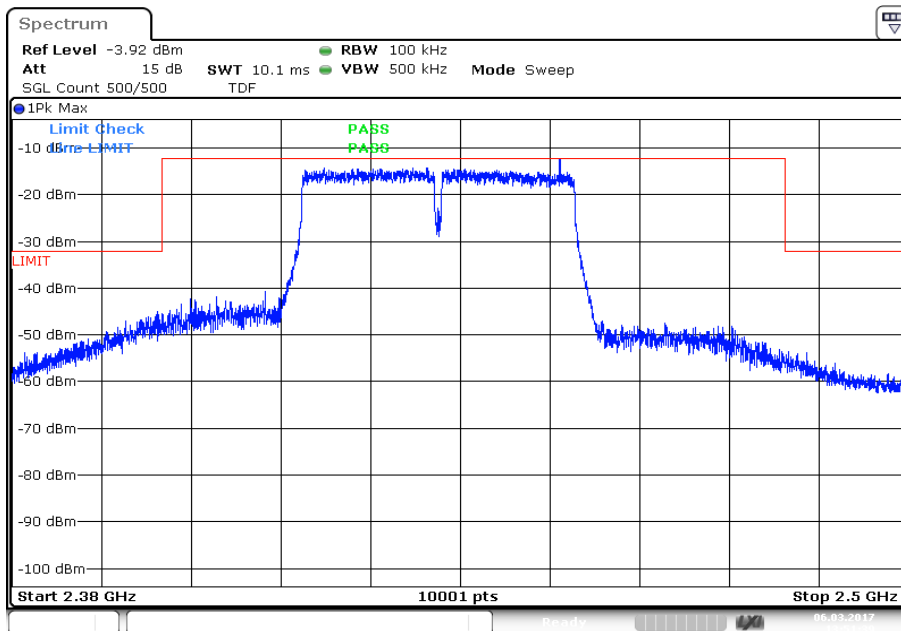

Date: 6.MAR.2017 13:51:40

Plot 9: Channel 7, up to 25 GHz

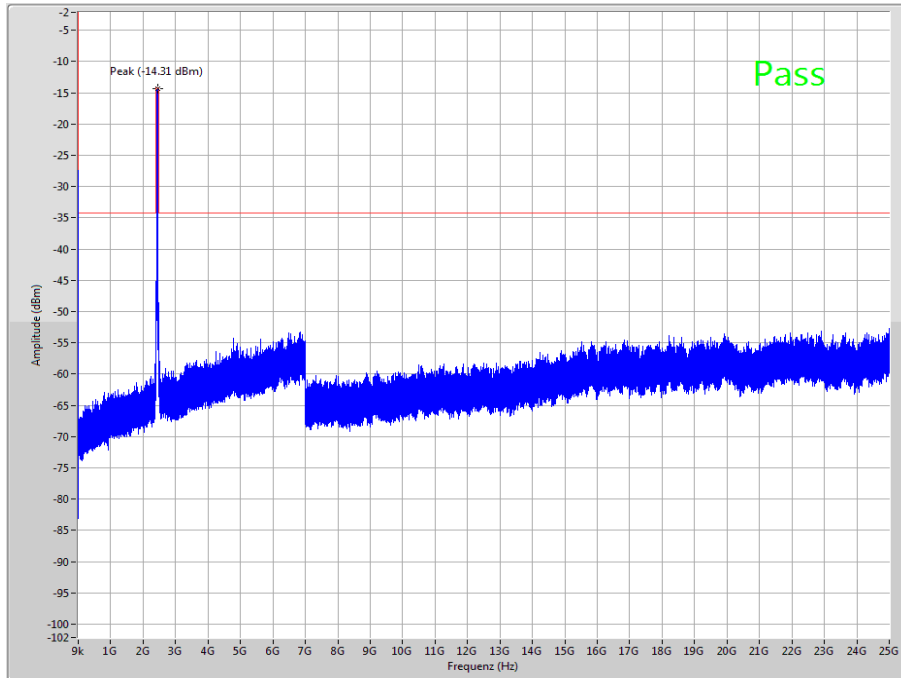

The peak at the beginning of the plot is the LO from the SA.

Plot 10: Channel 7, zoomed carrier

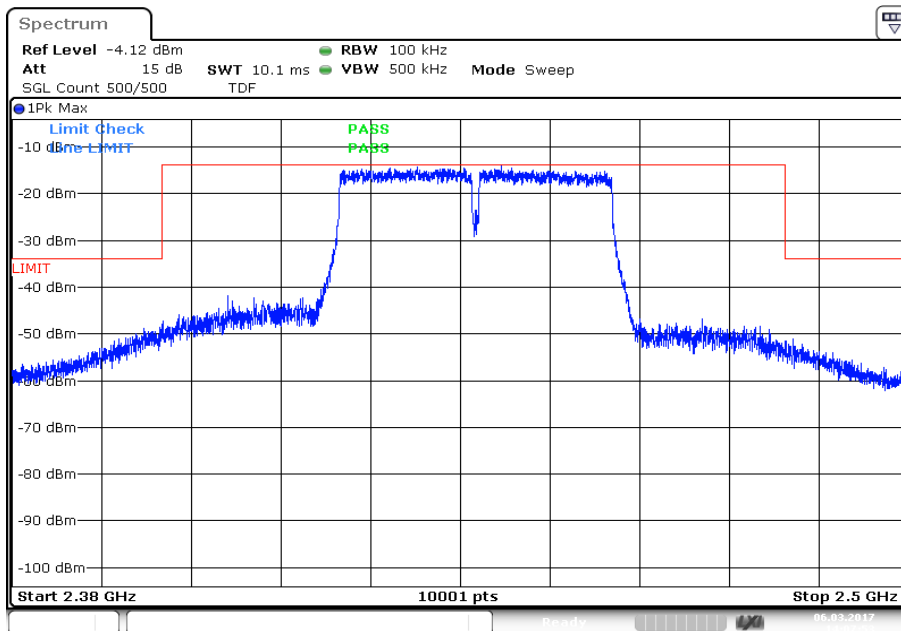

Plot 11: Channel 8, up to 25 GHz

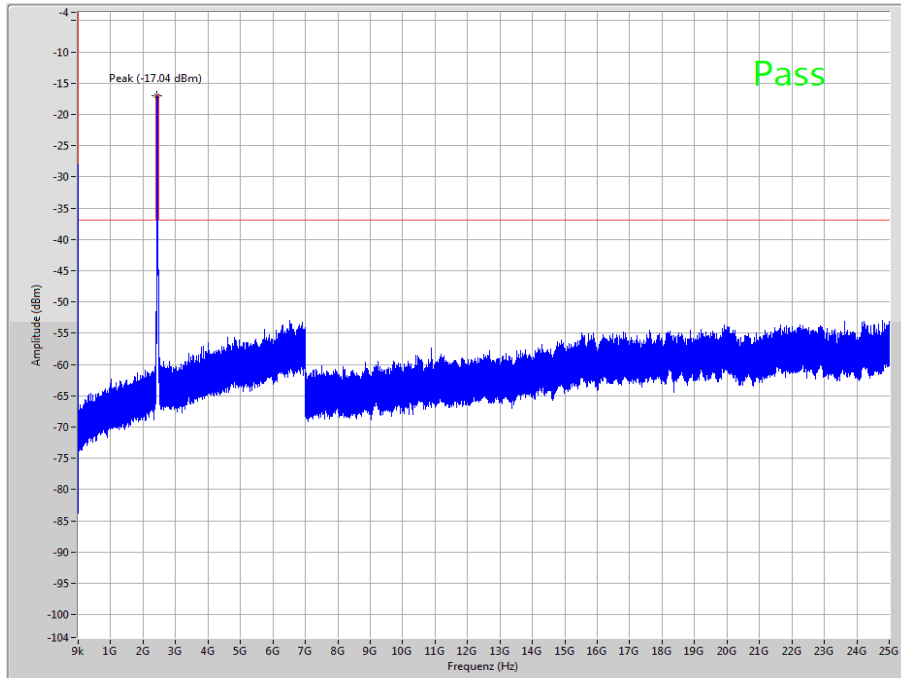

The peak at the beginning of the plot is the LO from the SA.

Plot 12: Channel 8, zoomed carrier

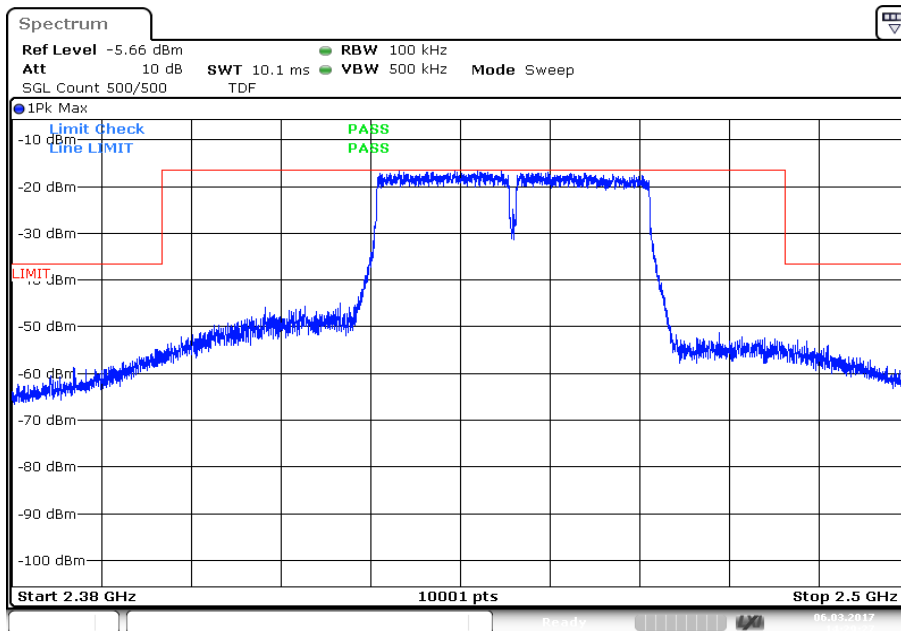

Date: 6.MAR.2017 14:29:27

Plot 13: Channel 9, up to 25 GHz

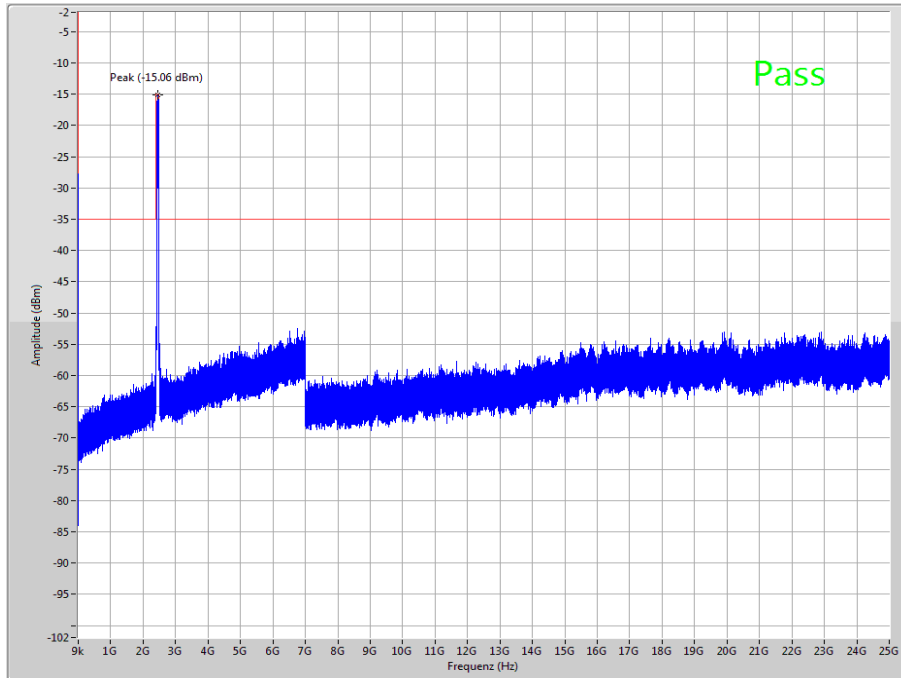

The peak at the beginning of the plot is the LO from the SA.

Plot 14: Channel 9, zoomed carrier

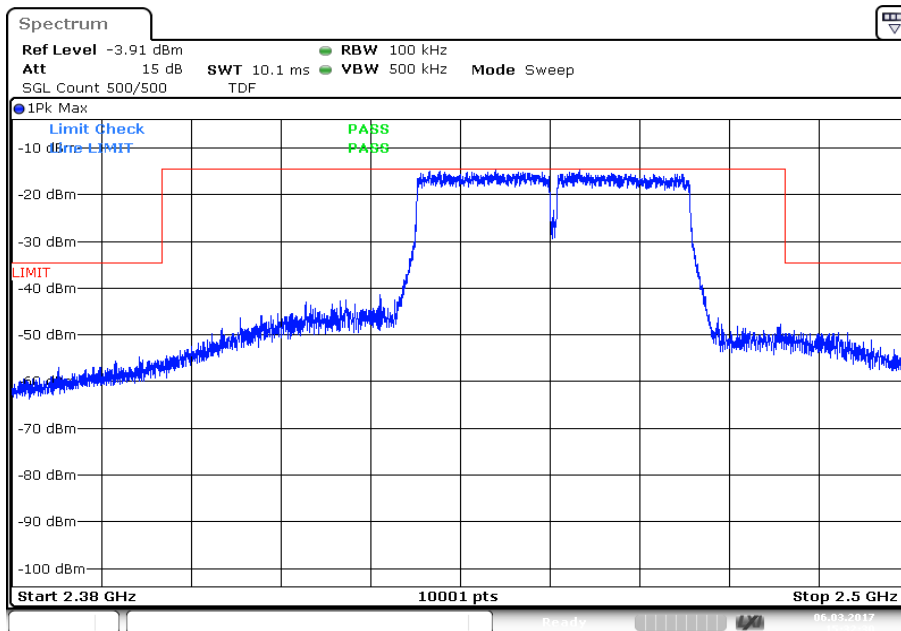

11.11 Spurious emissions radiated below 30 MHz

Description:

Measurement of the radiated spurious emissions in transmit mode below 30 MHz. The EUT is set to channel 6. This measurement is representative for all channels and modes. If peaks are found channel 1 and channel 11 will be measured too. The measurement is performed with the data rate producing the highest output power. The limits are recalculated to a measurement distance of 3 m with 40 dB/decade according CFR Part 2.

Measurement:

Measurement parameter	
Detector:	Peak / Quasi Peak
Sweep time:	Auto
Resolution bandwidth:	F < 150 kHz: 200 Hz F > 150 kHz: 9 kHz
Video bandwidth:	F < 150 kHz: 1 kHz F > 150 kHz: 100 kHz
Span:	9 kHz to 30 MHz
Trace mode:	Max Hold
Measured modulation	<input checked="" type="checkbox"/> DSSS b – mode <input checked="" type="checkbox"/> OFDM g – mode <input type="checkbox"/> OFDM n HT20 – mode <input checked="" type="checkbox"/> OFDM n HT40 – mode
Test setup:	See sub clause 6.2 - A
Measurement uncertainty	See sub clause 8

Limits:

FCC		IC
Frequency (MHz)	Field Strength (dBµV/m)	Measurement distance
0.009 – 0.490	2400/F(kHz)	300
0.490 – 1.705	24000/F(kHz)	30
1.705 – 30.0	30	30

Results:

TX Spurious Emissions Radiated < 30 MHz [dBµV/m]		
F [MHz]	Detector	Level [dBµV/m]
All detected peaks are more than 20 dB below the limit.		

Plots: DSSS

Plot 1: 9 kHz to 30 MHz, low channel

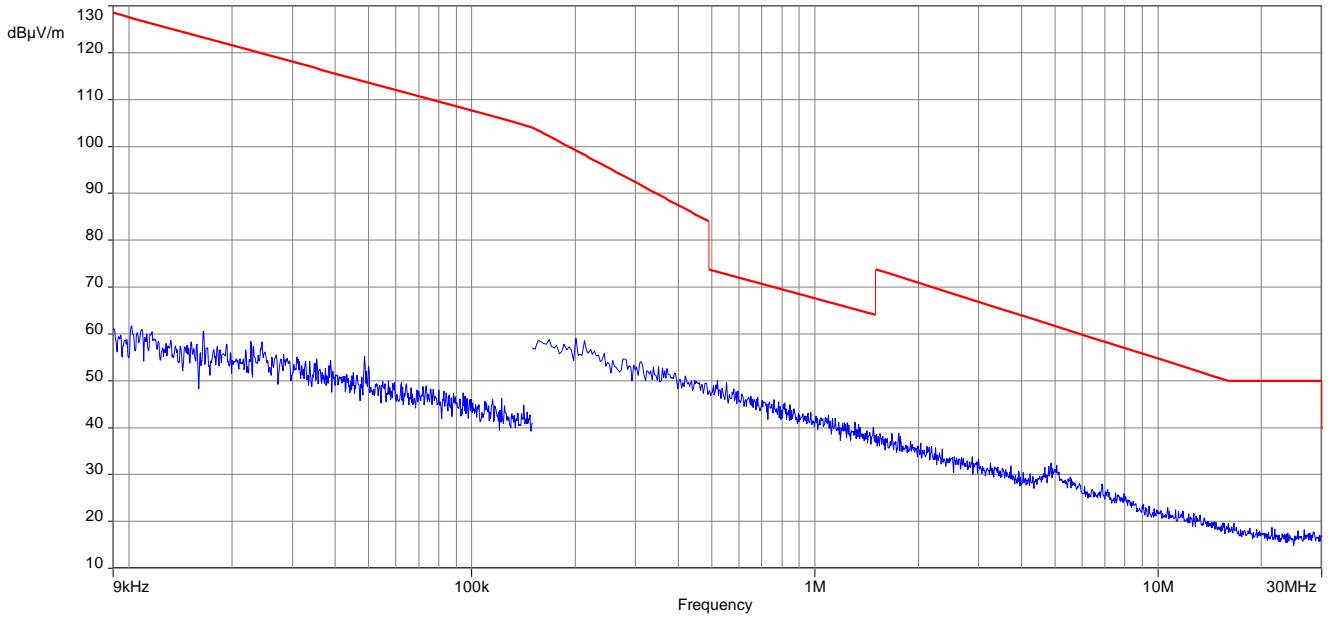

Plot 2: 9 kHz to 30 MHz, mid channel

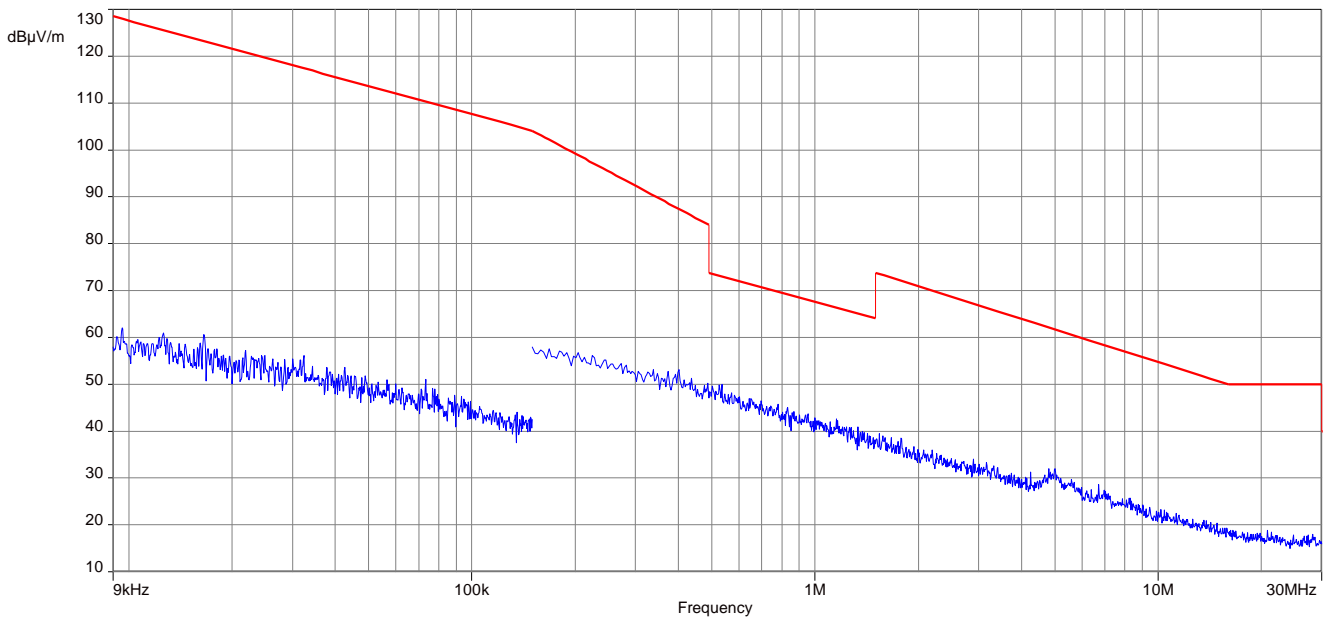

Plot 3: 9 kHz to 30 MHz, high channel

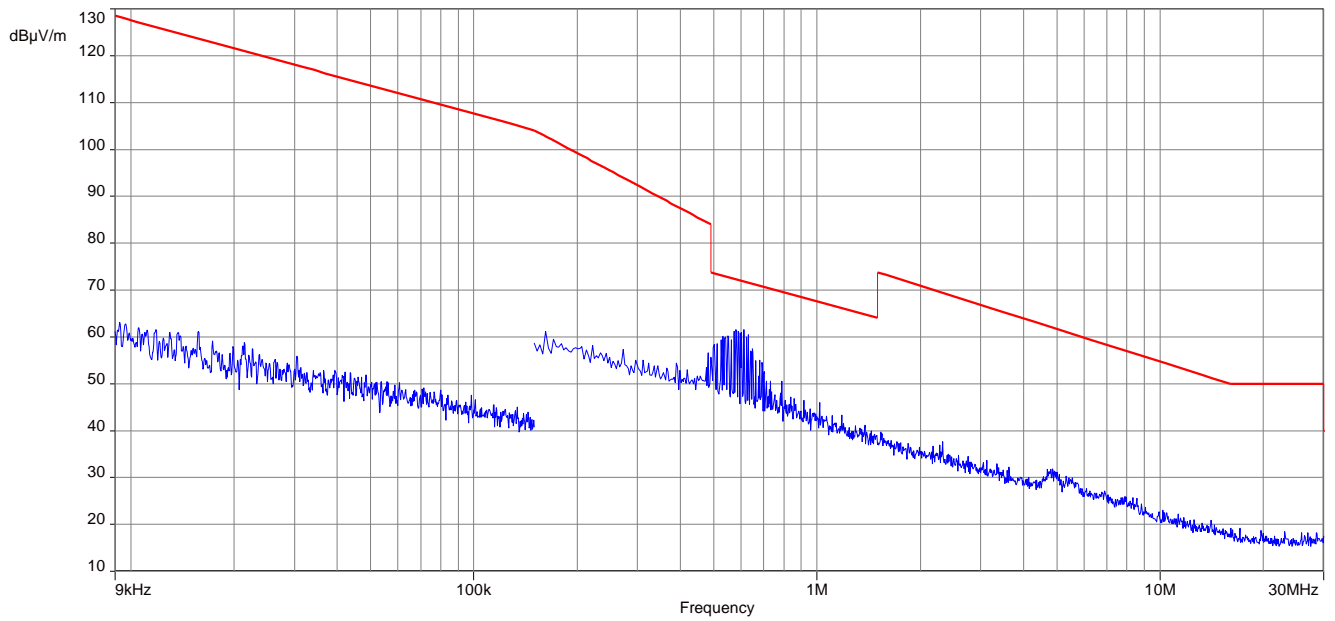

Plots: OFDM (20 MHz bandwidth)

Plot 1: 9 kHz to 30 MHz, low channel

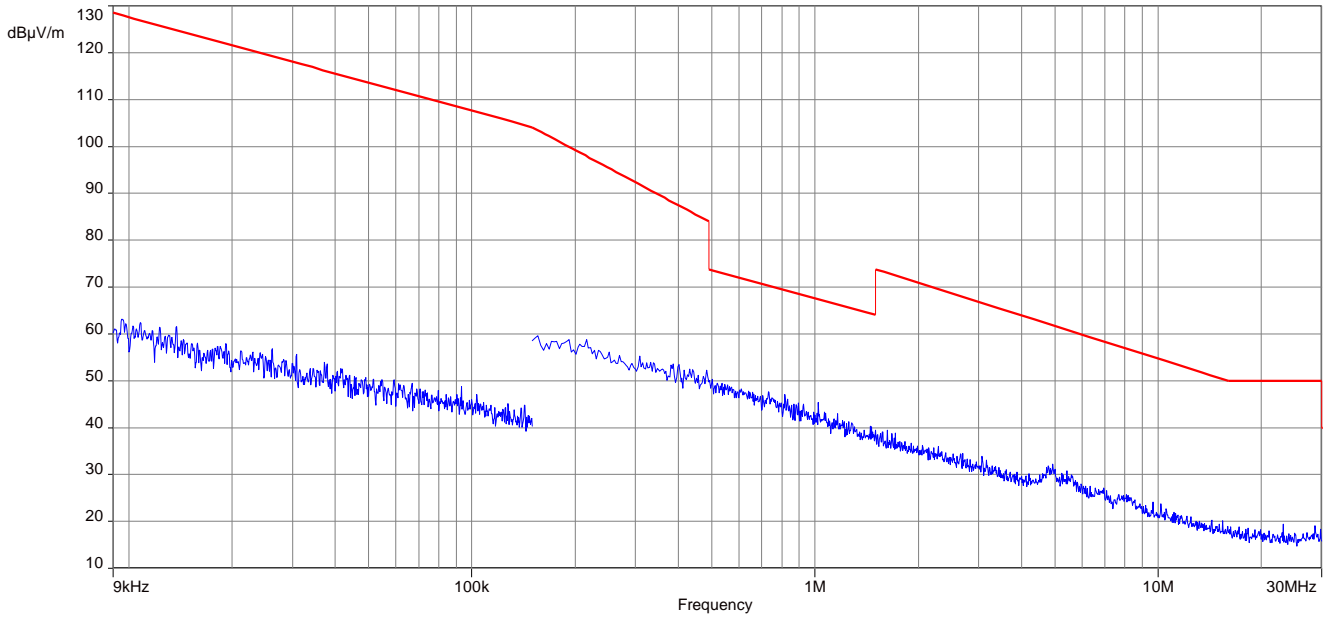

Plot 2: 9 kHz to 30 MHz, mid channel

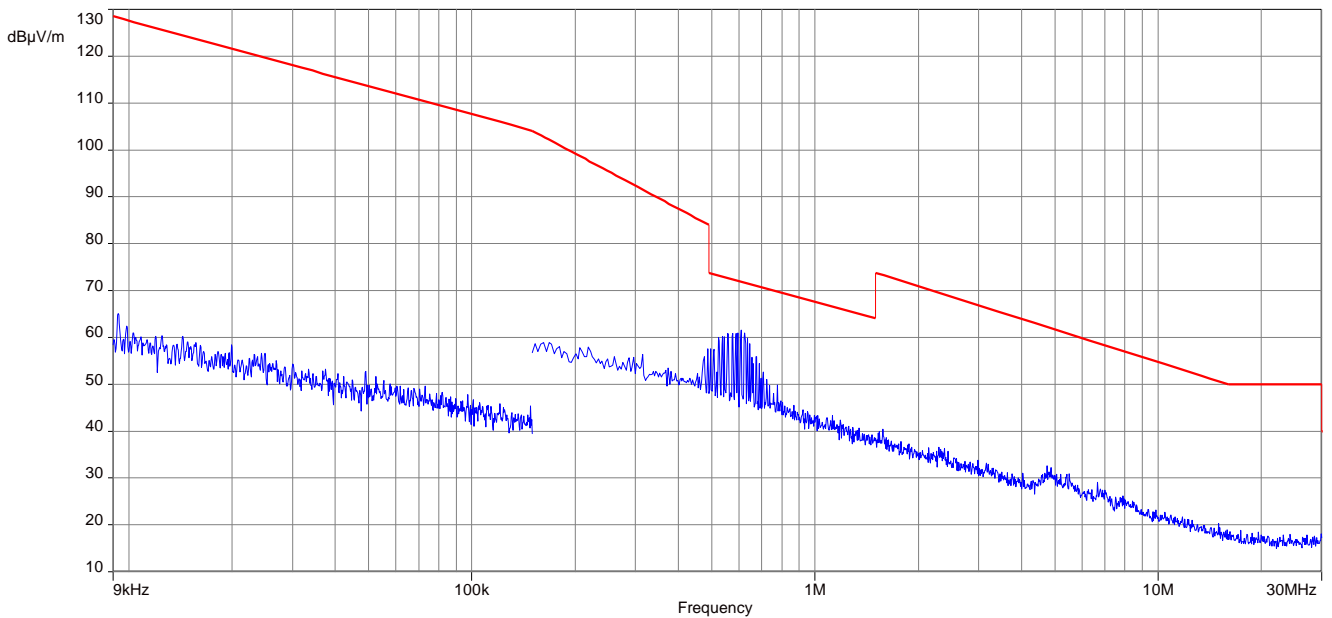

Plot 3: 9 kHz to 30 MHz, high channel

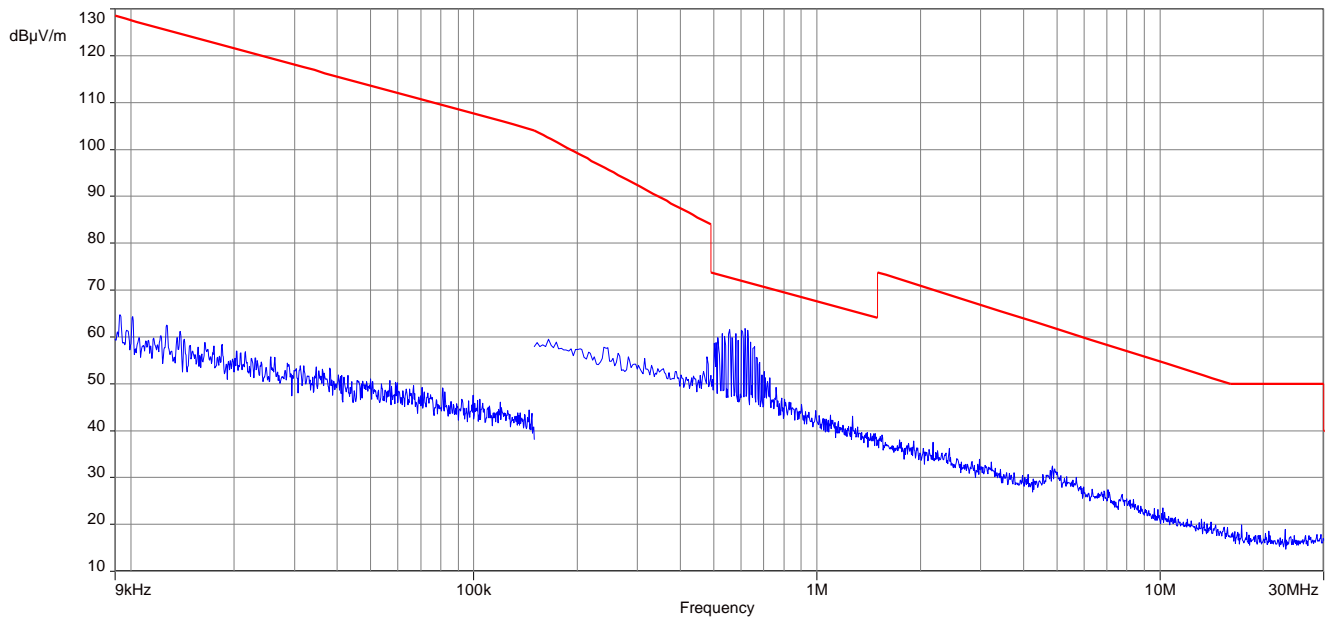

Plots: OFDM (40 MHz bandwidth)

Plot 1: 9 kHz to 30 MHz, low channel

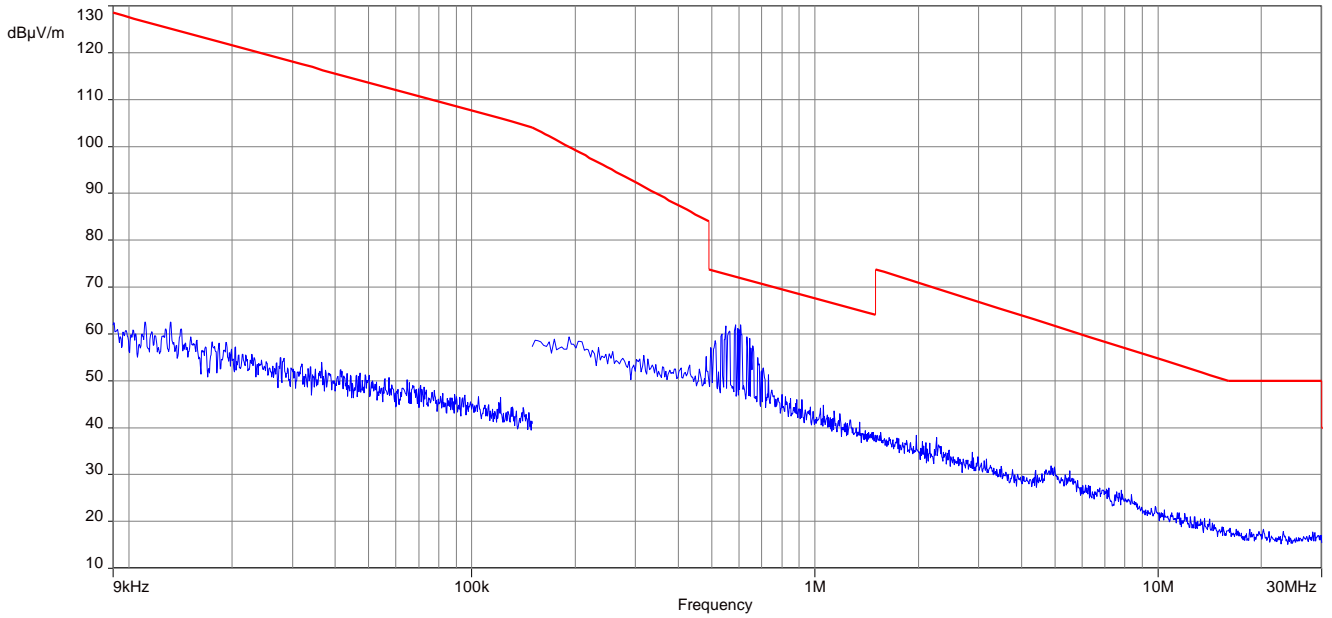

Plot 2: 9 kHz to 30 MHz, mid channel

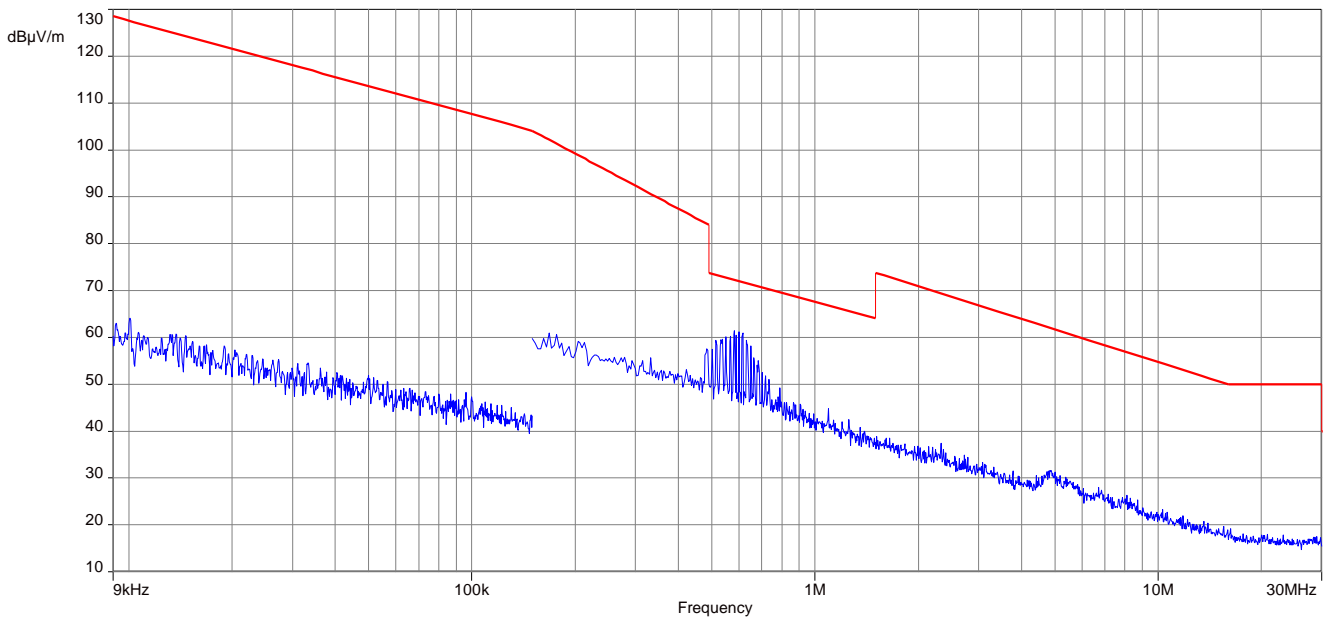

Plot 3: 9 kHz to 30 MHz, high channel

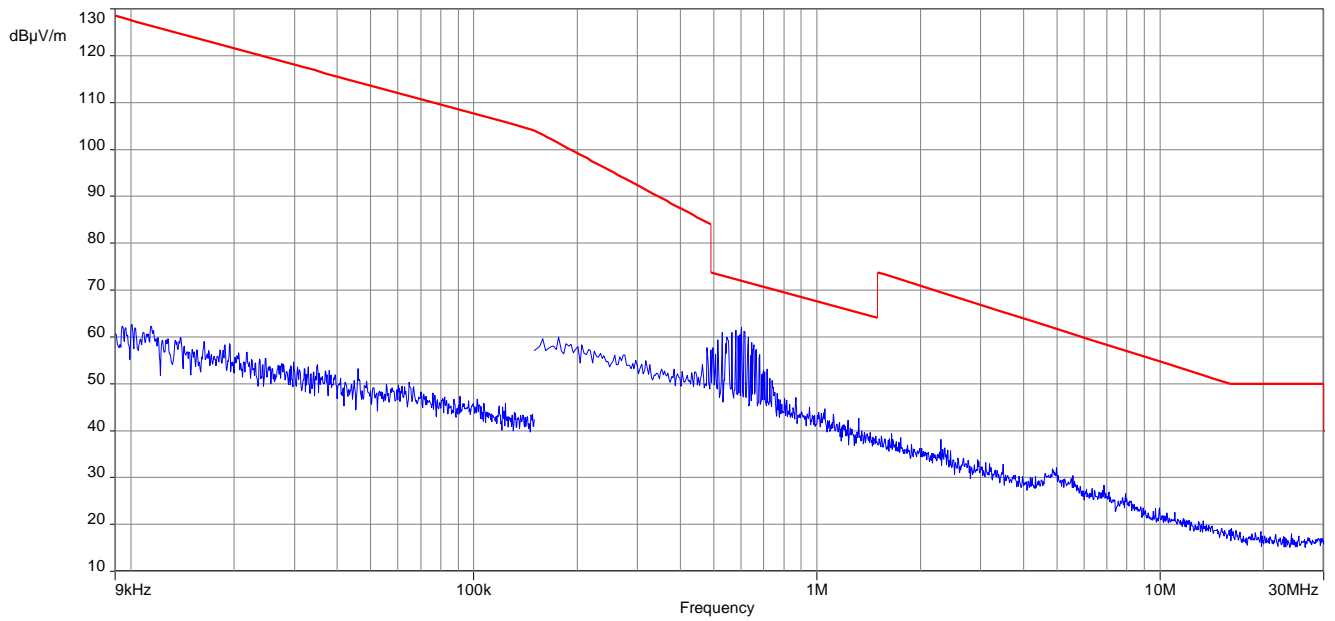

11.12 Spurious emissions radiated 30 MHz to 1 GHz

Description:

Measurement of the radiated spurious emissions and cabinet radiations below 1 GHz.

Measurement:

Measurement parameter	
Detector:	Peak / Quasi Peak
Sweep time:	Auto
Resolution bandwidth:	120 kHz
Video bandwidth:	3 x RBW
Span:	30 MHz to 1 GHz
Trace mode:	Max Hold
Measured modulation	<input checked="" type="checkbox"/> DSSS b – mode <input checked="" type="checkbox"/> OFDM g – mode <input type="checkbox"/> OFDM n HT20 – mode <input checked="" type="checkbox"/> OFDM n HT40 – mode <input checked="" type="checkbox"/> RX / Idle – mode
Test setup:	See sub clause 6.1
Measurement uncertainty	See sub clause 8

The modulation with the highest output power was used to perform the transmitter spurious emissions. If spurious were detected a re-measurement was performed on the detected frequency with each modulation.

Limits:

FCC		IC
In any 100 kHz bandwidth outside the frequency band in which the spread spectrum or digitally modulated intentional radiator is operating, the radio frequency power that is produced by the intentional radiator shall be at least 20 dB below that in the 100 kHz bandwidth within the band that contains the highest level of the desired power, based on either an RF conducted or a radiated measurement. Attenuation below the general limits specified in Section 15.209(a) is not required. In addition, radiated emissions which fall in the restricted bands, as defined in §15.205(a), must also comply with the radiated emission limits specified in §15.209(a) (see §15.205(c)).		
Frequency (MHz)	Field Strength (dBµV/m)	Measurement distance
30 - 88	30.0	10
88 – 216	33.5	10
216 – 960	36.0	10

Plot: DSSS

Plot 1: 30 MHz to 1 GHz, vertical & horizontal polarization, low channel

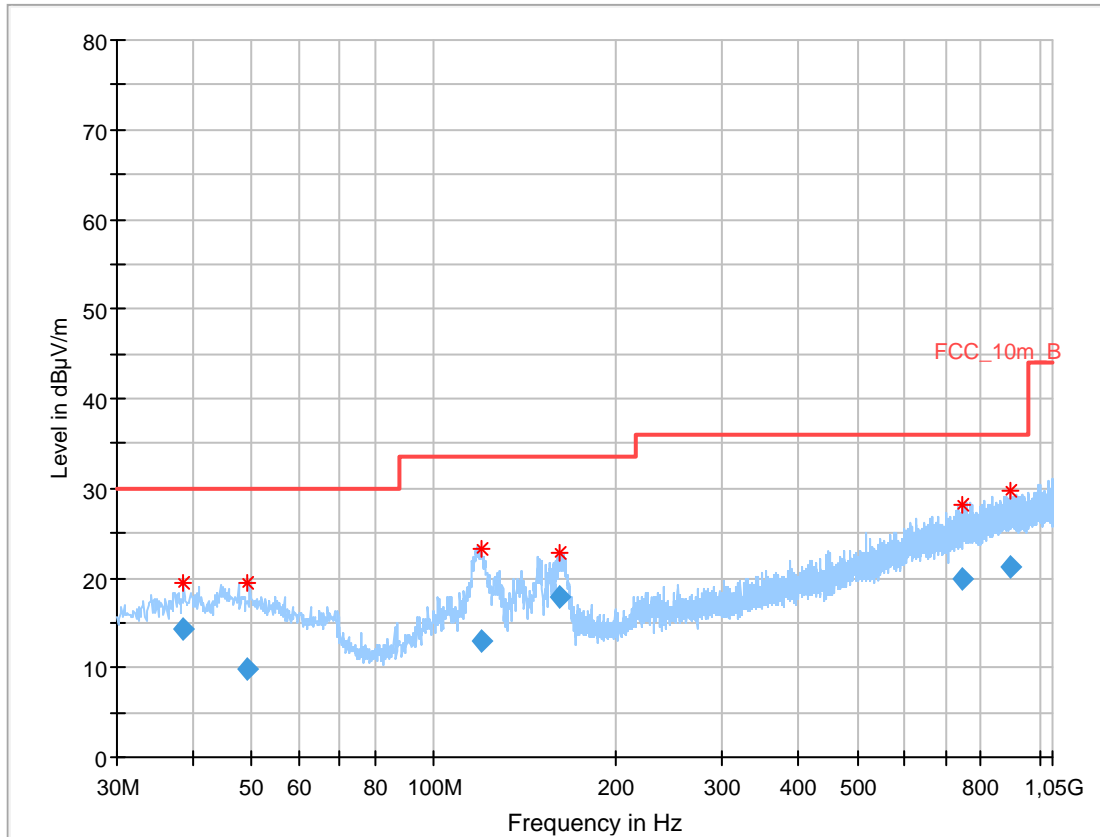

Final results:

Frequency (MHz)	QuasiPeak (dBµV/m)	Limit (dBµV/m)	Margin (dB)	Meas. Time (ms)	Bandwidth (kHz)	Height (cm)	Pol	Azimuth (deg)	Corr. (dB)
38.681400	14.20	30.00	15.80	1000.0	120.000	170.0	V	81.0	13.1
49.229700	9.90	30.00	20.10	1000.0	120.000	100.0	H	261.0	13.7
119.580900	12.86	33.50	20.64	1000.0	120.000	101.0	V	-8.0	10.3
161.513700	17.86	33.50	15.64	1000.0	120.000	98.0	V	80.0	9.8
747.977100	19.89	36.00	16.11	1000.0	120.000	170.0	V	261.0	22.7
891.824700	21.31	36.00	14.69	1000.0	120.000	170.0	V	100.0	24.1

Plot 2: 30 MHz to 1 GHz, vertical & horizontal polarization, mid channel

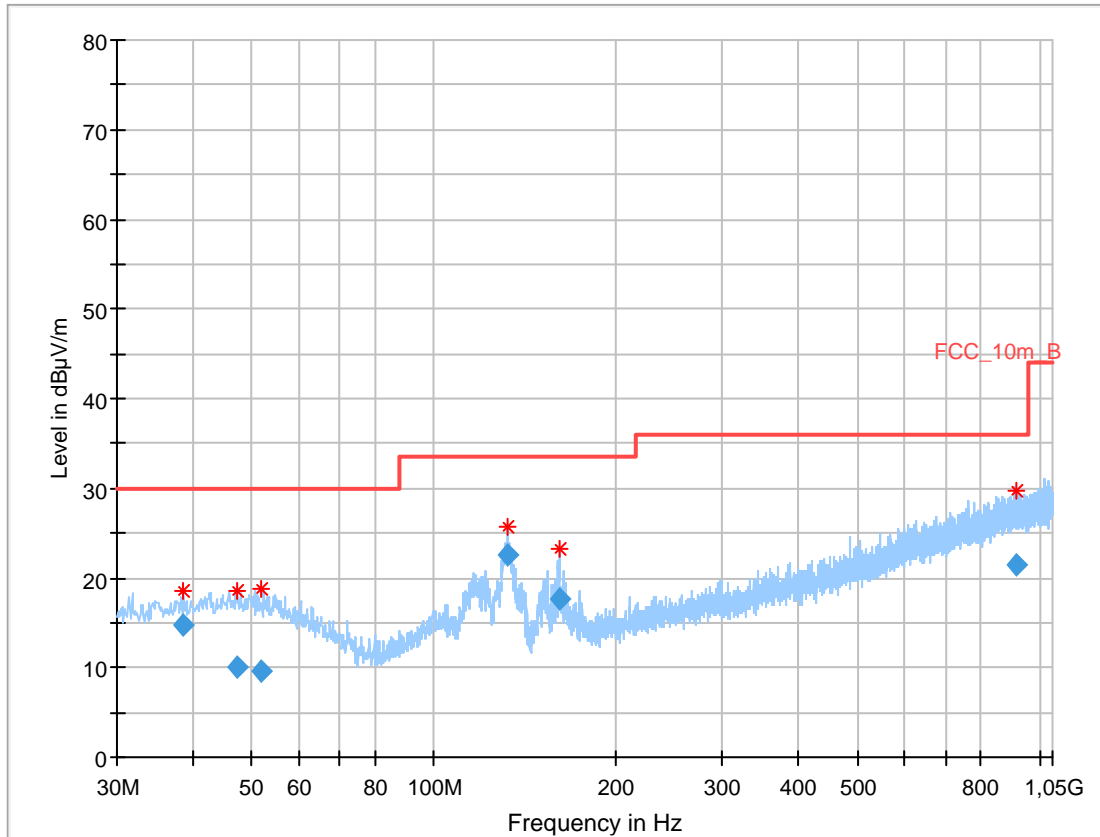

Final results:

Frequency (MHz)	QuasiPeak (dBµV/m)	Limit (dBµV/m)	Margin (dB)	Meas. Time (ms)	Bandwidth (kHz)	Height (cm)	Pol	Azimuth (deg)	Corr. (dB)
38.694900	14.78	30.00	15.22	1000.0	120.000	170.0	V	172.0	13.1
47.331450	10.16	30.00	19.84	1000.0	120.000	101.0	V	170.0	13.7
52.074150	9.66	30.00	20.34	1000.0	120.000	170.0	H	10.0	13.5
131.962650	22.58	33.50	10.92	1000.0	120.000	101.0	V	100.0	9.4
161.339100	17.74	33.50	15.76	1000.0	120.000	100.0	V	81.0	9.8
914.689050	21.36	36.00	14.64	1000.0	120.000	170.0	V	80.0	24.2

Plot 3: 30 MHz to 1 GHz, vertical & horizontal polarization, high channel

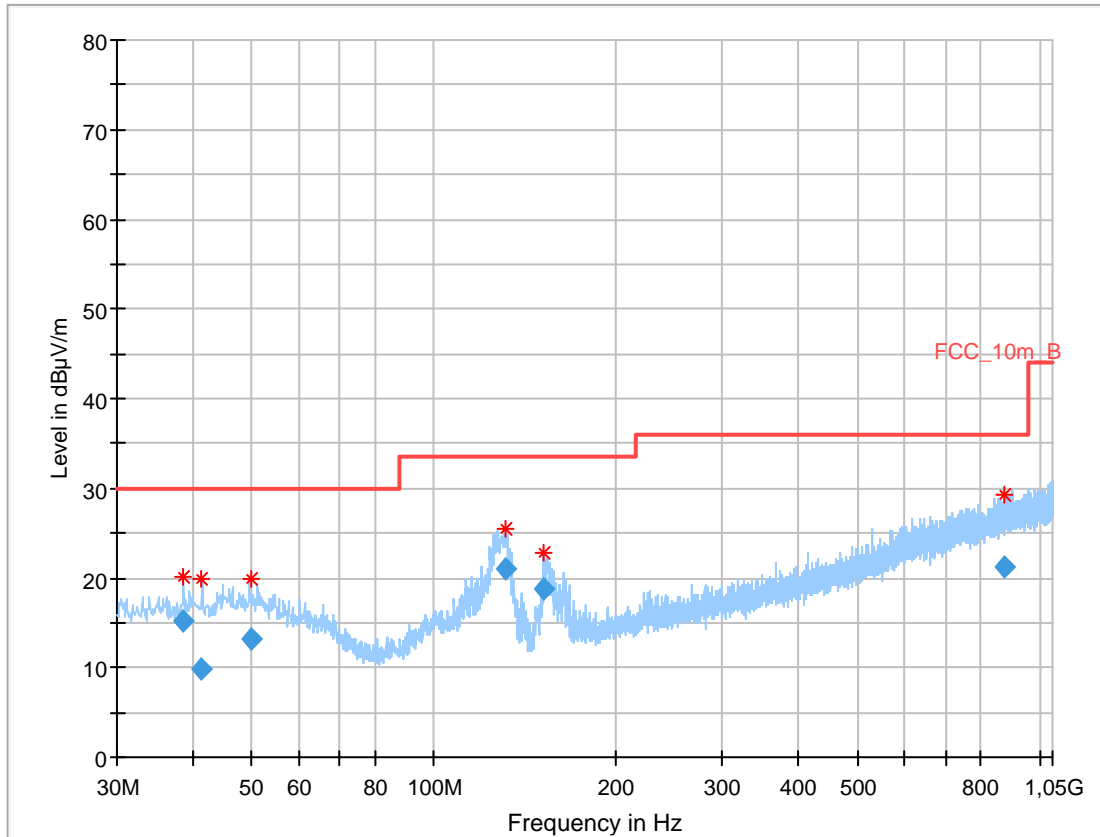

Final results:

Frequency (MHz)	QuasiPeak (dBµV/m)	Limit (dBµV/m)	Margin (dB)	Meas. Time (ms)	Bandwidth (kHz)	Height (cm)	Pol	Azimuth (deg)	Corr. (dB)
38.696850	15.30	30.00	14.70	1000.0	120.000	100.0	V	-8.0	13.1
41.380800	9.81	30.00	20.19	1000.0	120.000	101.0	H	-8.0	13.3
49.983450	13.11	30.00	16.89	1000.0	120.000	101.0	V	172.0	13.7
131.297400	21.10	33.50	12.40	1000.0	120.000	98.0	V	10.0	9.5
152.189850	18.69	33.50	14.81	1000.0	120.000	98.0	V	100.0	9.4
874.274100	21.31	36.00	14.69	1000.0	120.000	170.0	H	261.0	23.9

Plot: OFDM (20 MHz bandwidth)

Plot 1: 30 MHz to 1 GHz, vertical & horizontal polarization, low channel

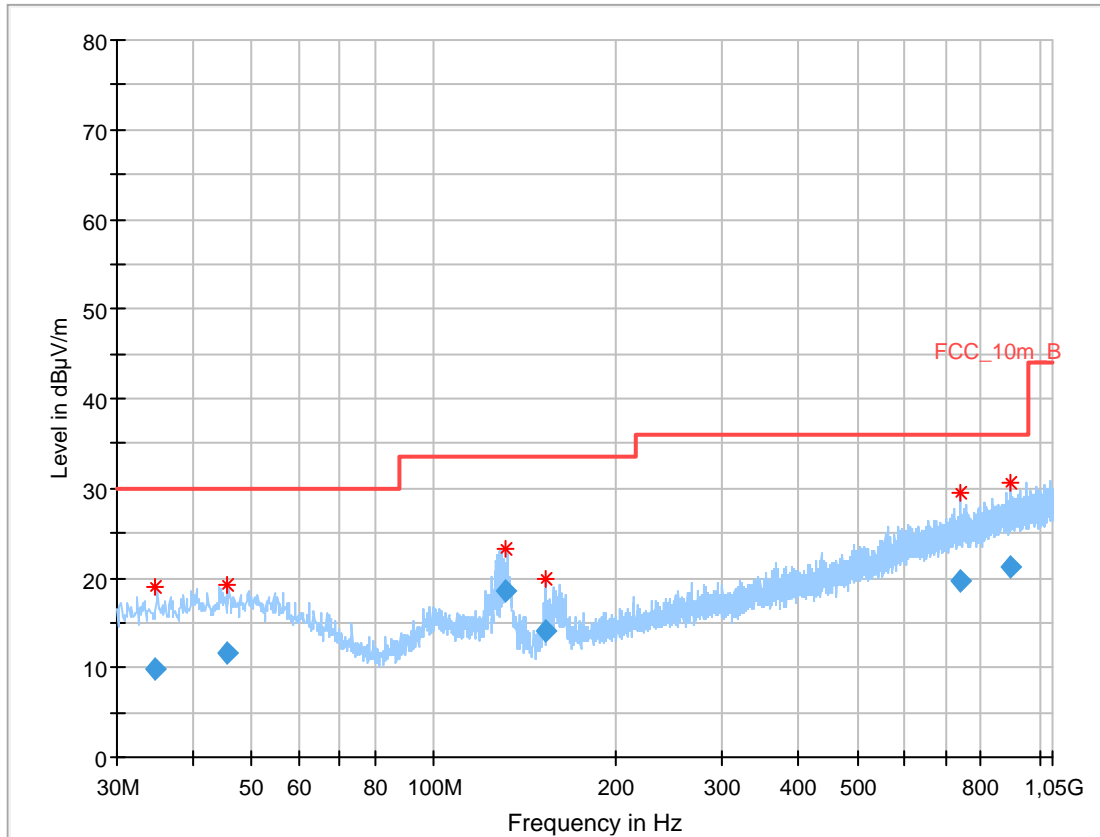

Final results:

Frequency (MHz)	QuasiPeak (dBµV/m)	Limit (dBµV/m)	Margin (dB)	Meas. Time (ms)	Bandwidth (kHz)	Height (cm)	Pol	Azimuth (deg)	Corr. (dB)
34.730850	9.81	30.00	20.19	1000.0	120.000	101.0	V	260.0	12.6
45.513900	11.51	30.00	18.49	1000.0	120.000	101.0	V	280.0	13.6
131.855850	18.53	33.50	14.97	1000.0	120.000	98.0	V	-10.0	9.4
153.175350	14.12	33.50	19.38	1000.0	120.000	98.0	V	100.0	9.4
738.185850	19.58	36.00	16.42	1000.0	120.000	170.0	V	260.0	22.4
892.836750	21.25	36.00	14.75	1000.0	120.000	101.0	V	100.0	24.1

Plot 2: 30 MHz to 1 GHz, vertical & horizontal polarization, mid channel

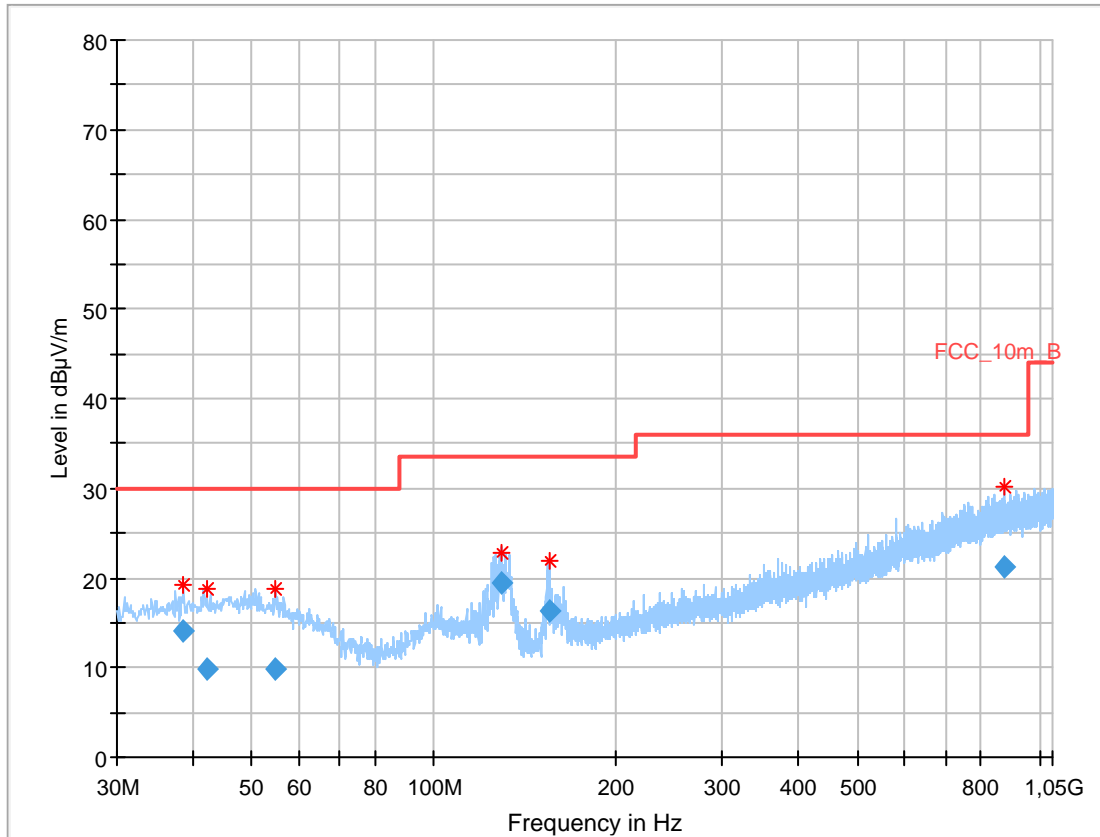

Final results:

Frequency (MHz)	QuasiPeak (dBµV/m)	Limit (dBµV/m)	Margin (dB)	Meas. Time (ms)	Bandwidth (kHz)	Height (cm)	Pol	Azimuth (deg)	Corr. (dB)
38.674050	14.08	30.00	15.92	1000.0	120.000	101.0	V	81.0	13.1
42.177750	9.75	30.00	20.25	1000.0	120.000	101.0	V	-10.0	13.4
54.575850	9.78	30.00	20.22	1000.0	120.000	170.0	V	100.0	13.1
129.155250	19.42	33.50	14.08	1000.0	120.000	170.0	V	100.0	9.6
155.467800	16.21	33.50	17.29	1000.0	120.000	102.0	V	100.0	9.5
877.165050	21.21	36.00	14.79	1000.0	120.000	170.0	V	261.0	23.9

Plot 3: 30 MHz to 1 GHz, vertical & horizontal polarization, high channel

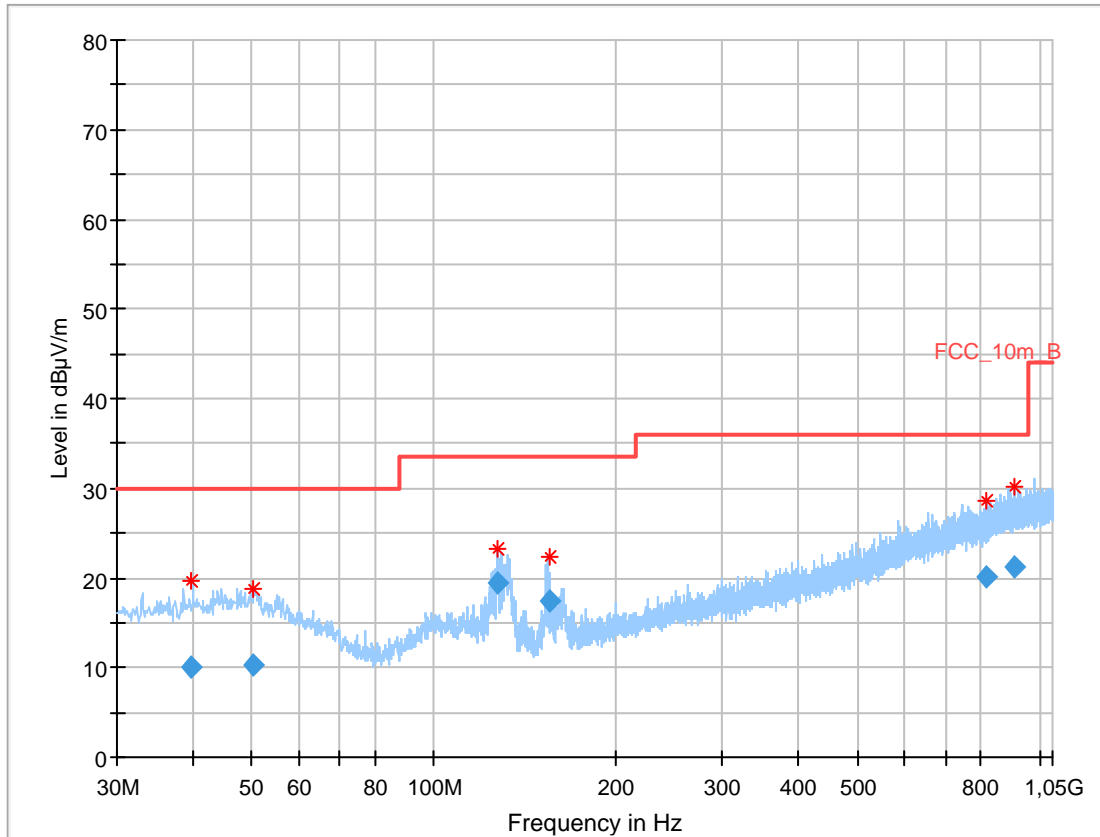

Final results:

Frequency (MHz)	QuasiPeak (dBµV/m)	Limit (dBµV/m)	Margin (dB)	Meas. Time (ms)	Bandwidth (kHz)	Height (cm)	Pol	Azimuth (deg)	Corr. (dB)
39.695400	10.06	30.00	19.94	1000.0	120.000	101.0	V	-10.0	13.2
50.315400	10.30	30.00	19.70	1000.0	120.000	170.0	H	100.0	13.7
127.468500	19.42	33.50	14.08	1000.0	120.000	170.0	V	100.0	9.7
155.208750	17.38	33.50	16.12	1000.0	120.000	98.0	V	82.0	9.5
814.206750	20.20	36.00	15.80	1000.0	120.000	170.0	V	10.0	23.0
906.401550	21.25	36.00	14.75	1000.0	120.000	101.0	V	261.0	24.2

Plot: OFDM (40 MHz bandwidth)

Plot 1: 30 MHz to 1 GHz, vertical & horizontal polarization, low channel

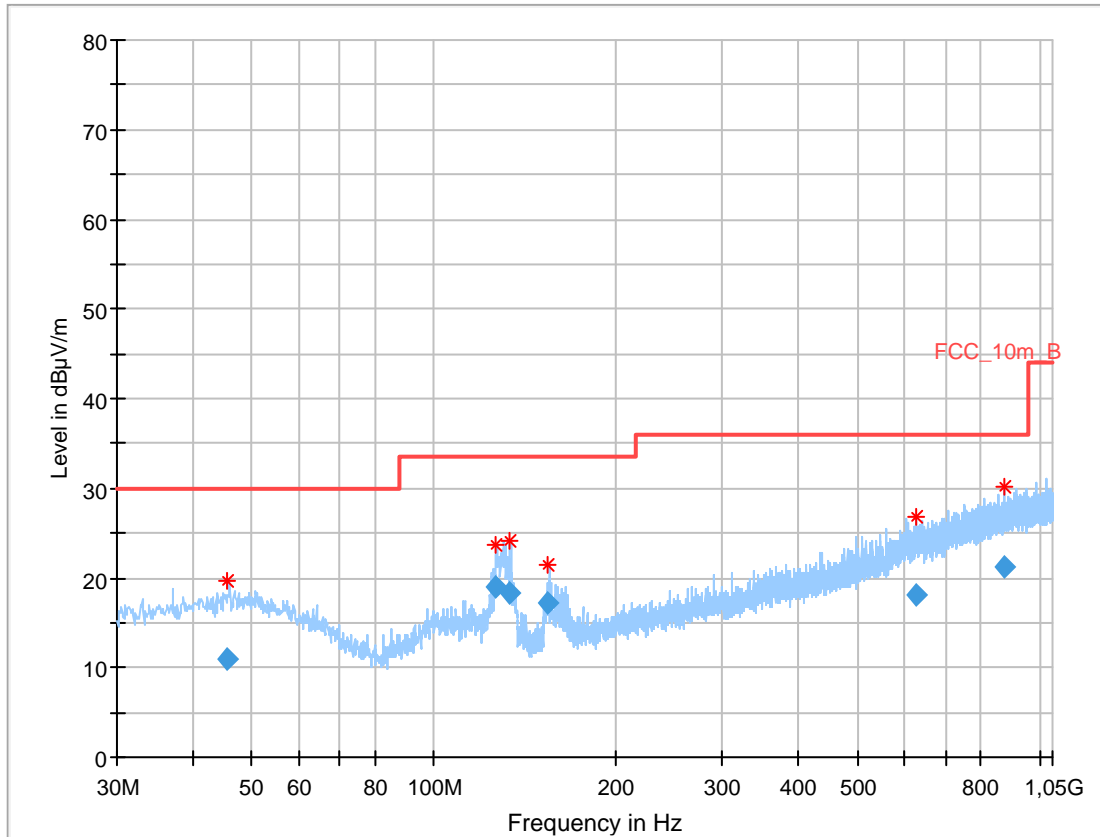

Final results:

Frequency (MHz)	QuasiPeak (dBµV/m)	Limit (dBµV/m)	Margin (dB)	Meas. Time (ms)	Bandwidth (kHz)	Height (cm)	Pol	Azimuth (deg)	Corr. (dB)
45.723300	10.98	30.00	19.02	1000.0	120.000	100.0	V	190.0	13.6
126.820650	19.09	33.50	14.41	1000.0	120.000	101.0	V	100.0	9.8
133.343550	18.34	33.50	15.16	1000.0	120.000	170.0	V	261.0	9.3
154.614300	17.30	33.50	16.20	1000.0	120.000	98.0	V	100.0	9.5
623.666550	18.07	36.00	17.93	1000.0	120.000	170.0	H	80.0	20.9
873.129900	21.28	36.00	14.72	1000.0	120.000	98.0	H	-8.0	23.8

Plot 2: 30 MHz to 1 GHz, vertical & horizontal polarization, mid channel

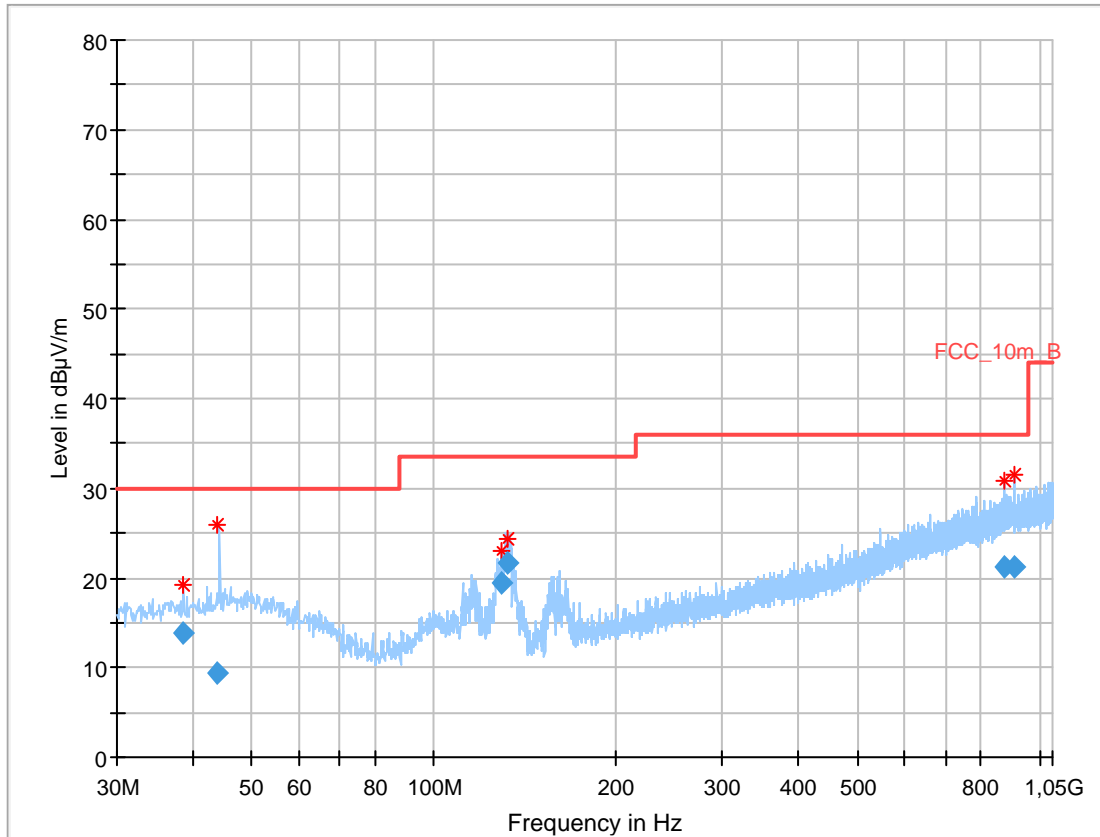

Final results:

Frequency (MHz)	QuasiPeak (dBµV/m)	Limit (dBµV/m)	Margin (dB)	Meas. Time (ms)	Bandwidth (kHz)	Height (cm)	Pol	Azimuth (deg)	Corr. (dB)
38.672550	13.91	30.00	16.09	1000.0	120.000	101.0	V	100.0	13.1
43.837200	9.48	30.00	20.52	1000.0	120.000	101.0	H	190.0	13.5
129.675900	19.48	33.50	14.02	1000.0	120.000	98.0	V	280.0	9.6
132.298350	21.75	33.50	11.75	1000.0	120.000	101.0	V	10.0	9.4
871.758600	21.25	36.00	14.75	1000.0	120.000	98.0	H	190.0	23.8
906.094350	21.24	36.00	14.76	1000.0	120.000	170.0	H	261.0	24.2

Plot 3: 30 MHz to 1 GHz, vertical & horizontal polarization, high channel

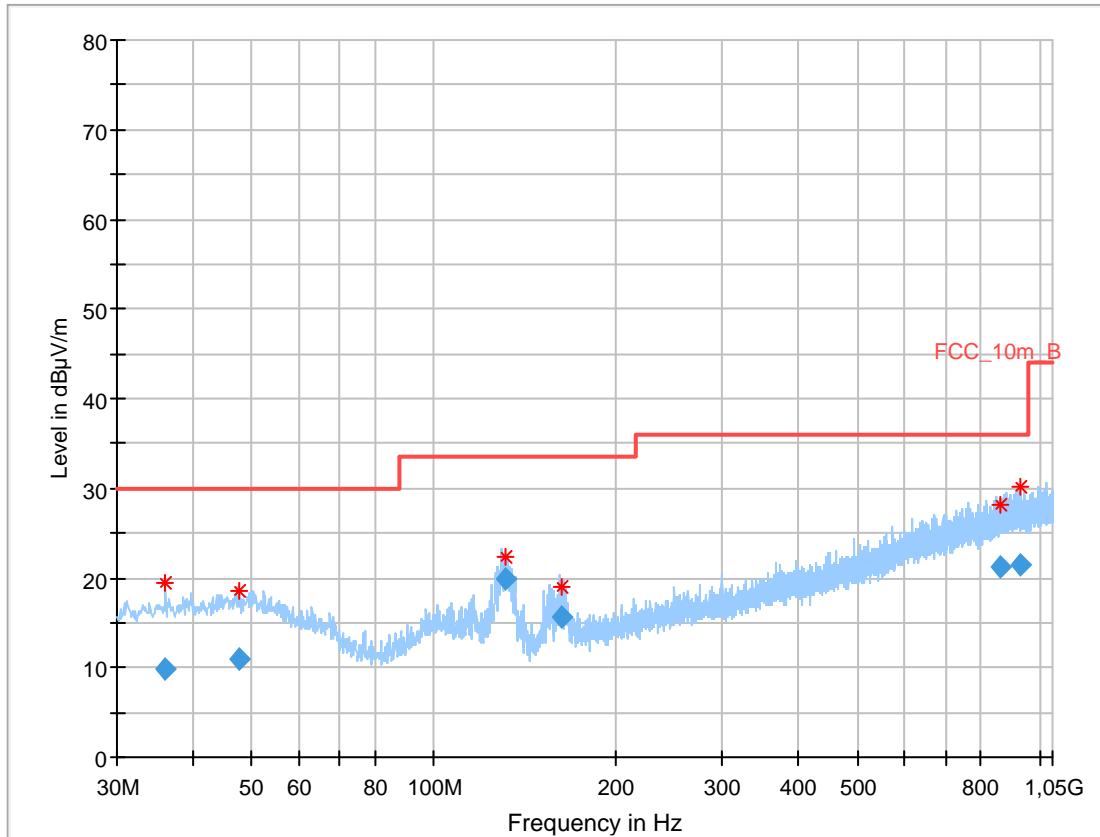

Final results:

Frequency (MHz)	QuasiPeak (dBµV/m)	Limit (dBµV/m)	Margin (dB)	Meas. Time (ms)	Bandwidth (kHz)	Height (cm)	Pol	Azimuth (deg)	Corr. (dB)
36.017550	9.75	30.00	20.25	1000.0	120.000	101.0	V	-10.0	12.8
47.911200	10.84	30.00	19.16	1000.0	120.000	101.0	V	100.0	13.7
131.170800	19.93	33.50	13.57	1000.0	120.000	104.0	V	190.0	9.5
162.316050	15.64	33.50	17.86	1000.0	120.000	170.0	V	100.0	9.8
864.267750	21.16	36.00	14.84	1000.0	120.000	101.0	H	100.0	23.7
926.546700	21.36	36.00	14.64	1000.0	120.000	170.0	H	280.0	24.3

Plot: RX / Idle mode

Plot 1: 30 MHz to 1 GHz, vertical & horizontal polarization

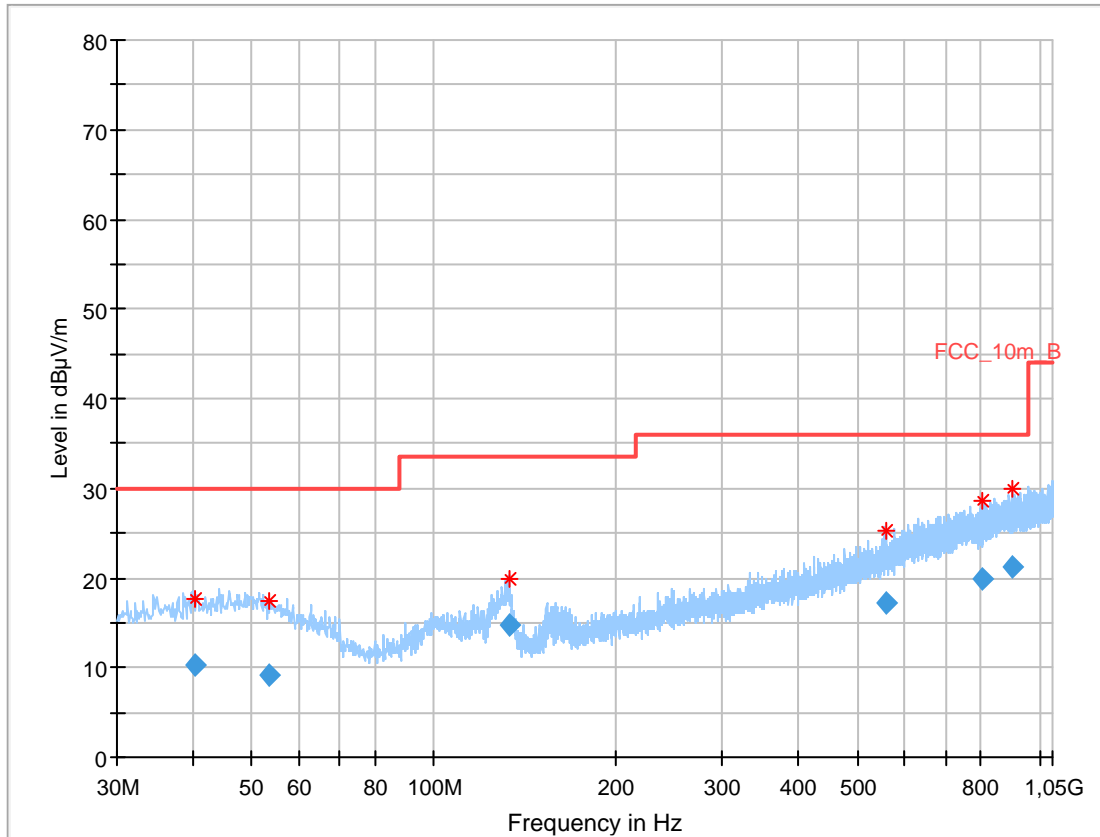

Final results:

Frequency (MHz)	QuasiPeak (dBµV/m)	Limit (dBµV/m)	Margin (dB)	Meas. Time (ms)	Bandwidth (kHz)	Height (cm)	Pol	Azimuth (deg)	Corr. (dB)
40.448250	10.25	30.00	19.75	1000.0	120.000	170.0	V	10.0	13.3
53.708700	9.15	30.00	20.85	1000.0	120.000	101.0	H	171.0	13.3
132.945600	14.82	33.50	18.68	1000.0	120.000	101.0	V	80.0	9.3
558.376650	17.21	36.00	18.79	1000.0	120.000	170.0	V	261.0	19.6
806.869200	19.97	36.00	16.03	1000.0	120.000	98.0	V	280.0	22.9
900.690900	21.28	36.00	14.72	1000.0	120.000	170.0	V	190.0	24.2

11.13 Spurious emissions radiated above 1 GHz

Description:

Measurement of the radiated spurious emissions above 1 GHz in transmit mode and receiver / idle mode.

Measurement:

Measurement parameter	
Detector:	Peak / RMS
Sweep time:	Auto
Resolution bandwidth:	1 MHz
Video bandwidth:	3 x RBW
Span:	1 GHz to 26 GHz
Trace mode:	Max Hold
Measured modulation	<input checked="" type="checkbox"/> DSSS b – mode <input checked="" type="checkbox"/> OFDM g – mode <input type="checkbox"/> OFDM n HT20 – mode <input checked="" type="checkbox"/> OFDM n HT40 – mode <input checked="" type="checkbox"/> RX / Idle – mode
Test setup:	See sub clause 6.2 A (1 GHz - 18 GHz) See sub clause 6.3 A (18 GHz - 26 GHz)
Measurement uncertainty	See sub clause 8

Limits:

FCC		IC
In any 100 kHz bandwidth outside the frequency band in which the spread spectrum or digitally modulated intentional radiator is operating, the radio frequency power that is produced by the intentional radiator shall be at least 30 dB below that in the 100 kHz bandwidth within the band that contains the highest level of the desired power, based on either an RF conducted or a radiated measurement. Attenuation below the general limits specified in Section 15.209(a) is not required. In addition, radiated emissions which fall in the restricted bands, as defined in §15.205(a), must also comply with the radiated emission limits specified in §15.209(a) (see §15.205(c)).		
Frequency (MHz)	Field Strength (dBµV/m)	Measurement distance
Above 960	54.0	3

Results: DSSS

TX Spurious Emissions Radiated [dBµV/m]								
2412 MHz			2437 MHz			2462 MHz		
F [MHz]	Detector	Level [dBµV/m]	F [MHz]	Detector	Level [dBµV/m]	F [MHz]	Detector	Level [dBµV/m]
4824	Peak	55.3	4874	Peak	52.6	4924	Peak	53.2
	AVG	52.8		AVG	47.8		AVG	49.2
-/-	Peak	-/-	-/-	Peak	-/-	-/-	Peak	-/-
	AVG	-/-		AVG	-/-		AVG	-/-

Results: OFDM (20 MHz bandwidth)

TX Spurious Emissions Radiated [dBµV/m]								
2412 MHz			2437 MHz			2462 MHz		
F [MHz]	Detector	Level [dBµV/m]	F [MHz]	Detector	Level [dBµV/m]	F [MHz]	Detector	Level [dBµV/m]
4824	Peak	60.4	4874	Peak	57.7	4922	Peak	55.5
	AVG	49.8		AVG	48.7		AVG	44.9
7240	Peak	54.5	7318	Peak	60.5	7382	Peak	53.6
	AVG	42.6		AVG	46.7		AVG	43.5
-/-	Peak	-/-	12176	Peak	56.8	-/-	Peak	-/-
	AVG	-/-		AVG	44.2		AVG	-/-

Results: OFDM (40 MHz bandwidth)

TX Spurious Emissions Radiated [dBµV/m]								
2422 MHz			2437 MHz			2462 MHz		
F [MHz]	Detector	Level [dBµV/m]	F [MHz]	Detector	Level [dBµV/m]	F [MHz]	Detector	Level [dBµV/m]
All detected emissions are more than 20 dB below the limit.			All detected emissions are more than 20 dB below the limit.			All detected emissions are more than 20 dB below the limit.		
-/-	Peak	-/-	-/-	Peak	-/-	-/-	Peak	-/-
	AVG	-/-		AVG	-/-		AVG	-/-
-/-	Peak	-/-	-/-	Peak	-/-	-/-	Peak	-/-
	AVG	-/-		AVG	-/-		AVG	-/-

Results: RX / idle – mode

TX Spurious Emissions Radiated [dBµV/m]		
F [MHz]	Detector	Level [dBµV/m]
All detected emissions are more than 20 dB below the limit.		
-/-	Peak	-/-
	AVG	-/-
-/-	Peak	-/-
	AVG	-/-

Plots: DSSS

Plot 1: Lowest channel, 1 GHz to 18 GHz, vertical & horizontal polarization

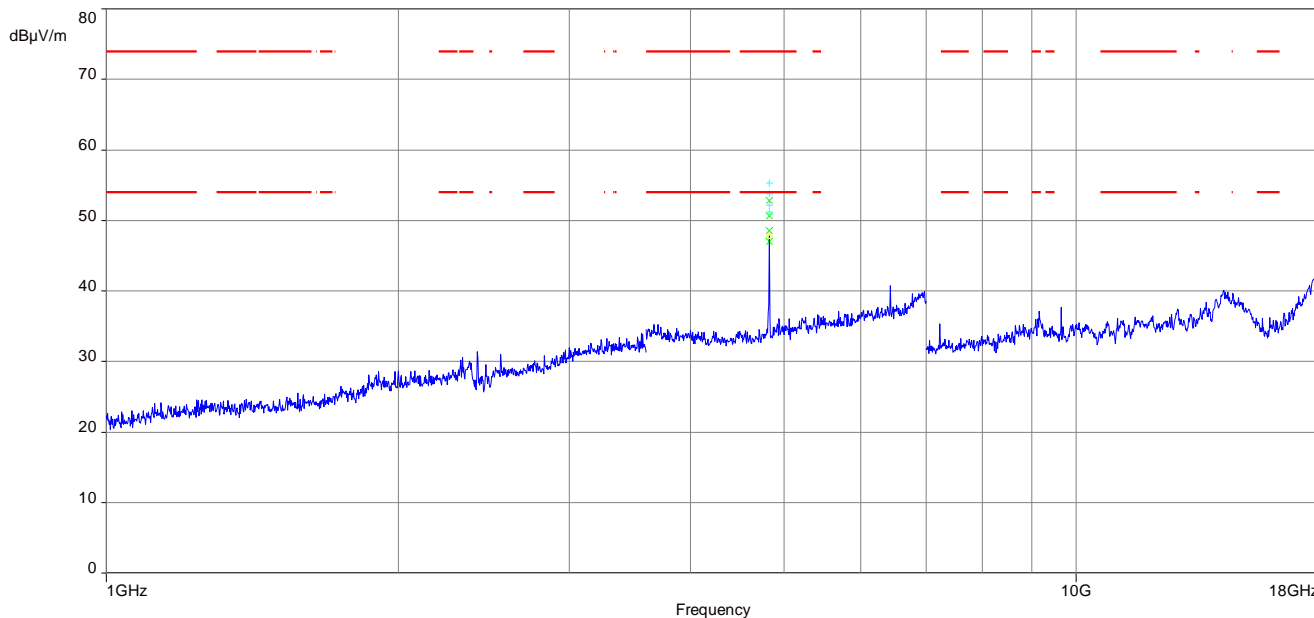

The carrier signal is notched with a 2.4 GHz band rejection filter.

Plot 2: Lowest channel, 18 GHz to 26 GHz, vertical & horizontal polarization

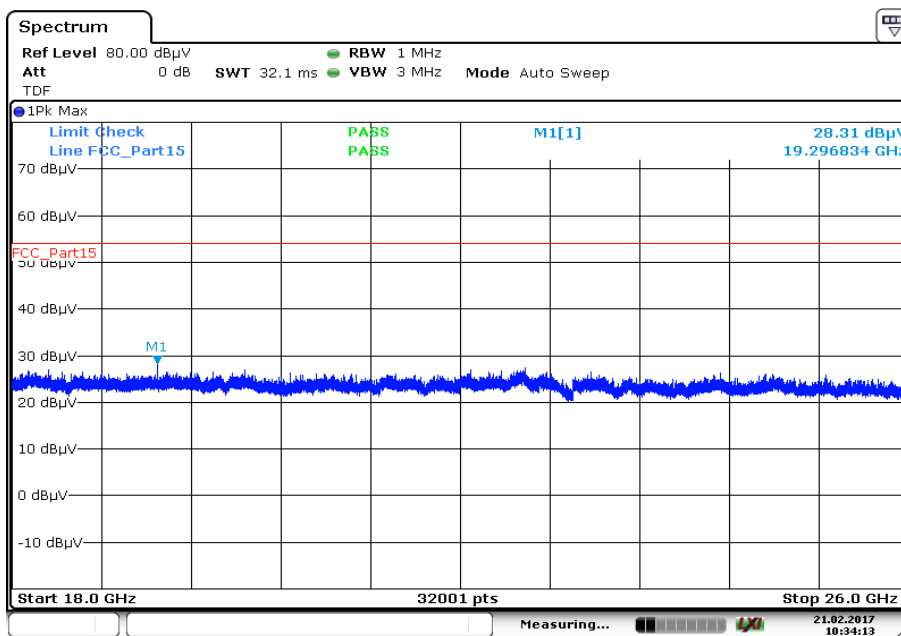

Date: 21.FEB.2017 10:34:14

Plot 3: Middle channel, 1 GHz to 18 GHz, vertical & horizontal polarization

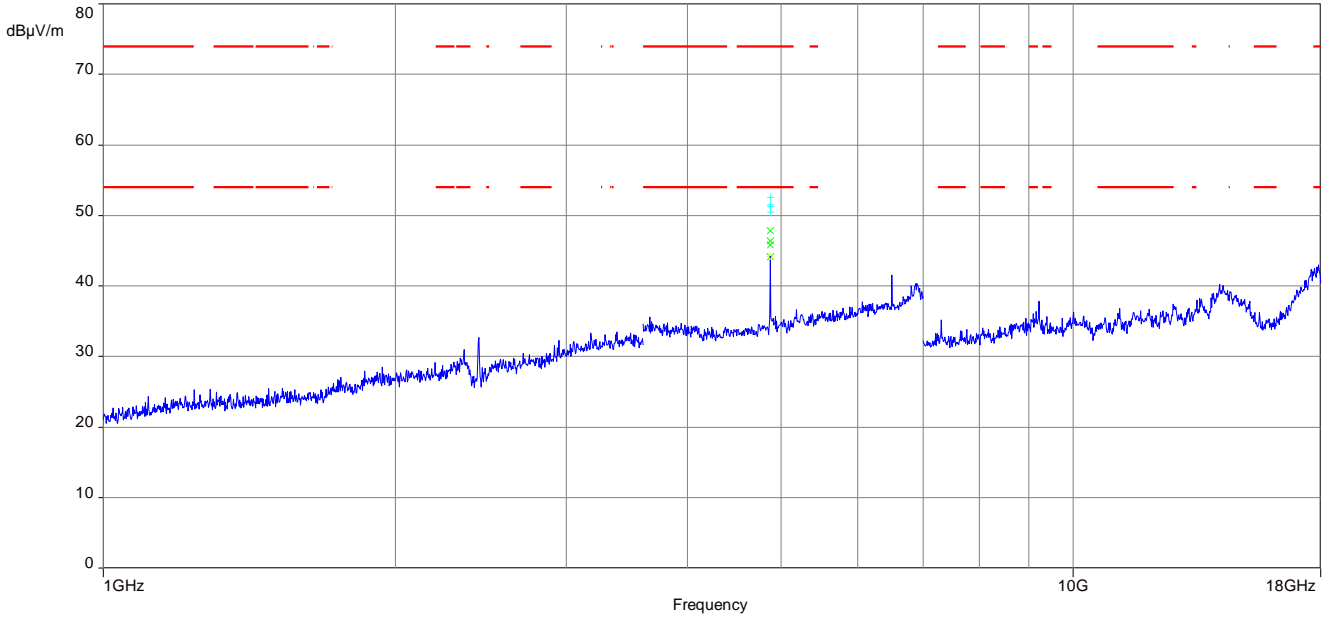

The carrier signal is notched with a 2.4 GHz band rejection filter.

Plot 4: Middle channel, 18 GHz to 26 GHz, vertical & horizontal polarization

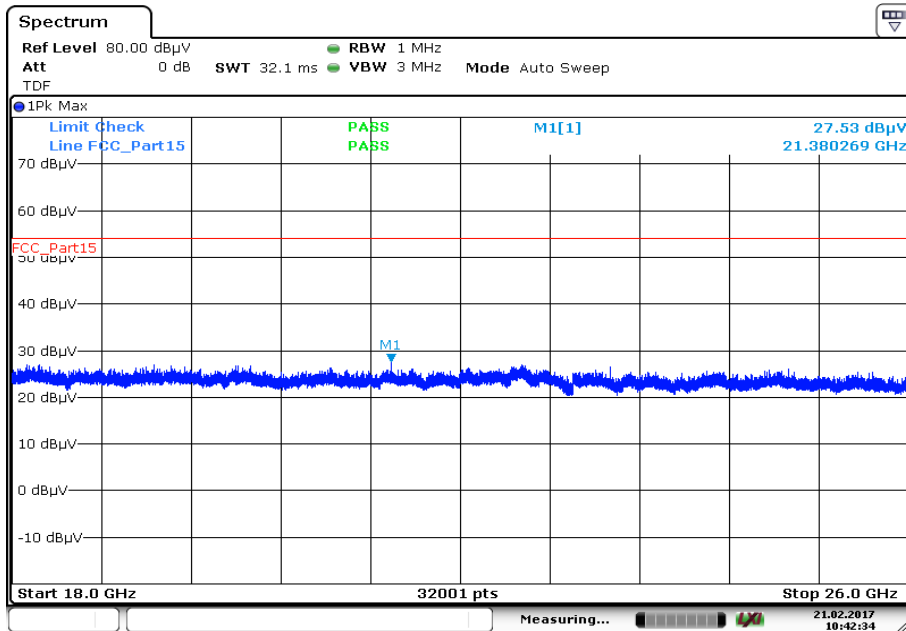

Plot 5: Highest channel, 1 GHz to 18 GHz, vertical & horizontal polarization

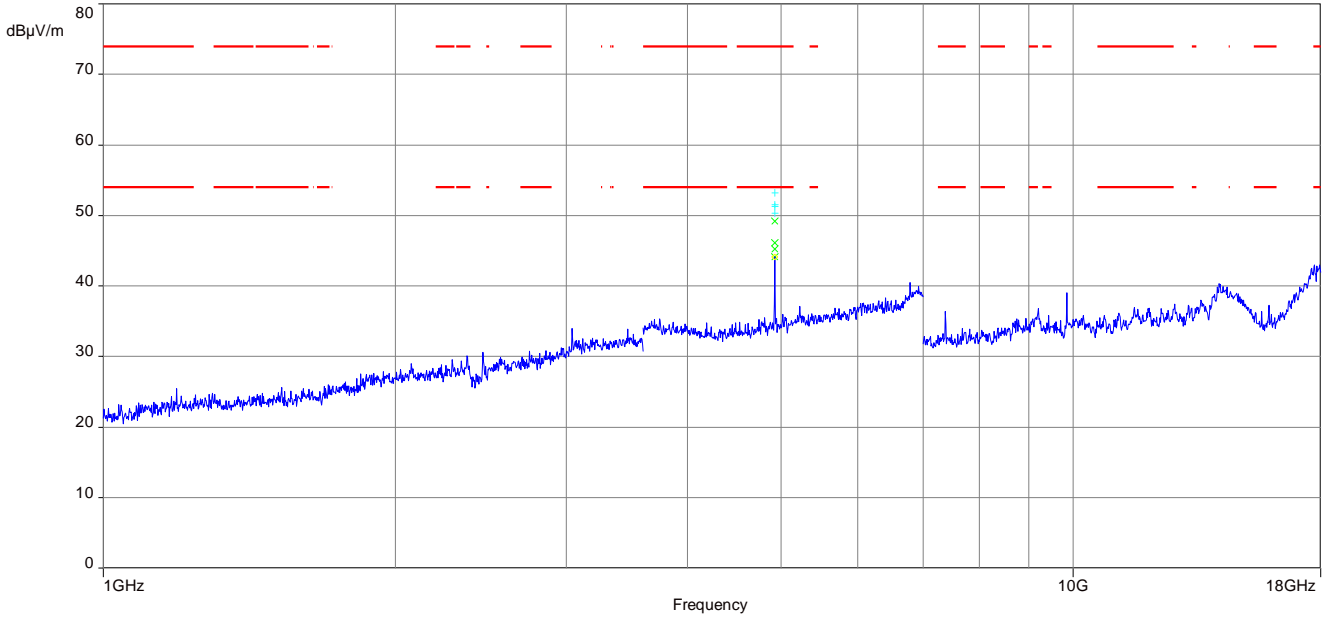

The carrier signal is notched with a 2.4 GHz band rejection filter.

Plot 6: Highest channel, 18 GHz to 26 GHz, vertical & horizontal polarization

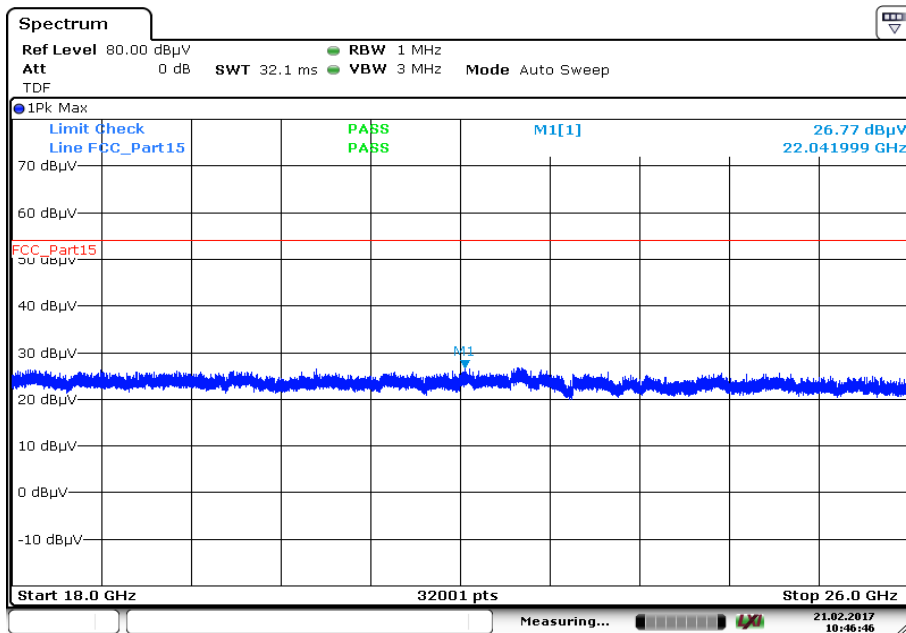

Plots: OFDM (20 MHz bandwidth)

Plot 1: Lowest channel, 1 GHz to 18 GHz, vertical & horizontal polarization

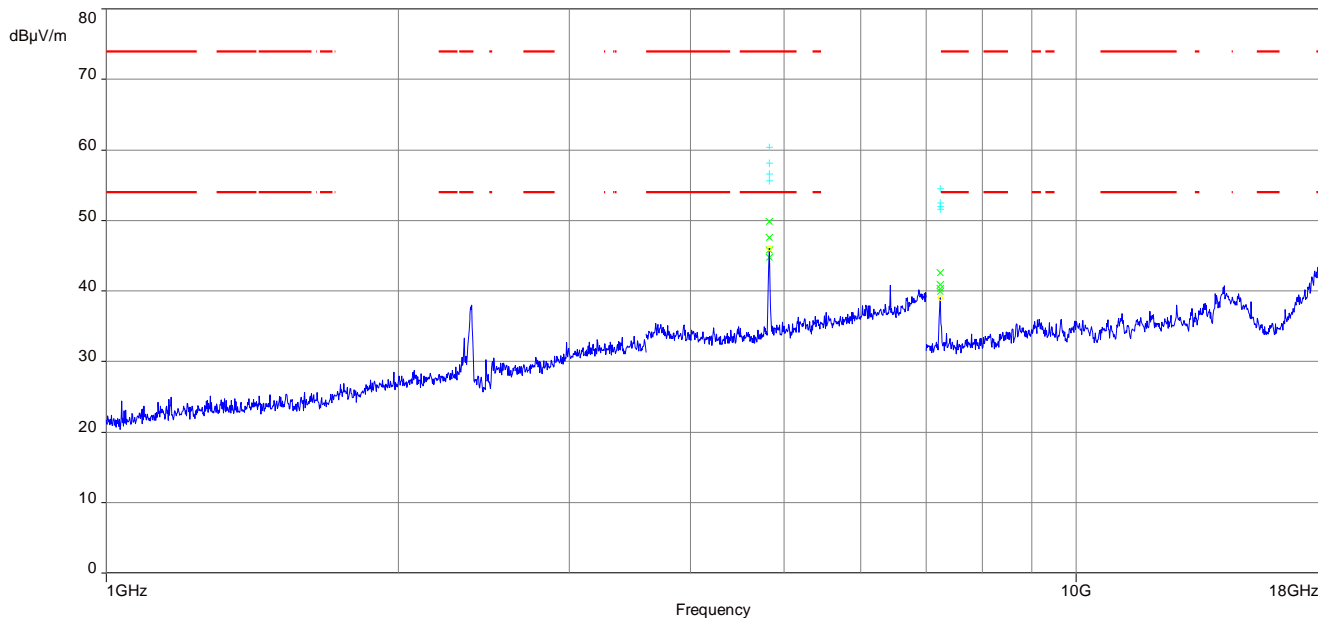

The carrier signal is notched with a 2.4 GHz band rejection filter.

Plot 2: Lowest channel, 18 GHz to 26 GHz, vertical & horizontal polarization

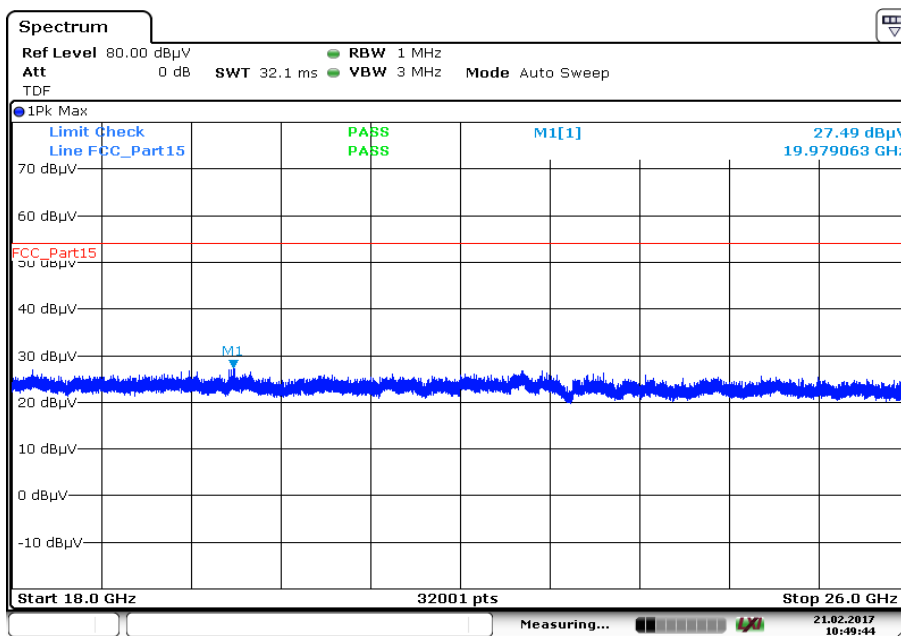

Date: 21.FEB.2017 10:49:45

Plot 3: Middle channel, 1 GHz to 18 GHz, vertical & horizontal polarization

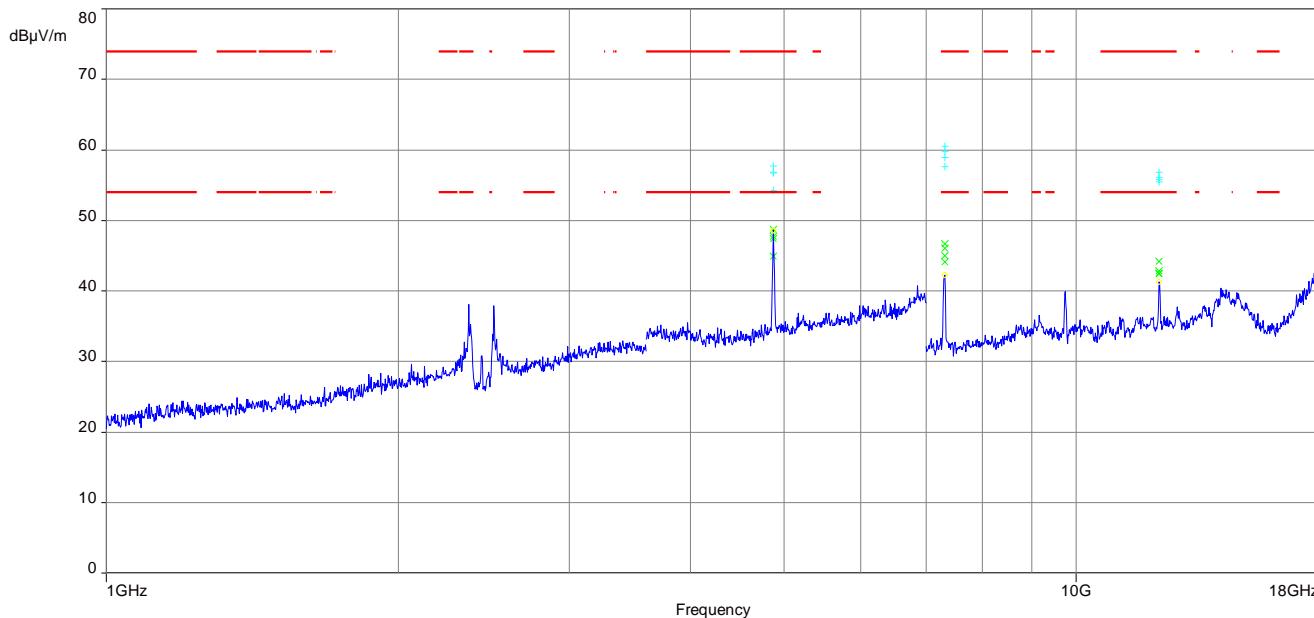

The carrier signal is notched with a 2.4 GHz band rejection filter.

Plot 4: Middle channel, 18 GHz to 26 GHz, vertical & horizontal polarization

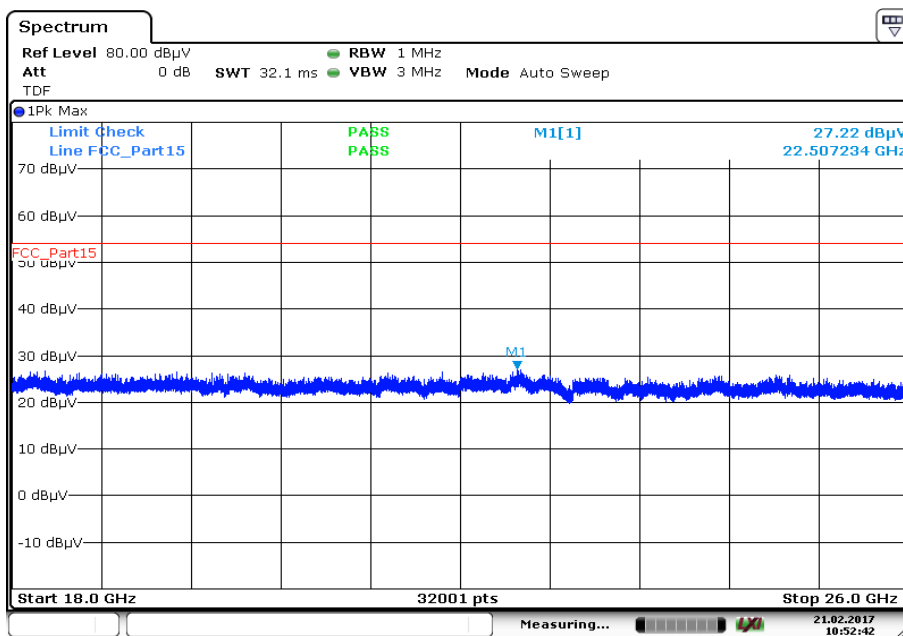

Date: 21.FEB.2017 10:52:43

Plot 5: Highest channel, 1 GHz to 18 GHz, vertical & horizontal polarization

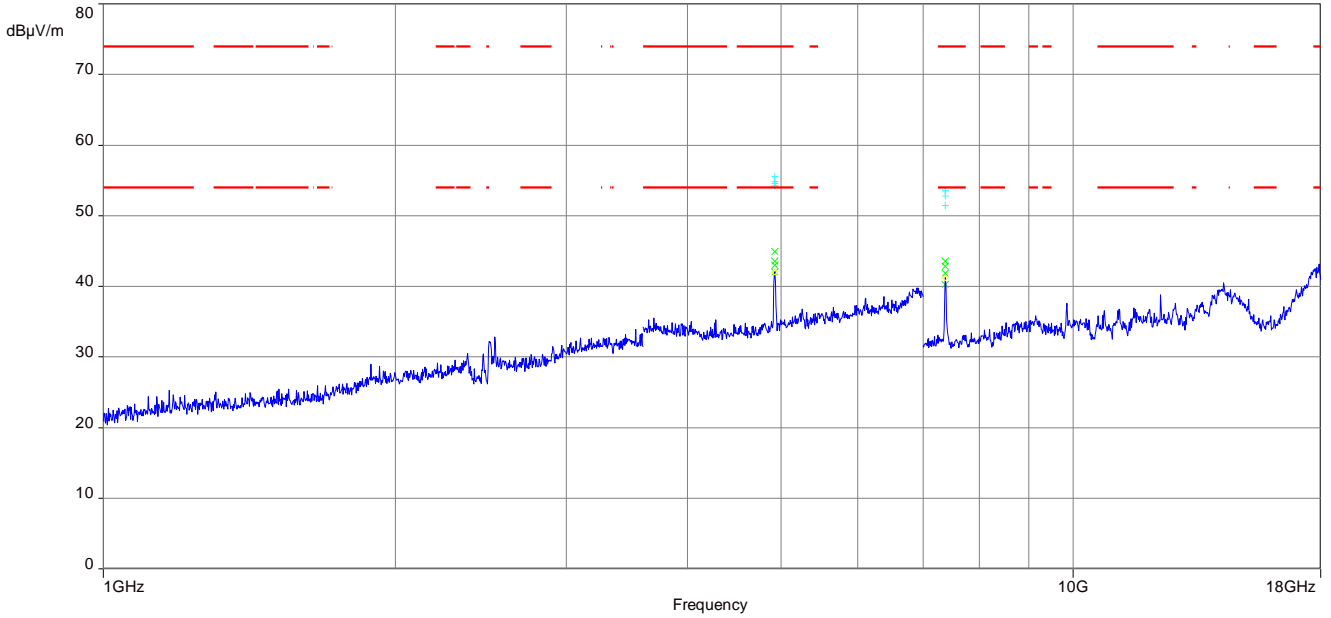

The carrier signal is notched with a 2.4 GHz band rejection filter.

Plot 6: Highest channel, 18 GHz to 26 GHz, vertical & horizontal polarization

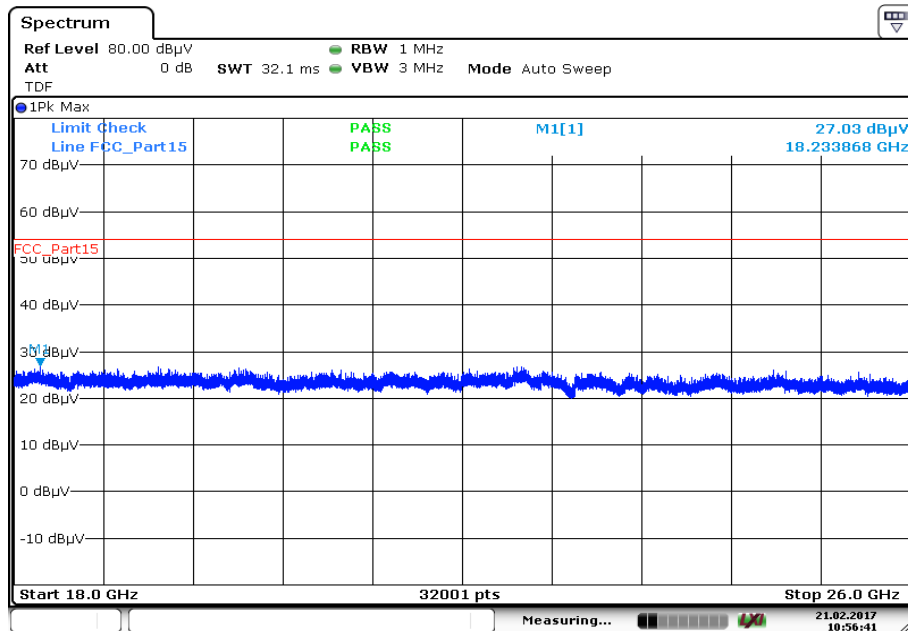

Date: 21.FEB.2017 10:56:42

Plots: OFDM (40 MHz bandwidth)

Plot 1: Lowest channel, 1 GHz to 18 GHz, vertical & horizontal polarization

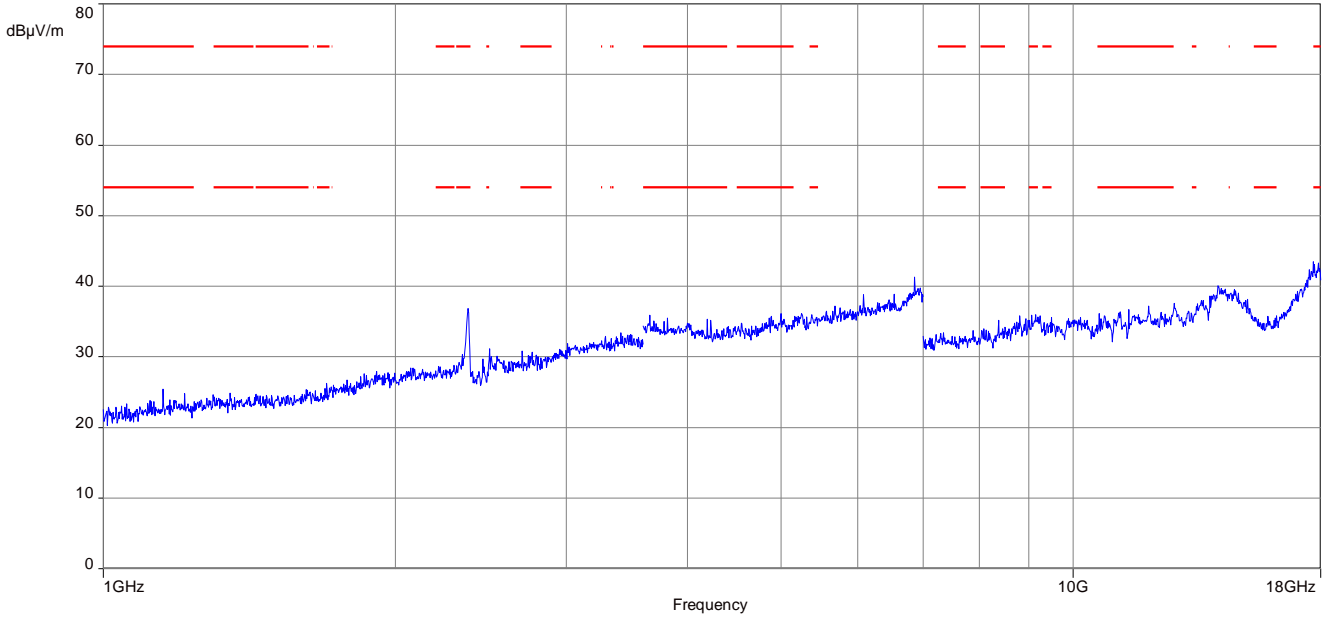

The carrier signal is notched with a 2.4 GHz band rejection filter.

Plot 2: Lowest channel, 18 GHz to 26 GHz, vertical & horizontal polarization

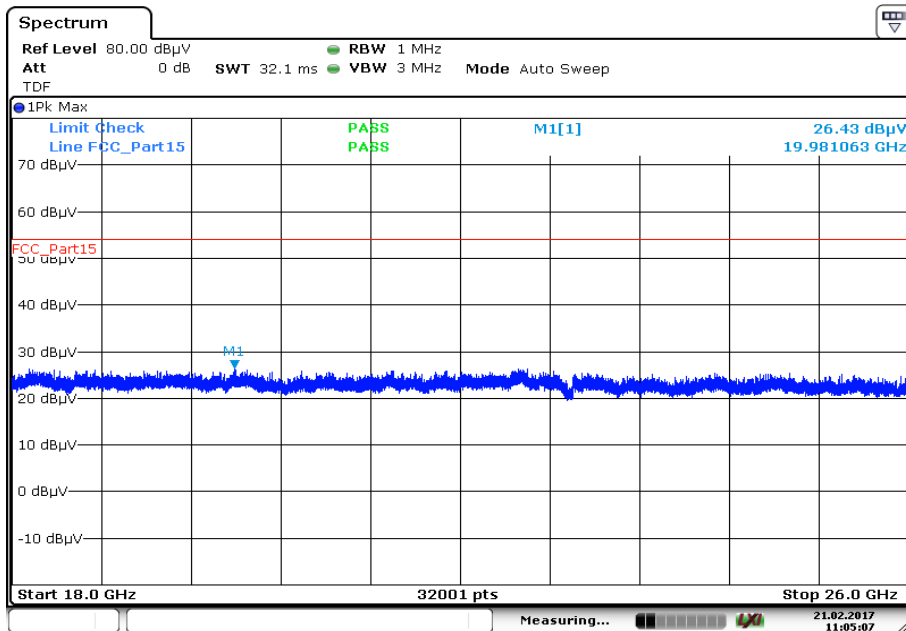

Date: 21.FEB.2017 11:05:08

Plot 3: Middle channel, 1 GHz to 18 GHz, vertical & horizontal polarization

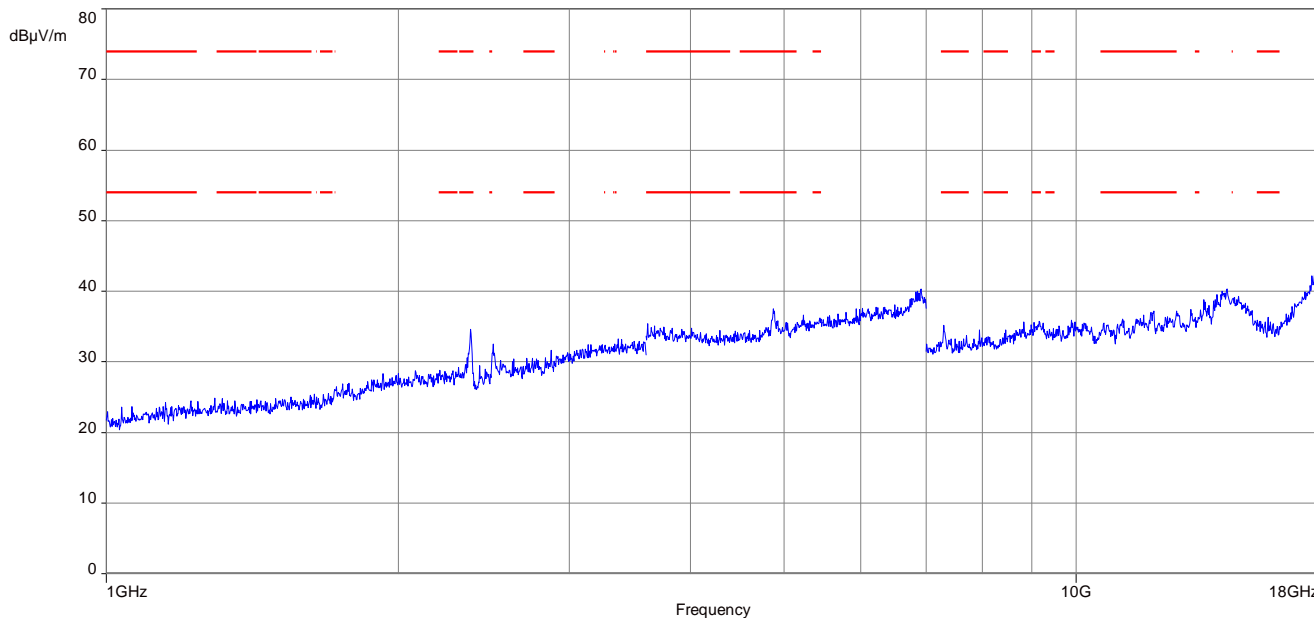

The carrier signal is notched with a 2.4 GHz band rejection filter.

Plot 4: Middle channel, 18 GHz to 26 GHz, vertical & horizontal polarization

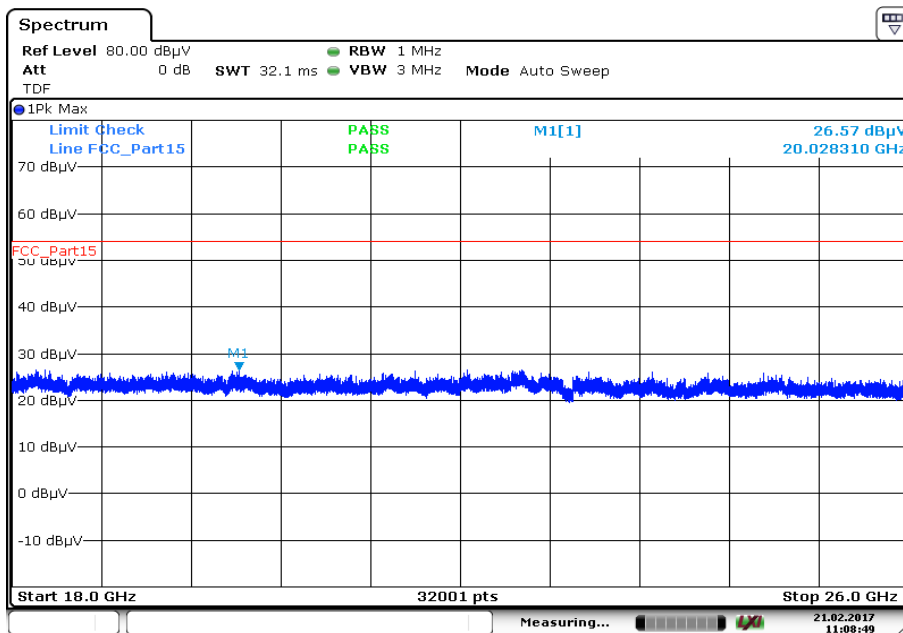

Date: 21.FEB.2017 11:08:50

Plot 5: Highest channel, 1 GHz to 18 GHz, vertical & horizontal polarization

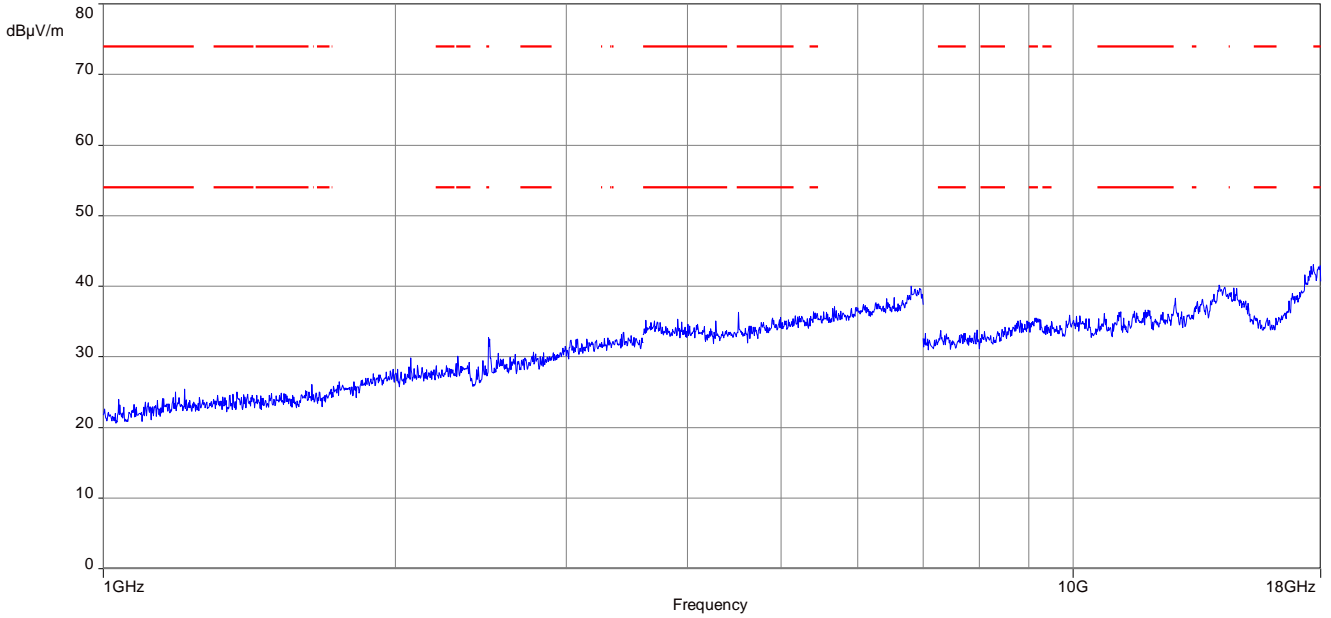

The carrier signal is notched with a 2.4 GHz band rejection filter.

Plot 6: Highest channel, 18 GHz to 26 GHz, vertical & horizontal polarization

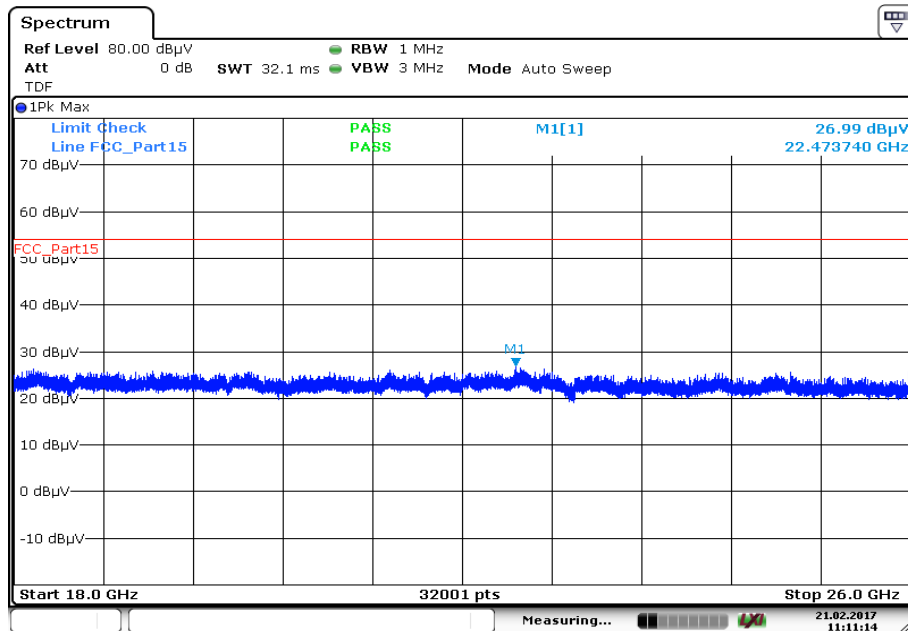

Date: 21.FEB.2017 11:11:14

Plots: RX / idle mode

Plot 1: 1 GHz to 18 GHz, vertical & horizontal polarization

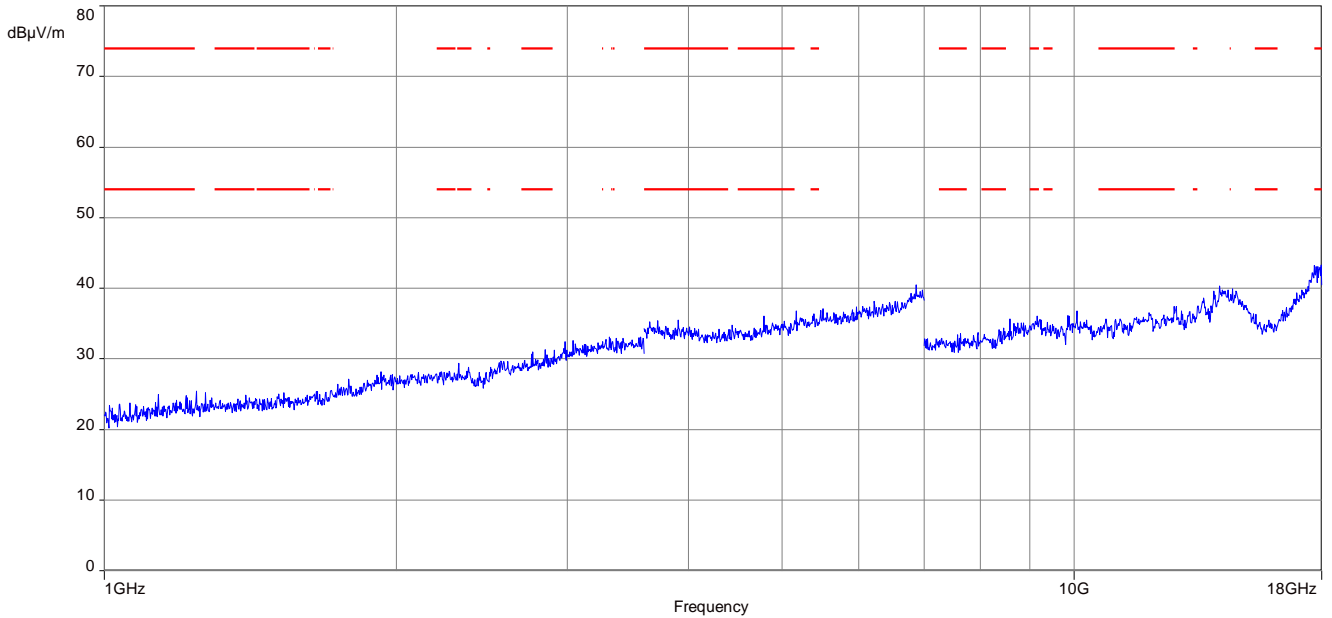

Plot 2: 18 GHz to 26 GHz, vertical & horizontal polarization

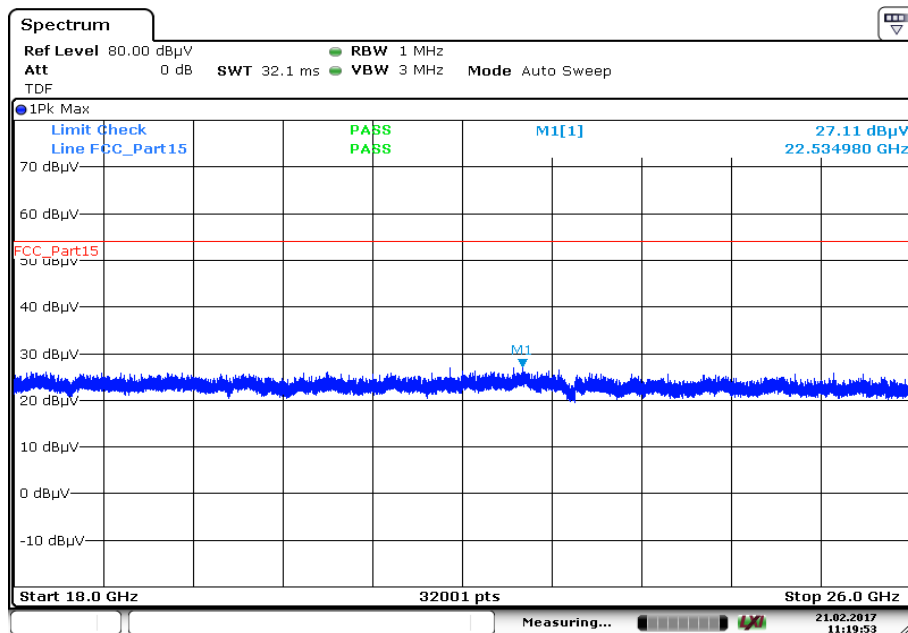

11.14 Spurious emissions conducted below 30 MHz (AC conducted)

Description:

Measurement of the conducted spurious emissions in transmit mode below 30 MHz. The EUT is set to channel 6. This measurement is repeated for DSSS and OFDM modulation. If peaks are found channel 1 and channel 11 will be measured too. The measurement is performed with the data rate producing the highest output power. Both power lines, phase and neutral line, are measured. Found peaks are re-measured with average and quasi peak detection to show compliance to the limits.

Measurement:

Measurement parameter	
Detector:	Peak - Quasi Peak / Average
Sweep time:	Auto
Resolution bandwidth:	F < 150 kHz: 200 Hz F > 150 kHz: 9 kHz
Video bandwidth:	F < 150 kHz: 1 kHz F > 150 kHz: 100 kHz
Span:	9 kHz to 30 MHz
Trace mode:	Max Hold
Test setup:	See sub clause 6.4 - A
Measurement uncertainty:	See sub clause 8

Limits:

FCC		IC
Frequency (MHz)	Quasi-Peak (dBµV/m)	Average (dBµV/m)
0.15 – 0.5	66 to 56*	56 to 46*
0.5 – 5	56	46
5 – 30.0	60	50

*Decreases with the logarithm of the frequency

Results:

TX Spurious Emissions Conducted < 30 MHz [dBµV/m]		
F [MHz]	Detector	Level [dBµV/m]
See table		

Plots:

Plot 1: 150 kHz to 30 MHz, phase line

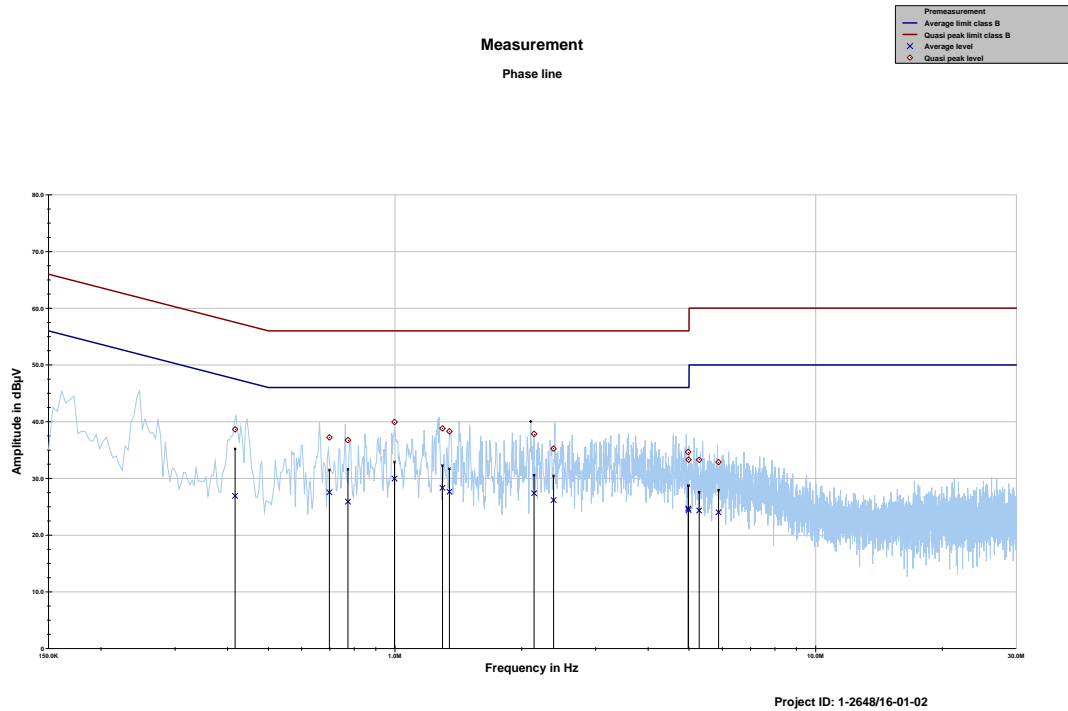

Final results:

Frequency	Quasi peak level	Margin quasi peak	Limit QP	Average level	Margin average	Limit AV
MHz	dBµV	dB	dBµV	dBµV	dB	dBµV
0.416631	38.64	18.88	57.515	26.91	21.47	48.382
0.698201	37.22	18.78	56.000	27.54	18.46	46.000
0.772678	36.73	19.27	56.000	25.89	20.11	46.000
0.997211	39.91	16.09	56.000	29.96	16.04	46.000
1.296687	38.81	17.19	56.000	28.33	17.67	46.000
1.347303	38.30	17.70	56.000	27.65	18.35	46.000
2.141794	37.84	18.16	56.000	27.39	18.61	46.000
2.381608	35.23	20.77	56.000	26.16	19.84	46.000
4.976158	34.65	21.35	56.000	24.70	21.30	46.000
4.986880	33.29	22.71	56.000	24.42	21.58	46.000
5.284201	33.25	26.75	60.000	24.33	25.67	50.000
5.874252	32.86	27.14	60.000	24.01	25.99	50.000

Plot 2: 150 kHz to 30 MHz, neutral line

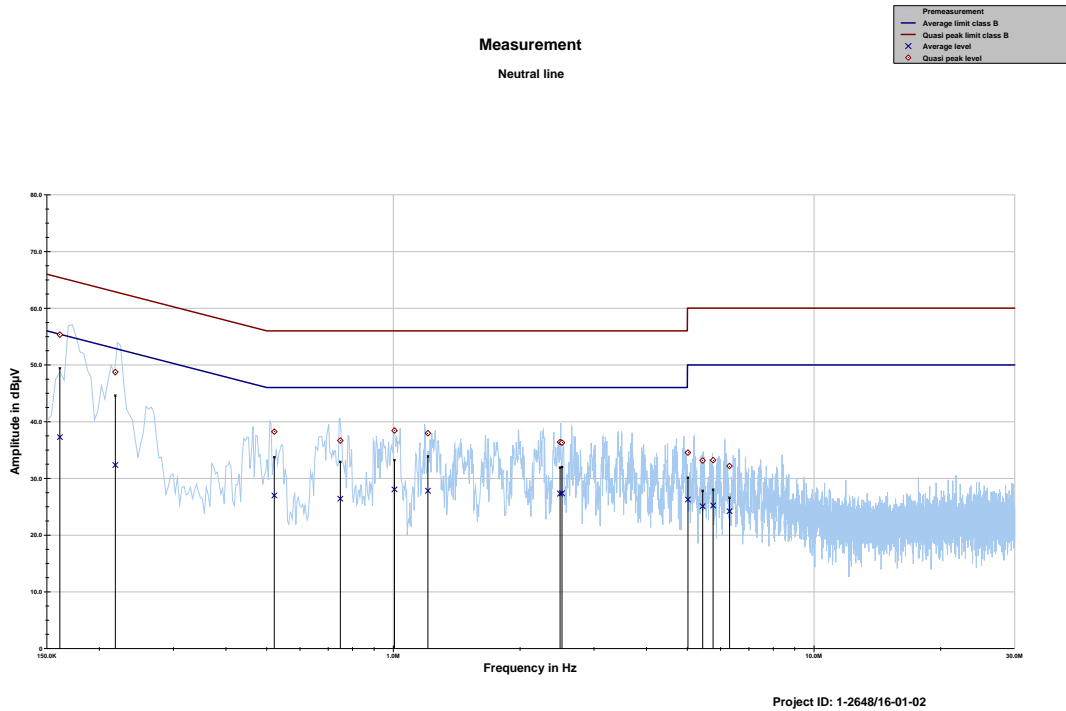

Final results:

Frequency	Quasi peak level	Margin quasi peak	Limit QP	Average level	Margin average	Limit AV
MHz	dBµV	dB	dBµV	dBµV	dB	dBµV
0.161118	55.35	10.06	65.406	37.27	18.41	55.682
0.218327	48.74	14.14	62.882	32.36	21.69	54.048
0.521062	38.22	17.78	56.000	26.98	19.02	46.000
0.747850	36.68	19.32	56.000	26.41	19.59	46.000
1.006126	38.43	17.57	56.000	28.05	17.95	46.000
1.208386	37.94	18.06	56.000	27.80	18.20	46.000
2.489762	36.39	19.61	56.000	27.30	18.70	46.000
2.516720	36.30	19.70	56.000	27.36	18.64	46.000
5.015009	34.53	25.47	60.000	26.27	23.73	50.000
5.433672	33.14	26.86	60.000	25.08	24.92	50.000
5.755236	33.20	26.80	60.000	25.22	24.78	50.000
6.295421	32.18	27.82	60.000	24.21	25.79	50.000

12 Observations

No observations except those reported with the single test cases have been made.

Annex A Document history

Version	Applied changes	Date of release
	Initial release	2017-03-23

Annex B Further information

Glossary

AVG	-	Average
DUT	-	Device under test
EMC	-	Electromagnetic Compatibility
EN	-	European Standard
EUT	-	Equipment under test
ETSI	-	European Telecommunications Standard Institute
FCC	-	Federal Communication Commission
FCC ID	-	Company Identifier at FCC
HW	-	Hardware
IC	-	Industry Canada
Inv. No.	-	Inventory number
N/A	-	Not applicable
PP	-	Positive peak
QP	-	Quasi peak
S/N	-	Serial number
SW	-	Software
PMN	-	Product marketing name
HMN	-	Host marketing name
HVIN	-	Hardware version identification number
FVIN	-	Firmware version identification number
OBW		Occupied Bandwidth
OC		Operating Channel
OCW		Operating Channel Bandwidth
OOB		Out Of Band

Annex C Accreditation Certificate

first page



Deutsche Akkreditierungsstelle GmbH

Befehle gemäß § 8 Absatz 1 AkkStelleG i.V.m. § 1 Absatz 1 AkkStelleGBV
Unterzeichnerin der Multilateralen Abkommen
von EA, ILAC und IAF zur gegenseitigen Anerkennung

Akkreditierung



Die Deutsche Akkreditierungsstelle GmbH bestätigt hiermit, dass das Prüflaboratorium

CTC advanced GmbH
Untertürkheimer Straße 6-10, 66117 Saarbrücken

die Kompetenz nach DIN EN ISO/IEC 17025:2005 besitzt, Prüfungen in folgenden Bereichen durchzuführen:

Funk
Mobilfunk (GSM / DCS) + OTA
Elektromagnetische Verträglichkeit (EMV)
Produktsicherheit
SAR / EMF
Umwelt
Smart Card Technology
Bluetooth®
Automotive
Wi-Fi-Services
Kanaadische Anforderungen
US-Anforderungen
Akustik
Near Field Communication (NFC)

Die Akkreditierungsurkunde gilt nur in Verbindung mit dem Bescheid vom 25.11.2016 mit der Akkreditierungsnummer D-PL-12076-01 und ist gültig bis 17.01.2018. Sie besteht aus diesem Deckblatt, der Rückseite des Deckblatts und der folgenden Anlage mit insgesamt 63 Seiten.

Registrierungsnummer der Urkunde: D-PL-12076-01-01

Frankfurt, 25.11.2016

Bitte Hinweisen auf der Rückseite

Im Auftrag Dipl.-Ing. Gerd Kalf Eigner
Abteilungsleiter

last page

Deutsche Akkreditierungsstelle GmbH

Standort Berlin
Spittelmarkt 10
10117 Berlin

Standort Frankfurt am Main
Europa-Allee 52
60327 Frankfurt am Main

Standort Braunschweig
Bundesallee 100
38116 Braunschweig

Die auszugsweise Veröffentlichung der Akkreditierungsurkunde bedarf der vorherigen schriftlichen Zustimmung der Deutsche Akkreditierungsstelle GmbH (DAKKS). Ausgenommen davon ist die separate Weiterverbreitung des Deckblattes durch die umseitig genannte Konformitätsbewertungsstelle in unveränderter Form.

Es darf nicht der Anschein erweckt werden, dass sich die Akkreditierung auch auf Bereiche erstreckt, die über den durch die DAKKS bestätigten Akkreditierungsbereich hinausgehen.

Die Akkreditierung erfolgte gemäß des Gesetzes über die Akkreditierungsstelle (AkkStelleG) vom 31. Juli 2009 (BGBl. I S. 2625) sowie der Verordnung (EG) Nr. 765/2008 des Europäischen Parlaments und des Rates vom 9. Juli 2008 über die Vorschriften für die Akkreditierung und Marktüberwachung im Zusammenhang mit der Vermarktung von Produkten (Abl. L 218 vom 9. Juli 2008, S. 30). Die DAKKS ist Unterzeichnerin der Multilateralen Abkommen zur gegenseitigen Anerkennung der European co-operation for Accreditation (EA), des International Accreditation Forum (IAF) und der International Laboratory Accreditation Cooperation (ILAC). Die Unterzeichner dieser Abkommen erkennen ihre Akkreditierungen gegenseitig an.

Der aktuelle Stand der Mitgliedschaft kann folgenden Webseiten entnommen werden:
EA: www.european-accreditation.org
ILAC: www.ilac.org
IAF: www.iaf.nu

Note:
The current certificate including annex can be received on request.