



CETECOM ICT Services is now

**CTC** | **advanced**  
member of RWTÜV group

## TEST REPORT

Test report no.: 1-2648/16-01-04



Deutsche  
Akkreditierungsstelle  
D-PL-12076-01-01

### Testing laboratory

#### CTC advanced GmbH

Untertuerkheimer Strasse 6 – 10

66117 Saarbruecken / Germany

Phone: + 49 681 5 98 - 0

Fax: + 49 681 5 98 - 9075

Internet: <http://www.ctcadvanced.com>

e-mail: [mail@ctcadvanced.com](mailto:mail@ctcadvanced.com)

#### Accredited Testing Laboratory:

The testing laboratory (area of testing) is accredited according to DIN EN ISO/IEC 17025 (2005) by the Deutsche Akkreditierungsstelle GmbH (DAKKS)

The accreditation is valid for the scope of testing procedures as stated in the accreditation certificate with the registration number: D-PL-12076-01-01

### Applicant

#### Ingenico Group

9 Avenue de la Gare Rovaltain

26958 Valence Cedex 9 / FRANCE

Phone: -/-

Fax: -/-

Contact: Jean-Baptiste Palisse

e-mail: [jean-baptiste.palisse@ingenico.com](mailto:jean-baptiste.palisse@ingenico.com)

Phone: +33 4 75 84 21 74

### Manufacturer

#### Ingenico Group

9 Avenue de la Gare Rovaltain

26958 Valence Cedex 9 / FRANCE

### Test standard/s

47 CFR Part 15

Title 47 of the Code of Federal Regulations; Chapter I; Part 15 - Radio frequency devices

RSS - 247 Issue 2

Digital Transmission Systems (DTSs), Frequency Hopping Systems (FHSs) and Licence - Exempt Local Area Network (LE-LAN) Devices

For further applied test standards please refer to section 3 of this test report.

### Test Item

Kind of test item:

**Mobile payment terminal**

Model name:

**Move/5000 and Move/3500  
CL/WiFi/BT/GPS/Camera of BCR**

FCC ID:

**XKB-M5000CLWIBT**

IC:

**2586D-M50CLWIBT**

Frequency:

UNII bands

5150 MHz to 5250 MHz; 5250 MHz to 5350 MHz;

5725 MHz to 5850 MHz

(lowest channel 5180 MHz; highest channel 5825 MHz)

Technology tested:

(WLAN (OFDM/a-; n HT20- & n HT40-mode)

Antenna:

Integrated metallic frame antenna

Power supply:

115 V AC / 5 V DC by mains adapter PSM08A-050I-R

3.6 V DC by battery (F26402376)

Temperature range:

+10°C to +50°C



This test report is electronically signed and valid without handwriting signature. For verification of the electronic signatures, the public keys can be requested at the testing laboratory.

### Test report authorized:

p.o.

Marco Bertolino

Lab Manager

Radio Communications & EMC

### Test performed:

Mihail Dorongovskij

Testing Manager

Radio Communications & EMC

<b>1 Table of contents</b>	
1	Table of contents .....2
2	General information .....3
2.1	Notes and disclaimer .....3
2.2	Application details.....3
2.3	Test laboratories sub-contracted .....3
3	Test standard/s and references .....4
4	Test environment.....5
5	Test item.....5
5.1	General description.....5
5.2	Additional information .....6
6	Description of the test setup.....6
6.1	Shielded semi anechoic chamber.....7
6.2	Shielded fully anechoic chamber .....8
6.3	Radiated measurements > 18 GHz.....9
6.4	AC conducted .....10
6.5	Conducted measurements with peak power meter & spectrum analyzer .....11
7	Sequence of testing .....12
7.1	Sequence of testing radiated spurious 9 kHz to 30 MHz.....12
7.2	Sequence of testing radiated spurious 30 MHz to 1 GHz.....13
7.3	Sequence of testing radiated spurious 1 GHz to 18 GHz.....14
7.4	Sequence of testing radiated spurious above 18 GHz .....15
8	Measurement uncertainty .....16
9	Summary of measurement results .....17
10	Additional comments.....18
11	Measurement results .....20
11.1	Identify worst case data rate .....20
11.2	Gain .....21
11.3	Duty cycle .....22
11.4	Maximum output power.....23
11.4.1	Maximum output power conducted – for FCC requirements .....23
11.4.2	Maximum output power – for IC requirements.....36
11.5	Power spectral density.....49
11.5.1	Power spectral density – for FCC requirements.....49
11.5.2	Power spectral density – for IC requirements.....56
11.6	Minimum emission bandwidth for the band 5.725-5.85 GHz .....63
11.7	Spectrum bandwidth – 26 dB bandwidth .....70
11.8	Occupied bandwidth – 99% emission bandwidth.....83
11.9	Band edge compliance radiated.....96
11.10	TX spurious emissions radiated .....99
11.11	RX spurious emissions radiated .....139
11.12	Spurious emissions radiated < 30 MHz .....143
11.13	Spurious emissions conducted < 30 MHz.....150
Annex A	Document history .....153
Annex B	Further information.....153
Annex C	Accreditation Certificate .....154

## 2 General information

### 2.1 Notes and disclaimer

The test results of this test report relate exclusively to the test item specified in this test report. CTC advanced GmbH does not assume responsibility for any conclusions and generalizations drawn from the test results with regard to other specimens or samples of the type of the equipment represented by the test item.

The test report may only be reproduced or published in full. Reproduction or publication of extracts from the report requires the prior written approval of CTC advanced GmbH.

The testing service provided by CTC advanced GmbH has been rendered under the current "General Terms and Conditions for CTC advanced GmbH".

CTC advanced GmbH will not be liable for any loss or damage resulting from false, inaccurate, inappropriate or incomplete product information provided by the customer.

Under no circumstances does the CTC advanced GmbH test report include any endorsement or warranty regarding the functionality, quality or performance of any other product or service provided.

Under no circumstances does the CTC advanced GmbH test report include or imply any product or service warranties from CTC advanced GmbH, including, without limitation, any implied warranties of merchantability, fitness for purpose, or non-infringement, all of which are expressly disclaimed by CTC advanced GmbH.

All rights and remedies regarding vendor's products and services for which CTC advanced GmbH has prepared this test report shall be provided by the party offering such products or services and not by CTC advanced GmbH. In no case this test report can be considered as a Letter of Approval.

This test report is electronically signed and valid without handwritten signature. For verification of the electronic signatures, the public keys can be requested at the testing laboratory.

### 2.2 Application details

Date of receipt of order:	2016-12-08
Date of receipt of test item:	2017-01-03
Start of test:	2017-01-13
End of test:	2017-03-15
Person(s) present during the test:	-/-

### 2.3 Test laboratories sub-contracted

None

### 3 Test standard/s and references

Test standard	Date	Description
47 CFR Part 15		Title 47 of the Code of Federal Regulations; Chapter I; Part 15 - Radio frequency devices
RSS - 247 Issue 2	February 2017	Digital Transmission Systems (DTSs), Frequency Hopping Systems (FHSs) and Licence - Exempt Local Area Network (LE-LAN) Devices
RSS - Gen Issue 4	November 2014	Spectrum Management and Telecommunications Radio Standards Specifications - General Requirements and Information for the Certification of Radio Apparatus

Guidance	Version	Description
UNII: KDB 789033 D02	v01r01	Guidelines for Compliance Testing of Unlicensed National Information Infrastructure (U-NII) Devices - Part 15, Subpart E Compliance measurement procedures for unlicensed - national information infrastructure devices operating in the 5250 - 5350 MHz and 5470 - 5725 MHz bands incorporating dynamic frequency selection
UNII: KDB 905462 D02	v01r02	American national standard for methods of measurement of radio-noise emissions from low-voltage electrical and electronic equipment in the range of 9 kHz to 40 GHz
ANSI C63.4-2014	-/-	American national standard of procedures for compliance testing of unlicensed wireless devices
ANSI C63.10-2013	-/-	

## 4 Test environment

Temperature	:	T <sub>nom</sub> T <sub>max</sub> T <sub>min</sub>	+23 °C during room temperature tests No tests under extreme conditions required. No tests under extreme conditions required.
Relative humidity content	:		55 %
Barometric pressure	:		1021 hpa
Power supply	:	V <sub>nom</sub> V <sub>max</sub> V <sub>min</sub>	115 V AC / 5 V DC by mains adapter PSM08A-050I-R 3.6 V DC by battery (F26402376) No tests under extreme conditions required. No tests under extreme conditions required.

## 5 Test item

### 5.1 General description

Kind of test item	:	Mobile payment terminal
Type identification	:	Move/5000 and Move/3500 CL/WiFi/BT/GPS/Camera of BCR
HMN	:	-/-
PMN	:	Move Series
HVIN	:	Move/5000 CL/WiFi/BT Move/3500 CL/WiFi/BT
FVIN	:	-/-
S/N serial number	:	Radiated unit: 163007333191035601212543 Conducted unit: 163007333191035601212543 (Both units have the same S/N label)
HW hardware status	:	01
SW software status	:	RF test mode
Frequency band	:	UNII bands 5150 MHz to 5250 MHz; 5250 MHz to 5350 MHz; 5725 MHz to 5850 MHz (lowest channel 5180 MHz; highest channel 5825 MHz)
Type of radio transmission	:	OFDM
Use of frequency spectrum	:	
Type of modulation	:	BPSK, QPSK, 16 – QAM, 64 – QAM
Number of channels	:	20 MHz channels: 13 40 MHz channels: 6
Antenna	:	Integrated metallic frame antenna
Power supply	:	115 V AC / 5 V DC by mains adapter PSM08A-050I-R 3.6 V DC by battery (F26402376)
Temperature range	:	+10°C to +50°C



## 6.1 Shielded semi anechoic chamber

The radiated measurements are performed in vertical and horizontal plane in the frequency range from 9 kHz to 1 GHz in semi-anechoic chambers. The EUT is positioned on a non-conductive support with a height of 0.80 m above a conductive ground plane that covers the whole chamber. The receiving antennas are conform to specifications ANSI C63. These antennas can be moved over the height range between 1.0 m and 4.0 m in order to search for maximum field strength emitted from EUT. The measurement distances between EUT and receiving antennas are indicated in the test setups for the various frequency ranges. For each measurement, the EUT is rotated in all three axes until the maximum field strength is received. The wanted and unwanted emissions are received by spectrum analyzers where the detector modes and resolution bandwidths over various frequency ranges are set according to requirement ANSI C63.



Measurement distance: tri-log antenna 10 meter

$$FS = UR + CL + AF$$

(FS-field strength; UR-voltage at the receiver; CL-loss of the cable; AF-antenna factor)

Example calculation:

$$FS [dB\mu V/m] = 12.35 [dB\mu V/m] + 1.90 [dB] + 16.80 [dB/m] = 31.05 [dB\mu V/m] (35.69 \mu V/m)$$

### Equipment table:

No.	Lab / Item	Equipment	Type	Manufacturer	Serial No.	INV. No.	Kind of Calibration	Last Calibration	Next Calibration
1	A	Switch-Unit	3488A	HP	2719A14505	300000368	ev	-/-	-/-
2	A	Meßkabine 1	HF-Absorberhalle	MWB AG 300023	101042	300000551	ne	-/-	-/-
3	A	EMI Test Receiver	ESCI 3	R&S	100083	300003312	k	08.03.2016	08.03.2017
4	A	Analyzer-Reference-System (Harmonics and Flicker)	ARS 16/1	SPS	A3509 07/0 0205	300003314	Ve	02.02.2016	02.02.2018
5	A	Antenna Tower	Model 2175	ETS-Lindgren	64762	300003745	izw	-/-	-/-
6	A	Positioning Controller	Model 2090	ETS-Lindgren	64672	300003746	izw	-/-	-/-
7	A	Turntable Interface-Box	Model 105637	ETS-Lindgren	44583	300003747	izw	-/-	-/-
8	A	TRILOG Broadband Test-Antenna 30 MHz - 3 GHz	VULB9163	Schwarzbeck	295	300003787	k	25.04.2016	25.04.2018

## 6.2 Shielded fully anechoic chamber

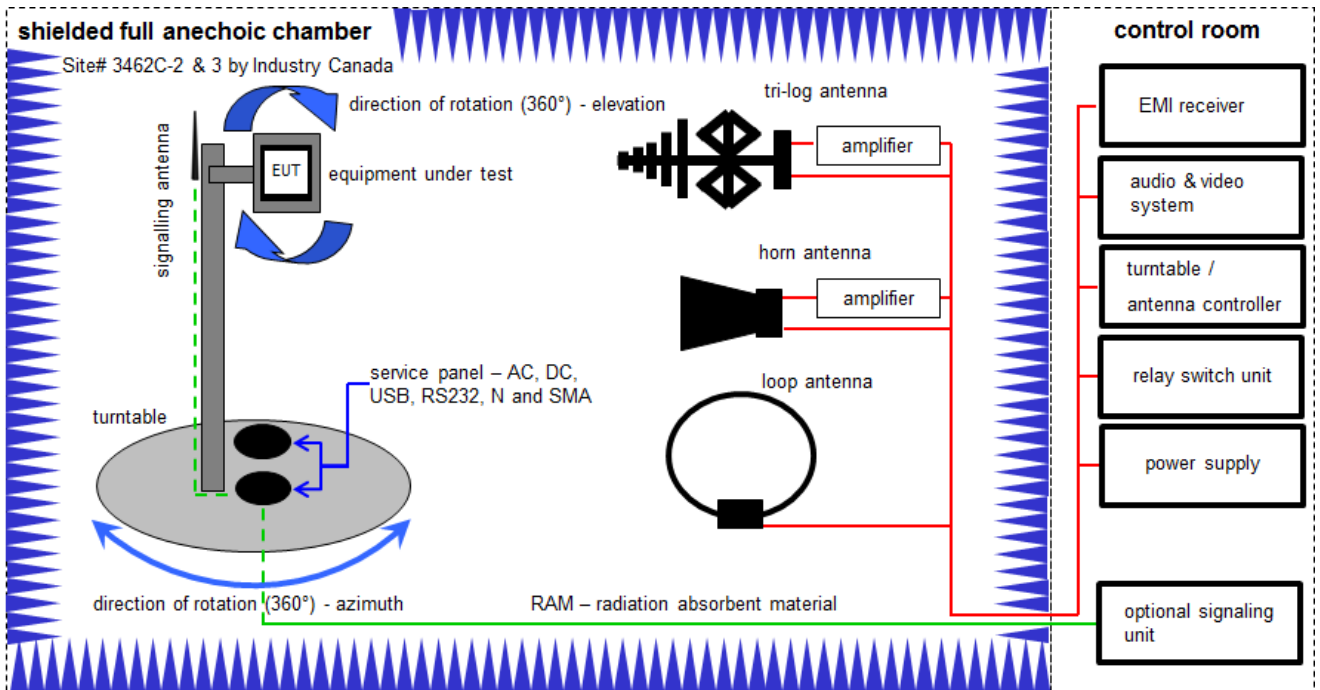

Measurement distance: tri-log antenna and horn antenna 3 meter; loop antenna 3 meter

FS = UR + CA + AF  
 (FS-field strength; UR-voltage at the receiver; CA-loss of the signal path; AF-antenna factor)

Example calculation:

$$FS [dB\mu V/m] = 40.0 [dB\mu V/m] + (-35.8) [dB] + 32.9 [dB/m] = 37.1 [dB\mu V/m] (71.61 \mu V/m)$$

**Equipment table:**

No.	Lab / Item	Equipment	Type	Manufacturer	Serial No.	INV. No.	Kind of Calibration	Last Calibration	Next Calibration
1	C	Active Loop Antenna 10 kHz to 30 MHz	6502	EMCO	2210	300001015	k	20.05.2015	20.05.2017
2	A	Double-Ridged Waveguide Horn Antenna 1-18.0GHz	3115	EMCO	9709-5290	300000212	k	13.08.2015	13.08.2017
3	A	Highpass Filter	WHK1.1/15G-10SS	Wainwright	37	400000148	ne	-/-	-/-
4	A	Highpass Filter	WHKX7.0/18G-8SS	Wainwright	18	300003789	ne	-/-	-/-
5	A	Band Reject Filter	WRCG2400/2483-2375/2505-50/10SS	Wainwright	26	300003792	ne	-/-	-/-
6	A, B	TRILOG Broadband Test-Antenna 30 MHz - 3 GHz	VULB9163	Schwarzbeck	318	300003696	k	22.04.2014	22.04.2017
7	A, B	Broadband Amplifier 0.5-18 GHz	CBLU5184540	CERNEX	22051	300004483	ev	-/-	-/-
8	A, B, C	4U RF Switch Platform	L4491A	Agilent Technologies	MY50000032	300004510	ne	-/-	-/-
9	A, B, C	Messrechner und Monitor	Intel Core i3 3220/3,3 GHz, Prozessor	Huber & Suhner	2V2403033A54 21	300004591	ne	-/-	-/-
10	A, B, C	NEXIO EMV-Software	BAT EMC V3.16.0.49	EMCO	Batch no. 14844	300004682	ne	-/-	-/-
11	A, B, C	Anechoic chamber	ESH3-Z5	TDK	893045/004	300003726	ne	-/-	-/-
12	A, B, C	EMI Test Receiver 9kHz-26,5GHz	ESR26	R&S	101376	300005063	vKI!	13.09.2016	13.03.2018



### 6.3 Radiated measurements > 18 GHz

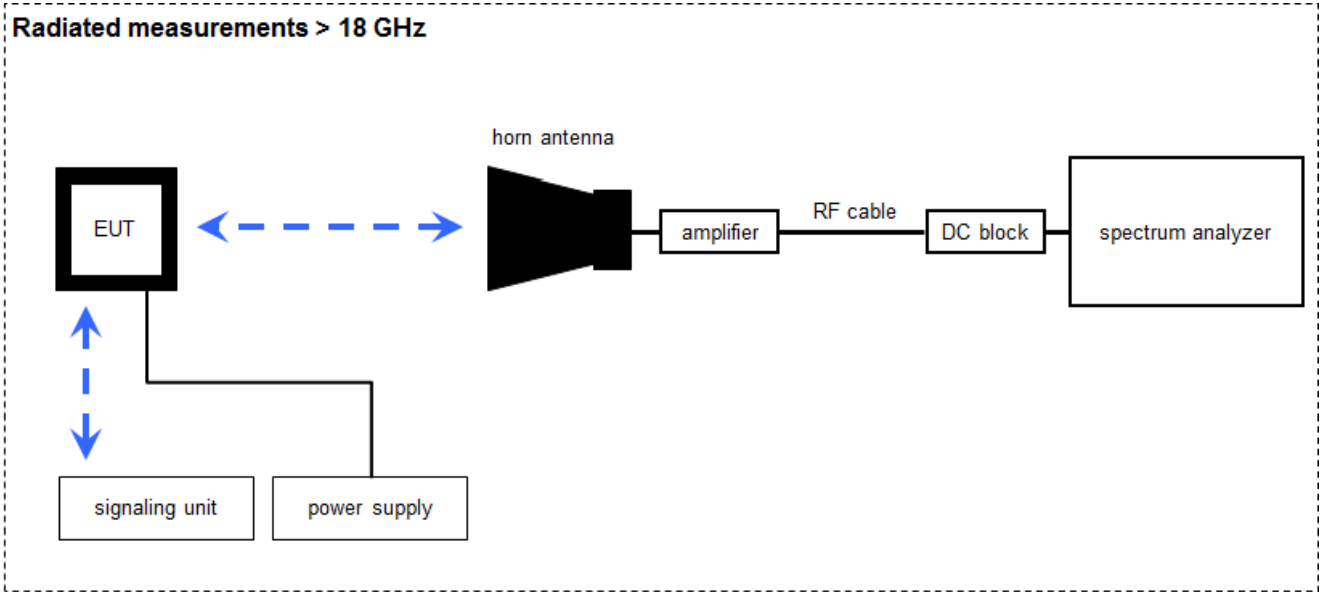

Measurement distance: horn antenna 50 cm

$$FS = U_R + CA + AF$$

(FS-field strength;  $U_R$ -voltage at the receiver; CA-loss signal path & distance correction; AF-antenna factor)

Example calculation:

$$FS [dB\mu V/m] = 40.0 [dB\mu V/m] + (-60.1) [dB] + 36.74 [dB/m] = 16.64 [dB\mu V/m] (6.79 \mu V/m)$$

**Equipment table:**

No.	Lab / Item	Equipment	Type	Manufacturer	Serial No.	INV. No.	Kind of Calibration	Last Calibration	Next Calibration
1	A	Std. Gain Horn Antenna 18.0 to 26.5 GHz	638	Narda	-/-	300000486	k	10.09.2015	10.09.2017
2	A	Signal Analyzer 40 GHz	FSV40	R&S	101042	300004517	k	27.01.2017	26.01.2018
3	A	Amplifier 2-40 GHz	JS32-02004000-57-5P	MITEQ	1777200	300004541	ev	-/-	-/-
4	A	RF-Cable	ST18/SMAm/SMAm/48	Huber & Suhner	Batch no. 600918	400001182	ev	-/-	-/-
5	A	RF-Cable	ST18/SMAm/SMAm/48	Huber & Suhner	Batch no. 127377	400001183	ev	-/-	-/-
6	A	DC-Blocker 0.1-40 GHz	8141A	Inmet	-/-	400001185	ev	-/-	-/-
7	A	Std. Gain Horn Antenna 26.5 to 40.0 GHz	V637	Narda	82-16	300000510	k	14.08.2015	14.08.2017

## 6.4 AC conducted

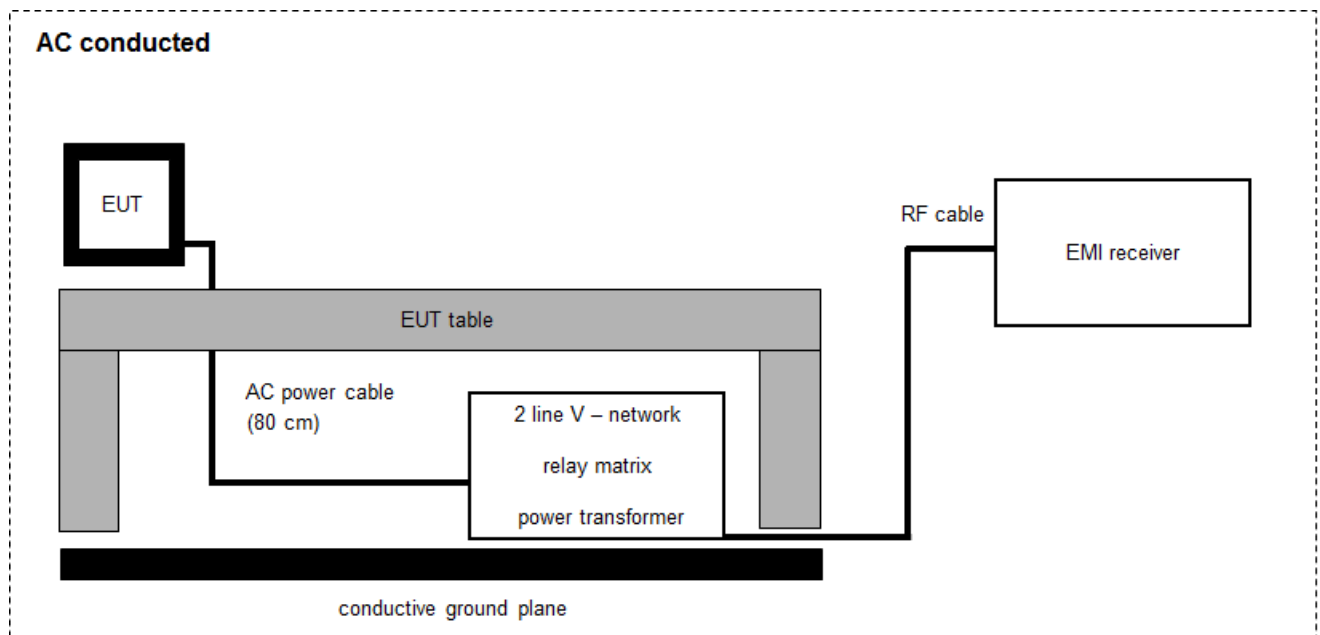

$$FS = UR + CF + VC$$

(FS-field strength; UR-voltage at the receiver; CR-loss of the cable and filter; VC-correction factor of the ISN)

*Example calculation:*

$$FS [dB\mu V/m] = 37.62 [dB\mu V/m] + 9.90 [dB] + 0.23 [dB] = 47.75 [dB\mu V/m] (244.06 \mu V/m)$$

### Equipment table:

No.	Lab / Item	Equipment	Type	Manufacturer	Serial No.	INV. No.	Kind of Calibration	Last Calibration	Next Calibration
1	A	Two-line V-Network (LISN) 9 kHz to 30 MHz	ESH3-Z5	R&S	893045/004	300000584	k	31.01.2017	30.01.2018
2	A	RF-Filter-section	85420E	HP	3427A00162	300002214	k	27.11.2006	-/-
3	A	EM-Injection Clamp	FCC-203i	emv	232	300000626	ev	18.05.2001	-/-
4	A	AC-Spannungsquelle variabel	MV2616-V	EM-Test	0397-12	300003259	k	11.12.2015	11.12.2017
5	A	Hochpass 150 kHz	EZ-25	R&S	100010	300003798	ev	08.04.2008	-/-
6	A	MXE EMI Receiver 20 Hz to 26,5 GHz	N9038A	Agilent Technologies	MY51210197	300004405	k	16.08.2016	16.08.2017

## 6.5 Conducted measurements with peak power meter & spectrum analyzer

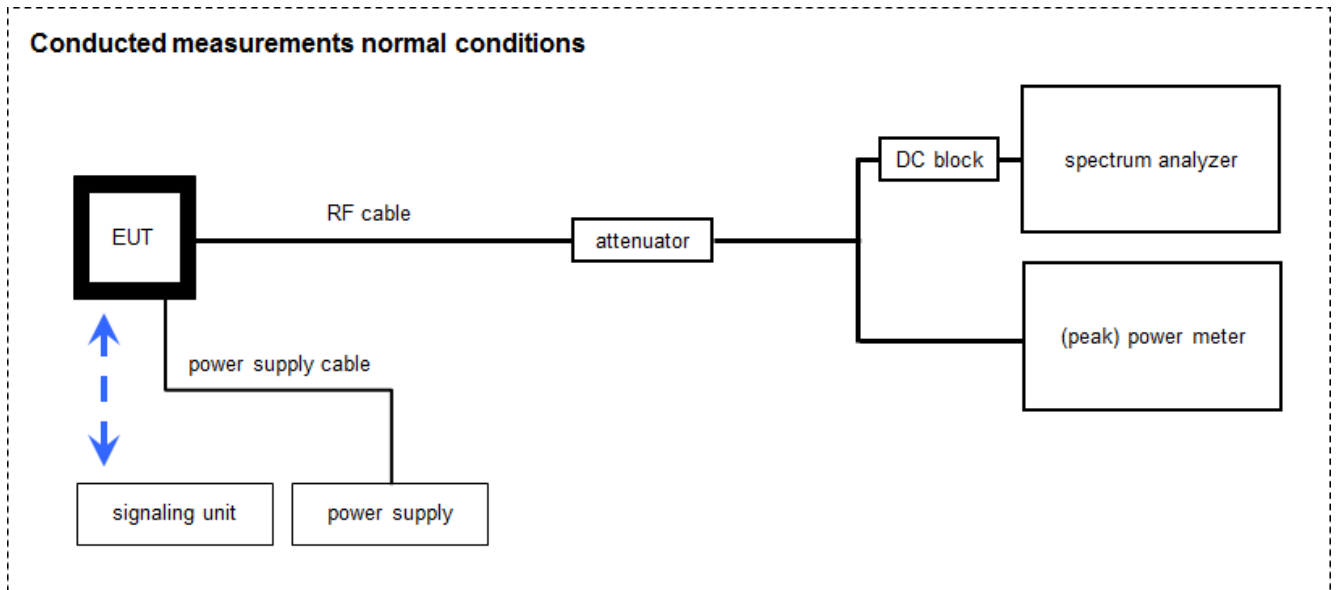

OP = AV + CA  
 (OP-output power; AV-analyzer value; CA-loss signal path)

Example calculation:

OP [dBm] = 6.0 [dBm] + 11.7 [dB] = 17.7 [dBm] (58.88 mW)

**Equipment table:**

No.	Lab / Item	Equipment	Type	Manufacturer	Serial No.	INV. No.	Kind of Calibration	Last Calibration	Next Calibration
1	A	Switch / Control Unit	3488A	HP	2719A15013	300000151	ne	-/-	-/-
2	A	PC-WLAN Tester	Intel Core i3 3220/3,3 GHz, Prozessor	R&S	2V2403033A4523	300004589	ne	-/-	-/-
3	A	Teststand	Teststand Custom Sequence Editor	National Instruments GmbH	2V2403033A4523	300004590	ne	-/-	-/-
4	A	PowerSplitter/Combiner 150-6000MHz N-Type	ZB3PD-63-N+	Mini-Circuits	100010	400000451	ev	-/-	-/-
5	A	RF-Cable	ST18/SMAm/SMAm/60	Huber & Suhner	Batch no. 606844	400001181	ev	-/-	-/-
6	A	Coax Attenuator 10 dB 2W 0-40 GHz	MCL BW-K10-2W44+	Mini Circuits	Batch no. 606844	400001186	ev	-/-	-/-
7	A	DC-Blocker 0.1-40 GHz	8141A	Inmet	Batch no. 127377	400001185	ev	-/-	-/-
8	A	Signal Analyzer 40 GHz	FSV40	R&S	101042	300004517	k	27.01.2017	26.01.2018

## 7 Sequence of testing

### 7.1 Sequence of testing radiated spurious 9 kHz to 30 MHz

#### Setup

- The equipment is set up to simulate normal operation mode as described in the user manual or defined by the manufacturer.
- If the EUT is a tabletop system, a 2-axis positioner with 1.5 m height is used.
- If the EUT is a floor standing device, it is placed directly on the turn table.
- Auxiliary equipment and cables are positioned to simulate normal operation conditions as described in ANSI C 63.4.
- The AC power port of the EUT (if available) is connected to a power outlet below the turntable.
- Measurement distance is 3 m (see ANSI C 63.4) – see test details.
- EUT is set into operation.

#### Premeasurement

- The turntable rotates from 0° to 315° using 45° steps.
- The antenna height is 1.5 m.
- At each turntable position the analyzer sweeps with positive-peak detector to find the maximum of all emissions.

#### Final measurement

- Identified emissions during the premeasurement are maximized by the software by rotating the turntable from 0° to 360°. In case of the 2-axis positioner is used the elevation axis is also rotated from 0° to 360°.
- The final measurement is done in the position (turntable and elevation) causing the highest emissions with quasi-peak (as described in ANSI C 63.4).
- Final levels, frequency, measuring time, bandwidth, turntable position, correction factor, margin to the limit and limit will be recorded. A plot with the graph of the premeasurement and the limit is stored.

## 7.2 Sequence of testing radiated spurious 30 MHz to 1 GHz

### Setup

- The equipment is set up to simulate normal operation mode as described in the user manual or defined by the manufacturer.
- If the EUT is a tabletop system, a table with 0.8 m height is used, which is placed on the ground plane.
- If the EUT is a floor standing device, it is placed on the ground plane with insulation between both.
- Auxiliary equipment and cables are positioned to simulate normal operation conditions as described in ANSI C 63.4.
- The AC power port of the EUT (if available) is connected to a power outlet below the turntable.
- Measurement distance is 10 m or 3 m (see ANSI C 63.4) – see test details.
- EUT is set into operation.

### Premeasurement

- The turntable rotates from 0° to 315° using 45° steps.
- The antenna is polarized vertical and horizontal.
- The antenna height changes from 1 m to 3 m.
- At each turntable position, antenna polarization and height the analyzer sweeps three times in peak to find the maximum of all emissions.

### Final measurement

- The final measurement is performed for at least six highest peaks according to the requirements of the ANSI C63.4.
- Based on antenna and turntable positions at which the peak values are measured the software maximize the peaks by changing turntable position  $\pm 45^\circ$  and antenna height between 1 and 4 m.
- The final measurement is done with quasi-peak detector (as described in ANSI C 63.4).
- Final levels, frequency, measuring time, bandwidth, antenna height, antenna polarization, turntable angle, correction factor, margin to the limit and limit are recorded. A plot with the graph of the premeasurement with marked maximum final results and the limit is stored.

### 7.3 Sequence of testing radiated spurious 1 GHz to 18 GHz

#### Setup

- The equipment is set up to simulate normal operation mode as described in the user manual or defined by the manufacturer.
- If the EUT is a tabletop system, a 2-axis positioner with 1.5 m height is used.
- If the EUT is a floor standing device, it is placed directly on the turn table.
- Auxiliary equipment and cables are positioned to simulate normal operation conditions as described in ANSI C 63.4.
- The AC power port of the EUT (if available) is connected to a power outlet below the turntable.
- Measurement distance is 3 m (see ANSI C 63.4) – see test details.
- EUT is set into operation.

#### Premeasurement

- The turntable rotates from 0° to 315° using 45° steps.
- The antenna is polarized vertical and horizontal.
- The antenna height is 1.5 m.
- At each turntable position and antenna polarization the analyzer sweeps with positive peak detector to find the maximum of all emissions.

#### Final measurement

- The final measurement is performed for at least six highest peaks according to the requirements of the ANSI C63.4.
- Based on antenna and turntable positions at which the peak values are measured the software maximizes the peaks by rotating the turntable from 0° to 360°. This measurement is repeated for different EUT-table positions (0° to 150° in 30°-steps) and for both antenna polarizations.
- The final measurement is done in the position (turntable, EUT-table and antenna polarization) causing the highest emissions with Peak and RMS detector (as described in ANSI C 63.4).
- Final levels, frequency, measuring time, bandwidth, turntable position, EUT-table position, antenna polarization, correction factor, margin to the limit and limit are recorded. A plot with the graph of the premeasurement with marked maximum final results and the limit is stored.

## 7.4 Sequence of testing radiated spurious above 18 GHz

### Setup

- The equipment is set up to simulate normal operation mode as described in the user manual or defined by the manufacturer.
- Auxiliary equipment and cables are positioned to simulate normal operation conditions as described in ANSI C 63.4.
- The AC power port of the EUT (if available) is connected to a power outlet.
- The measurement distance is as appropriate (e.g. 0.5 m).
- The EUT is set into operation.

### Premeasurement

- The test antenna is handheld and moved carefully over the EUT to cover the EUT's whole sphere and different polarizations of the antenna.

### Final measurement

- The final measurement is performed at the position and antenna orientation causing the highest emissions with Peak and RMS detector (as described in ANSI C 63.4).
- Final levels, frequency, measuring time, bandwidth, correction factor, margin to the limit and limit are recorded. A plot with the graph of the premeasurement and the limit is stored.

## 8 Measurement uncertainty

Measurement uncertainty	
Test case	Uncertainty
Antenna gain	± 3 dB
Power spectral density	± 1.5 dB
Spectrum bandwidth	± 100 kHz (depends on the used RBW)
Occupied bandwidth	± 100 kHz (depends on the used RBW)
Maximum output power	± 1.5 dB
Minimum emissions bandwidth	± 100 kHz (depends on the used RBW)
Spurious emissions conducted	± 3 dB
Spurious emissions radiated below 30 MHz	± 3 dB
Spurious emissions radiated 30 MHz to 1 GHz	± 3 dB
Spurious emissions radiated 1 GHz to 12.75 GHz	± 3.7 dB
Spurious emissions radiated above 12.75 GHz	± 4.5 dB
Spurious emissions conducted below 30 MHz (AC conducted)	± 2.6 dB



## 9 Summary of measurement results

<input checked="" type="checkbox"/>	No deviations from the technical specifications were ascertained
<input type="checkbox"/>	There were deviations from the technical specifications ascertained
<input checked="" type="checkbox"/>	This test report is only a partial test report. The content and verdict of the performed test cases are listed below.

TC Identifier	Description	Verdict	Date	Remark
RF-Testing	CFR Part 15 RSS 247, Issue 2	see table	2017-03-23	-/-

Test specification clause	Test case	Temperature conditions	Power source voltages	C	NC	NA	NP	Remark
-/-	Output power verification (conducted)	Nominal	Nominal	-/-				-/-
-/-	Antenna gain	Nominal	Nominal	-/-				Declared
U-NII Part 15	Duty cycle	Nominal	Nominal	-/-				-/-
§15.407(a) RSS - 247 (6.2.1.1) RSS - 247 (6.2.2.1) RSS - 247 (6.2.3.1) RSS - 247 (6.2.4.1)	Maximum output power (conducted & radiated)	Nominal	Nominal	<input checked="" type="checkbox"/>	<input type="checkbox"/>	<input type="checkbox"/>	<input type="checkbox"/>	-/-
§15.407(a) RSS - 247 (6.2.1.1) RSS - 247 (6.2.2.1) RSS - 247 (6.2.3.1) RSS - 247 (6.2.4.1)	Power spectral density	Nominal	Nominal	<input checked="" type="checkbox"/>	<input type="checkbox"/>	<input type="checkbox"/>	<input type="checkbox"/>	-/-
RSS - 247 (6.2.4.1)	Spectrum bandwidth 6dB bandwidth	Nominal	Nominal	<input checked="" type="checkbox"/>	<input type="checkbox"/>	<input type="checkbox"/>	<input type="checkbox"/>	-/-
§15.407(a)	Spectrum bandwidth 26dB bandwidth	Nominal	Nominal	<input checked="" type="checkbox"/>	<input type="checkbox"/>	<input type="checkbox"/>	<input type="checkbox"/>	-/-
RSS Gen clause 6.6	Spectrum bandwidth 99% bandwidth	Nominal	Nominal	-/-				-/-
§15.205 RSS - 247 (6.2.1.2) RSS - 247 (6.2.2.2) RSS - 247 (6.2.3.2) RSS - 247 (6.2.4.2)	Band edge compliance radiated	Nominal	Nominal	<input checked="" type="checkbox"/>	<input type="checkbox"/>	<input type="checkbox"/>	<input type="checkbox"/>	-/-
§15.407(b) RSS - 247 (6.2.1.2) RSS - 247 (6.2.2.2) RSS - 247 (6.2.3.2) RSS - 247 (6.2.4.2)	TX spurious emissions radiated	Nominal	Nominal	<input checked="" type="checkbox"/>	<input type="checkbox"/>	<input type="checkbox"/>	<input type="checkbox"/>	-/-
§15.109 RSS-Gen	RX spurious emissions radiated	Nominal	Nominal	<input checked="" type="checkbox"/>	<input type="checkbox"/>	<input type="checkbox"/>	<input type="checkbox"/>	-/-
§15.209(a) RSS-Gen	Spurious emissions radiated < 30 MHz	Nominal	Nominal	<input checked="" type="checkbox"/>	<input type="checkbox"/>	<input type="checkbox"/>	<input type="checkbox"/>	-/-
§15.107(a) §15.207	Spurious emissions conducted emissions < 30 MHz	Nominal	Nominal	<input checked="" type="checkbox"/>	<input type="checkbox"/>	<input type="checkbox"/>	<input type="checkbox"/>	-/-
§15.407 RSS - 247 (6.3)	DFS	Nominal	Nominal	-/-				See report 1-2648/16-01-05

**Note:** C = Compliant; NC = Not compliant; NA = Not applicable; NP = Not performed

## 10 Additional comments

Reference documents: Customer Questionnaire  
 ICO-OPE-03994 Wifi\_labtool\_Radio\_agreement\_procedure  
 ICO-OPE-04171 Wifi\_DFS\_Adaptivity\_agreement\_procedure

Special test descriptions: This test report is valid for both Move/3500 and Move/5000. Both systems use the identical RF parts. The only difference is the touch screen of the Move/5000 series. The different periphery electronics were tested with the worst case series (Move/5000) defined by the customer.

Used power settings for all tests:

Channel	36	40	44	48	52	56	60	64	149	153	157	161	165
11a	14	14	14	14	14	14	14	14	14	14	14	14	14
11n-20	13	13	13	13	13	13	13	13	13	13	13	13	13
11n-40	3	11	11	11	11	11	11	6	11	11	11	11	11

**The tested devices don't have a designed conducted port for the measurements. The impedance of the output is optimized for the internal antenna. Therefore the impedance of the temporary port doesn't match with the expected 50 Ohm impedance of the test system. This causes lower test results of the conducted measurements. This offset will be considered as "mismatch correction factor" and calculated in chapter 11.1.**

Configuration descriptions: None

Test mode:

- No test mode available.  
Iperf was used to ping another device with the largest support packet size
- Special software is used.  
EUT is transmitting pseudo random data by itself

Antennas and transmit operating modes:

- Operating mode 1 (single antenna)
  - *Equipment with 1 antenna,*
  - *Equipment with 2 diversity antennas operating in switched diversity mode by which at any moment in time only 1 antenna is used,*
  - *Smart antenna system with 2 or more transmit/receive chains, but operating in a mode where only 1 transmit/receive chain is used)*
- Operating mode 2 (multiple antennas, no beamforming)
  - *Equipment operating in this mode contains a smart antenna system using two or more transmit/receive chains simultaneously but without beamforming.*
- Operating mode 3 (multiple antennas, with beamforming)
  - *Equipment operating in this mode contains a smart antenna system using two or more transmit/receive chains simultaneously with beamforming.  
In addition to the antenna assembly gain (G), the beamforming gain (Y) may have to be taken into account when performing the measurements.*

## 11 Measurement results

### 11.1 Identify worst case data rate

**Measurement:**

All modes of the module will be measured with an average power meter or spectrum analyzer to identify the maximum transmission power.

In further tests only the identified worst case modulation scheme or bandwidth will be measured and this mode is used as representative mode for all other modulation schemes.

Additional the band edge compliance test will be performed in the lowest and highest modulation scheme.

**Measurement parameters:**

Measurement parameter	
Detector:	Peak
Sweep time:	Auto
Resolution bandwidth:	3 MHz
Video bandwidth:	3 MHz
Trace mode:	Max hold
Used test setup:	See chapter 6.5 – A
Measurement uncertainty:	see chapter 8

**Results:**

Modulation	Modulation scheme / bandwidth			
	5180 MHz	5320 MHz	5745 MHz	5825 MHz
Frequency	6 Mbit/s	6 Mbit/s	6 Mbit/s	6 Mbit/s
OFDM / a – mode	MCS0	MCS0	MCS0	MCS0
OFDM / n/ac HT20 – mode	5190 MHz	5310 MHz	5755 MHz	5815 MHz
OFDM / n/ac HT40 – mode	MCS0	MCS0	MCS0	MCS0

## 11.2 Gain

### Limits:

Antenna Gain
6 dBi / > 6 dBi output power and power density reduction required

### Results:

<b>OFDM</b> Band 5150 MHz to 5250 MHz	Lowest 5180 MHz	Lowest 5200 MHz	Highest 5240 MHz
Conducted power [dBm] Measured in a-mode	2.1	2.2	2.4
Radiated power [dBm] Measured in a-mode	17.2	17.0	17.0
Gain [dBi] Declared by manufacturer	0.0	0.0	0.0
mismatch correction factor [dB] Calculated	15.1	14.8	14.6

<b>OFDM</b> Band 5250 MHz to 5350 MHz	Lowest 5260 MHz	Lowest 5280 MHz	Highest 5320 MHz
Conducted power [dBm] Measured in a-mode	2.9	2.7	2.6
Radiated power [dBm] Measured in a-mode	17.3	17.3	17.4
Gain [dBi] Declared by manufacturer	0.0	0.0	0.0
mismatch correction factor [dB] Calculated	14.4	14.6	14.8

<b>OFDM</b> Band 5725 MHz to 5850 MHz	Lowest 5745 MHz	Middle 5785 MHz	Highest 5825 MHz
Conducted power [dBm] Measured in a-mode	3.9	4.7	4.8
Radiated power [dBm] Measured in a-mode	12.5	12.9	13.1
Gain [dBi] Declared by manufacturer	0.0	0.0	0.0
mismatch correction factor [dB] Calculated	8.6	8.2	8.3

### 11.3 Duty cycle

**Description:**

The duty cycle is necessary to compute the maximum power during an actual transmission. The shown plots and values are to show an example of the measurement procedure. The real value is measured direct during the power measurement or power density measurement. The correction value is shown in each plot of these measurements.

**Measurement:**

Measurement parameter	
According to: KDB789033 D02, B.	
Detector:	Peak
Sweep time:	Auto
Resolution bandwidth:	10 MHz
Video bandwidth:	10 MHz
Span:	Zero
Trace mode:	Video trigger / view / single sweep

**Results:**

**Duty cycle and correction factor:**

OFDM / a – mode:                    100 % duty cycle            =>    0.0 dB  
 OFDM / n/ac HT20 – mode:       100 % duty cycle            =>    0.0 dB  
 OFDM / n/ac HT40 – mode:       100 % duty cycle            =>    0.0 dB

**11.4 Maximum output power**

**11.4.1 Maximum output power conducted – for FCC requirements**

**Description:**

Measurement of the maximum output power conducted

**Measurement:**

Measurement parameter	
According to: KDB789033 D02, E.2.e.	
Detector:	RMS
Sweep time:	$\geq 10^* (\text{swp points}) * (\text{total on/off time})$
Resolution bandwidth:	1 MHz
Video bandwidth:	3 MHz
Span:	> EBW
Trace mode:	Max hold
Analyzer function	Band power / channel power Interval > 26 dB EBW
Used test setup:	See chapter 6.5 – A
Measurement uncertainty:	See chapter 8

**Limits:**

Radiated output power	Conducted output power for mobile equipment
Conducted power + 6 dBi antenna gain	250mW 5.150-5.250 GHz The lesser one of 250mW or 11 dBm + 10 log Bandwidth 5.250-5.350 GHz 250mW or 11 dBm + 10 log Bandwidth 5.470-5.725 GHz (where Bandwidth is the 26dB Bandwidth [MHz]) 1W 5.725-5.85 GHz

**Result:** OFDM / a – mode

OFDM / a – mode	Maximum output power conducted [dBm] incl. mismatch correction factor				
	Channel	5180 MHz	5240 MHz	5260 MHz	5320 MHz
		16.4	15.6	16.0	16.1
Channel	5745 MHz	5785 MHz	5825 MHz		
		10.2	11.1	11.8	

**Result:** OFDM / n/ac HT20 – mode

OFDM / n/ac HT20 – mode	Maximum output power conducted [dBm] incl. mismatch correction factor				
	Channel	5180 MHz	5240 MHz	5260 MHz	5320 MHz
		15.8	14.7	15.0	15.2
Channel	5745 MHz	5785 MHz	5825 MHz		
		9.8	10.2	11.4	

**Result:** OFDM / n/ac HT40 – mode

OFDM / n/ac HT40 – mode	Maximum output power conducted [dBm] incl. mismatch correction factor				
	Channel	5190 MHz	5230 MHz	5270 MHz	5310 MHz
		14.3	13.2	13.5	13.4
Channel	5755 MHz	5795 MHz			
		7.9	8.0		



**Plots:** OFDM / a – mode

**Plot 1:** 5180 MHz

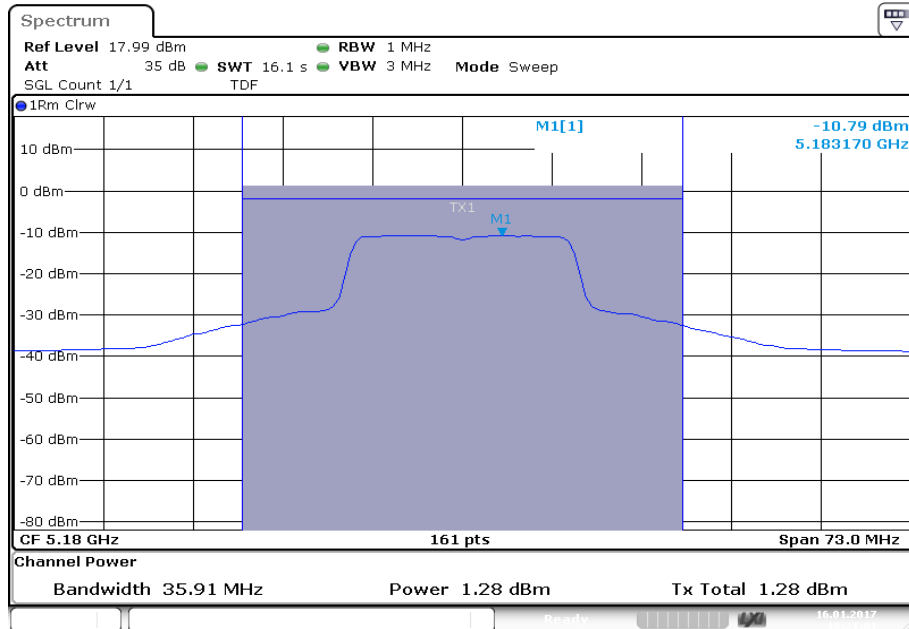

Date: 16.JAN.2017 18:21:02

**Plot 2:** 5240 MHz

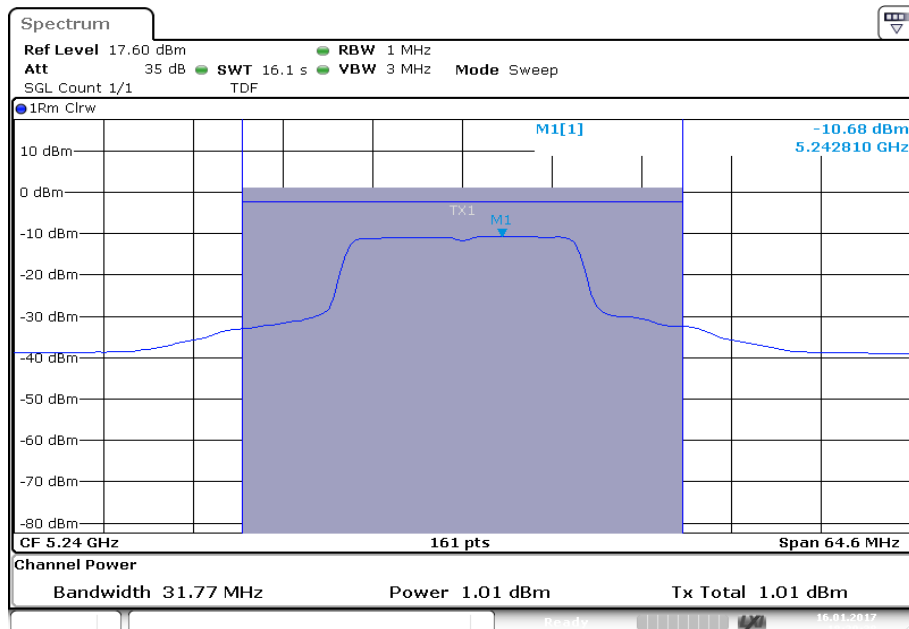

Date: 16.JAN.2017 18:29:39

Plot 3: 5260 MHz

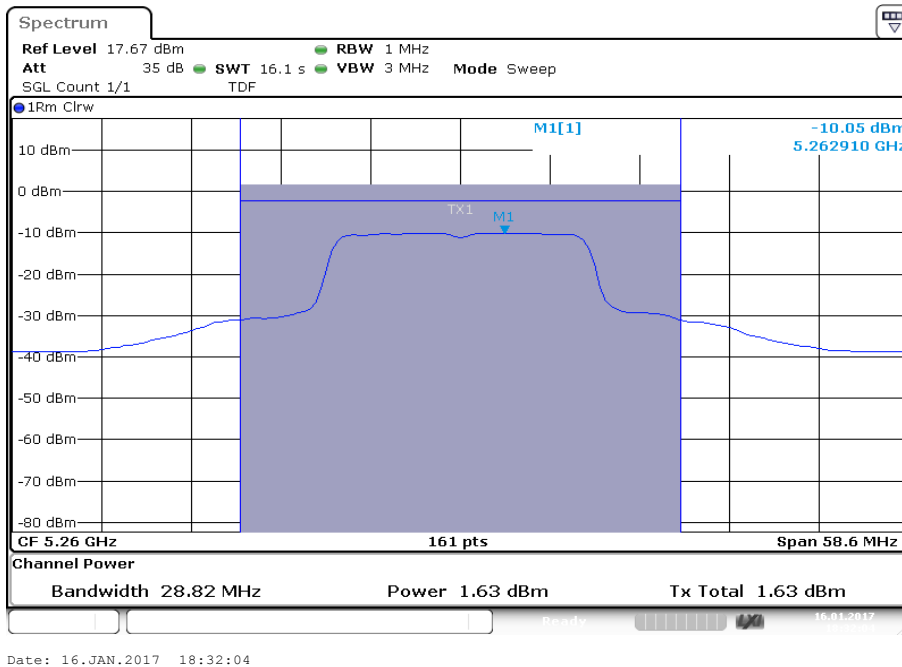

Plot 4: 5320 MHz

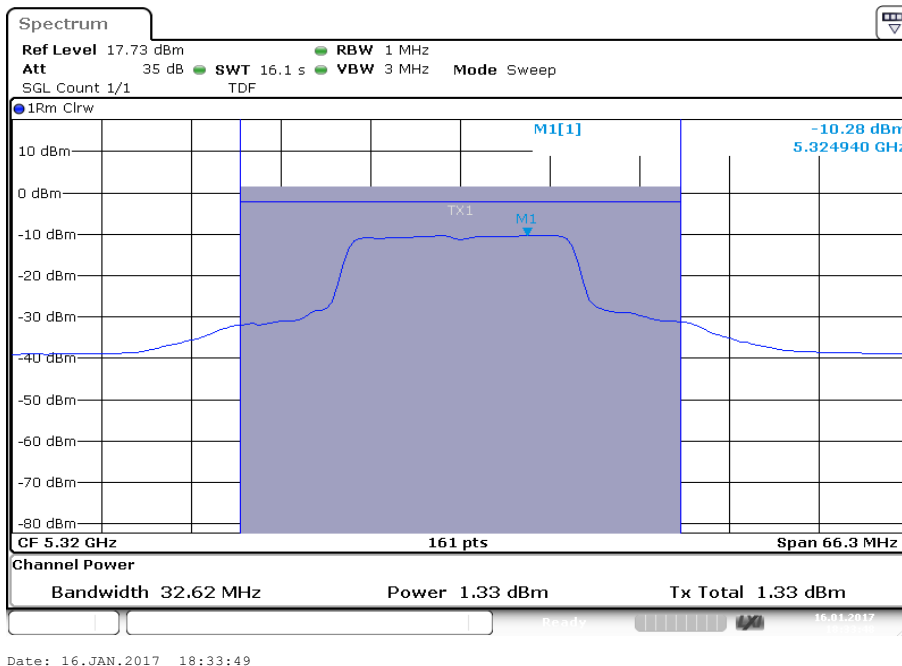

Plot 5: 5745 MHz

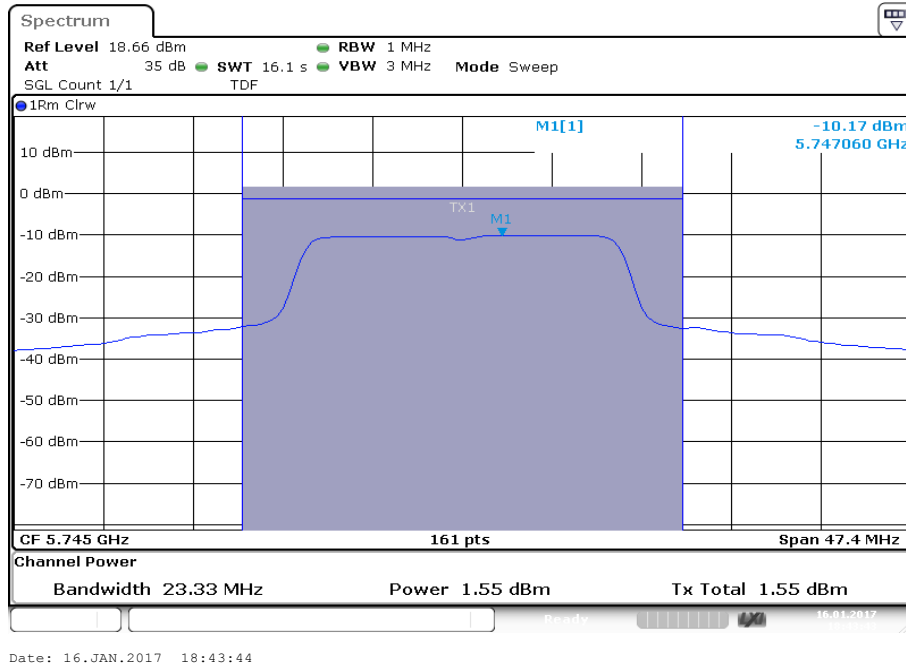

Plot 6: 5785 MHz

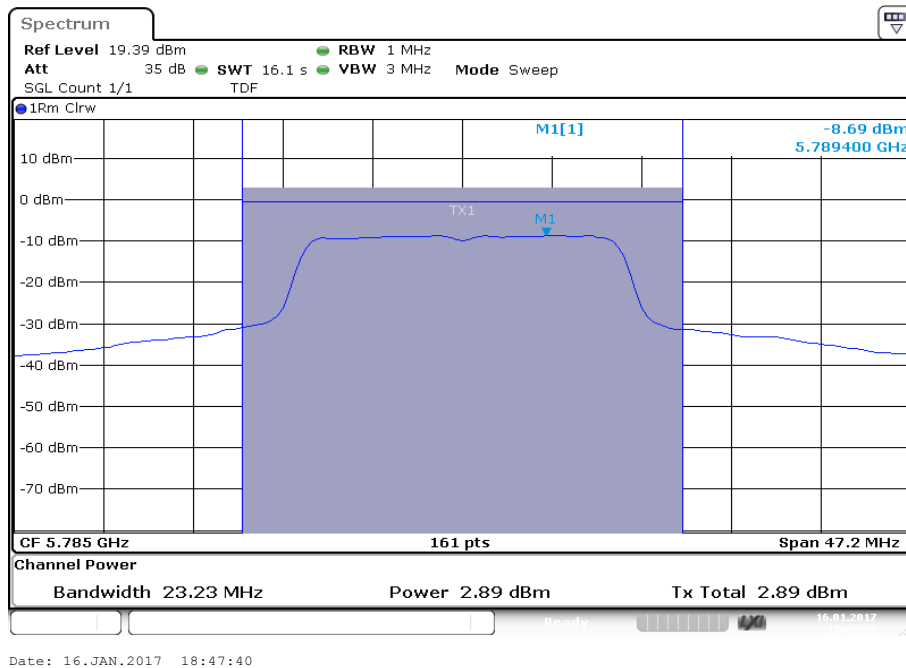

Plot 7: 5825 MHz

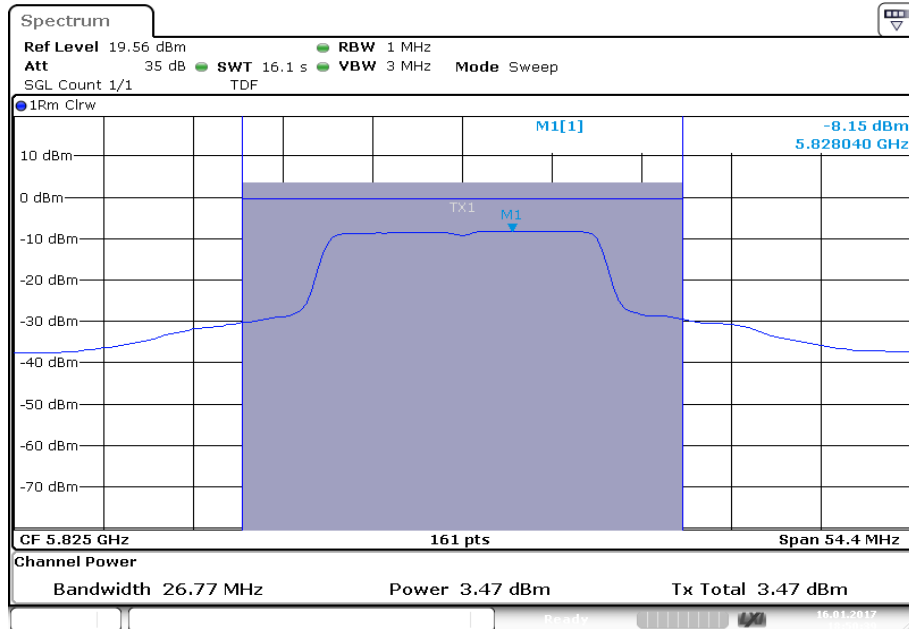

Date: 16.JAN.2017 18:50:40

**Plots:** OFDM / n/ac HT20 – mode

**Plot 1:** 5180 MHz

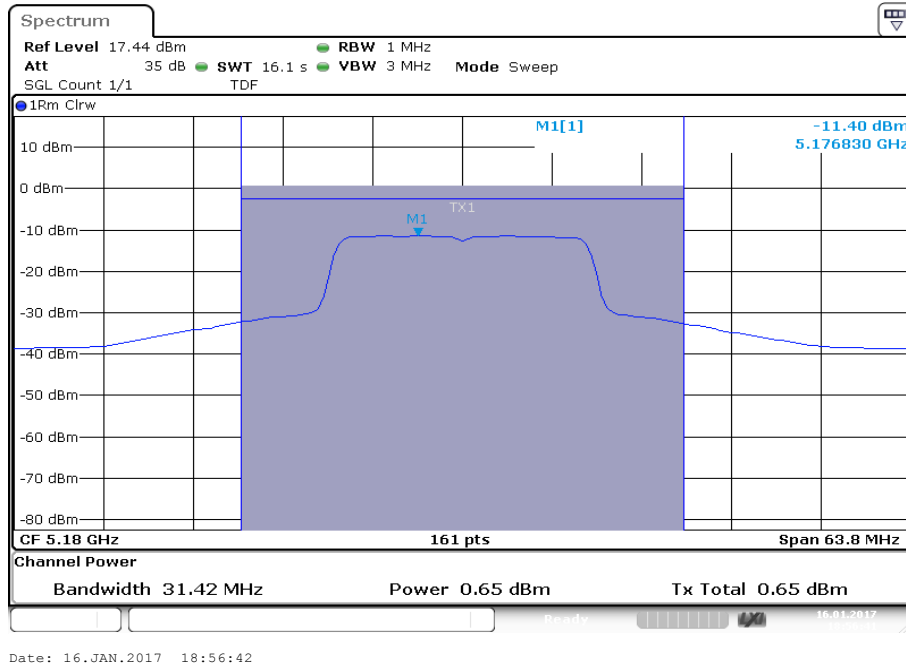

**Plot 2:** 5240 MHz

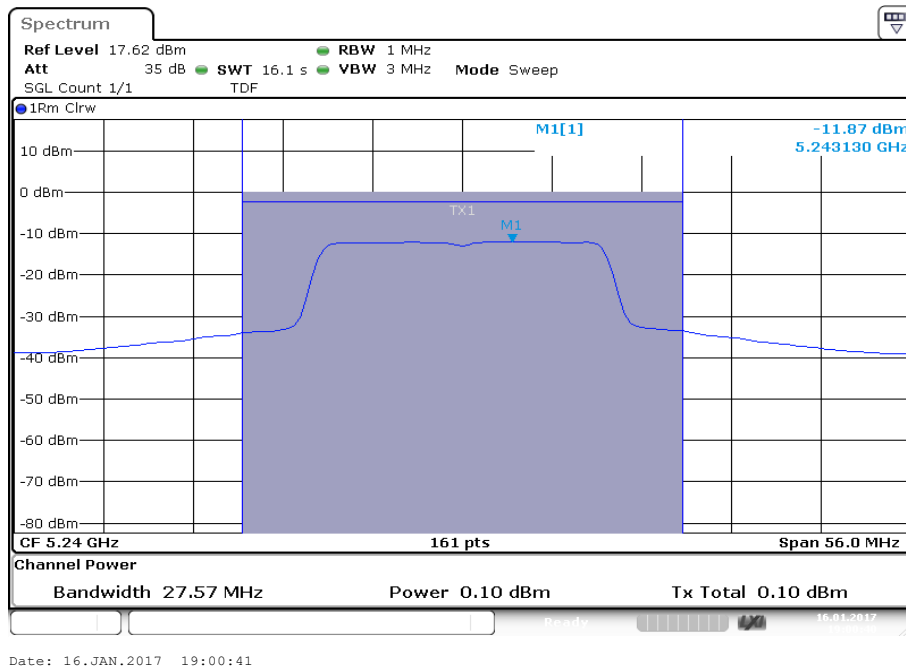

Plot 3: 5260 MHz

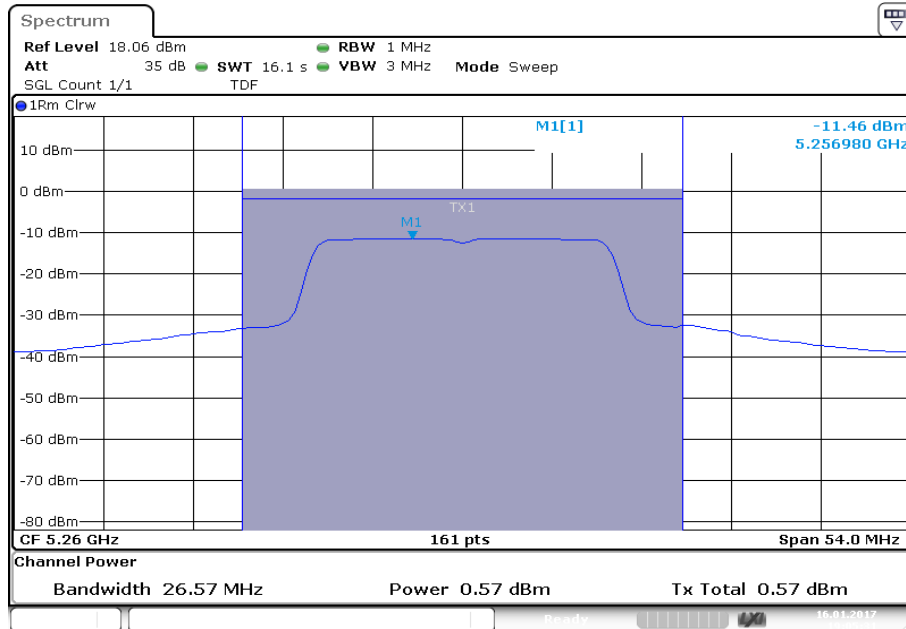

Plot 4: 5320 MHz

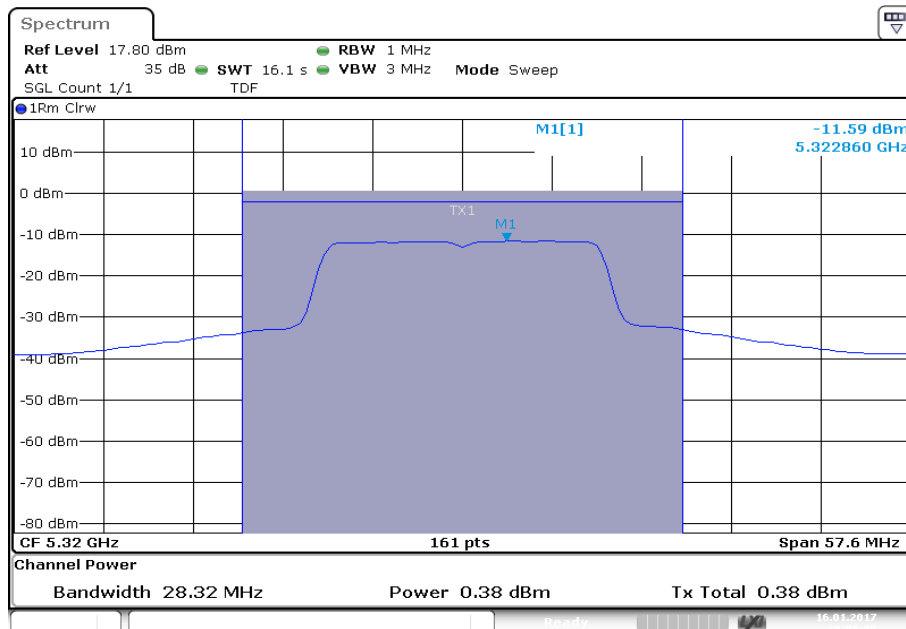

Plot 5: 5745 MHz

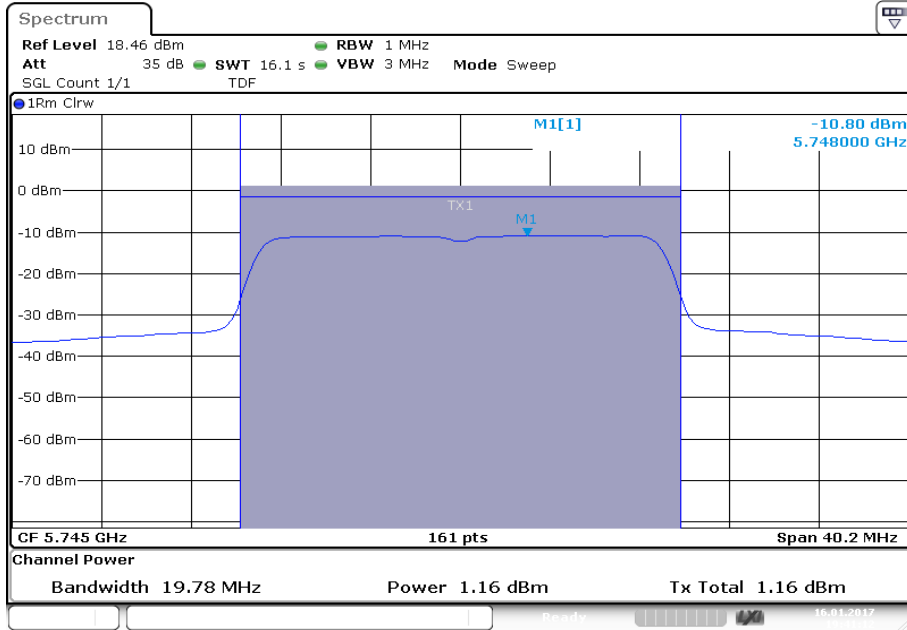

Date: 16.JAN.2017 19:41:12

Plot 6: 5785 MHz

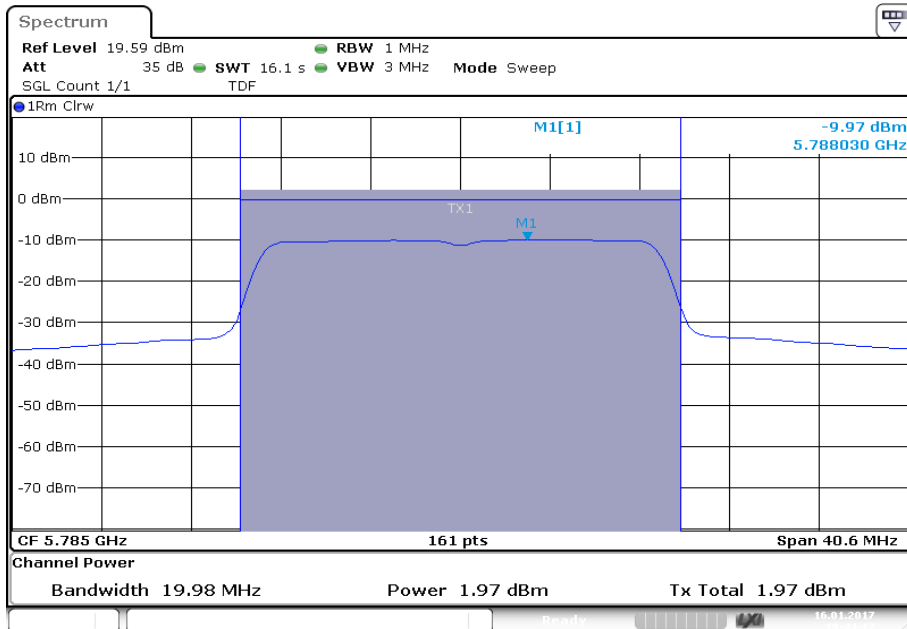

Date: 16.JAN.2017 19:44:18

Plot 7: 5825 MHz

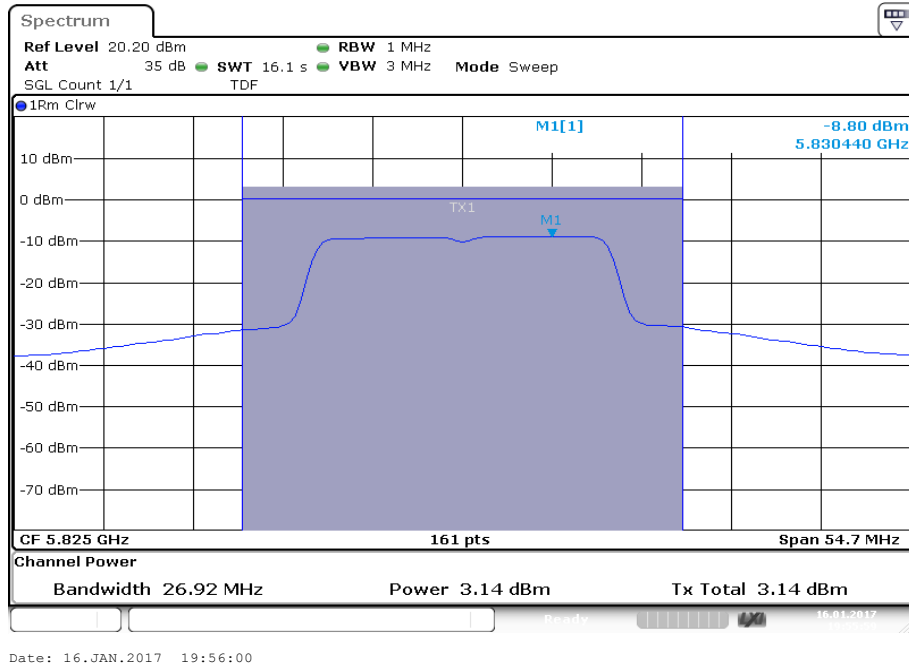



**Plots:** OFDM / n/ac HT40 – mode

**Plot 1:** 5190 MHz

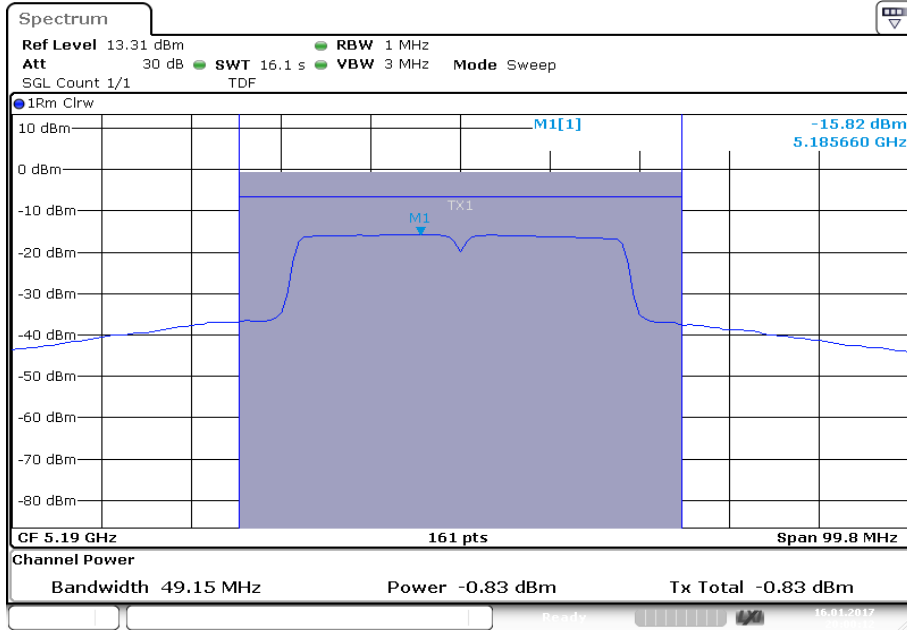

Date: 16.JAN.2017 20:00:13

**Plot 2:** 5230 MHz

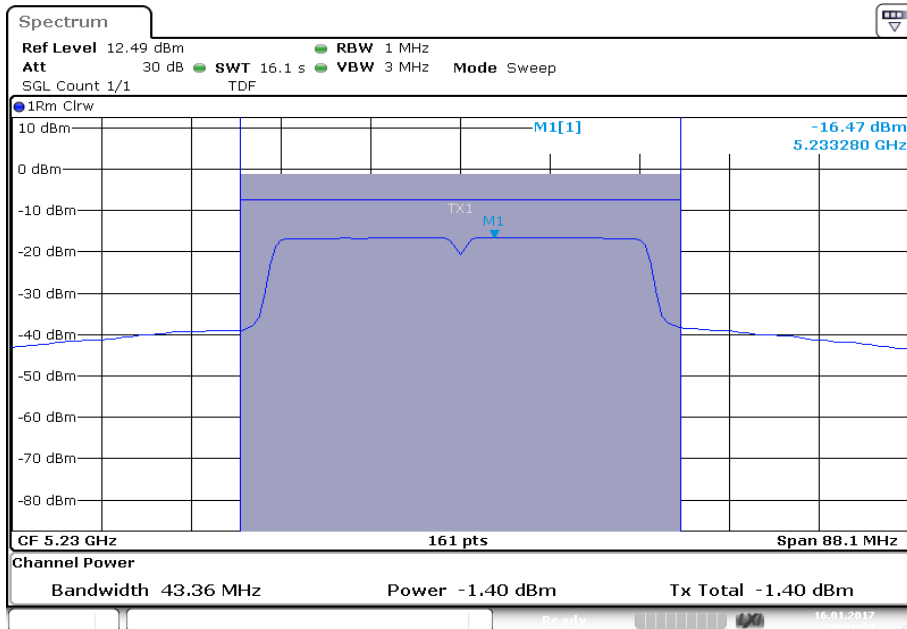

Date: 16.JAN.2017 20:01:55

Plot 3: 5270 MHz

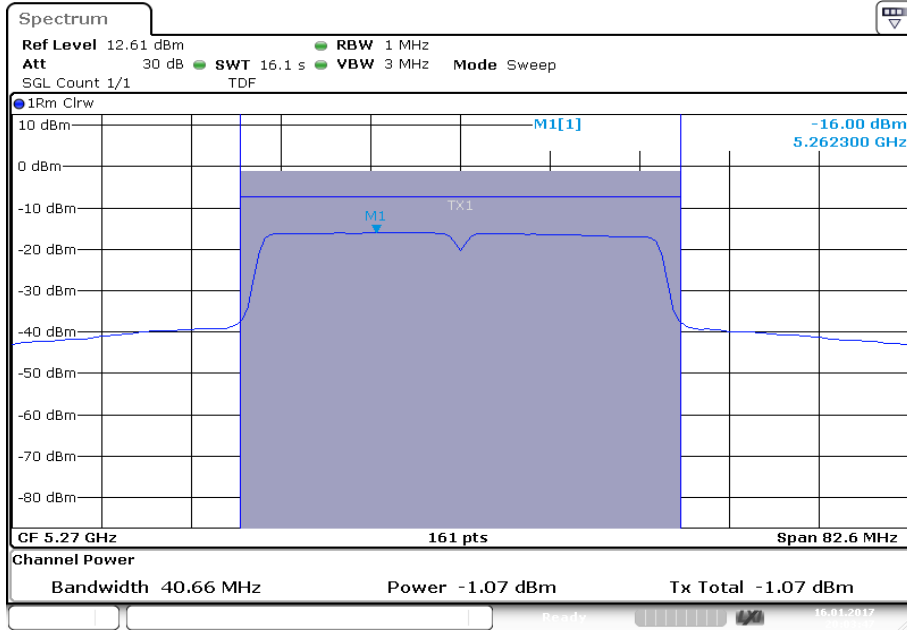

Date: 16.JAN.2017 20:03:48

Plot 4: 5310 MHz

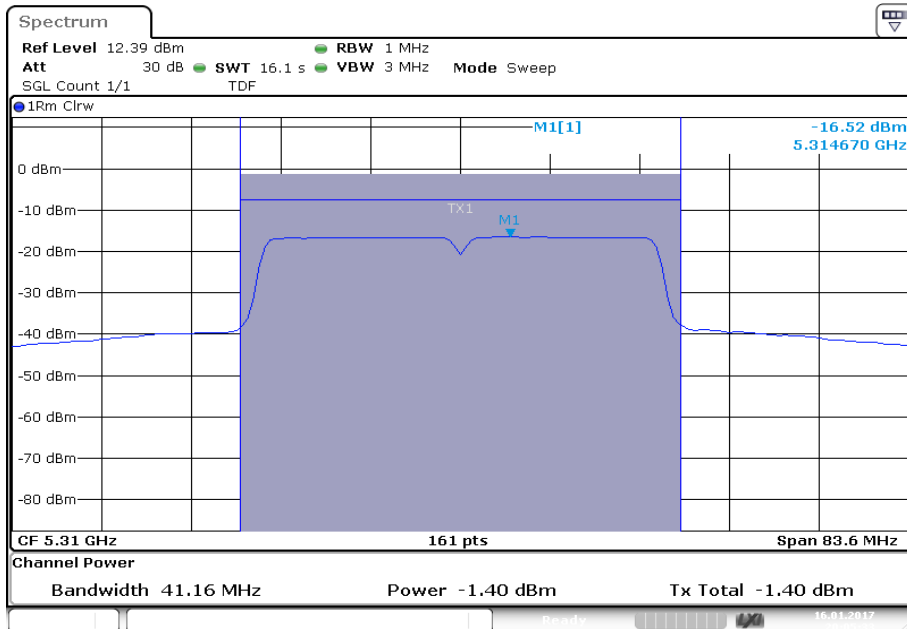

Date: 16.JAN.2017 20:05:34

Plot 5: 5755 MHz

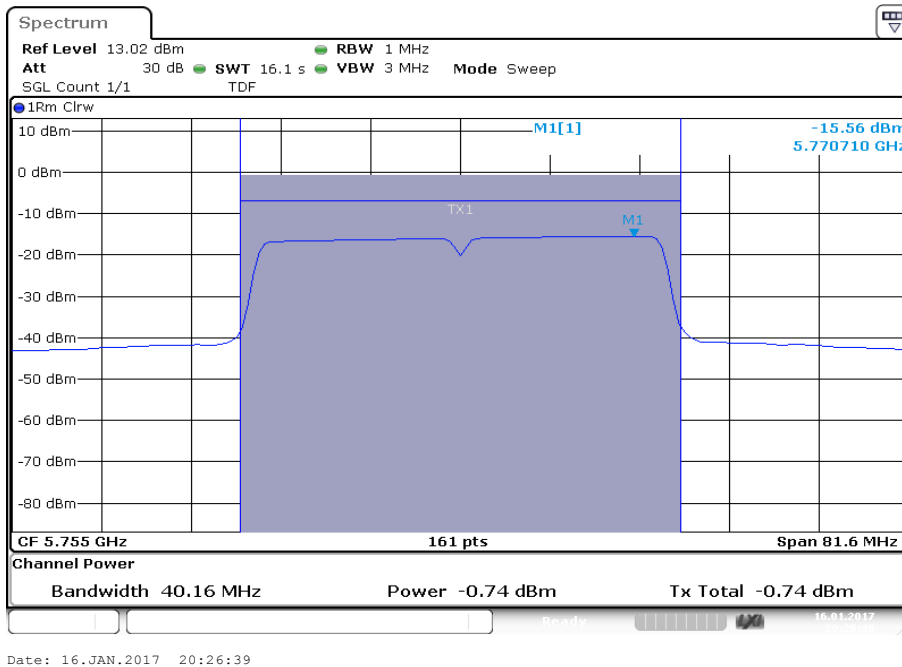

Plot 6: 5795 MHz

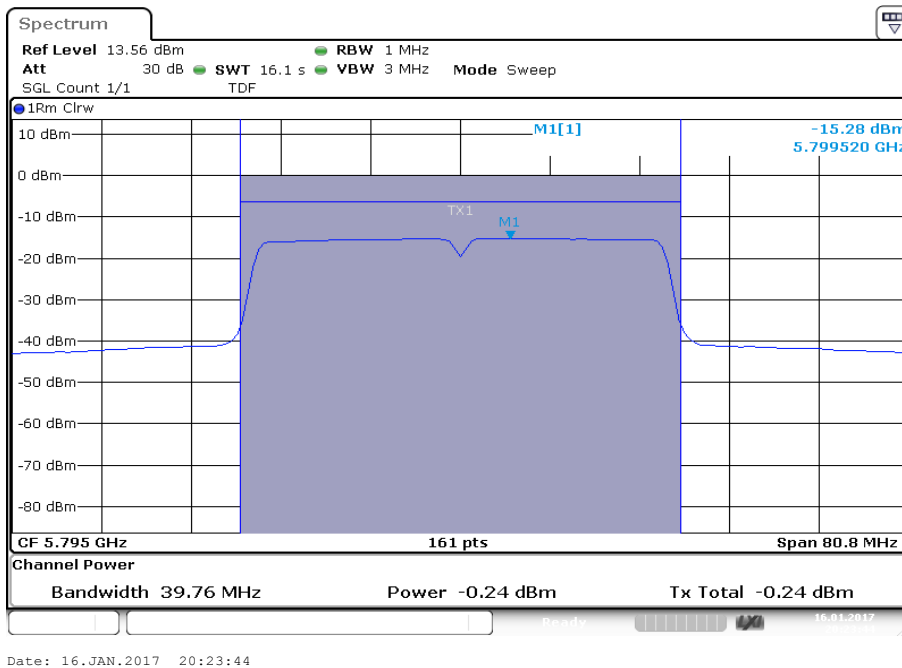

### 11.4.2 Maximum output power – for IC requirements

**Description:**

Measurement of the maximum output power conducted + radiated

**Measurement:**

Measurement parameter	
Detector:	RMS
Sweep time:	$\geq 10 * (\text{swp points}) * (\text{total on/off time})$
Resolution bandwidth:	1 MHz
Video bandwidth:	$\geq 3$ MHz
Span:	> EBW
Trace mode:	Max hold
Analyzer function	Band power / channel power Interval > 99% OBW
Used test setup:	See chapter 6.5 – A
Measurement uncertainty:	See chapter 8

**Limits:**

Radiated output power	Conducted output power for mobile equipment
The lesser one of 200 mW or 10 dBm + 10 log Bandwidth 5.150-5.250 GHz 1 W or 17 dBm + 10 log Bandwidth 5.250-5.350 GHz 1 W or 17 dBm + 10 log Bandwidth 5.470-5.725 GHz (where Bandwidth is the 99% Bandwidth [MHz]) Conducted power + 6dBi antenna gain 5.725-5.825 GHz	The lesser one of 250mW or 11 dBm + 10 log Bandwidth 5.250-5.350 GHz 250mW or 11 dBm + 10 log Bandwidth 5.470-5.725 GHz (where Bandwidth is the 99% Bandwidth [MHz]) 1W 5.725-5.825 GHz

**Result:** OFDM / a – mode

OFDM / a – mode	Maximum output power conducted [dBm] incl. mismatch correction factor			
	5180 MHz	5240 MHz	5260 MHz	5320 MHz
Channel	5180 MHz	5240 MHz	5260 MHz	5320 MHz
Including duty cycle correction factor	16.3	15.6	16.0	16.2
Channel	5745 MHz	5785 MHz	5825 MHz	
Including duty cycle correction factor	10.1	11.2	11.7	

**Result:** OFDM / n/ac HT20 – mode

OFDM / n/ac HT20 – mode	Maximum output power conducted [dBm] incl. mismatch correction factor			
	5180 MHz	5240 MHz	5260 MHz	5320 MHz
Channel	5180 MHz	5240 MHz	5260 MHz	5320 MHz
Including duty cycle correction factor	15.7	14.7	15.0	15.2
Channel	5745 MHz	5785 MHz	5825 MHz	
Including duty cycle correction factor	9.8	10.1	11.4	

**Result:** OFDM / n/ac HT40 – mode

OFDM / n/ac HT40 – mode	Maximum output power conducted [dBm] incl. mismatch correction factor			
	5190 MHz	5230 MHz	5270 MHz	5310 MHz
Channel	5190 MHz	5230 MHz	5270 MHz	5310 MHz
Including duty cycle correction factor	14.2	13.2	13.3	13.4
Channel	5755 MHz	5795 MHz		
Including duty cycle correction factor	7.8	8.0		

**Plots:** OFDM / a – mode

**Plot 1:** 5180 MHz

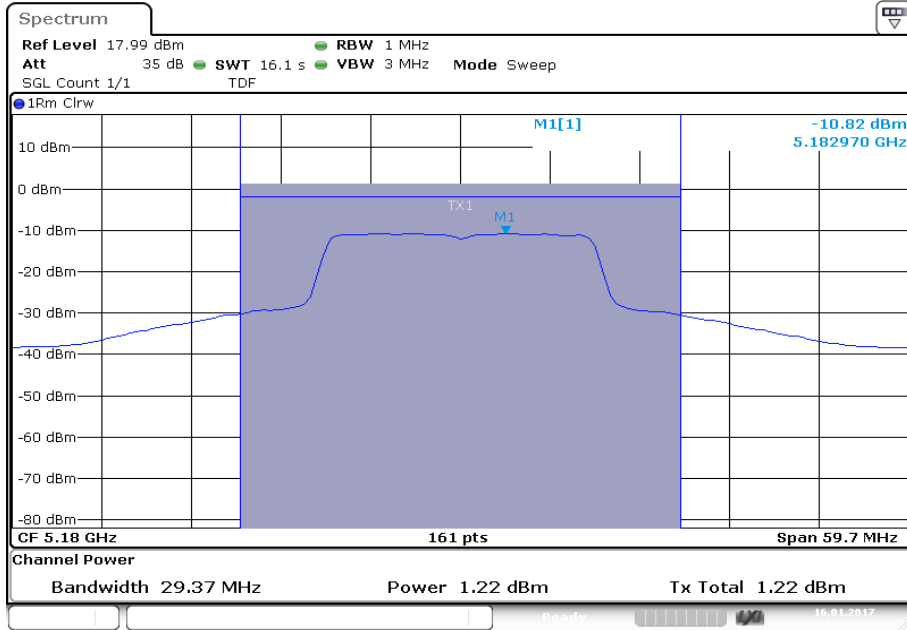

**Plot 2:** 5240 MHz

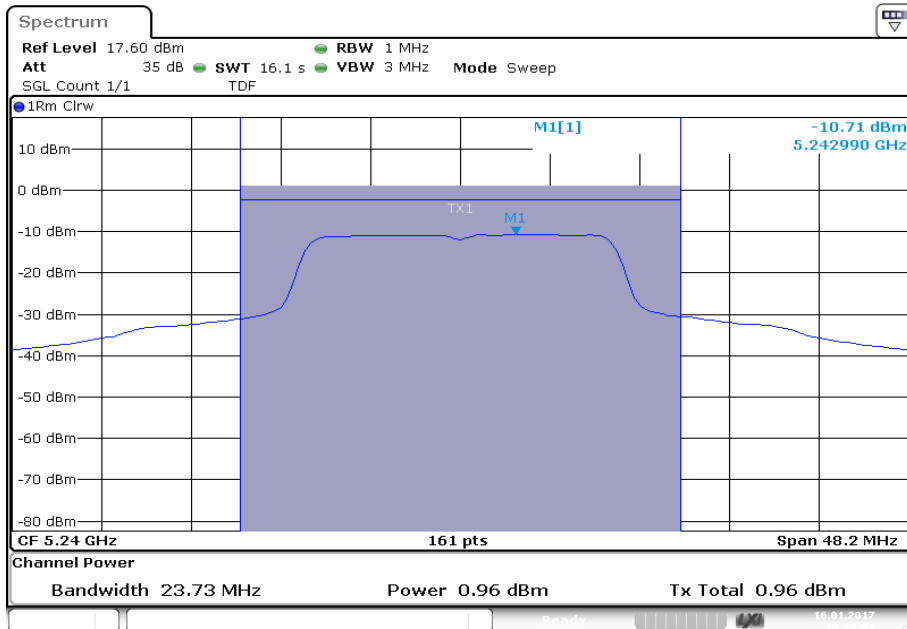

Plot 3: 5260 MHz

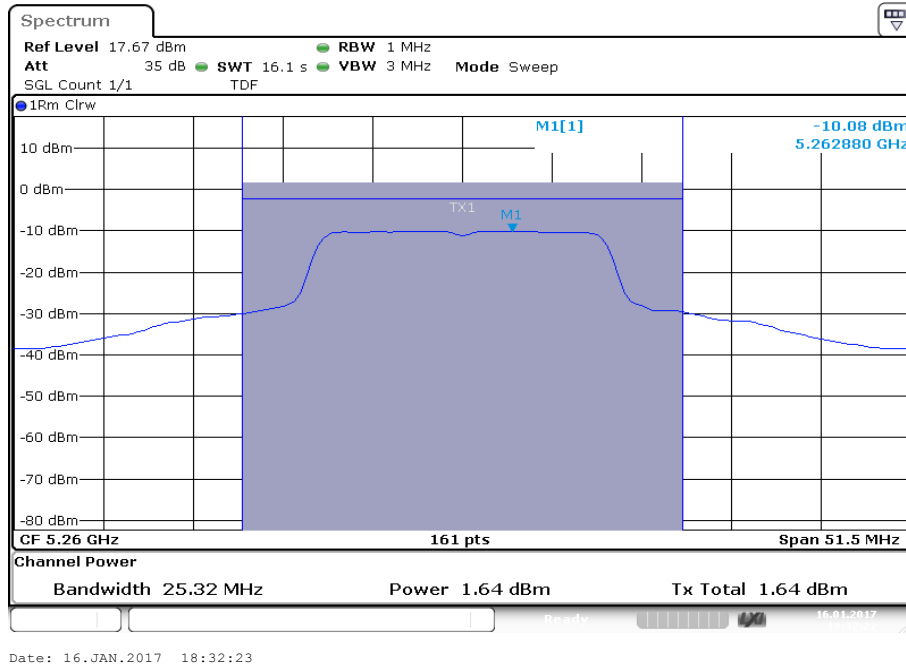

Plot 4: 5320 MHz

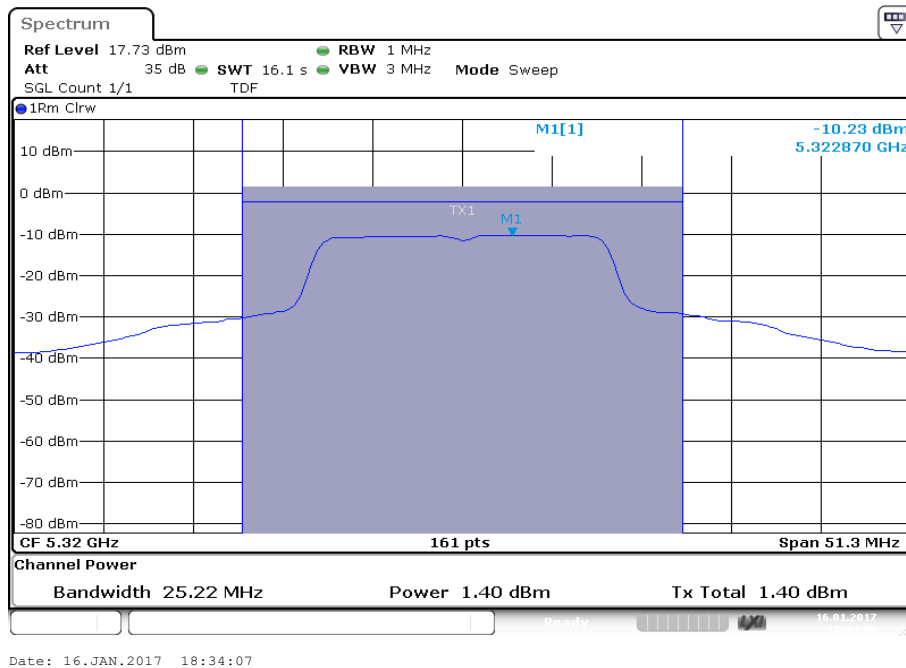

Plot 5: 5745 MHz

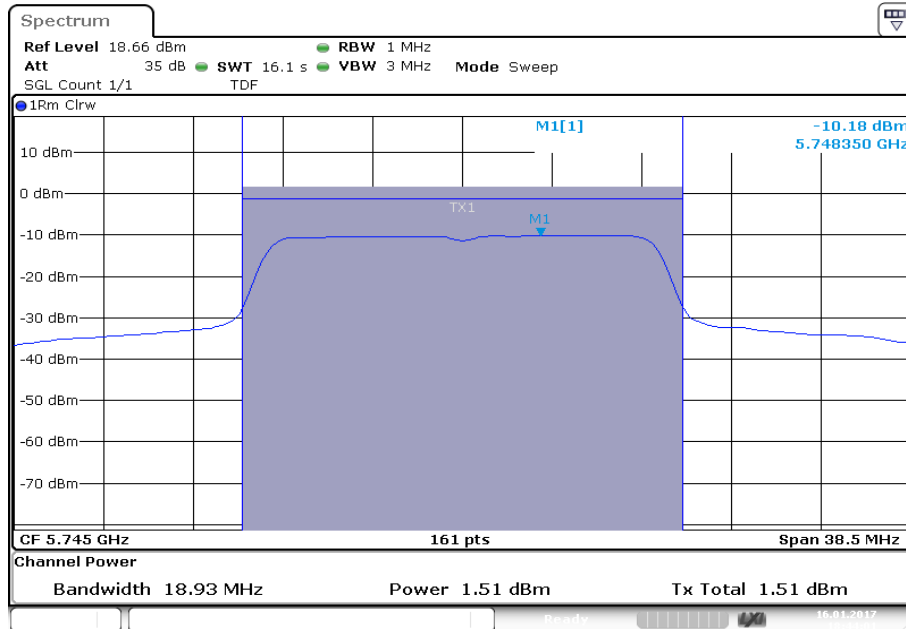

Plot 6: 5785 MHz

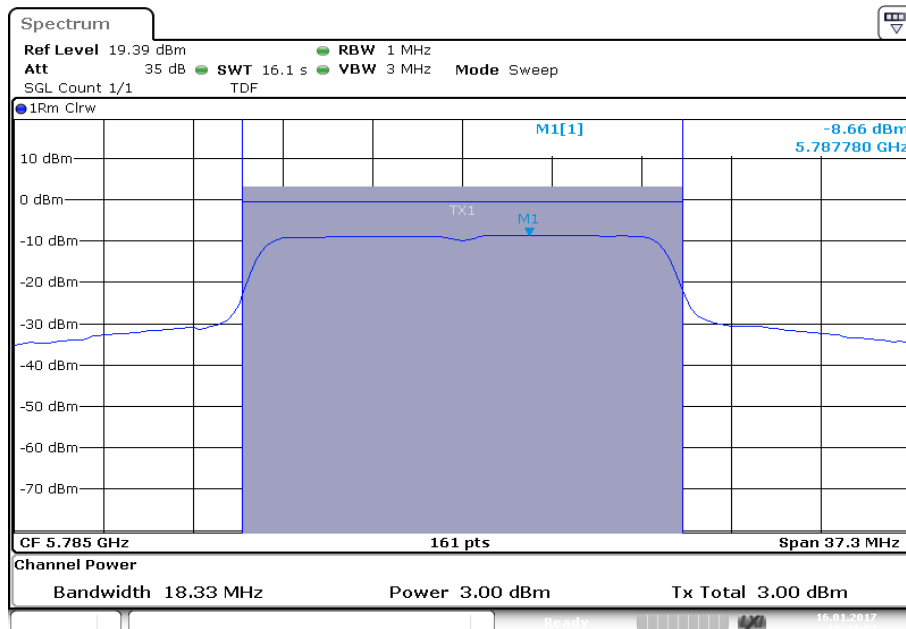



Plot 7: 5825 MHz

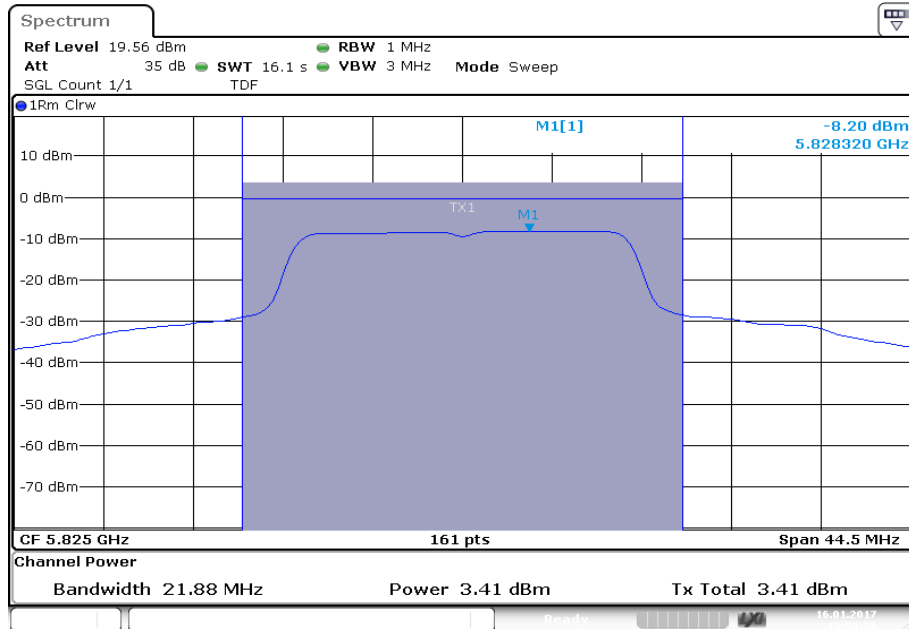

Date: 16.JAN.2017 18:50:58

**Plots:** OFDM / n/ac HT20 – mode

**Plot 1:** 5180 MHz

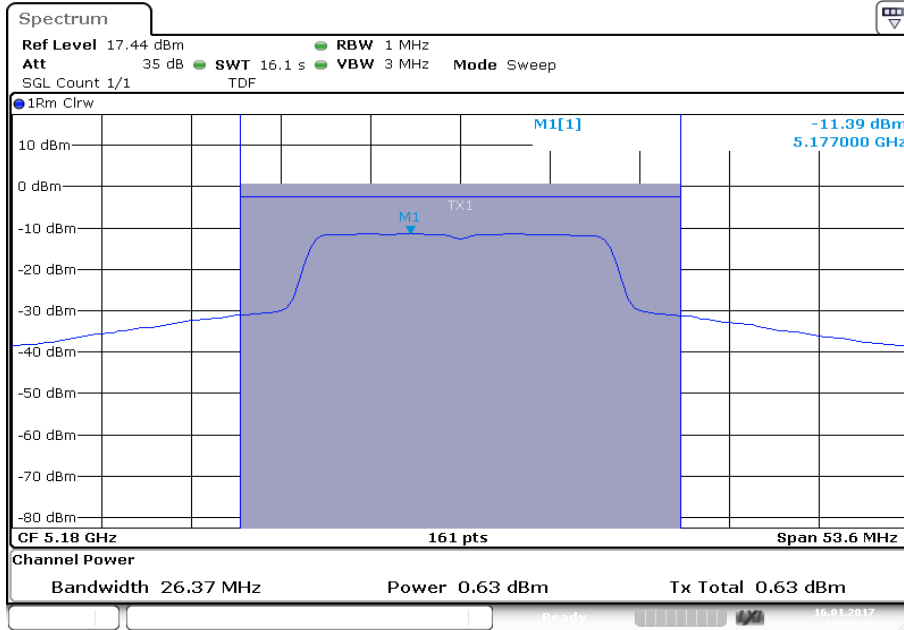

Date: 16.JAN.2017 18:57:00

**Plot 2:** 5240 MHz

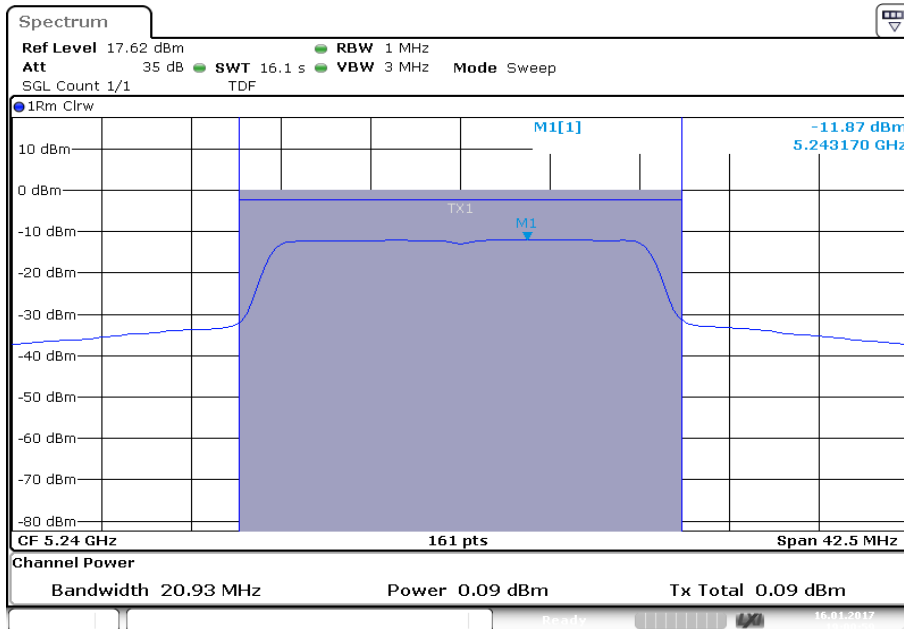

Date: 16.JAN.2017 19:01:00

Plot 3: 5260 MHz

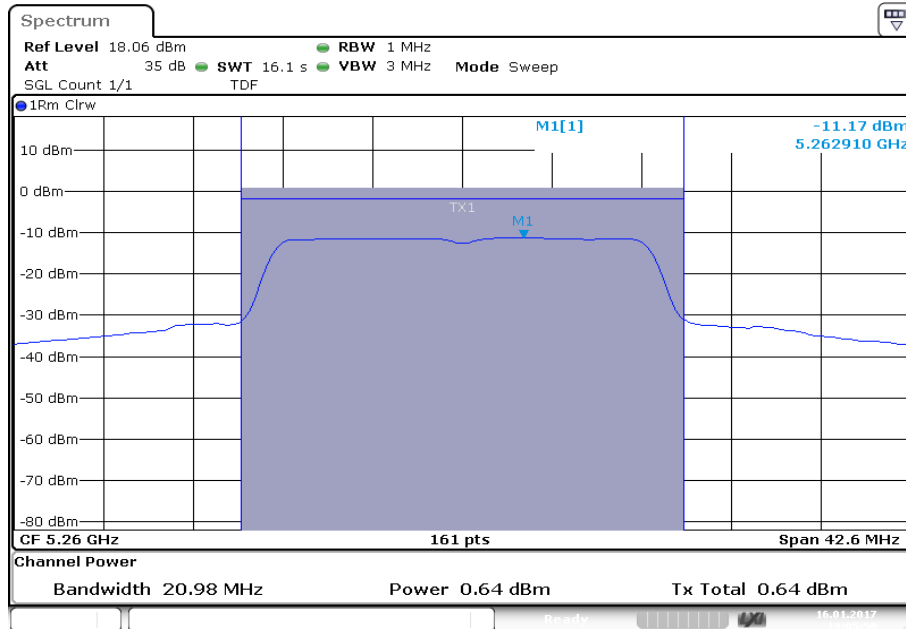

Plot 4: 5320 MHz

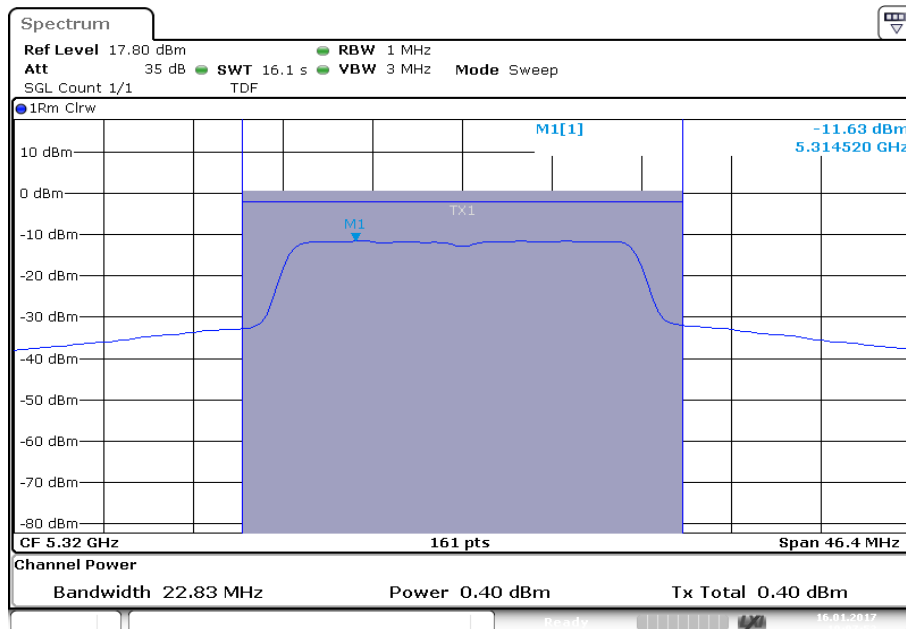

Plot 5: 5745 MHz

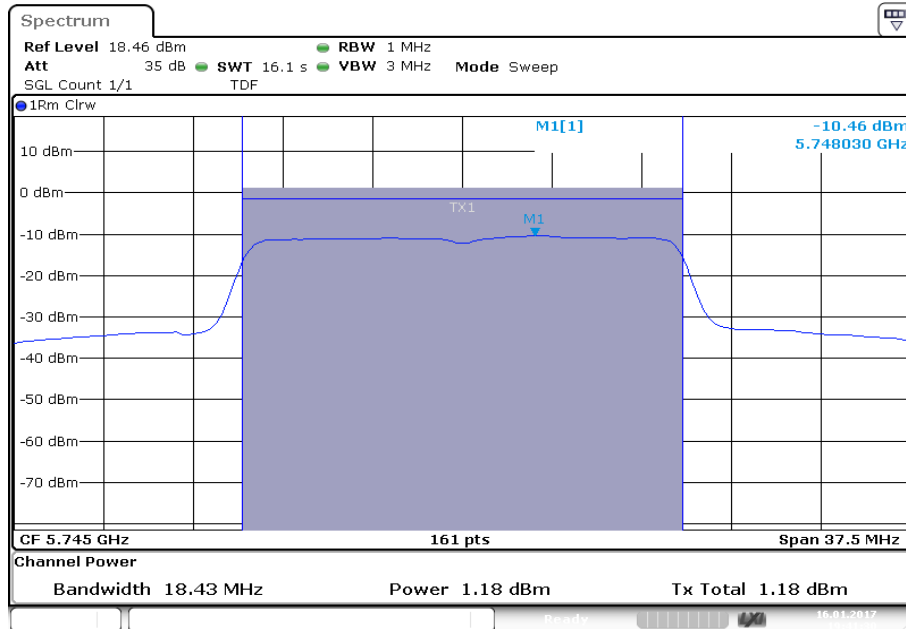

Date: 16.JAN.2017 19:41:31

Plot 6: 5785 MHz

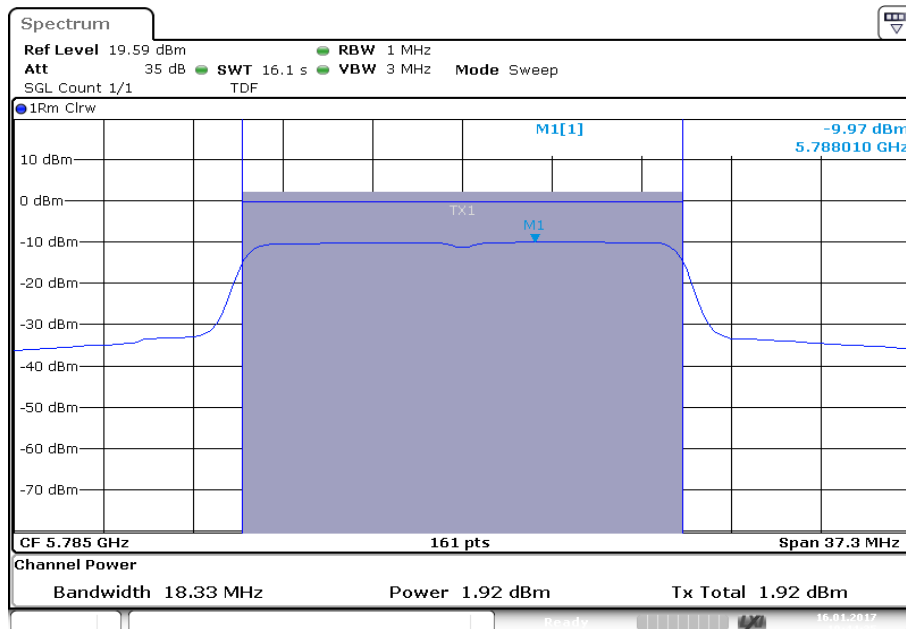

Date: 16.JAN.2017 19:44:36

Plot 7: 5825 MHz

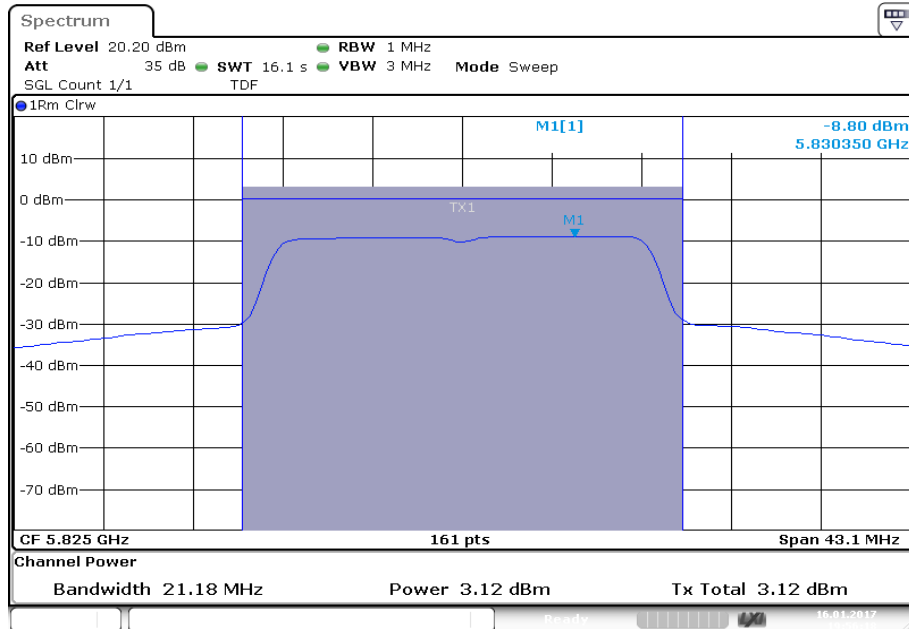

Date: 16.JAN.2017 19:56:19

**Plots:** OFDM / n/ac HT40 – mode

**Plot 1:** 5190 MHz

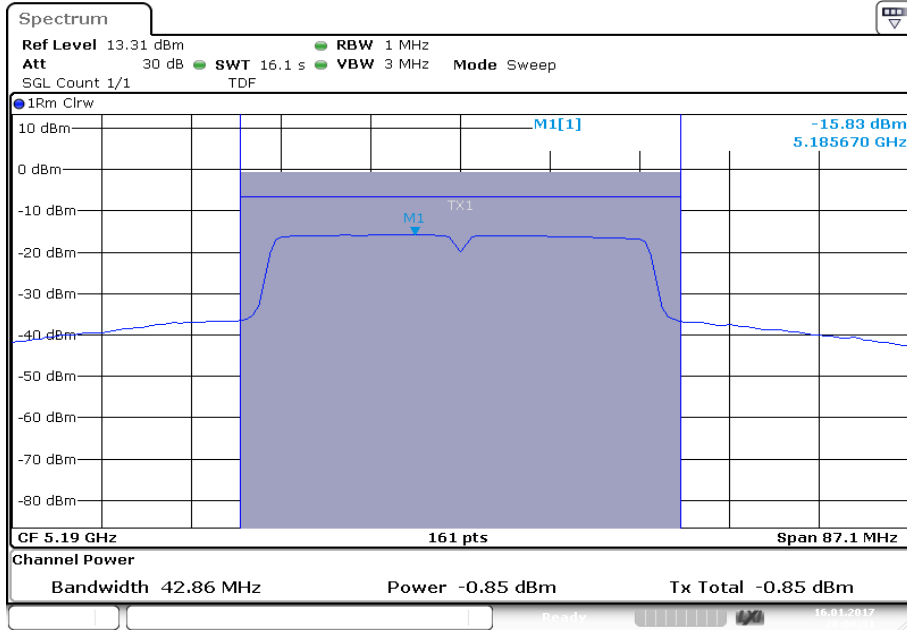

Date: 16.JAN.2017 20:00:31

**Plot 2:** 5230 MHz

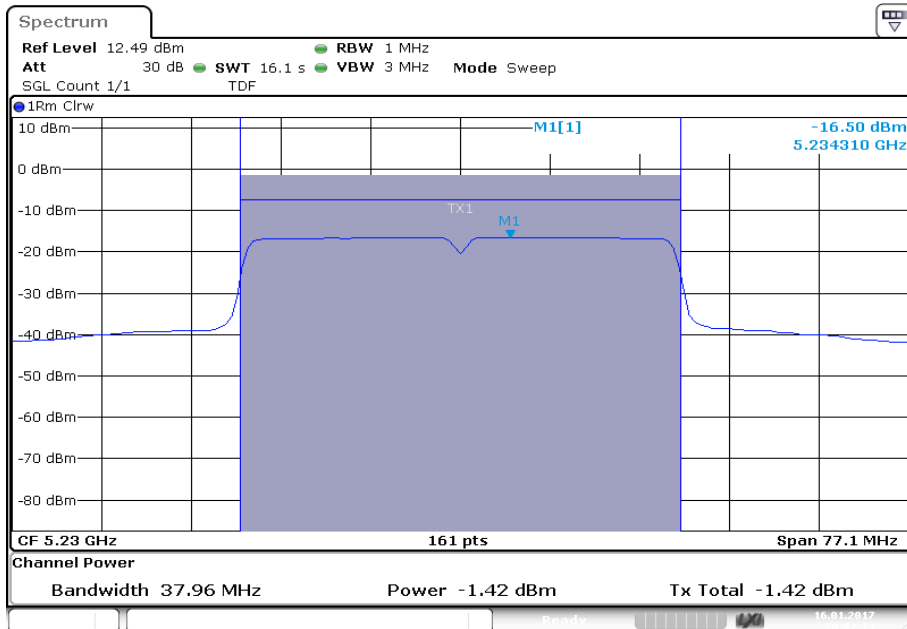

Date: 16.JAN.2017 20:02:14

Plot 3: 5270 MHz

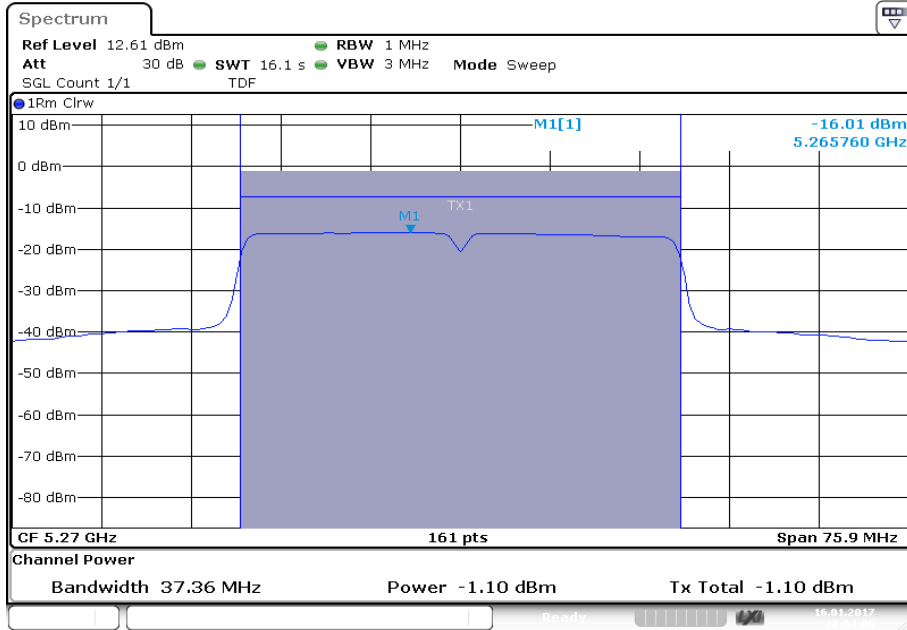

Plot 4: 5310 MHz

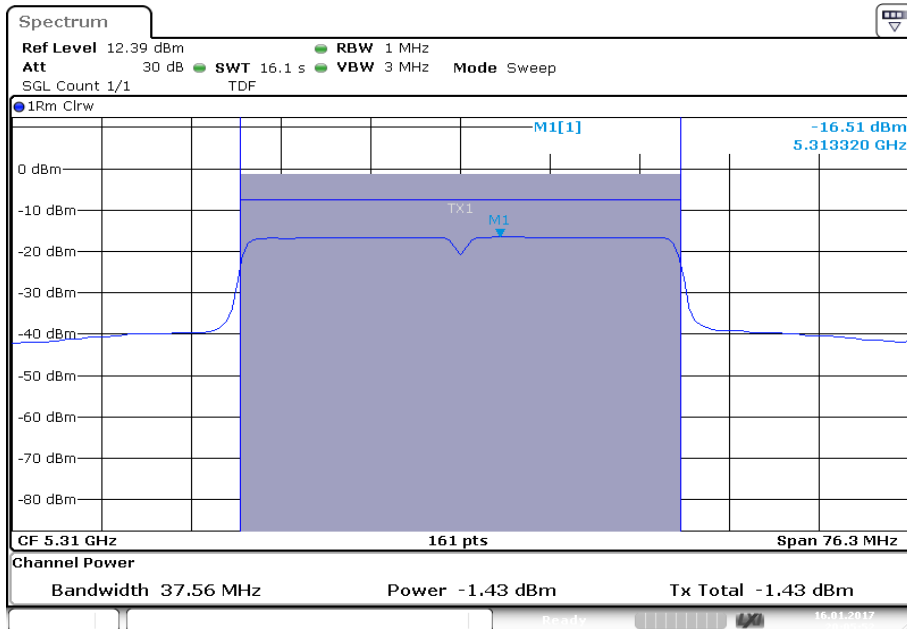

Plot 5: 5755 MHz

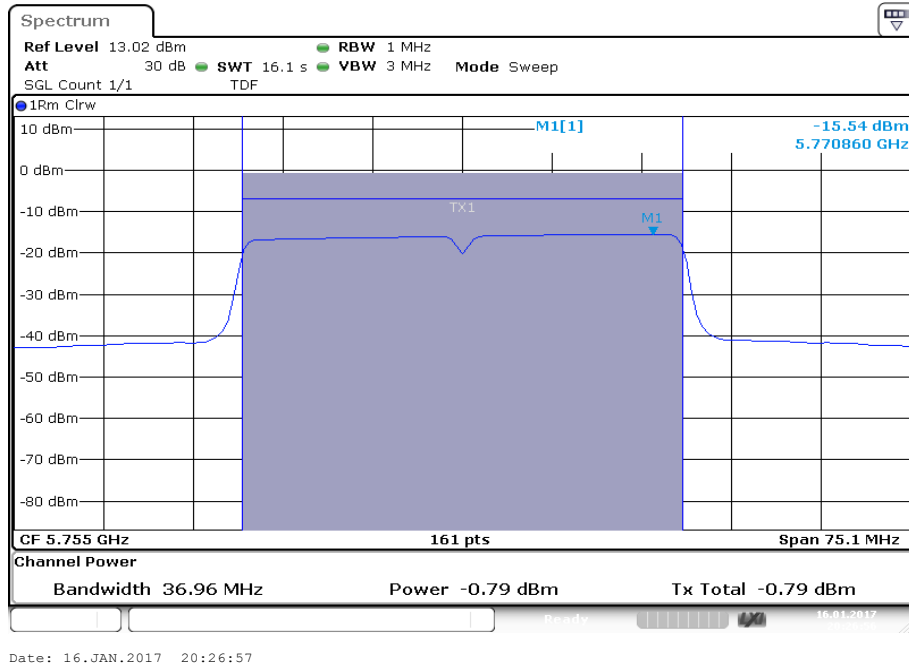

Plot 6: 5795 MHz

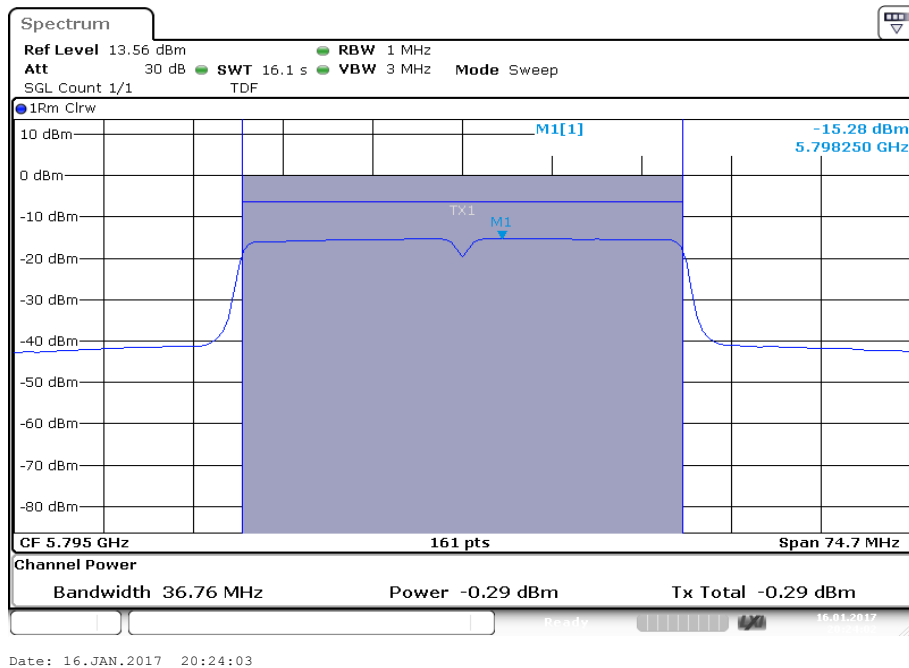



## 11.5 Power spectral density

### 11.5.1 Power spectral density – for FCC requirements

**Description:**

Measurement of the power spectral density of a digital modulated system. The measurement is repeated at the lowest, middle and highest channel.

**Measurement:**

Measurement parameter	
According to: KDB789033 D02, F.	
Detector:	RMS
Sweep time:	$\geq 10 * (\text{swp points}) * (\text{total on/off time})$
Resolution bandwidth:	1 MHz (500 kHz for 5.8 GHz band)
Video bandwidth:	$\geq 3 * \text{RBW}$
Span:	$> \text{EBW}$
Trace mode:	Max hold
Used test setup:	See chapter 6.5 – A
Measurement uncertainty:	See chapter 8

**Limits:**

Power Spectral Density
power spectral density conducted $\leq 11$ dBm in any 1 MHz band (band 5150 – 5250 MHz)
power spectral density conducted $\leq 11$ dBm in any 1 MHz band (band 5250 – 5350 MHz)
power spectral density conducted $\leq 11$ dBm in any 1 MHz band (band 5470 – 5725 MHz)
power spectral density conducted $\leq 30$ dBm in any 500 kHz band (band 5725 – 5850 MHz)

**Result:** OFDM / a – mode

OFDM / a – mode	Power spectral density [dBm/MHz] incl. mismatch correction factor			
Channel	5180 MHz	5240 MHz	5260 MHz	5320 MHz
	4.3	3.9	4.3	4.6
Channel	5745 MHz	5785 MHz	5825 MHz	
	-4.6	-3.5	-2.9	

**Result:** OFDM / n/ac HT20 – mode

OFDM / n/ac HT20 – mode	Power spectral density [dBm/MHz] incl. mismatch correction factor			
Channel	5180 MHz	5240 MHz	5260 MHz	5320 MHz
	3.7	2.7	2.9	3.2
Channel	5745 MHz	5785 MHz	5825 MHz	
	-4.8	-4.4	-3.5	

**Result:** OFDM / n/ac HT40 – mode

OFDM / n/ac HT40 – mode	Power spectral density [dBm/MHz] incl. mismatch correction factor			
Channel	5190 MHz	5230 MHz	5270 MHz	5310 MHz
	-0.7	-1.9	-1.6	-1.7
Channel	5755 MHz	5795 MHz		
	-10.0	-10.1		

The plots for the band 5150 MHz to 5350 MHz can be found in chapter 11.4.1“Output power”.

**Plots:** OFDM / a – mode

**Plot 1:** 5745 MHz

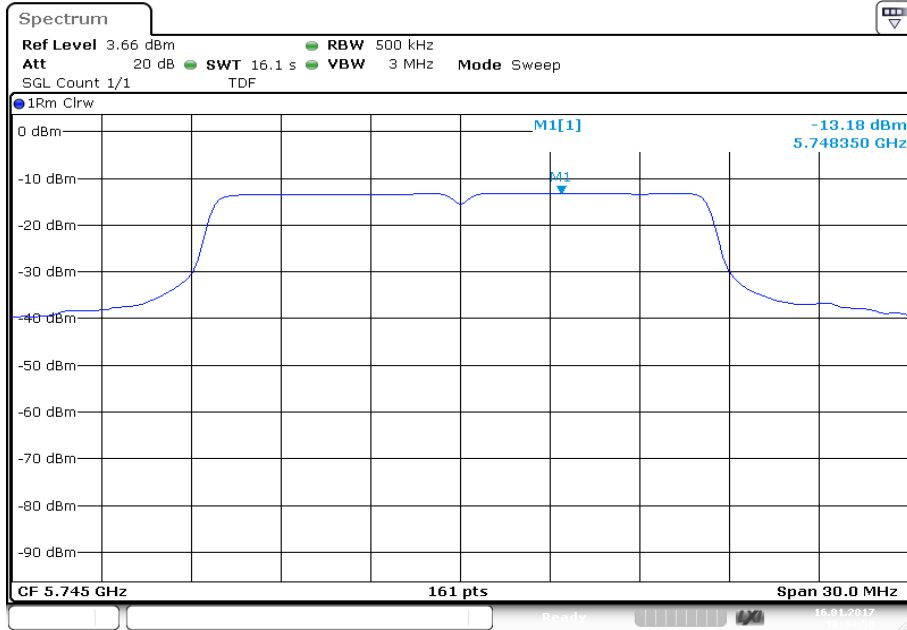

Date: 16.JAN.2017 18:44:51

**Plot 2:** 5785 MHz

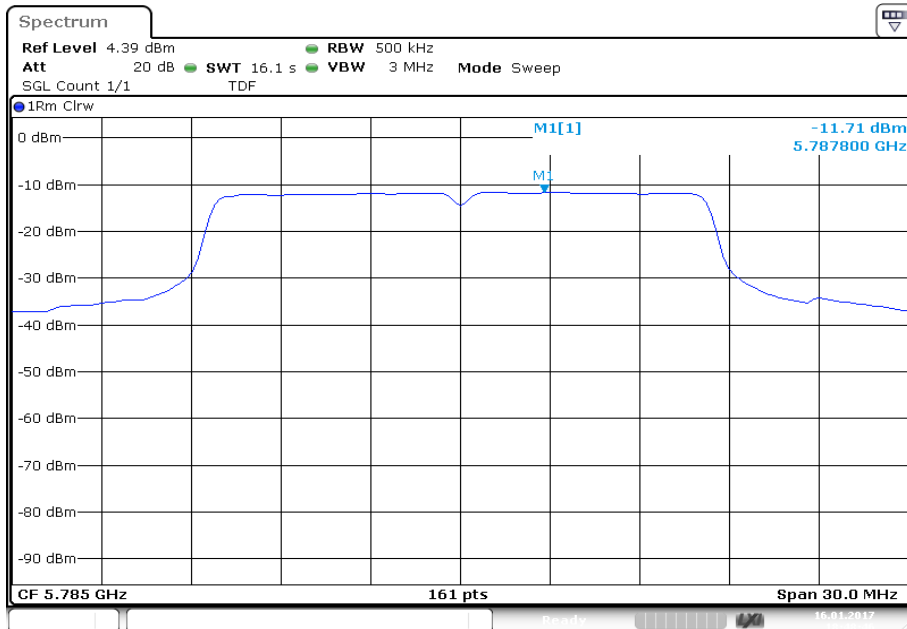

Date: 16.JAN.2017 18:48:46

Plot 3: 5825 MHz

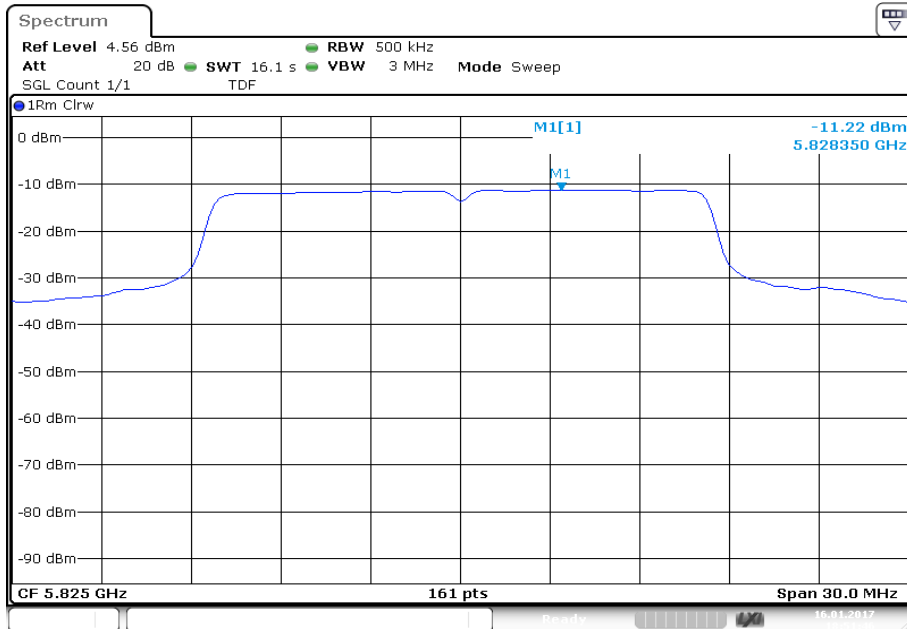

Date: 16.JAN.2017 18:51:47

**Plots:** OFDM / n/ac HT20 – mode

**Plot 1:** 5745 MHz

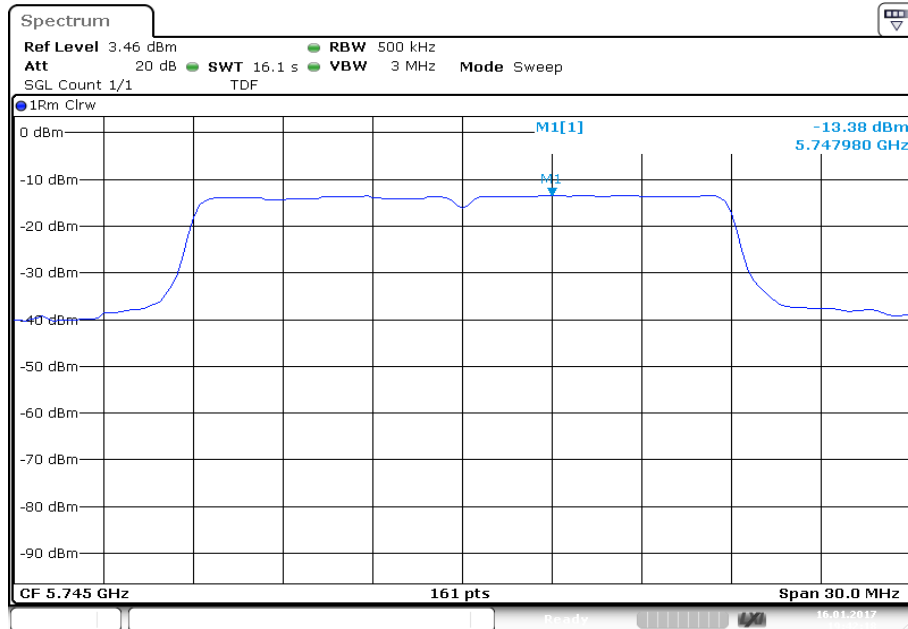

Date: 16.JAN.2017 19:42:19

**Plot 2:** 5785 MHz

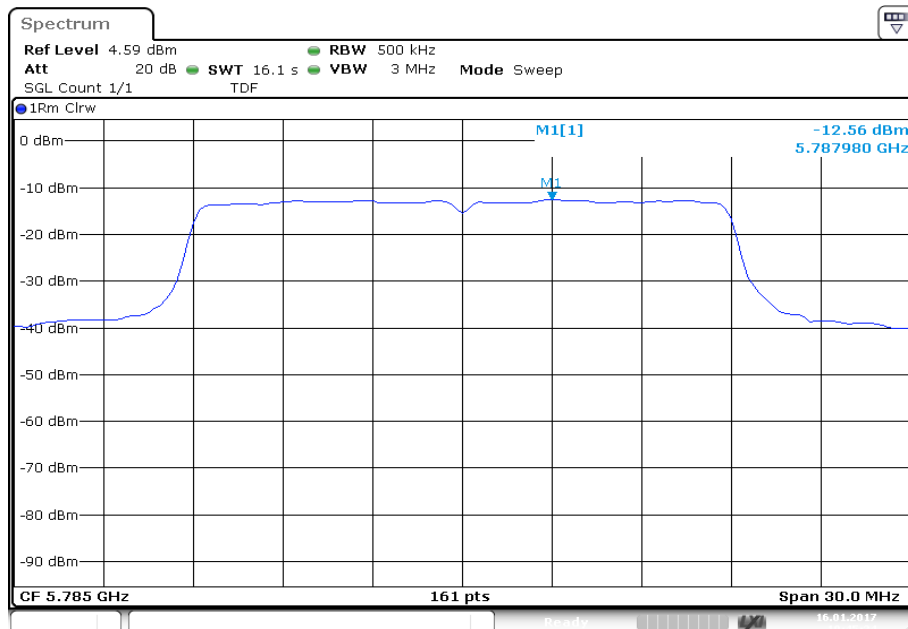

Date: 16.JAN.2017 19:45:25

Plot 3: 5825 MHz

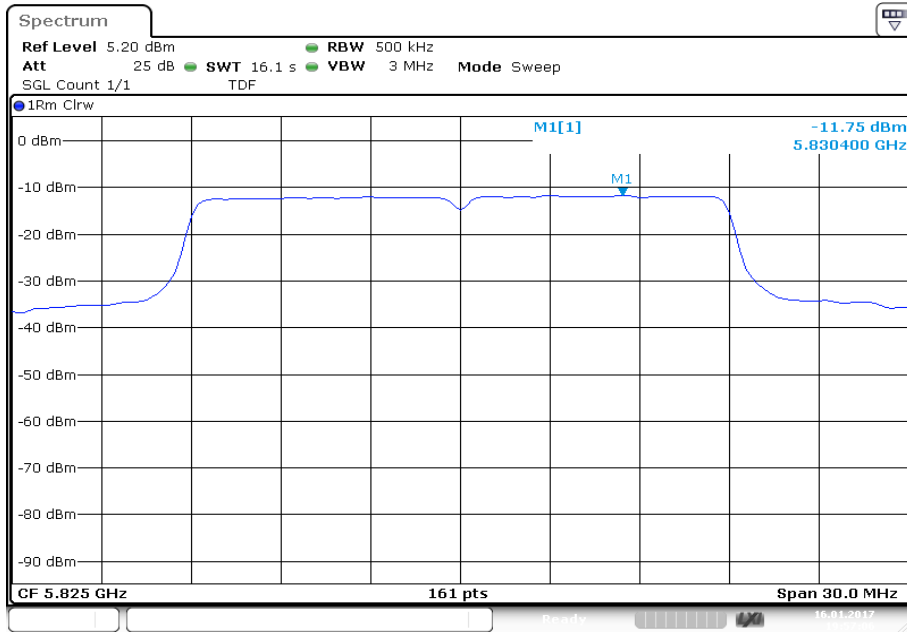

Date: 16.JAN.2017 19:57:07

**Plots:** OFDM / n/ac HT40 – mode

**Plot 1:** 5755 MHz

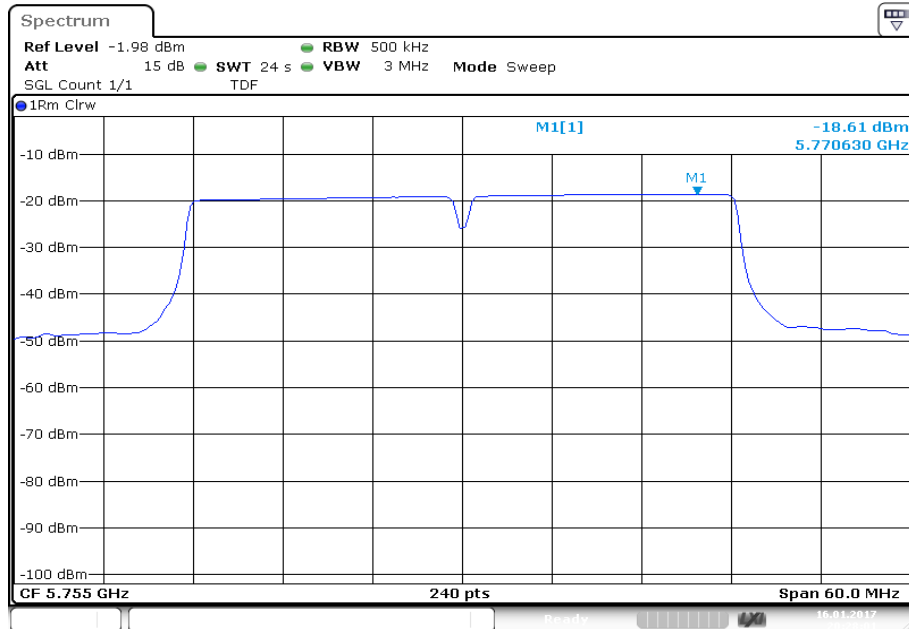

**Plot 2:** 5795 MHz

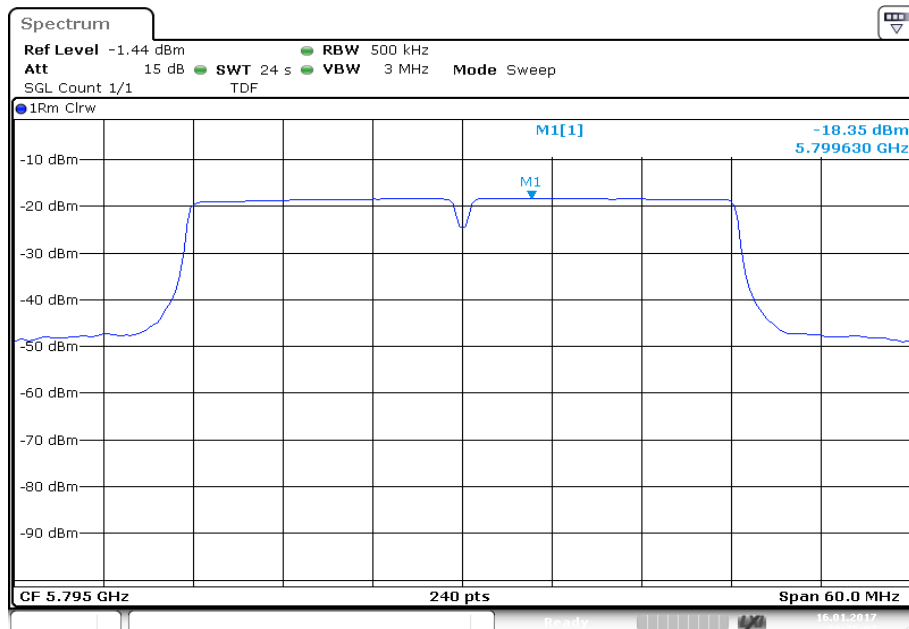

### 11.5.2 Power spectral density – for IC requirements

**Description:**

Measurement of the power spectral density of a digital modulated system. The measurement is repeated at the lowest, middle and highest channel.

**Measurement:**

Measurement parameter	
Detector:	RMS
Sweep time:	$\geq 10 * (\text{swp points}) * (\text{total on/off time})$
Resolution bandwidth:	1 MHz (500 kHz for 5.8 GHz band)
Video bandwidth:	$\geq 3xRBW$
Span:	$> EBW$
Trace mode:	Max hold
Used test setup:	See chapter 6.5 – A
Measurement uncertainty:	See chapter 8

**Limits:**

Power Spectral Density
power spectral density e.i.r.p. $\leq 10$ dBm in any 1 MHz band (band 5150 – 5250 MHz)
power spectral density conducted $\leq 11$ dBm in any 1 MHz band (band 5250 – 5350 MHz)
power spectral density conducted $\leq 11$ dBm in any 1 MHz band (band 5470 – 5725 MHz)
power spectral density conducted $\leq 30$ dBm in any 500 kHz band (band 5725 – 5850 MHz)



**Result:** OFDM / a – mode

OFDM / a – mode	Power spectral density [dBm/MHz] incl. mismatch correction factor			
Channel	5180 MHz	5240 MHz	5260 MHz	5320 MHz
	4.3	3.9	4.3	4.6
Channel	5745 MHz	5785 MHz	5825 MHz	
	-4.6	-3.5	-3.0	

**Result:** OFDM / n/ac HT20 – mode

OFDM / n/ac HT20 – mode	Power spectral density [dBm/MHz] incl. mismatch correction factor			
Channel	5180 MHz	5240 MHz	5260 MHz	5320 MHz
	3.7	2.7	3.2	3.2
Channel	5745 MHz	5785 MHz	5825 MHz	
	-4.8	-4.4	-3.4	

**Result:** OFDM / n/ac HT40 – mode

OFDM / n/ac HT40 – mode	Power spectral density [dBm/MHz] incl. mismatch correction factor			
Channel	5190 MHz	5230 MHz	5270 MHz	5310 MHz
	-0.7	-1.9	-1.6	-1.7
Channel	5755 MHz	5795 MHz		
	-10.0	-10.0		

The plots for the band 5150 MHz to 5350 MHz can be found in chapter 11.4.2 “Output power”.

**Plots:** OFDM / a – mode

**Plot 1:** 5745 MHz

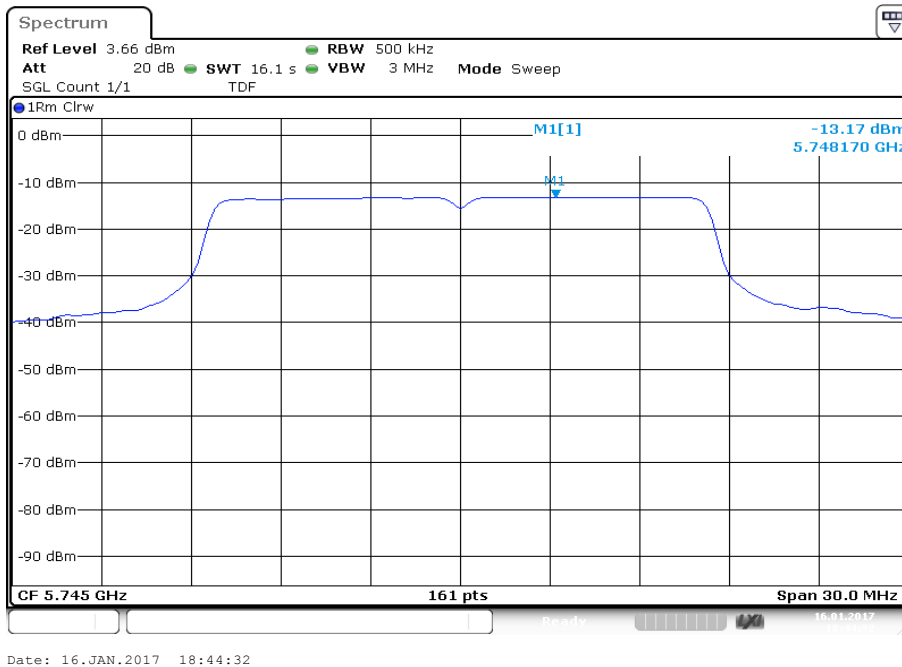

**Plot 2:** 5785 MHz

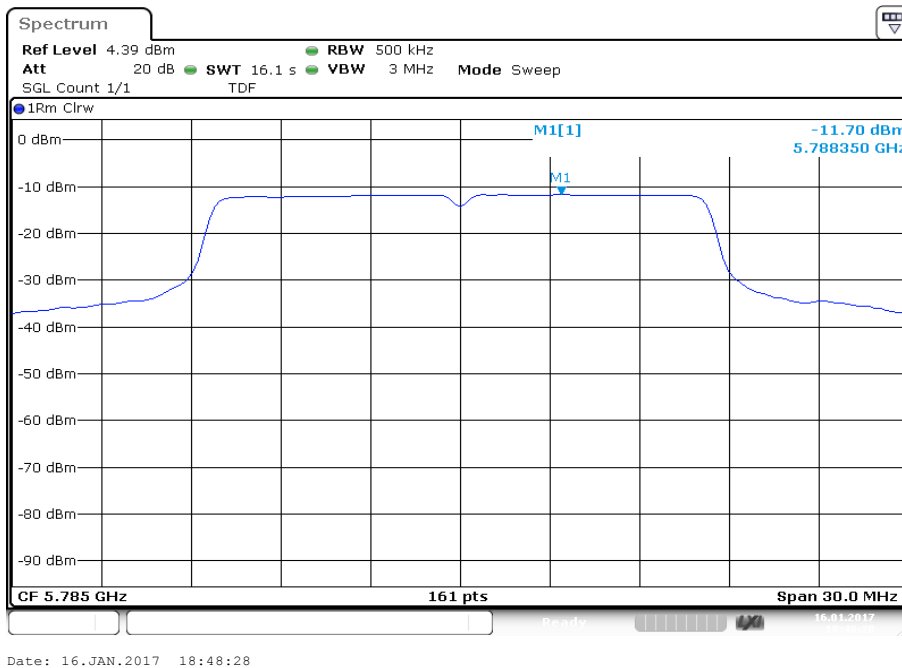

Plot 3: 5825 MHz

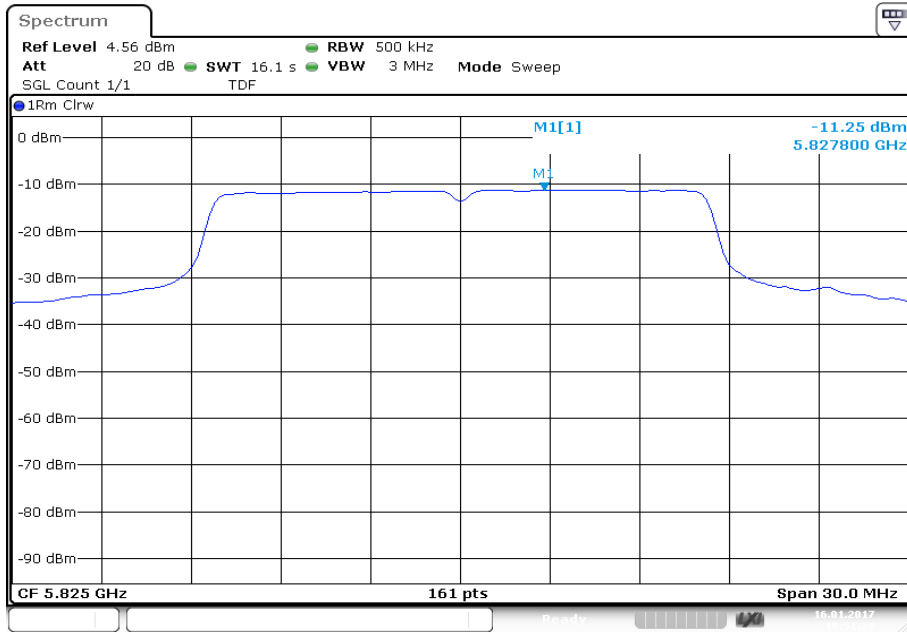

Date: 16.JAN.2017 18:51:29

**Plots:** OFDM / n/ac HT20 – mode

**Plot 1:** 5745 MHz

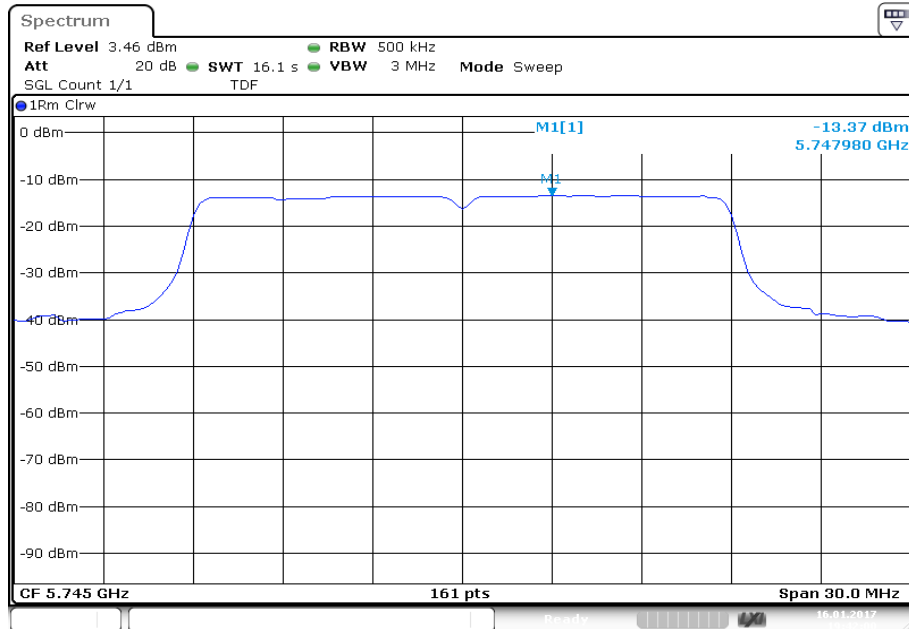

Date: 16.JAN.2017 19:42:01

**Plot 2:** 5785 MHz

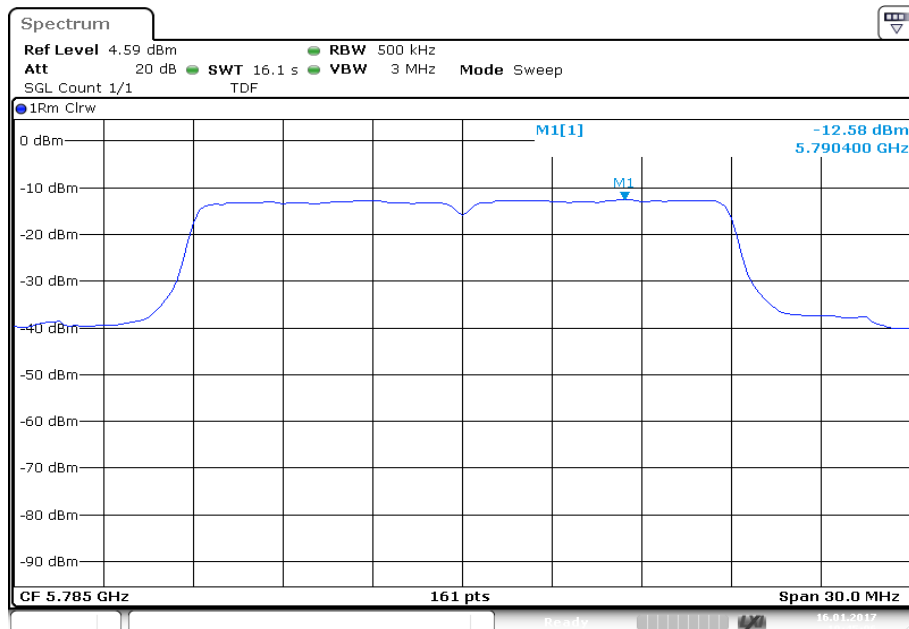

Date: 16.JAN.2017 19:45:07

Plot 3: 5825 MHz

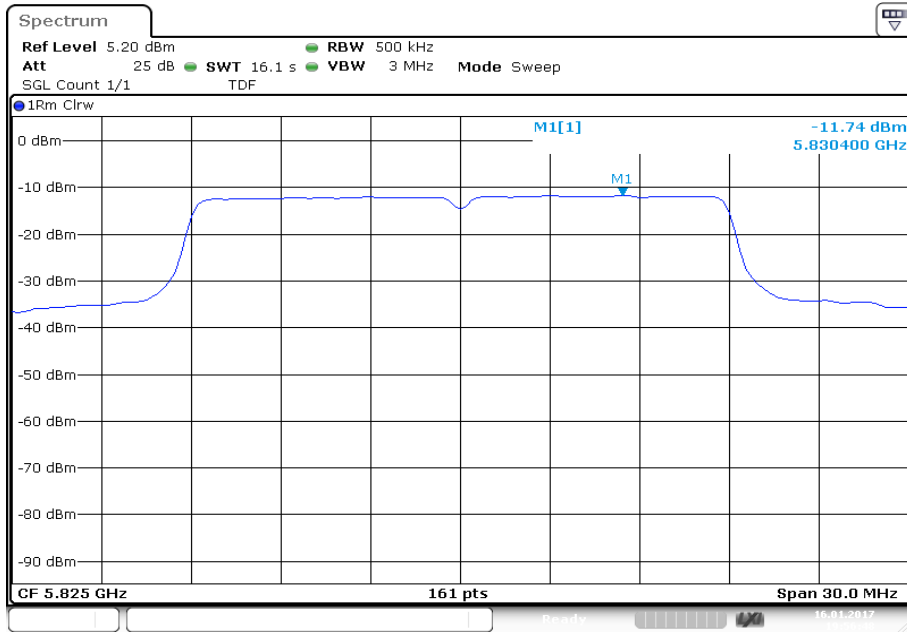

Date: 16.JAN.2017 19:56:49

**Plots:** OFDM / n/ac HT40 – mode

**Plot 1:** 5755 MHz

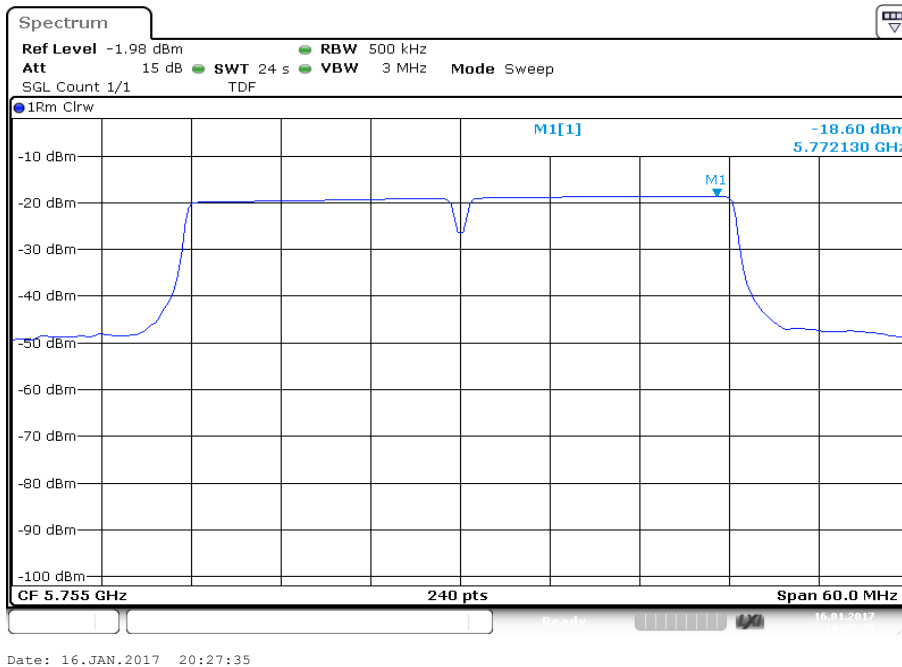

**Plot 2:** 5795 MHz

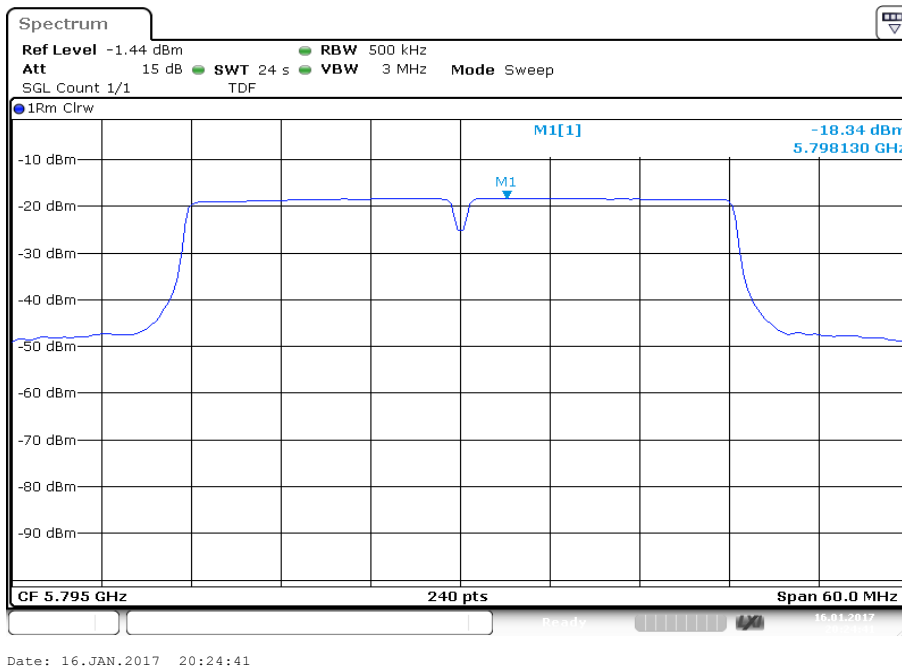

### 11.6 Minimum emission bandwidth for the band 5.725-5.85 GHz

**Description:**

Measurement of the 6 dB bandwidth of the modulated signal.

**Measurement:**

Measurement parameter	
According to: KDB789033 D02, C.2.	
Detector:	Peak
Sweep time:	Auto
Resolution bandwidth:	100 kHz
Video bandwidth:	300 kHz
Span:	40 MHz
Measurement procedure:	Using marker to find -6dBc frequencies
Trace mode:	Max hold (allow trace to stabilize)
Used test setup:	See chapter 6.5 – A
Measurement uncertainty:	See chapter 8

**Limits:**

FCC	IC
Minimum Emission Bandwidth for the band 5.725-5.85 GHz	
The minimum 6 dB bandwidth shall be at least 500 kHz.	

**Result:**

OFDM / a – mode	6 dB bandwidth [MHz]		
Channel	5745 MHz	5785 MHz	5825 MHz
	16.603	16.543	16.573

OFDM / n/ac HT20 – mode	6 dB bandwidth [MHz]		
Channel	5745 MHz	5785 MHz	5825 MHz
	17.862	17.892	17.862

OFDM / n/ac HT40 – mode	6 dB bandwidth [MHz]	
Channel	5755 MHz	5795 MHz
	36.623	36.623



**Plots:** OFDM / a – mode

**Plot 1:** 5745 MHz

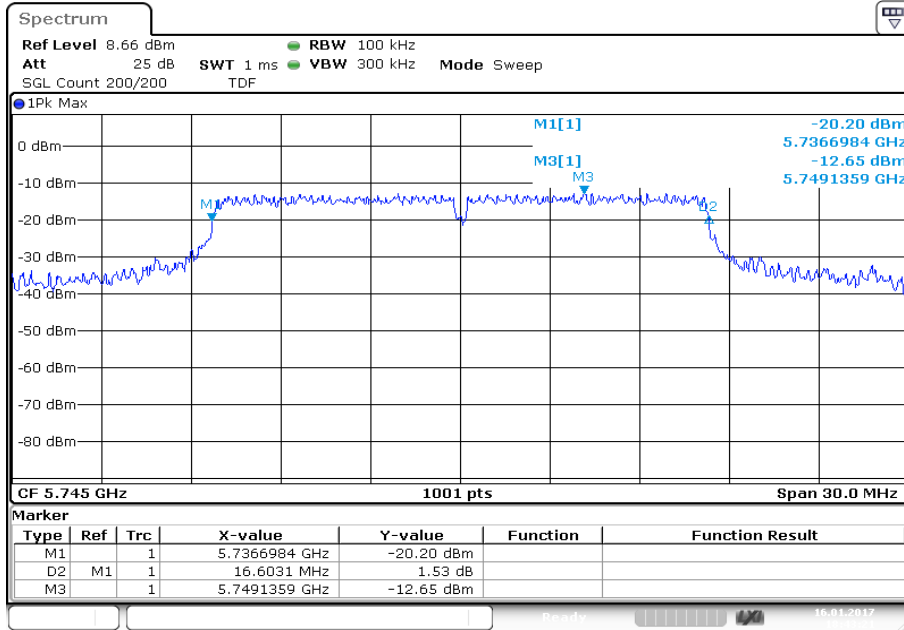

Date: 16.JAN.2017 18:43:22

**Plot 2:** 5785 MHz

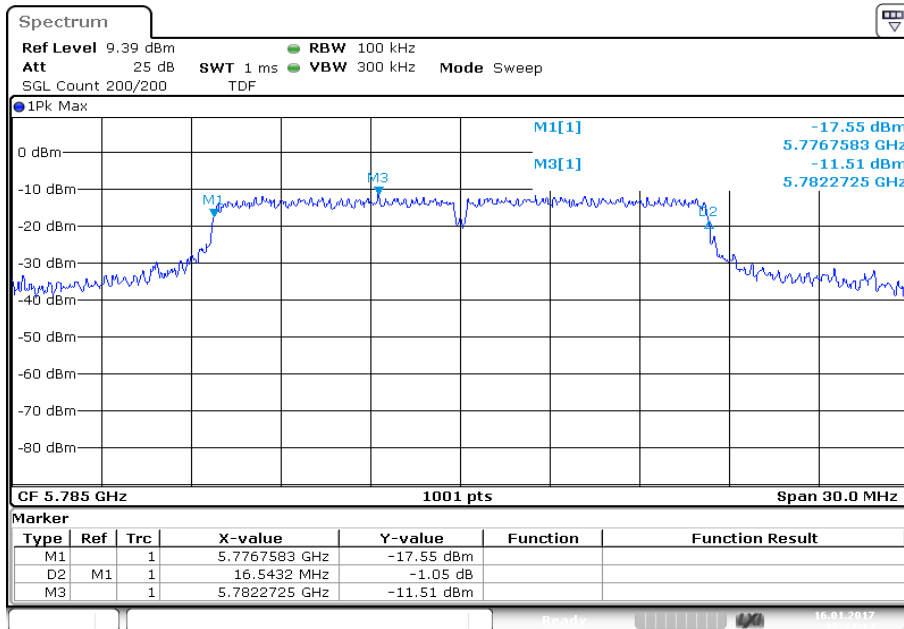

Date: 16.JAN.2017 18:47:18

Plot 3: 5825 MHz

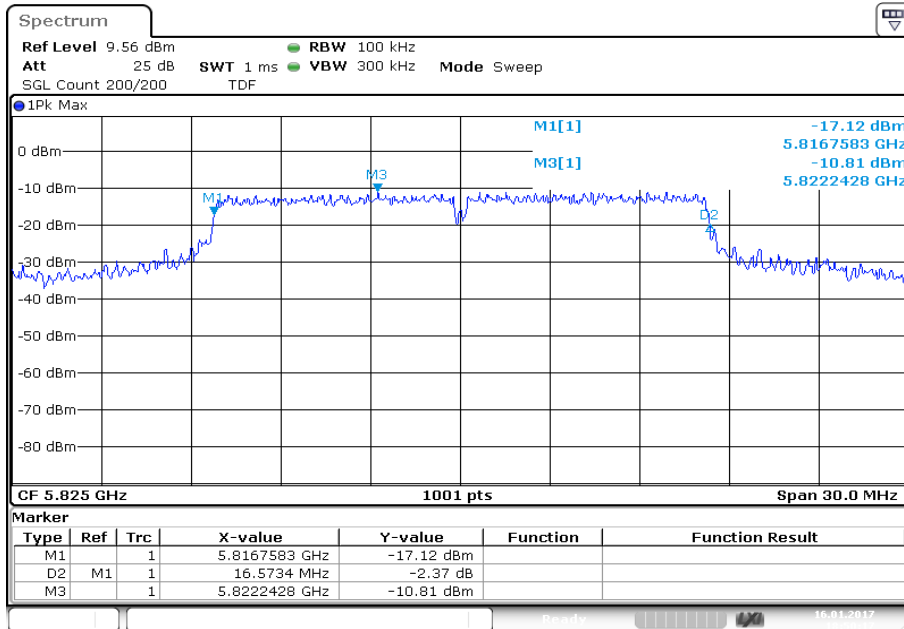

Date: 16.JAN.2017 18:50:18

**Plots:** OFDM / n/ac HT20 – mode

**Plot 1:** 5745 MHz

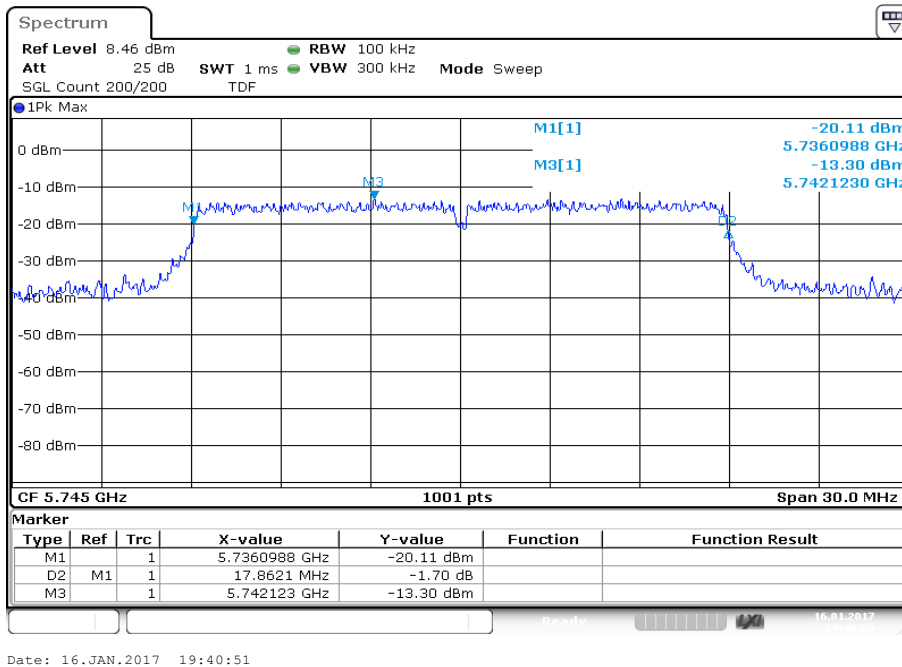

**Plot 2:** 5785 MHz

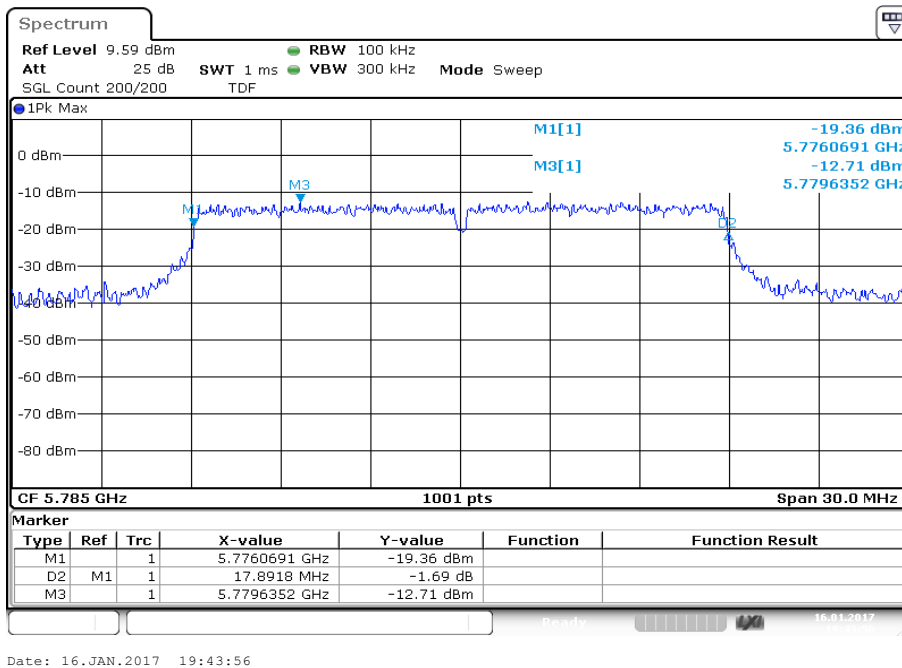

Plot 3: 5825 MHz

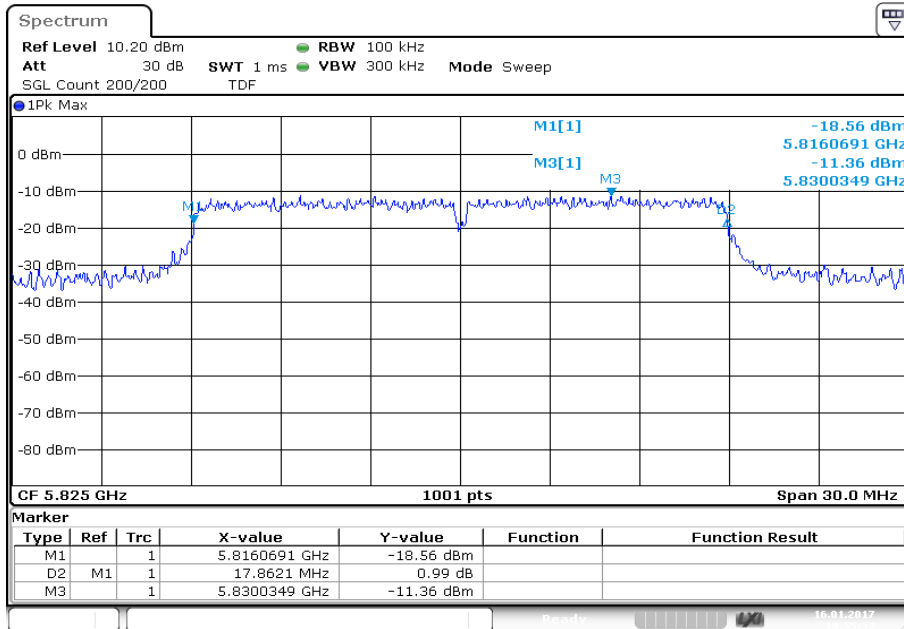

Date: 16.JAN.2017 19:55:38

**Plots:** OFDM / n/ac HT40 – mode

**Plot 1:** 5755 MHz

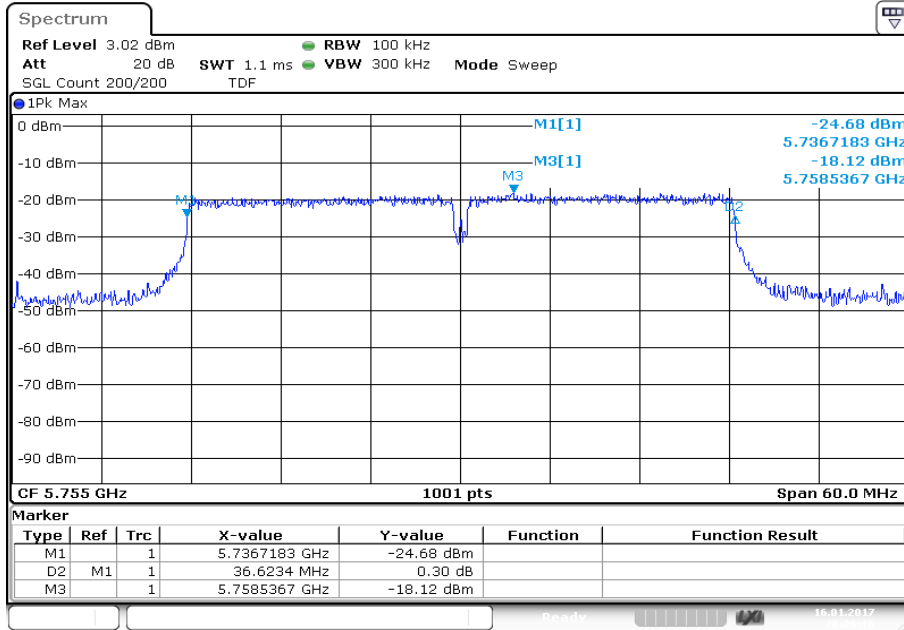

Date: 16.JAN.2017 20:26:17

**Plot 2:** 5795 MHz

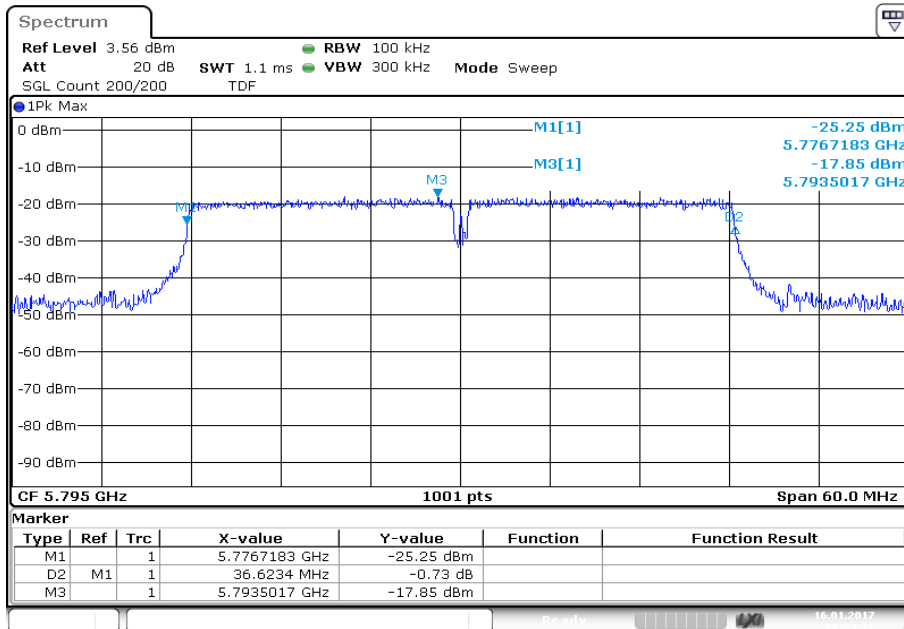

Date: 16.JAN.2017 20:23:23

### 11.7 Spectrum bandwidth – 26 dB bandwidth

**Description:**

Measurement of the 26 dB bandwidth of the modulated signal.

**Measurement:**

Measurement parameter	
According to: KDB789033 D02, C.1.	
Detector:	Peak
Sweep time:	Auto
Resolution bandwidth:	1% EBW
Video bandwidth:	≥ RBW
Span:	> complete signal!
Trace-Mode:	Max hold
Used test setup:	see chapter 6.5 – A
Measurement uncertainty:	See chapter 8

**Limits:**

Spectrum Bandwidth – 26 dB Bandwidth
-/-

**Result:** OFDM / a – mode

OFDM / a – mode	26 dB bandwidth [MHz]			
Channel	5180 MHz	5240 MHz	5260 MHz	5320 MHz
	47.552	41.608	38.912	41.159
Channel	5745 MHz	5785 MHz	5825 MHz	
	35.814	35.115	37.213	

**Result:** OFDM / n/ac HT20 – mode

OFDM / n/ac HT20 – mode	26 dB bandwidth [MHz]			
Channel	5180 MHz	5240 MHz	5260 MHz	5320 MHz
	45.255	43.257	41.559	43.757
Channel	5745 MHz	5785 MHz	5825 MHz	
	39.660	38.162	43.307	

**Result:** OFDM / n/ac HT40 – mode

OFDM / n/ac HT40 – mode	26 dB bandwidth [MHz]			
Channel	5190 MHz	5230 MHz	5270 MHz	5310 MHz
	84.416	81.318	76.424	80.520
Channel	5755 MHz	5795 MHz		
	55.944	60.339		

**Plots:** OFDM / a – mode

**Plot 1:** 5180 MHz

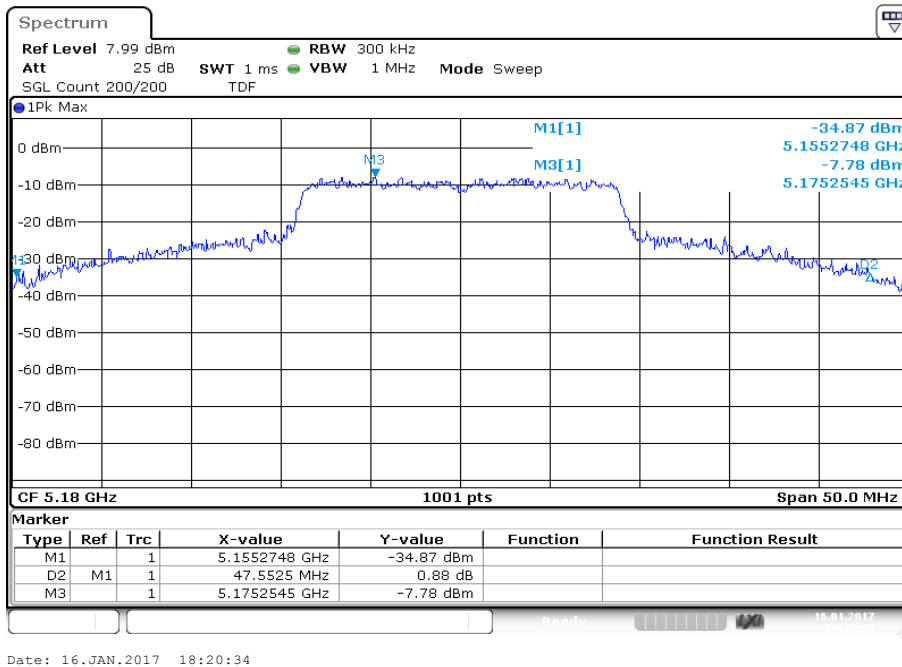

**Plot 2:** 5240 MHz

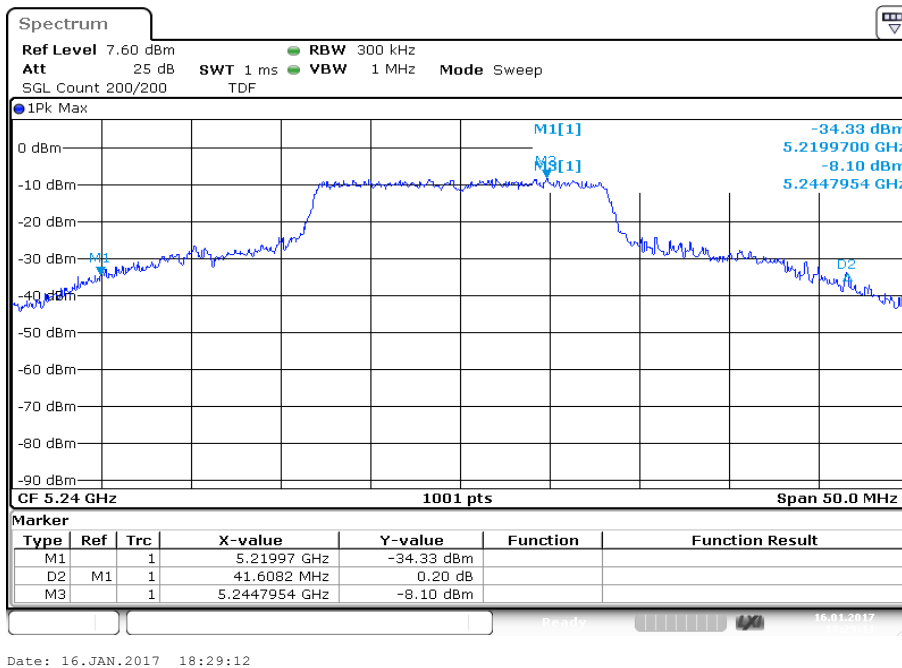



Plot 3: 5260 MHz

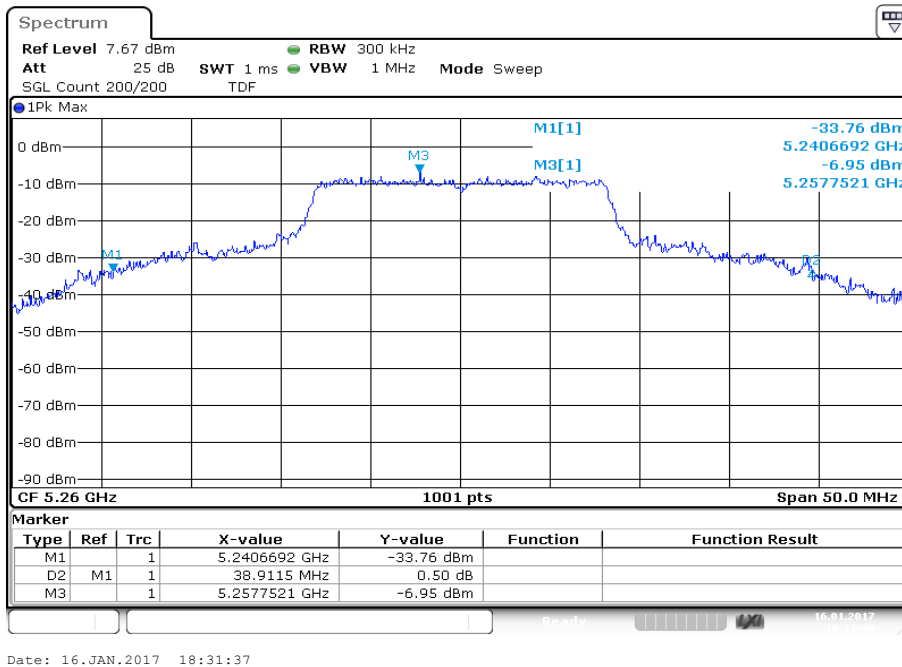

Plot 4: 5320 MHz

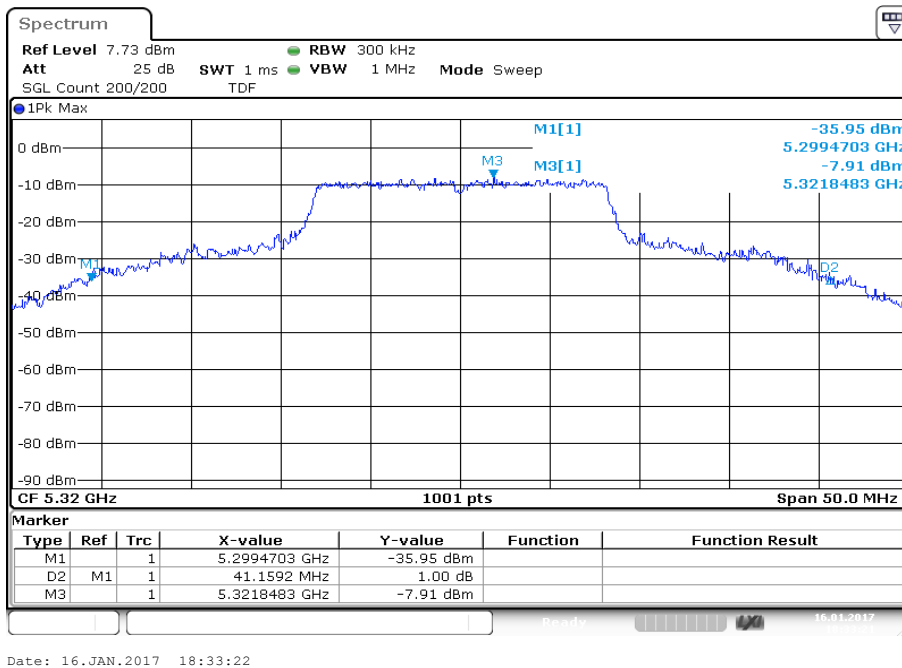

Plot 5: 5745 MHz

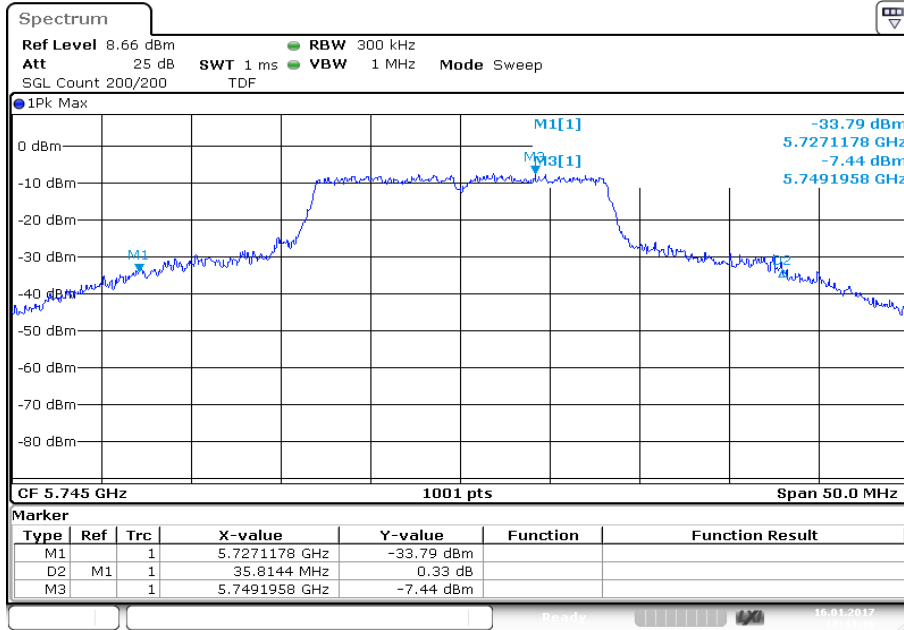

Date: 16.JAN.2017 18:43:16

Plot 6: 5785 MHz

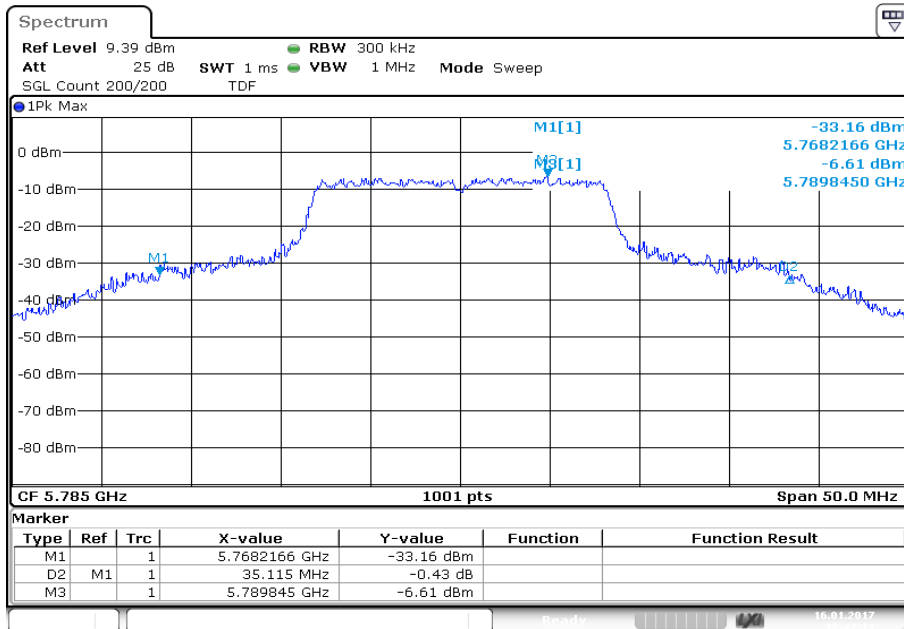

Date: 16.JAN.2017 18:47:12

Plot 7: 5825 MHz

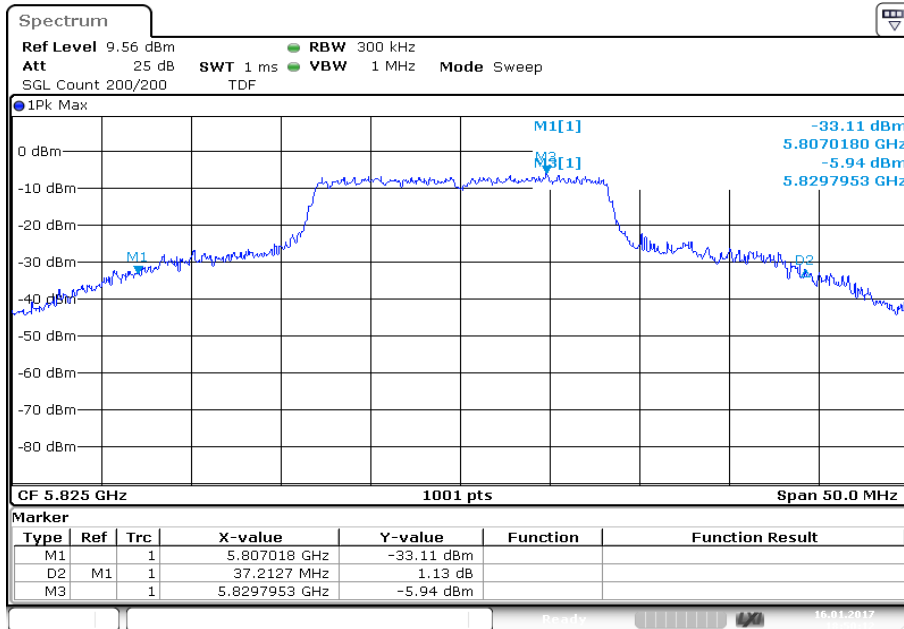

Date: 16.JAN.2017 18:50:13

**Plots:** OFDM / n/ac HT20 – mode

**Plot 1:** 5180 MHz

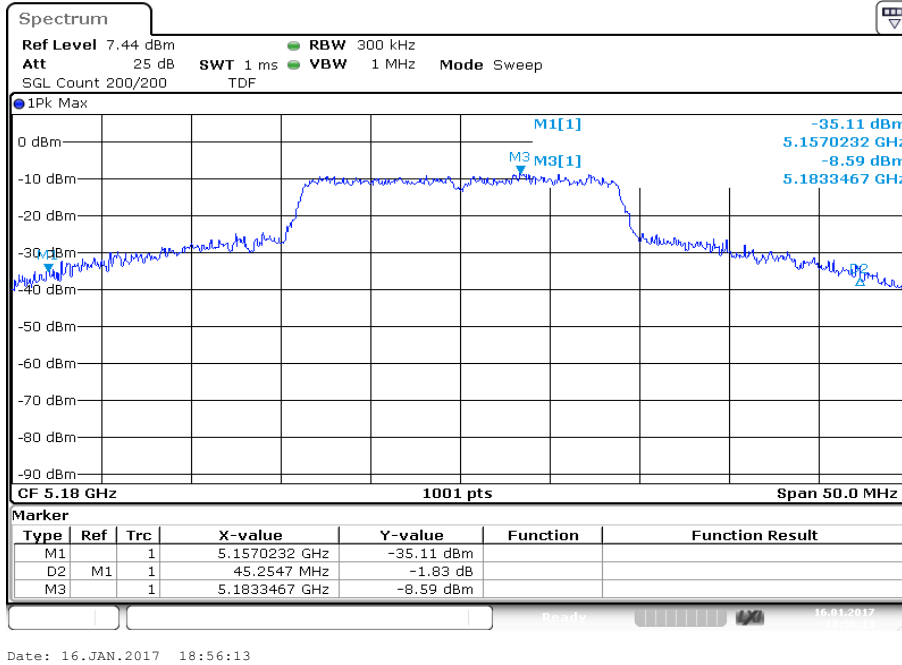

**Plot 2:** 5240 MHz

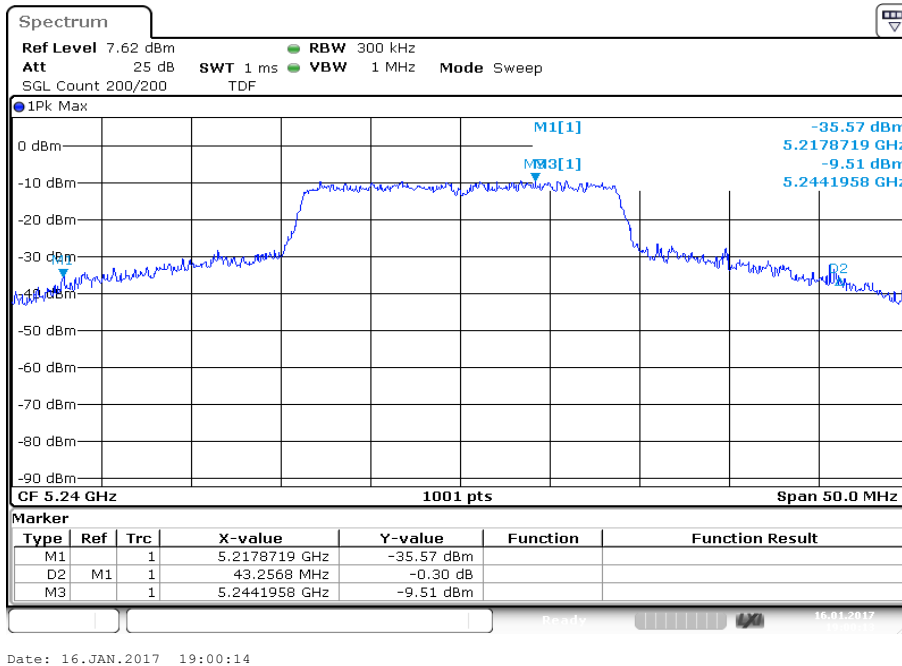

Plot 3: 5260 MHz

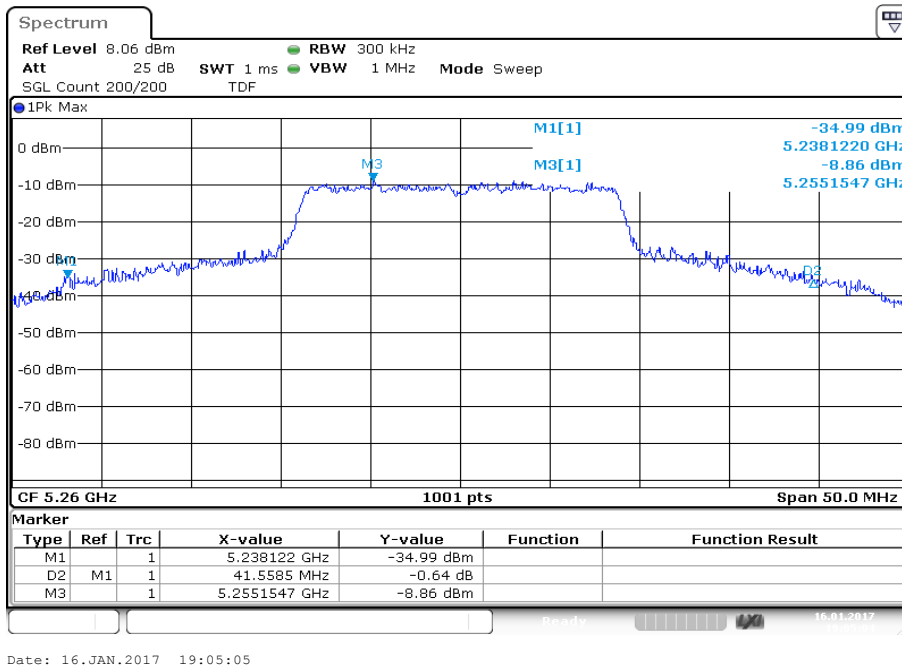

Plot 4: 5320 MHz

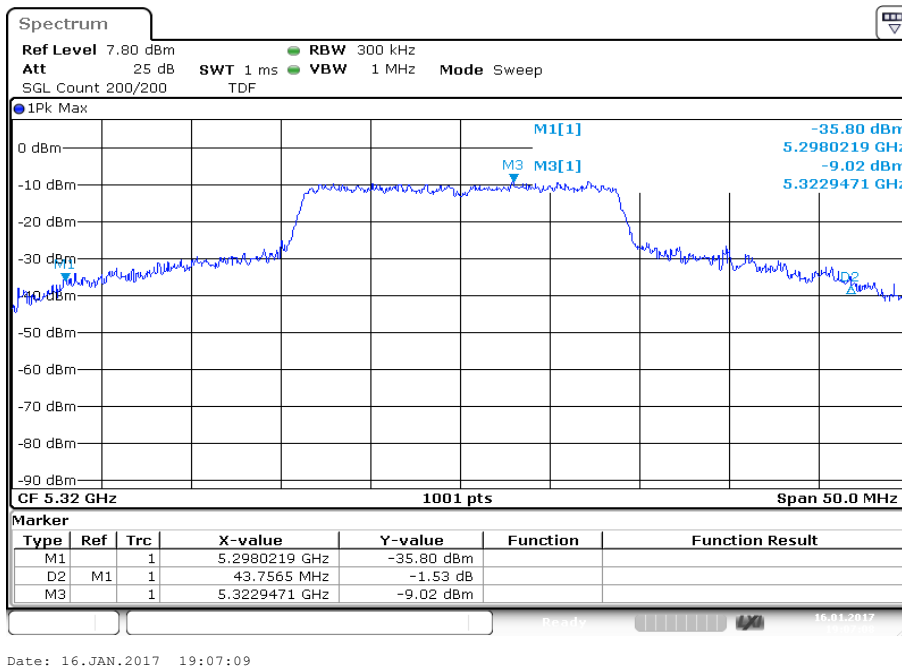

Plot 5: 5745 MHz

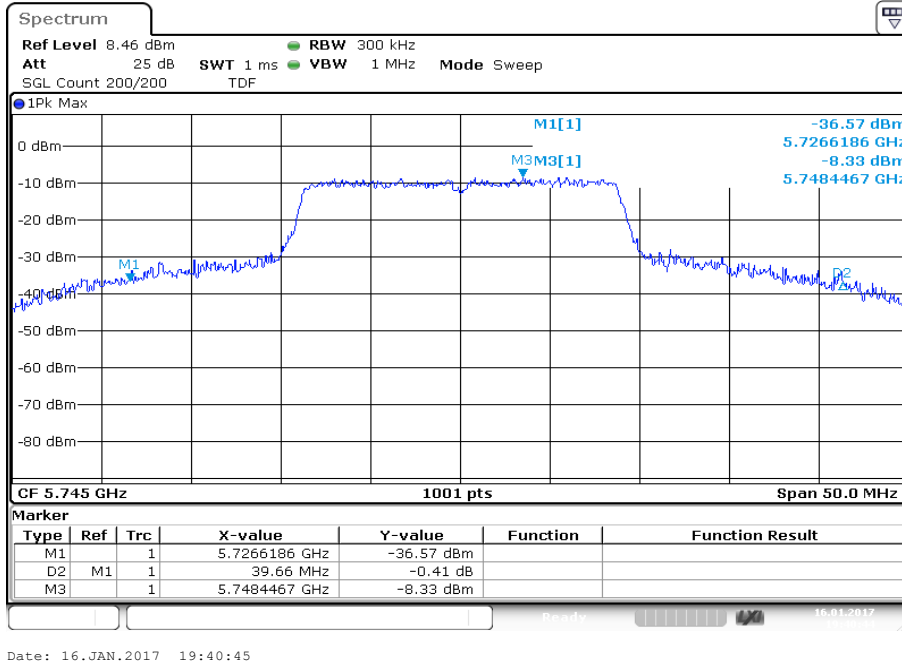

Plot 6: 5785 MHz

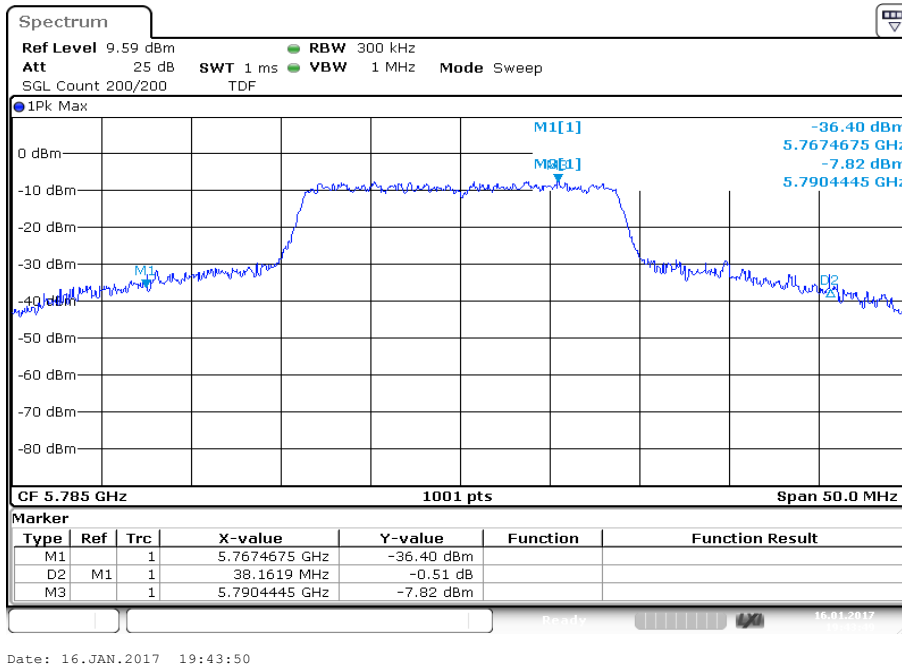

Plot 7: 5825 MHz

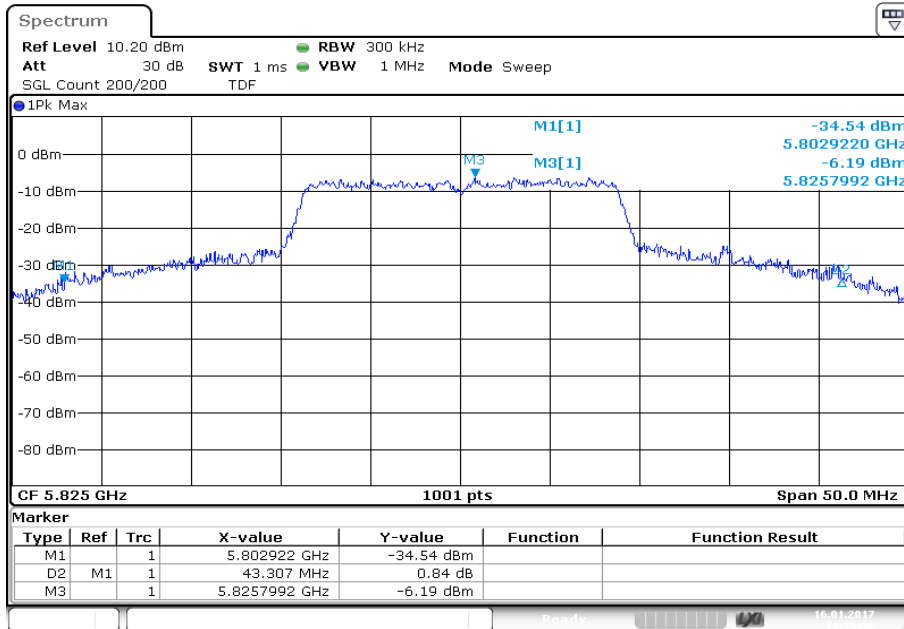

Date: 16.JAN.2017 19:55:33

**Plots:** OFDM / n/ac HT40 – mode

**Plot 1:** 5190 MHz

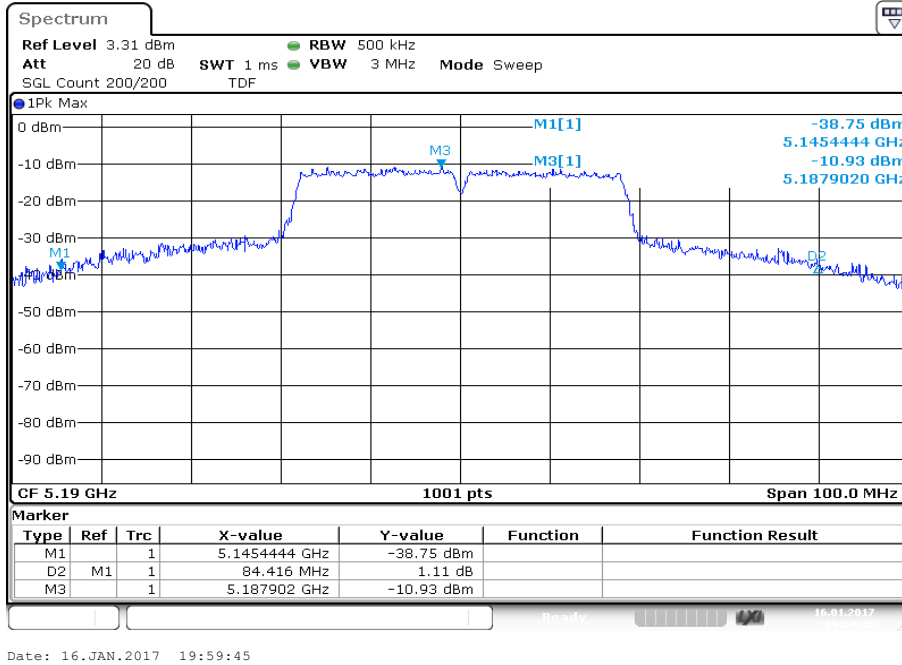

**Plot 2:** 5230 MHz

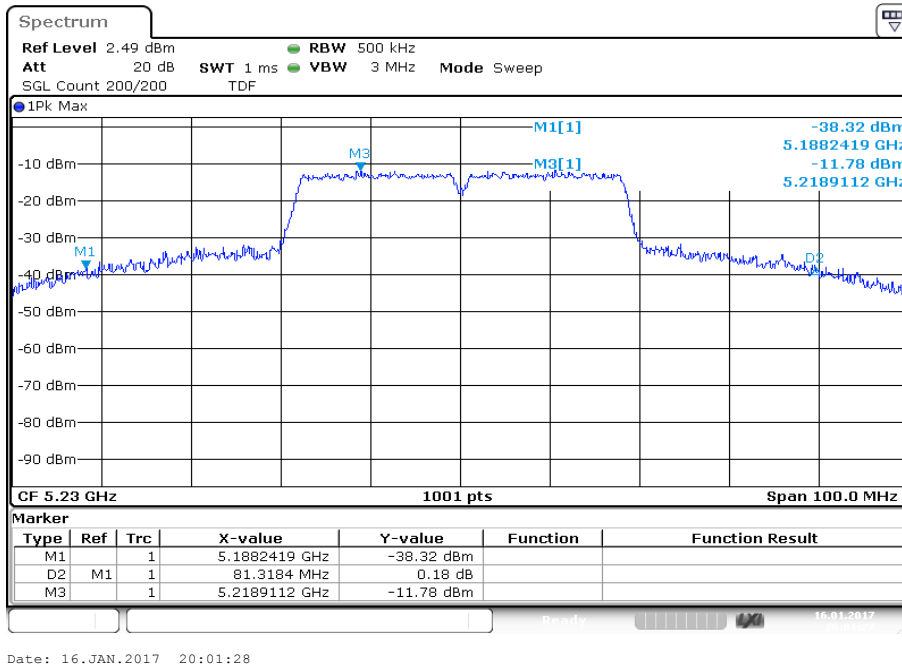



Plot 3: 5270 MHz

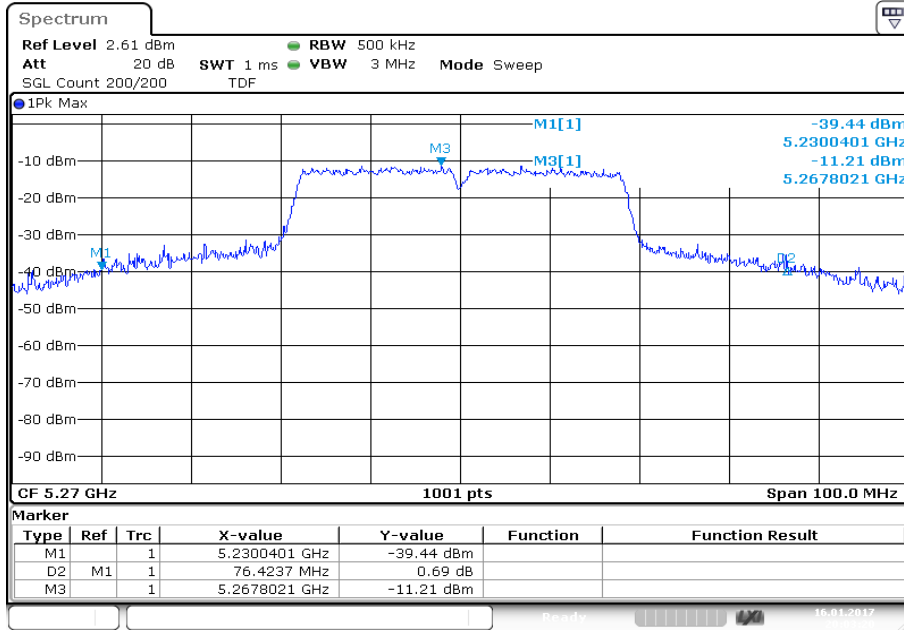

Date: 16.JAN.2017 20:03:21

Plot 4: 5310 MHz

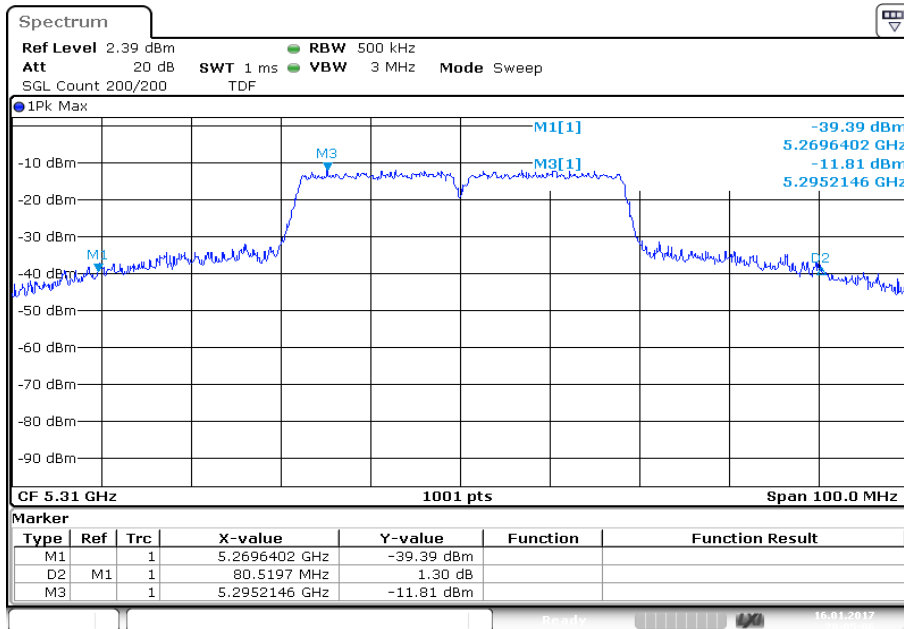

Date: 16.JAN.2017 20:05:07

Plot 5: 5755 MHz

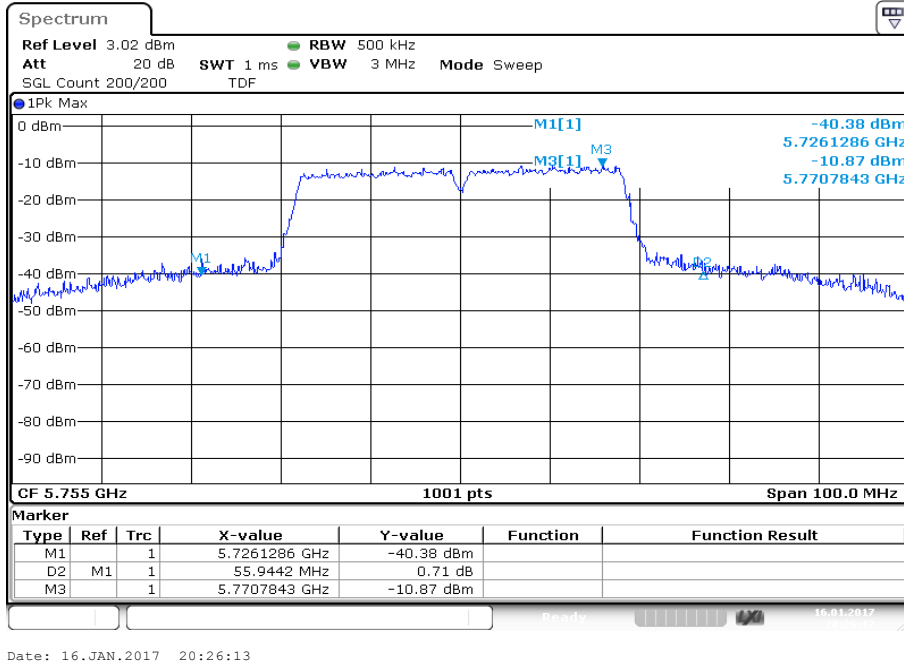

Plot 6: 5795 MHz

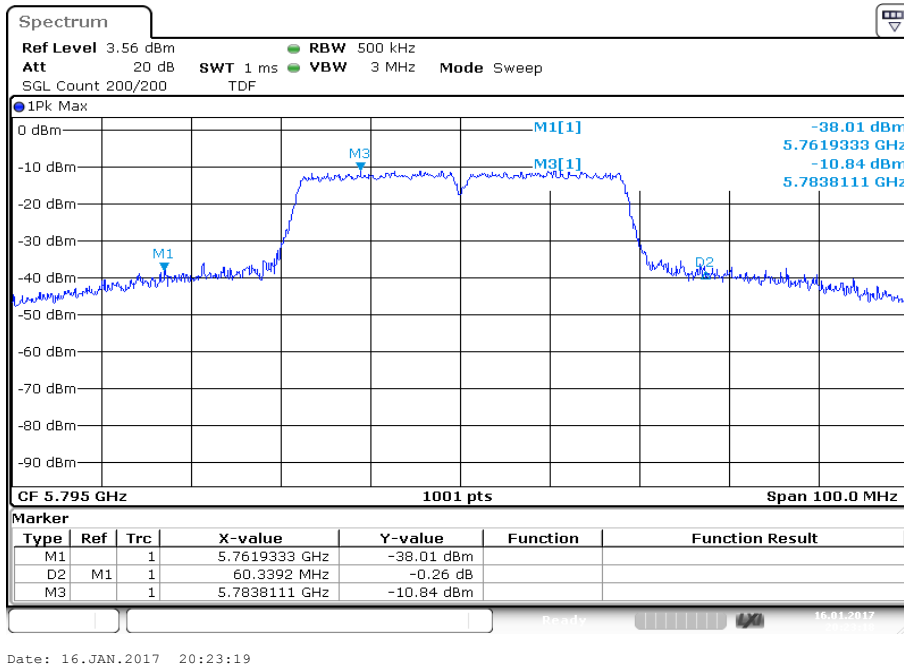

### 11.8 Occupied bandwidth – 99% emission bandwidth

**Description:**

Measurement of the 99% bandwidth of the modulated signal acc. RSS-GEN.

**Measurement:**

Measurement parameter	
Detector:	Peak
Sweep time:	Auto
Resolution bandwidth:	300 kHz / 500 kHz
Video bandwidth:	1 MHz / 3 MHz
Span:	50 MHz / 100 MHz
Measurement procedure:	Measurement of the 99% bandwidth using the integration function of the analyzer
Trace – mode:	Max hold (allow trace to stabilize)
Test setup:	See sub clause 6.5 – A
Measurement uncertainty:	See sub clause 8

**Usage:**

-/-	IC
Occupied Bandwidth – 99% emission bandwidth	
OBW is necessary for Emission Designator	

**Result:** OFDM / a – mode

OFDM / a – mode	99% bandwidth [kHz]			
Channel	5180 MHz	5240 MHz	5260 MHz	5320 MHz
	29371	23726	25325	25225
Channel	5745 MHz	5785 MHz	5825 MHz	
	18931	18332	21878	

**Result:** OFDM / n/ac HT20 – mode

OFDM / n/ac HT20 – mode	99% bandwidth [kHz]			
Channel	5180 MHz	5240 MHz	5260 MHz	5320 MHz
	26374	20929	20979	22827
Channel	5745 MHz	5785 MHz	5825 MHz	
	18432	18332	21179	

**Result:** OFDM / n/ac HT40 – mode

OFDM / n/ac HT40 – mode	99% bandwidth [kHz]			
Channel	5190 MHz	5230 MHz	5270 MHz	5310 MHz
	42857	37962	37363	37562
Channel	5755 MHz	5795 MHz		
	36963	36763		

**Plots:** OFDM / a – mode

**Plot 1:** 5180 MHz

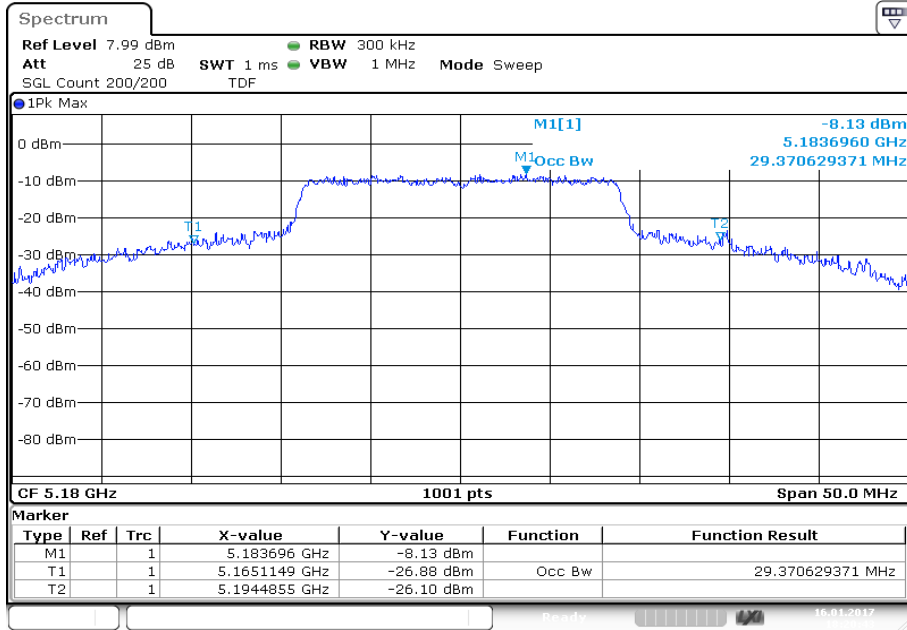

Date: 16.JAN.2017 18:20:44

**Plot 2:** 5240 MHz

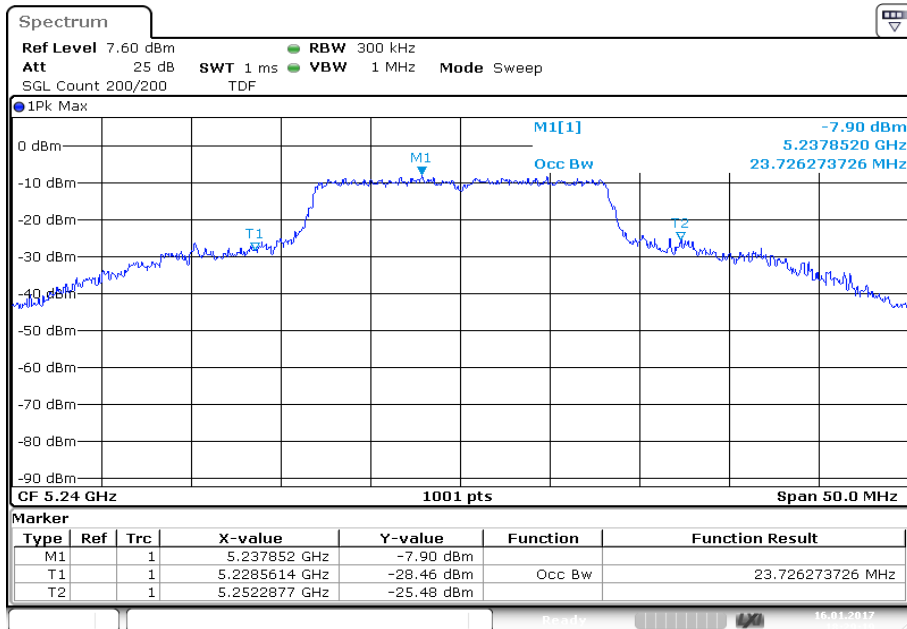

Date: 16.JAN.2017 18:29:20

Plot 3: 5260 MHz

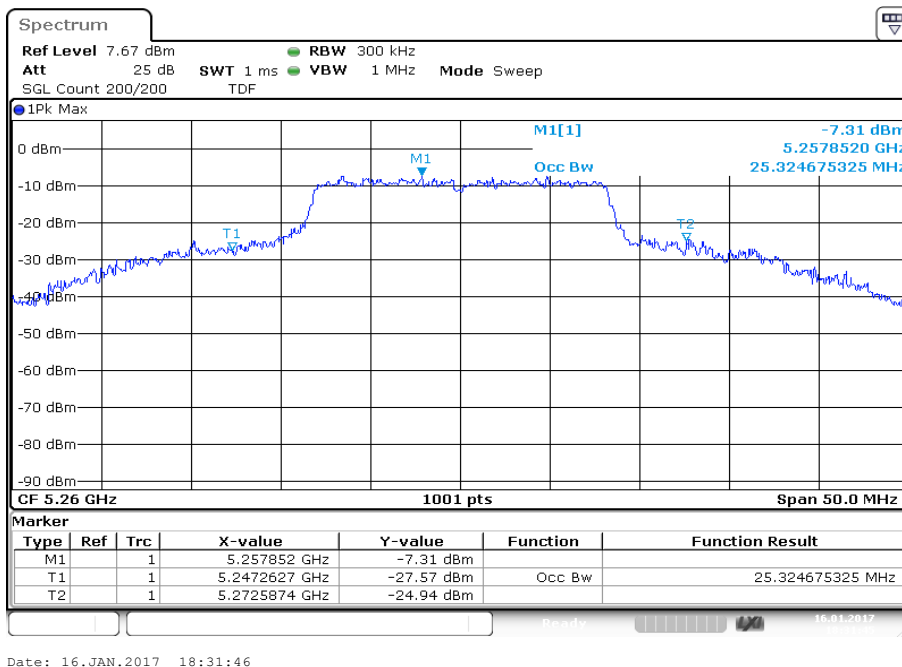

Plot 4: 5320 MHz

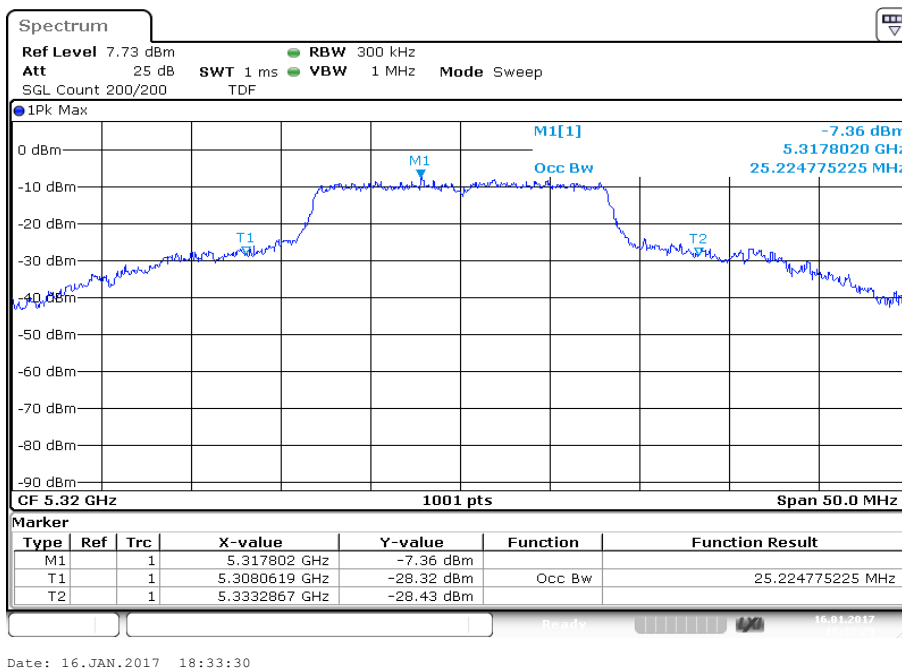

Plot 5: 5745 MHz

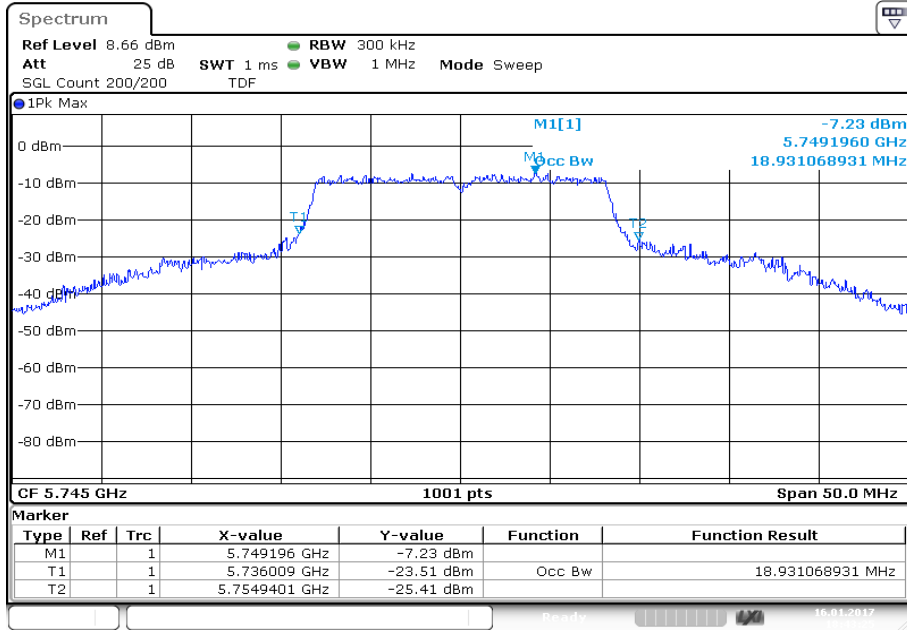

Date: 16.JAN.2017 18:43:25

Plot 6: 5785 MHz

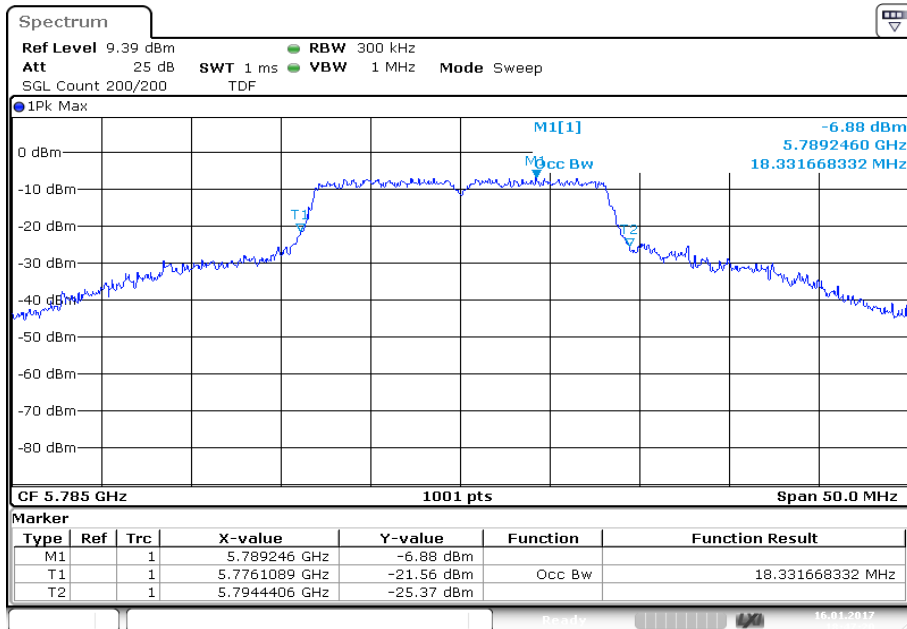

Date: 16.JAN.2017 18:47:21

Plot 7: 5825 MHz

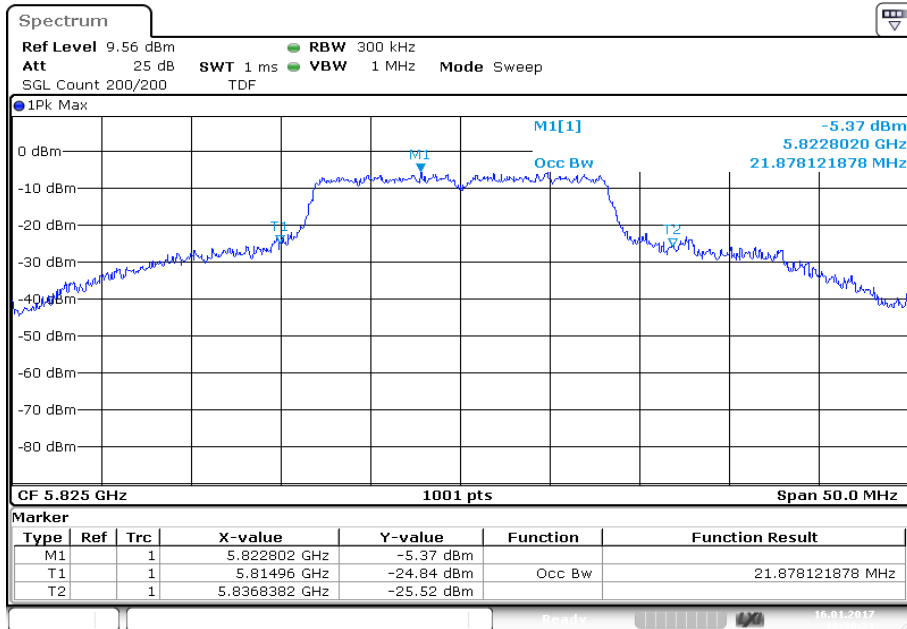

Date: 16.JAN.2017 18:50:22



**Plots:** OFDM / n/ac HT20 – mode

**Plot 1:** 5180 MHz

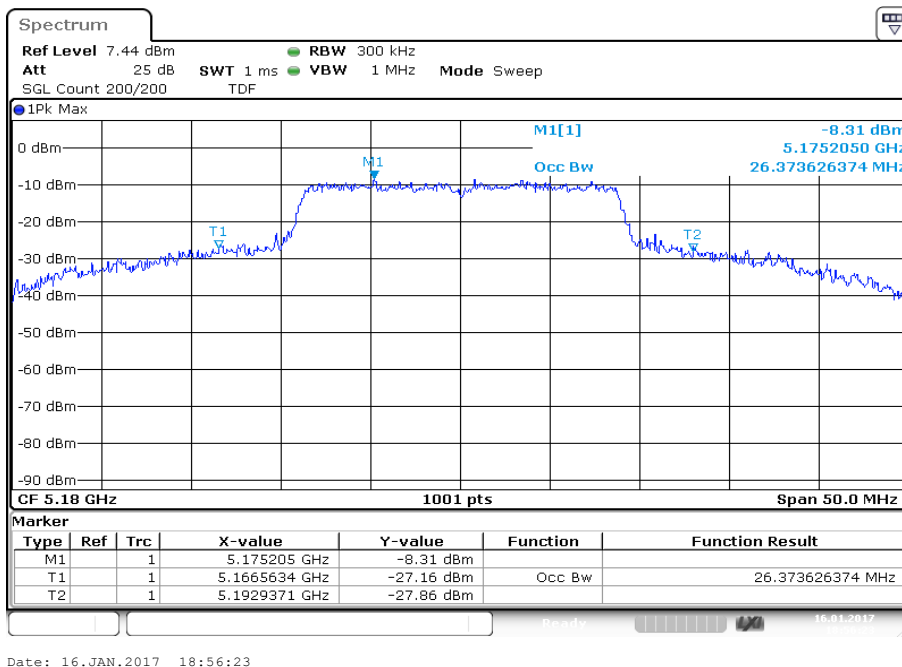

**Plot 2:** 5240 MHz

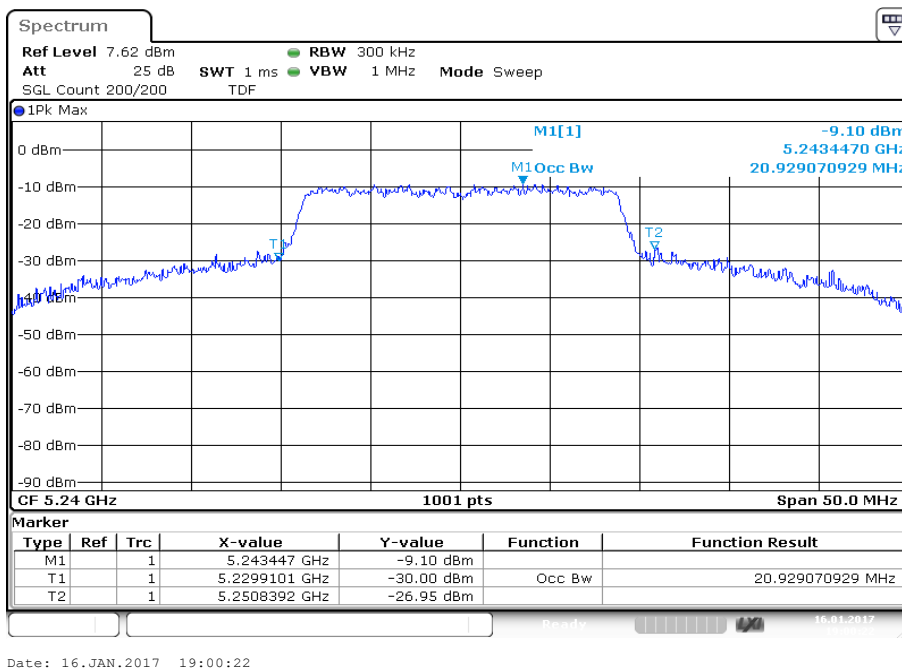

Plot 3: 5260 MHz

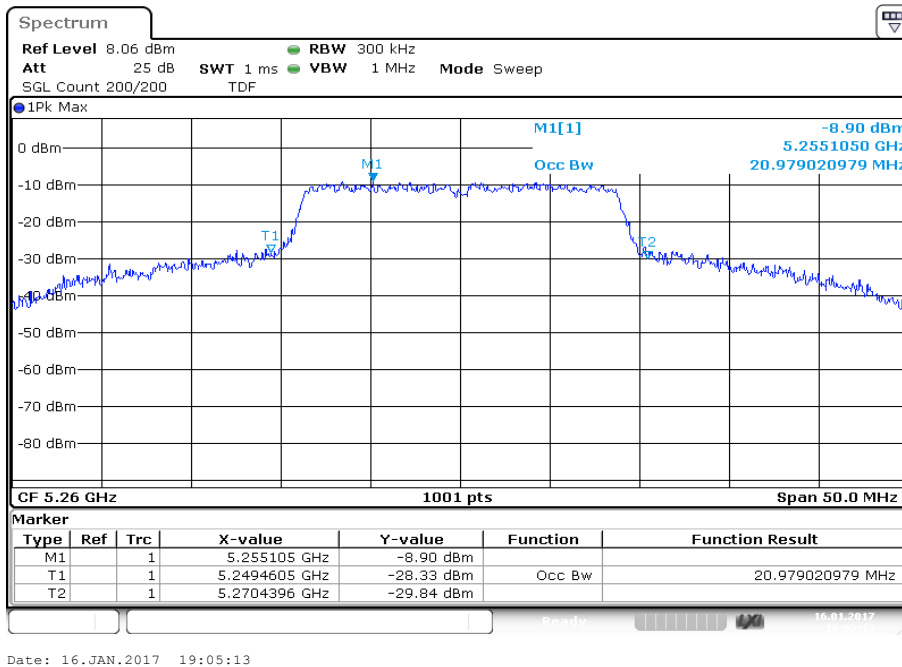

Plot 4: 5320 MHz

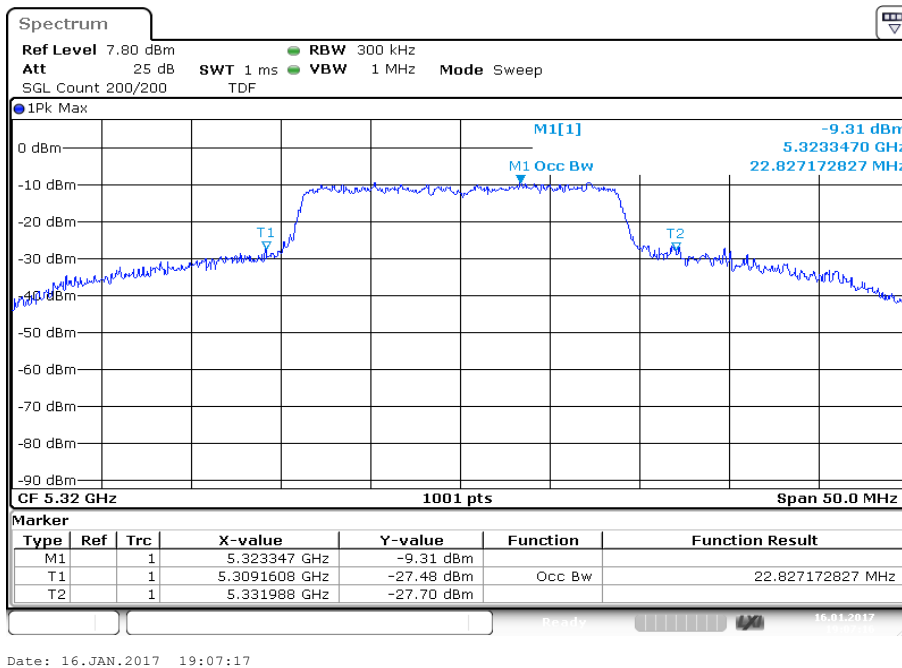

Plot 5: 5745 MHz

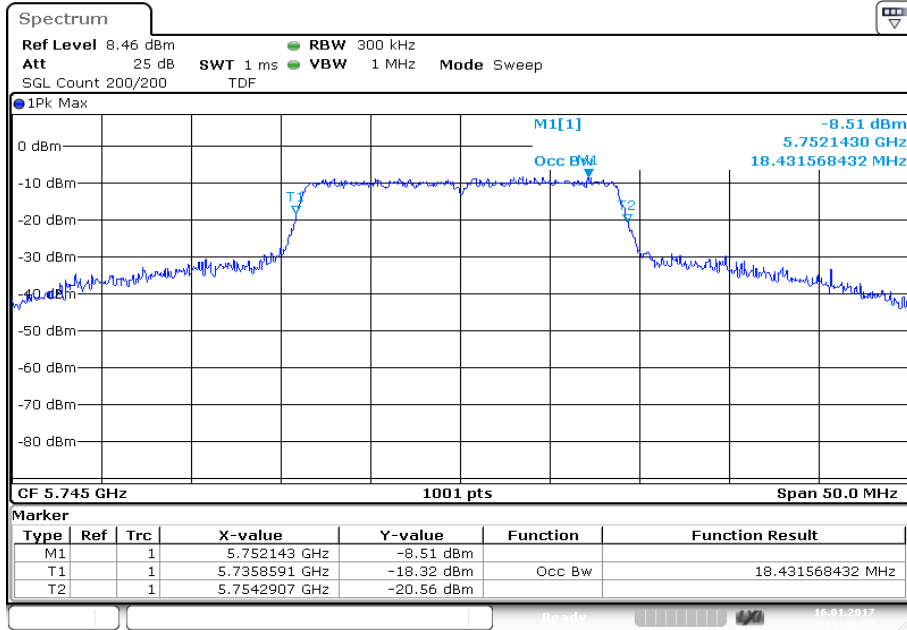

Date: 16.JAN.2017 19:40:54

Plot 6: 5785 MHz

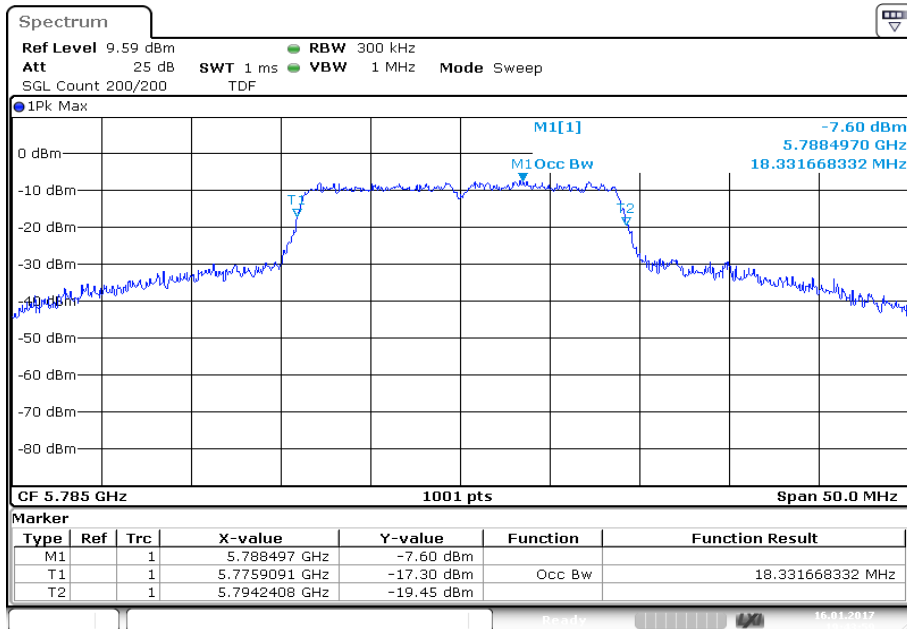

Date: 16.JAN.2017 19:43:59

Plot 7: 5825 MHz

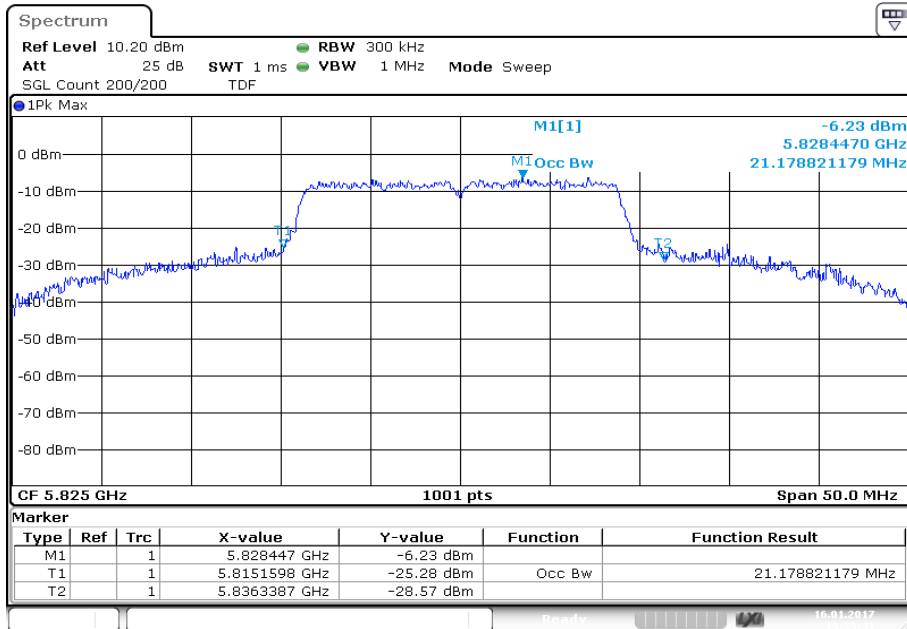

Date: 16.JAN.2017 19:55:42

**Plots:** OFDM / n/ac HT40 – mode

**Plot 1:** 5190 MHz

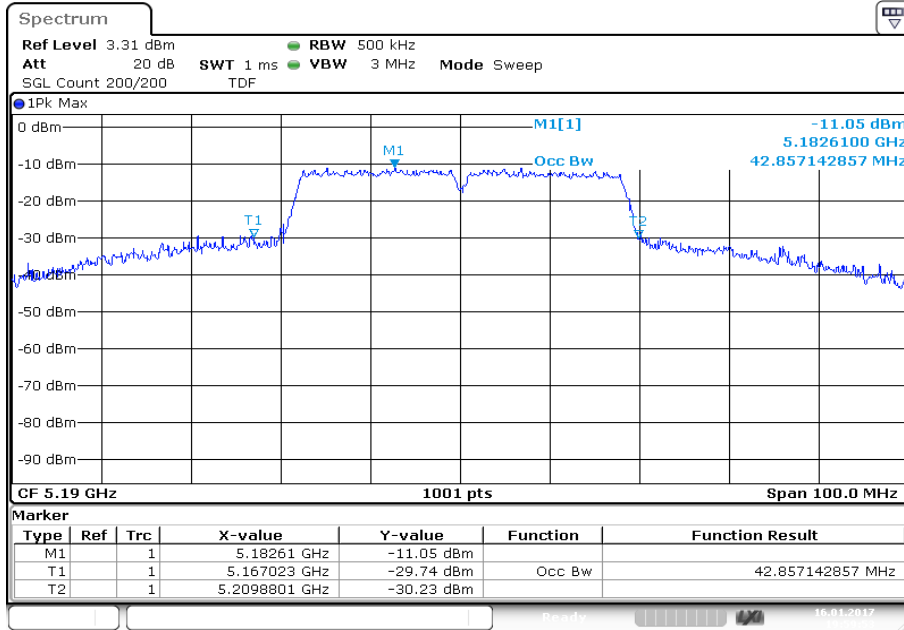

Date: 16.JAN.2017 19:59:54

**Plot 2:** 5230 MHz

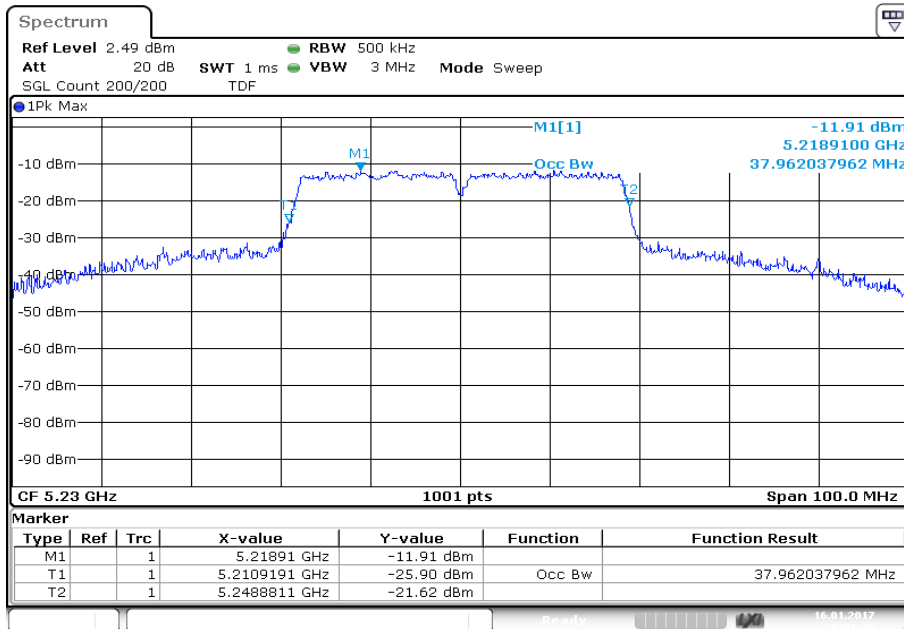

Date: 16.JAN.2017 20:01:36

Plot 3: 5270 MHz

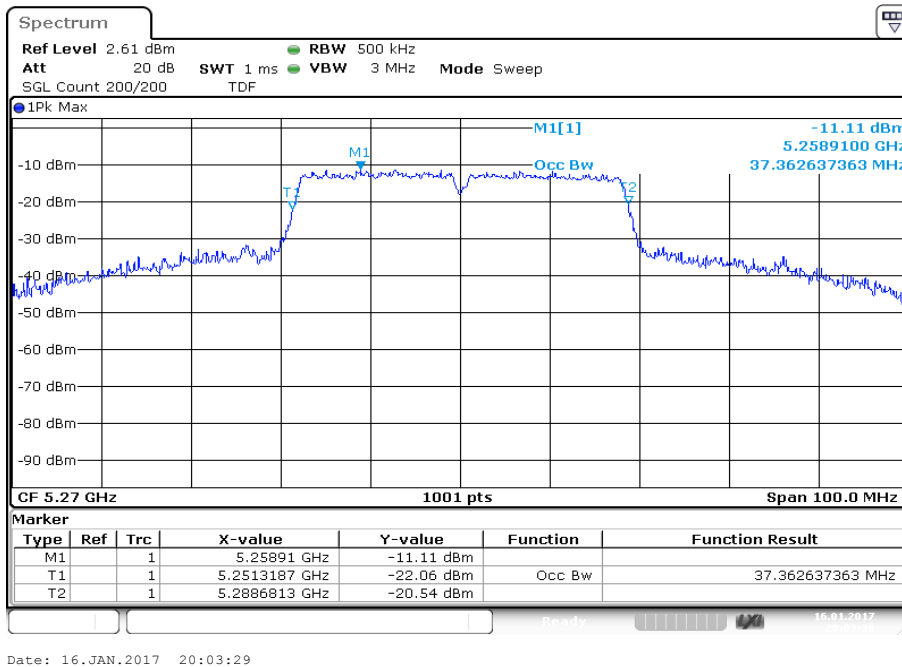

Plot 4: 5310 MHz

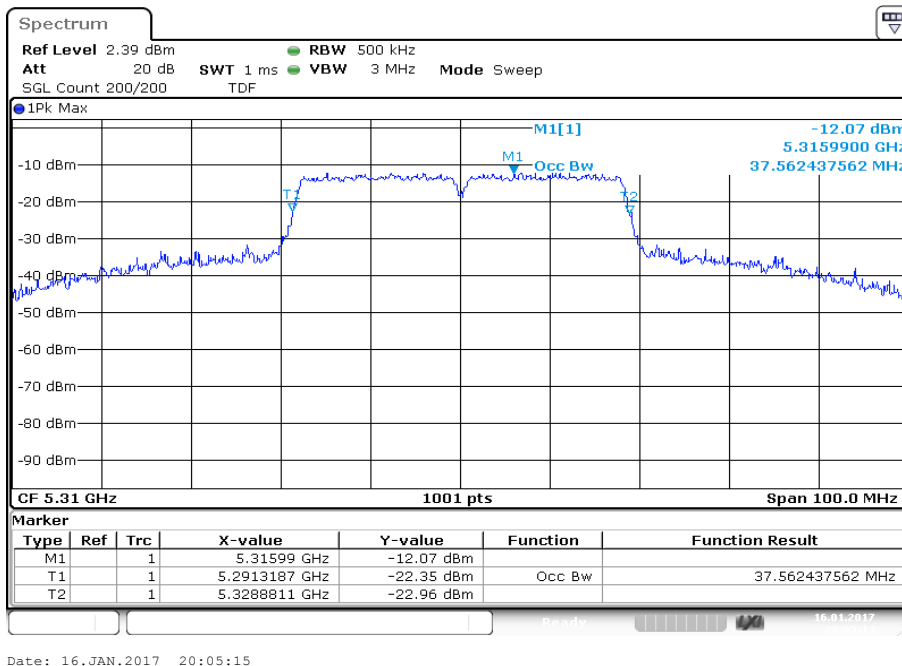

Plot 5: 5755 MHz

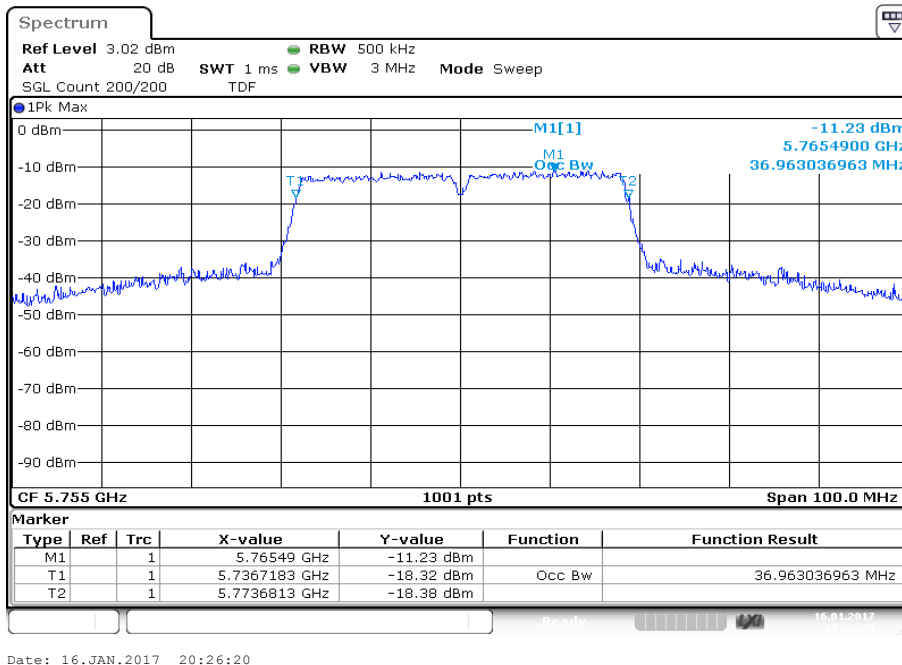

Plot 6: 5795 MHz

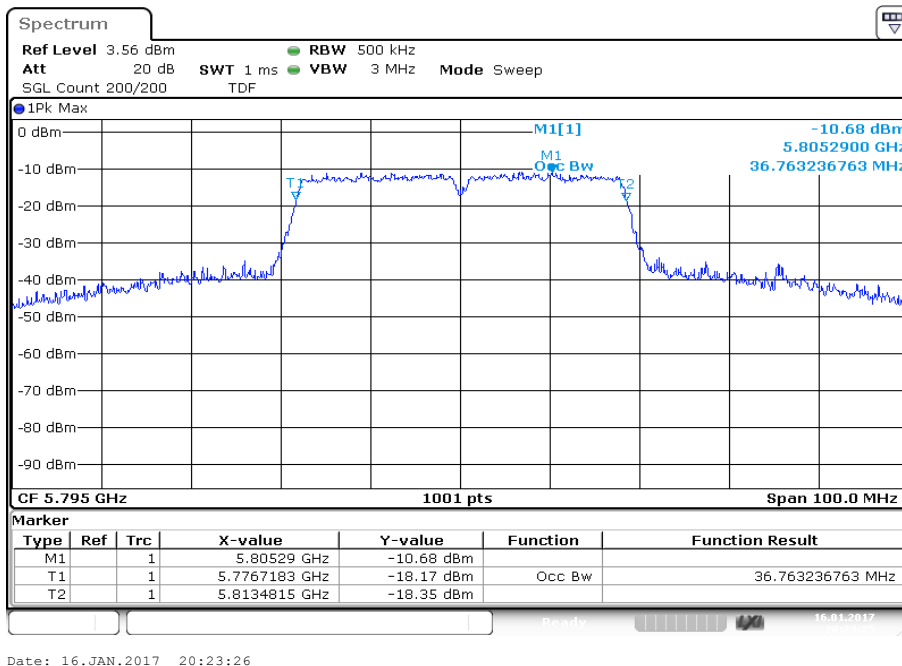

## 11.9 Band edge compliance radiated

### Description:

Measurement of the radiated band edge compliance. The EUT is turned in the position that results in the maximum level at the band edge. Then a sweep over the corresponding restricted band is performed. The EUT is set to the lowest channel for the lower restricted band and to the highest channel for the upper restricted band. Measurement distance is 3m.

### Measurement:

Measurement parameter	
Detector:	Peak / RMS
Sweep time:	Auto
Resolution bandwidth:	1 MHz
Video bandwidth:	≥ 3 x RBW
Span:	See plots!
Trace – mode:	Max Hold
Test setup:	See sub clause 6.2 – A
Measurement uncertainty:	See sub clause 8

### Limits:

Band Edge Compliance Radiated
In any 100 kHz bandwidth outside the frequency band in which the spread spectrum or digitally modulated intentional radiator is operating, the radio frequency power that is produced by the intentional radiator shall be at least 20 dB below that in the 100 kHz bandwidth within the band that contains the highest level of the desired power, based on either an RF conducted or a radiated measurement. Attenuation below the general limits specified in Section 15.209(a) is not required. In addition, radiated emissions which fall in the restricted bands, as defined in Section 15.205(a), must also comply with the radiated emission limits specified in Section 15.209(a) (see Section 5.205(c)).
74 dBµV/m (peak) 54 dBµV/m (average)

### Result:

Scenario	Band Edge Compliance Radiated [dBµV/m]
band edge	< 74 dBµV/m (peak) < 54 dBµV/m (average)



**Plots:**

**Plot 1:** lower band edge, vertical & horizontal polarization – OFDM 20 MHz, 5180 MHz

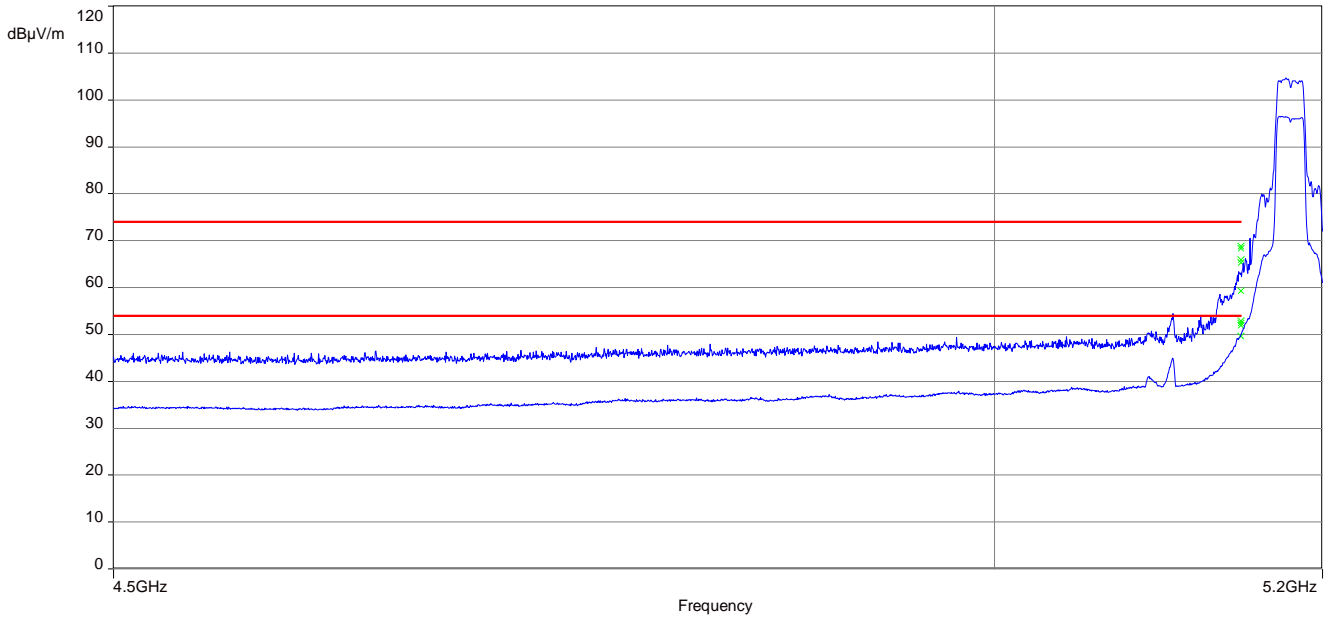

**Plot 2:** upper band edge, vertical & horizontal polarization – OFDM 20 MHz, 5320 MHz

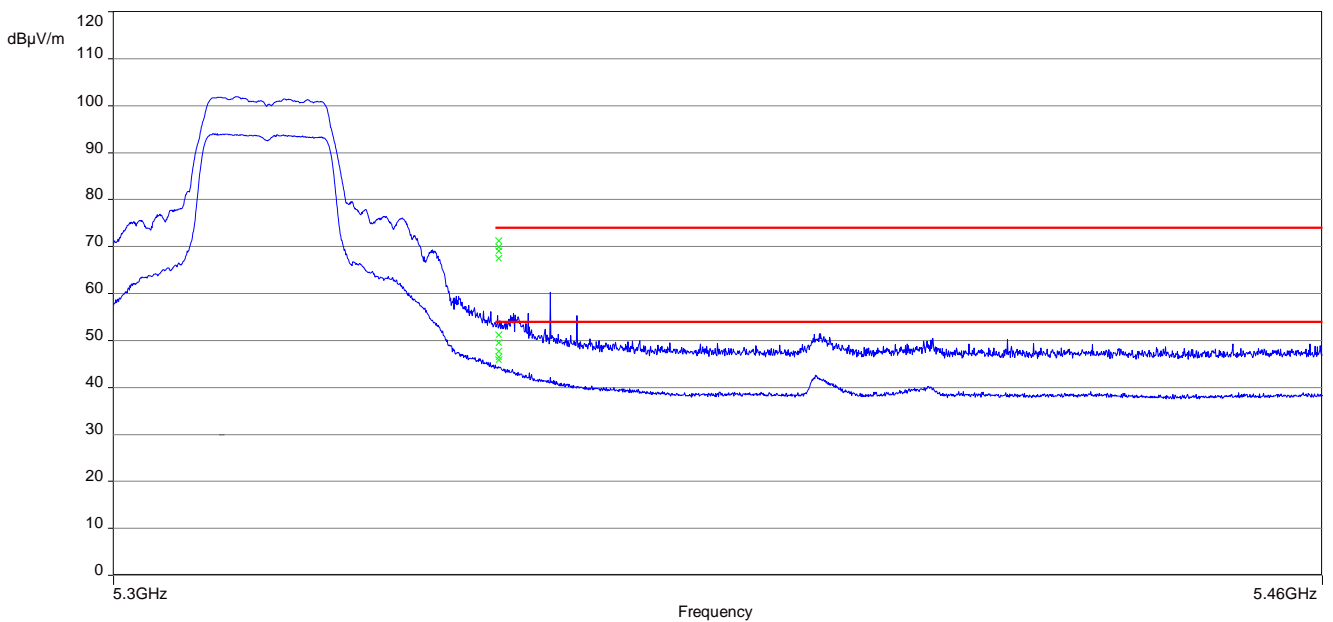

**Plot 3:** lower band edge, vertical & horizontal polarization – OFDM 40 MHz, 5190 MHz

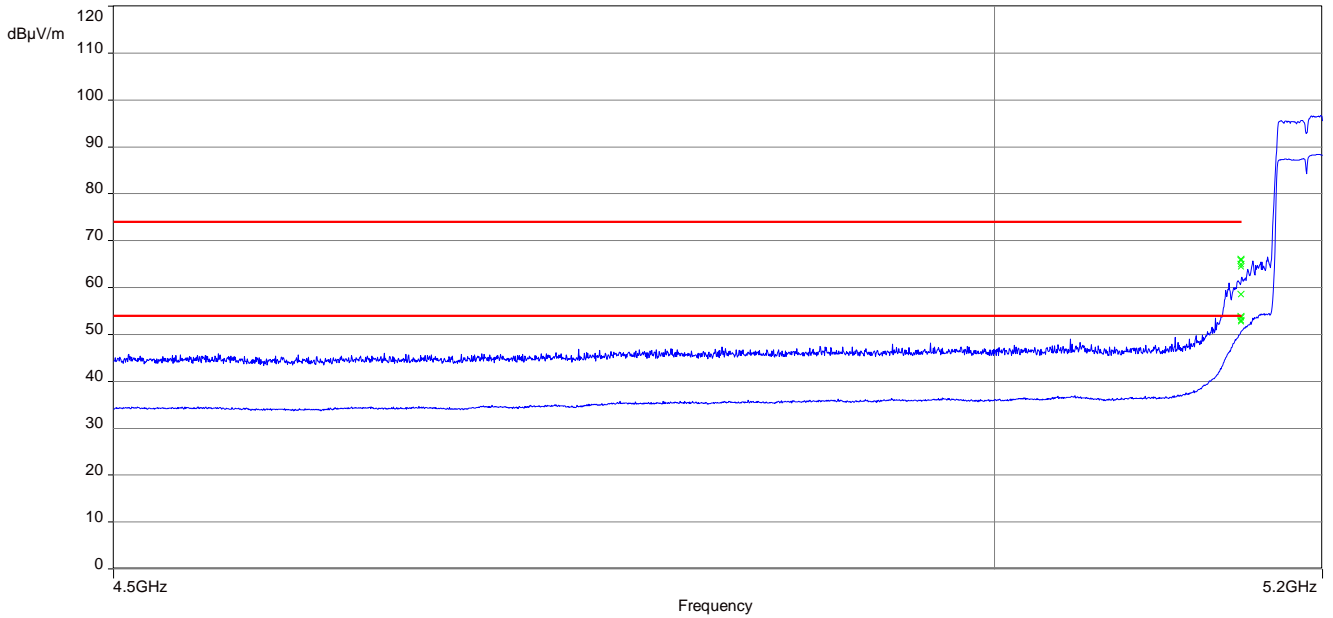

**Plot 4:** upper band edge, vertical & horizontal polarization – OFDM 40 MHz, 5310 MHz

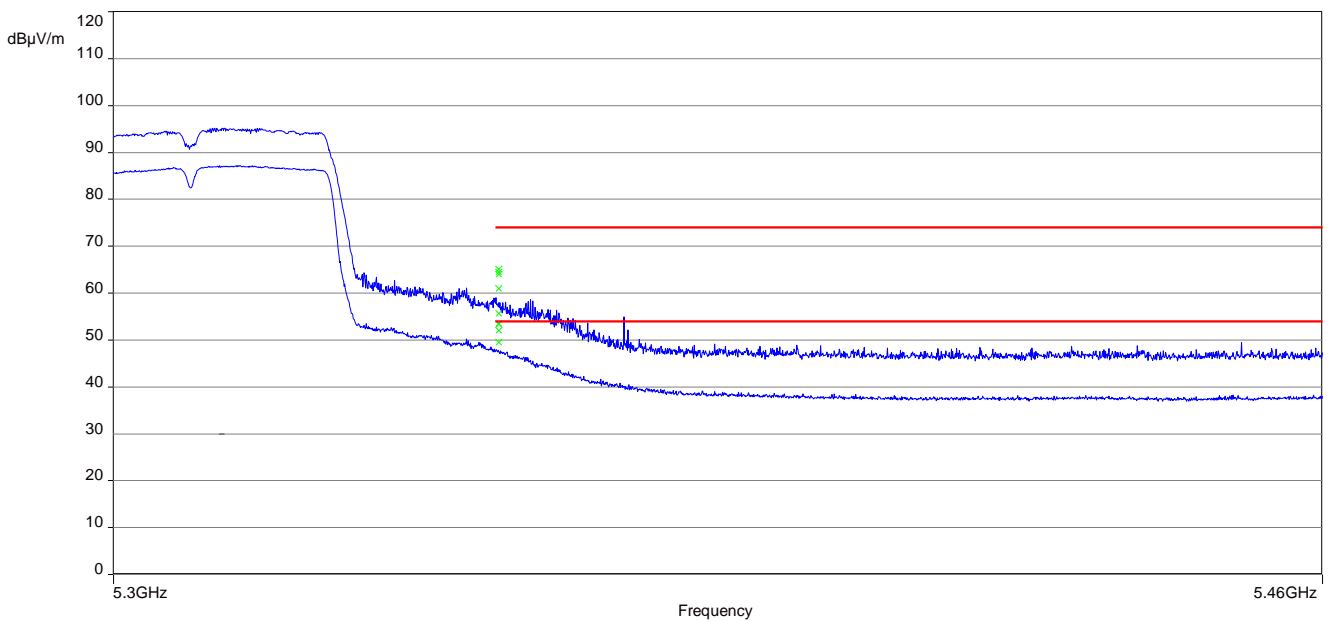

### 11.10 TX spurious emissions radiated

**Description:**

Measurement of the radiated spurious emissions in transmit mode. The measurement is performed at lowest, middle and highest channel.

**Measurement:**

Measurement parameter	
Detector:	Quasi Peak below 1 GHz (alternative Peak) Peak above 1 GHz / RMS
Sweep time:	Auto
Resolution bandwidth:	F < 1 GHz: 100 kHz F > 1 GHz: 1 MHz
Video bandwidth:	F < 1 GHz: 100 kHz F > 1 GHz: ≥ 3 MHz / 1 MHz
Span:	30 MHz to 40 GHz
Trace – mode:	Max Hold / Average with 100 counts + 20 log (1 / X) for duty cycle lower than 100 %
Test setup:	See sub clause 6.1 – A See sub clause 6.2 – A See sub clause 6.3 – A
Measurement uncertainty:	See sub clause 8

**Limits:**

TX Spurious Emissions Radiated		
§15.209		
Frequency (MHz)	Field Strength (dBµV/m)	Measurement distance
30 - 88	30.0	10
88 – 216	33.5	10
216 – 960	36.0	10
Above 960	54.0	3
§15.407		
Outside the restricted bands!	-27 dBm / MHz	

**Results:** OFDM (20 MHz bandwidth)

TX Spurious Emissions Radiated [dBµV/m] / dBm								
Lowest channel 5180 MHz			Middle channel 5240 MHz			Highest channel 5320 MHz		
F [MHz]	Detector	Level [dBµV/m]	F [MHz]	Detector	Level [dBµV/m]	F [MHz]	Detector	Level [dBµV/m]
15531	Peak	54.5	15720	Peak	53.6		Peak	
	AVG	40.7		AVG	42.2		AVG	
	Peak			Peak			Peak	
	AVG			AVG			AVG	
For emissions above 18 GHz please take look at the plots.			For emissions above 18 GHz please take look at the plots.			For emissions above 18 GHz please take look at the plots.		

TX Spurious Emissions Radiated [dBµV/m] / dBm								
Lowest 5745 MHz			Middle 5785 MHz			Highest 5825 MHz		
F [MHz]	Detector	Level [dBµV/m]	F [MHz]	Detector	Level [dBµV/m]	F [MHz]	Detector	Level [dBµV/m]
7660	Peak	50.9		Peak			Peak	
	AVG	45.4		AVG			AVG	
	Peak			Peak			Peak	
	AVG			AVG			AVG	
For emissions above 18 GHz please take look at the plots.			For emissions above 18 GHz please take look at the plots.			For emissions above 18 GHz please take look at the plots.		

**Results:** OFDM (40 MHz bandwidth)

TX Spurious Emissions Radiated [dBµV/m] / dBm								
Lowest channel 5190 MHz			Middle channel 5250 MHz			Highest channel 5310 MHz		
F [MHz]	Detector	Level [dBµV/m]	F [MHz]	Detector	Level [dBµV/m]	F [MHz]	Detector	Level [dBµV/m]
	Peak			Peak			Peak	
	AVG			AVG			AVG	
	Peak			Peak			Peak	
	AVG			AVG			AVG	
For emissions above 18 GHz please take look at the plots.			For emissions above 18 GHz please take look at the plots.			For emissions above 18 GHz please take look at the plots.		

TX Spurious Emissions Radiated [dBµV/m] / dBm								
Lowest 5755 MHz			Middle channel			Highest 5795 MHz		
F [MHz]	Detector	Level [dBµV/m]	F [MHz]	Detector	Level [dBµV/m]	F [MHz]	Detector	Level [dBµV/m]
	Peak			Peak			Peak	
	AVG			AVG			AVG	
	Peak			Peak			Peak	
	AVG			AVG			AVG	
For emissions above 18 GHz please take look at the plots.			For emissions above 18 GHz please take look at the plots.			For emissions above 18 GHz please take look at the plots.		

**Plots:** OFDM / 20 MHz bandwidth

**Plot 1:** 30 MHz to 1 GHz, 5180 MHz, vertical & horizontal polarization

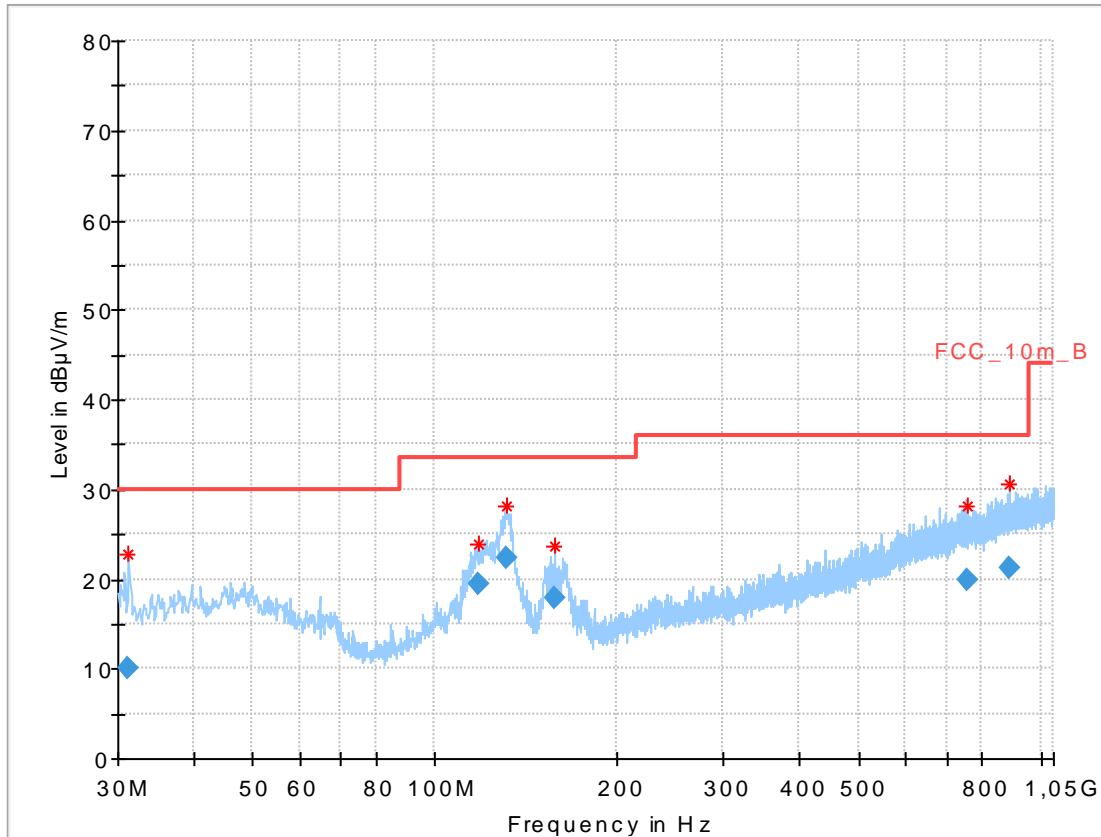

**Final results:**

Frequency (MHz)	QuasiPeak (dBµV/m)	Limit (dBµV/m)	Margin (dB)	Meas. Time (ms)	Bandwidth (kHz)	Height (cm)	Pol	Azimuth (deg)	Corr. (dB)
31.260900	9.97	30.00	20.03	1000.0	120.000	170.0	V	-8.0	12.0
117.700800	19.46	33.50	14.04	1000.0	120.000	170.0	V	10.0	10.5
131.246700	22.43	33.50	11.07	1000.0	120.000	98.0	V	100.0	9.5
157.572300	17.92	33.50	15.58	1000.0	120.000	101.0	V	100.0	9.6
755.312100	19.86	36.00	16.14	1000.0	120.000	170.0	H	172.0	22.7
885.332700	21.24	36.00	14.76	1000.0	120.000	170.0	V	81.0	24.0

**Plot 2:** 1 GHz to 18 GHz, 5180 MHz, vertical & horizontal polarization

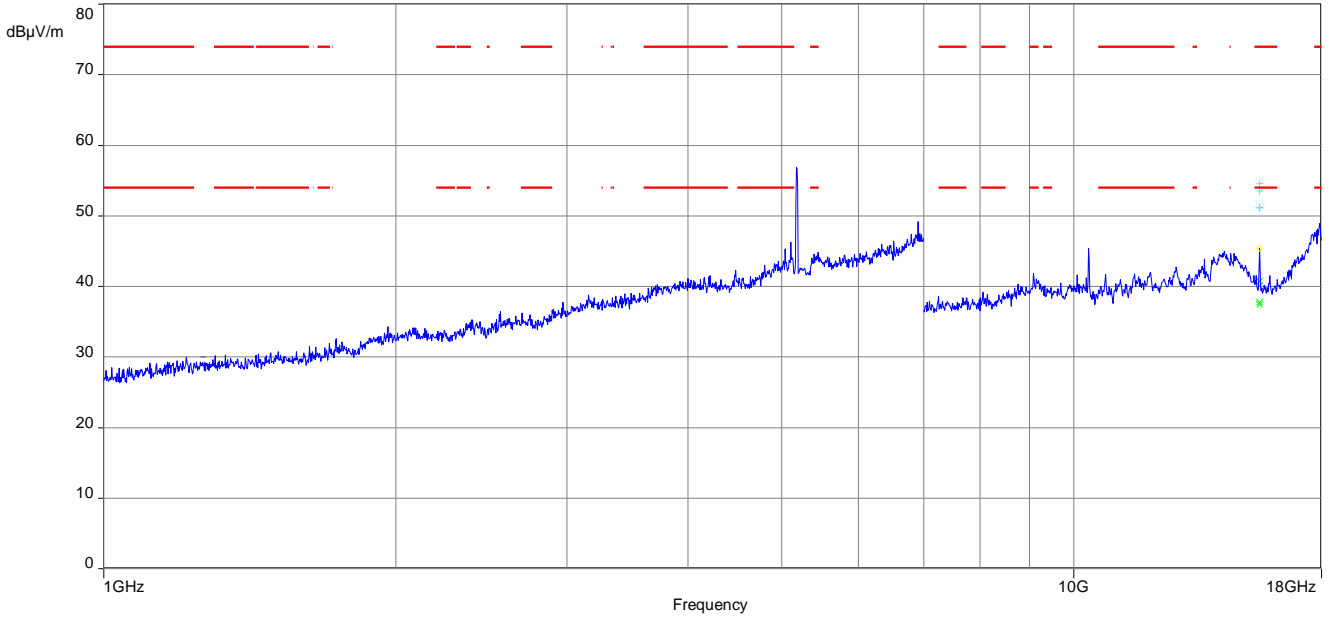

The carrier signal is notched with a band rejection filter.

**Plot 3:** 18 GHz to 26 GHz, 5180 MHz, vertical & horizontal polarization

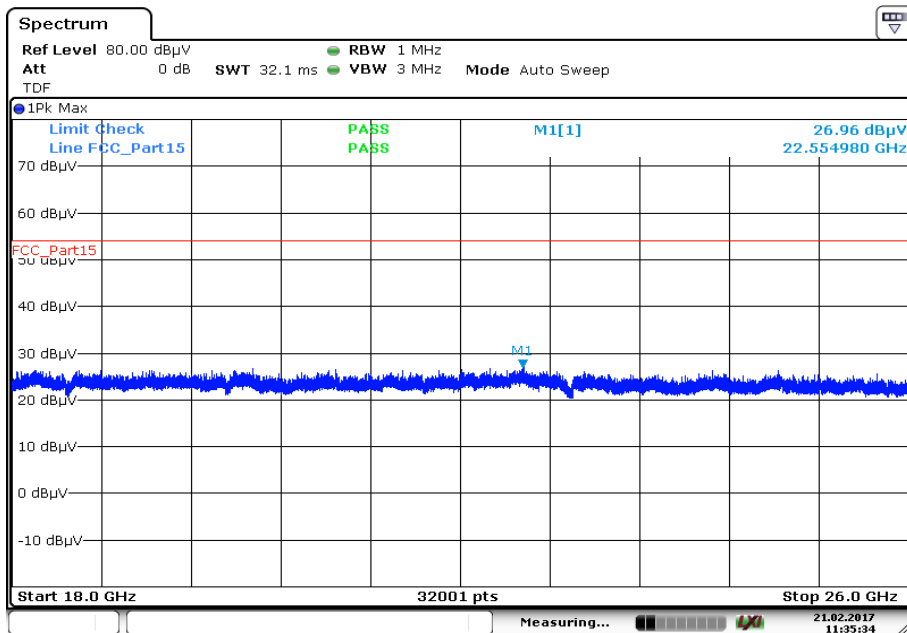

**Plot 4:** 26 GHz to 40 GHz, 5180 MHz, vertical & horizontal polarization

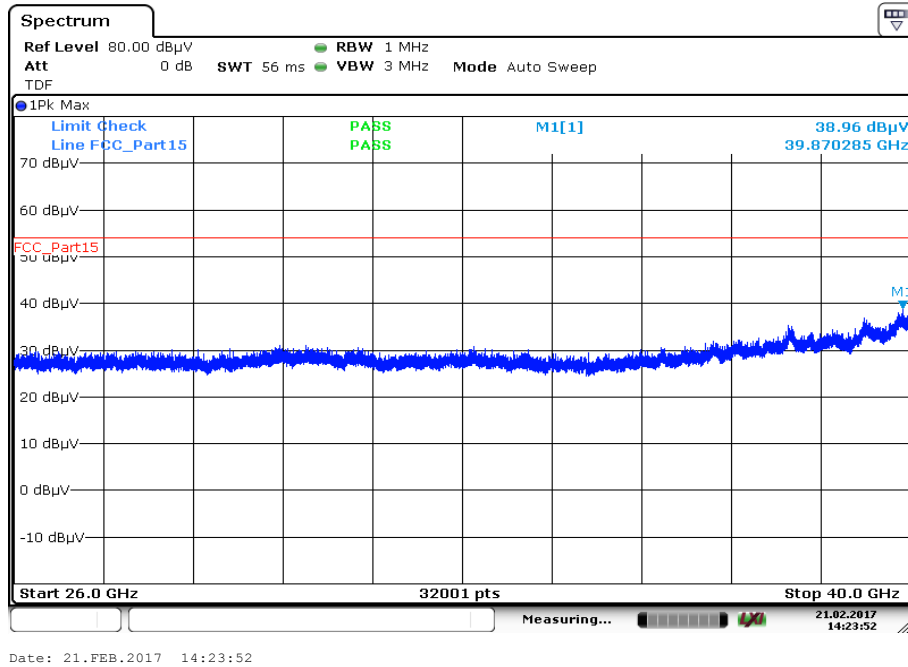



**Plot 5:** 30 MHz to 1 GHz, 5240 MHz, vertical & horizontal polarization

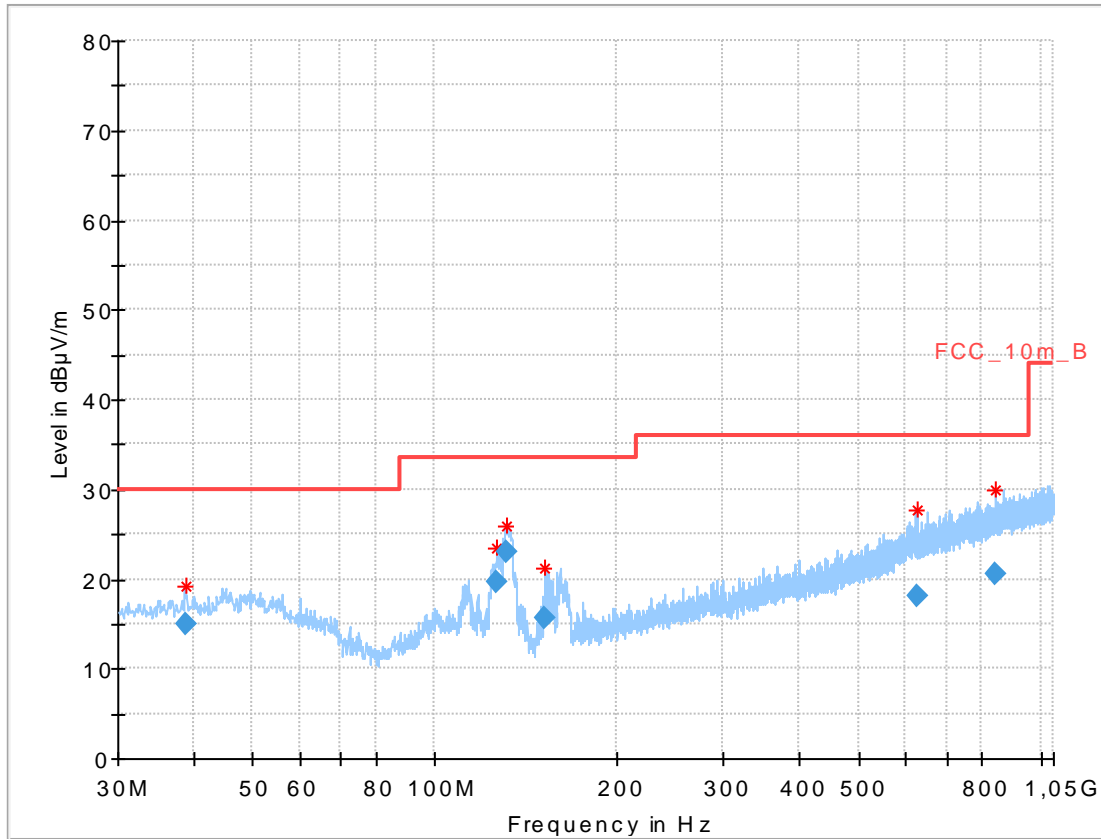

**Final results:**

Frequency (MHz)	QuasiPeak (dBµV/m)	Limit (dBµV/m)	Margin (dB)	Meas. Time (ms)	Bandwidth (kHz)	Height (cm)	Pol	Azimuth (deg)	Corr. (dB)
38.725200	14.93	30.00	15.07	1000.0	120.000	101.0	V	87.0	13.1
126.831150	19.74	33.50	13.76	1000.0	120.000	185.0	V	153.0	9.8
131.843400	22.98	33.50	10.52	1000.0	120.000	98.0	V	107.0	9.4
152.318400	15.58	33.50	17.92	1000.0	120.000	98.0	V	94.0	9.4
623.319600	18.04	36.00	17.96	1000.0	120.000	101.0	H	213.0	20.9
842.104500	20.63	36.00	15.37	1000.0	120.000	185.0	H	319.0	23.4

**Plot 6:** 1 GHz to 18 GHz, 5240 MHz, vertical & horizontal polarization

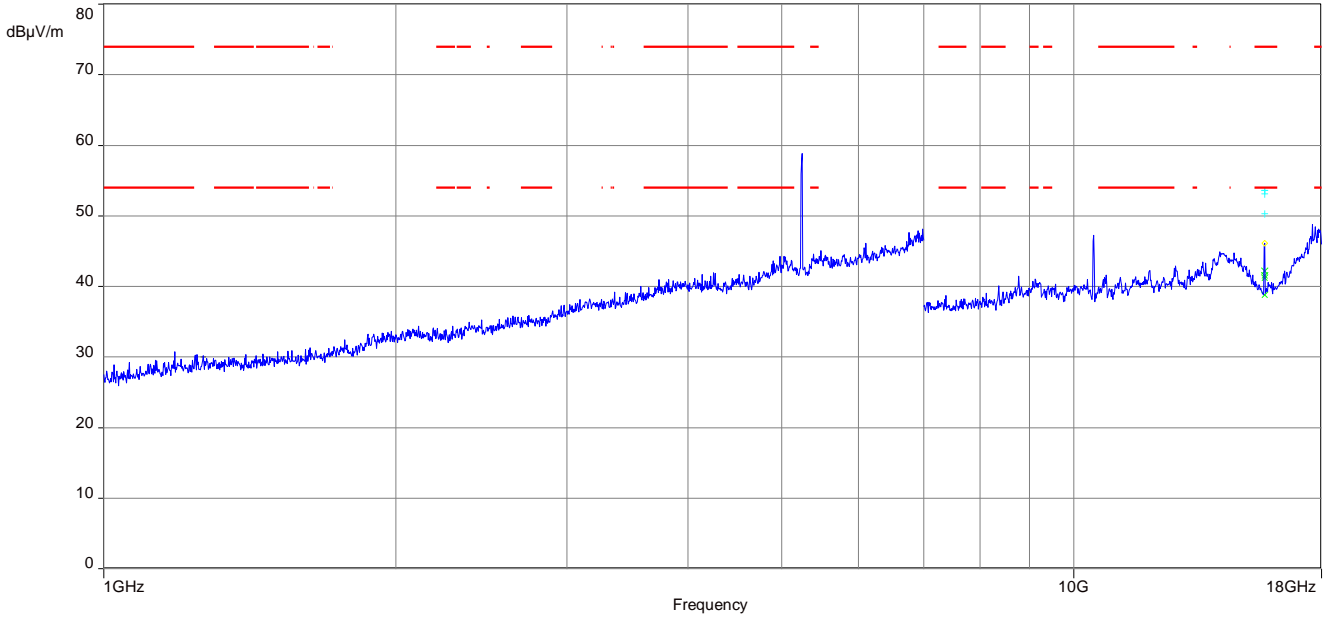

The carrier signal is notched with a band rejection filter.

**Plot 7:** 18 GHz to 26 GHz, 5240 MHz, vertical & horizontal polarization

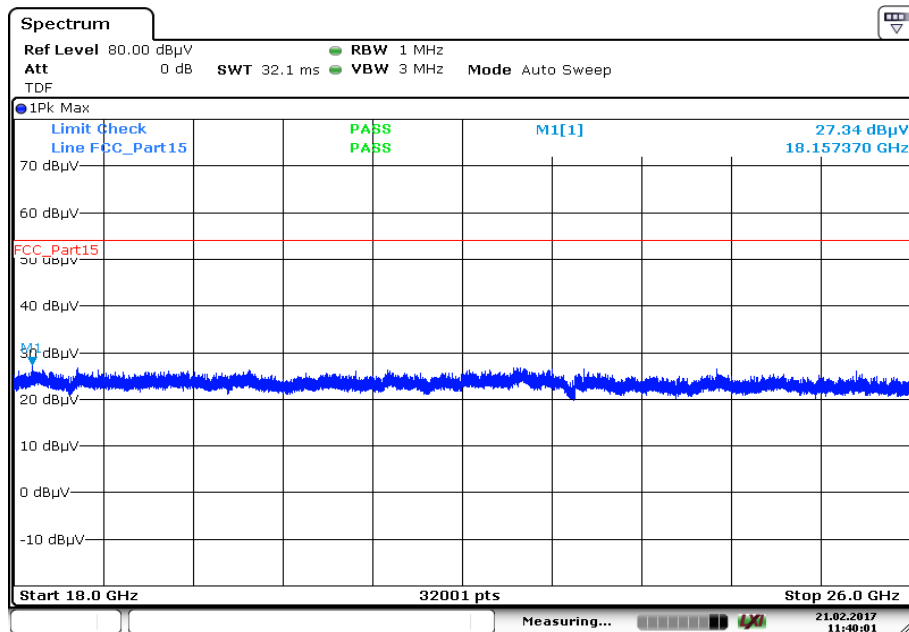

**Plot 8:** 26 GHz to 40 GHz, 5240 MHz, vertical & horizontal polarization

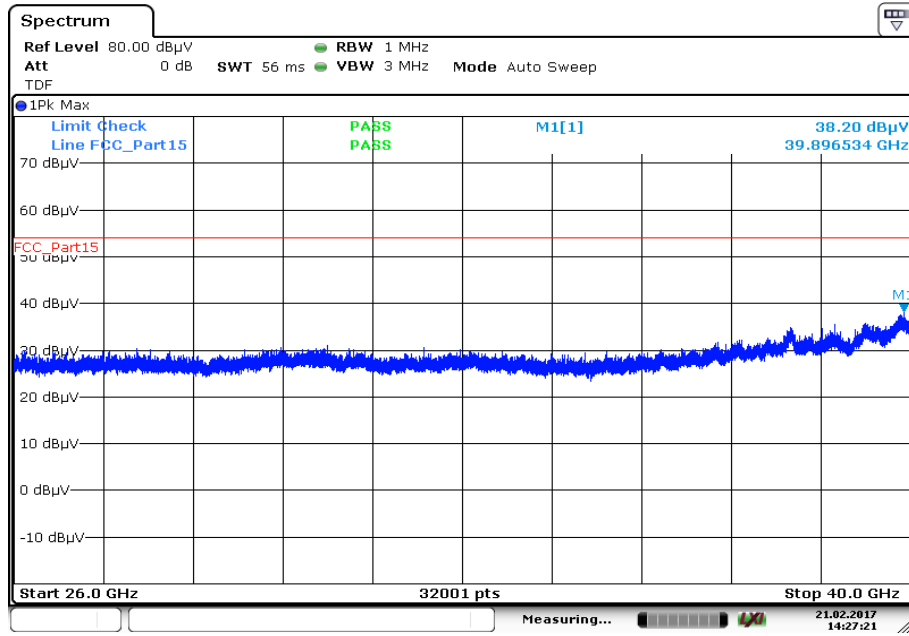

Date: 21.FEB.2017 14:27:21

**Plot 9:** 30 MHz to 1 GHz, 5320 MHz, vertical & horizontal polarization

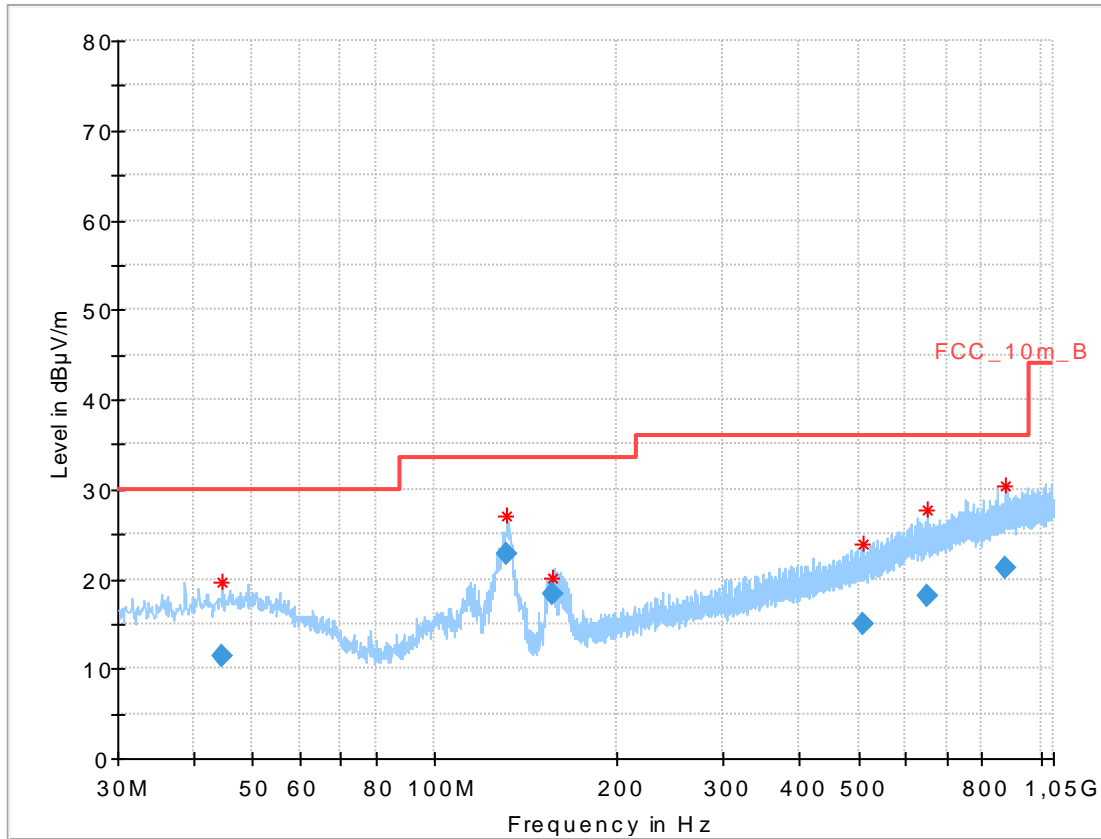

**Final results:**

Frequency (MHz)	QuasiPeak (dBµV/m)	Limit (dBµV/m)	Margin (dB)	Meas. Time (ms)	Bandwidth (kHz)	Height (cm)	Pol	Azimuth (deg)	Corr. (dB)
44.600850	11.33	30.00	18.67	1000.0	120.000	101.0	V	142.0	13.6
131.792550	22.72	33.50	10.78	1000.0	120.000	98.0	V	12.0	9.4
157.026000	18.24	33.50	15.26	1000.0	120.000	98.0	V	115.0	9.6
511.330500	15.03	36.00	20.97	1000.0	120.000	185.0	H	204.0	18.9
651.681000	18.21	36.00	17.79	1000.0	120.000	185.0	H	273.0	21.1
874.413150	21.30	36.00	14.70	1000.0	120.000	178.0	H	30.0	23.9

**Plot 10:** 1 GHz to 7 GHz, 5320 MHz, vertical & horizontal polarization

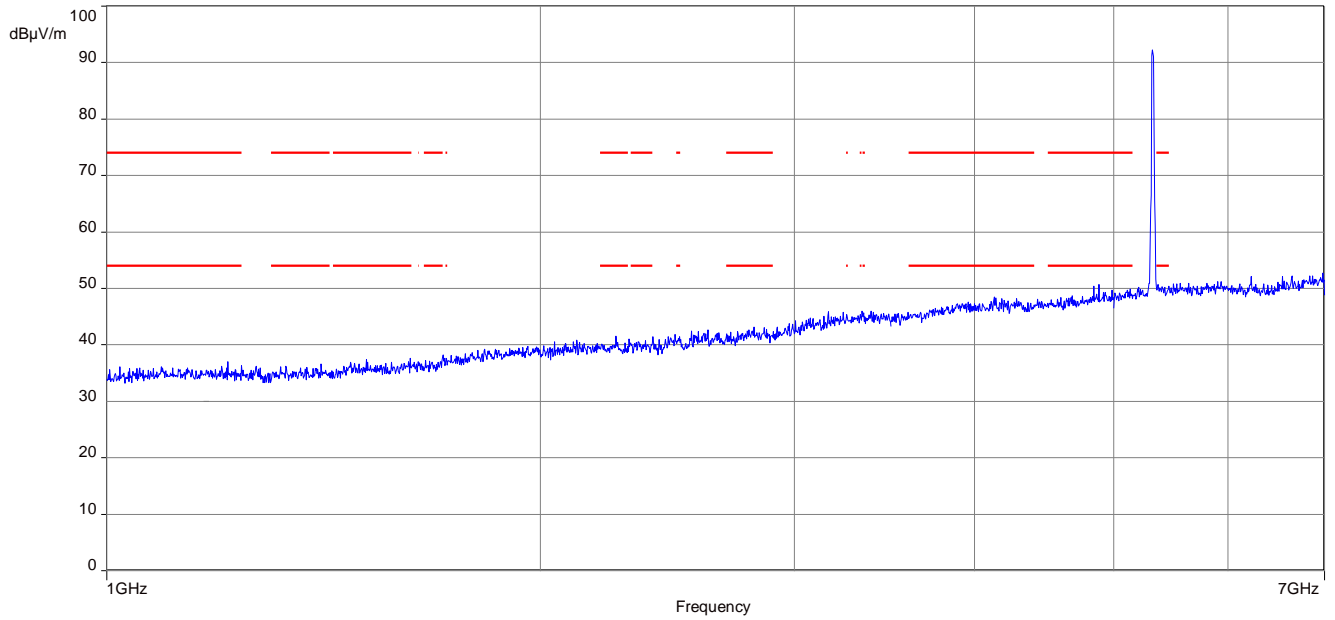

**Plot 11:** 1 GHz to 7 GHz, 5320 MHz, vertical & horizontal polarization

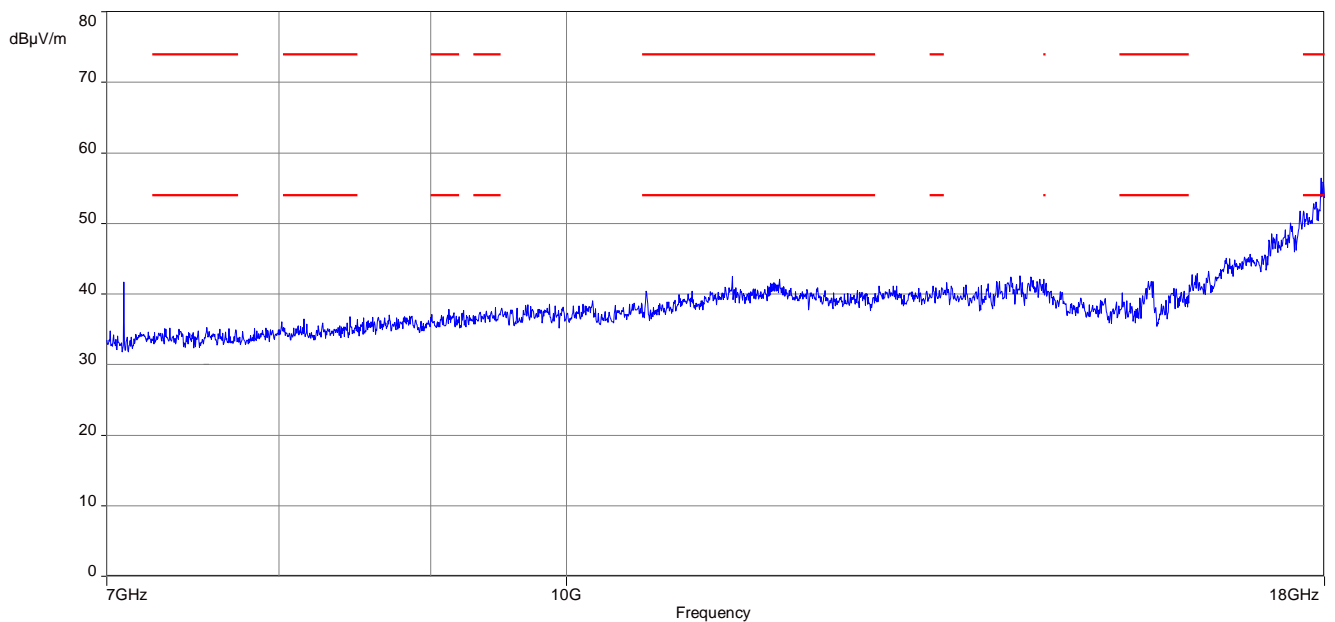

**Plot 12:** 17.7 GHz to 18 GHz, 5320 MHz, vertical & horizontal polarization

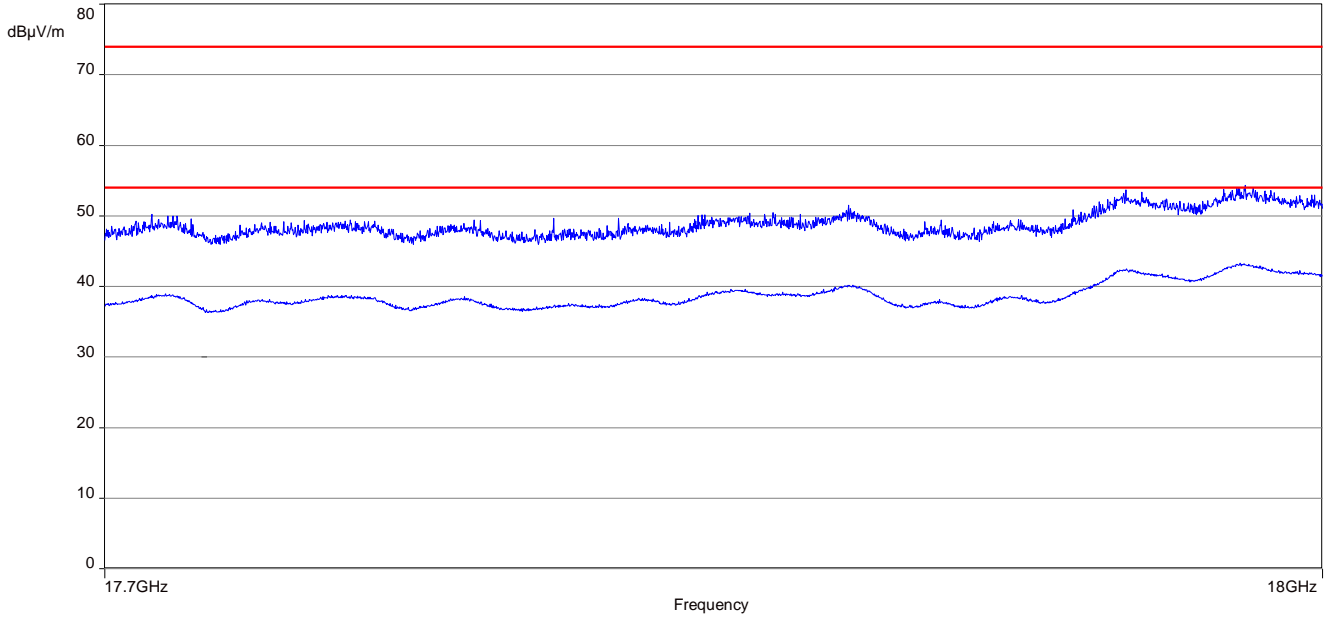

**Plot 13:** 18 GHz to 26 GHz, 5320 MHz, vertical & horizontal polarization

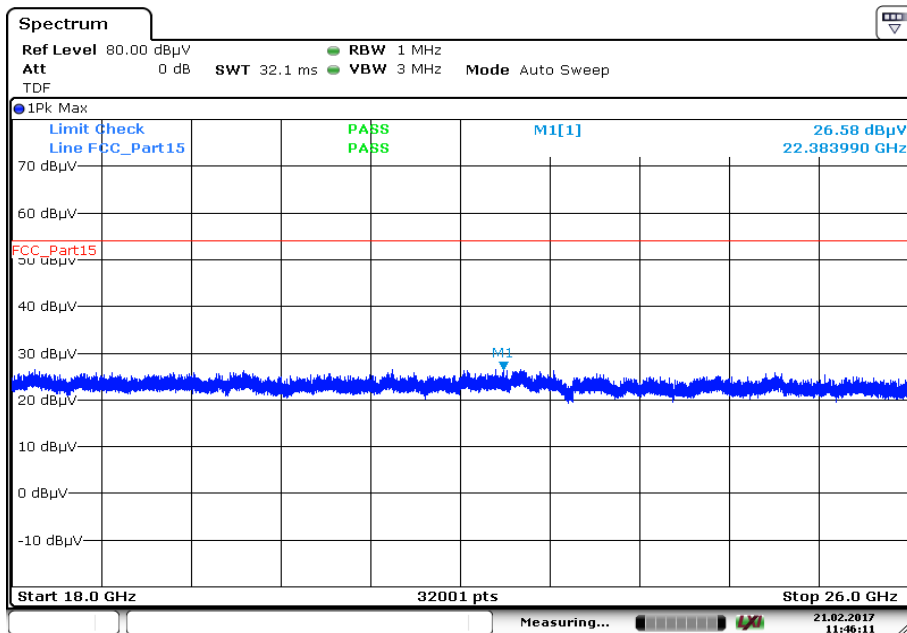

Plot 14: 26 GHz to 40 GHz, 5320 MHz, vertical & horizontal polarization

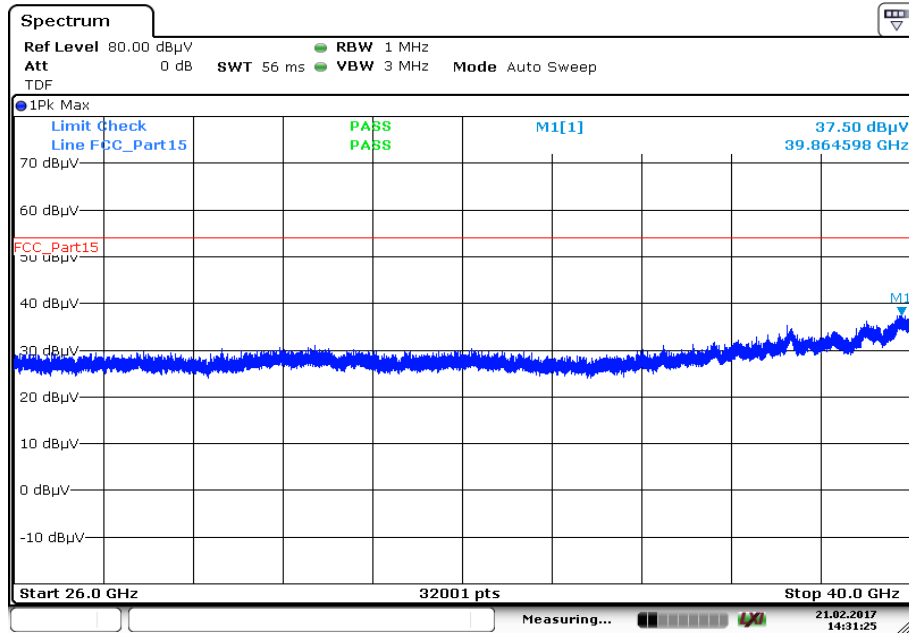

Date: 21.FEB.2017 14:31:25

**Plot 15:** 30 MHz to 1 GHz, 5745 MHz, vertical & horizontal polarization

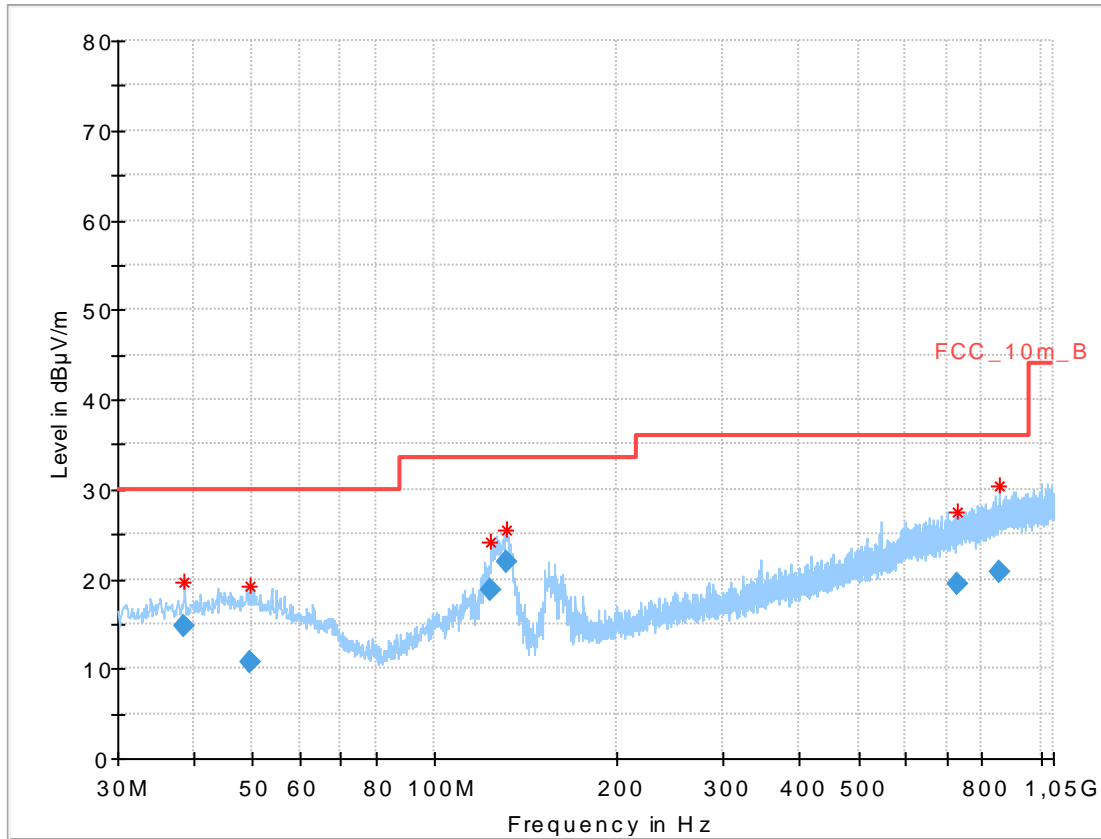

**Final results:**

Frequency (MHz)	QuasiPeak (dBµV/m)	Limit (dBµV/m)	Margin (dB)	Meas. Time (ms)	Bandwidth (kHz)	Height (cm)	Pol	Azimuth (deg)	Corr. (dB)
38.700900	14.64	30.00	15.36	1000.0	120.000	185.0	V	96.0	13.1
49.456200	10.69	30.00	19.31	1000.0	120.000	101.0	V	275.0	13.7
123.987750	18.69	33.50	14.81	1000.0	120.000	185.0	V	75.0	10.0
131.250150	21.84	33.50	11.66	1000.0	120.000	185.0	V	137.0	9.5
730.084200	19.52	36.00	16.48	1000.0	120.000	185.0	H	118.0	22.3
855.198150	20.77	36.00	15.23	1000.0	120.000	98.0	V	248.0	23.6



**Plot 16:** 1 GHz to 7 GHz, 5745 MHz, vertical & horizontal polarization

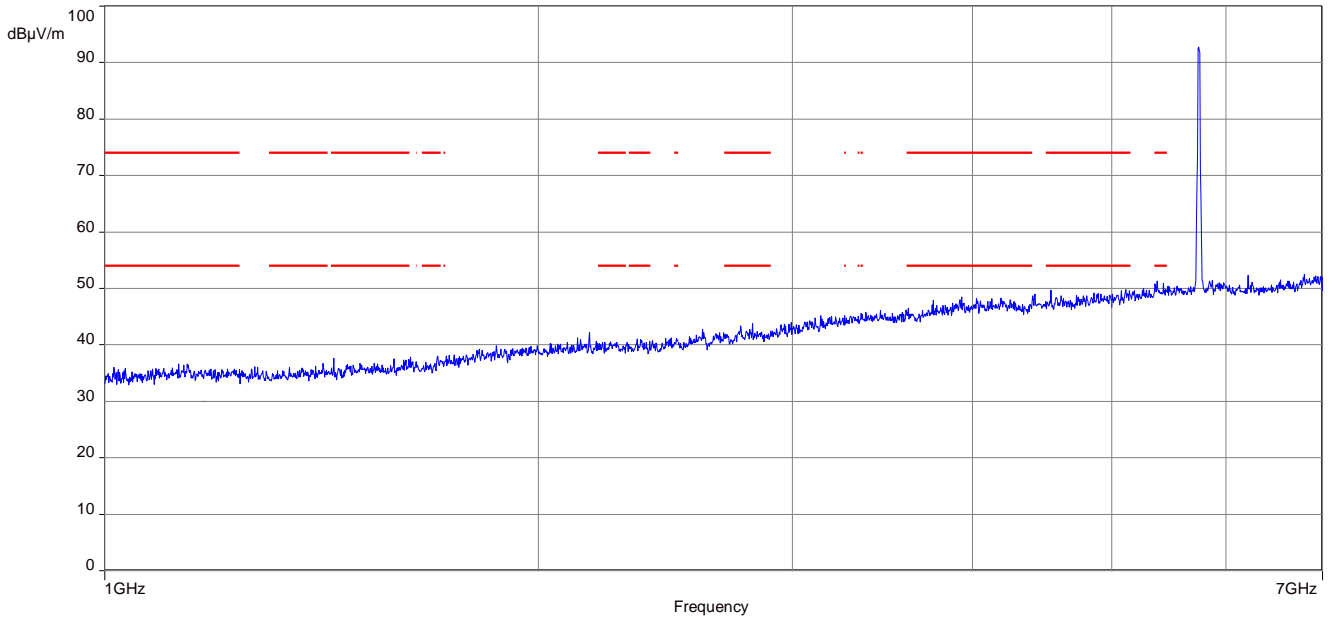

**Plot 17:** 7 GHz to 18 GHz, 5745 MHz, vertical & horizontal polarization

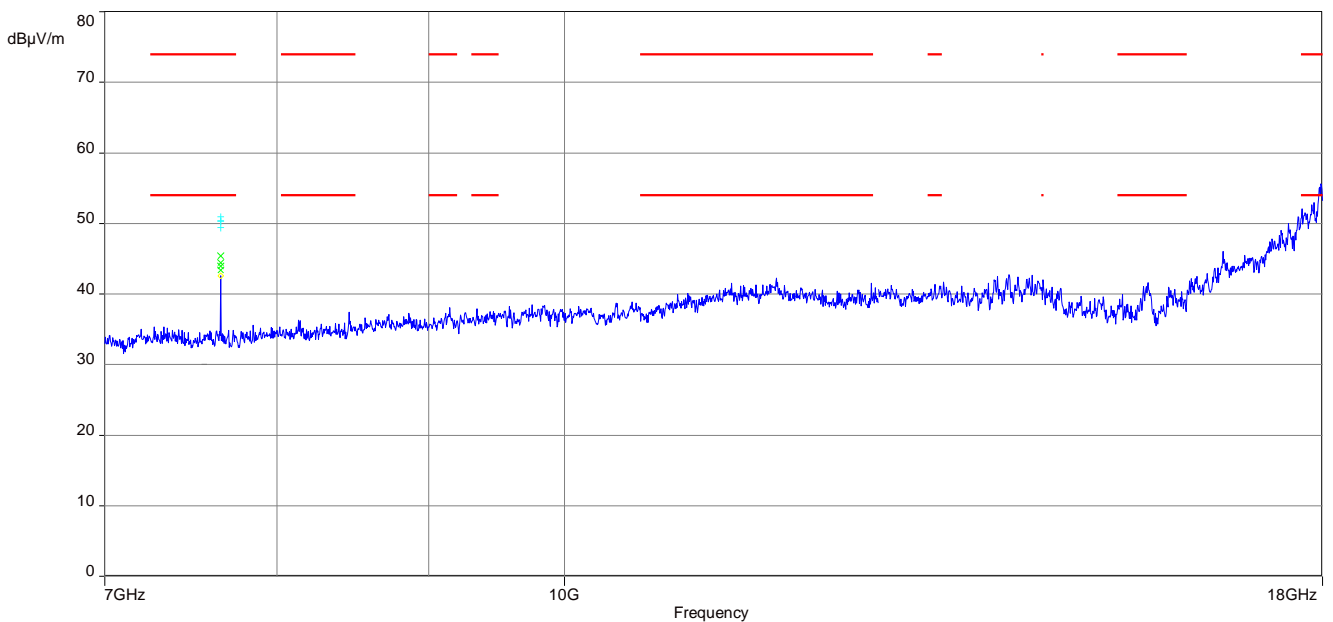

**Plot 18:** 17.7 GHz to 18 GHz, 5745 MHz, vertical & horizontal polarization

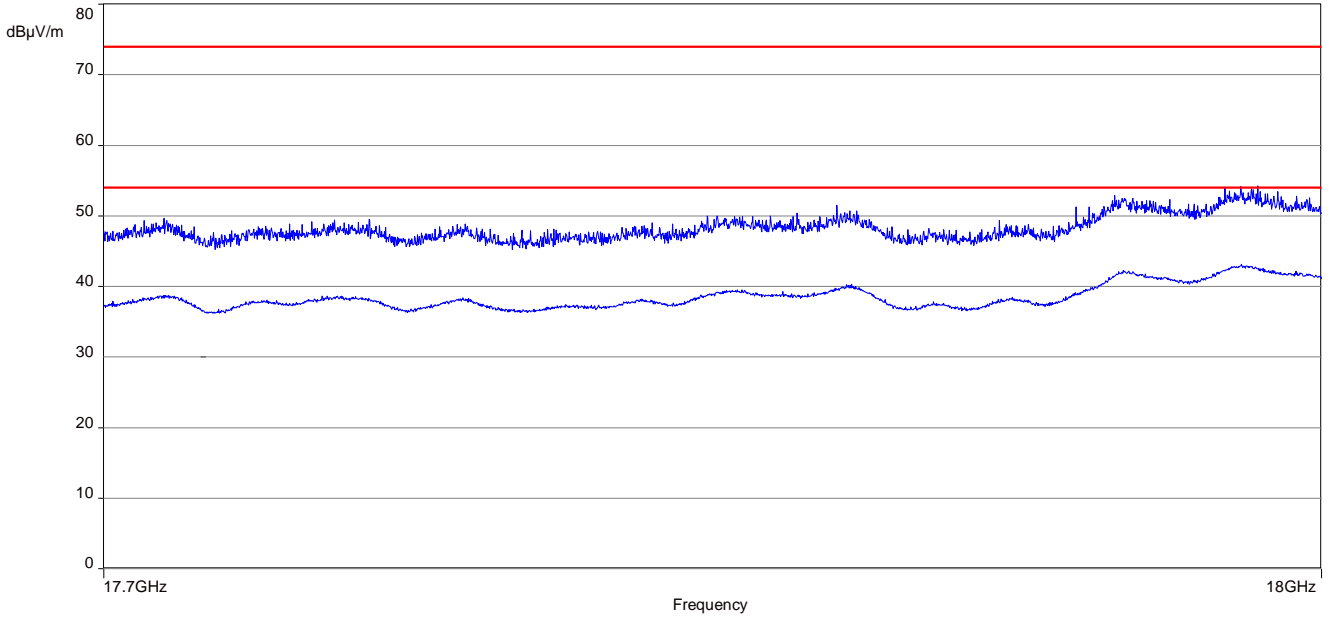

**Plot 19:** 18 GHz to 26 GHz, 5745 MHz, vertical & horizontal polarization

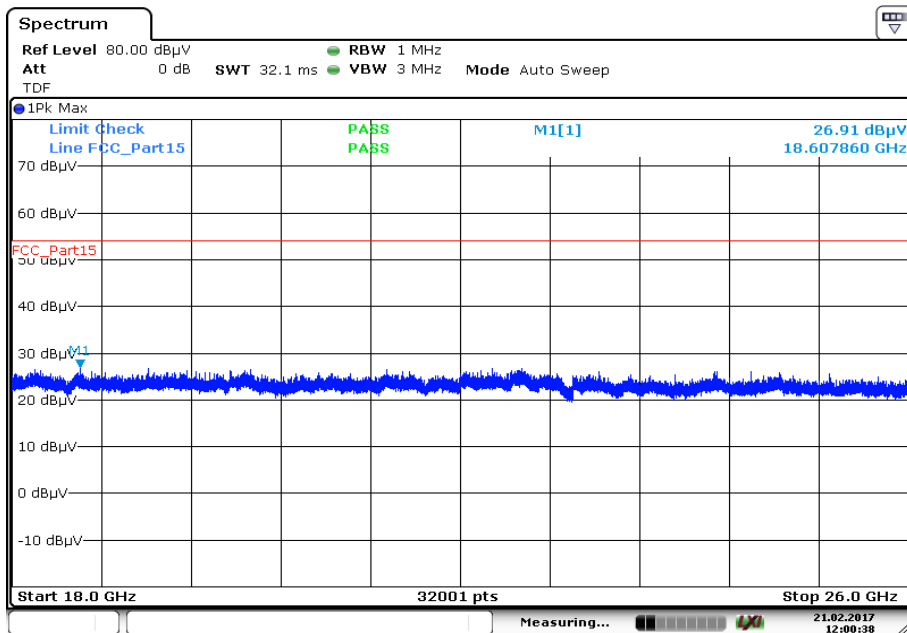

Date: 21.FEB.2017 12:00:38

Plot 20: 26 GHz to 40 GHz, 5745 MHz, vertical & horizontal polarization

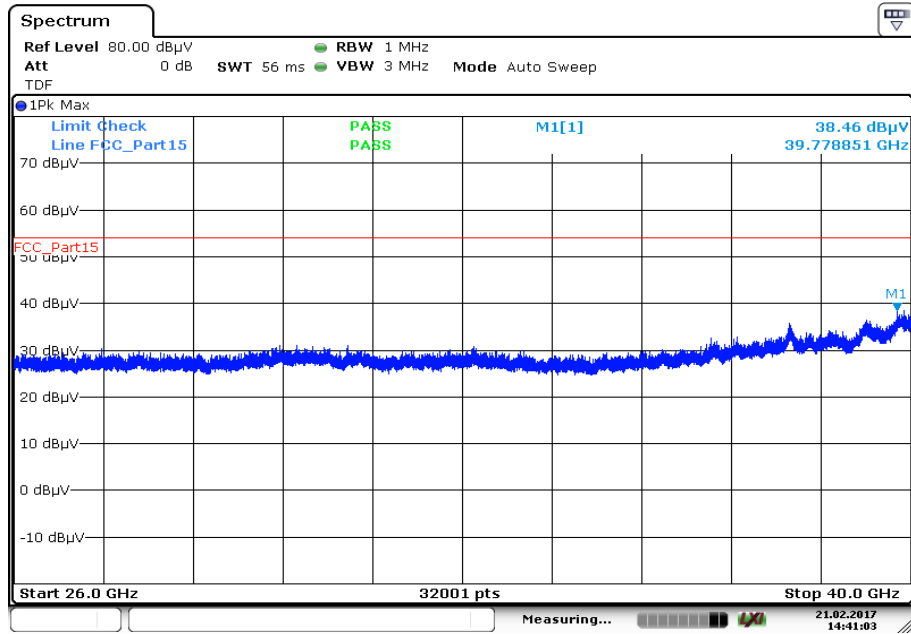

Date: 21.FEB.2017 14:41:03

**Plot 21:** 30 MHz to 1 GHz, 5785 MHz, vertical & horizontal polarization

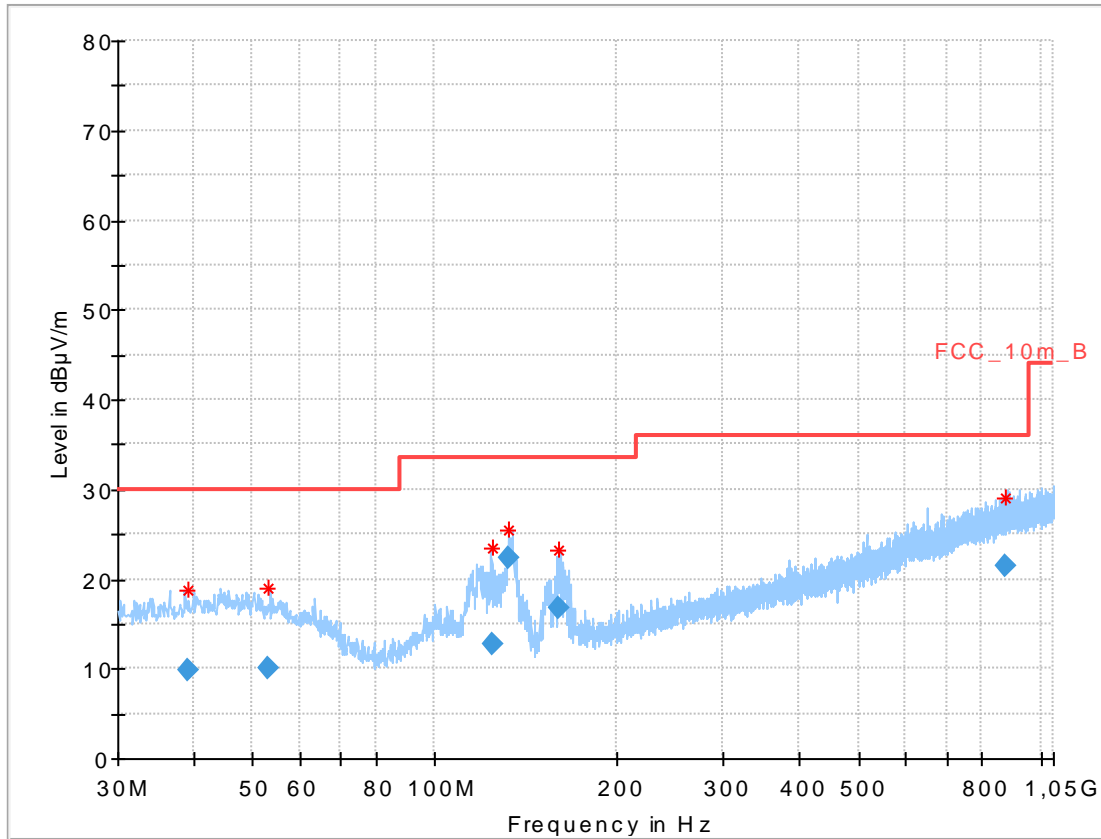

**Final results:**

Frequency (MHz)	QuasiPeak (dBµV/m)	Limit (dBµV/m)	Margin (dB)	Meas. Time (ms)	Bandwidth (kHz)	Height (cm)	Pol	Azimuth (deg)	Corr. (dB)
39.185850	9.78	30.00	20.22	1000.0	120.000	170.0	V	280.0	13.1
53.084550	9.95	30.00	20.05	1000.0	120.000	101.0	V	190.0	13.3
124.179000	12.66	33.50	20.84	1000.0	120.000	100.0	V	10.0	10.0
132.454800	22.31	33.50	11.19	1000.0	120.000	101.0	V	81.0	9.4
160.737600	16.71	33.50	16.79	1000.0	120.000	98.0	V	81.0	9.7
873.139200	21.35	36.00	14.65	1000.0	120.000	170.0	H	170.0	23.8

**Plot 22:** 1 GHz to 7 GHz, 5785 MHz, vertical & horizontal polarization

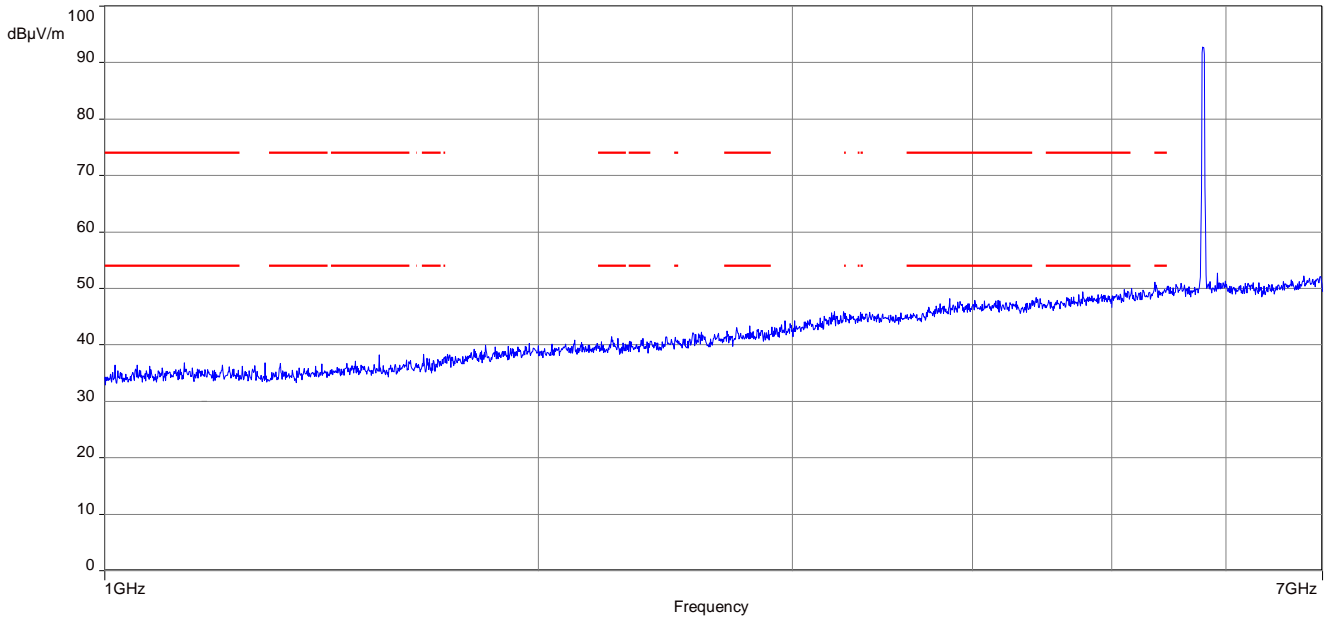

**Plot 23:** 7 GHz to 18 GHz, 5785 MHz, vertical & horizontal polarization

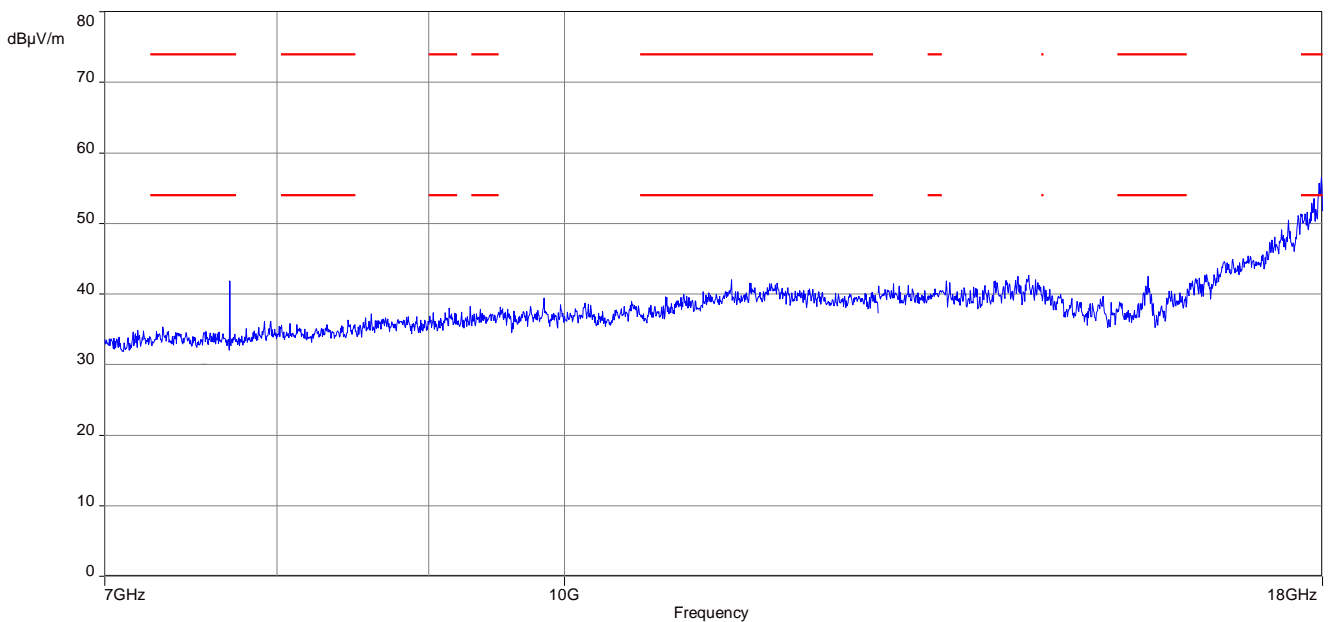

**Plot 24:** 17.7 GHz to 18 GHz, 5785 MHz, vertical & horizontal polarization

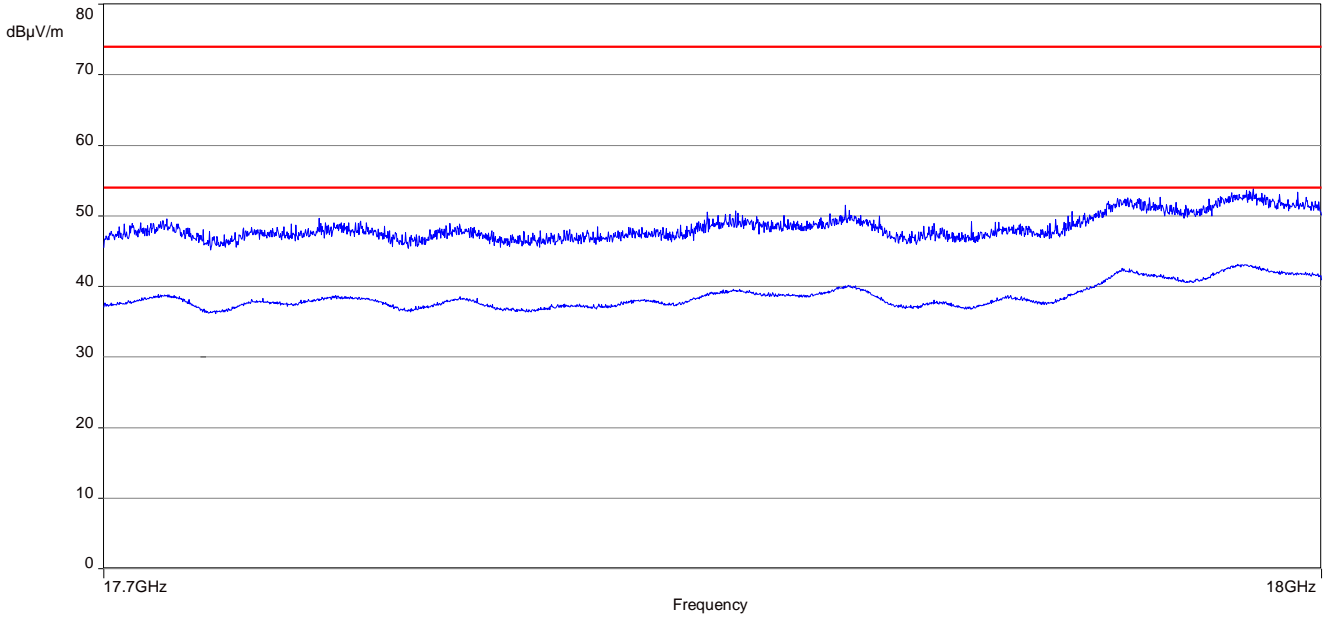

**Plot 25:** 18 GHz to 26 GHz, 5785 MHz, vertical & horizontal polarization

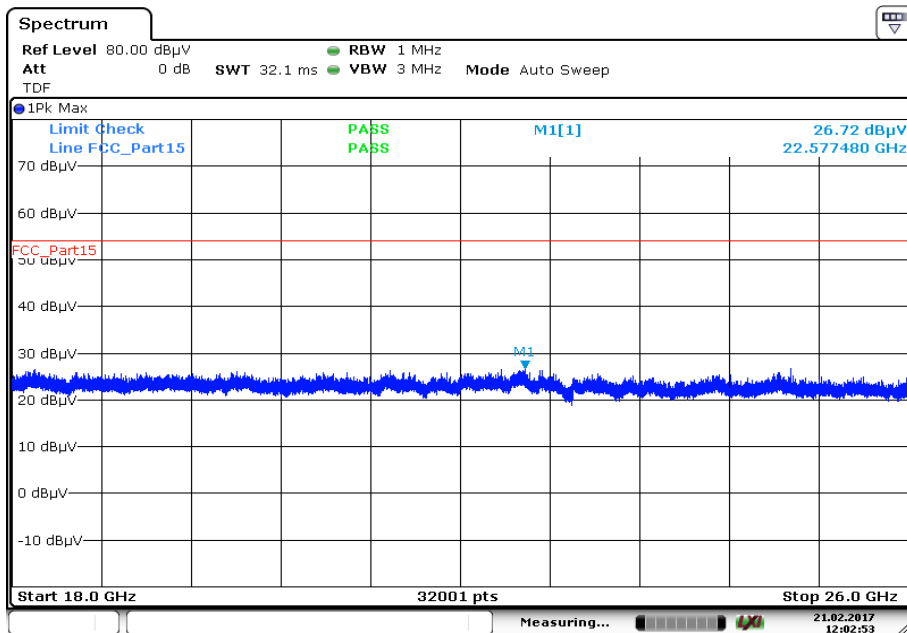

Plot 26: 26 GHz to 40 GHz, 5785 MHz, vertical & horizontal polarization

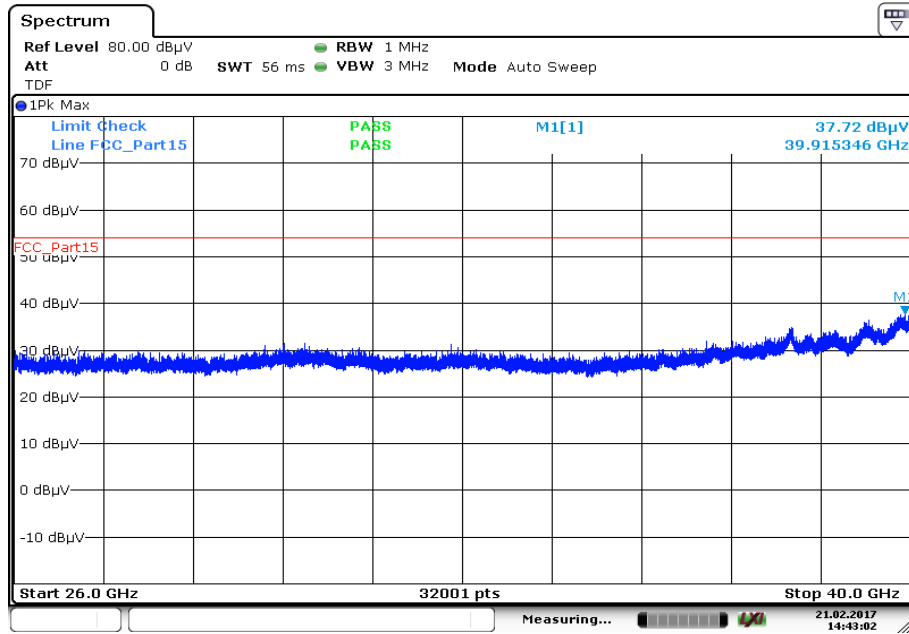

Date: 21.FEB.2017 14:43:02

**Plot 27:** 30 MHz to 1 GHz, 5825 MHz, vertical & horizontal polarization

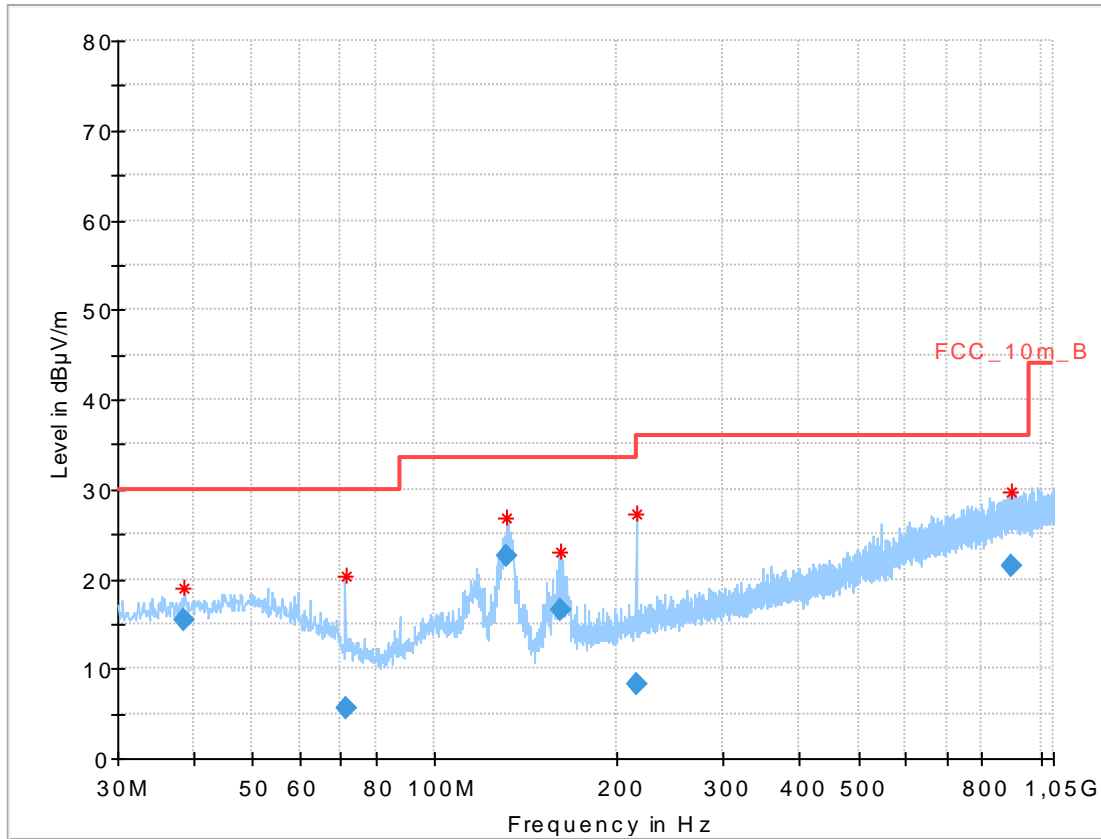

**Final results:**

Frequency (MHz)	QuasiPeak (dBµV/m)	Limit (dBµV/m)	Margin (dB)	Meas. Time (ms)	Bandwidth (kHz)	Height (cm)	Pol	Azimuth (deg)	Corr. (dB)
38.698950	15.33	30.00	14.67	1000.0	120.000	101.0	V	190.0	13.1
71.313000	5.55	30.00	24.45	1000.0	120.000	101.0	H	170.0	9.5
131.795550	22.52	33.50	10.98	1000.0	120.000	170.0	V	80.0	9.4
161.360400	16.50	33.50	17.00	1000.0	120.000	101.0	V	100.0	9.8
214.712400	8.33	33.50	25.17	1000.0	120.000	170.0	V	190.0	12.4
898.201050	21.39	36.00	14.61	1000.0	120.000	101.0	H	190.0	24.2



**Plot 28:** 1 GHz to 7 GHz, 5825 MHz, vertical & horizontal polarization

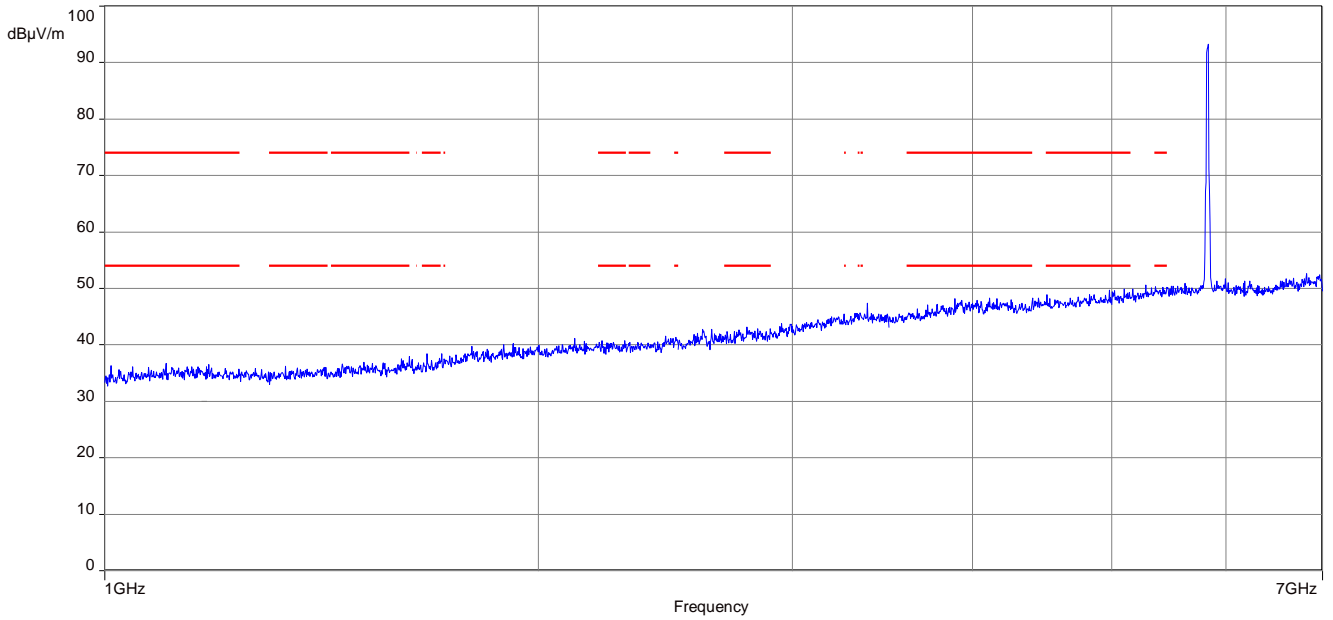

**Plot 29:** 7 GHz to 18 GHz, 5825 MHz, vertical & horizontal polarization

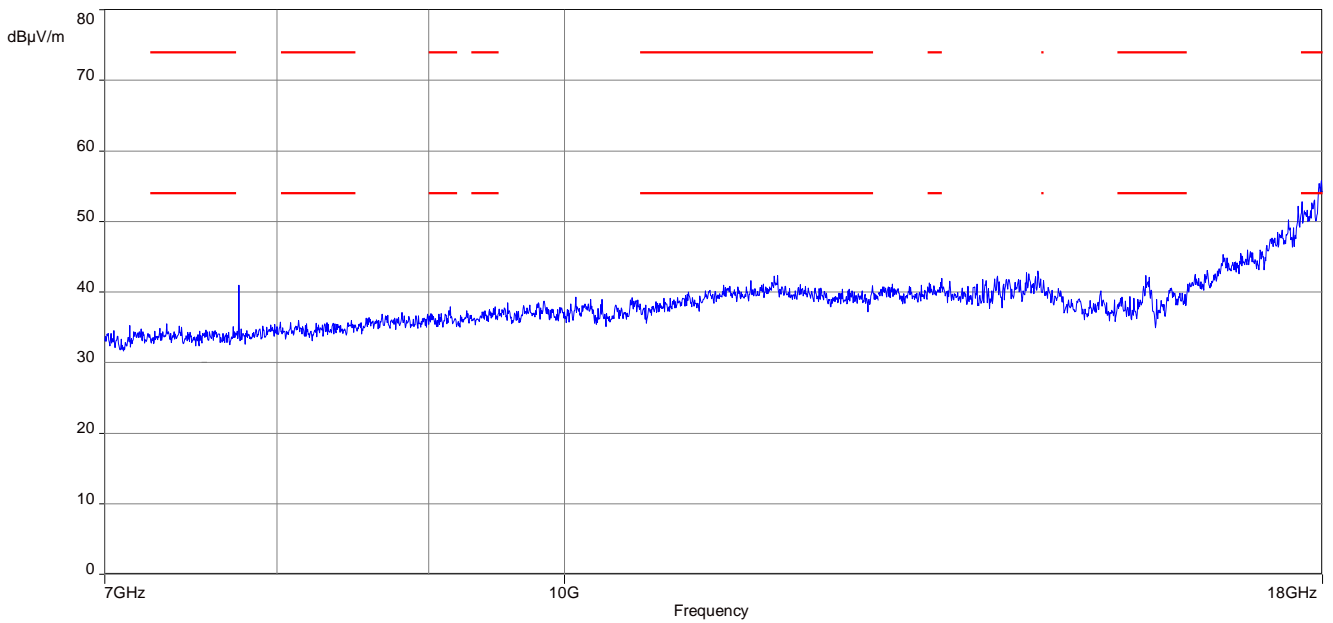

**Plot 30:** 17.7 GHz to 18 GHz, 5825 MHz, vertical & horizontal polarization

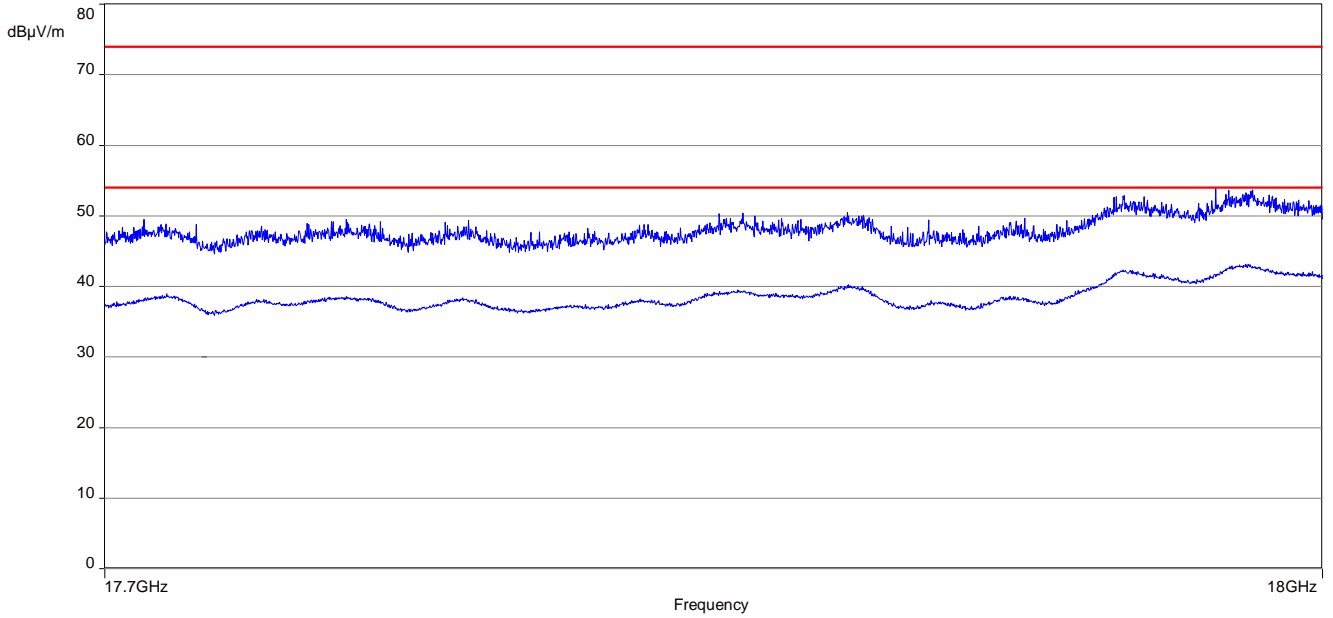

**Plot 31:** 18 GHz to 26 GHz, 5825 MHz, vertical & horizontal polarization

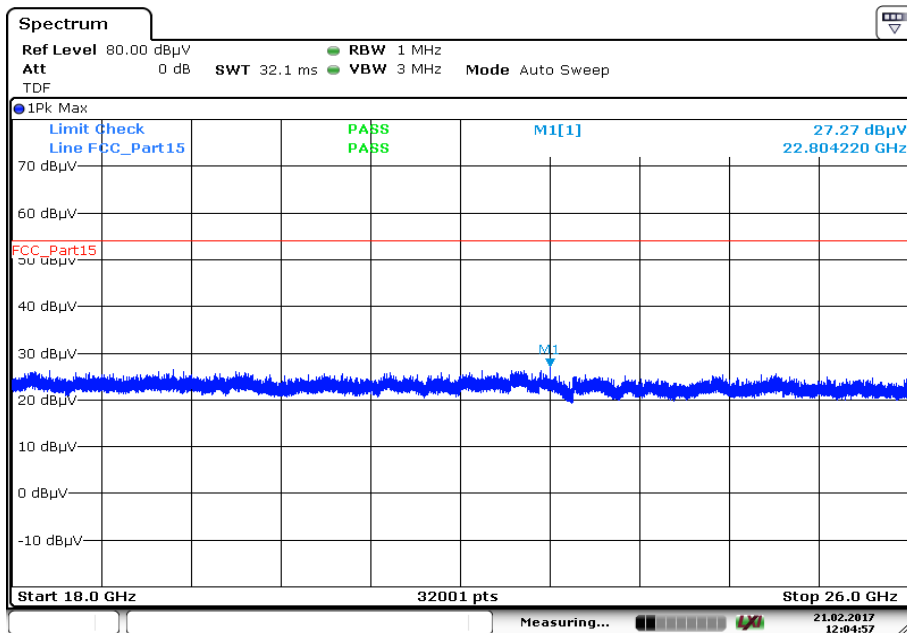

Date: 21.FEB.2017 12:04:58

**Plot 32:** 26 GHz to 40 GHz, 5825 MHz, vertical & horizontal polarization

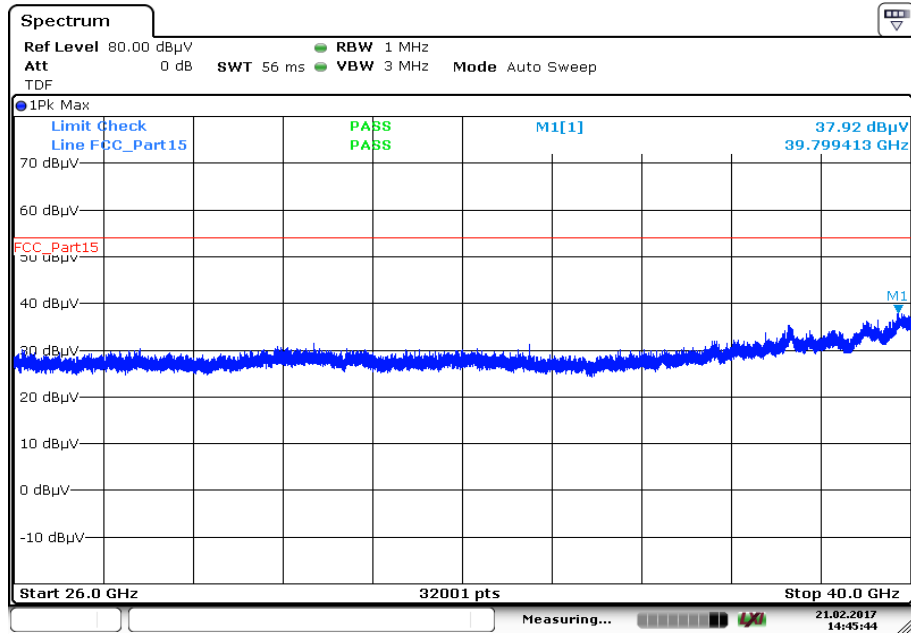

Date: 21.FEB.2017 14:45:44

**Plots:** OFDM / n/ac HT40 – mode

**Plot 1:** 30 MHz to 1 GHz, 5190 MHz, vertical & horizontal polarization

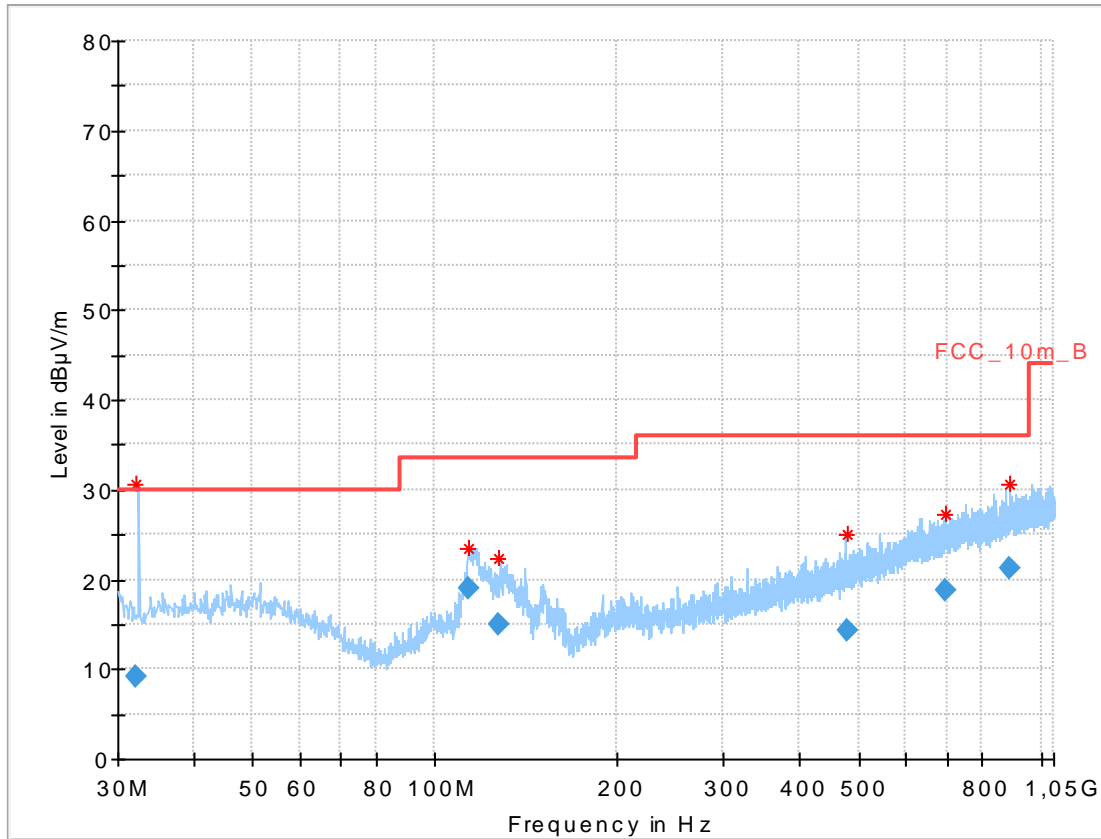

**Final results:**

Frequency (MHz)	QuasiPeak (dBµV/m)	Limit (dBµV/m)	Margin (dB)	Meas. Time (ms)	Bandwidth (kHz)	Height (cm)	Pol	Azimuth (deg)	Corr. (dB)
32.219100	9.13	30.00	20.87	1000.0	120.000	101.0	V	100.0	12.2
113.851800	19.10	33.50	14.40	1000.0	120.000	170.0	V	81.0	10.8
127.820100	14.89	33.50	18.61	1000.0	120.000	170.0	V	100.0	9.7
477.605550	14.33	36.00	21.67	1000.0	120.000	98.0	V	10.0	18.2
695.238900	18.74	36.00	17.26	1000.0	120.000	170.0	V	10.0	21.5
889.738950	21.18	36.00	14.82	1000.0	120.000	98.0	H	10.0	24.1

**Plot 2:** 1 GHz to 18 GHz, 5190 MHz, vertical & horizontal polarization

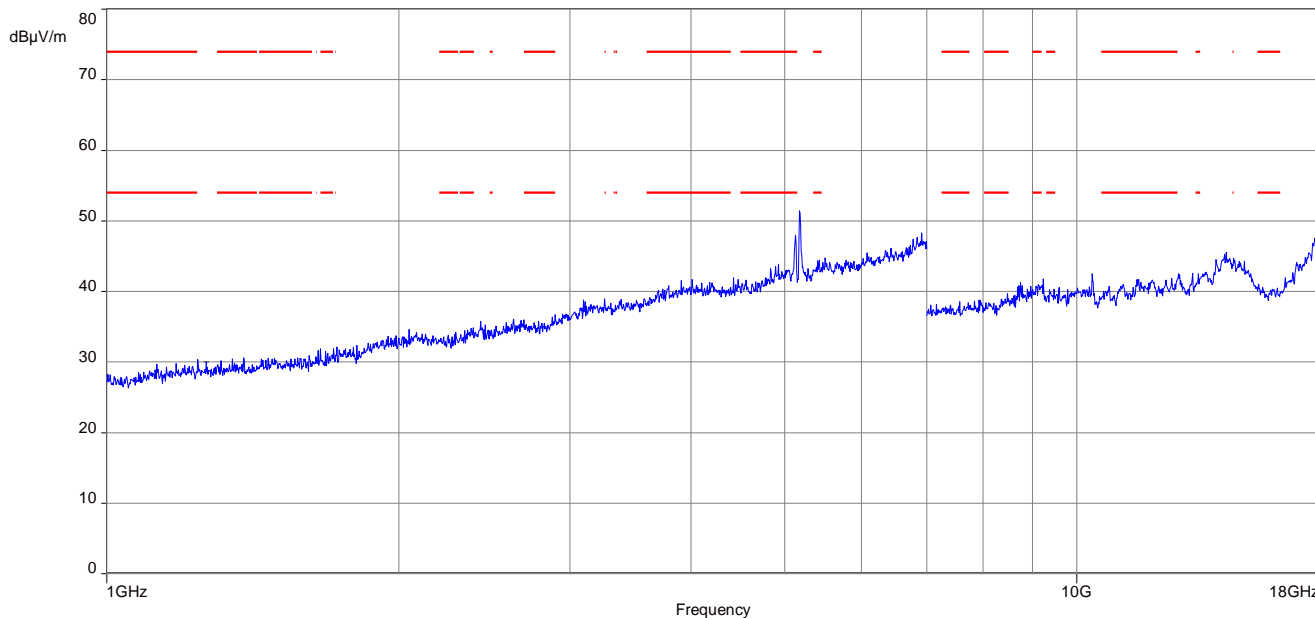

The carrier signal is notched with a band rejection filter.

**Plot 3:** 18 GHz to 26 GHz, 5190 MHz, vertical & horizontal polarization

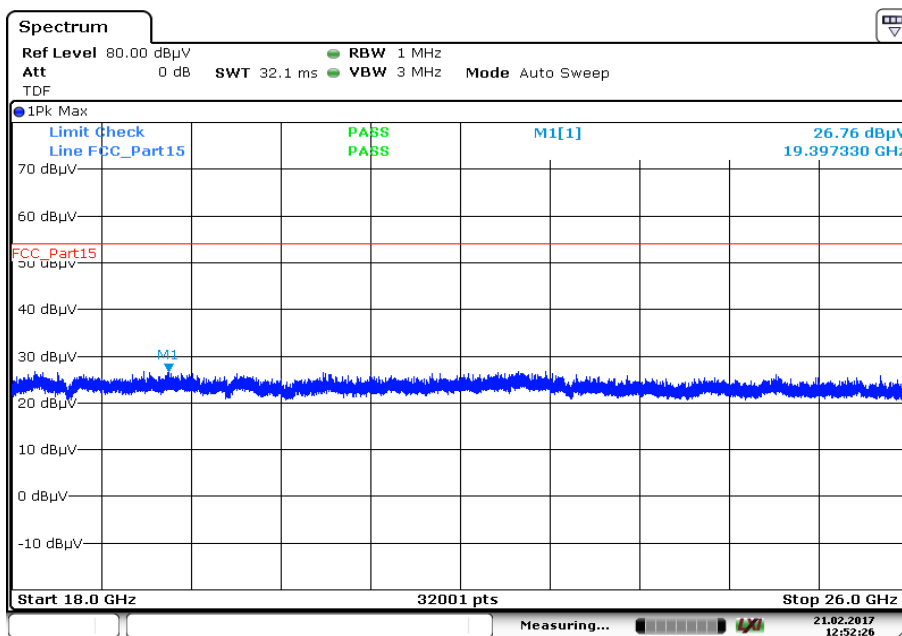

Date: 21.FEB.2017 12:52:27

**Plot 4:** 26 GHz to 40 GHz, 5190 MHz, vertical & horizontal polarization

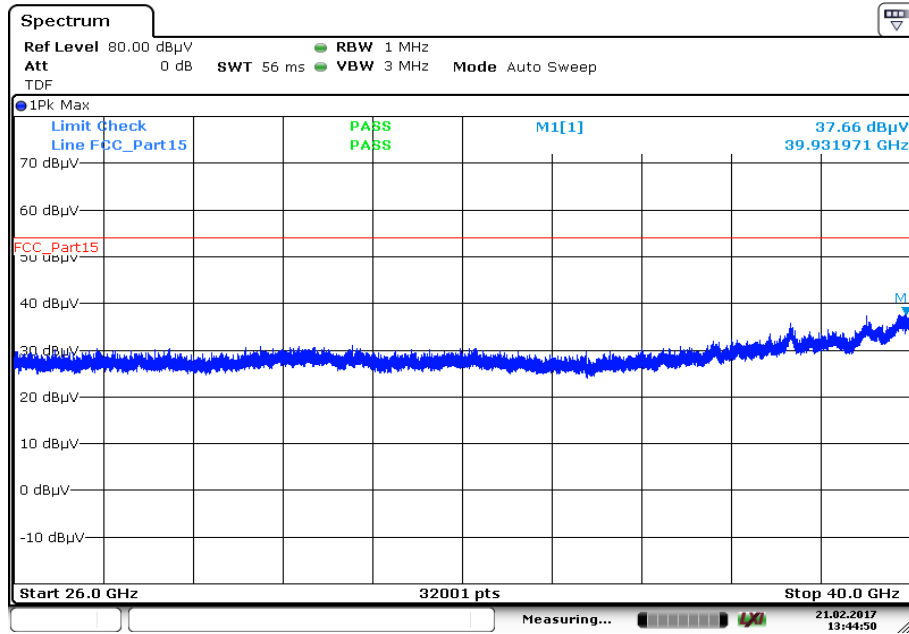

Date: 21.FEB.2017 13:44:50

**Plot 5:** 30 MHz to 1 GHz, 5250 MHz, vertical & horizontal polarization

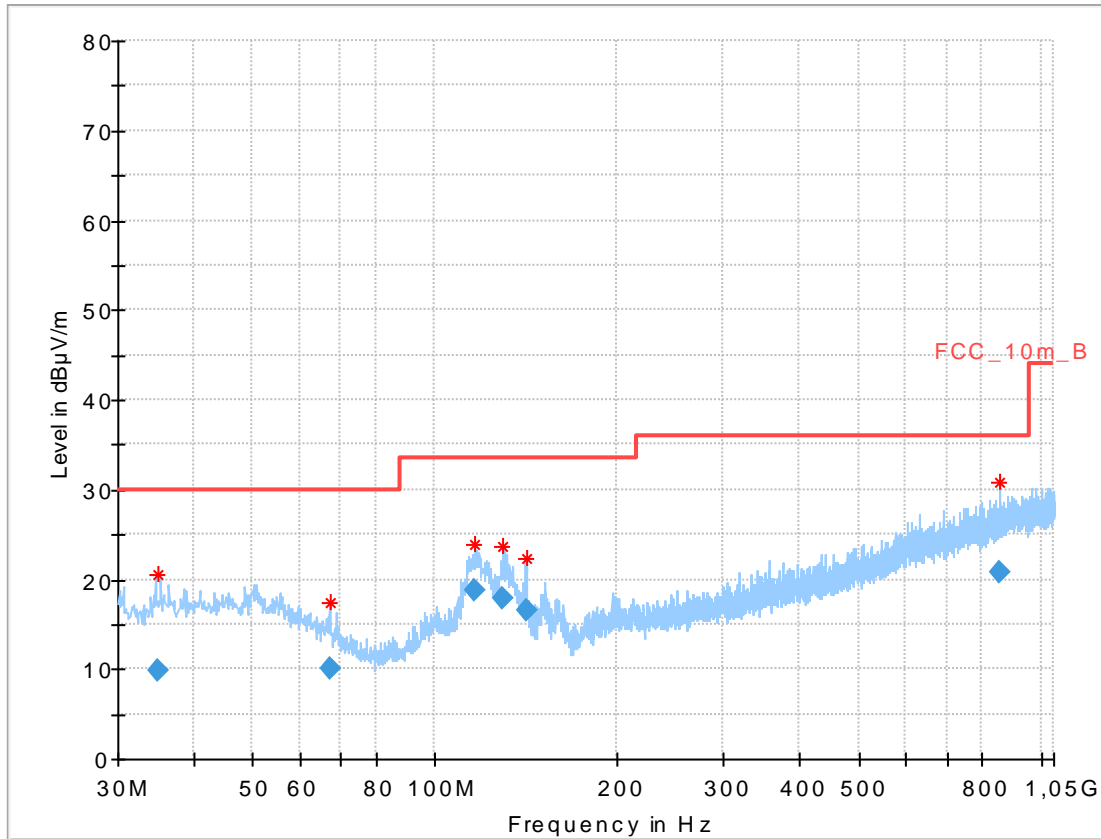

**Final results:**

Frequency (MHz)	QuasiPeak (dBµV/m)	Limit (dBµV/m)	Margin (dB)	Meas. Time (ms)	Bandwidth (kHz)	Height (cm)	Pol	Azimuth (deg)	Corr. (dB)
34.812300	9.77	30.00	20.23	1000.0	120.000	170.0	V	-8.0	12.6
66.986100	10.11	30.00	19.89	1000.0	120.000	100.0	V	100.0	10.3
116.321400	18.67	33.50	14.83	1000.0	120.000	170.0	V	190.0	10.6
129.821550	17.87	33.50	15.63	1000.0	120.000	101.0	V	170.0	9.6
141.612900	16.54	33.50	16.96	1000.0	120.000	101.0	V	-10.0	8.9
853.916100	20.79	36.00	15.21	1000.0	120.000	170.0	H	190.0	23.6

**Plot 6:** 1 GHz to 18 GHz, 5250 MHz, vertical & horizontal polarization

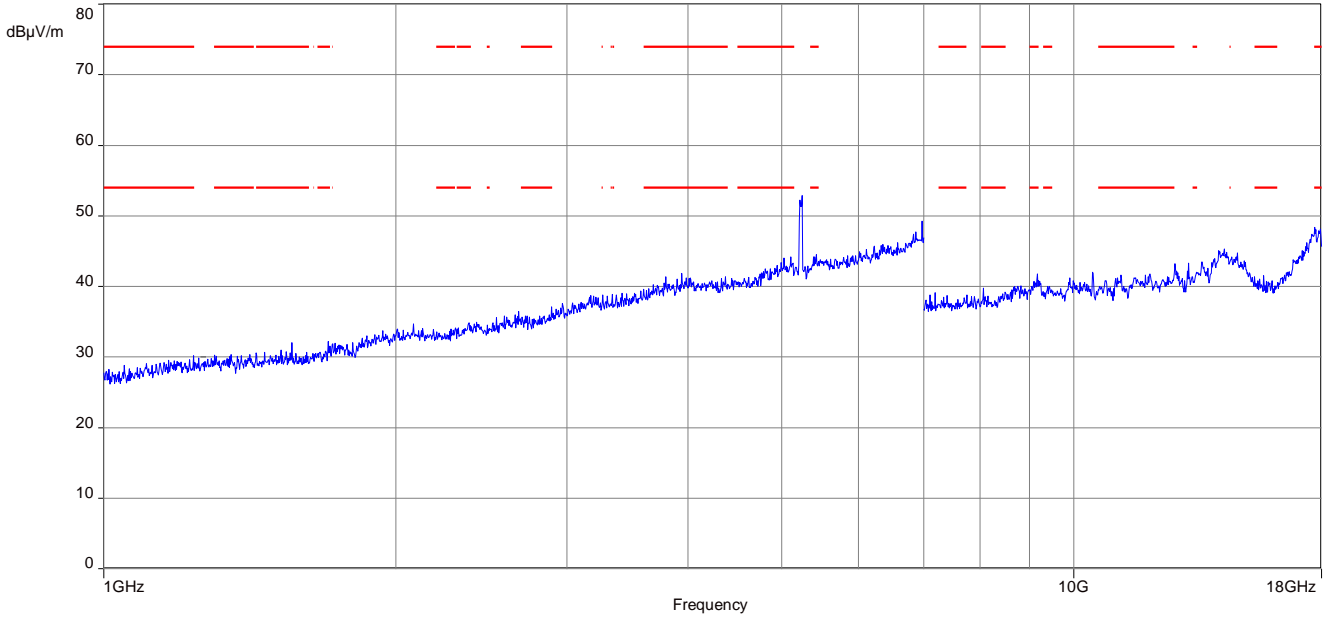

The carrier signal is notched with a band rejection filter.

**Plot 7:** 18 GHz to 26 GHz, 5250 MHz, vertical & horizontal polarization

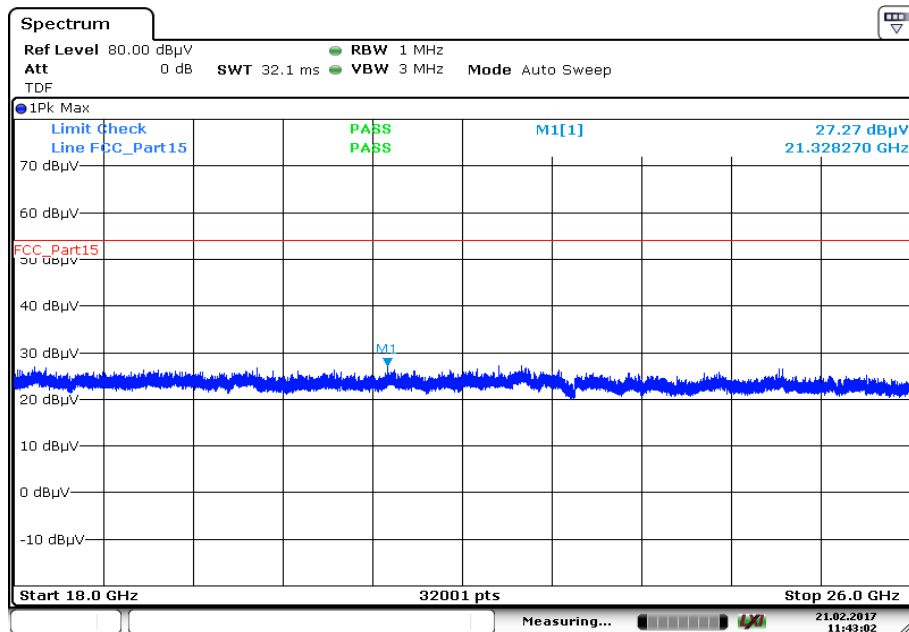

Date: 21.FEB.2017 11:43:02



**Plot 8:** 26 GHz to 40 GHz, 5250 MHz, vertical & horizontal polarization

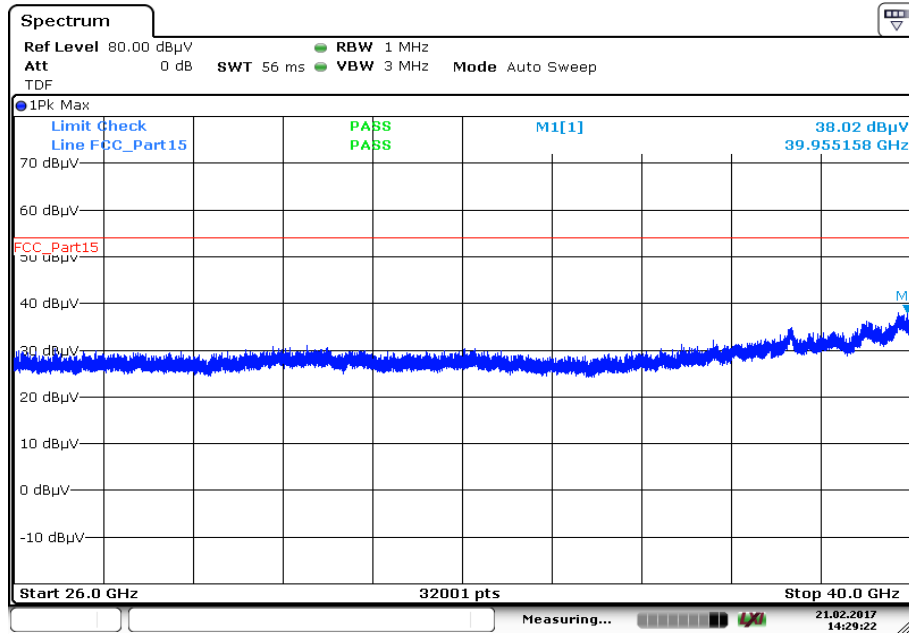

Date: 21.FEB.2017 14:29:22

**Plot 9:** 30 MHz to 1 GHz, 5310 MHz, vertical & horizontal polarization

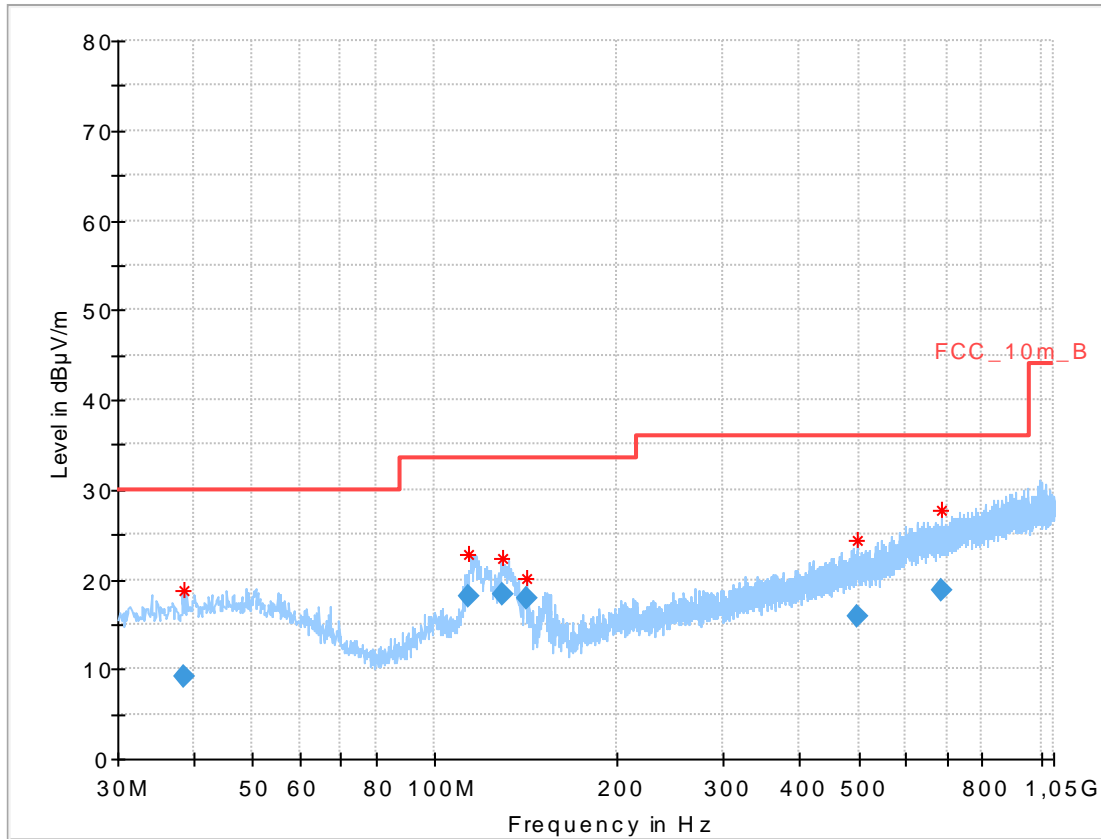

**Final results:**

Frequency (MHz)	QuasiPeak (dBµV/m)	Limit (dBµV/m)	Margin (dB)	Meas. Time (ms)	Bandwidth (kHz)	Height (cm)	Pol	Azimuth (deg)	Corr. (dB)
38.658150	9.07	30.00	20.93	1000.0	120.000	101.0	H	261.0	13.1
113.731500	18.13	33.50	15.37	1000.0	120.000	101.0	V	10.0	10.8
128.956050	18.23	33.50	15.27	1000.0	120.000	101.0	V	100.0	9.6
141.633600	17.91	33.50	15.59	1000.0	120.000	98.0	V	280.0	8.9
498.838350	15.78	36.00	20.22	1000.0	120.000	170.0	V	-8.0	18.7
686.435400	18.69	36.00	17.31	1000.0	120.000	98.0	H	261.0	21.4

**Plot 10:** 1 GHz to 18 GHz, 5310 MHz, vertical & horizontal polarization

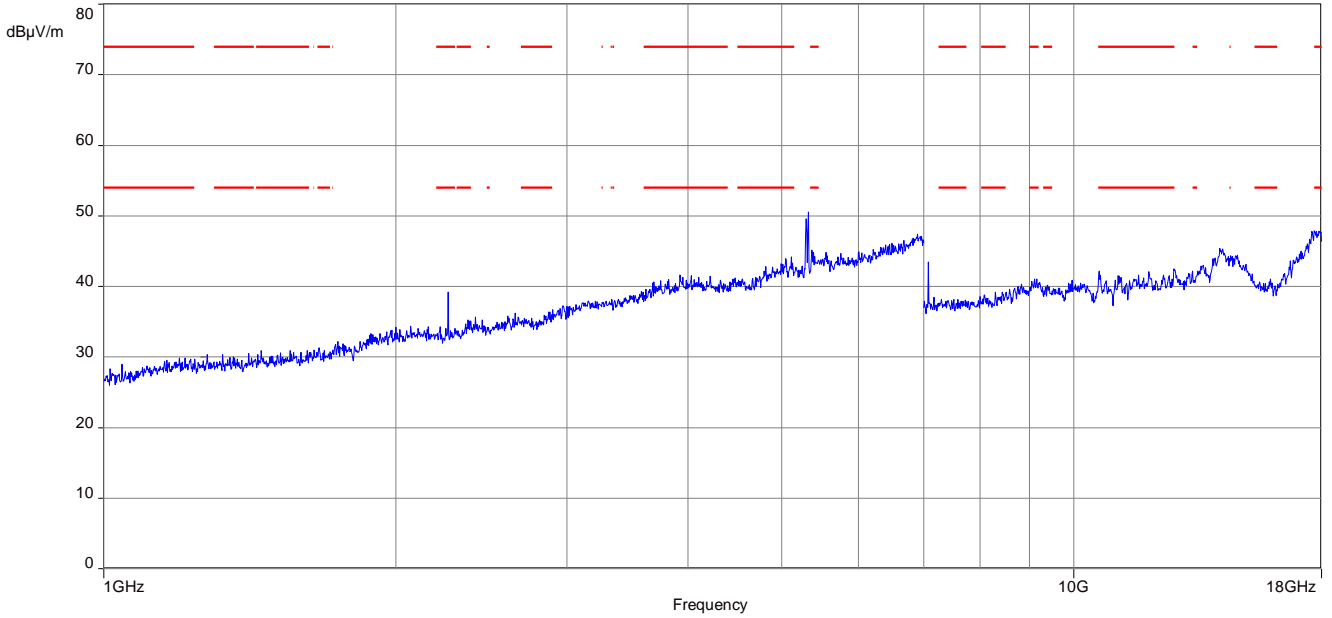

The carrier signal is notched with a band rejection filter.

**Plot 11:** 18 GHz to 26 GHz, 5310 MHz, vertical & horizontal polarization

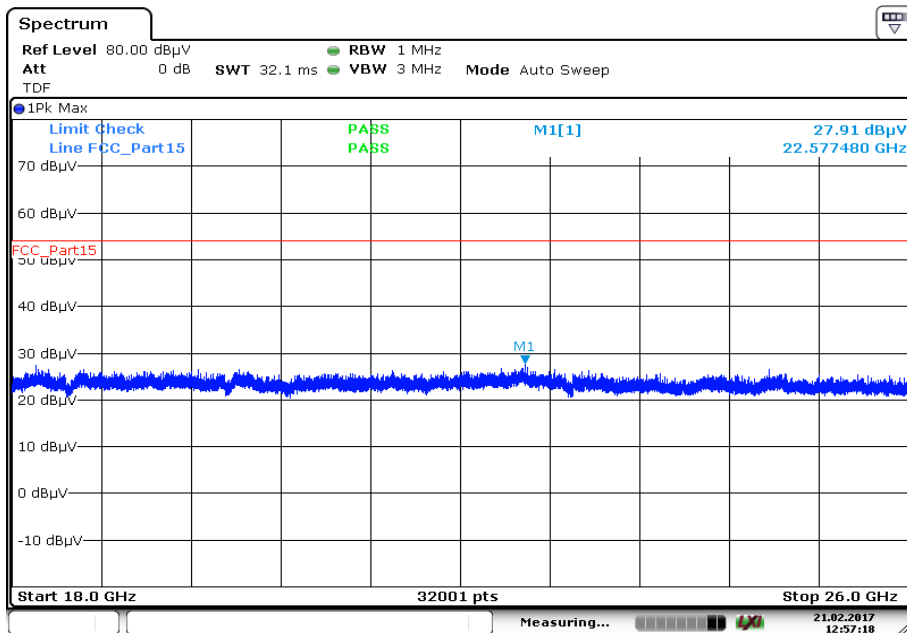

Date: 21.FEB.2017 12:57:19

Plot 12: 26 GHz to 40 GHz, 5310 MHz, vertical & horizontal polarization

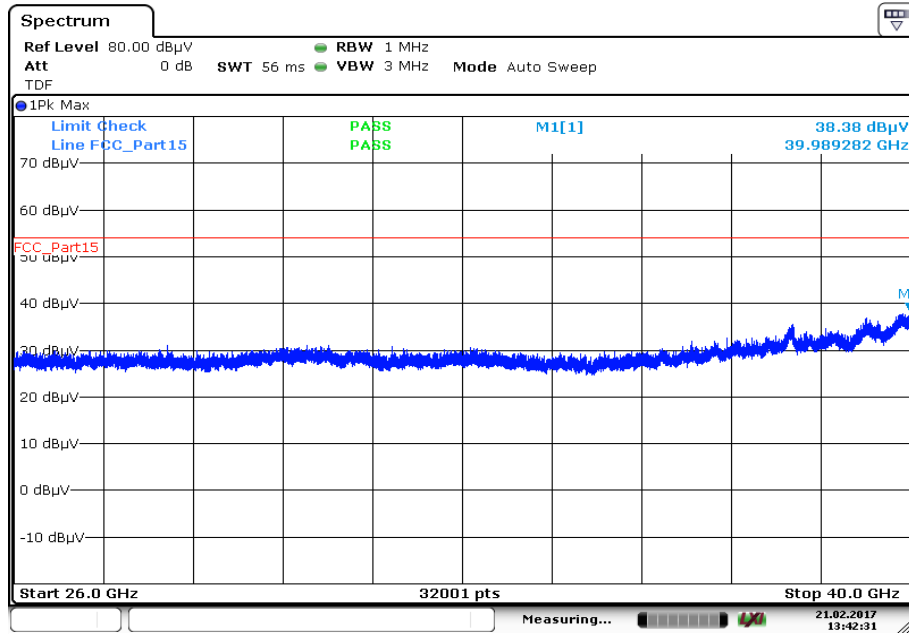

Date: 21.FEB.2017 13:42:31

**Plot 13:** 30 MHz to 1 GHz, 5755 MHz, vertical & horizontal polarization

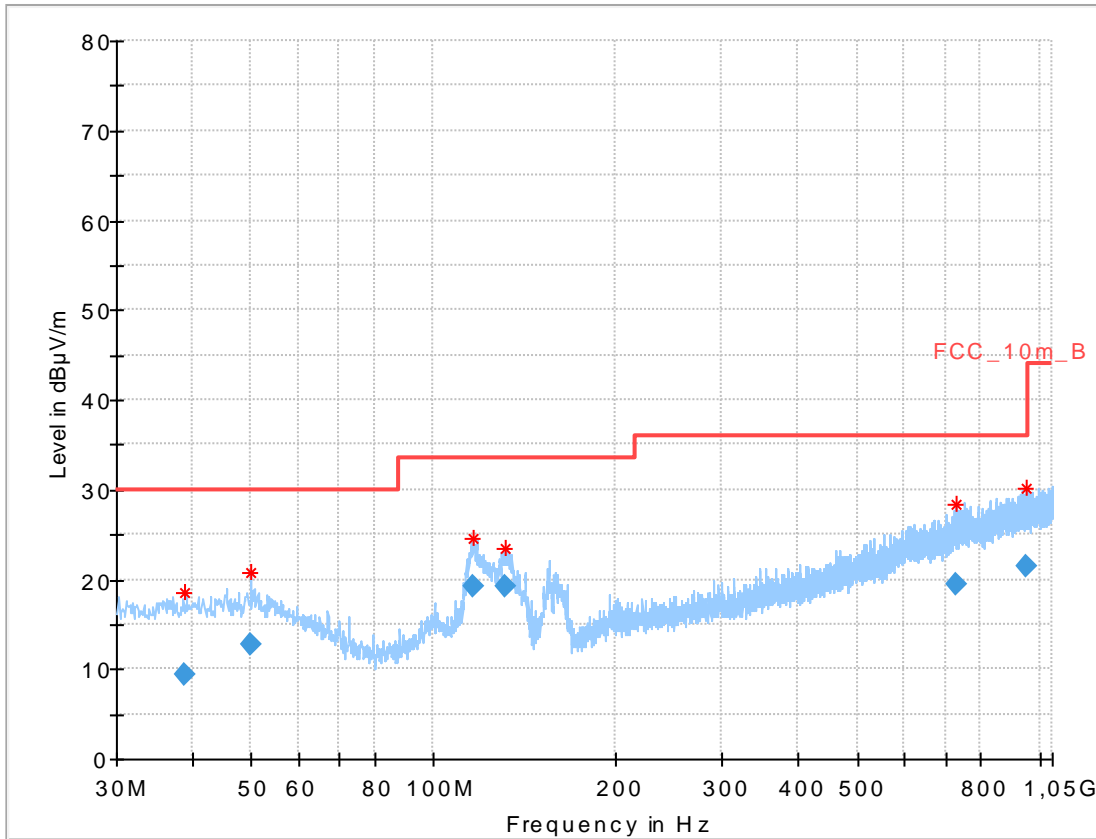

**Final results:**

Frequency (MHz)	QuasiPeak (dBµV/m)	Limit (dBµV/m)	Margin (dB)	Meas. Time (ms)	Bandwidth (kHz)	Height (cm)	Pol	Azimuth (deg)	Corr. (dB)
38.737050	9.41	30.00	20.59	1000.0	120.000	98.0	H	10.0	13.1
49.954650	12.68	30.00	17.32	1000.0	120.000	101.0	V	100.0	13.7
116.649600	19.26	33.50	14.24	1000.0	120.000	101.0	V	-10.0	10.6
131.286900	19.30	33.50	14.20	1000.0	120.000	170.0	V	10.0	9.5
726.648600	19.43	36.00	16.57	1000.0	120.000	170.0	V	10.0	22.2
949.544550	21.49	36.00	14.51	1000.0	120.000	170.0	V	280.0	24.3

**Plot 14:** 1 GHz to 18 GHz, 5755 MHz, vertical & horizontal polarization

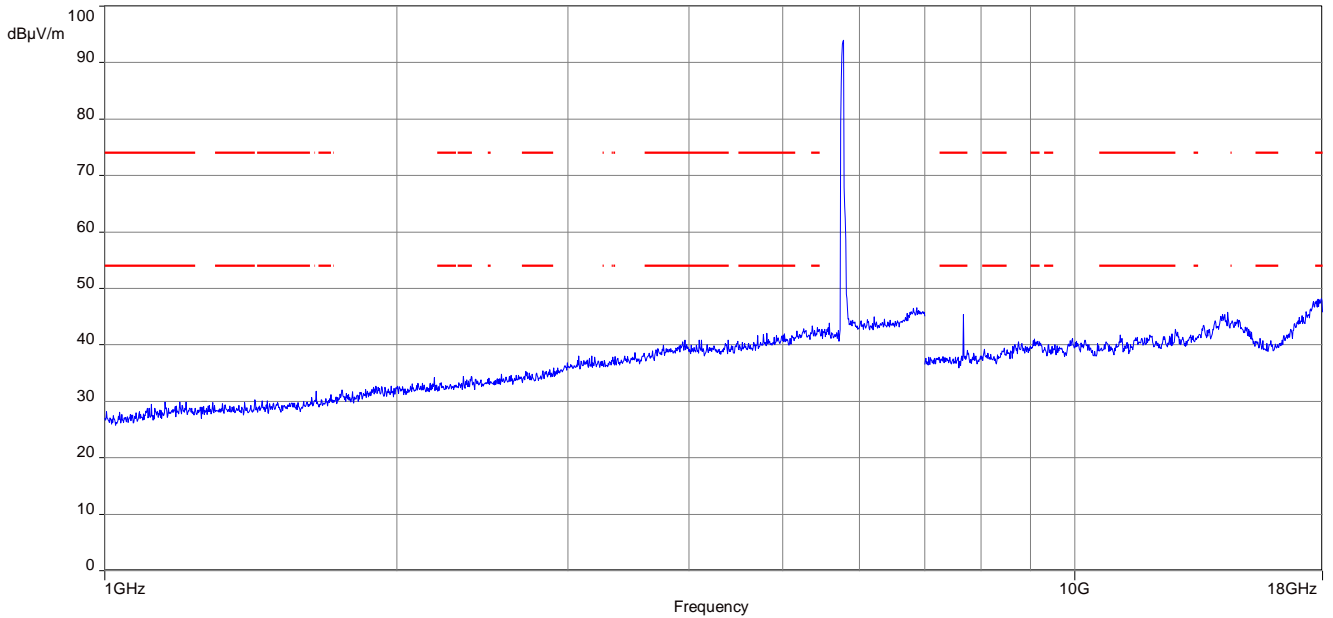

**Plot 15:** 18 GHz to 26 GHz, 5755 MHz, vertical & horizontal polarization

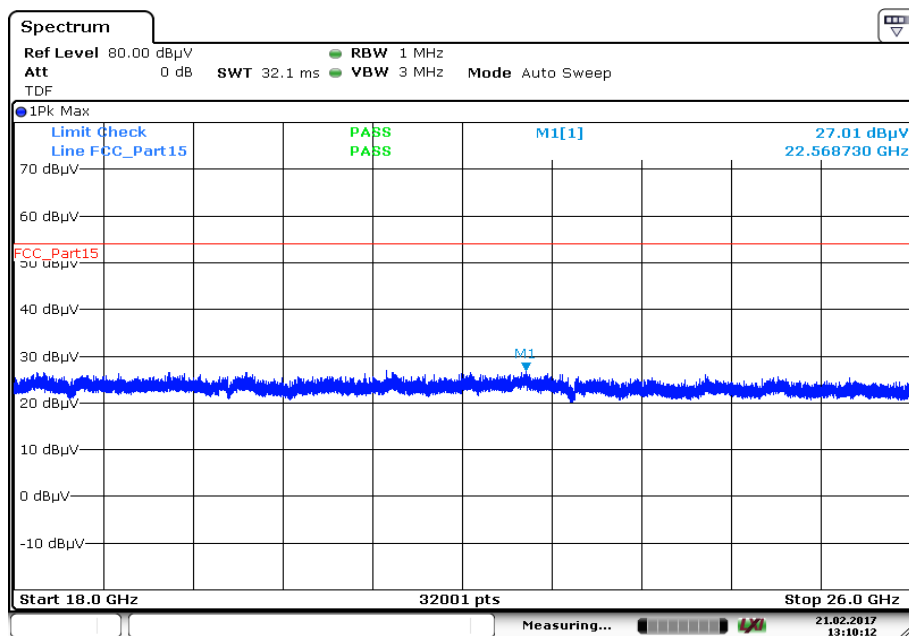

Date: 21.FEB.2017 13:10:13

**Plot 16:** 26 GHz to 40 GHz, 5755 MHz, vertical & horizontal polarization

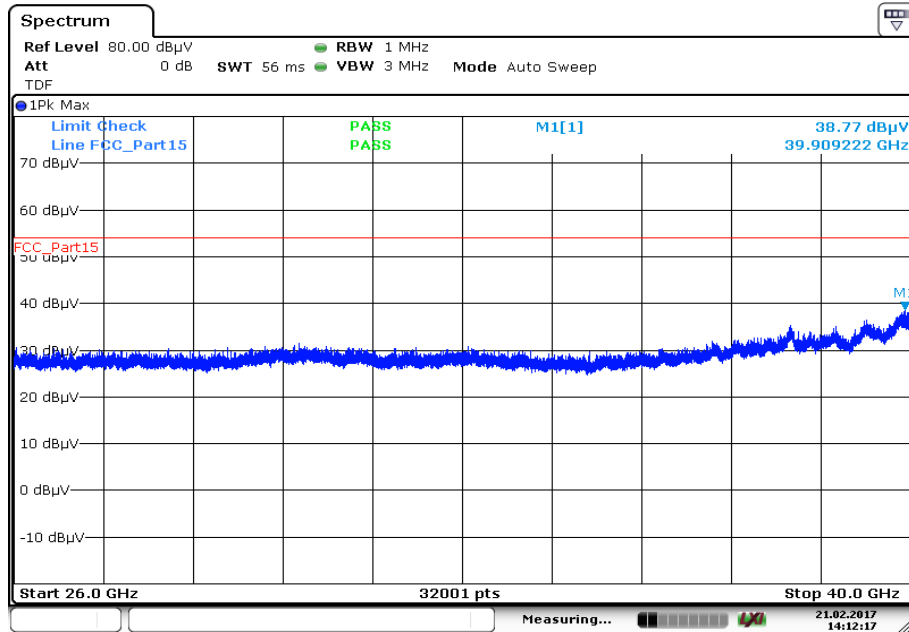

Date: 21.FEB.2017 14:12:17

**Plot 17:** 30 MHz to 1 GHz, 5795 MHz, vertical & horizontal polarization

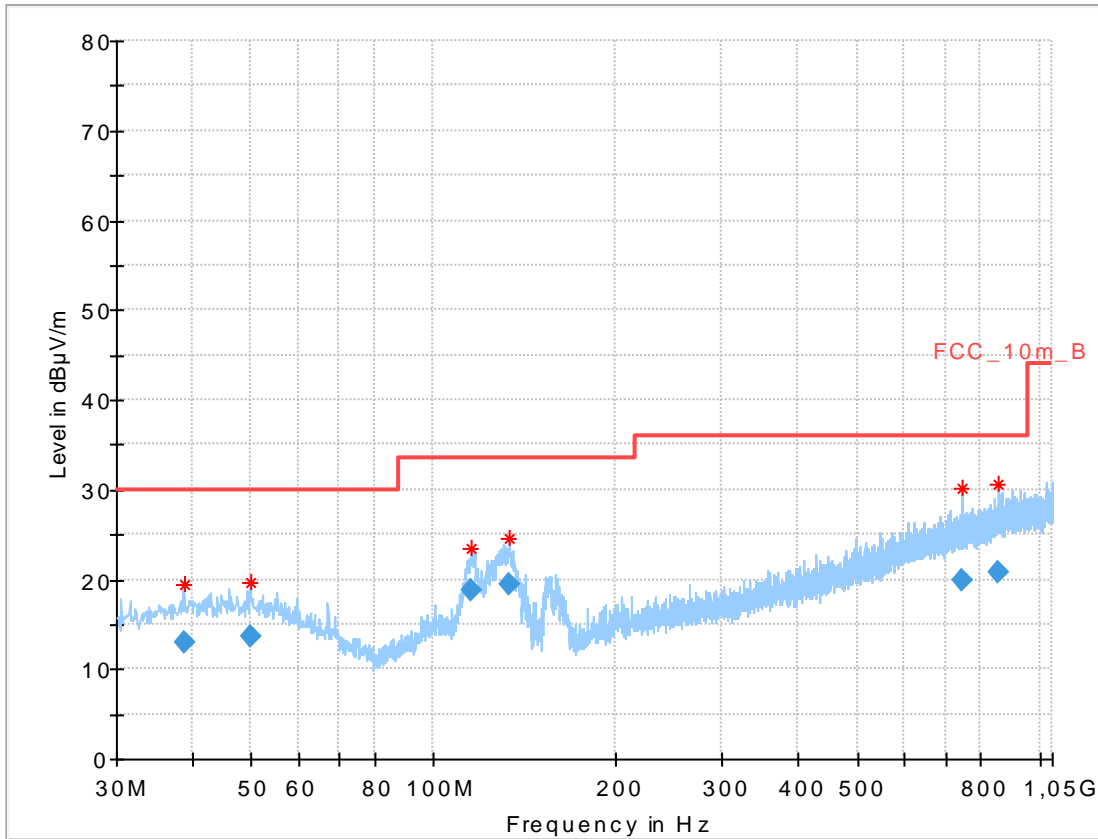

**Final results:**

Frequency (MHz)	QuasiPeak (dBµV/m)	Limit (dBµV/m)	Margin (dB)	Meas. Time (ms)	Bandwidth (kHz)	Height (cm)	Pol	Azimuth (deg)	Corr. (dB)
38.742000	12.89	30.00	17.11	1000.0	120.000	98.0	V	261.0	13.1
49.980900	13.66	30.00	16.34	1000.0	120.000	98.0	V	-10.0	13.7
115.443900	18.71	33.50	14.79	1000.0	120.000	100.0	V	80.0	10.7
133.266600	19.46	33.50	14.04	1000.0	120.000	170.0	V	81.0	9.3
745.753200	19.87	36.00	16.13	1000.0	120.000	170.0	V	280.0	22.6
854.625750	20.85	36.00	15.15	1000.0	120.000	170.0	H	-10.0	23.6



**Plot 18:** 1 GHz to 18 GHz, 5795 MHz, vertical & horizontal polarization

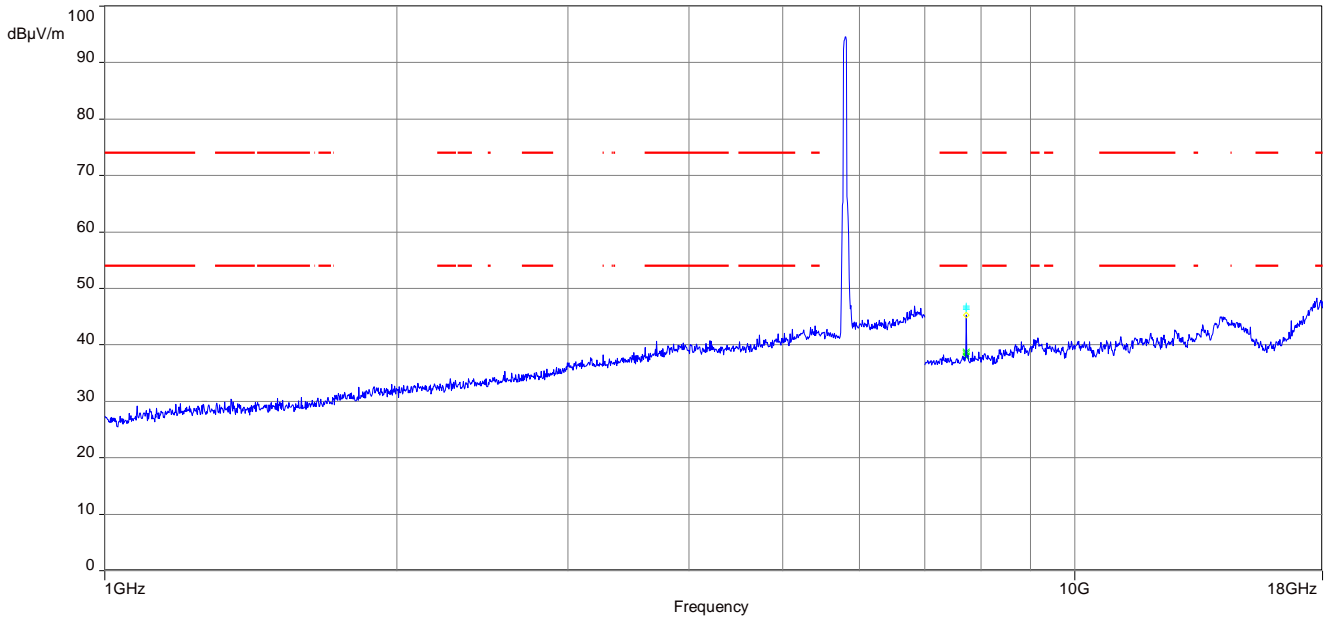

**Plot 19:** 18 GHz to 26 GHz, 5795 MHz, vertical & horizontal polarization

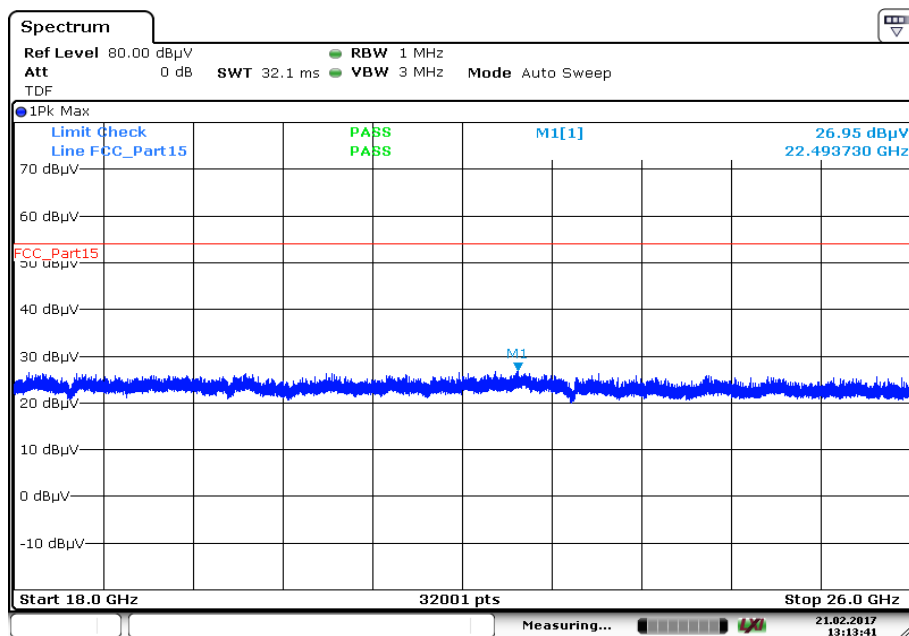

Date: 21.FEB.2017 13:13:41

Plot 20: 26 GHz to 40 GHz, 5795 MHz, vertical & horizontal polarization

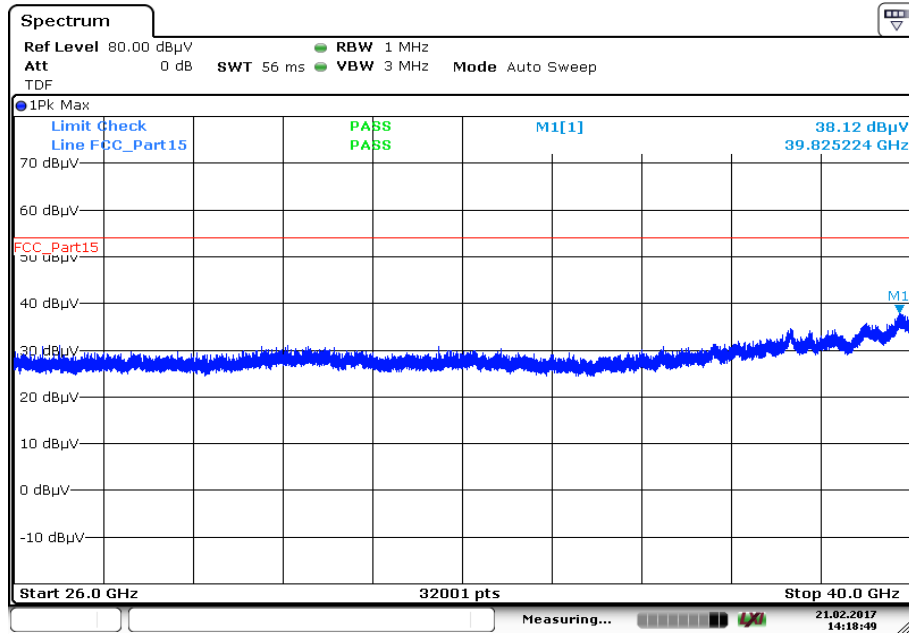

Date: 21.FEB.2017 14:18:49

**11.11 RX spurious emissions radiated**

**Description:**

Measurement of the radiated spurious emissions in idle/receive mode.

**Measurement:**

Measurement parameter	
Detector:	Quasi Peak below 1 GHz (alternative Peak) Peak above 1 GHz / RMS
Sweep time:	Auto
Resolution bandwidth:	F < 1 GHz: 100 kHz F > 1 GHz: 1 MHz
Video bandwidth:	F < 1 GHz: 100 kHz F > 1 GHz: ≥ 3 MHz
Span:	30 MHz to 40 GHz
Trace – mode:	Max Hold / Average with 100 counts + 20 log (1 / X) for duty cycle lower than 100 %
Test setup:	See sub clause 6.2 – B
Measurement uncertainty:	See sub clause 8

**Limits:**

RX Spurious Emissions Radiated		
Frequency (MHz)	Field Strength (dBµV/m)	Measurement distance
30 - 88	30.0	10
88 – 216	33.5	10
216 – 960	36.0	10
Above 960	54.0	3

**Results:**

RX Spurious Emissions Radiated [dBµV/m]		
F [MHz]	Detector	Level [dBµV/m]
For emissions below 1 GHz see table below plot. All detected emissions above 1 GHz are more than 15 dB below the limit.		

**Plots:**

**Plot 1:** 30 MHz to 1 GHz, vertical & horizontal polarization

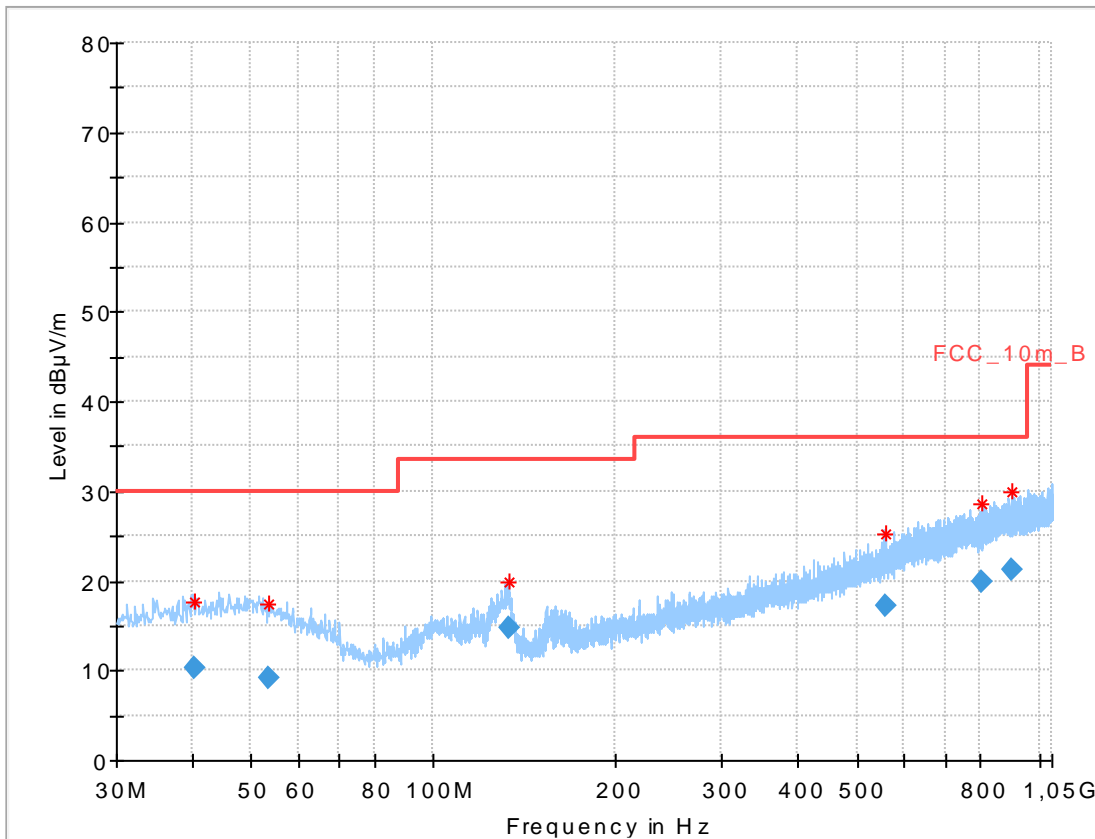

**Final results:**

Frequency (MHz)	QuasiPeak (dBµV/m)	Limit (dBµV/m)	Margin (dB)	Meas. Time (ms)	Bandwidth (kHz)	Height (cm)	Pol	Azimuth (deg)	Corr. (dB)
40.448250	10.25	30.00	19.75	1000.0	120.000	170.0	V	10.0	13.3
53.708700	9.15	30.00	20.85	1000.0	120.000	101.0	H	171.0	13.3
132.945600	14.82	33.50	18.68	1000.0	120.000	101.0	V	80.0	9.3
558.376650	17.21	36.00	18.79	1000.0	120.000	170.0	V	261.0	19.6
806.869200	19.97	36.00	16.03	1000.0	120.000	98.0	V	280.0	22.9
900.690900	21.28	36.00	14.72	1000.0	120.000	170.0	V	190.0	24.2

**Plot 2:** 1 GHz to 18 GHz, vertical & horizontal polarization

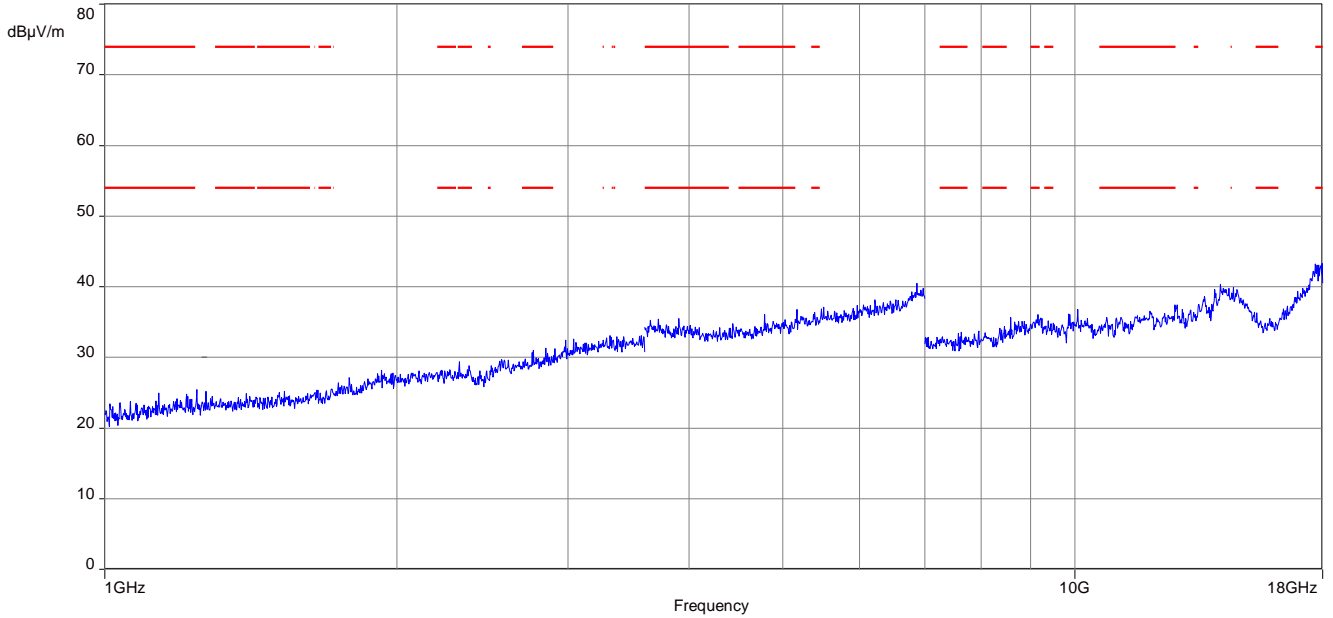

**Plot 3:** 18 GHz to 26 GHz, vertical & horizontal polarization

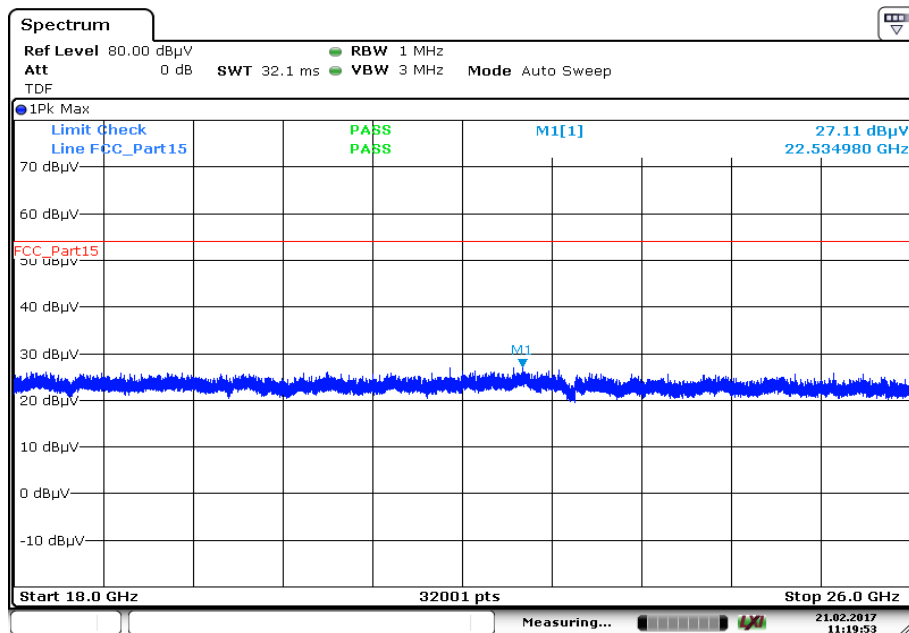

Date: 21.FEB.2017 11:19:53

Plot 4: 26 GHz to 40 GHz, vertical & horizontal polarization

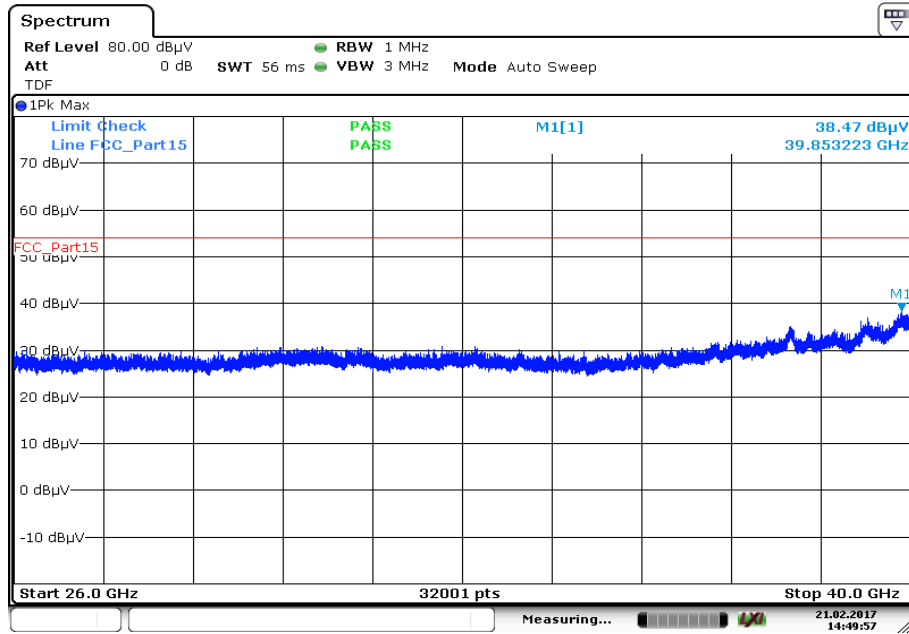

Date: 21.FEB.2017 14:49:57

**11.12 Spurious emissions radiated < 30 MHz**

**Description:**

Measurement of the radiated spurious emissions in transmit mode and receive mode below 30 MHz. The EUT is set first to middle channel. This measurement is representative for all channels and modes. If critical peaks are found the lowest channel and the highest channel will be measured too. Then the EUT is set to receive or idle mode. The limits are recalculated to a measurement distance of 3 m with 40 dB/decade according CFR Part 2.

**Measurement:**

Measurement parameter	
Detector:	Peak / Quasi Peak
Sweep time:	Auto
Resolution bandwidth	F < 150 kHz: 200 Hz F > 150 kHz: 9 kHz
Video bandwidth	F < 150 kHz: 1 kHz F > 150 kHz: 100 kHz
Span:	9 kHz to 30 MHz
Trace – mode:	Max Hold
Test setup:	See sub clause 6.2 – C
Measurement uncertainty:	See sub clause 8

**Limits:**

Spurious Emissions Radiated < 30 MHz		
Frequency (MHz)	Field Strength (dBµV/m)	Measurement distance
0.009 – 0.490	2400/F(kHz)	300
0.490 – 1.705	24000/F(kHz)	30
1.705 – 30.0	30	30

**Results:**

Spurious Emissions Radiated < 30 MHz [dBµV/m]		
F [MHz]	Detector	Level [dBµV/m]
All detected emissions are more than 20 dB below the limit.		

**Plots:**

**Plot 1:** 9 kHz to 30 MHz, OFDM 20 MHz, 5180 MHz

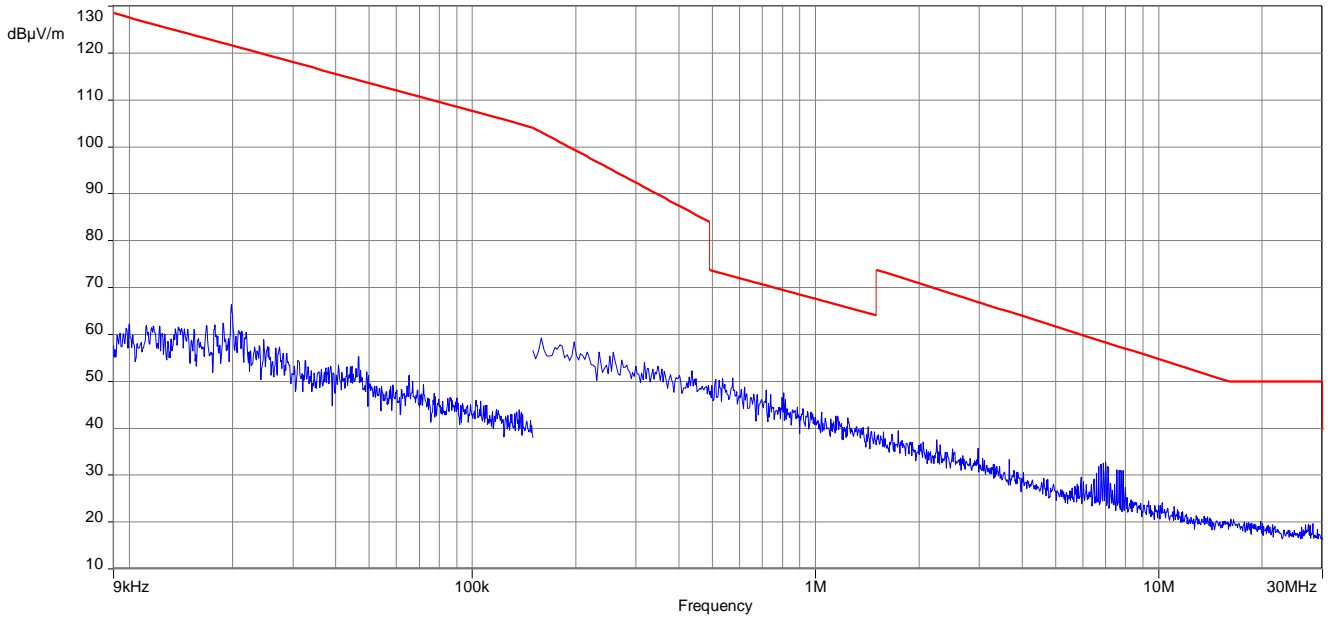

**Plot 2:** 9 kHz to 30 MHz, OFDM 20 MHz, 5240 MHz

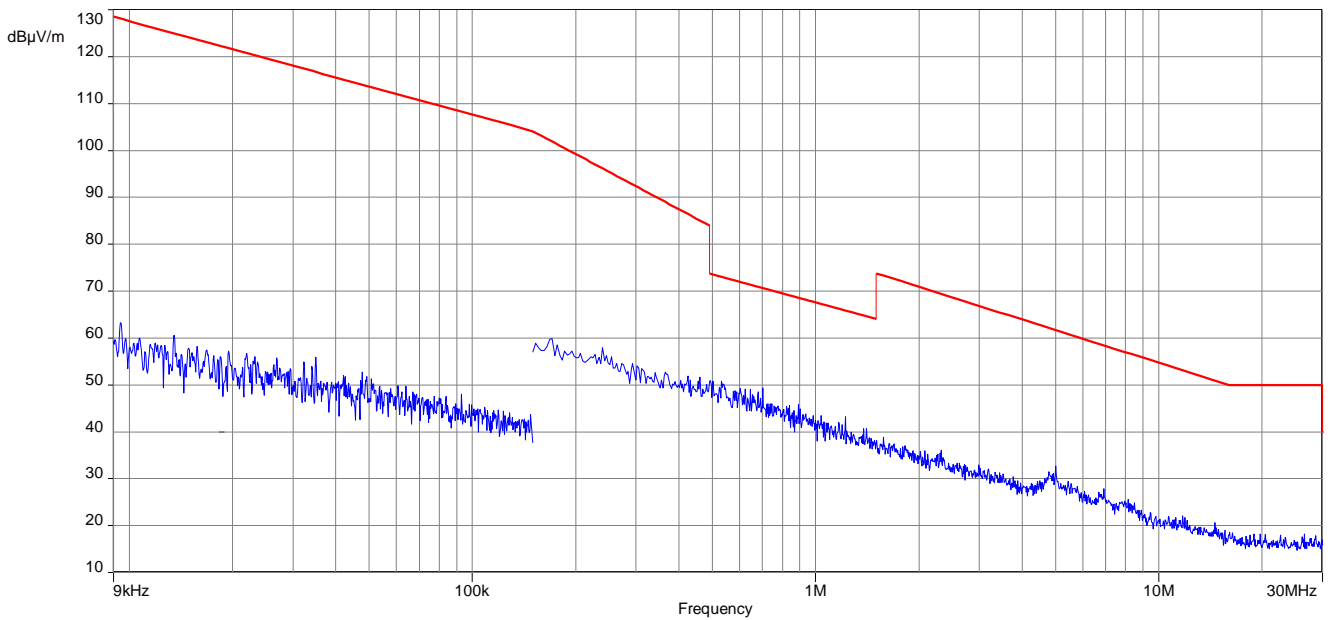



**Plot 3:** 9 kHz to 30 MHz, OFDM 20 MHz, 5320 MHz

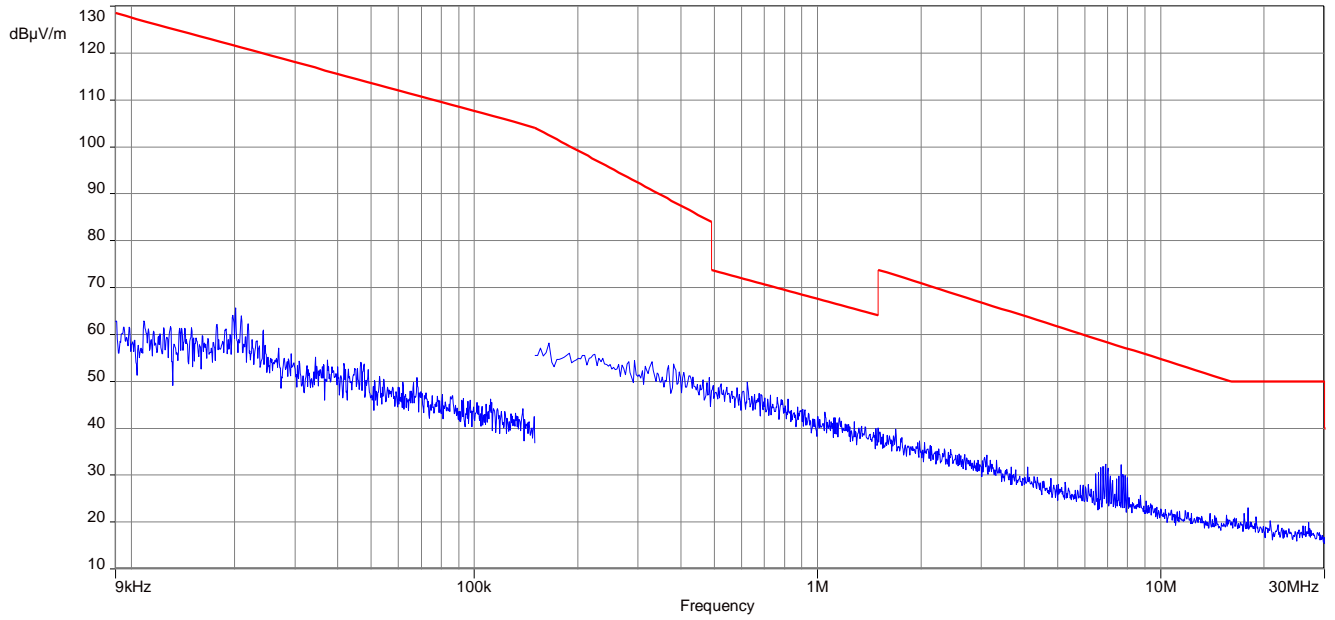

**Plot 4:** 9 kHz to 30 MHz, OFDM 20 MHz, 5745 MHz

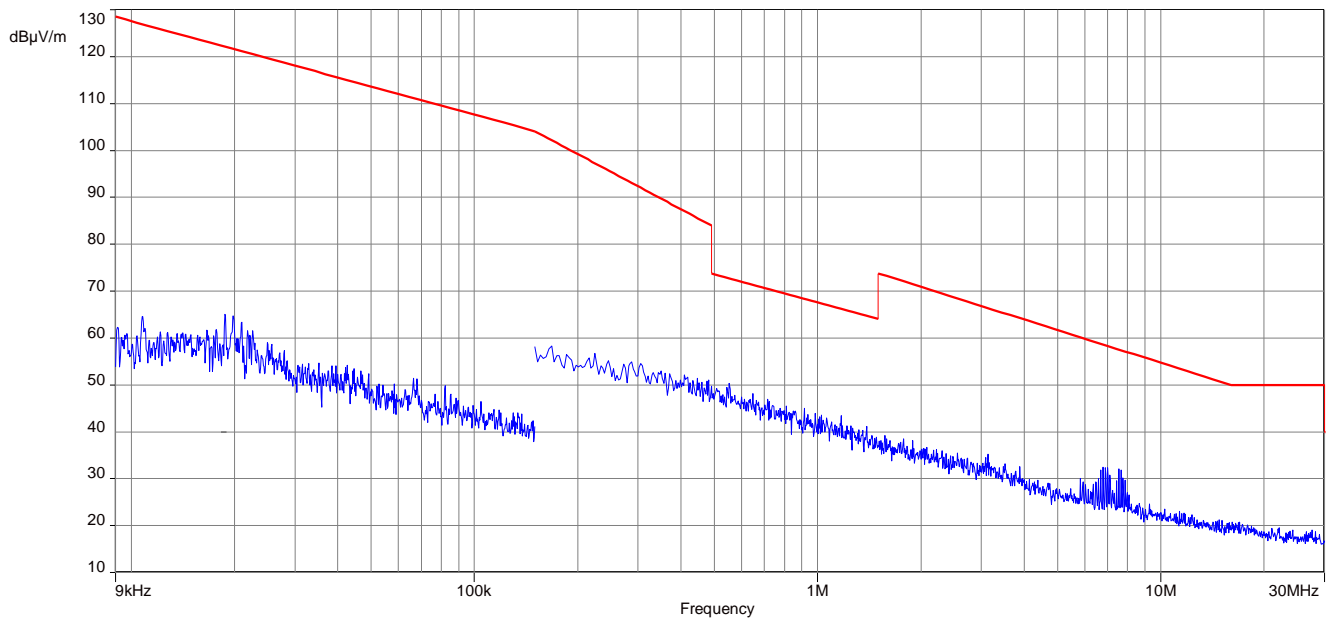

**Plot 5:** 9 kHz to 30 MHz, OFDM 20 MHz, 5785 MHz

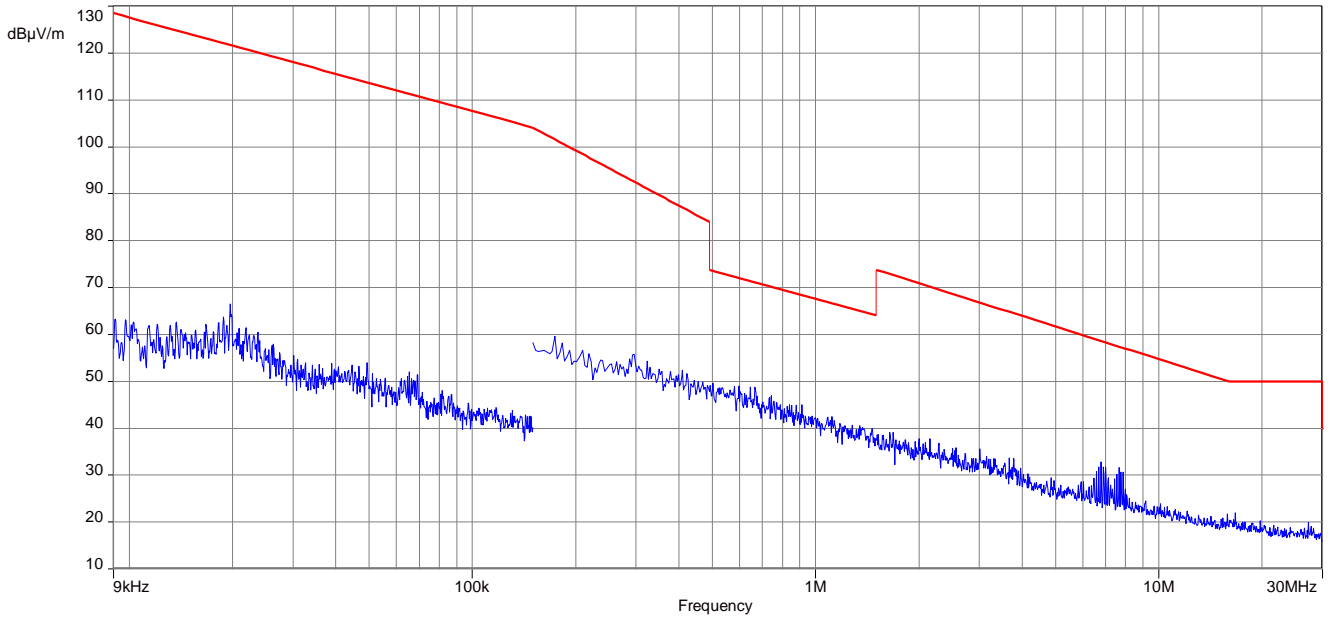

**Plot 6:** 9 kHz to 30 MHz, OFDM 20 MHz, 5825 MHz

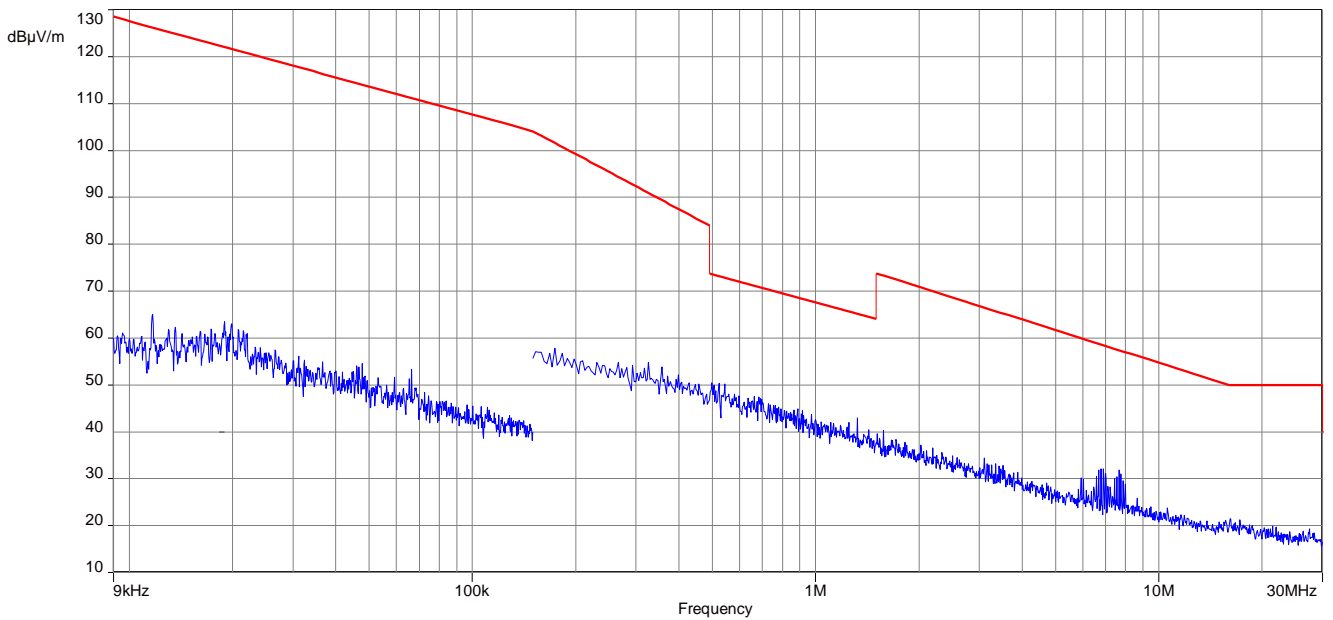

**Plot 7:** 9 kHz to 30 MHz, OFDM 40 MHz, 5190 MHz

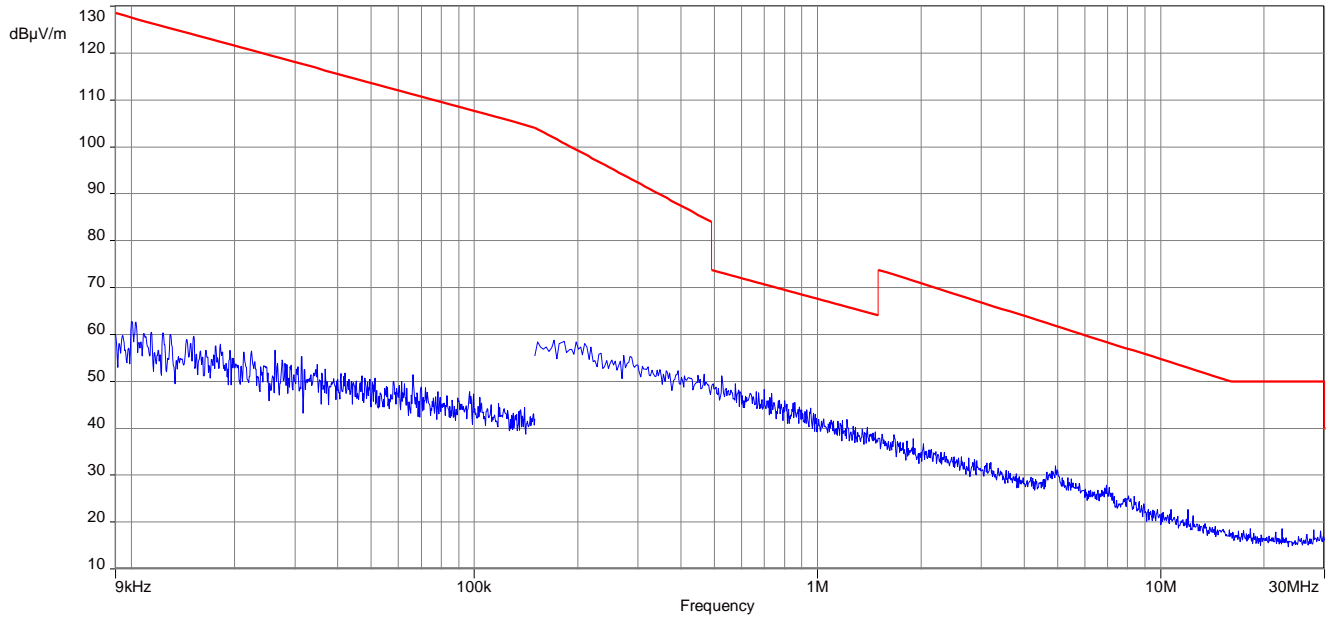

**Plot 8:** 9 kHz to 30 MHz, OFDM 40 MHz, 5250 MHz

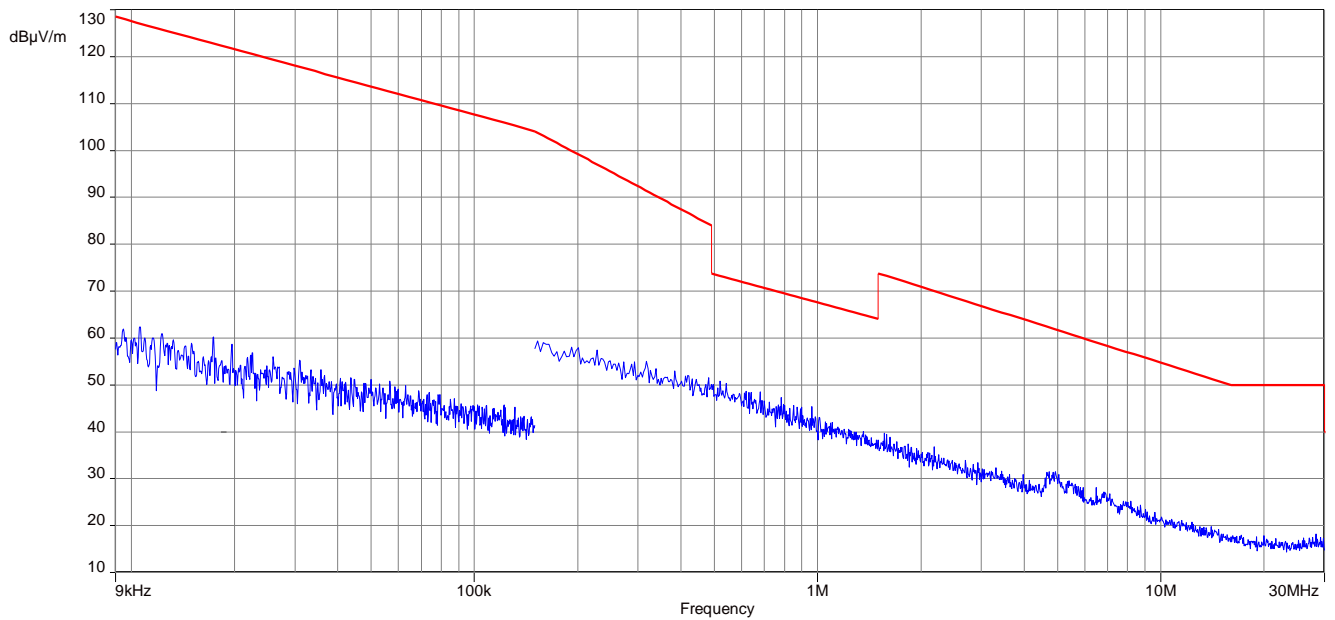

**Plot 9:** 9 kHz to 30 MHz, OFDM 40 MHz, 5310 MHz

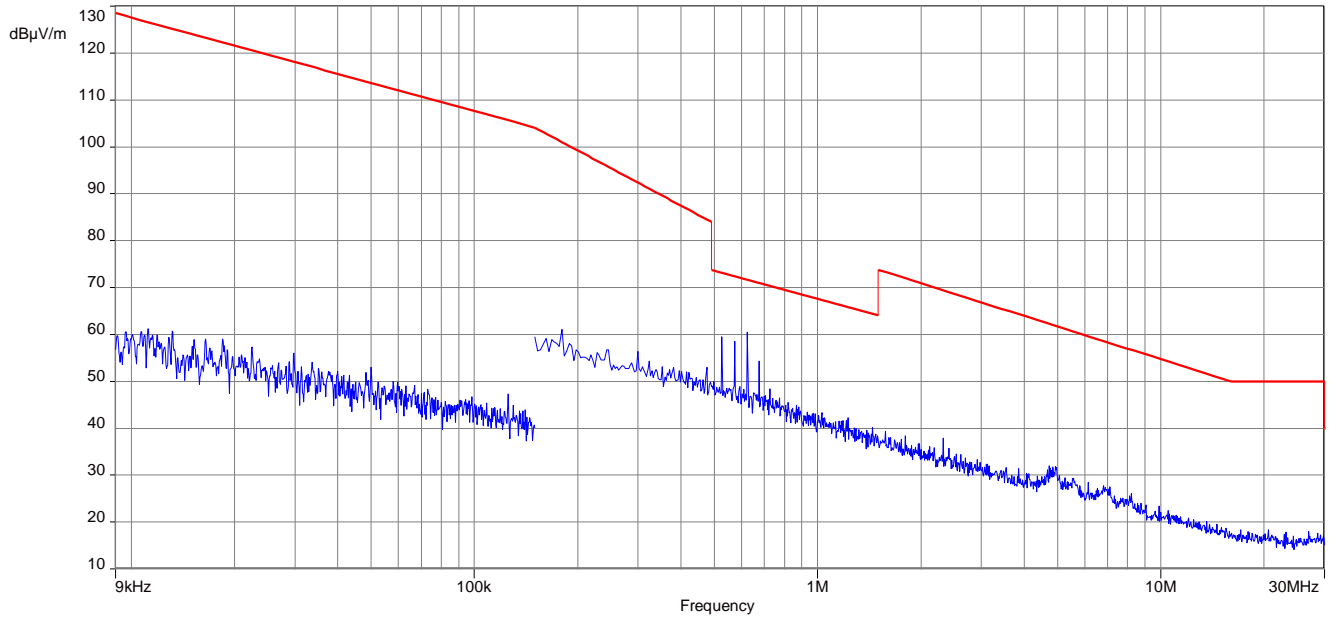

**Plot 10:** 9 kHz to 30 MHz, OFDM 40 MHz, 5755 MHz

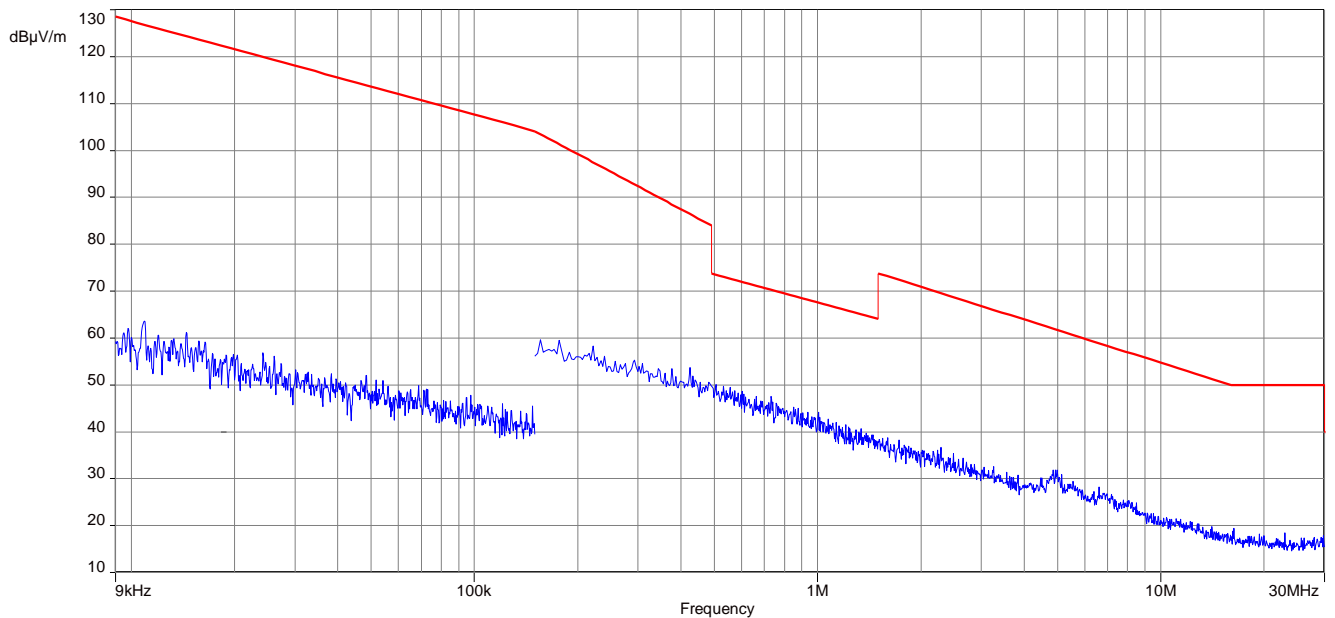

**Plot 11:** 9 kHz to 30 MHz, OFDM 40 MHz, 5795 MHz

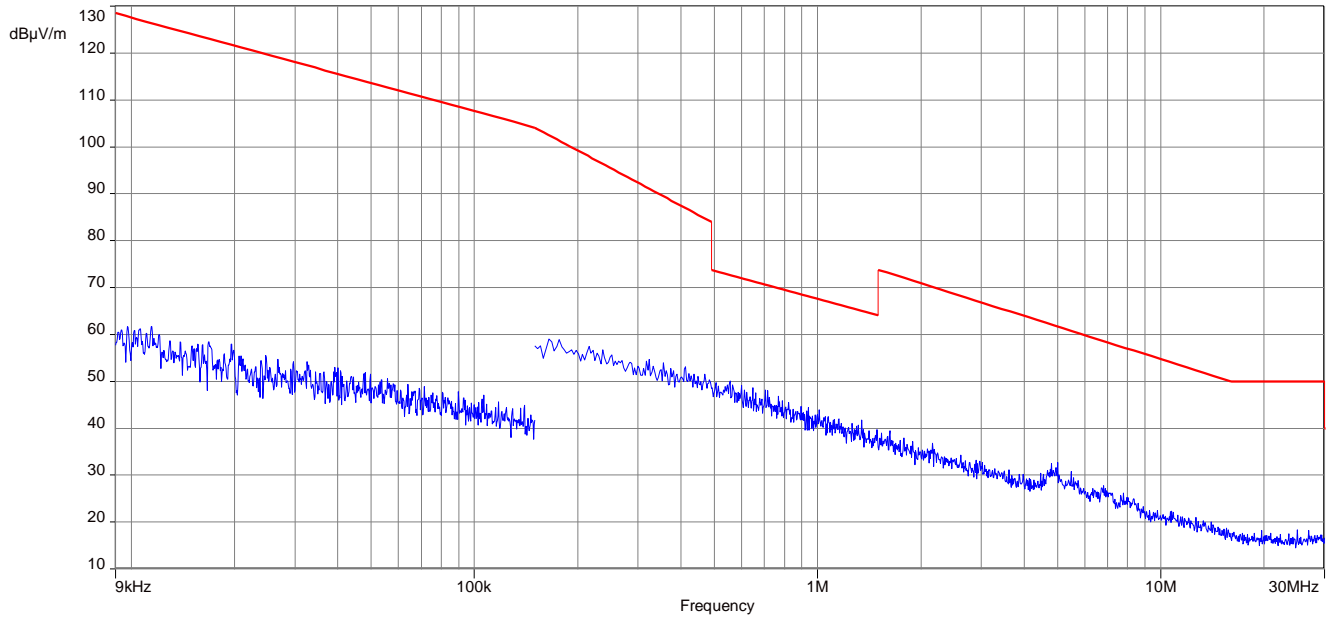

### 11.13 Spurious emissions conducted < 30 MHz

**Description:**

Measurement of the conducted spurious emissions in transmit mode below 30 MHz. The EUT is set to middle channel. If critical peaks are found the lowest channel and the highest channel will be measured too. Both power lines, phase and neutral line, are measured. Found peaks are re-measured with average and quasi peak detection to show compliance to the limits.

**Measurement:**

Measurement parameter	
Detector:	Peak - Quasi Peak / Average
Sweep time:	Auto
Video bandwidth:	9 kHz
Resolution bandwidth:	100 kHz
Span:	150 kHz to 30 MHz
Trace – mode:	Max Hold
Test setup:	See sub clause 6.4 – A
Measurement uncertainty:	See sub clause 8

**Limits:**

Spurious Emissions Conducted < 30 MHz		
Frequency (MHz)	Quasi-Peak (dBµV/m)	Average (dBµV/m)
0.15 – 0.5	66 to 56*	56 to 46*
0.5 – 5	56	46
5 – 30.0	60	50

\*Decreases with the logarithm of the frequency

**Results:**

Spurious Emissions Conducted < 30 MHz [dBµV/m]		
F [MHz]	Detector	Level [dBµV/m]
See tables below the plots		

**Plots:**

**Plot 1:** 150 kHz to 30 MHz, phase line

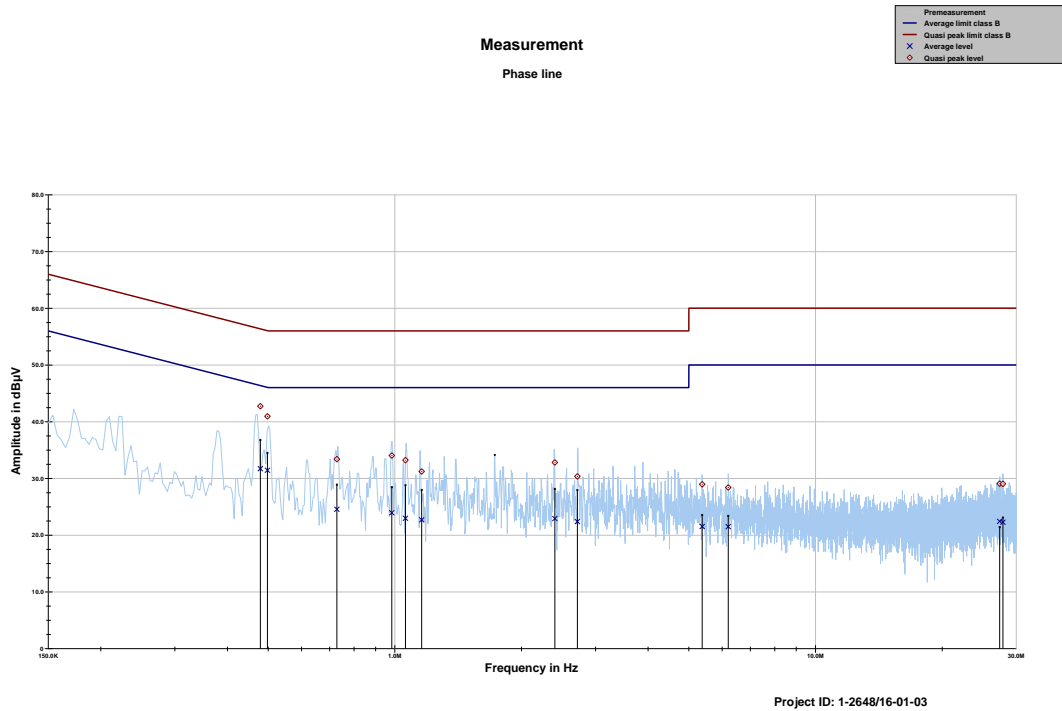

**Final results:**

Frequency	Quasi peak level	Margin quasi peak	Limit QP	Average level	Margin average	Limit AV
MHz	dBµV	dB	dBµV	dBµV	dB	dBµV
0.479044	42.73	13.62	56.356	31.72	14.88	46.599
0.498055	40.94	15.09	56.032	31.44	14.62	46.056
0.728356	33.39	22.61	56.000	24.56	21.44	46.000
0.983471	34.03	21.97	56.000	23.94	22.06	46.000
1.060001	33.22	22.78	56.000	22.96	23.04	46.000
1.158661	31.22	24.78	56.000	22.68	23.32	46.000
2.401149	32.81	23.19	56.000	22.92	23.08	46.000
2.716396	30.36	25.64	56.000	22.39	23.61	46.000
5.378302	28.96	31.04	60.000	21.52	28.48	50.000
6.202800	28.40	31.60	60.000	21.49	28.51	50.000
27.412899	29.08	30.92	60.000	22.42	27.58	50.000
27.892759	29.04	30.96	60.000	22.28	27.72	50.000

**Plot 2:** 150 kHz to 30 MHz, neutral line

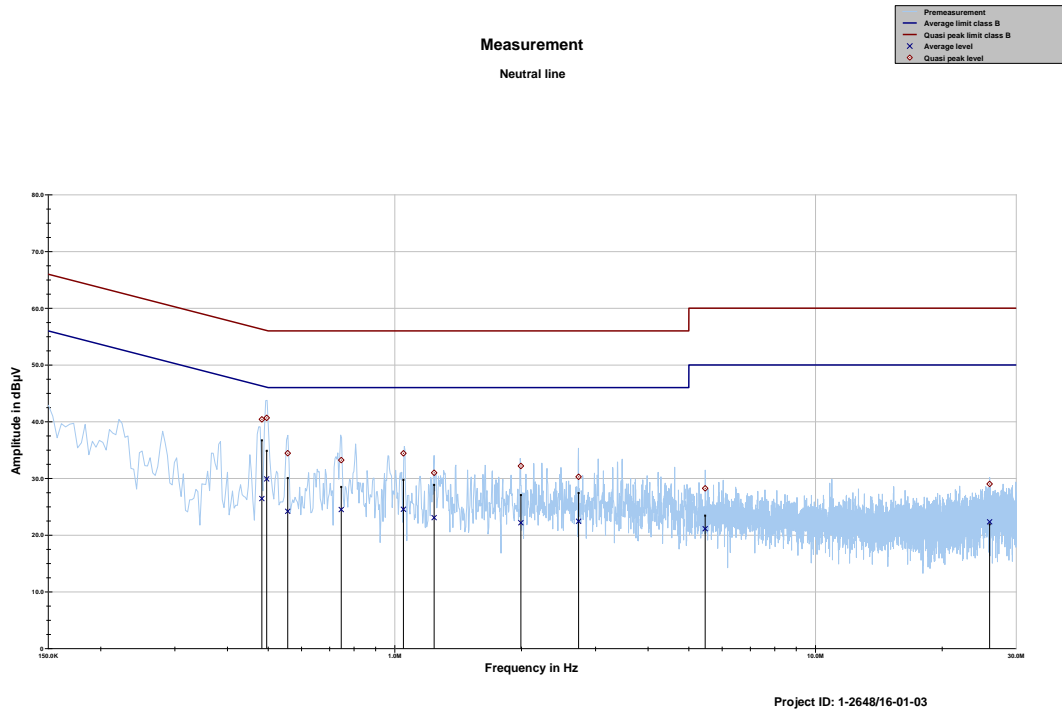

**Final results:**

Frequency	Quasi peak level	Margin quasi peak	Limit QP	Average level	Margin average	Limit AV
MHz	dBµV	dB	dBµV	dBµV	dB	dBµV
0.483032	40.41	15.88	56.287	26.44	20.05	46.485
0.496022	40.67	15.40	56.066	29.91	16.21	46.114
0.556475	34.44	21.56	56.000	24.19	21.81	46.000
0.746112	33.23	22.77	56.000	24.50	21.50	46.000
1.048382	34.42	21.58	56.000	24.56	21.44	46.000
1.240047	30.98	25.02	56.000	23.08	22.92	46.000
1.993677	32.18	23.82	56.000	22.18	23.82	46.000
2.734286	30.28	25.72	56.000	22.44	23.56	46.000
5.466816	28.25	31.75	60.000	21.13	28.87	50.000
25.942757	29.03	30.97	60.000	22.33	27.67	50.000



## Annex A Document history

Version	Applied changes	Date of release
	Initial release	2017-03-23

## Annex B Further information

### Glossary

AVG	-	Average
DUT	-	Device under test
EMC	-	Electromagnetic Compatibility
EN	-	European Standard
EUT	-	Equipment under test
ETSI	-	European Telecommunications Standard Institute
FCC	-	Federal Communication Commission
FCC ID	-	Company Identifier at FCC
HW	-	Hardware
IC	-	Industry Canada
Inv. No.	-	Inventory number
N/A	-	Not applicable
PP	-	Positive peak
QP	-	Quasi peak
S/N	-	Serial number
SW	-	Software
PMN	-	Product marketing name
HMN	-	Host marketing name
HVIN	-	Hardware version identification number
FVIN	-	Firmware version identification number
OBW		Occupied Bandwidth
OC		Operating Channel
OCW		Operating Channel Bandwidth
OOB		Out Of Band

## Annex C Accreditation Certificate

first page

last page



Deutsche Akkreditierungsstelle GmbH

Bellehene gemäß § 8 Absatz 1 AkkStelleG i.V.m. § 1 Absatz 1 AkkStelleGBV  
Unterzeichnerin der Multilateralen Abkommen  
von EA, ILAC und IAF zur gegenseitigen Anerkennung

### Akkreditierung



Die Deutsche Akkreditierungsstelle GmbH bestätigt hiermit, dass das Prüflaboratorium

**CTC advanced GmbH**  
Untertürkheimer Straße 6-10, 66117 Saarbrücken

die Kompetenz nach DIN EN ISO/IEC 17025:2005 besitzt, Prüfungen in folgenden Bereichen durchzuführen:

**Funk**  
Mobilfunk (GSM / DCS) + OTA  
Elektromagnetische Verträglichkeit (EMV)  
Produktsicherheit  
SAR / EMF  
Umwelt  
Smart Card Technology  
Bluetooth®  
Automotive  
Wi-Fi-Services  
Kandische Anforderungen  
US-Anforderungen  
Akustik  
Near Field Communication (NFC)

Die Akkreditierungsurkunde gilt nur in Verbindung mit dem Bescheid vom 25.11.2016 mit der Akkreditierungsnummer D-PL-12076-01 und ist gültig bis 17.01.2018. Sie besteht aus diesem Deckblatt, der Rückseite des Deckblatts und der folgenden Anlage mit insgesamt 63 Seiten.

Registrierungsnummer der Urkunde: D-PL-12076-01-01

Frankfurt, 25.11.2016

Stelle Minister auf der Rückseite

Im Auftrag Dipl.-Ing. (FH) Ralf Eigner  
Abteilungsleiter

Deutsche Akkreditierungsstelle GmbH

Standort Berlin  
Spittelmarkt 10  
10117 Berlin

Standort Frankfurt am Main  
Europa-Allee 52  
60327 Frankfurt am Main

Standort Braunschweig  
Bundesallee 100  
38116 Braunschweig

Die auszugsweise Veröffentlichung der Akkreditierungsurkunde bedarf der vorherigen schriftlichen Zustimmung der Deutsche Akkreditierungsstelle GmbH (DAkkS). Ausgenommen davon ist die separate Weiterverbreitung des Deckblattes durch die umseitig genannte Konformitätsbewertungsstelle in unveränderter Form.

Es darf nicht der Anschein erweckt werden, dass sich die Akkreditierung auch auf Bereiche erstreckt, die über den durch die DAkkS bestätigten Akkreditierungsbereich hinausgehen.

Die Akkreditierung erfolgte gemäß des Gesetzes über die Akkreditierungsstelle (AkkStelleG) vom 31. Juli 2009 (BGBl. I S. 2625) sowie der Verordnung (EG) Nr. 765/2008 des Europäischen Parlaments und des Rates vom 9. Juli 2008 über die Vorschriften für die Akkreditierung und Marktüberwachung im Zusammenhang mit der Vermarktung von Produkten (Abt. L 218 vom 9. Juli 2008, S. 30). Die DAkkS ist Unterzeichnerin der Multilateralen Abkommen zur gegenseitigen Anerkennung der European co-operation for Accreditation (EA), des International Accreditation Forum (IAF) und der International Laboratory Accreditation Cooperation (ILAC). Die Unterzeichner dieser Abkommen erkennen ihre Akkreditierungen gegenseitig an.

Der aktuelle Stand der Mitgliedschaft kann folgenden Webseiten entnommen werden:  
EA: [www.european-accreditation.org](http://www.european-accreditation.org)  
ILAC: [www.ilac.org](http://www.ilac.org)  
IAF: [www.iaf.eu](http://www.iaf.eu)

**Note:**  
The current certificate including annex can be received on request.