

ingenico
GROUP

Move 5000

User Guide



Optional

www.ingenico.com

28-32, boulevard de Grenelle, 75015 Paris - France / (T) +33 (0)1 58 01 80 00 / (F) +33 (0)1 58 01 91 35
Ingenico - SA au capital de 47 656 332 / 317 218 758 RCS Nanterre

● SEAMLESS PAYMENT

Contents

1	Introduction	4
2	Presentation	5
2_1	Content of the box	5
2_2	Overview on the MOVE/5000	6
2_3	Keyboard details and functionality	8
2_4	Touch panel	9
3	Use of the terminal	10
3_1	Switching off the terminal	10
3_2	Reading card	10
3_3	Scan Engine (Optional)	12
4	Installation	13
4_1	Recommendations	13
4_2	Terminal connections	14
4_2_1	uUSB	14
4_2_2	DC Jack	14
4_2_3	MicroSD memory Card	15
4_2_4	Audio Jack (optional)	15
4_3	Opening trap door	16
4_4	SAMS & SIMS	17

4_5	Battery	18
4_5_1	Main characteristics	18
4_5_2	Installing the battery	18
4_5_3	Charging the battery	20
4_5_4	Changing the battery	21
4_6	Paper roll	22
4_6_1	Main characteristics of INGENICO paper roll	22
4_6_2	Installing paper roll	23
5	Recommendations	24
5_1	Safety	24
5_2	Security of your terminal	25
5_3	Fixed installation	26
6	Standards	28
6_1	Environment (WEEE, Batteries and Packaging)	28
6_2	FCC/IC Compliance	29
6_3	MIC Compliance	33
7	Troubleshooting	34

1_Introduction

We hope that you will be fully satisfied with your new terminal MOVE/5000. This terminal is available in different models. Please select by yourself in this documentation items related to your model.

Read this guide to understand and make the best use of your terminal. It presents you the necessary information about use, installation, maintenance, safety and security recommendations.

WARRANTY / SECURITY



Use only the power supply included with the product to ensure best performance and safety. Maintenance should only be provided by Ingenico authorized technician. Failure to comply with these instructions will void the manufacturer's responsibility.



This symbol indicates an important Warning.



This symbol indicates a piece of advice.

● SEAMLESS PAYMENT

2_Presentation

2_1 Content of the box

- **MOVE/5000 terminal unit equipped with a paper roll**



- **A battery pack disconnected**



- **User guide**



- **Power adapter**

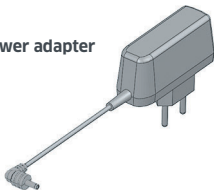

WARNING

The power supply unit provided with your equipment is specially designed for Ingenico terminals. Do not use any other power supply. The use of a power supply with apparently similar voltage/current characteristics may damage your terminal.

● SEAMLESS PAYMENT



ADVICE

Keep the packaging. It must be re-used whenever the terminal is shipped.

2.2 Overview of the MOVE/5000



> Terminal unit

3"5 LCD Display with touch panel

Easy loading printer

Backlit keyboard

Magnetic card reader

Smart card reader

● SEAMLESS PAYMENT

> Compartment where are located:

- the battery pack
- the modules SAM1/SAM2/SIM1/SIM2
- the 2nd Smart card reader (optional)



Weight (without paper roll nor battery)	310g
Dimensions (L x w x h)	169x78x57 mm
Electrical mains network	100-240VAC / 50-60 Hz - Class II equipment
Connections on terminal	Micro USB AB serial link Power connector Contacts for Cradle

2_3 Keyboard details and functionality



Some keys can have other functions according to the applications that are in the terminal.



The functions key accesses the different application menus

The red key cancels the procedure in progress

The yellow key cancels the last character

The green key validates input selections and information. It is also used to switch on the terminal

Feed paper a few centimeters if pressed for a long time (more than 2 seconds)

● SEAMLESS PAYMENT

2_4 Touch panel

Move/5000 features touch screen display, allowing user interaction via finger or a stylus. Note that there are 2 different stylus pens depending on the touch screen type, one for Move/5000 with resistive touch screen and one for Move/5000 with capacitive touch screen as shown below :



Resistive stylus



Capacitive stylus

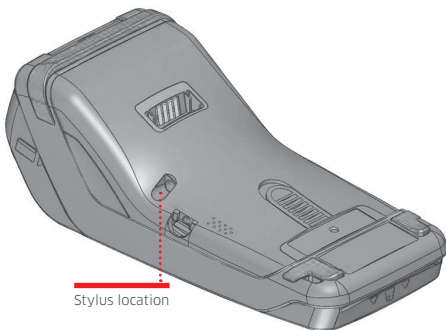

Retractable stylus is located at the back cover as shown above :

3_Use of the terminal





ADVICE

Before to use the terminal, always check if the roll of paper is present.

3_1 Switching off the terminal

If the battery is empty and the terminal in use is removed from its base, the terminal automatically shuts off.

It may also be switch by pressing simultaneously  and  (yellow key) for one second.

In order to restart the terminal, press  on the keyboard.

3_2 Reading card

Magnetic stripe card

The card can be read either from bottom to top or from top to bottom, with the stripe facing the terminal.

Use a regular movement in order to ensure a reliable card reading.



Smart card

- **Card reader:** insert the card horizontally with the chip facing upwards and leave in position throughout the transaction.



- **2nd card reader (Optional):** is located under terminal trapdoor (on back of the terminal). Insert the card up side down chip facing the terminal.



Contactless (optional)

- Bring the card firmly up to the active zone. Keep the card close to the reader during the transaction
- The 4 virtual LEDs are displayed during the transaction.

The terminal behavior for the cardholder may depend on:

- The terminal environment
- Local usage (language...)



● SEAMLESS PAYMENT

3.3 Scan Engine (Optional)

An optional Camera Autofocus with LED or an optional Barcode module can be fitted on back of Move/5000 terminal (dedicated reference).

About camera feature, 11.16.7B SDK minimum is required to have the benefit of Honeywell® Library.



Different formats barcode can be decoded, exhaustive list is given below :

- UPC
- EAN
- CODES 11,39, 93 & 128
- Interleaved 2 of 5
- CODABAR & CODABLOCK
- GS1_DATABAR (RSS) & DATABAR_EXPANDED
- QR_CODE
- DATA_MATRIX
- AZTEC
- PDF417 & Micro PDF 417
- MAXICODE
- POSTAL CODES

If other types of barcode formats have to be decoded, please share your request with your Region Coordination Manager to check the feasibility.

4_Installation

4_1 Recommendations

Location of the Move5000

Place the base on flat surface near an electric socket and according to the base to the telephone or a Ethernet socket. The terminal should be placed far from any very hot zones, protected from vibrations, dust, damp and electromagnetic radiation (computer screen, anti-theft barrier etc.).

Operating conditions

Ambient temperature	from +0°C to +50°C
Max relative humidity	85% at +40°C

Battery charging conditions

Ambient temperature	from +0°C to +40°C
---------------------	--------------------

Storage conditions

Ambient temperature	from -20°C to +55°C
Max relative humidity	85% at +55°C

4_2 Terminal connections

4_2_1 uUSB

- There is an USB connector (microAB) on the left side of the Move/5000 Wireless terminal (see below picture). This connector manages Host and Slave connexions.
- The terminal supports USB Keys with FAT16 or FAT32
- The USB Key has to be used with an USB adapter (refers to accessories section)

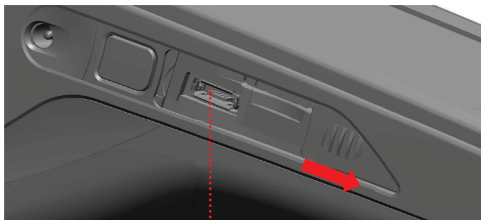

USB micro AB

Connector used for USB Key, etc...

****MicroAB connector durability: up to 10 000 mating cycles***

4_2_2 DC Jack



Power Supply Jack

Connector used to plug DC power supply 5V delivered by Ingenico

● SEAMLESS PAYMENT

4_2_3 MicroSD memory Card

- Insert the MicroSD Memory Card into the connector slot as shown on the figure.
- MicroSD connector is located on terminal side.
- The terminal supports MicroSD up to 32GB

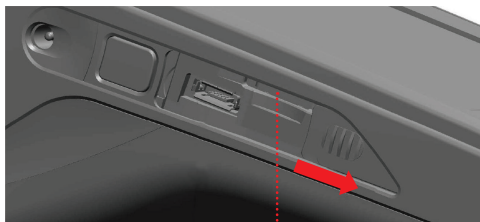

microSD connector

4_2_4 Audio Jack (optional)



Audio Jack 3"5

● SEAMLESS PAYMENT

4_3 Opening trap door



CAUTION

Switch off the terminal before opening the trapdoor.

- Turn the terminal and unclip the trapdoor by pushing on the clip with as shown with the arrows on the picture



4_4 SAMs & SIMs

The connector modules security SAM/SIM are located inside the terminal, in a closed compartment.

- SAMs and SIMs are identified by the engraved marks on the lower housing
- When introducing a SAM/SIM in its slot, be sure to put the cut corner as indicated on the engraved marks

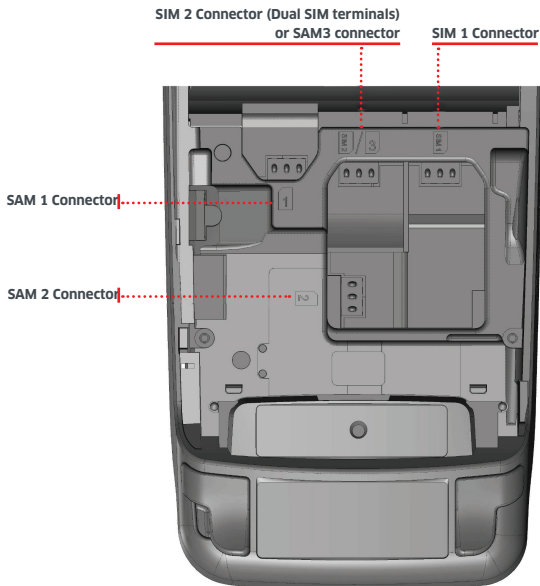

● SEAMLESS PAYMENT

4_5 Battery

4_5_1 Main characteristics

Characteristics	Li-ion 2900 mAh
Charge (power supply-1.5A)	50% capacity in 1,5 h; full capacity in 4 hours
Battery life	<ul style="list-style-type: none">● 450 transactions in GPRS with fully charged battery, printing and backlit activated● Can remain powered ON up to 150 hours with connected GPRS link and terminal in sleeping state starting with fully charged battery and without energy consumption related to backlit or radio link

* *The battery capacity depends on the model of terminal and its use*

4_5_2 Installing the battery



WARNING

Check that the terminal is not connected to the main electric network.

- Turn your terminal and unclip the battery trapdoor by pushing on the button as shown on the picture
- Disengage the trapdoor
- Take the battery pack included in the box
- Locate the battery pack connector beside the battery compartment
- Plug the battery pack connector **according to the connector locating system and** (as shown on picture). Verify that it locks.
- Place the battery pack in its compartment.
- Close the battery compartment trapdoor.

● SEAMLESS PAYMENT



4_5_3 Charging the battery

➤ When does the battery need to be charged?

- On initial start up, charge the battery under the environmental conditions stated above
- When used daily, the terminal recharges its batteries each time it is placed on its base . Charging is automatic
- When used with a terminal power supply: connect the power supply to Move5000 power connector.

➤ How does the battery need to be charged?

- The environment in which the charge takes place influences battery lifetime and autonomy (number of transactions)

The optimal conditions are as follows:

/ Charging away from any external heat source (radiator, sun, enclosed area...)

/ The optimal temperature is between +15°C and +25°C

➤ How can the battery be charged?

Using the base

- Place the terminal on its base
- **Check if the battery symbol is flashing or moving (=battery charging).**



Using the terminal power supply (the terminal is out of its base)

- Connect the terminal power supply unit to use the jack connector located on the left side of the terminal.
- Connect the power supply unit to the power supply mains network
- **Check to see if the battery symbol is flashing or moving(=battery charging)**

4_5_4 Changing the battery



It is imperative to use a battery authorized by Ingenico. There is danger of explosion if battery used is not approved by Ingenico.

- Remove the terminal from its base
- Turn it off by pressing simultaneously  and  (yellow key) for about one second
- Remove the battery trapdoor (see section 4.5.2 "installing battery")
- Carefully disconnect battery, following the instructions below, For standard battery :

a Unlock the connector by pressing the locking mechanism as indicated by F1 arrow while pulling this connector (F2 arrow). Release traction on it as soon as the connector comes unclipped

b Finish extracting connector by tilting it slightly (F3 arrow) to bring it away from the terminal housing

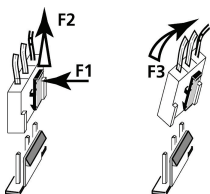

- Following the instructions below for Hardpack battery :

a Unlock the connector by moving up the battery pack latch (F1)

b Finish extracting battery pack by raising slightly the connector to bring battery pack away from the terminal housing. (F2)

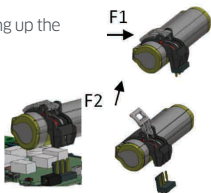

- Connect and install the new battery by following the instructions in section 4.5.2 "Installing battery"
- Close the battery trapdoor and charge the new battery. See section «Charging the Battery»
- In order to preserve the environment, dispose used battery in compliance with current country recycling legislation.

● SEAMLESS PAYMENT

4_6 Paper roll

4_6_1 Mains characteristics of INGENICO paper roll

R40 paper roll Characteristics	Precisions
Colour	White
Width	58 mm
Diameter	40 mm
Length	About 18 metres

- The thermal paper can be deteriorated by poor storage conditions, so we recommend you to avoid:
 - / storage in hot wet places (near air-conditioner, humidity higher than 85%)
 - / exposure to sunlight or ultraviolet for long periods
 - / contact with organic solvents (solvent type adhesive)
 - / direct contact with materials containing plasticizers (PVC transparent folders or envelopes)
 - / direct contact with «dialzo» papers
 - / direct contact with water
 - / Rubbing or pressing the paper too strongly



WARNING

For best product performance, **only use heat sensitized paper approved by Ingenico.**



WARNING

Switch off the terminal prior to installing a paper roll.
Use only paper approved by Ingenico.
The use of non approved paper is likely to damage the printer of your terminal.

● SEAMLESS PAYMENT

4_6_2 Installing paper roll

- Open the paper compartment by lifting the catch located at the rear of the terminal and pull the cover to the rear of the terminal.

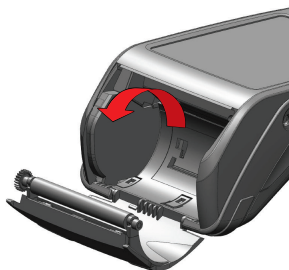

- Insert the paper roll in the compartment following the directions shown on the below picture
- Pull the paper up to the top of the terminal
- Maintain the paper and close the lid
- Press simultaneously on both upper corners of the paper flap, as shown by arrows on picture, until it clips into position

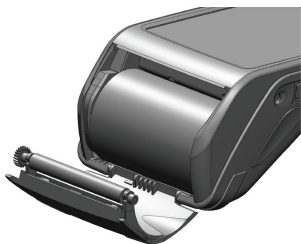

● SEAMLESS PAYMENT



ADVICE

If you insert a new R40 paper roll, tear off the first length (one complete turn to avoid printing on adhesive tape footprint).

5_Recommendations

5_1 Safety

Powering down the Move/5000 :

Disconnect the Move/5000 power supply block adapter from the electrical mains network.

Lithium cell

The Move/5000 is fitted with an internal lithium cell which can only be accessed by a qualified technician.

Battery

Move5000 is fitted with battery specially designed for this terminal.

- Only use the appropriate chargers and batteries listed in the Ingenico's catalogue.
- Do not short-circuit the battery.
- Do not attempt to open the battery container.
- Used batteries must be disposed of at the appropriate sites.



WARNING

There is a risk of explosion if the battery is incorrectly replaced or is placed in a fire.

Electrical power outlet

The electrical outlet must meet the following criteria :







- Must be installed **near the equipment and easily accessible**;
- Must meet standards and regulations in the country where used;
- For type A plug, the protection of the installation must be set to 20 A

SAR exposure

- Maximum SAR value : 1.880 W/kg (LTE FDD I 2100 MHz)
- Maximum simultaneous SAR value : 1.998 W/kg

● SEAMLESS PAYMENT

The power supply label contains seven symbols :

	Double insulation symbol
	DC current output
	AC current input
	DC Power jack polarity
	In door use only
	International Efficiency Marking Protocol (Energy Star Level 5)
	International Efficiency Marking Protocol (Energy Star Level 6)

SAM1/SAM2/SIM1/(SAM3/SIM2) readers compartment

The trapdoor for battery, SAM1/SAM2/SIM1/(SAM3/SIM2), readers located underneath the terminal, must be in place during the normal operation of the terminal. See sections «Removal of SAM1/SAM2/SIM, modules» as well as «Connecting the battery».

On airplanes

Your handset must be switched off by removing the battery pack. Remove the battery from the terminal when on an airplane.

Non-compliance with these safety rules may result in legal action and/or a ban on later access to cellular network services.

Explosion areas

Certain regulations restrict the use of radio equipment in chemical plants, fuel depots and any site where blasting is carried out. You are urged to comply with these regulations. The terminal shall be protected by a specially fitted and certified cover enabling use in proximity to a fuel pump.

Electronic health appliances

Your handset is a radio transmitter which may interfere with health appliances, such as hearing aids, pacemaker, hospital equipment, etc.

Your doctor or the equipment manufacturer will be able to provide you with appropriate advice.

External connection

All external circuits connected to the Move/5000 must be SELV (Safety Extra Low Voltage) and LPS (limited power source) within the meaning of section 2.2 and 2.5 of the standard IEC60950-1:2005+/A1:2010 and EN60950-1:2006+/A11:2009+/A1:2010+/A12:2011

Cleaning

To clean the terminal, use a soft cloth slightly moistened with water. Do not clean the electrical connections; do not use solvents, detergents or abrasive products.

5_2 Security of your terminal

Your device fulfils current applicable PCI PTS security requirements. Upon receipt of your terminal you should check for signs of tampering of the equipment. It is strongly advised that these checks are performed regularly after receipt. You should check, for example: that the keypad is firmly in place; that there is no evidence of unusual wires that have been connected to any ports on your terminal or associated equipment, the chip card reader or any other part of your terminal. Such checks would provide warning of any unauthorised modifications to your terminal, and other suspicious behaviour of individuals that have access to your terminal. Your terminal detects any "tampered state". In this state the terminal will repeatedly flash the message "Alert Irruption!" and further use of the terminal will not be possible. If you observe the "Alert Irruption!" message, you should contact the terminal helpdesk immediately.

You are strongly advised to ensure that privileged access to your terminal is only granted to staff that have been independently verified as being trustworthy.

The terminal must never be put in or left at a location where it could be stolen or replaced by another device.