

CETECOM ICT Services is now

CTC | **advanced**
member of RWTÜV group

TEST REPORT

Test report no.: 1-2628/16-01-02



Deutsche
Akkreditierungsstelle
D-PL-12076-01-01

Testing laboratory

CTC advanced GmbH

Untertuerkheimer Strasse 6 – 10

66117 Saarbruecken / Germany

Phone: + 49 681 5 98 - 0

Fax: + 49 681 5 98 - 9075

Internet: <http://www.ctcadvanced.com>

e-mail: mail@ctcadvanced.com

Accredited Testing Laboratory:

The testing laboratory (area of testing) is accredited according to DIN EN ISO/IEC 17025 (2005) by the Deutsche Akkreditierungsstelle GmbH (DAkkS)

The accreditation is valid for the scope of testing procedures as stated in the accreditation certificate with the registration number: D-PL-12076-01-01

Applicant

Ingenico Group

9 Avenue de la Gare Rovaltain

26958 Valence Cedex 9 / FRANCE

Phone: -/-

Fax: -/-

Contact: Jean-Baptiste Palisse

e-mail: jean-baptiste.palisse@ingenico.com

Phone: +33 4 75 84 21 74

Manufacturer

Ingenico Group

9 Avenue de la Gare Rovaltain

26958 Valence Cedex 9 / FRANCE

Test standard/s

47 CFR Part 15

Title 47 of the Code of Federal Regulations; Chapter I; Part 15 - Radio frequency devices

RSS-210 Issue 9

Licence-Exempt Radio Apparatus: Category I Equipment

For further applied test standards please refer to section 3 of this test report.

Test Item

Kind of test item: Mobile payment terminal

Model name: Move/2500

FCC ID: XKB-M2500CL3G

IC: 2586D-M2500CL3G

Frequency: 13.56 MHz

Technology tested: RFID

Antenna: Integrated loop antenna

Power supply: 5.00 V DC by external 115 V AC power supply unit

(P SM05A-0501-R) and
3.60 V DC by Li-Ion battery

Temperature range: -20°C to +50°C



This test report is electronically signed and valid without handwriting signature. For verification of the electronic signatures, the public keys can be requested at the testing laboratory.

Test report authorized:

Andreas Luckenbill
Lab Manager
Radio Communications & EMC

Test performed:

Marco Bertolino
Lab Manager
Radio Communications & EMC

1 Table of contents

1	Table of contents	2
2	General information	3
2.1	Notes and disclaimer	3
2.2	Application details.....	3
2.3	Test laboratories sub-contracted	3
3	Test standard/s and references	4
4	Test environment.....	5
5	Test item.....	5
5.1	General description.....	5
5.2	Additional information	5
6	Description of the test setup.....	6
6.1	Shielded semi anechoic chamber.....	7
6.2	Shielded fully anechoic chamber	8
6.3	AC conducted	9
6.4	Test setup for normalized measurement configurations & frequency error.....	10
7	Sequence of testing	11
7.1	Sequence of testing radiated spurious 9 kHz to 30 MHz.....	11
7.2	Sequence of testing radiated spurious 30 MHz to 1 GHz.....	12
8	Measurement uncertainty	13
9	Summary of measurement results	14
10	Additional comments	14
11	Measurement results.....	15
11.1	Occupied bandwidth.....	15
11.2	Field strength of the fundamental.....	17
11.3	Field strength of the harmonics and spurious	18
11.4	Conducted limits.....	21
11.5	Frequency error	24
12	Observations	25
Annex A	Document history	25
Annex B	Further information.....	25
Annex C	Accreditation Certificate	26

2 General information

2.1 Notes and disclaimer

The test results of this test report relate exclusively to the test item specified in this test report. CTC advanced GmbH does not assume responsibility for any conclusions and generalizations drawn from the test results with regard to other specimens or samples of the type of the equipment represented by the test item.

The test report may only be reproduced or published in full. Reproduction or publication of extracts from the report requires the prior written approval of CTC advanced GmbH.

The testing service provided by CTC advanced GmbH has been rendered under the current "General Terms and Conditions for CTC advanced GmbH".

CTC advanced GmbH will not be liable for any loss or damage resulting from false, inaccurate, inappropriate or incomplete product information provided by the customer.

Under no circumstances does the CTC advanced GmbH test report include any endorsement or warranty regarding the functionality, quality or performance of any other product or service provided.

Under no circumstances does the CTC advanced GmbH test report include or imply any product or service warranties from CTC advanced GmbH, including, without limitation, any implied warranties of merchantability, fitness for purpose, or non-infringement, all of which are expressly disclaimed by CTC advanced GmbH.

All rights and remedies regarding vendor's products and services for which CTC advanced GmbH has prepared this test report shall be provided by the party offering such products or services and not by CTC advanced GmbH. In no case this test report can be considered as a Letter of Approval.

This test report is electronically signed and valid without handwritten signature. For verification of the electronic signatures, the public keys can be requested at the testing laboratory.

2.2 Application details

Date of receipt of order:	2016-12-08
Date of receipt of test item:	2017-02-01
Start of test:	2017-02-01
End of test:	2017-02-02
Person(s) present during the test:	-/-

2.3 Test laboratories sub-contracted

None

3 Test standard/s and references

Test standard	Date	Description
47 CFR Part 15	-/-	Title 47 of the Code of Federal Regulations; Chapter I; Part 15 - Radio frequency devices
RSS-210 Issue 9	August 2016	Licence-Exempt Radio Apparatus: Category I Equipment
RSS - Gen Issue 4	November 2014	Spectrum Management and Telecommunications Radio Standards Specifications - General Requirements and Information for the Certification of Radio Apparatus

Guidance	Version	Description
ANSI C63.4-2014	-/-	American national standard for methods of measurement of radio-noise emissions from low-voltage electrical and electronic equipment in the range of 9 kHz to 40 GHz
ANSI C63.10-2013	-/-	American national standard of procedures for compliance testing of unlicensed wireless devices

4 Test environment

Temperature	: T _{nom} T _{max} T _{min}	+22 °C during room temperature tests +50 °C during high temperature tests -20 °C during low temperature tests
Relative humidity content	:	35 %
Barometric pressure	:	1021 hpa
Power supply	: V _{nom} V _{max} V _{min}	5.00 V DC by external 115 V AC power supply unit (P SM05A-0501-R) and 3.60 V DC by Li-Ion battery 5.25 V DC 4.75 V DC

5 Test item

5.1 General description

Kind of test item	:	Mobile payment terminal
Type identification	:	Move/2500
HMN	:	-/-
PMN	:	Move/2500
HVIN	:	Move/2500 CL/Eth/Mod/3G
FVIN	:	-/-
S/N serial number	:	162793433221038700001778
HW hardware status	:	01
SW software status	:	OS : 032011 / APPLI : 006200
Frequency band	:	13.553 MHz to 13.567 MHz Carrier frequency: 13.56 MHz
Type of radio transmission	:	modulated carrier, clean carrier
Use of frequency spectrum	:	
Type of modulation	:	OOK
Number of channels	:	1
Antenna	:	Integrated loop antenna
Power supply	:	5.00 V DC by external 115 VAC power supply unit (P SM05A-0501-R) and 3.60 V DC by Li-Ion battery
Temperature range	:	-20°C to +50°C

5.2 Additional information

The content of the following annexes is defined in the QA. It may be that not all of the listed annexes are necessary for this report, thus some values in between may be missing.

Test setup- and EUT-photos are included in test report: 1-2628/16-01-01_AnnexA
 1-2628/16-01-01_AnnexB
 1-2628/16-01-01_AnnexD

6 Description of the test setup

Typically, the calibrations of the test apparatus are commissioned to and performed by an accredited calibration laboratory. The calibration intervals are determined in accordance with the DIN EN ISO/IEC 17025. In addition to the external calibrations, the laboratory executes comparison measurements with other calibrated test systems or effective verifications. Weekly chamber inspections and range calibrations are performed. Where possible, RF generating and signaling equipment as well as measuring receivers and analyzers are connected to an external high-precision 10 MHz reference (GPS-based or rubidium frequency standard).

In order to simplify the identification of the equipment used at some special tests, some items of test equipment and ancillaries can be provided with an identifier or number in the equipment list below (Lab/Item).

Agenda: Kind of Calibration

k	calibration / calibrated	EK	limited calibration
ne	not required (k, ev, izw, zw not required)	zw	cyclical maintenance (external cyclical maintenance)
ev	periodic self verification	izw	internal cyclical maintenance
Ve	long-term stability recognized	g	blocked for accredited testing
vlk!	Attention: extended calibration interval		
NK!	Attention: not calibrated	*)	next calibration ordered / currently in progress

6.1 Shielded semi anechoic chamber

The radiated measurements are performed in vertical and horizontal plane in the frequency range from 9 kHz to 1 GHz in semi-anechoic chambers. The EUT is positioned on a non-conductive support with a height of 0.80 m above a conductive ground plane that covers the whole chamber. The receiving antennas are conform to specifications ANSI C63. These antennas can be moved over the height range between 1.0 m and 4.0 m in order to search for maximum field strength emitted from EUT. The measurement distances between EUT and receiving antennas are indicated in the test setups for the various frequency ranges. For each measurement, the EUT is rotated in all three axes until the maximum field strength is received. The wanted and unwanted emissions are received by spectrum analyzers where the detector modes and resolution bandwidths over various frequency ranges are set according to requirement ANSI C63.

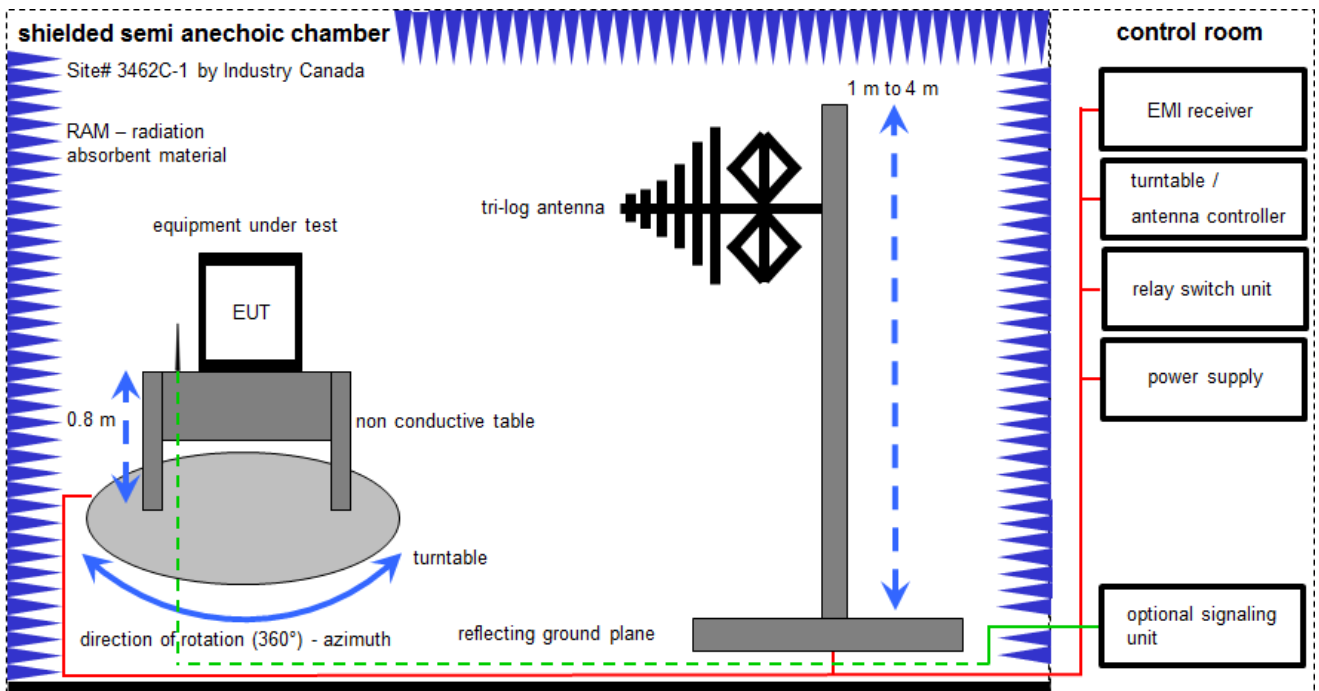

Measurement distance: tri-log antenna 10 meter

$$FS = UR + CL + AF$$

(FS-field strength; UR-voltage at the receiver; CL-loss of the cable; AF-antenna factor)

Example calculation:

$$FS [dB\mu V/m] = 12.35 [dB\mu V/m] + 1.90 [dB] + 16.80 [dB/m] = 31.05 [dB\mu V/m] (35.69 \mu V/m)$$

Equipment table:

No.	Lab / Item	Equipment	Type	Manufacturer	Serial No.	INV. No.	Kind of Calibration	Last Calibration	Next Calibration
1	A	Switch-Unit	3488A	HP	2719A14505	300000368	ev	-/-	-/-
2	A	EMI Test Receiver	ESCI 3	R&S	100083	300003312	k	08.03.2016	08.03.2017
3	A	Analyzer-Reference-System (Harmonics and Flicker)	ARS 16/1	SPS	A3509 07/0 0205	300003314	Ve	02.02.2016	02.02.2018
4	A	Antenna Tower	Model 2175	ETS-Lindgren	64762	300003745	izw	-/-	-/-
5	A	Positioning Controller	Model 2090	ETS-Lindgren	64672	300003746	izw	-/-	-/-
6	A	Turntable Interface-Box	Model 105637	ETS-Lindgren	44583	300003747	izw	-/-	-/-
7	A	TRILOG Broadband Test-Antenna 30 MHz - 3 GHz	VULB9163	Schwarzbeck	295	300003787	k	25.04.2016	25.04.2018

6.2 Shielded fully anechoic chamber

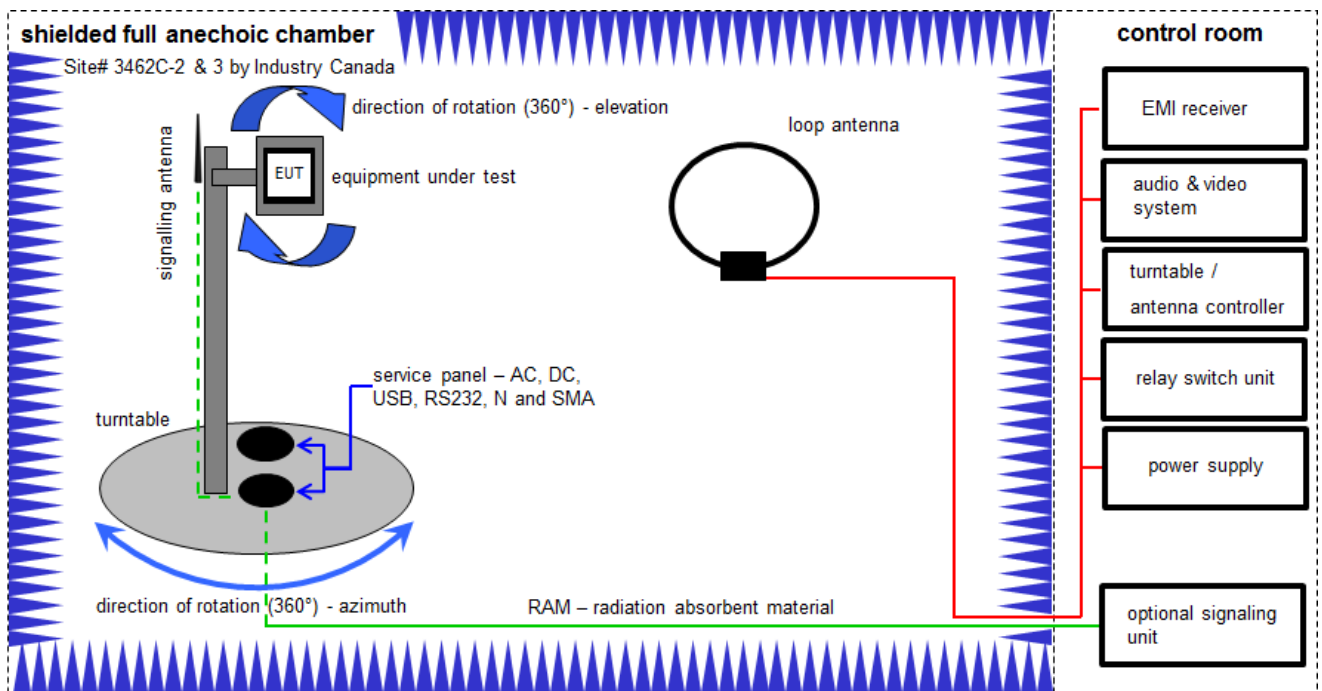

Measurement distance: loop antenna 3 meter

$$FS = UR + CA + AF$$

(FS-field strength; UR-voltage at the receiver; CA-loss of the signal path; AF-antenna factor)

Example calculation:

$$FS [dB\mu V/m] = 40.0 [dB\mu V/m] + (-35.8) [dB] + 32.9 [dB/m] = 37.1 [dB\mu V/m] (71.61 \mu V/m)$$

Equipment table:

No.	Lab / Item	Equipment	Type	Manufacturer	Serial No.	INV. No.	Kind of Calibration	Last Calibration	Next Calibration
1	A	Anechoic chamber	FAC 3/5m	MWB / TDK	87400/02	300000996	ev	-/-	-/-
2	A	Switch / Control Unit	3488A	HP	*	300000199	ne	-/-	-/-
3	A	Active Loop Antenna 10 kHz to 30 MHz	6502	EMCO/2	8905-2342	300000256	k	24.06.2015	24.06.2017
4	A	EMI Test Receiver 20Hz- 26,5GHz	ESU26	R&S	100037	300003555	k	31.01.2017	30.01.2018
5	A	4U RF Switch Platform	L4491A	Agilent Technologies	MY50000037	300004509	ne	-/-	-/-

6.3 AC conducted

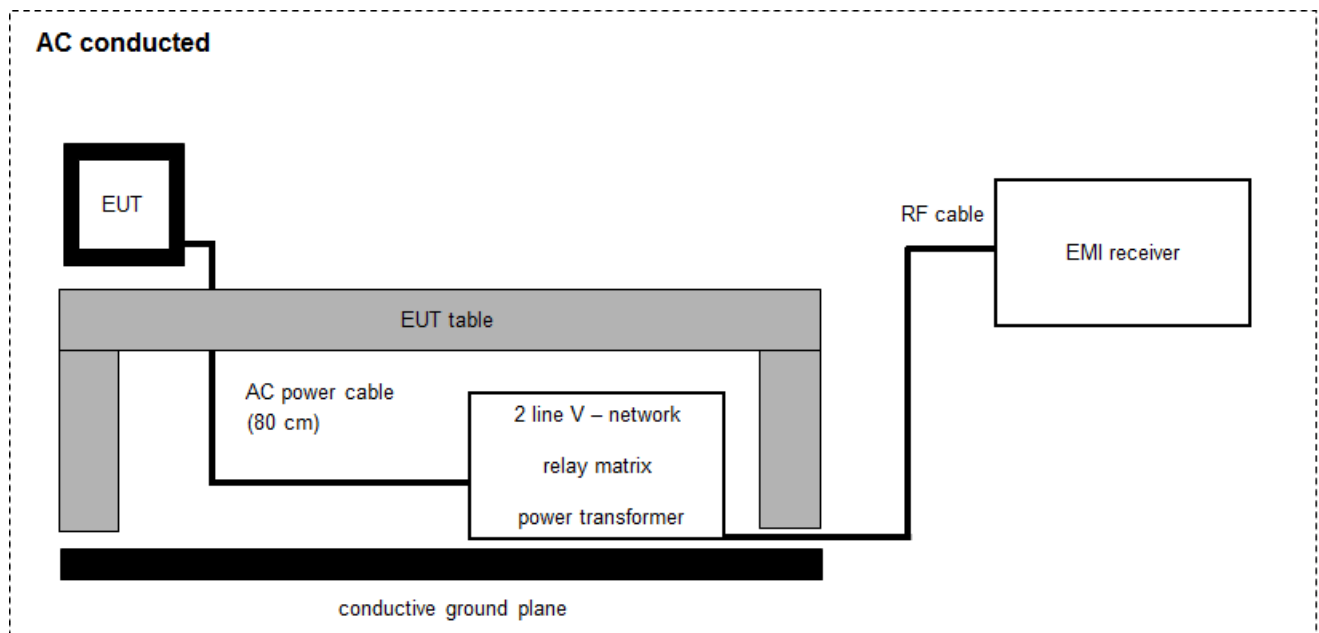

$$FS = UR + CF + VC$$

(FS-field strength; UR-voltage at the receiver; CR-loss of the cable and filter; VC-correction factor of the ISN)

Example calculation:

$$FS [dB\mu V/m] = 37.62 [dB\mu V/m] + 9.90 [dB] + 0.23 [dB] = 47.75 [dB\mu V/m] (244.06 \mu V/m)$$

Equipment table:

No.	Lab / Item	Equipment	Type	Manufacturer	Serial No.	INV. No.	Kind of Calibration	Last Calibration	Next Calibration
1	A	Two-line V-Network (LISN) 9 kHz to 30 MHz	ESH3-Z5	R&S	893045/004	300000584	k	31.01.2017	30.01.2018
2	A	RF-Filter-section	85420E	HP	3427A00162	300002214	k	27.11.2006	-/-
3	A	AC-Spannungsquelle variabel	MV2616-V	EM-Test	0397-12	300003259	k	11.12.2015	11.12.2017
4	A	Hochpass 150 kHz	EZ-25	R&S	100010	300003798	ev	08.04.2008	-/-
5	A	MXE EMI Receiver 20 Hz to 26,5 GHz	N9038A	Agilent Technologies	MY51210197	300004405	k	16.08.2016	16.08.2017
6	A	Analyzer-Reference-System (Harmonics and Flicker)	ARS 16/1	SPS	A3509 07/0 0205	300003314	Ve	02.02.2016	02.02.2018

6.4 Test setup for normalized measurement configurations & frequency error

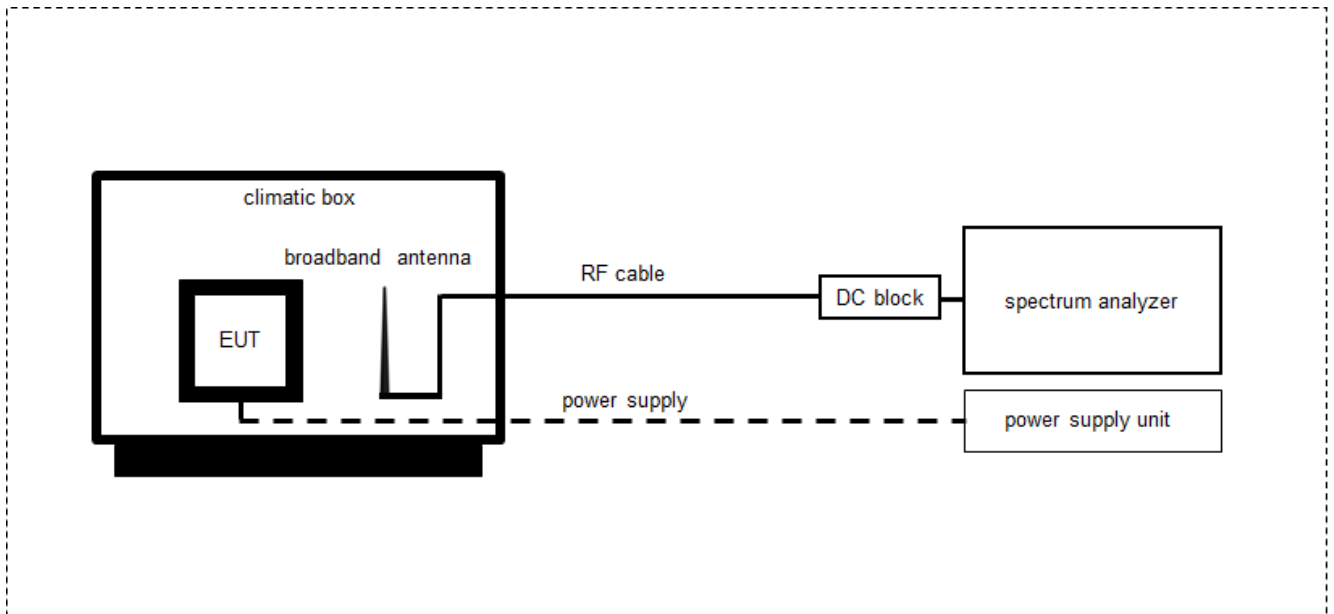

Equipment table:

No.	Lab / Item	Equipment	Type	Manufacturer	Serial No.	INV. No.	Kind of Calibration	Last Calibration	Next Calibration
1	B	Temperature Test Chamber	VT 4002	Heraeus Voetsch	521/83761	300002326	ev	03.09.2015	03.09.2017
2	A; B	Hygro-Thermometer	-/, 5-45C, 20-100rF	Heraeus Voetsch	-/	400000108	ev	07.09.2015	07.09.2017
3	A; B	Signal Analyzer 40 GHz	FSV40	R&S	101042	300004517	k	27.01.2017	26.01.2018
4	B	Power Supply 0-20V, 0-5A	6632B	Agilent Technologies	GB42110541	400000562	vIKI!	26.01.2016	26.01.2019
5	A; B	RF-Cable	ST18/SMAM/SMAM/48	Huber & Suhner	Batch no. 600918	400001182	ev	-/	-/
6	A; B	DC-Blocker 0.1-40 GHz	8141A	Inmet	Batch no. 600918	400001185	ev	-/	-/

7 Sequence of testing

7.1 Sequence of testing radiated spurious 9 kHz to 30 MHz

Setup

- The equipment is set up to simulate normal operation mode as described in the user manual or defined by the manufacturer.
- If the EUT is a tabletop system, a 2-axis positioner with 1.5 m height is used.
- If the EUT is a floor standing device, it is placed directly on the turn table.
- Auxiliary equipment and cables are positioned to simulate normal operation conditions as described in ANSI C 63.4.
- The AC power port of the EUT (if available) is connected to a power outlet below the turntable.
- Measurement distance is 3 m (see ANSI C 63.4) – see test details.
- EUT is set into operation.

Premeasurement

- The turntable rotates from 0° to 315° using 45° steps.
- The antenna height is 1.5 m.
- At each turntable position the analyzer sweeps with positive-peak detector to find the maximum of all emissions.

Final measurement

- Identified emissions during the premeasurement are maximized by the software by rotating the turntable from 0° to 360°. In case of the 2-axis positioner is used the elevation axis is also rotated from 0° to 360°.
- The final measurement is done in the position (turntable and elevation) causing the highest emissions with quasi-peak (as described in ANSI C 63.4).
- Final levels, frequency, measuring time, bandwidth, turntable position, correction factor, margin to the limit and limit will be recorded. A plot with the graph of the premeasurement and the limit is stored.

7.2 Sequence of testing radiated spurious 30 MHz to 1 GHz

Setup

- The equipment is set up to simulate normal operation mode as described in the user manual or defined by the manufacturer.
- If the EUT is a tabletop system, a table with 0.8 m height is used, which is placed on the ground plane.
- If the EUT is a floor standing device, it is placed on the ground plane with insulation between both.
- Auxiliary equipment and cables are positioned to simulate normal operation conditions as described in ANSI C 63.4.
- The AC power port of the EUT (if available) is connected to a power outlet below the turntable.
- Measurement distance is 10 m or 3 m (see ANSI C 63.4) – see test details.
- EUT is set into operation.

Premeasurement

- The turntable rotates from 0° to 315° using 45° steps.
- The antenna is polarized vertical and horizontal.
- The antenna height changes from 1 m to 3 m.
- At each turntable position, antenna polarization and height the analyzer sweeps three times in peak to find the maximum of all emissions.

Final measurement

- The final measurement is performed for at least six highest peaks according to the requirements of the ANSI C63.4.
- Based on antenna and turntable positions at which the peak values are measured the software maximize the peaks by changing turntable position $\pm 45^\circ$ and antenna height between 1 and 4 m.
- The final measurement is done with quasi-peak detector (as described in ANSI C 63.4).
- Final levels, frequency, measuring time, bandwidth, antenna height, antenna polarization, turntable angle, correction factor, margin to the limit and limit are recorded. A plot with the graph of the premeasurement with marked maximum final results and the limit is stored.

8 Measurement uncertainty

Measurement uncertainty	
Test case	Uncertainty
Occupied bandwidth	± used RBW
Field strength of the fundamental	± 3 dB
Field strength of the harmonics and spurious	± 3 dB
Receiver spurious emissions and cabinet radiations	± 3 dB
Conducted limits	± 2.6 dB

9 Summary of measurement results

<input checked="" type="checkbox"/>	No deviations from the technical specifications were ascertained
<input type="checkbox"/>	There were deviations from the technical specifications ascertained
<input type="checkbox"/>	This test report is only a partial test report. The content and verdict of the performed test cases are listed below.

TC Identifier	Description	Verdict	Date	Remark
RF-Testing	CFR Part 15 RSS-210 Issue 9 RSS Gen Issue 4	See table!	2017-02-14	-/-

Test specification clause	Test case	Temperature conditions	Power source conditions	C	NC	NA	NP	Remark
RSS Gen Issue 4	Occupied bandwidth	Nominal	Nominal	<input checked="" type="checkbox"/>	<input type="checkbox"/>	<input type="checkbox"/>	<input type="checkbox"/>	-/-
§ 15.225 (a) RSS-210 Issue 9 B.6	Field strength of the fundamental	Nominal	Nominal	<input checked="" type="checkbox"/>	<input type="checkbox"/>	<input type="checkbox"/>	<input type="checkbox"/>	-/-
§ 15.209 & § 15.225 (b-d) RSS-210 Issue 9 B.6	Field strength of the harmonics and spurious	Nominal	Nominal	<input checked="" type="checkbox"/>	<input type="checkbox"/>	<input type="checkbox"/>	<input type="checkbox"/>	-/-
§ 15.109 RSS Gen Issue 4	Receiver spurious emissions and cabinet radiations	Nominal	Nominal	<input type="checkbox"/>	<input type="checkbox"/>	<input checked="" type="checkbox"/>	<input type="checkbox"/>	No stand-alone receiver mode!
§15.107 §15.207	Conducted limits	Nominal	Nominal	<input checked="" type="checkbox"/>	<input type="checkbox"/>	<input type="checkbox"/>	<input type="checkbox"/>	-/-
§ 15.225 (a) RSS-210 Issue 9 B.6	Frequency tolerance	Normal & extreme conditions	Normal & extreme conditions	<input checked="" type="checkbox"/>	<input type="checkbox"/>	<input type="checkbox"/>	<input type="checkbox"/>	-/-

Note:

- C Compliant
- NC Not compliant
- NA Not applicable
- NP Not performed

10 Additional comments

Reference documents: None

Special test descriptions: None

Configuration descriptions: None

11 Measurement results

11.1 Occupied bandwidth

Measurement:

The emission bandwidth (x dB) is defined as the frequency range between two points, one above and one below the carrier frequency, at which the spectral density of the emission is attenuated x dB below the maximum in-band spectral density of the modulated signal.

Measurement parameters	
Detector:	Peak
Resolution bandwidth:	1 % – 5 % of the occupied bandwidth
Video bandwidth:	≥ 3x RBW
Trace mode:	Max hold
Analyzer function:	99 % power function
Used equipment:	See chapter 6.4 - A
Measurement uncertainty:	See chapter 8

Limit:

IC
for RSP-100 test report coversheet only

Result:

99% emission bandwidth
129.9 kHz

11.2 Field strength of the fundamental

Measurement:

The maximum detected field strength for the carrier signal.

Measurement parameters	
Detector:	Quasi peak / peak (worst case)
Resolution bandwidth:	120 kHz
Video bandwidth:	≥ 3x RBW
Trace mode:	Max hold
Used equipment:	See chapter 6.2 - A
Measurement uncertainty:	See chapter 8

Limit:

FCC & IC		
Frequency (MHz)	Field strength (µV/m)	Measurement distance (m)
13.553 to 13.567	15,848 (84 dBµV/m)	30

Recalculation:

According to ANSI C63.10		
Frequency	Formula	Correction value from 3m to 30m
13.56 MHz	$FS_{limit} = FS_{max} - 40 \log\left(\frac{d_{nearfield}}{d_{measure}}\right) - 20 \log\left(\frac{d_{limit}}{d_{nearfield}}\right)$ <p> FS_{limit} is the calculation of field strength at the limit distance, expressed in dBµV/m FS_{max} is the measured field strength, expressed in dBµV/m d_{near field} is the λ/2π distance d_{measure} is the distance of the measurement point from EUT d_{limit} is the reference limit distance </p>	-21.39 dB

According to ANSI C63.10

Result:

Field strength of the fundamental		
Frequency	13.56 MHz	
Distance	@ 3 m	@ 30 m
Measured / calculated value	81.3 dBµV/m (Peak) 75.2 dBµV/m (QP)	59.9 dBµV/m (Peak) 53.8 dBµV/m (QP)

11.3 Field strength of the harmonics and spurious

Measurement:

The maximum detected field strength for the harmonics and spurious.

Measurement parameters	
Detector:	Quasi peak / average or peak (worst case – pre-scan)
Resolution bandwidth:	F < 150 kHz: 200 Hz 150 kHz < F < 30 MHz: 9 kHz 30 MHz < F < 1 GHz: 120 kHz
Video bandwidth:	F < 150 kHz: 1 kHz 150 kHz < F < 30 MHz: 100 kHz 30 MHz < F < 1 GHz: 300 kHz
Trace mode:	Max hold
Used equipment:	See chapter 6.1 – A See chapter 6.2 – A See chapter 6.4 – A
Measurement uncertainty:	See chapter 8

Limit:

FCC & IC		
Frequency (MHz)	Field strength (dBµV/m)	Measurement distance (m)
0.009 – 0.490	2400/F(kHz)	300
0.490 – 1.705	24000/F(kHz)	30
1.705 – 30	30 (29.5 dBµV/m)	30
30 – 88	100 (40 dBµV/m)	3
88 – 216	150 (43.5 dBµV/m)	3
216 – 960	200 (46 dBµV/m)	3

Note: For a reduced measurement distance, please take a look at the limit line and the ANSI C63.10-2013 sub clause 6.4 radiated emissions from unlicensed wireless devices below 30 MHz.

Result:

Detected emissions			
Frequency (MHz)	Detector	Resolution bandwidth (kHz)	Detected value (dBµV/m @ 3m)
12.7	Peak	9	38.7
	QP	9	24.5
27.1	Peak	9	40.1
	QP	9	31.7

For emissions between 30 MHz and 1 GHz, please look at the table below the 1 GHz plot.

Plots:

Plot 1: 9 kHz – 30 MHz, magnetic emissions

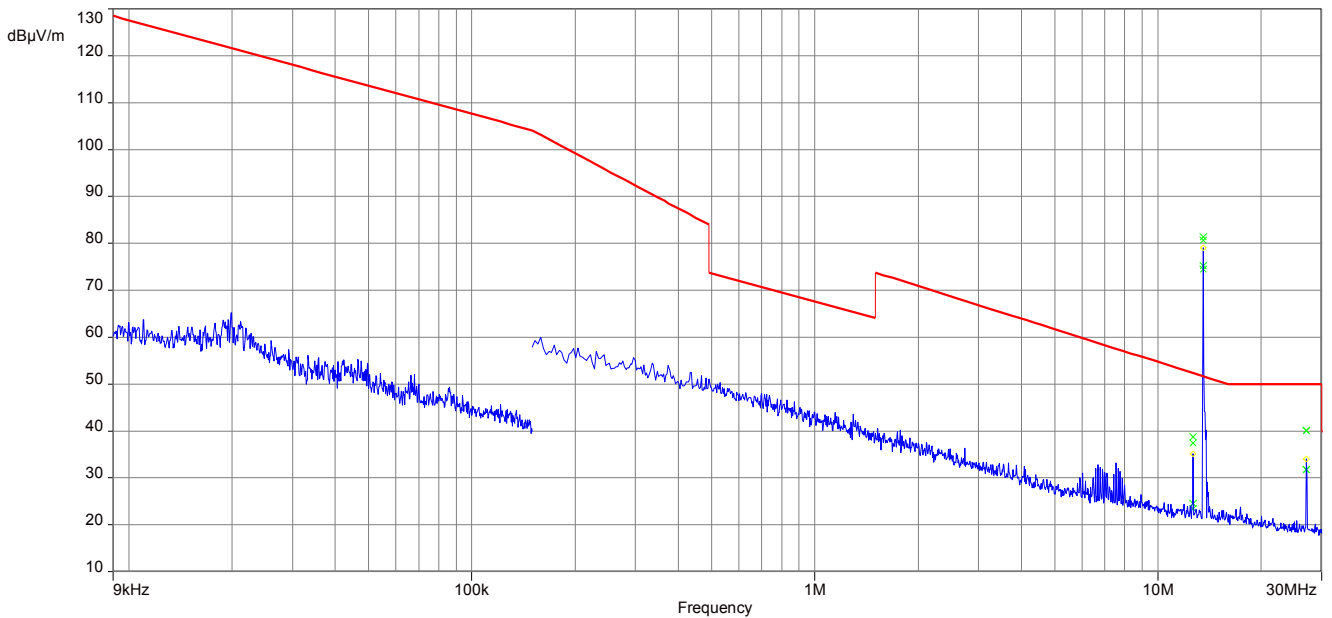

Plot 2: Spectrum mask (the limits are recalculated according to the ANSI C63.10-2013 sub clause 6.4)

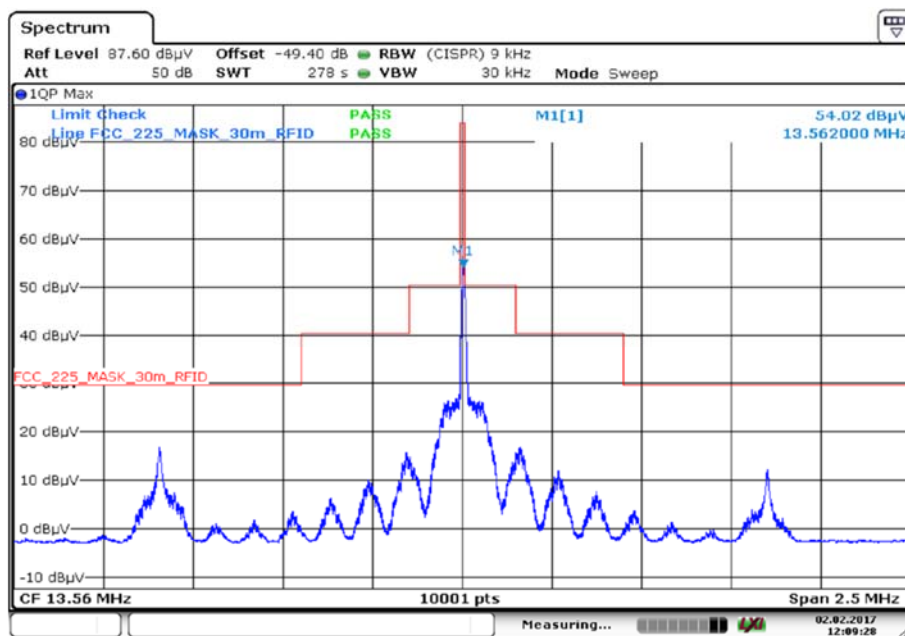

Date: 2.FEB.2017 12:09:29

Plot 3: 30 MHz – 1 GHz, vertical and horizontal polarization

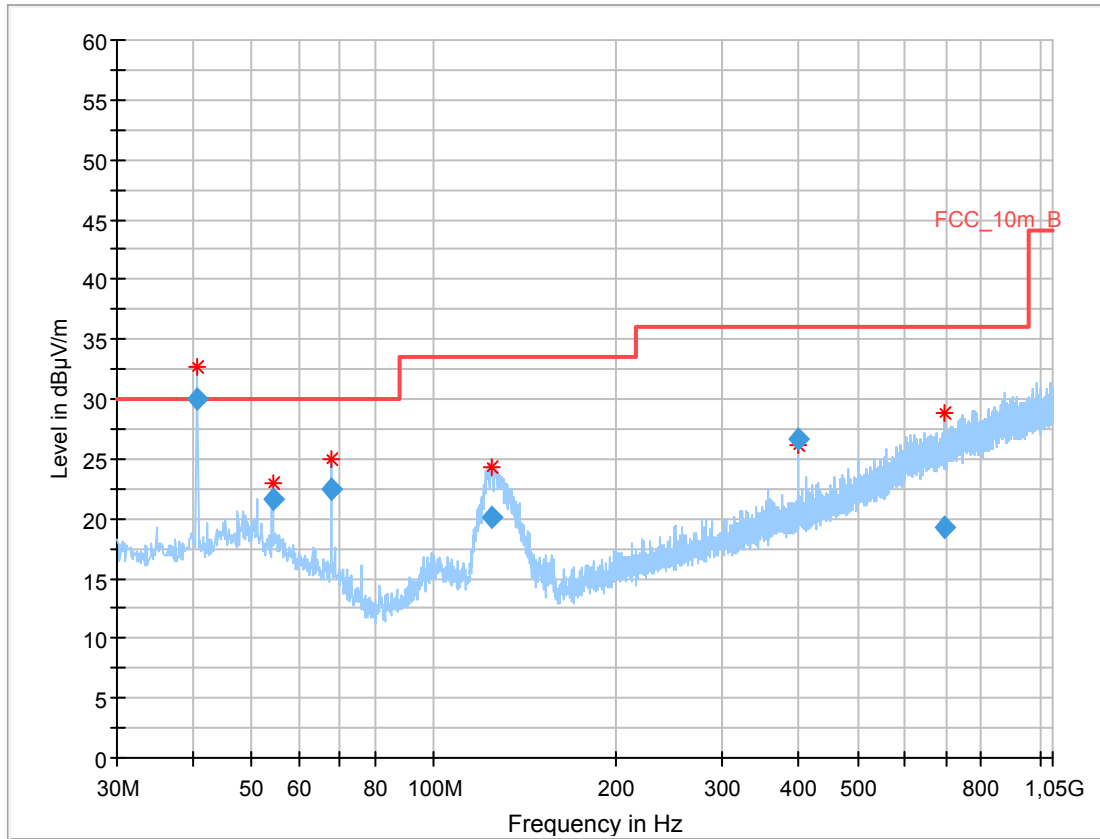

Final_Result:

Frequency (MHz)	QuasiPeak (dBµV/m)	Limit (dBµV/m)	Margin (dB)	Meas. Time (ms)	Bandwidth (kHz)	Height (cm)	Pol	Azimuth (deg)	Corr. (dB)
40.662150	29.98	30.00	0.02	1000.0	120.000	103.0	V	-3.0	13.3
54.225900	21.60	30.00	8.40	1000.0	120.000	203.0	V	275.0	13.2
67.791750	22.50	30.00	7.50	1000.0	120.000	203.0	V	198.0	10.2
124.583550	20.03	33.50	13.47	1000.0	120.000	100.0	V	88.0	9.9
399.986550	26.62	36.00	9.38	1000.0	120.000	200.0	H	84.0	16.9
696.884400	19.30	36.00	16.70	1000.0	120.000	200.0	V	132.0	21.5

11.4 Conducted limits

Measurement:

Measurement of the conducted spurious emissions for an intentional radiator that is designed to be connected to the public utility (AC) power line.

Measurement parameters	
Detector:	Quasi peak / average or peak (worst case – pre-scan)
Resolution bandwidth:	F < 150 kHz: 200 Hz F > 150 kHz: 9 kHz
Video bandwidth:	F < 150 kHz: 1 kHz F > 150 kHz: 100 kHz
Trace mode:	Max hold
Used equipment:	See chapter 6.3 - A
Measurement uncertainty:	See chapter 8

Limit:

FCC & IC		
Frequency (MHz)	Quasi-peak (dBµV/m)	Average (dBµV/m)
0.15 – 0.5	66 to 56	56 to 46
0.5 – 5	56	46
5 – 30.0	60	50

Result:

Detected emissions			
Frequency (MHz)	Detector	Resolution bandwidth (kHz)	Detected value
See table below the plots.			

Plots:

Plot 1: 150 kHz to 30 MHz, phase line

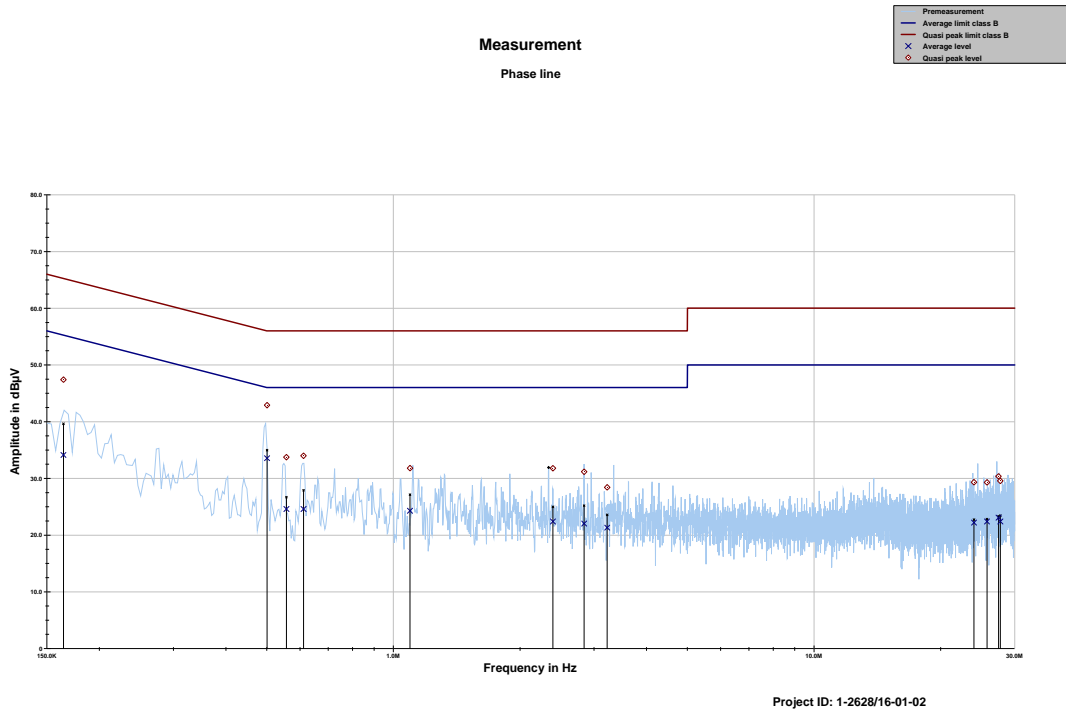

Frequency	Quasi peak level	Margin quasi peak	Limit OQ	Average level	Margin average	Limit AV
MHz	dBµV	dB	dBµV	dBµV	dB	dBµV
0.164252	47.40	17.85	65.246	34.12	21.47	55.593
0.500767	42.90	13.10	56.000	33.54	12.46	46.000
0.556723	33.74	22.26	56.000	24.59	21.41	46.000
0.611520	33.99	22.01	56.000	24.60	21.40	46.000
1.095489	31.79	24.21	56.000	24.28	21.72	46.000
2.394942	31.78	24.22	56.000	22.40	23.60	46.000
2.840708	31.16	24.84	56.000	22.02	23.98	46.000
3.224195	28.42	27.58	56.000	21.31	24.69	46.000
24.002179	29.31	30.69	60.000	22.20	27.80	50.000
25.780127	29.29	30.71	60.000	22.40	27.60	50.000
27.464574	30.35	29.65	60.000	23.06	26.94	50.000
27.736276	29.54	30.46	60.000	22.38	27.62	50.000

Plot 2: 150 kHz to 30 MHz, neutral line

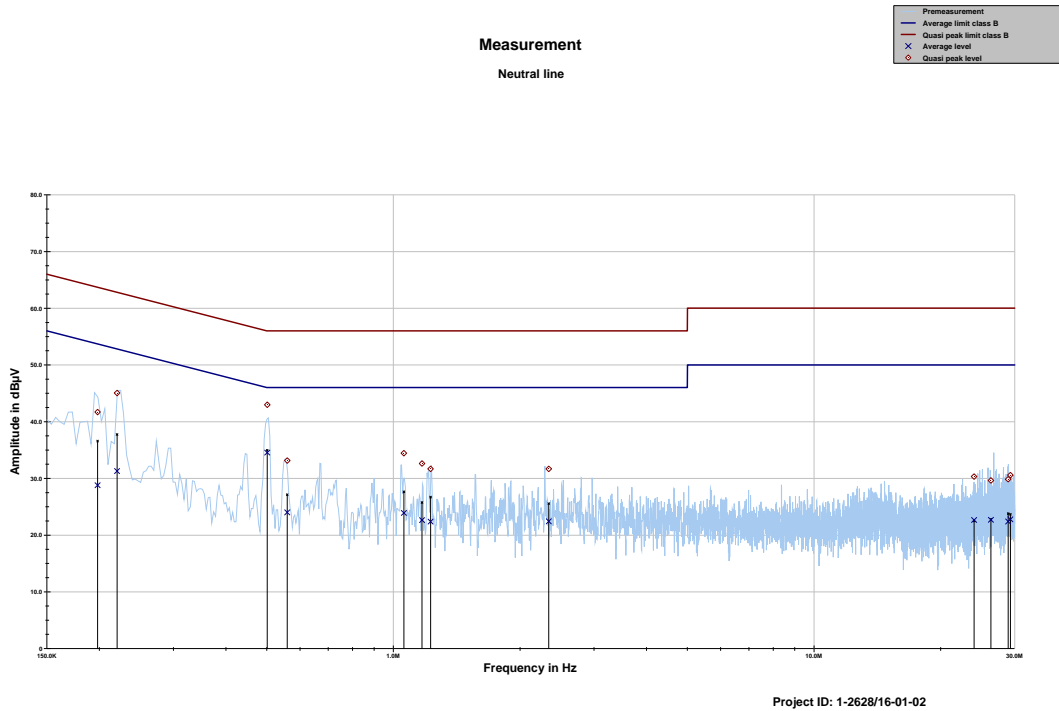

Frequency	Quasi peak level	Margin quasi peak	Limit OQ	Average level	Margin average	Limit AV
MHz	dBµV	dB	dBµV	dBµV	dB	dBµV
0.198051	41.69	22.00	63.692	28.79	25.84	54.627
0.220314	45.04	17.77	62.807	31.29	22.70	53.991
0.501369	42.97	13.03	56.000	34.53	11.47	46.000
0.559424	33.13	22.87	56.000	24.00	22.00	46.000
1.058870	34.44	21.56	56.000	23.90	22.10	46.000
1.169553	32.62	23.38	56.000	22.64	23.36	46.000
1.225734	31.67	24.33	56.000	22.38	23.62	46.000
2.340955	31.66	24.34	56.000	22.42	23.58	46.000
24.015136	30.32	29.68	60.000	22.66	27.34	50.000
26.344510	29.63	30.37	60.000	22.68	27.32	50.000
28.948971	29.84	30.16	60.000	22.39	27.61	50.000
29.303840	30.56	29.44	60.000	22.76	27.24	50.000

11.5 Frequency error

Measurement:

The maximum detected field strength for the spurious.

Measurement parameters	
Detector:	Peak detector
Resolution bandwidth:	10 Hz / 100 Hz
Video bandwidth:	> RBW
Trace mode:	Max hold
Used equipment:	See chapter 6.4 – B
Measurement uncertainty:	See chapter 8

Limit:

FCC & IC
FCC: The frequency tolerance of the carrier signal shall be maintained within +/- 0.01% of the operating frequency over a temperature variation of -20 degrees to +50 degrees C at normal supply voltage, and for a variation in the primary supply voltage from 85% to 115% of the rated supply voltage at a temperature of 20 degrees C. (± 1.356 kHz)
IC: ± 100 ppm

Result: Temperature variation

Frequency tolerance			
Measured frequency (MHz)	Frequency error (kHz)	Conditions	Result
13.5597179	0.282	-20 °C & 100% voltage	compliant
13.5596976	0.302	-10 °C & 100% voltage	compliant
13.5596470	0.353	0 °C & 100% voltage	compliant
13.5596310	0.369	+10 °C & 100% voltage	compliant
13.5596035	0.397	+20 °C & 100% voltage	compliant
13.5595920	0.408	+30 °C & 100% voltage	compliant
13.5595891	0.411	+40 °C & 100% voltage	compliant
13.5595963	0.404	+50 °C & 100% voltage	compliant

Result: Voltage variation

Frequency tolerance			
Measured frequency (MHz)	Frequency error (kHz)	Conditions	Result
13.5596556	0.344	+20 °C & 85% voltage	compliant
13.5596542	0.346	+20 °C & 100% voltage	compliant
13.5596498	0.350	+20 °C & 115% voltage	compliant

12 Observations

No observations except those reported with the single test cases have been made.

Annex A Document history

Version	Applied changes	Date of release
	Initial release	2017-02-14

Annex B Further information

Glossary

AVG	-	Average
DUT	-	Device under test
EMC	-	Electromagnetic Compatibility
EN	-	European Standard
EUT	-	Equipment under test
ETSI	-	European Telecommunications Standard Institute
FCC	-	Federal Communication Commission
FCC ID	-	Company Identifier at FCC
HW	-	Hardware
IC	-	Industry Canada
Inv. No.	-	Inventory number
N/A	-	Not applicable
PP	-	Positive peak
QP	-	Quasi peak
S/N	-	Serial number
SW	-	Software
PMN	-	Product marketing name
HMN	-	Host marketing name
HVIN	-	Hardware version identification number
FVIN	-	Firmware version identification number
OBW		Occupied Bandwidth
OC		Operating Channel
OCW		Operating Channel Bandwidth
OOB		Out Of Band

Annex C Accreditation Certificate

first page

last page



Deutsche Akkreditierungsstelle GmbH

Befehlene gemäß § 8 Absatz 1 AkkStelleG i.V.m. § 1 Absatz 1 AkkStelleGBV
Unterzeichnerin der Multilateralen Abkommen
von EA, ILAC und IAF zur gegenseitigen Anerkennung

Akkreditierung



Die Deutsche Akkreditierungsstelle GmbH bestätigt hiermit, dass das Prüflaboratorium

CTC advanced GmbH
Untertürkheimer Straße 6-10, 66117 Saarbrücken

die Kompetenz nach DIN EN ISO/IEC 17025:2005 besitzt, Prüfungen in folgenden Bereichen durchzuführen:

Funk
Mobilfunk (GSM / DCS) + OTA
Elektromagnetische Verträglichkeit (EMV)
Produktsicherheit
SAR / EMF
Umwelt
Smart Card Technology
Bluetooth®
Automotive
Wi-Fi-Services
Kanaadische Anforderungen
US-Anforderungen
Akustik
Near Field Communication (NFC)

Die Akkreditierungsurkunde gilt nur in Verbindung mit dem Bescheid vom 25.11.2016 mit der Akkreditierungsnummer D-PL-12076-01 und ist gültig bis 17.01.2018. Sie besteht aus diesem Deckblatt, der Rückseite des Deckblatts und der folgenden Anlage mit insgesamt 63 Seiten.

Registrierungsnummer der Urkunde: D-PL-12076-01-01

Frankfurt, 25.11.2016

Bitte Hinweisen auf der Rückseite

Im Auftrag Dipl.-Ing. Gerd Hoff Eigner
Abteilungsleiter

Deutsche Akkreditierungsstelle GmbH

Standort Berlin
Spittelmarkt 10
10117 Berlin

Standort Frankfurt am Main
Europa-Allee 52
60327 Frankfurt am Main

Standort Braunschweig
Bundesallee 100
38116 Braunschweig

Die auszugsweise Veröffentlichung der Akkreditierungsurkunde bedarf der vorherigen schriftlichen Zustimmung der Deutsche Akkreditierungsstelle GmbH (DAkkS). Ausgenommen davon ist die separate Weiterverbreitung des Deckblattes durch die umseitig genannte Konformitätsbewertungsstelle in unveränderter Form.

Es darf nicht der Anschein erweckt werden, dass sich die Akkreditierung auch auf Bereiche erstreckt, die über den durch die DAkkS bestätigten Akkreditierungsbereich hinausgehen.

Die Akkreditierung erfolgte gemäß des Gesetzes über die Akkreditierungsstelle (AkkStelleG) vom 31. Juli 2009 (BGBl. I S. 2625) sowie der Verordnung (EG) Nr. 765/2008 des Europäischen Parlaments und des Rates vom 9. Juli 2008 über die Vorschriften für die Akkreditierung und Marktüberwachung im Zusammenhang mit der Vermarktung von Produkten (Abtl. L 218 vom 9. Juli 2008, S. 30). Die DAkkS ist Unterzeichnerin der Multilateralen Abkommen zur gegenseitigen Anerkennung der European co-operation for Accreditation (EA), des International Accreditation Forum (IAF) und der International Laboratory Accreditation Cooperation (ILAC). Die Unterzeichner dieser Abkommen erkennen ihre Akkreditierungen gegenseitig an.

Der aktuelle Stand der Mitgliedschaft kann folgenden Webseiten entnommen werden:
EA: www.european-accrreditation.org
ILAC: www.ilac.org
IAF: www.iaf.nu

Note:
The current certificate including annex can be received on request.