

TEST REPORT

Test report no.: 1-4711_22-01-12

BNetzA-CAB-02/21-102

Testing laboratory

CTC advanced GmbH

Untertuerkheimer Strasse 6 – 10

66117 Saarbruecken / Germany

Phone: + 49 681 5 98 - 0

Fax: + 49 681 5 98 - 9075

Internet: <https://www.ctcadvanced.com>

e-mail: mail@ctcadvanced.com

Accredited Testing Laboratory:

The testing laboratory (area of testing) is accredited according to DIN EN ISO/IEC 17025 (2018-03) by the Deutsche Akkreditierungsstelle GmbH (DAkkS)

The accreditation is valid for the scope of testing procedures as stated in the accreditation certificate starting with the registration number: D-PL-12076-01.

Applicant

Ingenico

9 Avenue de la Gare Rovaltain

26958 Valence Cedex 9 / FRANCE

Phone: -/-

Contact: Nicolas Jacquemont

e-mail: nicolas.jacquemont@ingenico.com

Manufacturer

Ingenico

9 Avenue de la Gare Rovaltain

26958 Valence Cedex 9 / FRANCE

Test standard/s

FCC - Title 47 CFR Part 15 FCC - Title 47 of the Code of Federal Regulations; Chapter I; Part 15 - Radio frequency devices

RSS - 247 Issue 2 Digital Transmission Systems (DTSS), Frequency Hopping Systems (FHSs) and Licence - Exempt Local Area Network (LE-LAN) Devices

For further applied test standards please refer to section 3 of this test report.

Test Item

Kind of test item: **Payment Terminal**
Model name: **Link/2500**
FCC ID: **XKB-L25CLWIBTV2**
ISED certification number: **2586D-L25CLWIBTV2**
Frequency: 2400 MHz to 2483.5 MHz
Technology tested: IEEE 802.11 (W-LAN)
Antenna: Integrated antenna
Power supply: 3.7 V DC by rechargeable Lithium Ion battery
Temperature range: -10°C to +50°C

This test report is electronically signed and valid without handwritten signature. For verification of the electronic signatures, the public keys can be requested at the testing laboratory.

Test report authorized:

Marco Bertolino
Lab Manager
Radio Communications

Test performed:

David Lang
Lab Manager
Radio Communications

1 Table of contents

1	Table of contents	2
2	General information	4
2.1	Notes and disclaimer	4
2.2	Application details	4
2.3	Test laboratories sub-contracted	4
3	Test standard/s, references and accreditations	5
4	Reporting statements of conformity – decision rule	6
5	Test environment	7
6	Test item.....	7
6.1	General description	7
6.2	Additional information	7
7	Description of the test setup.....	8
7.1	Shielded semi anechoic chamber	9
7.2	Shielded fully anechoic chamber.....	10
7.3	Radiated measurements > 18 GHz.....	11
7.4	AC conducted	12
7.5	Conducted measurements with peak power meter & spectrum analyzer	13
8	Sequence of testing	14
8.1	Sequence of testing radiated spurious 9 kHz to 30 MHz	14
8.2	Sequence of testing radiated spurious 30 MHz to 1 GHz	15
8.3	Sequence of testing radiated spurious 1 GHz to 18 GHz	16
8.4	Sequence of testing radiated spurious above 18 GHz	17
9	Measurement uncertainty	18
10	Summary of measurement results.....	19
11	Additional information and comments	20
12	Additional EUT parameter	21
13	Measurement results.....	22
13.1	Antenna gain.....	22
13.2	Identify worst case data rate	23
13.3	Maximum output power.....	24
13.4	Duty cycle	25
13.5	Peak power spectral density	26
13.6	6 dB DTS bandwidth	27
13.7	Occupied bandwidth – 99% emission bandwidth	28
13.8	Occupied bandwidth – 20 dB bandwidth	29
13.9	Band edge compliance radiated	30
13.10	Spurious emissions conducted	34
13.11	Spurious emissions radiated below 30 MHz.....	37
13.12	Spurious emissions radiated 30 MHz to 1 GHz	44
13.13	Spurious emissions radiated above 1 GHz	48

13.14	Spurious emissions conducted below 30 MHz (AC conducted).....	56
14	Observations.....	58
15	Glossary	58
16	Document history	59
17	Accreditation Certificate – D-PL-12076-01-04	59
18	Accreditation Certificate – D-PL-12076-01-05	60

2 General information

2.1 Notes and disclaimer

The test results of this test report relate exclusively to the test item specified in this test report. CTC advanced GmbH does not assume responsibility for any conclusions and generalizations drawn from the test results with regard to other specimens or samples of the type of the equipment represented by the test item.

The test report may only be reproduced or published in full. Reproduction or publication of extracts from the report requires the prior written approval of CTC advanced GmbH.

The testing service provided by CTC advanced GmbH has been rendered under the current "General Terms and Conditions for CTC advanced GmbH".

CTC advanced GmbH will not be liable for any loss or damage resulting from false, inaccurate, inappropriate or incomplete product information provided by the customer.

Under no circumstances does the CTC advanced GmbH test report include any endorsement or warranty regarding the functionality, quality or performance of any other product or service provided.

Under no circumstances does the CTC advanced GmbH test report include or imply any product or service warranties from CTC advanced GmbH, including, without limitation, any implied warranties of merchantability, fitness for purpose, or non-infringement, all of which are expressly disclaimed by CTC advanced GmbH.

All rights and remedies regarding vendor's products and services for which CTC advanced GmbH has prepared this test report shall be provided by the party offering such products or services and not by CTC advanced GmbH. In no case this test report can be considered as a Letter of Approval.

This test report is electronically signed and valid without handwritten signature. For verification of the electronic signatures, the public keys can be requested at the testing laboratory.

2.2 Application details

Date of receipt of order:	2022-07-04
Date of receipt of test item:	2022-09-15
Start of test:*	2022-09-15
End of test:*	2022-11-15
Person(s) present during the test:	-/-

*Date of each measurement, if not shown in the plot, can be requested. Dates are stored in the measurement software.





2.3 Test laboratories sub-contracted

None

3 Test standard/s, references and accreditations

Test standard	Date	Description
FCC - Title 47 CFR Part 15	-/-	FCC - Title 47 of the Code of Federal Regulations; Chapter I; Part 15 - Radio frequency devices
RSS - 247 Issue 2	February 2017	Digital Transmission Systems (DTSs), Frequency Hopping Systems (FHSs) and Licence - Exempt Local Area Network (LE-LAN) Devices
RSS - Gen Issue 5 incl. Amendment 1 & 2	February 2021	Spectrum Management and Telecommunications Radio Standards Specification - General Requirements for Compliance of Radio Apparatus

Guidance	Version	Description
KDB 558074 D01	v05r02	GUIDANCE FOR COMPLIANCE MEASUREMENTS ON DIGITAL TRANSMISSION SYSTEM, FREQUENCY HOPPING SPREAD SPECTRUM SYSTEM, AND HYBRID SYSTEM DEVICES OPERATING UNDER SECTION 15.247 OF THE FCC RULES
ANSI C63.4-2014	-/-	American National Standard for Methods of Measurement of Radio-Noise Emissions from Low-Voltage Electrical and Electronic Equipment in the Range of 9 kHz to 40 GHz
ANSI C63.10-2013	-/-	American National Standard of Procedures for Compliance Testing of Unlicensed Wireless Devices

Accreditation	Description	
D-PL-12076-01-04	Telecommunication and EMC Canada https://www.dakks.de/as/ast/d/D-PL-12076-01-04e.pdf	  Deutsche Akkreditierungsstelle D-PL-12076-01-04
D-PL-12076-01-05	Telecommunication FCC requirements https://www.dakks.de/as/ast/d/D-PL-12076-01-05e.pdf	  Deutsche Akkreditierungsstelle D-PL-12076-01-05

ISED Testing Laboratory Recognized Listing Number: DE0001

FCC designation number: DE0002

4 Reporting statements of conformity – decision rule

Only the measured values related to their corresponding limits will be used to decide whether the equipment under test meets the requirements of the test standards listed in chapter 3.

The measurement uncertainty is mentioned in this test report, see chapter 9, but is not taken into account - neither to the limits nor to the measurement results. Measurement results with a smaller margin to the corresponding limits than the measurement uncertainty have a potential risk of more than 5% that the decision might be wrong."

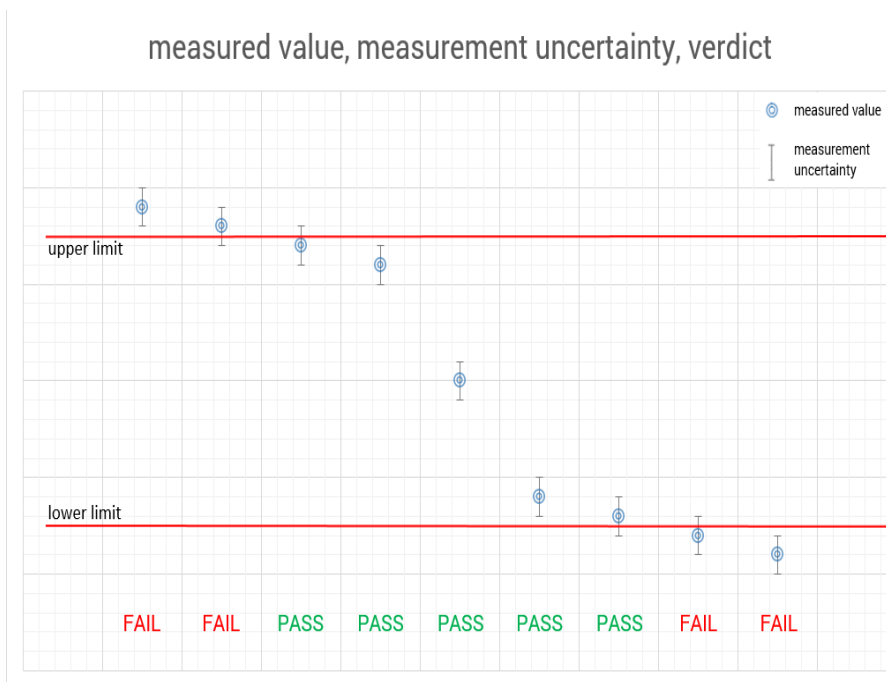

5 Test environment

Temperature	:	T_{nom} +22 °C during room temperature tests T_{max} No tests under extreme conditions required. T_{min} No tests under extreme conditions required.
Relative humidity content	:	42 %
Barometric pressure	:	1018 hpa
Power supply	:	V_{nom} 3.7 V DC by rechargeable Lithium Ion battery V_{max} No tests under extreme conditions required. V_{min} No tests under extreme conditions required.

6 Test item

6.1 General description

Kind of test item	:	Payment Terminal
Model name	:	Link/2500
HMN	:	-/-
PMN	:	Link/2500
HVIN	:	Link/2500 CL/WiFi/BT V2
FVIN	:	-/-
S/N serial number	:	Radiated unit: 221377303201293724913261 Conducted unit: 221367303091293324901471
Hardware status	:	RTS
Software status	:	039303_HTB308
Firmware status	:	039303_HTB308
Frequency band	:	2400 MHz to 2483.5 MHz
Type of radio transmission	:	DSSS, OFDM
Use of frequency spectrum	:	
Type of modulation	:	CCK, (D)BPSK, (D)QPSK, 16 – QAM, 64 – QAM
Number of channels	:	11
Antenna	:	Integrated antenna
Power supply	:	3.7 V DC by rechargeable Lithium Ion battery
Temperature range	:	-10°C to +50°C

6.2 Additional information

The content of the following annexes is defined in the QA. It may be that not all of the listed annexes are necessary for this report, thus some values in between may be missing.

Test setup and EUT photos are included in test report:

- 1-4711/22-01-01_AnnexA
- 1-4711/22-01-01_AnnexB
- 1-4711/22-01-01_AnnexD

7 Description of the test setup

Typically, the calibrations of the test apparatus are commissioned to and performed by an accredited calibration laboratory. The calibration intervals are determined in accordance with the DIN EN ISO/IEC 17025. In addition to the external calibrations, the laboratory executes comparison measurements with other calibrated test systems or effective verifications. Weekly chamber inspections and range calibrations are performed. Where possible, RF generating and signaling equipment as well as measuring receivers and analyzers are connected to an external high-precision 10 MHz reference (GPS-based or rubidium frequency standard).

In order to simplify the identification of the equipment used at some special tests, some items of test equipment and ancillaries can be provided with an identifier or number in the equipment list below (Lab/Item).

Each block diagram listed can contain several test setup configurations. All devices belonging to a test setup are identified with the same letter syntax. For example: Column Setup and all devices with an A.

Agenda: Kind of Calibration

k	calibration / calibrated	EK	limited calibration
ne	not required (k, ev, izw, zw not required)	zw	cyclical maintenance (external cyclical maintenance)
ev	periodic self verification	izw	internal cyclical maintenance
Ve	long-term stability recognized	g	blocked for accredited testing
vlk!	Attention: extended calibration interval		
NK!	Attention: not calibrated	*)	next calibration ordered / currently in progress

7.1 Shielded semi anechoic chamber

The radiated measurements are performed in vertical and horizontal plane in the frequency range from 30 MHz to 1 GHz in semi-anechoic chambers. The EUT is positioned on a non-conductive support with a height of 0.80 m above a conductive ground plane that covers the whole chamber. The receiving antennas are conform to specifications ANSI C63. These antennas can be moved over the height range between 1.0 m and 4.0 m in order to search for maximum field strength emitted from EUT. The measurement distances between EUT and receiving antennas are indicated in the test setups for the various frequency ranges. For each measurement, the EUT is rotated in all three axes until the maximum field strength is received. The wanted and unwanted emissions are received by spectrum analyzers where the detector modes and resolution bandwidths over various frequency ranges are set according to requirement ANSI C63.

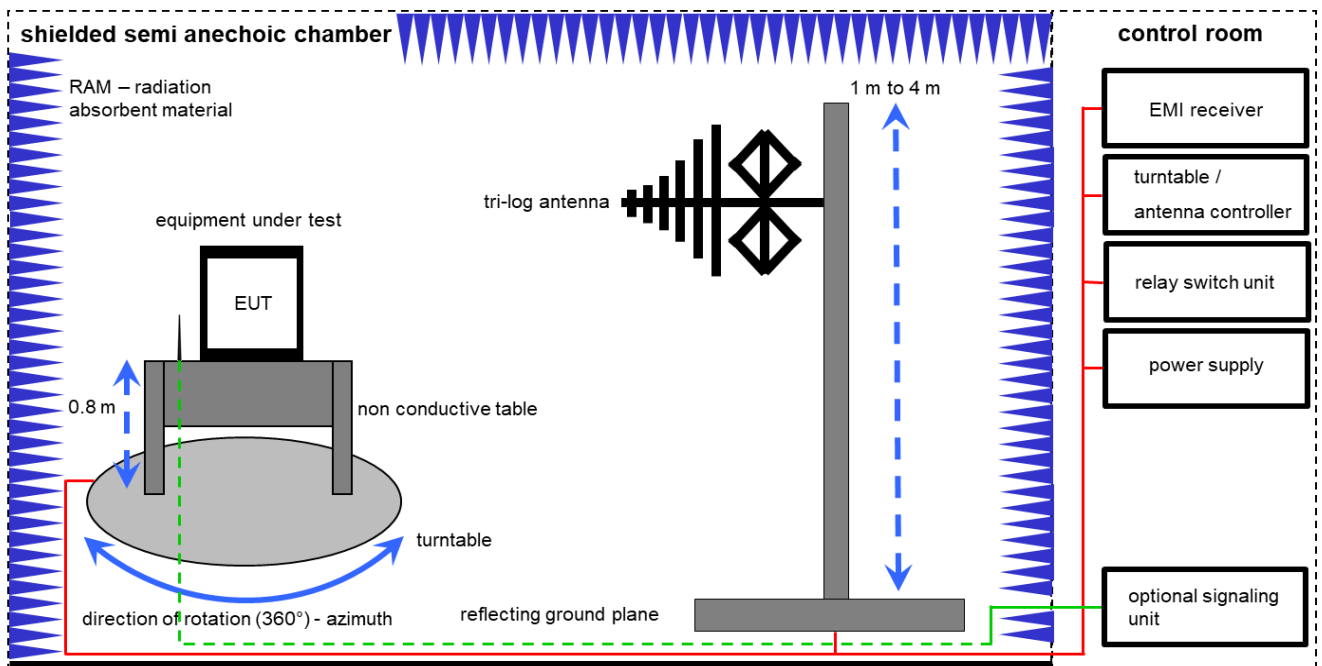

Measurement distance: tri-log antenna 10 meter; EMC32 software version: 10.59.00

$$FS = UR + CL + AF$$

(FS-field strength; UR-voltage at the receiver; CL-loss of the cable; AF-antenna factor)

Example calculation:

$$FS [dB\mu V/m] = 12.35 [dB\mu V/m] + 1.90 [dB] + 16.80 [dB/m] = 31.05 [dB\mu V/m] (35.69 \mu V/m)$$

Equipment table:

No.	Setup	Equipment	Type	Manufacturer	Serial No.	INV. No.	Kind of Calibration	Last Calibration	Next Calibration
1	A	Switch-Unit	3488A	HP	2719A14505	300000368	ev	-/-	-/-
2	A	Semi anechoic chamber	3000023	MWB AG	-/-	300000551	ne	-/-	-/-
3	A	Antenna Tower	Model 2175	ETS-Lindgren	64762	300003745	izw	-/-	-/-
4	A	Positioning Controller	Model 2090	ETS-Lindgren	64672	300003746	izw	-/-	-/-
5	A	Turntable Interface-Box	Model 105637	ETS-Lindgren	44583	300003747	izw	-/-	-/-
6	A	TRILOG Broadband Test-Antenna 30 MHz - 3 GHz	VULB9163	Schwarzbeck Mess - Elektronik	318	300003696	vKI!	30.09.2021	29.09.2023
7	A	Turntable	2089-4.0	EMCO	-/-	300004394	ne	-/-	-/-
8	A	PC	TecLine	F+W	-/-	300004388	ne	-/-	-/-
9	A	EMI Test Receiver	ESR3	Rohde & Schwarz	102587	300005771	k	20.05.2022	19.05.2023

7.2 Shielded fully anechoic chamber

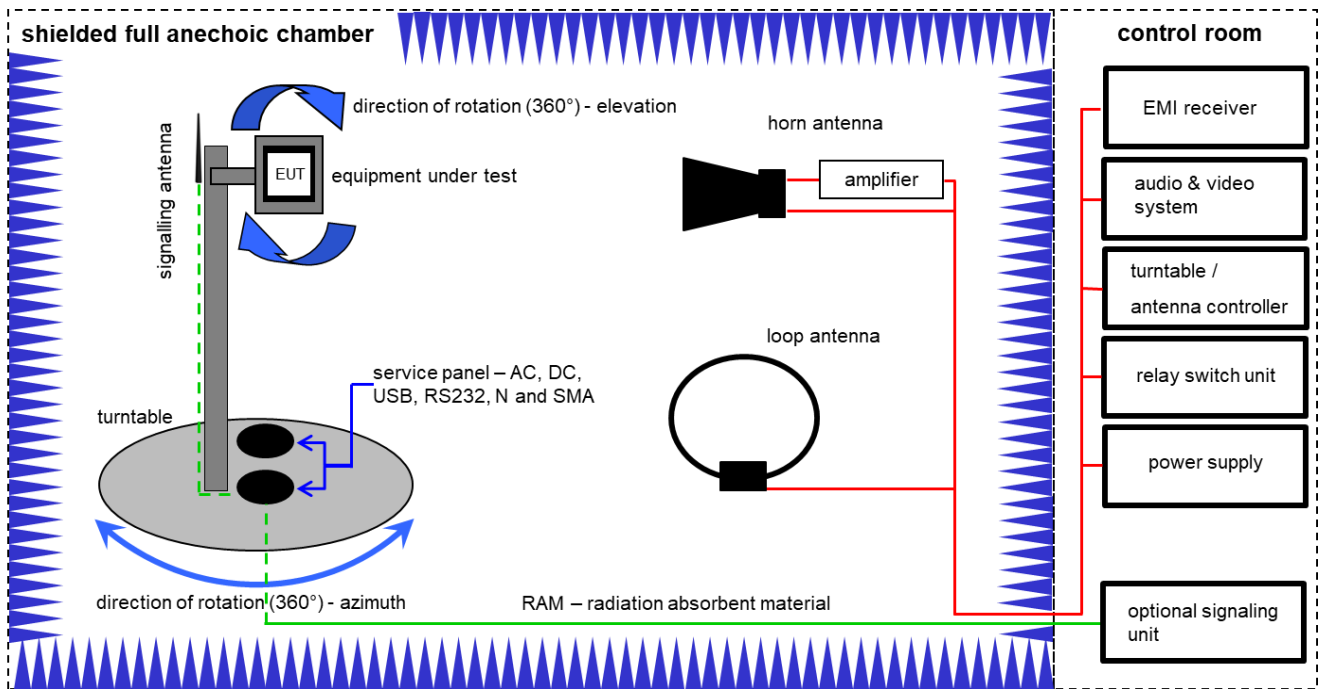

Measurement distance: horn antenna 3 meter; loop antenna 3 meter / 1 meter

$$FS = UR + CA + AF$$

(FS-field strength; UR-voltage at the receiver; CA-loss of the signal path; AF-antenna factor)

Example calculation:

$$FS \text{ [dB}\mu\text{V/m]} = 40.0 \text{ [dB}\mu\text{V/m]} + (-35.8) \text{ [dB]} + 32.9 \text{ [dB/m]} = 37.1 \text{ [dB}\mu\text{V/m]} \text{ (71.61 } \mu\text{V/m)}$$

Equipment table:

No.	Setup	Equipment	Type	Manufacturer	Serial No.	INV. No.	Kind of Calibration	Last Calibration	Next Calibration
1	A	Active Loop Antenna 9 kHz to 30 MHz	6502	EMCO	2210	300001015	vKI!	01.07.2021	31.07.2023
2	B, C	Highpass Filter	WHK1.1/15G-10SS	Wainwright	37	400000148	ne	-/-	-/-
3	B, C	Highpass Filter	WHKX7.0/18G-8SS	Wainwright	18	300003789	ne	-/-	-/-
4	C	Band Reject Filter	WRCG2400/2483-2375/2505-50/10SS	Wainwright	26	300003792	ne	-/-	-/-
5	B, C	Broadband Amplifier 0.5-18 GHz	CBLU5184540	CERNEX	22051	300004483	ev	-/-	-/-
6	A, B, C	4U RF Switch Platform	L4491A	Agilent Technologies	MY50000032	300004510	ne	-/-	-/-
7	A, B, C	Computer	Intel Core i3 3220/3,3 GHz, Prozessor	-/-	2V2403033A54 21	300004591	ne	-/-	-/-
8	A, B, C	NEXIO EMV-Software	BAT EMC V3.21.0.32	EMCO	-/-	300004682	ne	-/-	-/-
9	A, B, C	Anechoic chamber	-/-	TDK	-/-	300003726	ne	-/-	-/-
10	A, B, C	EMI Test Receiver 9kHz-26,5GHz	ESR26	Rohde & Schwarz	101376	300005063	k	15.12.2021	31.12.2022
11	C	RF-Amplifier	AMF-6F06001800-30-10P-R	NARDA-MITEQ Inc	2011571	300005240	ev	-/-	-/-

7.3 Radiated measurements > 18 GHz

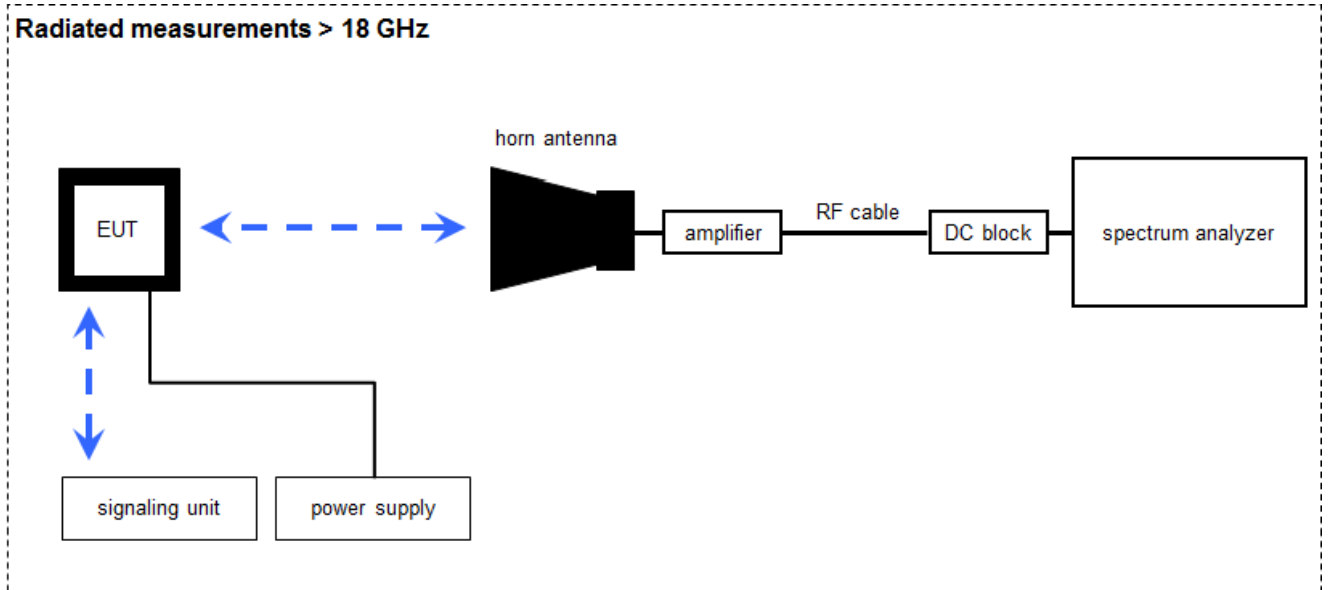

Measurement distance: horn antenna 50 cm

$$FS = UR + CA + AF$$

(FS-field strength; UR-voltage at the receiver; CA-loss signal path & distance correction; AF-antenna factor)

Example calculation:

$$FS [dB\mu V/m] = 40.0 [dB\mu V/m] + (-60.1) [dB] + 36.74 [dB/m] = 16.64 [dB\mu V/m] (6.79 \mu V/m)$$

Equipment table:

No.	Setup	Equipment	Type	Manufacturer	Serial No.	INV. No.	Kind of Calibration	Last Calibration	Next Calibration
1	A	Std. Gain Horn Antenna 18.0-26.5 GHz	638	Narda	8205	300002442	k	17.01.2022	31.01.2024
2	A	Amplifier 2-40 GHz	JS32-02004000-57-5P	MITEQ	1777200	300004541	ev	-/-	-/-
3	A	RF-Cable	ST18/SMAM/SMAM/48	Huber & Suhner	Batch no. 127377	400001183	ev	-/-	-/-
4	A	DC-Blocker 0.1-40 GHz	8141A	Inmet	-/-	400001185	ev	-/-	-/-
5	A	Signal- and Spectrum Analyzer 2 Hz - 50 GHz	FSW50	Rohde&Schwarz	101560	300006179	k	07.03.2022	31.03.2023

7.4 AC conducted

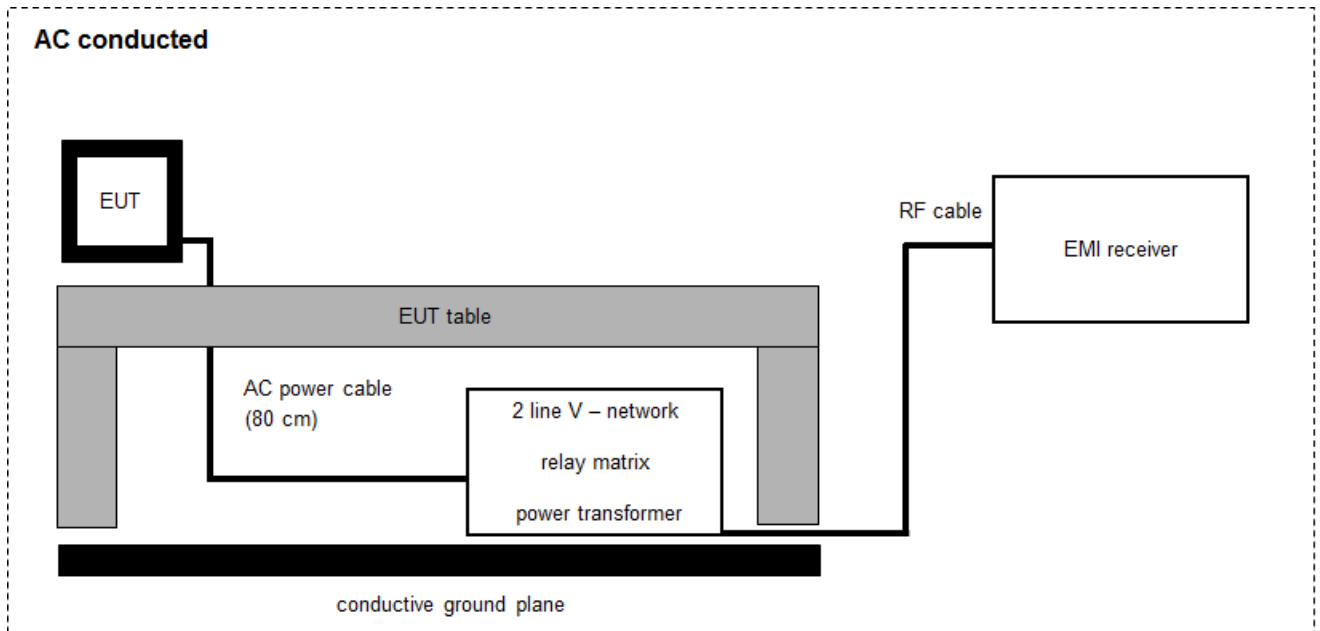

$$FS = UR + CF + VC$$

(FS-field strength; UR-voltage at the receiver; CR-loss of the cable and filter; VC-correction factor of the ISN)

Example calculation:

$$FS [dB\mu V/m] = 37.62 [dB\mu V/m] + 9.90 [dB] + 0.23 [dB] = 47.75 [dB\mu V/m] (244.06 \mu V/m)$$

Equipment table:

No.	Setup	Equipment	Type	Manufacturer	Serial No.	INV. No.	Kind of Calibration	Last Calibration	Next Calibration
1	A	Spektrum Monitor	EZM	Rohde & Schwarz	883086/026	300001469	NK!	-/-	-/-
2	A	Two-line V-Network (LISN) 9 kHz to 30 MHz	ESH3-Z5	Rohde & Schwarz	892475/017	300002209	vIK!	14.12.2021	31.12.2023
3	A	RF-Filter-section	85420E	HP	3427A00162	300002214	NK!	-/-	-/-
4	A	EMI Test Receiver	ESCI 3	R&S	100083	300003312	k	09.12.2021	31.12.2022
5	A	Analyzer-Reference-System (Harmonics and Flicker)	ARS 16/1	SPS	A3509 07/0 0205	300003314	vIK!	29.12.2021	31.12.2023
6	A	Hochpass 150 kHz	EZ-25	R&S	100010	300003798	ev	-/-	-/-
7	A	PC	TeLine	F+W	-/-	300003532	ne	-/-	-/-

7.5 Conducted measurements with peak power meter & spectrum analyzer

Conducted measurements normal conditions

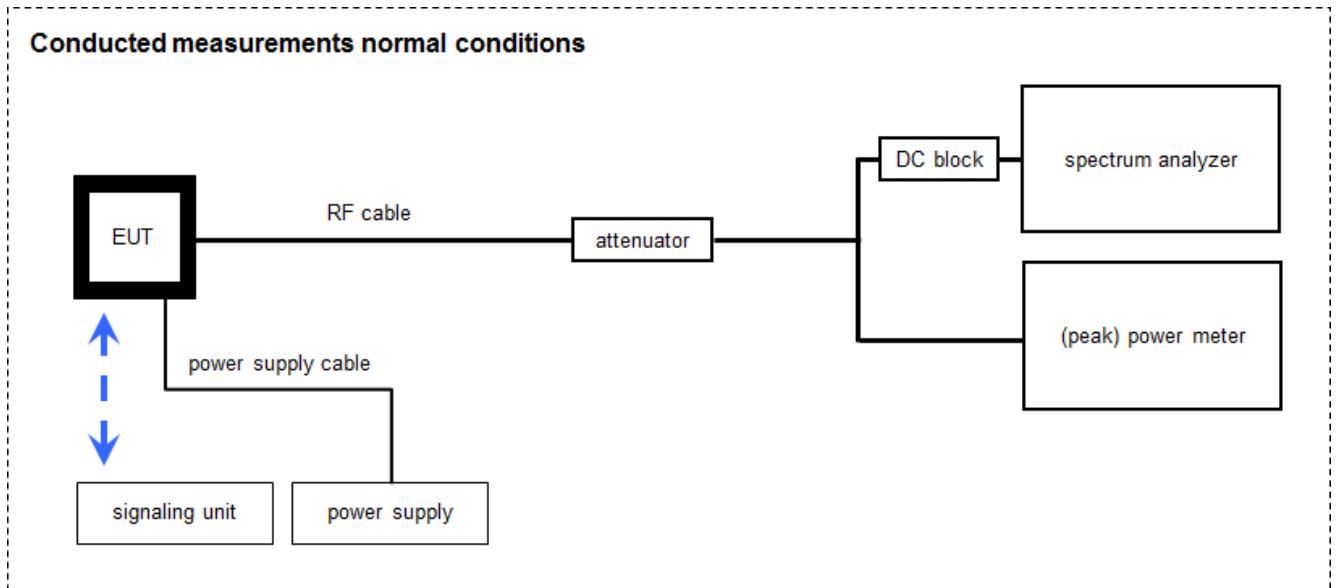

WLAN tester version: 1.1.13; LabView2015

OP = AV + CA
(OP-output power; AV-analyzer value; CA-loss signal path)

Example calculation:

OP [dBm] = 6.0 [dBm] + 11.7 [dB] = 17.7 [dBm] (58.88 mW)

Equipment table:

No.	Setup	Equipment	Type	Manufacturer	Serial No.	INV. No.	Kind of Calibration	Last Calibration	Next Calibration
1	A, B	PC Tester R005	Intel Core i3 3220/3,3 GHz, Prozessor	-/-	2V2403033A45 23	300004589	ne	-/-	-/-
2	A, B	RF-Cable	ST18/SMAm/SMAm /60	Huber & Suhner	Batch no. 606844	400001181	ev	-/-	-/-
3	A, B	DC-Blocker 0.1-40 GHz	8141A	Inmet	-/-	400001185	ev	-/-	-/-
4	A, B	Coax Attenuator 10 dB 2W 0-40 GHz	MCL BW-K10-2W44+	Mini Circuits	-/-	400001186	ev	-/-	-/-
5	A, B	Tester Software RadioStar (C.BER2 for BT Conformance)	Version 1.0.0.X	CTC advanced GmbH	0001	400001380	ne	-/-	-/-
6	B	USB Wideband Power Sensor (50MHz - 18GHz)	U2021XA	Keysight	MY591900010	300005802	k	14.12.2021	31.12.2022
7	A	Signal analyzer	FSV40	Rohde&Schwarz	101042	300004517	k	25.01.2022	31.01.2023

8 Sequence of testing

8.1 Sequence of testing radiated spurious 9 kHz to 30 MHz

Setup

- The equipment is set up to simulate normal operation mode as described in the user manual or defined by the manufacturer.
- If the EUT is a tabletop system, it is placed on a table with 0.8 m height.
- If the EUT is a floor standing device, it is placed directly on the turn table.
- Auxiliary equipment and cables are positioned to simulate normal operation conditions as described in ANSI C 63.4.
- The AC power port of the EUT (if available) is connected to a power outlet below the turntable.
- Measurement distance is 3 m (see ANSI C 63.4) – see test details.
- EUT is set into operation.

Premeasurement*

- The turntable rotates from 0° to 315° using 45° steps.
- The antenna height is 1 m.
- At each turntable position the analyzer sweeps with positive-peak detector to find the maximum of all emissions.

Final measurement

- Identified emissions during the pre-measurement are maximized by the software by rotating the turntable from 0° to 360°.
- Loop antenna is rotated about its vertical axis for maximum response at each azimuth about the EUT. (For certain applications, the loop antenna plane may also need to be positioned horizontally at the specified distance from the EUT)
- The final measurement is done in the position (turntable and elevation) causing the highest emissions with quasi-peak (as described in ANSI C 63.4).
- Final levels, frequency, measuring time, bandwidth, turntable position, correction factor, margin to the limit and limit will be recorded. A plot with the graph of the premeasurement and the limit is stored.

*Note: The sequence will be repeated three times with different EUT orientations.

8.2 Sequence of testing radiated spurious 30 MHz to 1 GHz

Setup

- The equipment is set up to simulate normal operation mode as described in the user manual or defined by the manufacturer.
- If the EUT is a tabletop system, a table with 0.8 m height is used, which is placed on the ground plane.
- If the EUT is a floor standing device, it is placed on the ground plane with insulation between both.
- Auxiliary equipment and cables are positioned to simulate normal operation conditions as described in ANSI C 63.4.
- The AC power port of the EUT (if available) is connected to a power outlet below the turntable.
- Measurement distance is 10 m or 3 m (see ANSI C 63.4) – see test details.
- EUT is set into operation.

Premeasurement

- The turntable rotates from 0° to 315° using 45° steps.
- The antenna is polarized vertical and horizontal.
- The antenna height changes from 1 m to 3 m.
- At each turntable position, antenna polarization and height the analyzer sweeps three times in peak to find the maximum of all emissions.

Final measurement

- The final measurement is performed for at least six highest peaks according to the requirements of the ANSI C63.4.
- Based on antenna and turntable positions at which the peak values are measured the software maximize the peaks by changing turntable position $\pm 45^\circ$ and antenna height between 1 and 4 m.
- The final measurement is done with quasi-peak detector (as described in ANSI C 63.4).
- Final levels, frequency, measuring time, bandwidth, antenna height, antenna polarization, turntable angle, correction factor, margin to the limit and limit are recorded. A plot with the graph of the premeasurement with marked maximum final results and the limit is stored.

8.3 Sequence of testing radiated spurious 1 GHz to 18 GHz

Setup

- The equipment is set up to simulate normal operation mode as described in the user manual or defined by the manufacturer.
- If the EUT is a tabletop system, a 2-axis positioner with 1.5 m height is used.
- If the EUT is a floor standing device, it is placed directly on the turn table.
- Auxiliary equipment and cables are positioned to simulate normal operation conditions as described in ANSI C 63.4.
- The AC power port of the EUT (if available) is connected to a power outlet below the turntable.
- Measurement distance is 3 m (see ANSI C 63.4) – see test details.
- EUT is set into operation.

Premeasurement

- The turntable rotates from 0° to 315° using 45° steps.
- The antenna is polarized vertical and horizontal.
- The antenna height is 1.5 m.
- At each turntable position and antenna polarization the analyzer sweeps with positive peak detector to find the maximum of all emissions.

Final measurement

- The final measurement is performed for at least six highest peaks according to the requirements of the ANSI C63.4.
- Based on antenna and turntable positions at which the peak values are measured the software maximizes the peaks by rotating the turntable from 0° to 360°. This measurement is repeated for different EUT-table positions (0° to 150° in 30°-steps) and for both antenna polarizations.
- The final measurement is done in the position (turntable, EUT-table and antenna polarization) causing the highest emissions with Peak and RMS detector (as described in ANSI C 63.4).
- Final levels, frequency, measuring time, bandwidth, turntable position, EUT-table position, antenna polarization, correction factor, margin to the limit and limit are recorded. A plot with the graph of the premeasurement with marked maximum final results and the limit is stored.

8.4 Sequence of testing radiated spurious above 18 GHz

Setup

- The equipment is set up to simulate normal operation mode as described in the user manual or defined by the manufacturer.
- Auxiliary equipment and cables are positioned to simulate normal operation conditions as described in ANSI C 63.4.
- The AC power port of the EUT (if available) is connected to a power outlet.
- The measurement distance is as appropriate (e.g. 0.5 m).
- The EUT is set into operation.

Premeasurement

- The test antenna is handheld and moved carefully over the EUT to cover the EUT's whole sphere and different polarizations of the antenna.

Final measurement

- The final measurement is performed at the position and antenna orientation causing the highest emissions with Peak and RMS detector (as described in ANSI C 63.4).
- Final levels, frequency, measuring time, bandwidth, correction factor, margin to the limit and limit are recorded. A plot with the graph of the premeasurement and the limit is stored.

9 Measurement uncertainty

Measurement uncertainty		
Test case	Uncertainty	
Antenna gain	± 3 dB	
Power spectral density	± 1.56 dB	
DTS bandwidth	± 100 kHz (depends on the used RBW)	
Occupied bandwidth	± 100 kHz (depends on the used RBW)	
Maximum output power conducted	± 1.56 dB	
Detailed spurious emissions @ the band edge - conducted	± 1.56 dB	
Band edge compliance radiated	± 3 dB	
Spurious emissions conducted	> 3.6 GHz	± 1.56 dB
	> 7 GHz	± 1.56 dB
	> 18 GHz	± 2.31 dB
	≥ 40 GHz	± 2.97 dB
Spurious emissions radiated below 30 MHz	± 3 dB	
Spurious emissions radiated 30 MHz to 1 GHz	± 3 dB	
Spurious emissions radiated 1 GHz to 12.75 GHz	± 3.7 dB	
Spurious emissions radiated above 12.75 GHz	± 4.5 dB	
Spurious emissions conducted below 30 MHz (AC conducted)	± 2.6 dB	

10 Summary of measurement results

<input checked="" type="checkbox"/>	No deviations from the technical specifications were ascertained
<input type="checkbox"/>	There were deviations from the technical specifications ascertained
<input type="checkbox"/>	This test report is only a partial test report. The content and verdict of the performed test cases are listed below.

TC Identifier	Description	Verdict	Date	Remark
RF-Testing	CFR Part 15 RSS - 247, Issue 2	See table!	2022-11-16	-/-

Test specification clause	Test case	Guideline	Temperature & voltage conditions	C	NC	NA	NP	Remark
§15.247(b)(4) RSS - 247 / 5.4 (f)(ii)	Antenna gain	-/-	Nominal	-/-				-/-
§15.35	Duty cycle	-/-	Nominal	-/-				-/-
§15.247(e) RSS - 247 / 5.2 (b)	Power spectral density	KDB 558074 DTS clause: 8.4	Nominal	<input checked="" type="checkbox"/>	<input type="checkbox"/>	<input type="checkbox"/>	<input type="checkbox"/>	-/-
§15.247(a)(2) RSS - 247 / 5.2 (a)	DTS bandwidth	KDB 558074 DTS clause: 8.2	Nominal	<input checked="" type="checkbox"/>	<input type="checkbox"/>	<input type="checkbox"/>	<input type="checkbox"/>	-/-
RSS Gen clause 4.6.1	Occupied bandwidth	-/-	Nominal	<input checked="" type="checkbox"/>	<input type="checkbox"/>	<input type="checkbox"/>	<input type="checkbox"/>	-/-
§15.247(b)(3) RSS - 247 / 5.4 (d)	Maximum output power	KDB 558074 DTS clause: 8.3.1.3	Nominal	<input checked="" type="checkbox"/>	<input type="checkbox"/>	<input type="checkbox"/>	<input type="checkbox"/>	-/-
§15.247(d) RSS - 247 / 5.5	Detailed spurious emissions @ the band edge – cond.	-/-	Nominal	<input checked="" type="checkbox"/>	<input type="checkbox"/>	<input type="checkbox"/>	<input type="checkbox"/>	-/-
§15.205 RSS - 247 / 5.5 RSS - Gen	Band edge compliance cond. or rad.	KDB 558074 DTS clause: 8.7.3	Nominal	<input checked="" type="checkbox"/>	<input type="checkbox"/>	<input type="checkbox"/>	<input type="checkbox"/>	-/-
§15.247(d) RSS - 247 / 5.5	TX spurious emissions cond.	KDB 558074 DTS clause: 8.5	Nominal	<input checked="" type="checkbox"/>	<input type="checkbox"/>	<input type="checkbox"/>	<input type="checkbox"/>	-/-
§15.209(a) RSS-Gen	TX spurious emissions rad. below 30 MHz	-/-	Nominal	<input checked="" type="checkbox"/>	<input type="checkbox"/>	<input type="checkbox"/>	<input type="checkbox"/>	-/-
§15.247(d) RSS - 247 / 5.5 RSS-Gen	TX spurious emissions rad. 30 MHz to 1 GHz	-/-	Nominal	<input checked="" type="checkbox"/>	<input type="checkbox"/>	<input type="checkbox"/>	<input type="checkbox"/>	-/-
§15.247(d) RSS - 247 / 5.5 RSS-Gen	TX spurious emissions rad. above 1 GHz	-/-	Nominal	<input checked="" type="checkbox"/>	<input type="checkbox"/>	<input type="checkbox"/>	<input type="checkbox"/>	-/-
§15.107(a) §15.207	Conducted emissions < 30 MHz	-/-	Nominal	<input checked="" type="checkbox"/>	<input type="checkbox"/>	<input type="checkbox"/>	<input type="checkbox"/>	-/-

Notes:

C	Compliant	NC	Not compliant	NA	Not applicable	NP	Not performed
----------	-----------	-----------	---------------	-----------	----------------	-----------	---------------

11 Additional information and comments

Reference documents: Radio Wifi agreement procedure.pdf

Co-applicable documents: 1-4711_22-01-12_log1_conducted.pdf

Special test descriptions: None

Configuration descriptions: Operating mode vs. data rate vs. power setting:

Test mode:	Data rate:	Power setting:
b-mode	1Mbit/s	CH1=18 CH6 = 11 CH11=14
g-mode	6Mbit/s	16
nHT20-mode	MCS0	15
nHT40-mode	MCS0	13

- EUT selection:
- Only one device available
 - Devices selected by the customer
 - Devices selected by the laboratory (Randomly)

Provided channels:

Channels with 20 MHz channel bandwidth:

channel number & center frequency													
channel	1	2	3	4	5	6	7	8	9	10	11	12	13
f _c / MHz	2412	2417	2422	2427	2432	2437	2442	2447	2452	2457	2462	2467	2472

Channels with 40 MHz channel bandwidth:

channel number & center frequency													
channel	-/-	-/-	3	4	5	6	7	8	9	10	11	-/-	-/-
f _c / MHz	-/-	-/-	2422	2427	2432	2437	2442	2447	2452	2457	2462	-/-	-/-

Note: The channels used for the tests are marked in bold in the list.

12 Additional EUT parameter

- Test mode:
- No test mode available
Iperf was used to ping another device with the largest support packet size
 - Test mode available
Special software is used.
EUT is transmitting pseudo random data by itself
- Modulation types:
- Wide Band Modulation (None Hopping – e.g. DSSS, OFDM)
 - Frequency Hopping Spread Spectrum (FHSS)
- Antennas and transmit operating modes:
- Operating mode 1 (single antenna)
 - *Equipment with 1 antenna,*
 - *Equipment with 2 diversity antennas operating in switched diversity mode by which at any moment in time only 1 antenna is used,*
 - *Smart antenna system with 2 or more transmit/receive chains, but operating in a mode where only 1 transmit/receive chain is used)*
 - Operating mode 2 (multiple antennas, no beamforming)
 - *Equipment operating in this mode contains a smart antenna system using two or more transmit/receive chains simultaneously but without beamforming.*
 - Operating mode 3 (multiple antennas, with beamforming)
 - *Equipment operating in this mode contains a smart antenna system using two or more transmit/receive chains simultaneously with beamforming.
In addition to the antenna assembly gain (G), the beamforming gain (Y) may have to be taken into account when performing the measurements.*

13 Measurement results

13.1 Antenna gain

Description:

The antenna gain of the complete system is calculated by the difference of radiated power (@ 3 MHz) in EIRP and the conducted power (@ 3 MHz) of the module.

Measurement:

Measurement parameter	
Detector	Peak
Sweep time	Auto
Resolution bandwidth	3 MHz
Video bandwidth	3 MHz / 10 MHz
Trace mode	Max hold
Test setup	See chapter 7.2 setup B (radiated)
Measurement uncertainty	See chapter 9

Measurement parameters (conducted)	
External result file(s)	1-4711_22-01-12_log1_conducted.pdf
Test setup	See chapter 7.5 setup A
Measurement uncertainty	See chapter 9

Limits:

FCC	ISED
6 dBi / > 6 dBi output power and power density reduction required	

Results:

T _{nom}	V _{nom}	Lowest channel	Middle channel	Highest channel
Conducted power [dBm] Measured, DSSS modulation		18.8	12.7	13.8
Radiated power [dBm] Measured, DSSS modulation		16.6	16.7	16.4
Gain [dBi] Calculated		-2.2	4.0	2.6

13.2 Identify worst case data rate

Worst case data rates declared by the manufacturer (see section 11).

13.3 Maximum output power

Description:

Measurement of the maximum conducted peak output power. The measurements are performed using the data rate identified in the previous chapter.

Measurement:

Measurement parameter	
According to DTS clause: 8.3.1.3	
Peak power meter	
External result file(s)	1-4711_22-01-12_log1_conducted.pdf
Test setup	See chapter 7.5 setup B
Measurement uncertainty	See chapter 9

Limits:

FCC	ISED
Conducted 1.0 W / 30 dBm with an antenna gain of max. 6 dBi	

Results:

	maximum output power / dBm		
	lowest channel	middle channel	highest channel
Output power conducted DSSS / b – mode	22.6	16.7	17.8
Output power conducted OFDM / g – mode	26.6	26.6	24.6
Output power conducted OFDM / n HT20 – mode	23.0	25.1	24.2
Output power conducted OFDM / n HT40 – mode	19.8	22.7	19.7

13.4 Duty cycle

Description:

Measurement of the timing behavior.

Measurement:

Measurement parameter	
Detector	Peak
Sweep time	Depends on the signal see plot
Resolution bandwidth	10 MHz
Video bandwidth	10 MHz
Trace mode	Max hold
External result file(s)	1-4711_22-01-12_log1_conducted.pdf
Test setup	See chapter 7.5 setup A
Measurement uncertainty	See chapter 9

Limits:

FCC	ISED
No limitation!	

Results:

T _{nom}	V _{nom}	lowest channel	middle channel	highest channel
DSSS / b – mode		100 % / 0.0 dB	100 % / 0.0 dB	100 % / 0.0 dB
OFDM / g – mode		100 % / 0.0 dB	100 % / 0.0 dB	100 % / 0.0 dB
OFDM / n HT20 – mode		100 % / 0.0 dB	100 % / 0.0 dB	100 % / 0.0 dB
OFDM / n HT40 – mode		100 % / 0.0 dB	100 % / 0.0 dB	100 % / 0.0 dB

13.5 Peak power spectral density

Description:

Measurement of the peak power spectral density of a digital modulated system. The PSD shows the strength of the variations as a function of the frequency.

Measurement:

Measurement parameter	
According to DTS clause: 8.4	
Detector	Positive Peak
Sweep time	Auto
Resolution bandwidth	100 kHz
Video bandwidth	300 kHz
Span	30 MHz
Trace mode	Max. hold (allow trace to fully stabilize)
External result file(s)	1-4711_22-01-12_log1_conducted.pdf
Test setup	See chapter 7.5 setup A
Measurement uncertainty	See chapter 9

Limits:

FCC	ISED
8 dBm / 3 kHz (conducted)	

Results:

measured	peak power spectral density / dBm @ 3 kHz		
	Lowest channel	Middle channel	Highest channel
DSSS / b – mode	-9.6	-16.1	-14.9
OFDM / g – mode	-13.7	-11.7	-13.6
OFDM / n HT20 – mode	-14.8	-12.4	-13.4
OFDM / n HT40 – mode	-18.4	-16.2	-19.4

13.6 6 dB DTS bandwidth

Description:

Measurement of the 6 dB bandwidth of the modulated signal.

Measurement:

Measurement parameter	
According to DTS clause: 8.2	
Detector	Peak
Sweep time	Auto
Resolution bandwidth	100 kHz
Video bandwidth	500 kHz
Span	30 MHz / 50 MHz
Trace mode	Single count with 200 counts
External result file(s)	1-4711_22-01-12_log1_conducted.pdf
Test setup	See chapter 7.5 setup A
Measurement uncertainty	See chapter 9

Limits:

FCC	ISED
Systems using digital modulation techniques may operate in the 2400–2483.5 MHz band. The minimum 6 dB bandwidth shall be at least 500 kHz.	

Results:

	6 dB DTS bandwidth / kHz		
	lowest channel	middle channel	highest channel
DSSS / b – mode	9108	9120	9112
OFDM / g – mode	16568	16580	16580
OFDM / n HT20 – mode	17708	17704	17708
OFDM / n HT40 – mode	36384	36384	36432

13.7 Occupied bandwidth – 99% emission bandwidth

Description:

Measurement of the 99% bandwidth of the modulated signal acc. RSS-GEN.

Measurement:

Measurement parameter	
Detector	Peak
Sweep time	Auto
Resolution bandwidth	300 kHz
Video bandwidth	1 MHz
Span	30 MHz / 50 MHz
Measurement procedure	Measurement of the 99% bandwidth using the integration function of the analyzer
Trace mode	Single count with 200 counts
External result file(s)	1-4711_22-01-12_log1_conducted.pdf
Test setup	See chapter 7.5 setup A
Measurement uncertainty	See chapter 9

Usage:

-/-	ISED
OBW is necessary for Emission Designator	

Results:

	99% emission bandwidth / kHz		
	lowest channel	middle channel	highest channel
DSSS / b – mode	11939	11991	11975
OFDM / g – mode	17214	17210	17218
OFDM / n HT20 – mode	17902	17906	17914
OFDM / n HT40 – mode	36500	36492	36500

13.8 Occupied bandwidth – 20 dB bandwidth

Description:

Measurement of the 20 dB bandwidth of the modulated carrier.

Measurement:

Measurement parameter	
Detector	Peak
Sweep time	Auto
Resolution bandwidth	100 kHz
Video bandwidth	500 kHz
Span	30 MHz / 50 MHz
Trace mode	Single count with min. 200 counts
External result file(s)	1-4711_22-01-12_log1_conducted.pdf
Test setup	See chapter 7.5 setup A
Measurement uncertainty	See chapter 9

Usage:

-/-	ISED
The complete bandwidth has to be within the frequency range of the band.	

Results:

	20 dB bandwidth / MHz		
	lowest channel	middle channel	highest channel
DSSS / b – mode	13.6	13.7	13.7
OFDM / g – mode	19.3	19.3	19.3
OFDM / n HT20 – mode	17.9	19.8	19.8
OFDM / n HT40 – mode	40.1	40.2	40.1

13.9 Band edge compliance radiated

Description:

Measurement of the radiated band edge compliance. The EUT is turned in the position that results in the maximum level at the band edge. Then a sweep over the corresponding restricted band is performed. The EUT is set to the lowest channel for the lower restricted band and to the highest channel for the upper restricted band. Measurement distance is 3 meter.

Measurement:

	Measurement parameter for peak measurements	Measurement parameter for average measurements
		According to DTS clause: 8.7.3
Detector	Peak	RMS
Sweep time	Auto	Auto
Resolution bandwidth	1 MHz	100 kHz
Video bandwidth	1 MHz	300 kHz
Span	See plot	2 MHz
Trace mode	Max. hold	RMS Average over 101 sweeps
Analyzer function	-/-	Band power function (Compute the power by integrating the spectrum over 1 MHz)
Test setup	See chapter 7.2 setup B	
Measurement uncertainty	See chapter 9	

Limits:

FCC	ISED
74 dB μ V/m @ 3 m (Peak) 54 dB μ V/m @ 3 m (AVG)	

Results:

band edge compliance radiated / (dB μ V / m) @ 3 m			
	DSSS	OFDM (20 MHz nominal channel bandwidth)	OFDM (40 MHz nominal channel bandwidth)
Lower band edge	51.6 Peak 40.0 RMS	55.5 Peak 42.0 RMS	52.5 Peak 39.4 RMS
Upper band edge	49.3 Peak 38.1 RMS	57.6 Peak 43.0 RMS	53.7 Peak 42.9 RMS

Plots: DSSS - peak / average

Plot 1: TX mode, lower band edge, vertical & horizontal polarization

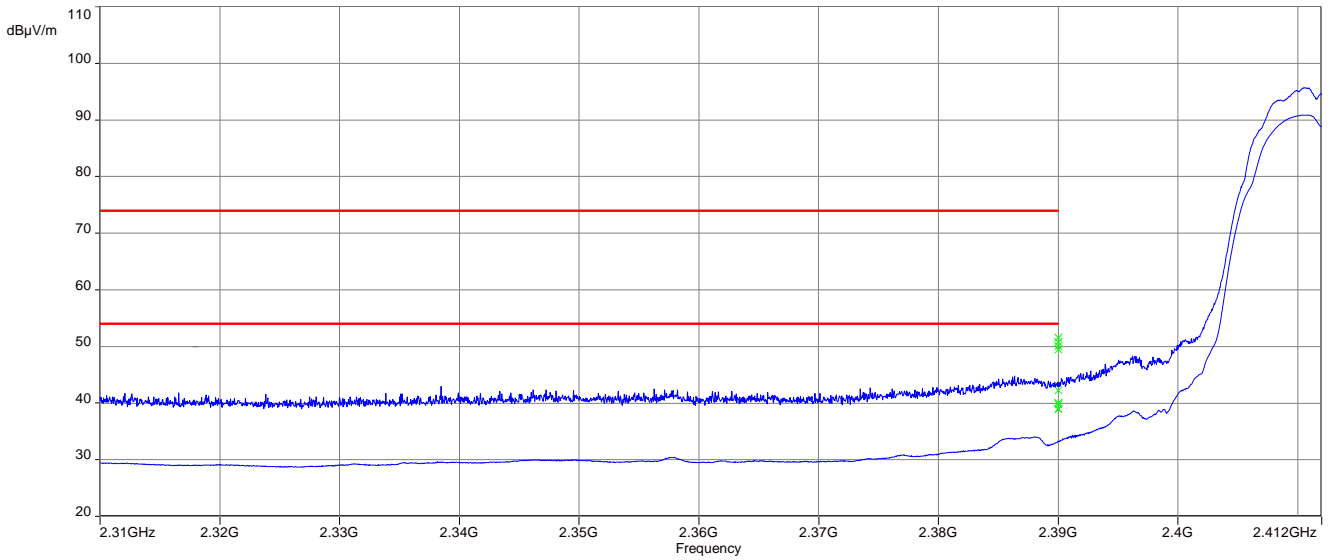

Plot 2: TX mode, upper band edge, vertical & horizontal polarization

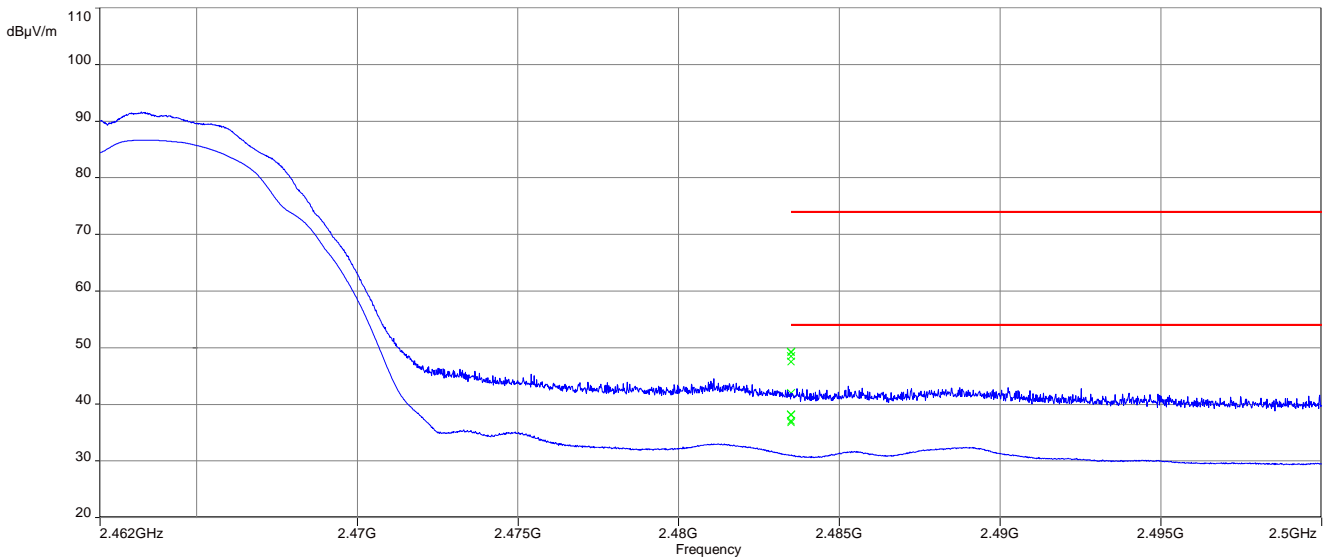

Plots: OFDM (20 MHz bandwidth) - peak / average

Plot 1: TX mode, lower band edge, vertical & horizontal polarization

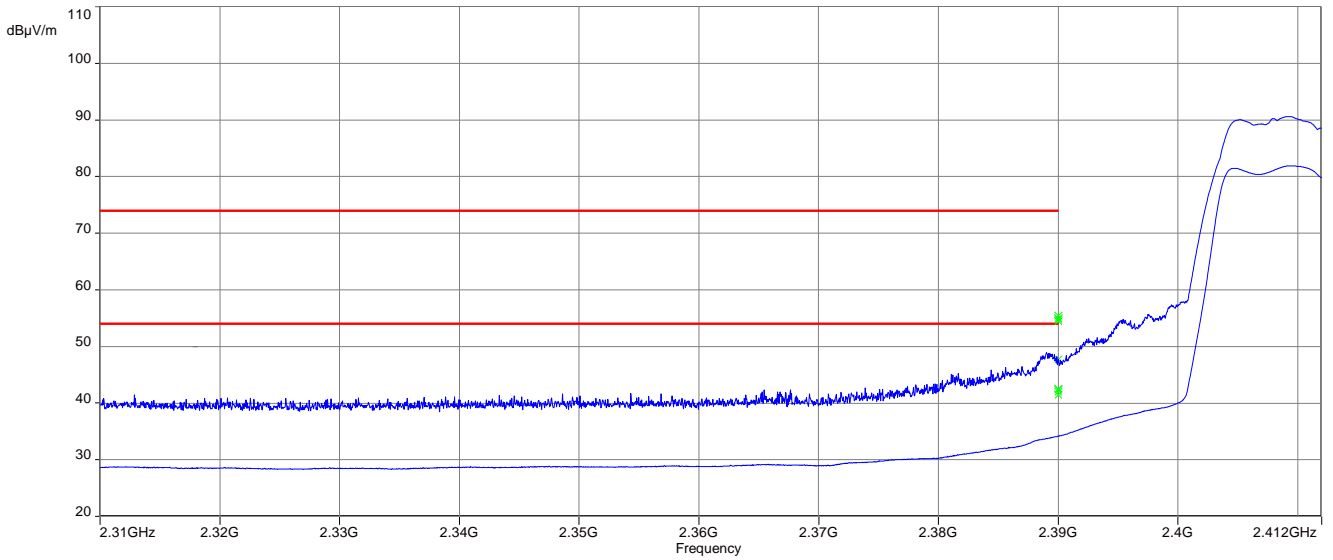

Plot 2: TX mode, upper band edge, vertical & horizontal polarization

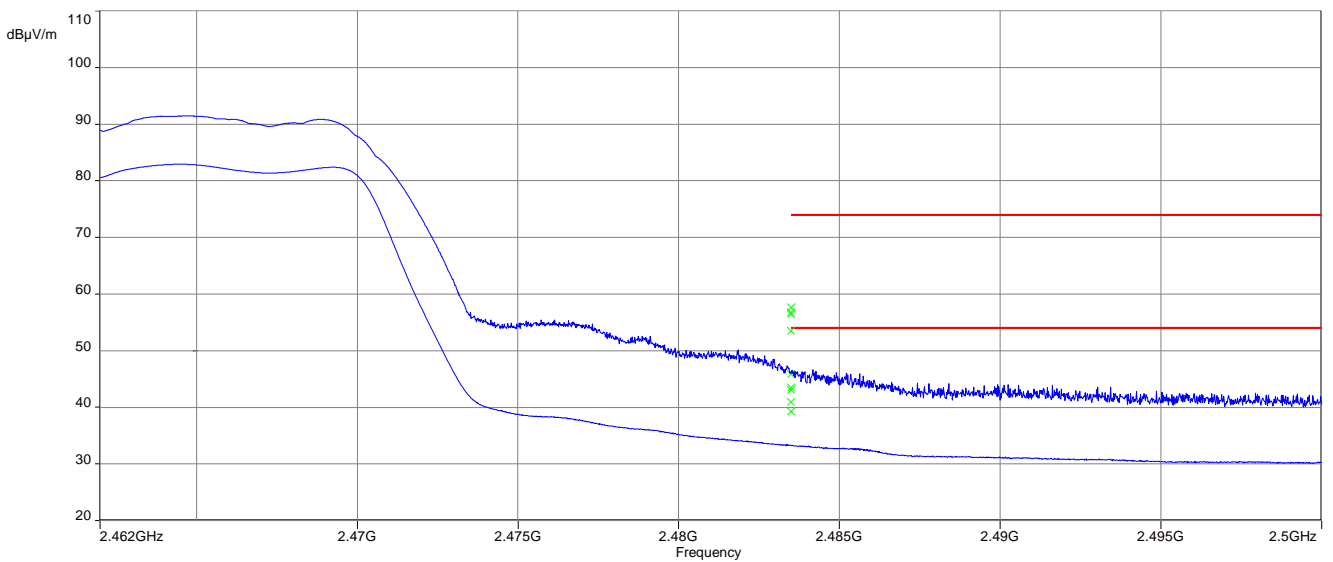

Plots: OFDM (40 MHz bandwidth) - mode peak / average

Plot 1: TX mode, lower band edge, vertical & horizontal polarization

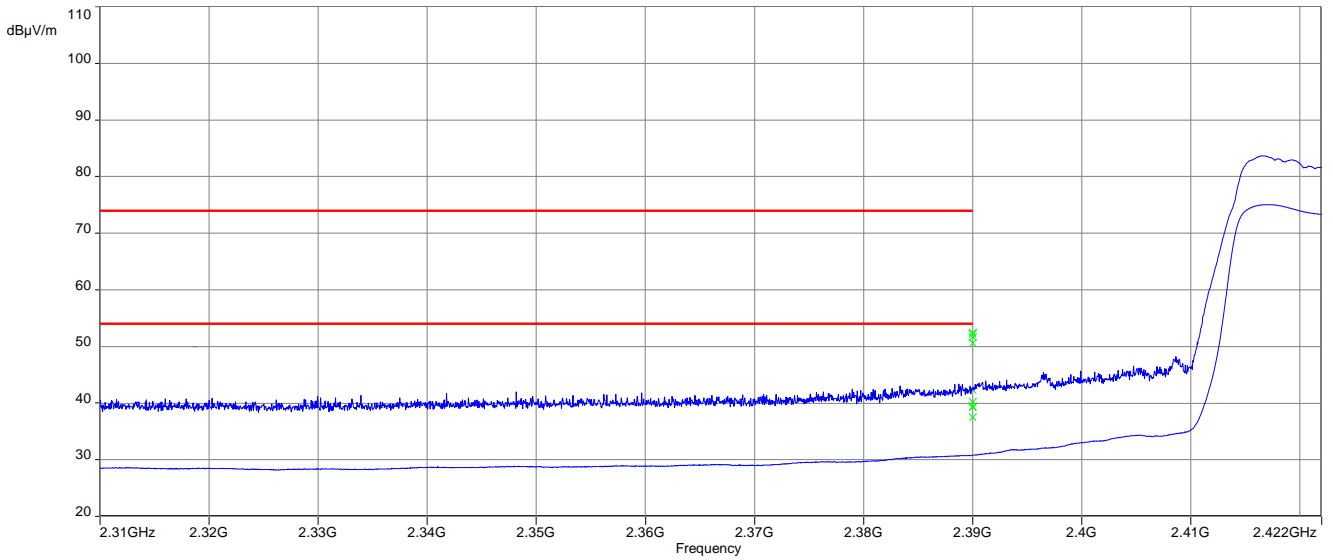

Plot 2: TX mode, upper band edge, vertical & horizontal polarization

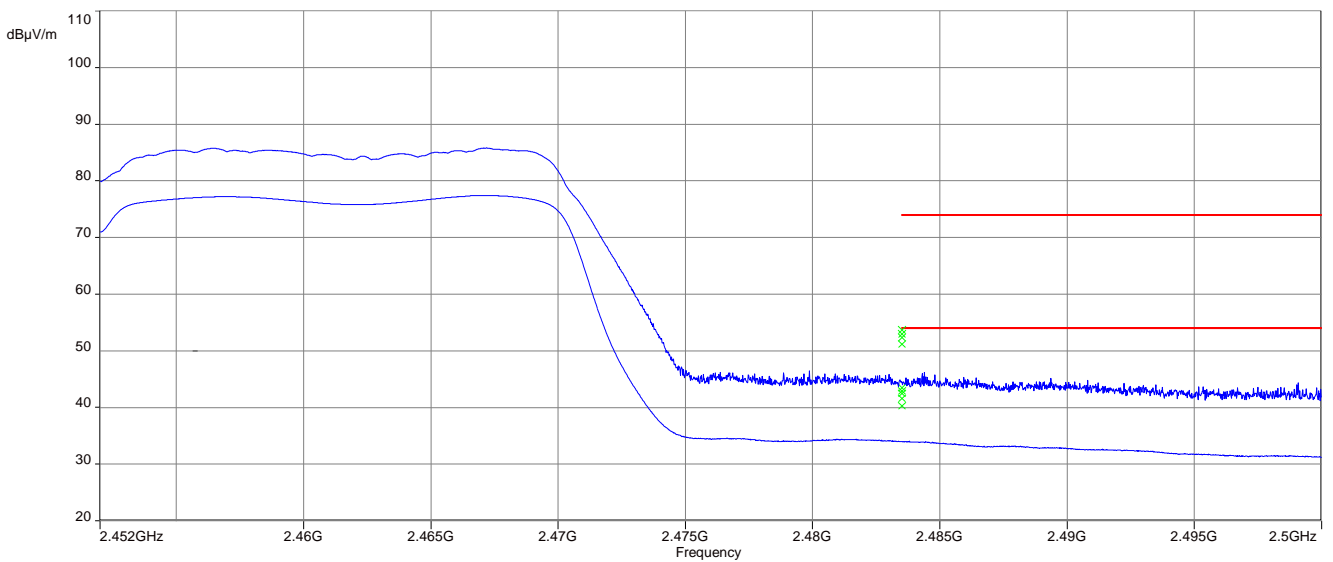

13.10 Spurious emissions conducted

Description:

Measurement of the conducted spurious emissions in transmit mode. The measurement is performed at the lowest; the middle and the highest channel.

Measurement:

Measurement parameter	
Detector	Peak
Sweep time	Auto
Resolution bandwidth	100 kHz
Video bandwidth	500 kHz
Span	9 kHz to 25 GHz
Trace mode	Max Hold
External result file(s)	1-4711_22-01-12_log1_conducted.pdf
Test setup	See chapter 7.5 setup A
s	See chapter 9

Limits:

FCC	ISED
In any 100 kHz bandwidth outside the frequency band in which the spread spectrum or digitally modulated intentional radiator is operating, the radio frequency power that is produced by the intentional radiator shall be at least 30 dB below that in the 100 kHz bandwidth within the band that contains the highest level of the desired power, based on either an RF conducted or a radiated measurement. Attenuation below the general limits specified in Section 15.209(a) is not required	

Results: DSSS / b – mode

TX spurious emissions conducted					
f [MHz]		amplitude of emission [dBm]	limit max. allowed emission power	actual attenuation below frequency of operation [dB]	results
Lowest channel		7.7	30 dBm		Operating frequency
All detected emissions are below the -20 dBc & -30 dBc criteria.			-20 dBc (peak) -30 dBc (average)		compliant
Middle channel		1.4	30 dBm		Operating frequency
All detected emissions are below the -20 dBc & -30 dBc criteria.			-20 dBc (peak) -30 dBc (average)		compliant
Highest channel		2.6	30 dBm		Operating frequency
All detected emissions are below the -20 dBc & -30 dBc criteria.			-20 dBc (peak) -30 dBc (average)		compliant

Results: OFDM / g – mode

TX spurious emissions conducted					
f [MHz]		amplitude of emission [dBm]	limit max. allowed emission power	actual attenuation below frequency of operation [dB]	results
Lowest channel		-0.3	30 dBm		Operating frequency
All detected emissions are below the -20 dBc & -30 dBc criteria.			-20 dBc (peak) -30 dBc (average)		compliant
Middle channel		1.5	30 dBm		Operating frequency
All detected emissions are below the -20 dBc & -30 dBc criteria.			-20 dBc (peak) -30 dBc (average)		compliant
Highest channel		-0.6	30 dBm		Operating frequency
All detected emissions are below the -20 dBc & -30 dBc criteria.			-20 dBc (peak) -30 dBc (average)		compliant

Results: OFDM / n HT20 – mode

TX spurious emissions conducted					
f [MHz]		amplitude of emission [dBm]	limit max. allowed emission power	actual attenuation below frequency of operation [dB]	results
Lowest channel		-0.8	30 dBm		Operating frequency
All detected emissions are below the -20 dBc & -30 dBc criteria.			-20 dBc (peak) -30 dBc (average)		compliant
Middle channel		0.6	30 dBm		Operating frequency
All detected emissions are below the -20 dBc & -30 dBc criteria.			-20 dBc (peak) -30 dBc (average)		compliant
Highest channel		-0.3	30 dBm		Operating frequency
All detected emissions are below the -20 dBc & -30 dBc criteria.			-20 dBc (peak) -30 dBc (average)		compliant

Results: OFDM / n HT40 – mode

TX spurious emissions conducted					
f [MHz]		amplitude of emission [dBm]	limit max. allowed emission power	actual attenuation below frequency of operation [dB]	results
Lowest channel		-7.5	30 dBm		Operating frequency
All detected emissions are below the -20 dBc & -30 dBc criteria.			-20 dBc (peak) -30 dBc (average)		compliant
Middle channel		-4.3	30 dBm		Operating frequency
All detected emissions are below the -20 dBc & -30 dBc criteria.			-20 dBc (peak) -30 dBc (average)		compliant
Highest channel		-7.4	30 dBm		Operating frequency
All detected emissions are below the -20 dBc & -30 dBc criteria.			-20 dBc (peak) -30 dBc (average)		compliant

13.11 Spurious emissions radiated below 30 MHz

Description:

Measurement of the radiated spurious emissions in transmit mode below 30 MHz. The limits are recalculated to a measurement distance of 3 m with 40 dB/decade according CFR Part 2.

Measurement:

Measurement parameter	
Detector	Peak / Quasi Peak
Sweep time	Auto
Resolution bandwidth	F < 150 kHz: 200 Hz F > 150 kHz: 9 kHz
Video bandwidth	F < 150 kHz: 1 kHz F > 150 kHz: 100 kHz
Span	9 kHz to 30 MHz
Trace mode	Max Hold
Measured modulation	<input checked="" type="checkbox"/> DSSS b – mode <input checked="" type="checkbox"/> OFDM g – mode <input type="checkbox"/> OFDM n HT20 – mode <input checked="" type="checkbox"/> OFDM n HT40 – mode
Test setup	See chapter 7.2 setup A
Measurement uncertainty	See chapter 9

Limits:

FCC		ISED	
Frequency / MHz	Field Strength / (dBµV / m)	Measurement distance / m	
0.009 – 0.490	2400/F(kHz)	300	
0.490 – 1.705	24000/F(kHz)	30	
1.705 – 30.0	30	30	

Results:

TX spurious emissions radiated < 30 MHz / (dBµV / m) @ 3 m		
Frequency / MHz	Detector	Level / (dBµV / m)
All detected peaks are more than 20 dB below the limit.		

Plots: DSSS

Plot 1: 9 kHz to 30 MHz, lowest channel

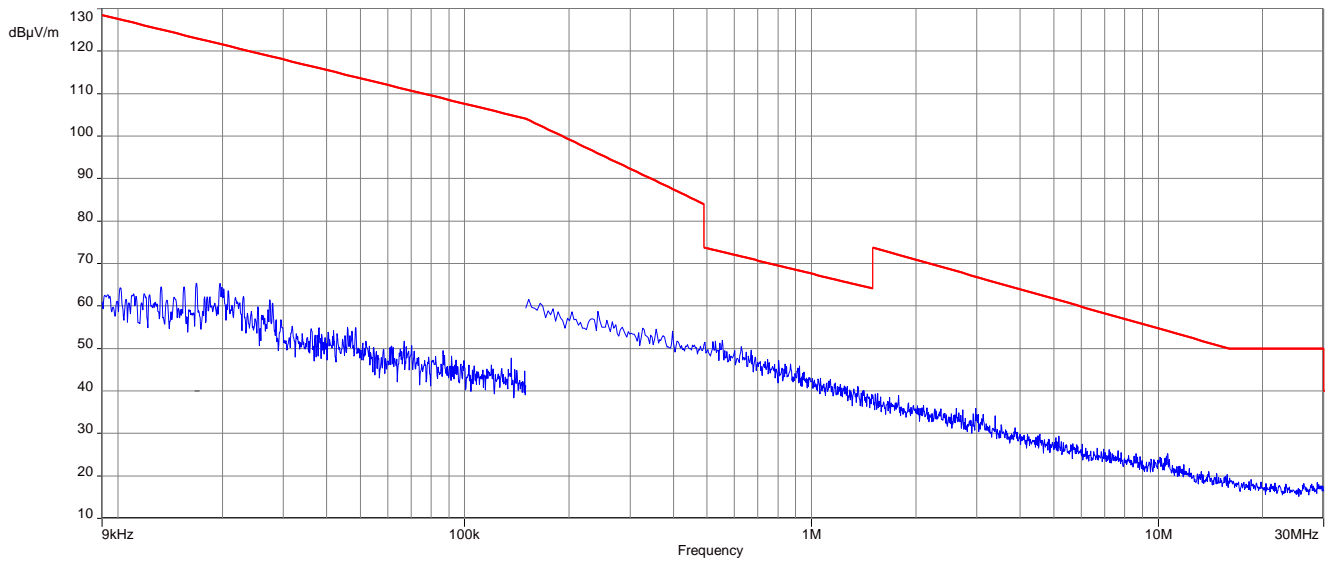

Plot 2: 9 kHz to 30 MHz, middle channel

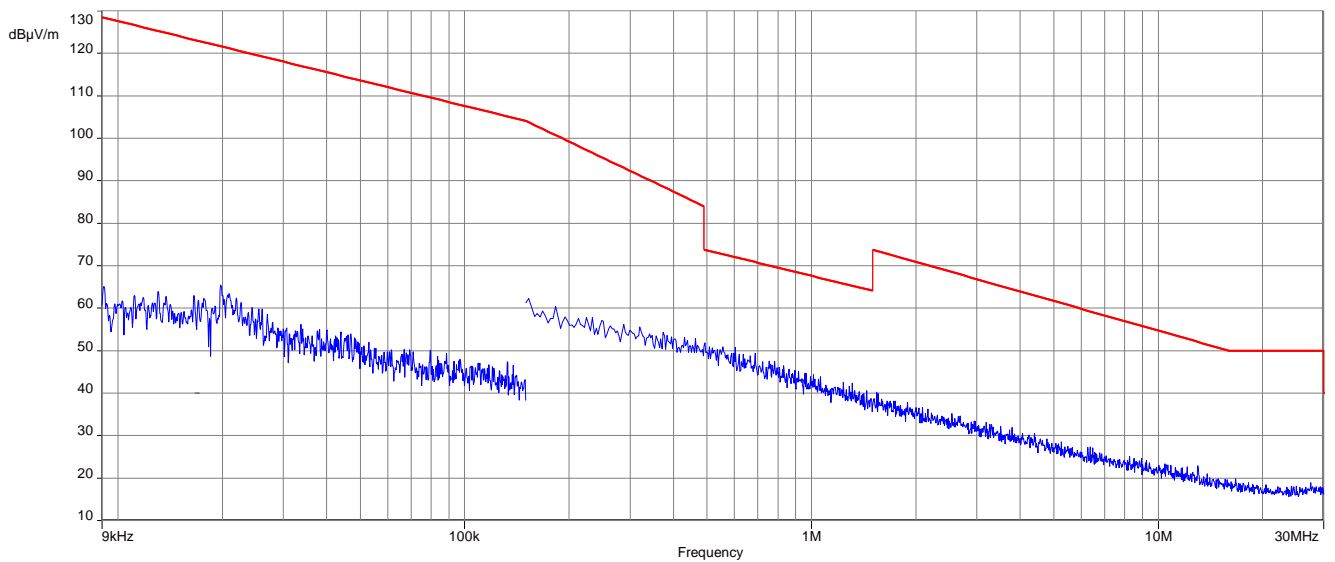

Plot 3: 9 kHz to 30 MHz, highest channel

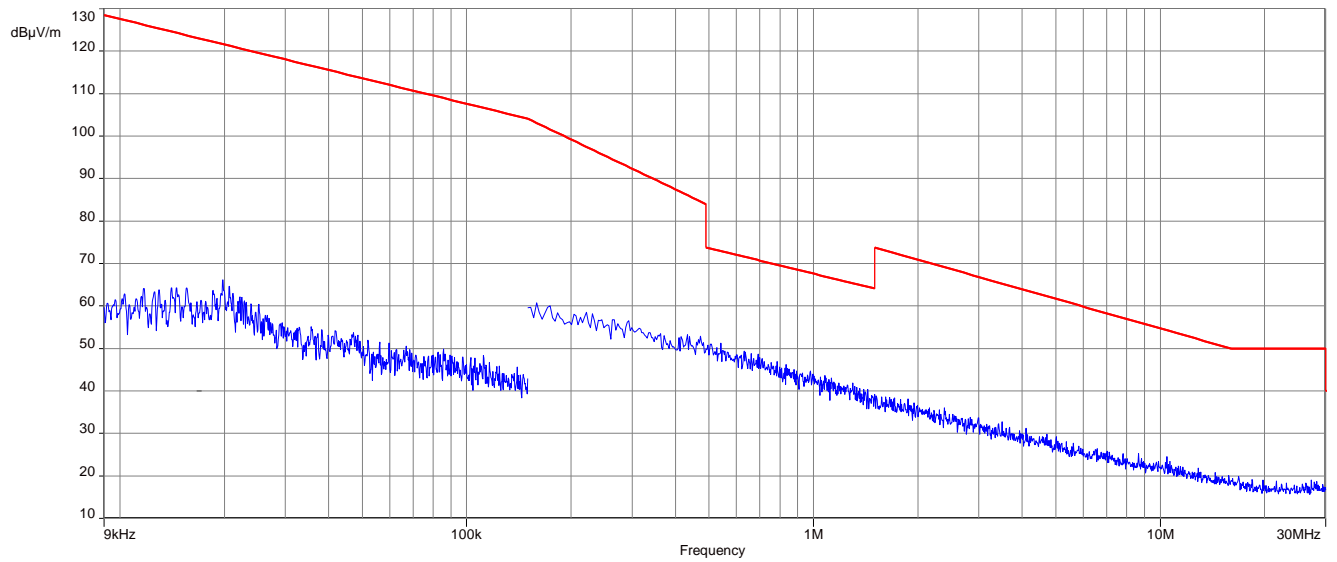

Plots: OFDM (20 MHz nominal channel bandwidth)

Plot 1: 9 kHz to 30 MHz, lowest channel

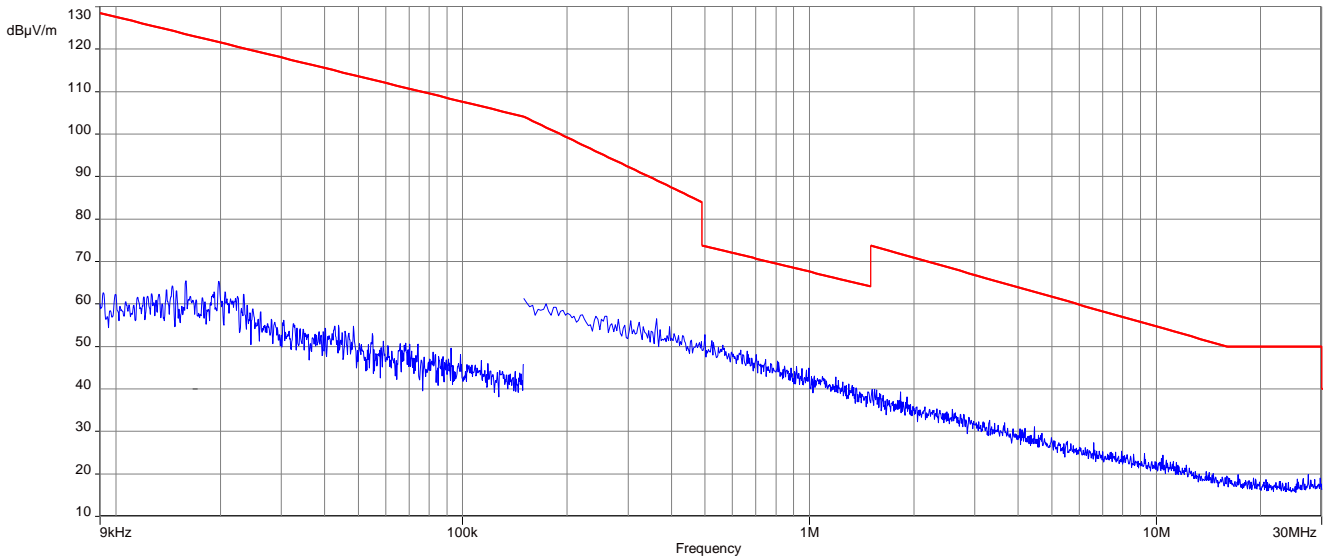

Plot 2: 9 kHz to 30 MHz, middle channel

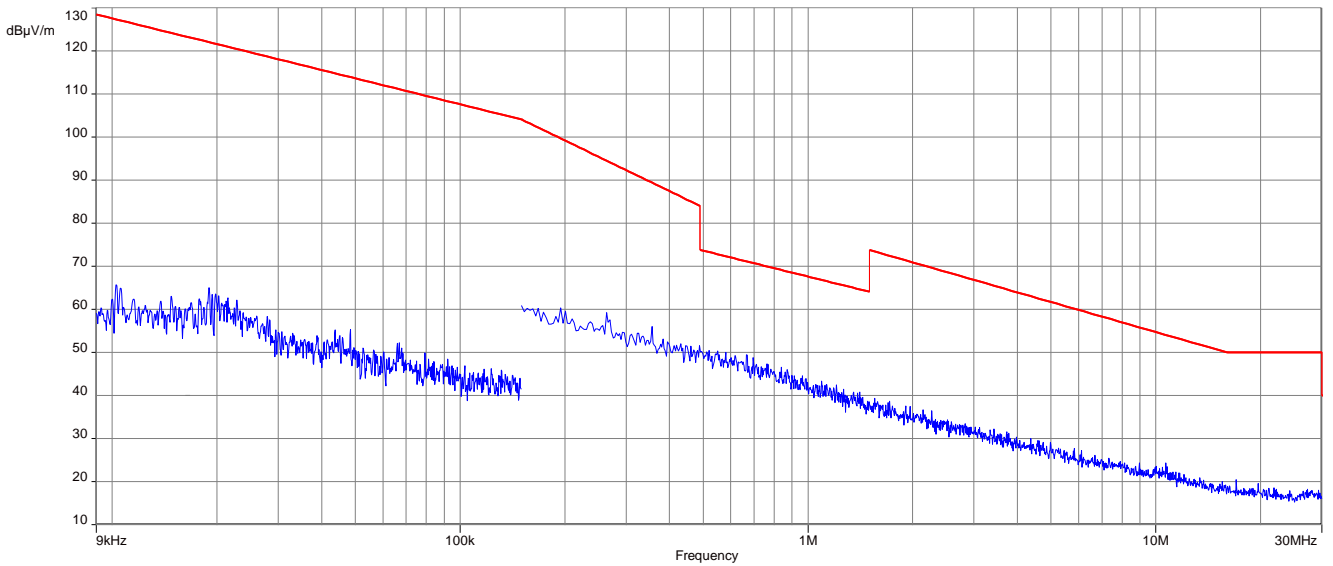

Plot 3: 9 kHz to 30 MHz, highest channel

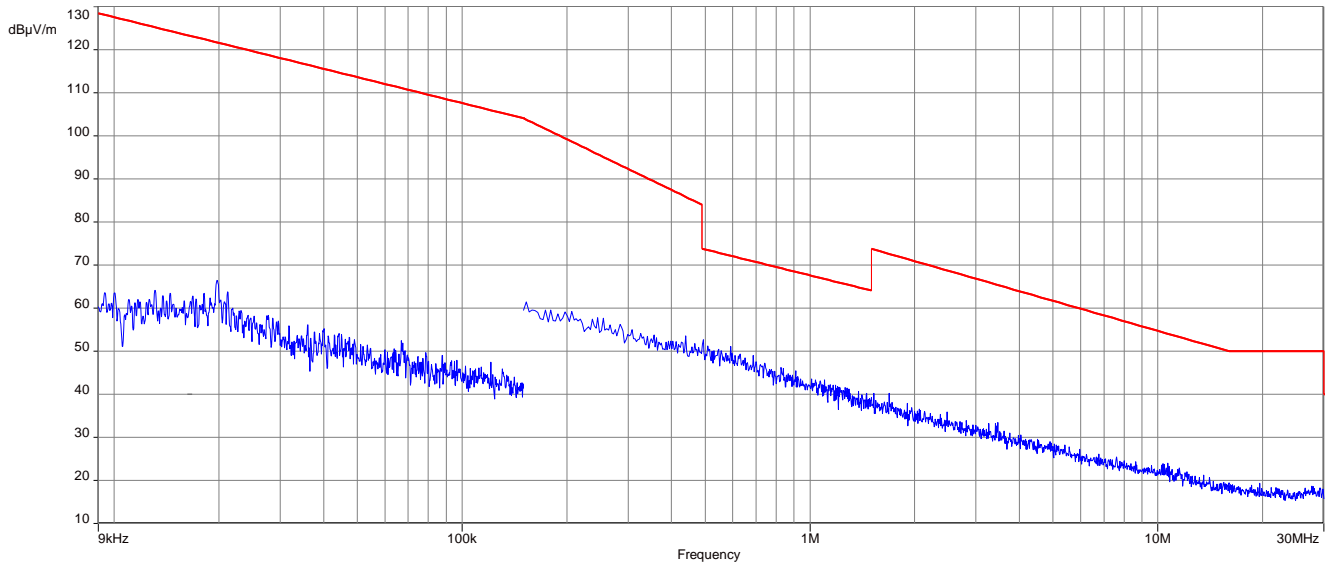

Plots: OFDM (40 MHz nominal channel bandwidth)

Plot 1: 9 kHz to 30 MHz, lowest channel

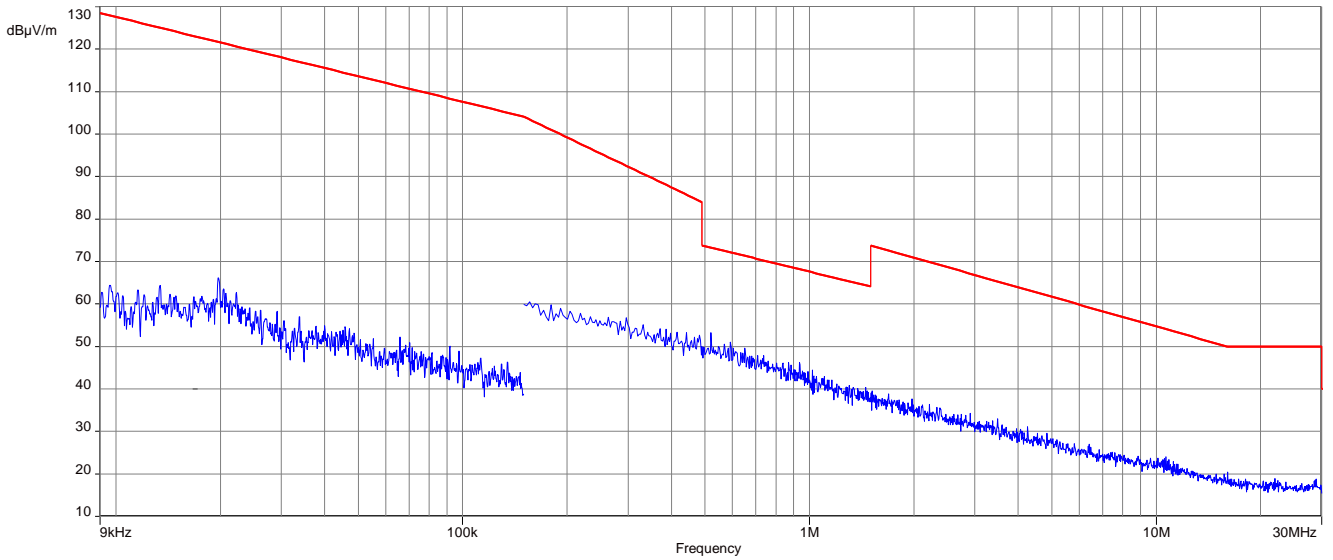

Plot 2: 9 kHz to 30 MHz, middle channel

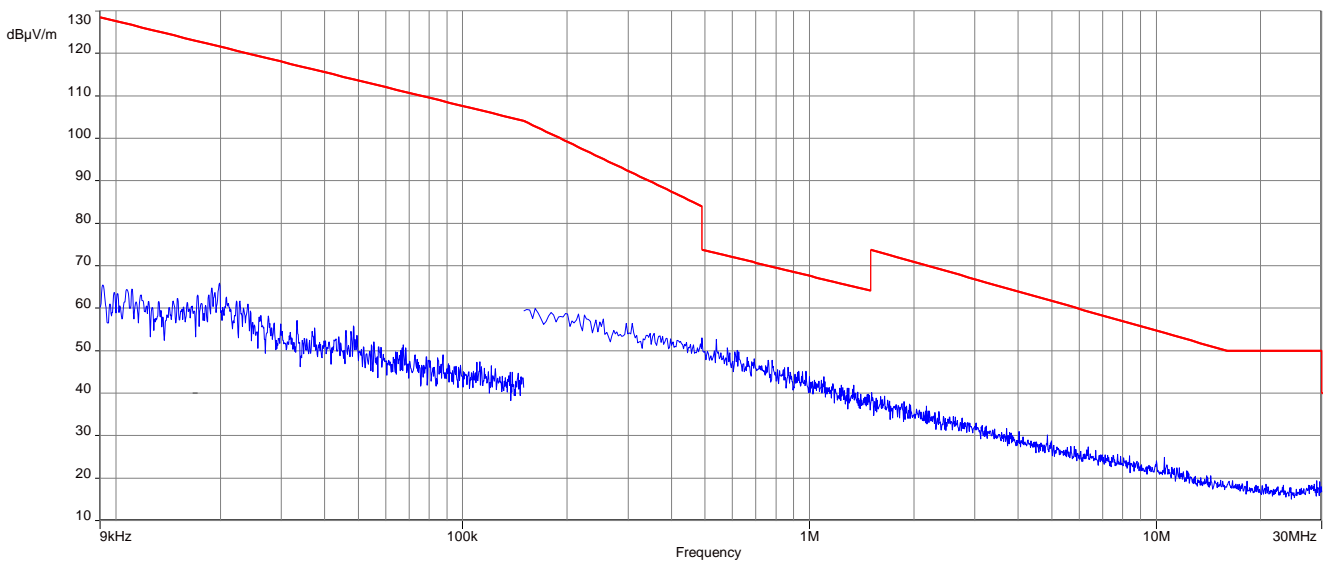

Plot 3: 9 kHz to 30 MHz, highest channel

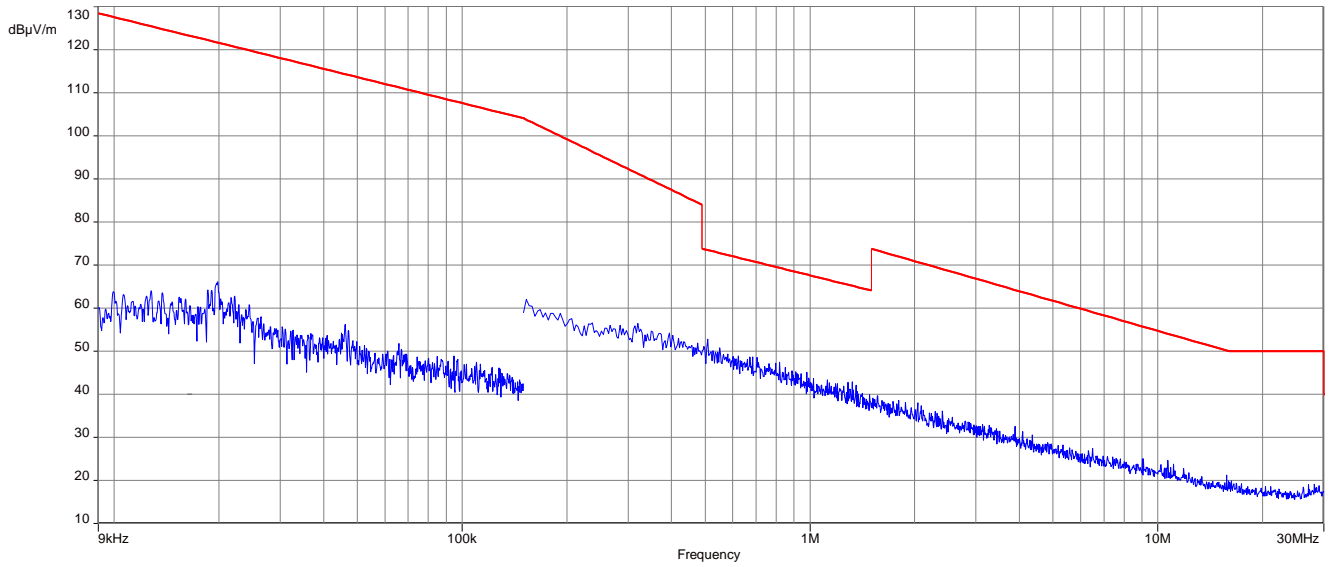

13.12 Spurious emissions radiated 30 MHz to 1 GHz

Description:

Measurement of the radiated spurious emissions and cabinet radiations below 1 GHz.

Measurement:

Measurement parameter	
Detector	Peak / Quasi Peak
Sweep time	Auto
Resolution bandwidth	120 kHz
Video bandwidth	3 x RBW
Span	30 MHz to 1 GHz
Trace mode	Max Hold
Measured modulation	<input checked="" type="checkbox"/> DSSS b – mode <input checked="" type="checkbox"/> OFDM g – mode <input type="checkbox"/> OFDM n HT20 – mode <input checked="" type="checkbox"/> OFDM n HT40 – mode
Test setup	See chapter 7.1 setup A
Measurement uncertainty	See chapter 9

Limits:

FCC	ISED	
In any 100 kHz bandwidth outside the frequency band in which the spread spectrum or digitally modulated intentional radiator is operating, the radio frequency power that is produced by the intentional radiator shall be at least 20 dB below that in the 100 kHz bandwidth within the band that contains the highest level of the desired power, based on either an RF conducted or a radiated measurement. Attenuation below the general limits specified in Section 15.209(a) is not required. In addition, radiated emissions which fall in the restricted bands, as defined in §15.205(a), must also comply with the radiated emission limits specified in §15.209(a) (see §15.205(c)).		
Frequency / MHz	Field Strength / (dBµV / m)	Measurement distance / m
30 – 88	30.0	10
88 – 216	33.5	10
216 – 960	36.0	10

Plot: DSSS

Plot 1: 30 MHz to 1 GHz, vertical & horizontal polarization (max hold, three channels)

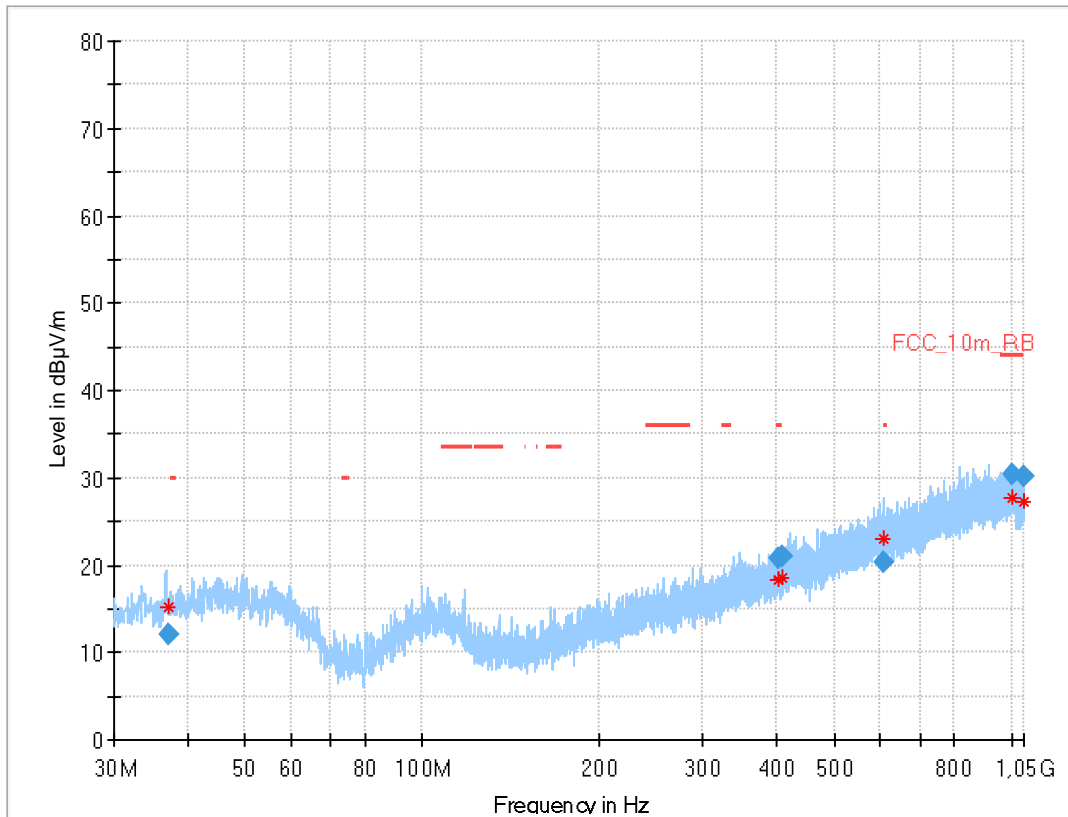

Final results:

Frequency (MHz)	QuasiPeak (dBµV/m)	Limit (dBµV/m)	Margin (dB)	Meas. Time (ms)	Bandwidth (kHz)	Height (cm)	Pol	Azimuth (deg)	Corr. (dB)
37.172	12.13	---	---	1000	120.0	134.0	V	282	15
403.821	20.74	36.0	15.3	1000	120.0	148.0	H	22	18
407.873	21.02	36.0	15.0	1000	120.0	130.0	H	-22	18
608.324	20.24	36.0	15.8	1000	120.0	170.0	H	-22	22
1006.379	30.40	44.0	13.6	1000	120.0	156.0	H	4	26
1048.490	30.14	44.0	13.9	1000	120.0	170.0	H	266	27

Plot: OFDM (20 MHz nominal channel bandwidth)

Plot 1: 30 MHz to 1 GHz, vertical & horizontal polarization (max hold, three channels)

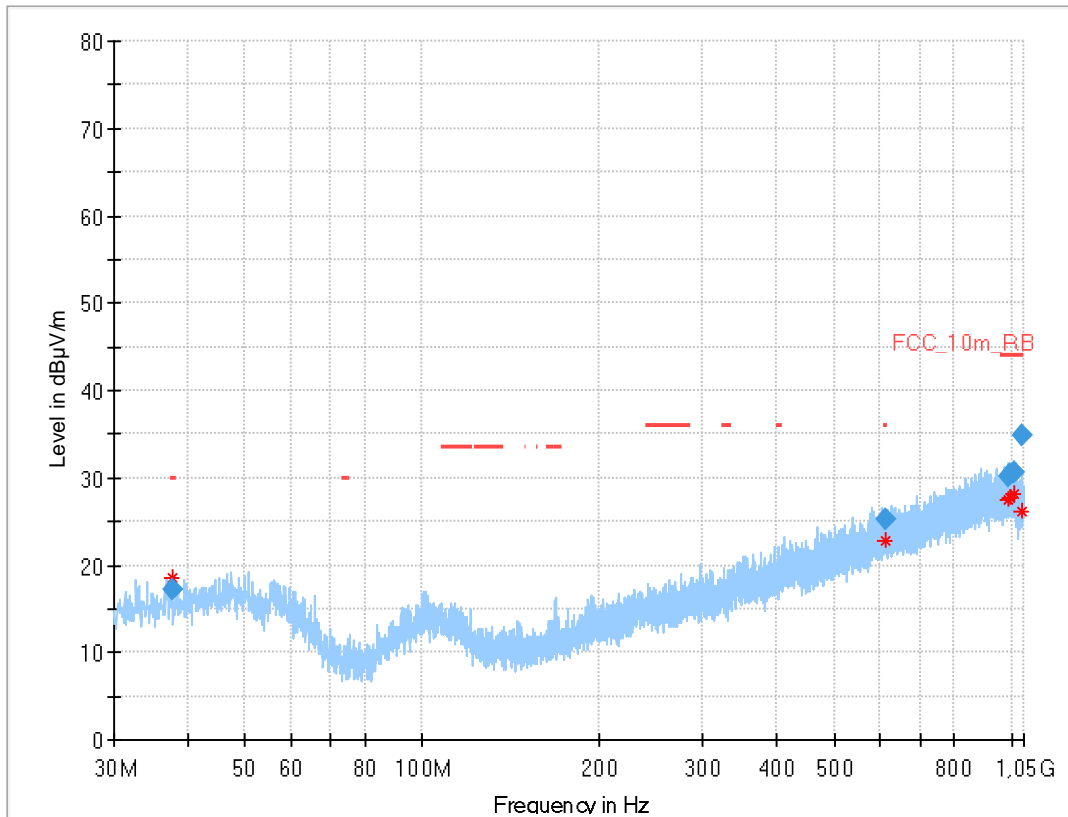

Final results:

Frequency (MHz)	QuasiPeak (dBµV/m)	Limit (dBµV/m)	Margin (dB)	Meas. Time (ms)	Bandwidth (kHz)	Height (cm)	Pol	Azimuth (deg)	Corr. (dB)
38.155	12.26	30.0	17.7	1000	120.0	114.0	V	75	15
112.597	15.29	33.5	18.2	1000	120.0	170.0	V	251	13
162.462	8.51	33.5	25.0	1000	120.0	115.0	V	202	11
267.504	15.25	36.0	20.8	1000	120.0	107.0	V	67	14
608.757	25.30	36.0	10.7	1000	120.0	117.0	V	84	22
965.696	29.61	44.0	14.4	1000	120.0	170.0	V	10	25

Plot: OFDM (40 MHz nominal channel bandwidth)

Plot 1: 30 MHz to 1 GHz, vertical & horizontal polarization (max hold, three channels)

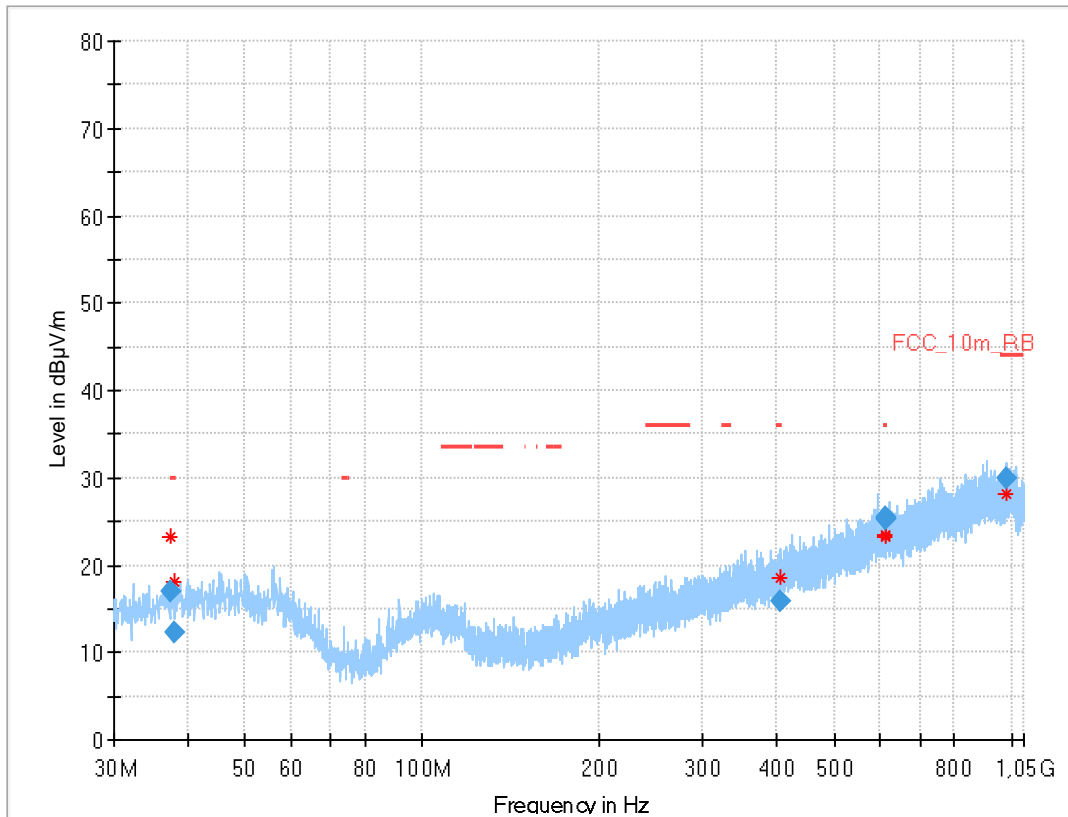

Final results:

Frequency (MHz)	QuasiPeak (dBµV/m)	Limit (dBµV/m)	Margin (dB)	Meas. Time (ms)	Bandwidth (kHz)	Height (cm)	Pol	Azimuth (deg)	Corr. (dB)
37.275	17.06	---	---	1000	120.0	126.0	V	281	15
38.096	12.26	30.0	17.7	1000	120.0	105.0	H	247	15
405.648	15.86	36.0	20.1	1000	120.0	170.0	H	68	18
611.325	25.34	36.0	10.7	1000	120.0	170.0	H	67	22
613.300	25.46	36.0	10.5	1000	120.0	170.0	H	67	22
978.478	29.96	44.0	14.0	1000	120.0	98.0	V	157	26

13.13 Spurious emissions radiated above 1 GHz

Description:

Measurement of the radiated spurious emissions above 1 GHz in transmit mode and receiver / idle mode.

Measurement:

Measurement parameter	
Detector	Peak / RMS
Sweep time	Auto
Resolution bandwidth	1 MHz
Video bandwidth	3 x RBW
Span	1 GHz to 26 GHz
Trace mode	Max Hold
Measured modulation	<input checked="" type="checkbox"/> DSSS b – mode <input checked="" type="checkbox"/> OFDM g – mode <input type="checkbox"/> OFDM n HT20 – mode <input checked="" type="checkbox"/> OFDM n HT40 – mode
Test setup	See chapter 7.2 setup C & 7.3 setup A
Measurement uncertainty	See chapter 9

Limits:

FCC	ISED	
In any 100 kHz bandwidth outside the frequency band in which the spread spectrum or digitally modulated intentional radiator is operating, the radio frequency power that is produced by the intentional radiator shall be at least 30 dB below that in the 100 kHz bandwidth within the band that contains the highest level of the desired power, based on either an RF conducted or a radiated measurement. Attenuation below the general limits specified in Section 15.209(a) is not required. In addition, radiated emissions which fall in the restricted bands, as defined in §15.205(a), must also comply with the radiated emission limits specified in §15.209(a) (see §15.205(c)).		
Frequency / MHz	Field Strength / (dBµV / m)	Measurement distance / m
Above 960	54.0 (AVG)	3
	74.0 (peak)	

Results: DSSS

TX spurious emissions radiated / dB μ V/m @ 3 m								
lowest channel			middle channel			highest channel		
f / MHz	Detector	Level / dB μ V/m	f / MHz	Detector	Level / dB μ V/m	f / MHz	Detector	Level / dB μ V/m
4824	Peak	49.7	4874	Peak	48.1	4924	Peak	49.0
	AVG	45.1		AVG	52.1		AVG	43.6
12060	Peak	54.1	7326	Peak	56.7	7386	Peak	56.9
	AVG	48.9		AVG	52.6		AVG	53.1
14472	Peak	54.3	12186	Peak	46.6	12309	Peak	49.7
	AVG	46.1		AVG	39.2		AVG	43.6
All other detected peak emissions are below the average limit or do not fall into the restricted band.			All other detected peak emissions are below the average limit or do not fall into the restricted band.			All other detected peak emissions are below the average limit or do not fall into the restricted band.		

Results: OFDM (20 MHz nominal channel bandwidth)

TX spurious emissions radiated / dB μ V/m @ 3 m								
lowest channel			middle channel			highest channel		
f / MHz	Detector	Level / dB μ V/m	f / MHz	Detector	Level / dB μ V/m	f / MHz	Detector	Level / dB μ V/m
7238	Peak	60.5	7311	Peak	60.3	7386	Peak	58.2
	AVG	52.5		AVG	50.7		AVG	48.5
All other detected peak emissions are below the average limit or do not fall into the restricted band.			All other detected peak emissions are below the average limit or do not fall into the restricted band.			All other detected peak emissions are below the average limit or do not fall into the restricted band.		

Results: OFDM (40 MHz nominal channel bandwidth)

TX spurious emissions radiated / dB μ V/m @ 3 m								
lowest channel			middle channel			highest channel		
f / MHz	Detector	Level / dB μ V/m	f / MHz	Detector	Level / dB μ V/m	f / MHz	Detector	Level / dB μ V/m
7285	Peak	52.2	7303	Peak	54.6	7382	Peak	50.5
	AVG	43.4		AVG	47.1		AVG	41.9
All other detected peak emissions are below the average limit or do not fall into the restricted band.			All other detected peak emissions are below the average limit or do not fall into the restricted band.			All other detected peak emissions are below the average limit or do not fall into the restricted band.		

Plots: DSSS

Plot 1: Lowest channel, 1 GHz to 18 GHz, vertical & horizontal polarization

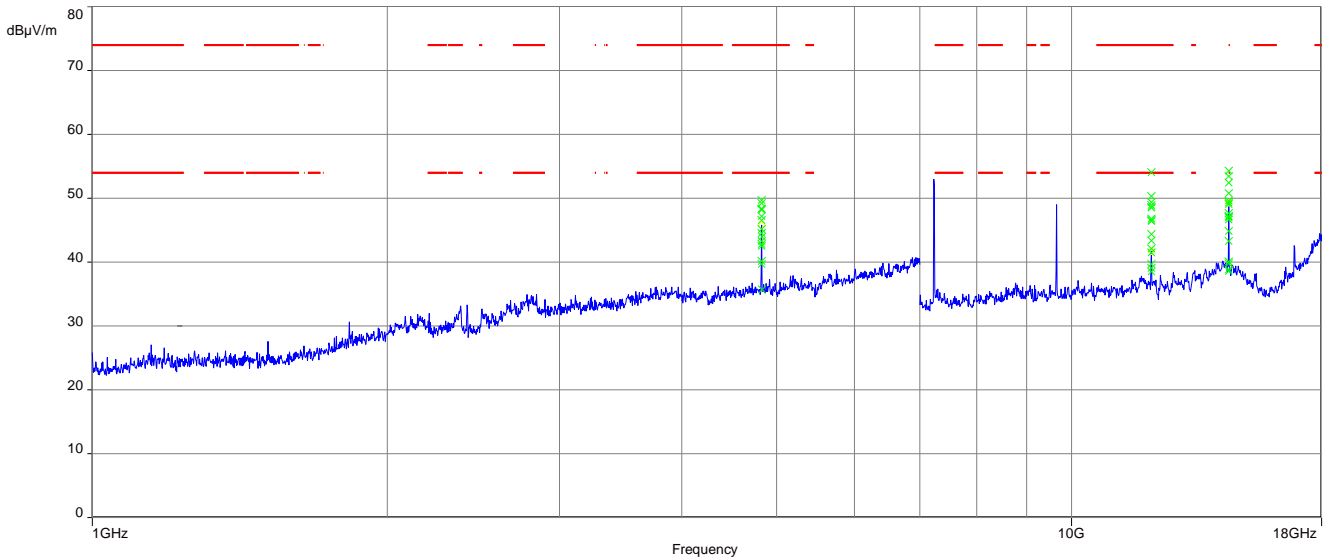

The carrier signal is notched with a 2.4 GHz band rejection filter.

Plot 3: Middle channel, 1 GHz to 18 GHz, vertical & horizontal polarization

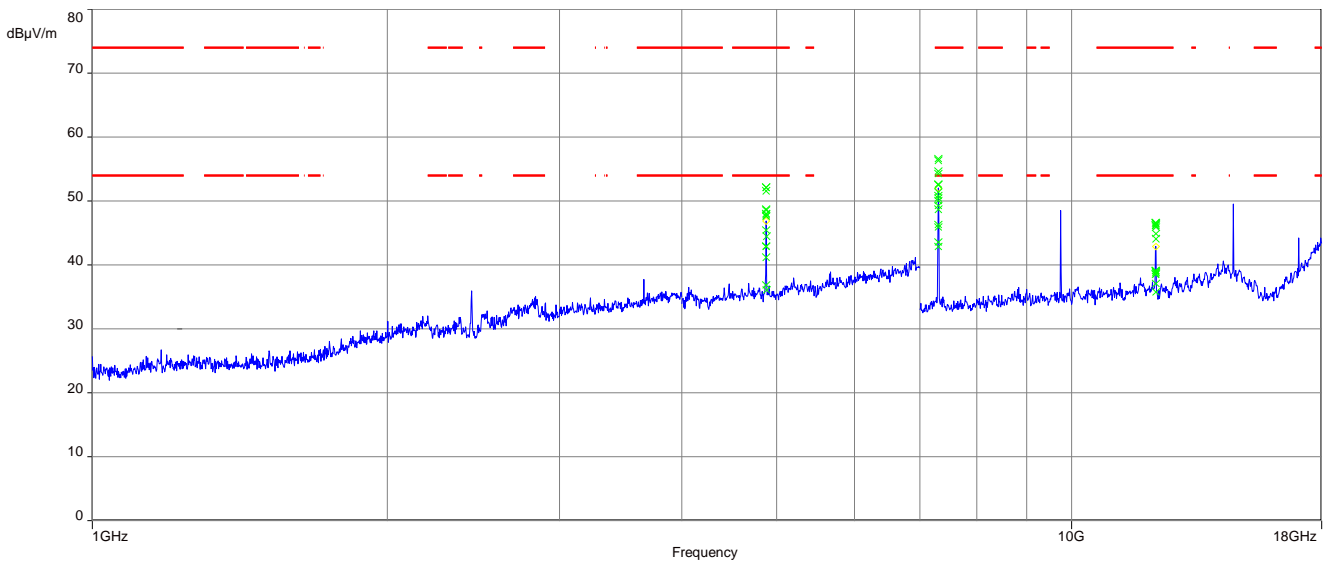

The carrier signal is notched with a 2.4 GHz band rejection filter.

Plot 5: Highest channel, 1 GHz to 18 GHz, vertical & horizontal polarization

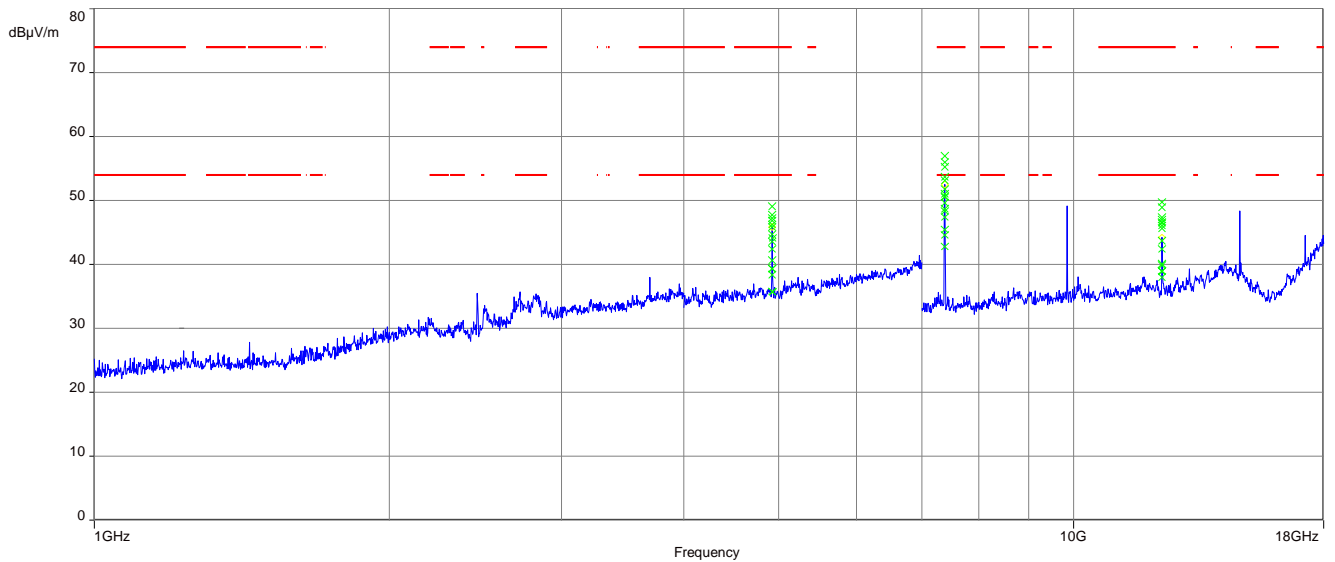

The carrier signal is notched with a 2.4 GHz band rejection filter.

Plot 6: Three channels max hold, 18 GHz to 26 GHz, vertical & horizontal polarization

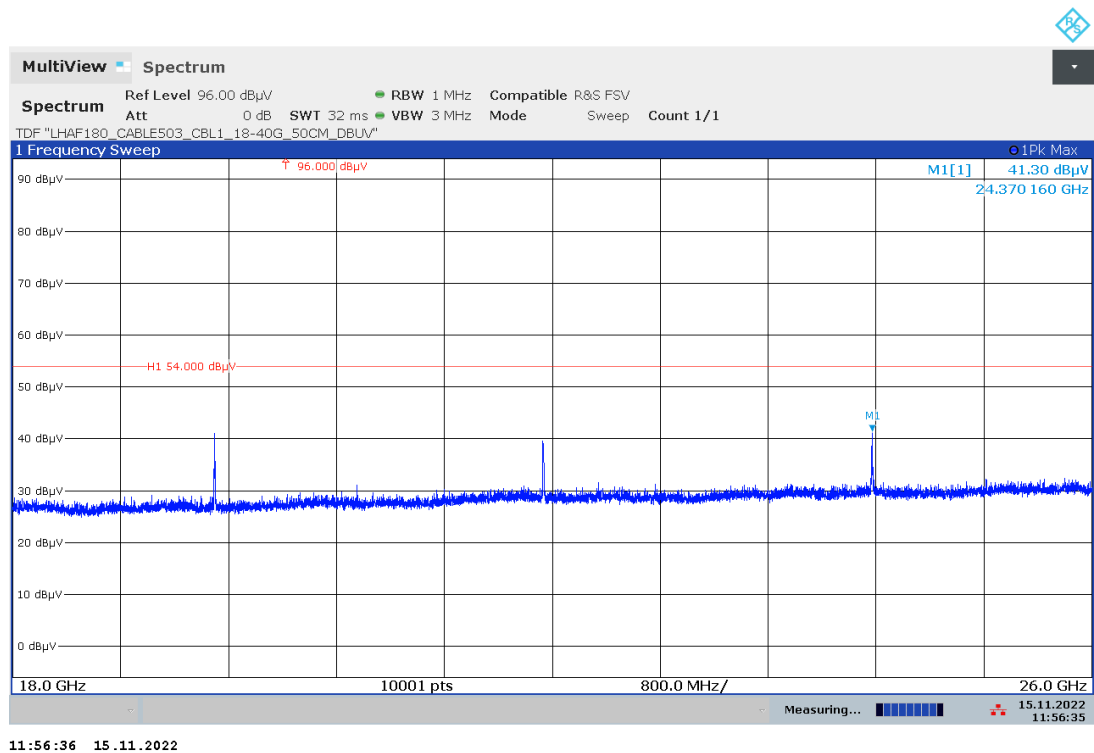

Plots: OFDM (20 MHz bandwidth)

Plot 1: Lowest channel, 1 GHz to 18 GHz, vertical & horizontal polarization

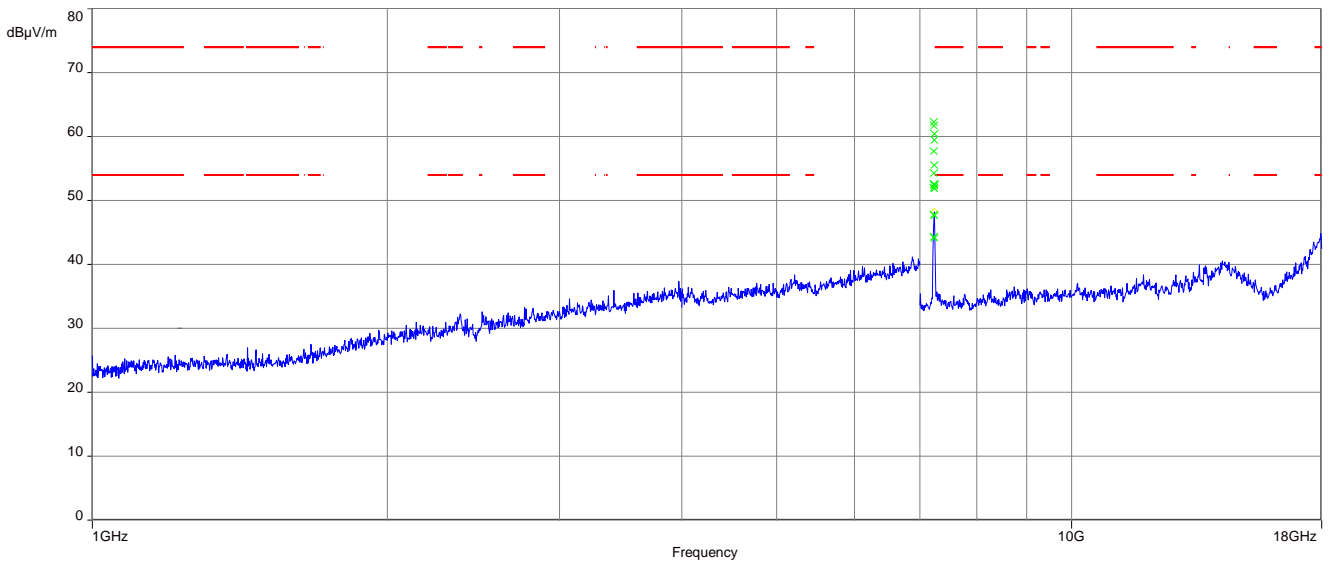

The carrier signal is notched with a 2.4 GHz band rejection filter.

Plot 3: Middle channel, 1 GHz to 18 GHz, vertical & horizontal polarization

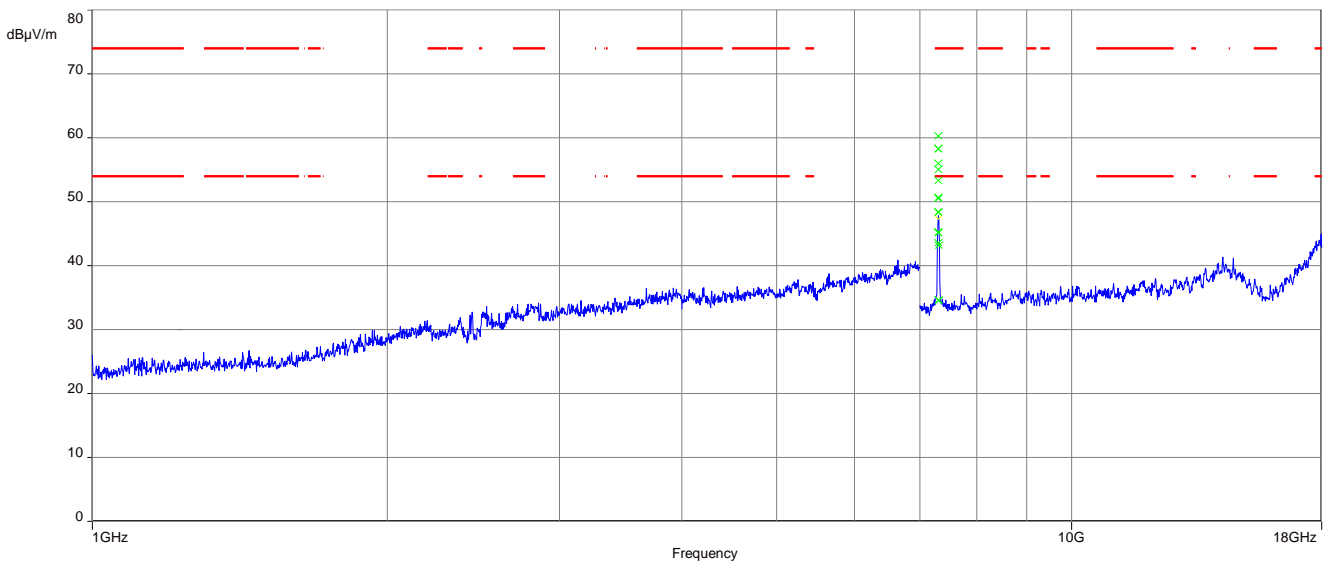

The carrier signal is notched with a 2.4 GHz band rejection filter.

Plot 5: Highest channel, 1 GHz to 18 GHz, vertical & horizontal polarization

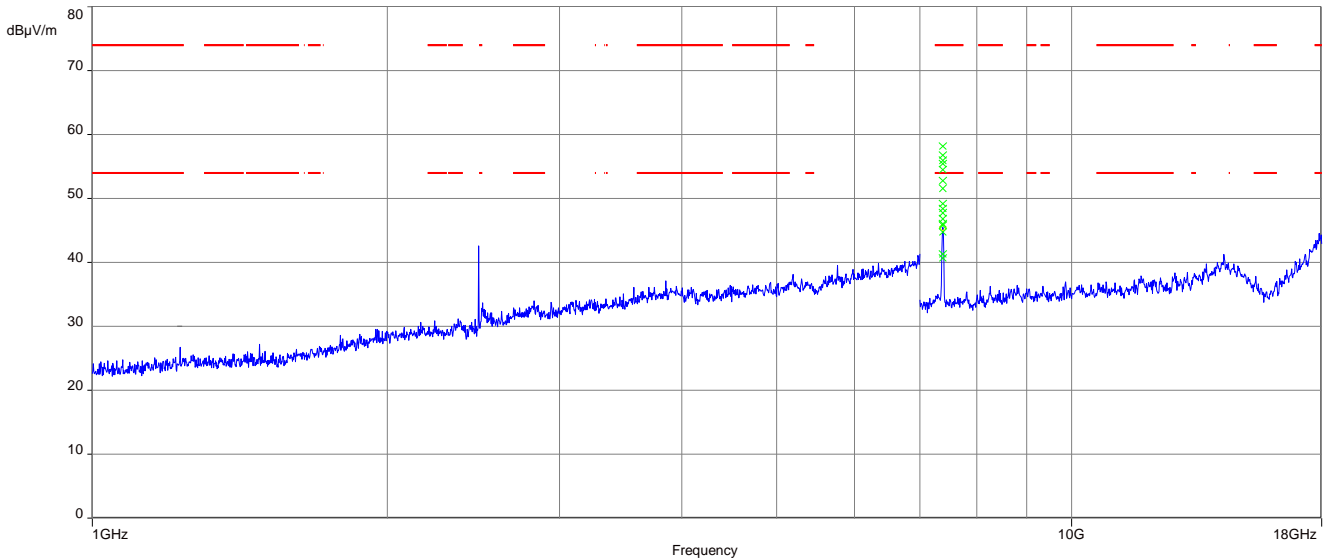

The carrier signal is notched with a 2.4 GHz band rejection filter.

Plot 6: Three channels max hold, 18 GHz to 26 GHz, vertical & horizontal polarization

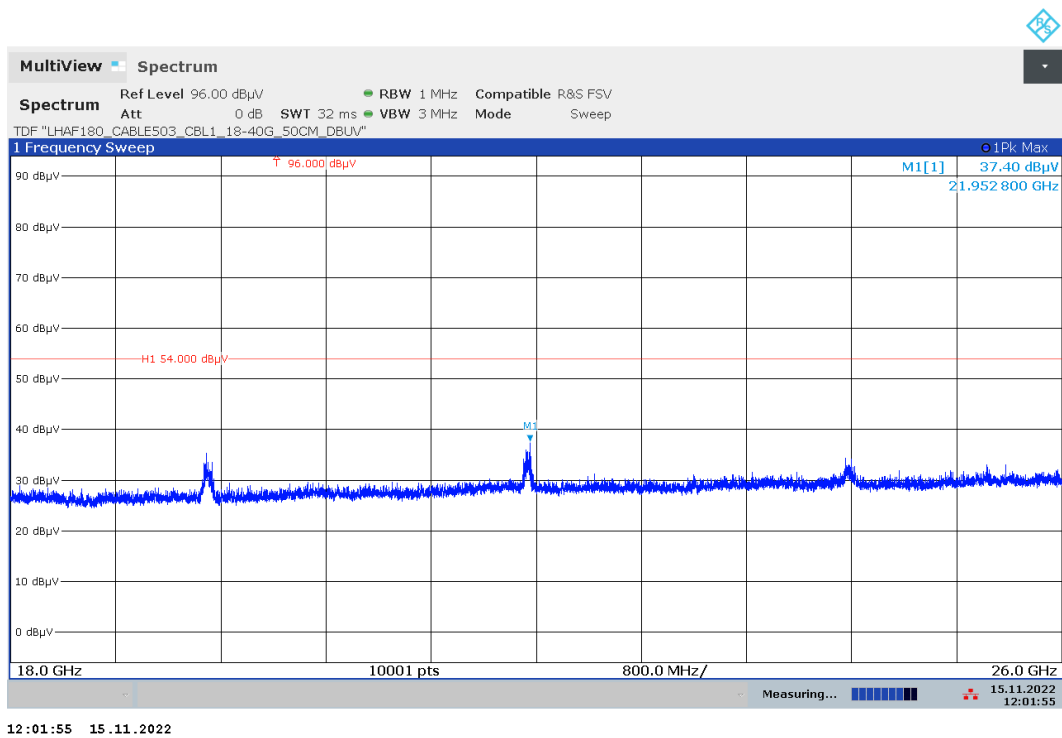

12:01:55 15.11.2022

Plots: OFDM (40 MHz bandwidth)

Plot 1: Lowest channel, 1 GHz to 18 GHz, vertical & horizontal polarization

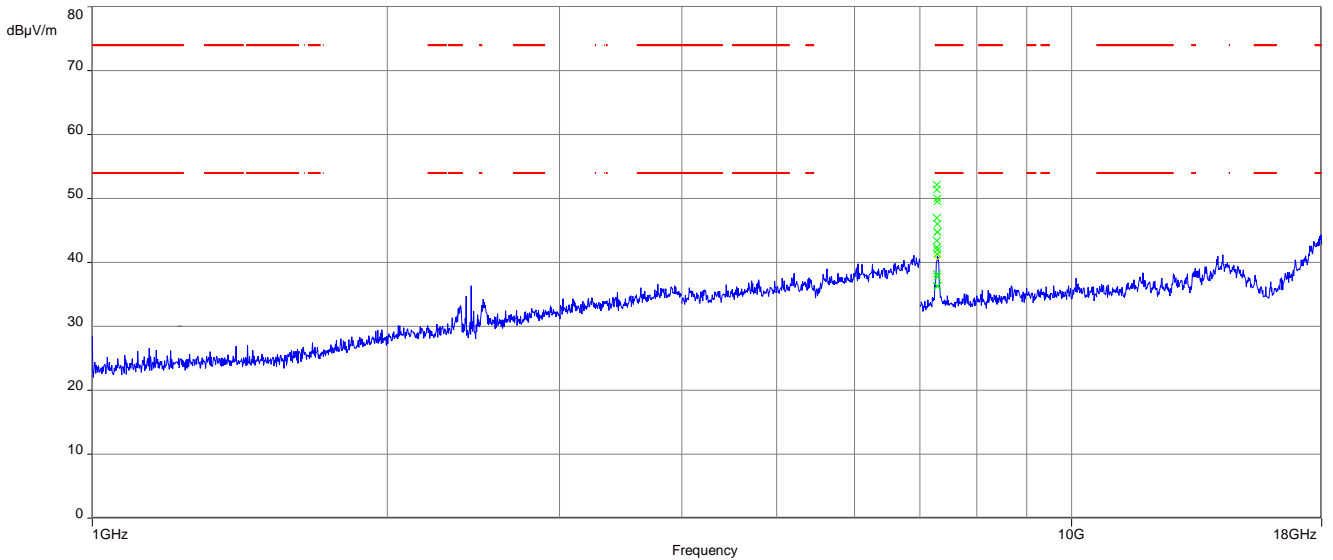

The carrier signal is notched with a 2.4 GHz band rejection filter.

Plot 3: Middle channel, 1 GHz to 18 GHz, vertical & horizontal polarization

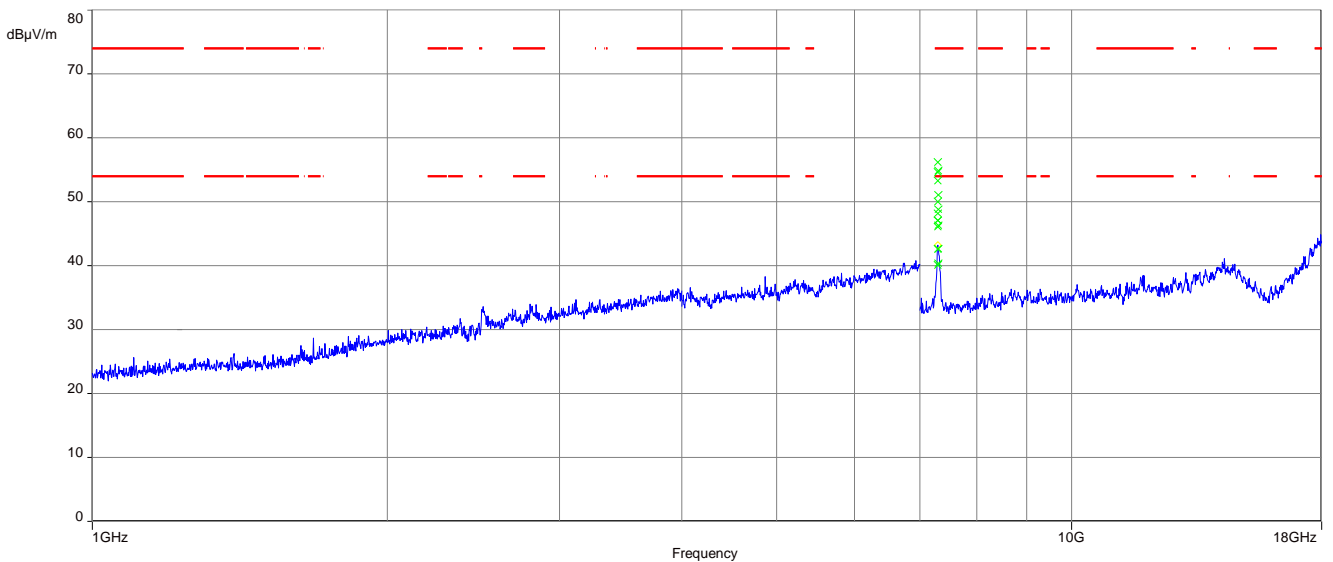

The carrier signal is notched with a 2.4 GHz band rejection filter.

Plot 5: Highest channel, 1 GHz to 18 GHz, vertical & horizontal polarization

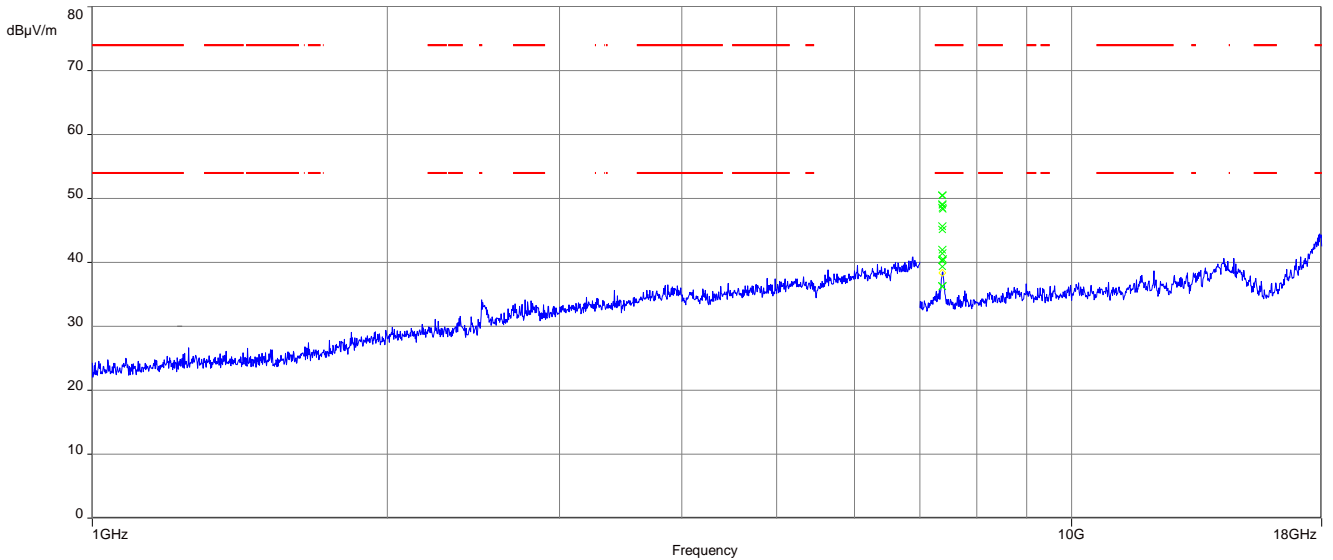

The carrier signal is notched with a 2.4 GHz band rejection filter.

Plot 6: Three channels max hold, 18 GHz to 26 GHz, vertical & horizontal polarization

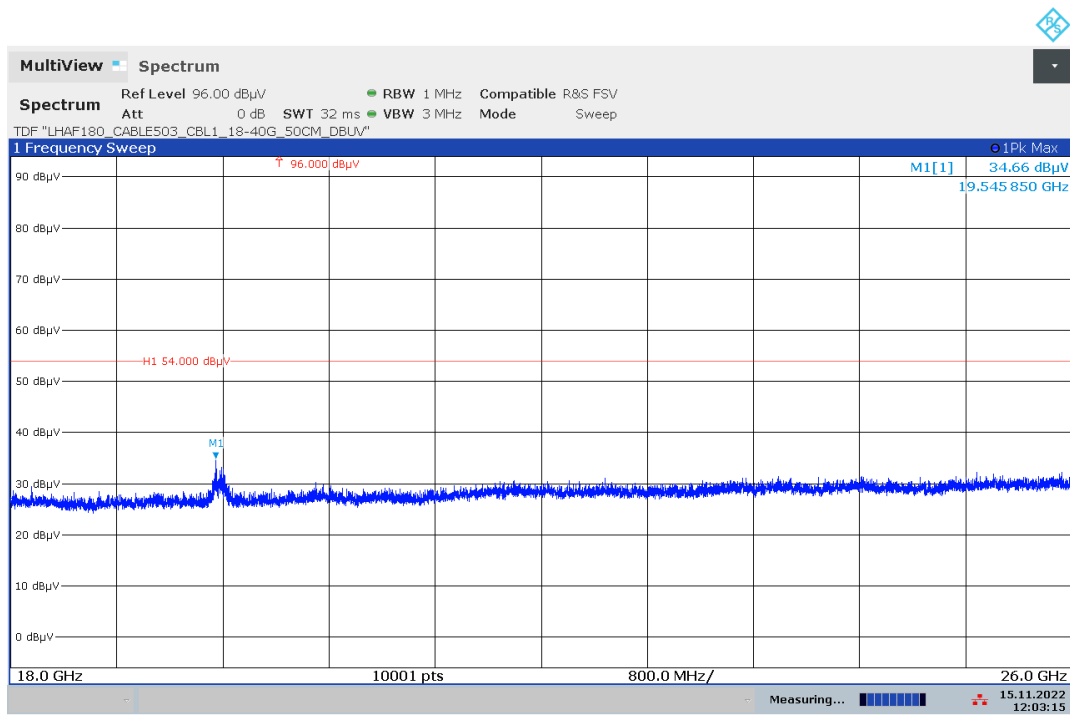

13.14 Spurious emissions conducted below 30 MHz (AC conducted)

Description:

Measurement of the conducted spurious emissions in transmit mode below 30 MHz. Both power lines, phase and neutral line, are measured. Found peaks are re-measured with average and quasi peak detection to show compliance to the limits.

Measurement:

Measurement parameter	
Detector	Peak - Quasi Peak / Average
Sweep time	Auto
Resolution bandwidth	F < 150 kHz: 200 Hz F > 150 kHz: 9 kHz
Video bandwidth	F < 150 kHz: 1 kHz F > 150 kHz: 100 kHz
Span	9 kHz to 30 MHz
Trace mode	Max. hold
Test setup	See chapter 7.4 setup A
Measurement uncertainty	See chapter 9

Limits:

FCC		ISED
Frequency / MHz	Quasi-Peak / (dBµV / m)	Average / (dBµV / m)
0.15 – 0.5	66 to 56*	56 to 46*
0.5 – 5	56	46
5 – 30.0	60	50

*Decreases with the logarithm of the frequency

Plots:

Plot 1: 150 kHz to 30 MHz, phase line

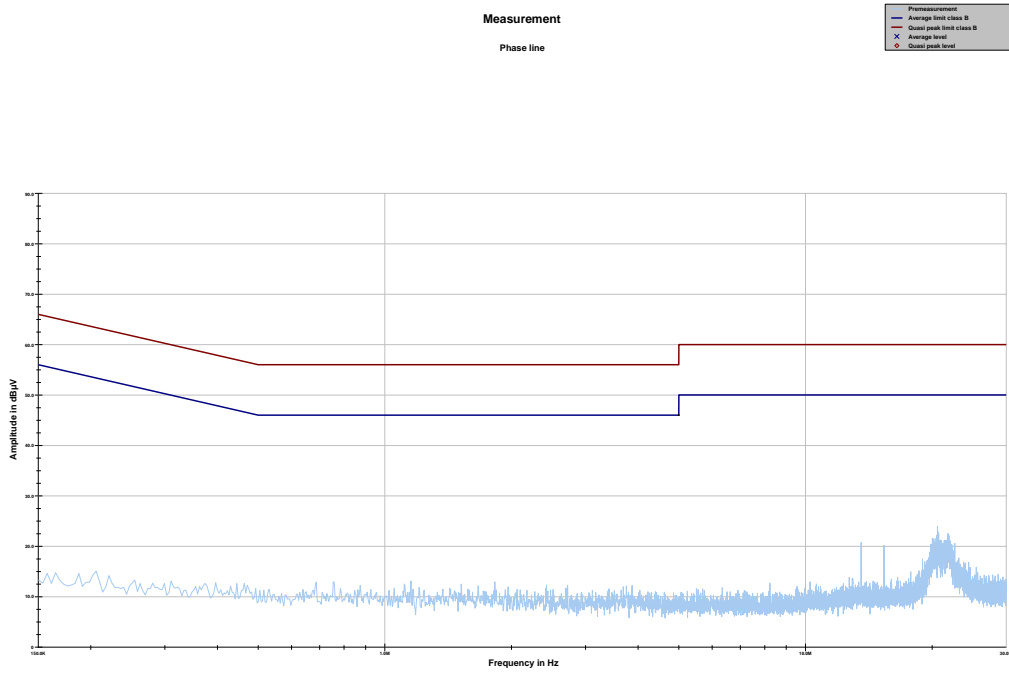

Plot 2: 150 kHz to 30 MHz, neutral line

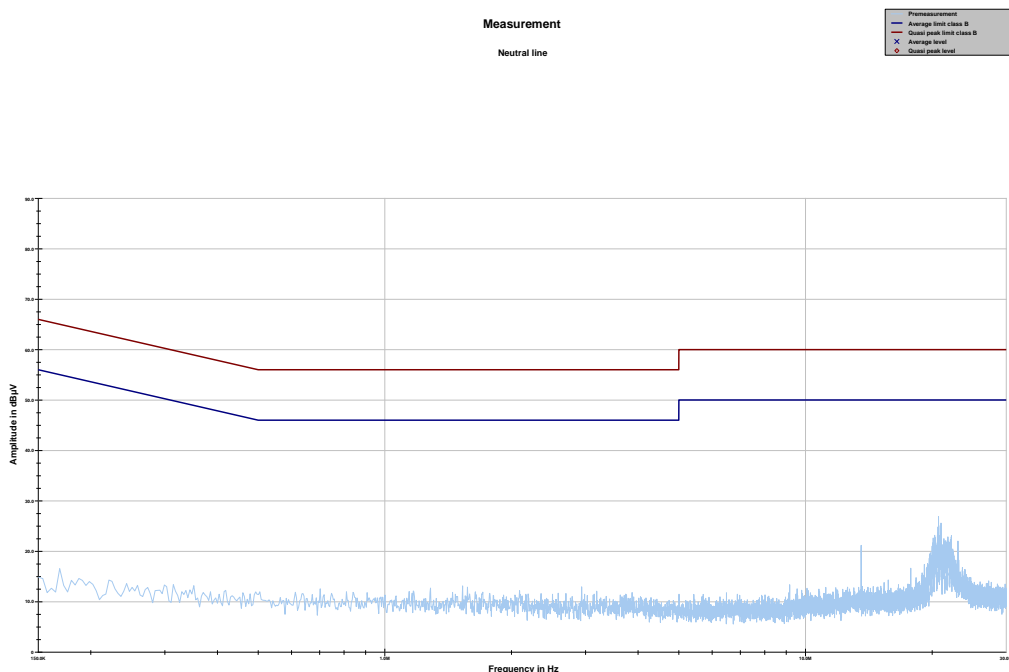

14 Observations

No observations except those reported with the single test cases have been made.

15 Glossary

EUT	Equipment under test
DUT	Device under test
UUT	Unit under test
FCC	Federal Communications Commission
FCC ID	Company Identifier at FCC
IC	Industry Canada
PMN	Product marketing name
HMN	Host marketing name
HVIN	Hardware version identification number
FVIN	Firmware version identification number
HW	Hardware
SW	Software
Inv. No.	Inventory number
S/N or SN	Serial number
C	Compliant
NC	Not compliant
NA	Not applicable
NP	Not performed
PP	Positive peak
QP	Quasi peak
AVG	Average
OC	Operating channel
OCW	Operating channel bandwidth
OBW	Occupied bandwidth
OOB	Out of band
DFS	Dynamic frequency selection
CAC	Channel availability check
OP	Occupancy period
NOP	Non occupancy period
DC	Duty cycle
PER	Packet error rate
CW	Clean wave
MC	Modulated carrier
WLAN	Wireless local area network
RLAN	Radio local area network
DSSS	Dynamic sequence spread spectrum
OFDM	Orthogonal frequency division multiplexing
FHSS	Frequency hopping spread spectrum

16 Document history

Version	Applied changes	Date of release
-/-	Initial release	2022-11-16

17 Accreditation Certificate – D-PL-12076-01-04

first page	last page
 <p>The first page of the accreditation certificate includes the DAKKS logo, the name 'Deutsche Akkreditierungsstelle GmbH', and accreditation details for CTC advanced GmbH. It states that the laboratory is competent under DIN EN ISO/IEC 17025:2018 for testing in the fields of Telecommunication (TC) and Electromagnetic Compatibility (EMC) for Canadian Standards. The certificate is signed by the Head of Division, dated 09.06.2020.</p>	 <p>The last page of the accreditation certificate lists the office addresses for Berlin, Frankfurt am Main, and Braunschweig. It also contains information regarding the publication of extracts, the accreditation granted pursuant to the Act on the Accreditation Body (AkkStelleG) of 31 July 2009, and the up-to-date state of membership.</p>

Note: The current certificate annex is published on the websites (link see below).

<https://www.dakks.de/files/data/as/pdf/D-PL-12076-01-04e.pdf>

OR

https://ctcadvanced.com/app/uploads/2020/06/D-PL-12076-01-04_Canada_TCEMC.pdf

18 Accreditation Certificate – D-PL-12076-01-05

first page	last page			
 <p>Deutsche Akkreditierungsstelle GmbH</p> <p>Entrusted according to Section 8 subsection 1 AkkStelleG in connection with Section 1 subsection 1 AkkStelleGBV Signatory to the Multilateral Agreements of EA, ILAC and IAF for Mutual Recognition</p> <p>Accreditation </p> <p>The Deutsche Akkreditierungsstelle GmbH attests that the testing laboratory CTC advanced GmbH Untertürkheimer Straße 6-10, 66117 Saarbrücken is competent under the terms of DIN EN ISO/IEC 17025:2018 to carry out tests in the following fields:</p> <p>Telecommunication (FCC Requirements)</p> <p>The accreditation certificate shall only apply in connection with the notice of accreditation of 09.06.2020 with the accreditation number D-PL-12076-01. It comprises the cover sheet, the reverse side of the cover sheet and the following annex with a total of 05 pages.</p> <p>Registration number of the certificate: D-PL-12076-01-05</p> <p>Frankfurt am Main, 09.06.2020  by <i>Dr. Alf Egner</i> Head of Division</p> <p><small>The certificate together with its annex reflects the status at the time of the date of issue. The current status of the scope of accreditation can be found in the database of accredited bodies of Deutsche Akkreditierungsstelle GmbH. https://www.dakks.de/en/content/accredited-bodies-dakks Site valid: 09/2020</small></p>	<p>Deutsche Akkreditierungsstelle GmbH</p> <table border="0"> <tr> <td>Office Berlin Spittelmarkt 10 10117 Berlin</td> <td>Office Frankfurt am Main Europa-Allee 52 60327 Frankfurt am Main</td> <td>Office Braunschweig Bundesallee 100 38116 Braunschweig</td> </tr> </table> <p>The publication of extracts of the accreditation certificate is subject to the prior written approval by Deutsche Akkreditierungsstelle GmbH (DAkKS). Exempted is the unchanged form of separate disseminations of the cover sheet by the conformity assessment body mentioned overleaf.</p> <p>No impression shall be made that the accreditation also extends to fields beyond the scope of accreditation attested by DAkKS.</p> <p>The accreditation was granted pursuant to the Act on the Accreditation Body (AkkStelleG) of 31 July 2009 (Federal Law Gazette I p. 2625) and the Regulation (EC) No 765/2008 of the European Parliament and of the Council of 9 July 2008 setting out the requirements for accreditation and market surveillance relating to the marketing of products (Official Journal of the European Union L 218 of 9 July 2008, p. 30). DAkKS is a signatory to the Multilateral Agreements for Mutual Recognition of the European co-operation for Accreditation (EA), International Accreditation Forum (IAF) and International Laboratory Accreditation Cooperation (ILAC). The signatories to these agreements recognise each other's accreditations.</p> <p>The up-to-date state of membership can be retrieved from the following websites: EA: www.european-accreditation.org ILAC: www.ilac.org IAF: www.iaf.nu</p>	Office Berlin Spittelmarkt 10 10117 Berlin	Office Frankfurt am Main Europa-Allee 52 60327 Frankfurt am Main	Office Braunschweig Bundesallee 100 38116 Braunschweig
Office Berlin Spittelmarkt 10 10117 Berlin	Office Frankfurt am Main Europa-Allee 52 60327 Frankfurt am Main	Office Braunschweig Bundesallee 100 38116 Braunschweig		

Note: The current certificate annex is published on the websites (link see below).

<https://www.dakks.de/files/data/as/pdf/D-PL-12076-01-05e.pdf>

OR

https://ctcadvanced.com/app/uploads/2020/06/D-PL-12076-01-05_TCB_USA.pdf

END OF TEST REPORT