

# ingenico

**Link/2500**

**USER GUIDE**



# Contents

---

|   |           |
|---|-----------|
| <b>1. Introduction</b>                  | <b>3</b>  |
| <b>2. Presentation</b>                  | <b>5</b>  |
| 2.1. Content of the box                 | 5         |
| 2.1.1. Terminal                         | 5         |
| 2.2. Overview of the Link/2500          | 6         |
| 2.3. Keyboard details and functionality | 8         |
| <b>3. Use of the terminal</b>           | <b>9</b>  |
| 3.1. Switching off the terminal         | 9         |
| 3.2. Reading card                       | 9         |
| <b>4. Installation</b>                  | <b>11</b> |
| 4.1. Recommendations                    | 11        |
| 4.2. USB Terminal connections           | 12        |
| 4.2.1. uUSB                             | 12        |
| 4.3. Opening trap door                  | 12        |
| 4.4. SAMs & SIMs                        | 13        |
| 4.5. Battery                            | 14        |
| 4.5.1. Main characteristics             | 14        |
| 4.5.2. Installing the battery           | 14        |
| 4.5.3. Charging the battery             | 15        |
| 4.5.4. Changing the battery             | 16        |
| <b>5. Recommendations</b>               | <b>17</b> |
| 5.1. Safety                             | 17        |
| 5.2. Security of your terminal          | 18        |
| <b>6. Standards</b>                     | <b>19</b> |
| <b>7. Troubleshooting</b>               | <b>21</b> |

# 1. Introduction

---

We hope that you will be fully satisfied with your new terminal Link/2500. This terminal is available in different models. Please select by yourself in this documentation items related to your model.

Read this guide to understand and make the best use of your terminal. It presents you the necessary information about use, installation, maintenance, safety and security recommendations.



---

## **WARRANTY / SECURITY**

Use only the power supply included with the product to ensure best performance and safety. Maintenance should only be provided by Ingenico authorized technician. Failure to comply with these instructions will void the manufacturer's responsibility.

---



**This symbol indicates an important Warning.**

---



**This symbol indicates a piece of advice.**

---

---

Any Changes or modifications not expressly approved by the party responsible for compliance could void the user's authority to operate the equipment.

This device complies with part 15 of the FCC Rules. Operation is subject to the following two conditions: (1) This device may not cause harmful interference, and (2) this device must accept any interference received, including interference that may cause undesired operation.

This equipment complies with FCC radiation exposure limits set forth for an uncontrolled environment.

This transmitter must not be co-located or operating in conjunction with any other antenna or transmitter.



**Note:** This equipment has been tested and found to comply with the limits for a Class B digital device, pursuant to part 15 of the FCC Rules. These limits are designed to provide reasonable protection against harmful interference in a residential installation. This equipment generates uses and can radiate radio frequency energy and, if not installed and used in accordance with the instructions, may cause harmful interference to radio communications. However, there is no guarantee that interference will not occur in a particular installation. If this equipment does cause harmful interference to radio or television reception, which can be determined by turning the equipment off and on, the user is encouraged to try to correct the interference by one or more of the following measures:

- Reorient or relocate the receiving antenna.
- Increase the separation between the equipment and receiver.
- Connect the equipment into an outlet on a circuit different from that to which the receiver is connected.
- Consult the dealer or an experienced radio/TV technician for help.

---

SAR tests are conducted using standard operating positions accepted by FCC the with the device transmitting at its highest certified power level in all tested frequency bands. For hand-held operation, this device has been tested and meets the FCC RF exposure Guidelines when used with an accessory designated for this product or when used with an accessory that contains no metal. Non-compliance with the above restrictions may result in violation of RF exposure guidelines. For mobile exposure condition use, for satisfying RF exposure compliance, the device must be installed to provide a separate distance of at least 20 cm from all persons.

## 2. Presentation

---

### 2.1. Content of the box

---

#### 2.1.1. Terminal

Link/2500 terminal unit



A battery pack disconnected

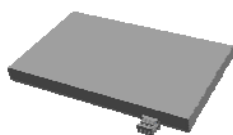

User guide



---

#### ADVICE

Keep the packaging. It must be re-used whenever the terminal is shipped.

---

## 2.2. Overview of the Link/2500

---



### Terminal unit

2"4 LCD Display



Magnetic card reader

Smart card reader

Compartment where are located:

- the battery pack
- the modules SAM1/SAM2/SIM1/SIM2
- the 2<sup>nd</sup> Smart card reader (optional)

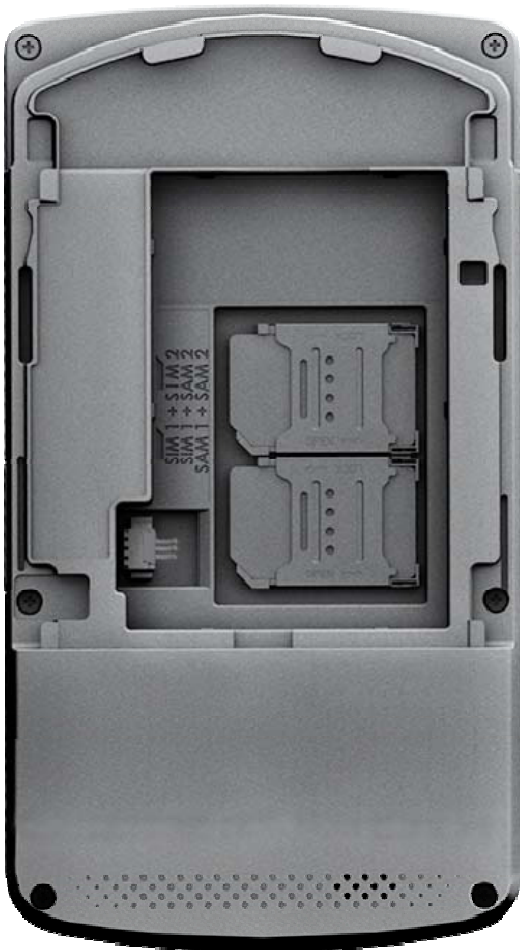

|  |  |
|--|--|
| Weight<br>(without paper roll nor battery) | 155g                                       |
| Dimensions (L x w x h)                     | 129x70x17 mm                               |
| Electrical mains network                   | 100-240VAC / 50-60 Hz - Class II equipment |
| Connections on terminal                    | Type C USB serial link<br>Power connector  |

### 2.3. Keyboard details and functionality

---



Some keys can have other functions according to the applications that are in the terminal.



The functions key accesses the different application menus

The red key cancels the procedure in progress

The yellow key cancels the last character

The green key validates input selections and information. It is also used to switch on the terminal



## 3. Use of the terminal

---



### ADVICE



Before to use the terminal, always check if the roll of paper is present.

---

### 3.1. Switching off the terminal

---

If the battery is empty and the terminal in use is removed from its base, the terminal automatically shuts off.

It may also be switch by pressing simultaneously  and  (yellow key) for one second.

In order to restart the terminal, press  on the keyboard.

### 3.2. Reading card

---

#### Magnetic stripe card

The card can be read either from bottom to top or from top to bottom, with the stripe facing the terminal.

Use a regular movement in order to ensure a reliable card reading.



### Smart card

- **Card reader:** insert the card horizontally with the chip facing upwards and leave in position throughout the transaction.



### Contactless

- Bring the card firmly up to the active zone. Keep the card close to the reader during the transaction
- The 4 virtual LEDs are displayed during the transaction.

The terminal behavior for the cardholder may depend on:

- The terminal environment
- Local usage (language...)



## 4. Installation

---

### 4.1. Recommendations

---

#### Location of the Link/2500

Place the base on flat surface near an electric socket and according to the base to the telephone or an Ethernet socket. The terminal should be placed far from any very hot zones, protected from vibrations, dust, damp and electromagnetic radiation (computer screen, anti-theft barrier etc.).

#### Operating conditions

|                       |                    |
|-----------------------|--------------------|
| Ambient temperature   | from +0°C to +50°C |
| Max relative humidity | 85% at +40°C       |

#### Battery charging conditions

|                     |                    |
|---------------------|--------------------|
| Ambient temperature | from +0°C to +40°C |
|---------------------|--------------------|

#### Storage conditions

|                       |                     |
|-----------------------|---------------------|
| Ambient temperature   | from -20°C to +55°C |
| Max relative humidity | 85% at +55°C        |

## 4.2. USB Terminal connections

---

### 4.2.1. uUSB

- There is an USB connector (USB type C) on the right side of the Link/2500 Wireless terminal (see below picture).
- The USB Key has to be used with an USB adapter (refers to accessories section)

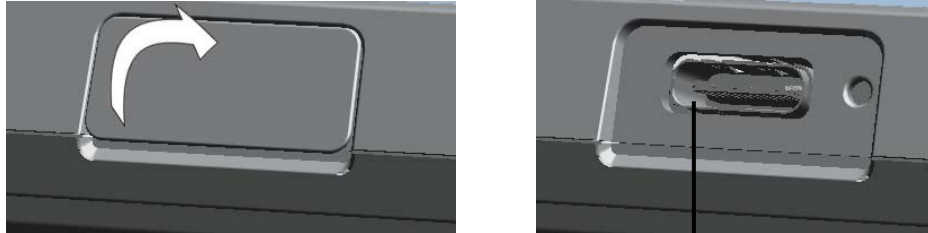

**USB type C**  
Connector used for PC travel  
charger, USB Key, etc...

*\*Type C connector durability: up to 10 000 mating cycles*

## 4.3. Opening trap door

---

### **CAUTION:**

Switch off the terminal before opening the trapdoor.

---

- Turn the terminal and unclip the trapdoor by pushing on the clip with as shown with the arrows on the picture



## 4.4. SAMs & SIMs

---

The connector modules security SAM/SIM is located inside the terminal, in a closed compartment.

- SAMs and SIMs are identified by the engraved marks on the lower housing
- When introducing a SAM/SIM in its slot, be sure to put the cut corner as indicated on the engraved marks

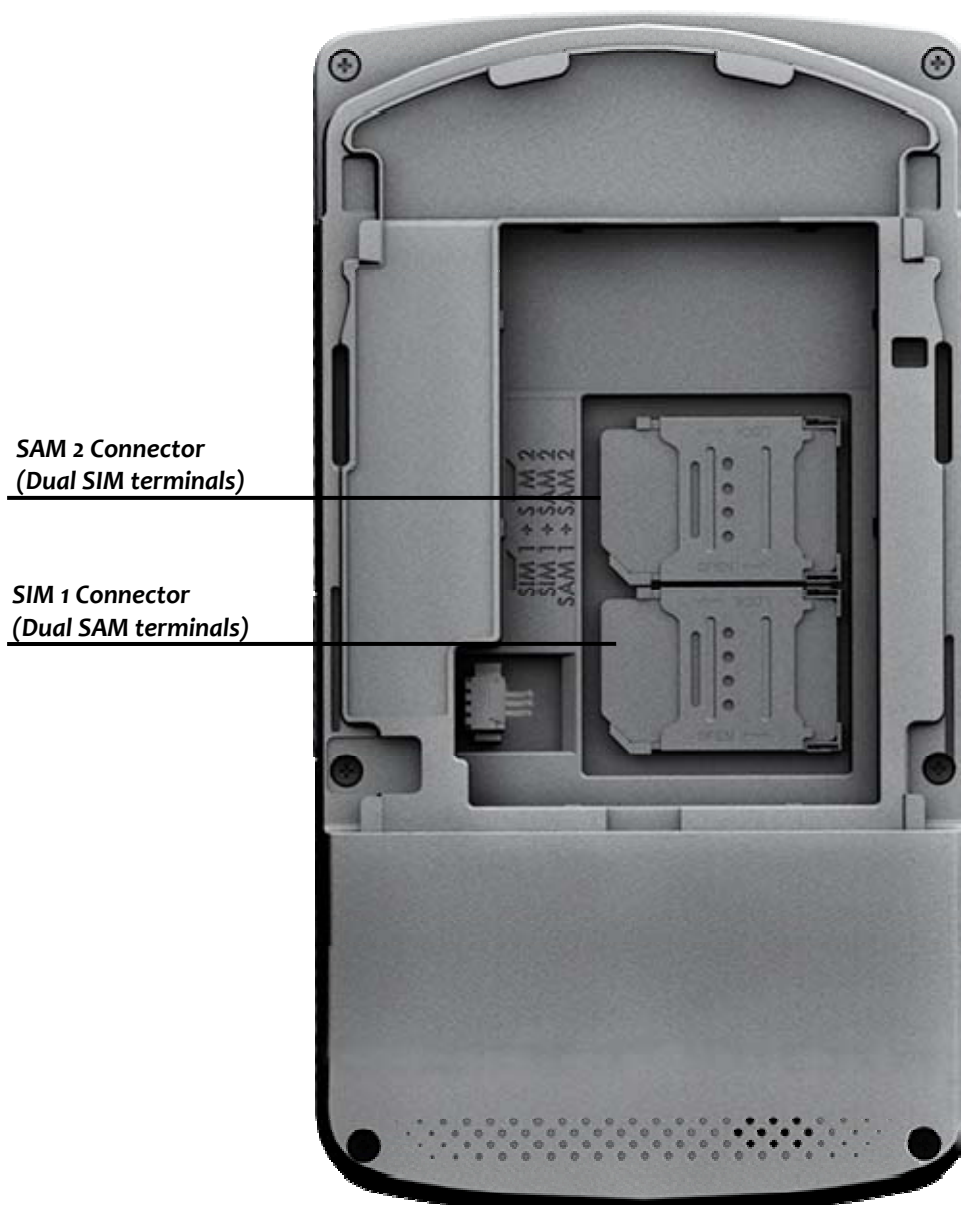

## 4.5. Battery

### 4.5.1. Main characteristics

|                            |  |
|----------------------------|--|
| Characteristics            | Li-ion 1200 mAh  |
| Charge (power supply-1.0A) | 50% capacity in 1,5 h; full capacity in 4 hours  |
| Battery life               | <ul style="list-style-type: none"><li>• 450 transactions in GPRS with fully charged battery, printing and backlit activated.</li><li>• Can remain powered ON up to 150 hours with connected GPRS link and terminal in sleeping state starting with fully charged battery and without energy consumption related to backlit or radio link</li></ul> |

\* The battery capacity depends on the model of terminal and its use

### 4.5.2. Installing the battery



#### WARNING

**Check that the terminal is not connected to the main electric network.**

- Turn your terminal and unclip the battery trapdoor by pushing on the button as shown on the picture
- Disengage the trapdoor
- Take the battery pack included in the box
- Locate the battery pack connector beside the battery compartment
- Plug the battery pack connector **according to the connector locating system and** (as shown on picture). Verify that it locks.
- Place the battery pack in its compartment.
- Close the battery compartment trapdoor.

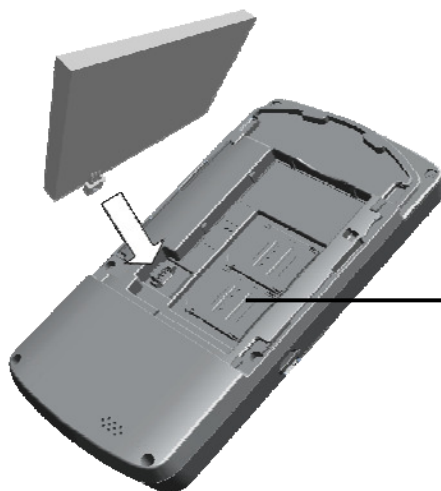

**Battery compartment**

### 4.5.3. Charging the battery

➤ *When does the battery need to be charged?*

- On initial start-up, charge the battery for 16 hours under the environmental conditions stated above
- When used daily, the terminal recharges its batteries each time it is placed on its base. Charging is automatic
- When used with a terminal power supply: connect the power supply to Link/2500 power connector.

➤ *How does the battery need to be charged?*

- The environment in which the charge takes place influences battery lifetime and autonomy (number of transactions)

The optimal conditions are as follows:

- Charging away from any external heat source (radiator, sun, enclosed area...)
- The optimal temperature is between +15°C and +25°C

➤ *How can the battery be charged?*

Using the terminal power supply



- Connect the terminal power supply unit to the terminal type C connector located on the right side of the terminal.
- Connect the power supply unit to the power supply mains network
- **Check to see if the battery symbol is flashing or moving(=battery charging)**

#### 4.5.4. Changing the battery



**It is imperative to use a battery authorized by Ingenico.**

**There is danger of explosion if battery used is not approved by Ingenico.**

- Turn it off by pressing simultaneously  and  (yellow key) for about one second
- Remove the battery trapdoor (see section 4.5.2 “installing battery”)
- Lift the battery and remove it from its compartment
- Carefully disconnect battery, following the instructions below.

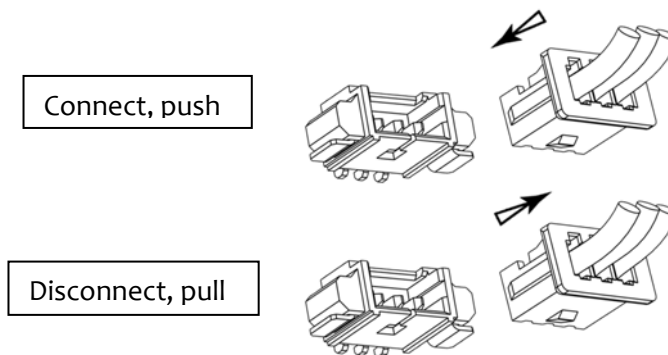

- Inform the terminal that battery will be replaced (\*). Do not start the terminal or connecting terminal power supply without battery.
- Connect and install the new battery by following the instructions in section 4.5.2 “Installing battery”
- Close the battery trapdoor and charge the new battery. See section "o “Charging the Battery”
- In order to preserve the environment, dispose used battery in compliance with current country recycling legislation.

(\*)The terminal memorizes that there is no battery simply by powering up. It will then correctly perform-full recharge with the next battery.



---

## 5. Recommendations

---

### 5.1. Safety

---

#### Powering down the Link/2500:

Disconnect the Link/2500 power supply block adapter from the electrical mains network.

#### Lithium cell

The Link/2500 is fitted with an internal **lithium cell** which can only be accessed by a qualified technician.

#### Battery

Link/2500 is fitted with battery specially designed for this terminal.

- Only use the appropriate chargers and batteries listed in the Ingenico's catalogue.
- Do not short-circuit the battery.
- Do not attempt to open the battery container.
- Used batteries must be disposed of at the appropriated sites.



#### Warning

There is a risk of explosion if the battery is incorrectly replaced or is placed in a fire.

---

#### SAM1/(SIM2)/SIM1(SAM2) readers' compartment

The trapdoor for battery, SAM1(SIM2)/SIM1(SAM2), readers located underneath the terminal, must be in place during the normal operation of the terminal. See sections "Removal of SAM1/SAM2/SIM, modules" as well as "Connecting the battery".

#### On airplanes

Your handset must be switched off by removing the battery pack. Remove the battery from the terminal when on an airplane.

Non-compliance with these safety rules may result in legal action and/or a ban on later access to cellular network services.

#### Explosion areas

Certain regulations restrict the use of radio equipment in chemical plants, fuel depots and any site where blasting is carried out. You are urged to comply with these regulations. The terminal shall be protected by a specially fitted and certified cover enabling use in proximity to a fuel pump.

#### Electronic health appliances

Your handset is a radio transmitter which may interfere with health appliances, such as hearing aids, pacemaker, hospital equipment, etc.

Your doctor or the equipment manufacturer will be able to provide you with appropriate advice.

## 5.2. Security of your terminal

---

Your device fulfils current applicable PCI PTS security requirements.

Upon receipt of your terminal you should check for signs of tampering of the equipment. It is strongly advised that these checks are performed regularly after receipt. You should check, for example: that the keypad is firmly in place; that there is no evidence of unusual wires that have been connected to any ports on your terminal or associated equipment, the chip card reader or any other part of your terminal. Such checks would provide warning of any unauthorised modifications to your terminal, and other suspicious behaviour of individuals that have access to your terminal. Your terminal detects any “tampered state”. In this state the terminal will repeatedly flash the message” Alert Irruption!” and further use of the terminal will not be possible. If you observe the “Alert Irruption!” message, you should contact the terminal helpdesk immediately.

You are strongly advised to ensure that privileged access to your terminal is only granted to staff that have been independently verified as being trustworthy.

The terminal must never be put in or left at a location where it could be stolen or replaced by another device.



### CAUTION

Positioning of the terminal on check stand must be in such a way to make cardholder PIN (Personal Identification Number) spying infeasible.

Installing device on an adjustable stand must be in such a way that consumers can swivel the terminal sideways and/or tilt it forwards/backwards to a position that makes visual observation of the PIN-entry process difficult.

Positioning of in-store security cameras such way that the PIN-entry keypad is not visible.

NEVER ask the customer to divulge their PIN Code. Customers should be advised to ensure that they are not being overlooked when entering their PIN Code.

## 6. Standards

### CE Mark

The CE marking indicates Link/2500 complies with the requirements of European Directive 1999/5/EC of 9 March 1999 on Radio and Telecommunications Terminal Equipment for:

- The protection of the health and the safety of the user and any other person.
- The protection requirements with respect to electromagnetic compatibility.

And complies with harmonised standards.

Depending Link/2500 model involved standards-are:

| EU Directives :                | According to harmonised EU standards : |                  |  |   |
|--------------------------------|--|------------------|--|---|
|                                | Product                                | Product Type     | Standards  | Issue date  |
| 1999/5/EC<br>(R&TTE Directive) | LinK/2500                              | All product type | EN 60950-1   | 2006 +/A11:2009<br>+/A1:2010<br>+/A12:2011<br>+/AC:2011<br>+ /A2:2013 |
|                                |  | ContactLess      | EN 302 291-1/2<br>EN 301 489-1<br>EN 301 489-3<br>ETSI EN 300 330-3                                      | 2005<br>2008<br>2002<br>2015  |
|                                |  | GSM/GPRS/UMTS    | EN 301 489-1<br>EN 301 489-7<br>EN 301 489-24<br>EN 301 511<br>EN 301 908-1<br>EN 301 908-2<br>EN 62 311 | 2008<br>2005<br>2007<br>2003<br>2010<br>2010<br>2008                  |
|                                |  | All product type | EN 50581   | 2012  |
| 2011/65/EU<br>(RoHS Directive) |  |                  |  |   |

\*Note: certification must be confirm after mass production.

## Environnement (WEEE, Batteries and Packaging)

This product is labeled in accordance with European Directives 2002/96/EC concerning Waste Electrical and Electronic Equipment (WEEE) and 2006/66/EC concerning Batteries and Accumulators. Those provisions are requiring producers and manufacturers to become liable for take-back, treatment and recycling upon end of life of equipment and batteries.



The associated symbol means that WEEE and waste batteries must not be thrown away but collected separately and recycled.

Ingenico ensures that efficient collection and recycling schemes are set-up for WEEE and batteries according to the local regulation of your country. Please contact your retailers for more detailed information about the compliance solution in place for disposing of your old product and used batteries.

Packaging waste must also be collected separately to assure a proper disposal and recycling.

Please note that proper recycling of the electrical and electronic equipment and waste batteries will ensure safety of human health and environment.

## 7. Troubleshooting

---

The terminal does not turn on

- Check the battery (is it discharged, is it connected?)  
*A full discharged battery can take long charging time to recover*
- Connect terminal to terminal power supply or put it on powered base

Cards are not read

- Check that the magnetic card is swiped correctly (with magnetic band on terminal side).
- Swipe again the card with the magnetic stripe movement constant and rapid
- Verify that the magnetic strip is not damaged, grooved or cracked
- Make sure you have inserted correctly the smart card into the smart card reader and removed the card only after the transaction is performed.

“This Document is Copyright © 2012 by INGENICO Group. INGENICO retains full copyright ownership, rights and protection in all material contained in this document. The recipient can receive this document on the condition that he will keep the document confidential and will not use its contents in any form or by any means, except as agreed beforehand, without the prior written permission of INGENICO. Moreover, nobody is authorized to place this document at the disposal of any third party without the prior written permission of INGENICO. If such permission is granted, it will be subject to the condition that the recipient ensures that any other recipient of this document, or information contained therein, is held responsible to INGENICO for the confidentiality of that information.

Care has been taken to ensure that the content of this document is as accurate as possible. INGENICO however declines any responsibility for inaccurate, incomplete or outdated information. The contents of this document may change from time to time without prior notice, and do not create, specify, modify or replace any new or prior contractual obligations agreed upon in writing between INGENICO and the user.

INGENICO is not responsible for any use of this device, which would be non consistent with the present document.

All trademarks used in this document remain the property of their rightful owners.”

Your contact

Ingenico  
28-32 Boulevard de Grenelle  
75015 Paris - France  
Tél. +33 (0)1 58 01 80 00 – Fax +33 (0)1 58 01 91 35  
[www.ingenico.com](http://www.ingenico.com)

\*296182111\*