

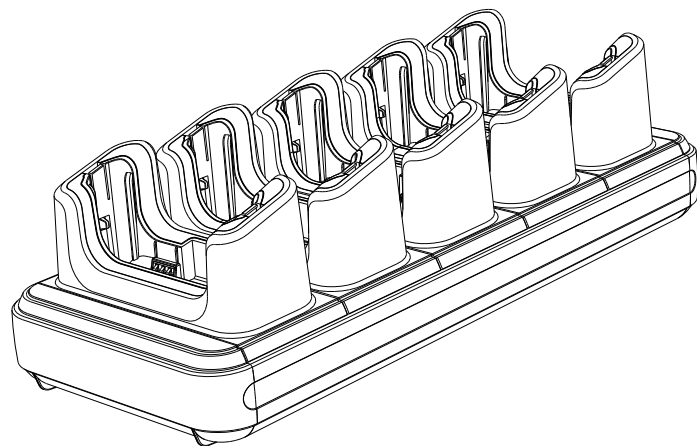

Model:AXIUM EX-MBASE-W1



User Guide

WWW.ingenico.com

28-32,boulevard de Grenelle, 75015 Paris - France/ (T)+33(0)1 58 01 80 00 / (F)+33 (0)1 58 01 91 35
Ingenico-SA au capital de 47 656 332 / 317 218 758 RCS Nanterre

Contents

1. Product Introduction	3
1.1 Open Package Inspection	3
1.2 Device Introduction	3
1.3 Interface definition.....	3
2. Product Technology Features	4
2.1 Product Technology Specifications	4
2.2 Environmental Conditions	4
2.3 Product Functions	5
2.4 Instructions	5
3. WiFi Connection.....	6
3.1 Connect EX pos to the base WiFi.....	6
3.2 Web Setting of base.....	6
3.3 Restore factory Setting	9
4. BASE Setting From EX pos	9
4.1 Get the Admin permission	9
4.2 Ethernet Parameter Setting.....	10
4.3 WLAN Parameter Setting	10
4.4 Advanced Setting	11
4.5 Operating Mode	11
4.5.1 Gateway Mode.....	11
4.5.2 Bridge Mode	12
4.5.3 WiFi Repeater Mode	12
4.6 Management Setting	12
6. FAQs	13
7. Notes	14
8. Delivery and Storage	14
9. Power Adapter	14
10. Standard	14

1. Product Introduction

1.1 Open Package Inspection

Open the package to check if there are any disabling masks or transportation damage in the terminals and fittings.

Procedures :

- 1) Open the package
- 2) Check the following items(Subject to actual product configuration)
 - Base host
 - User Guide
 - 12V/3.33 A power adapter
 - AC power cable
 - USB type-B cable
 - 5 AXIUM EX8000 Bushings
 - 5 AXIUM EX6000 Bushings
- 3) Save the transportation package and packing material for second use.

1.2 Device Introduction

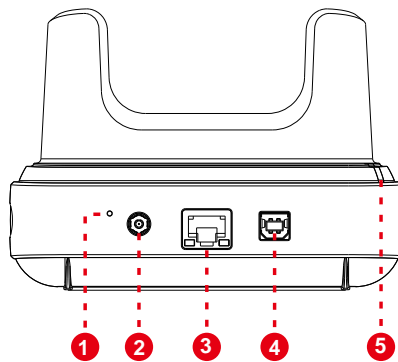

- 1.Reset Button
2. DC JACK Power Interface
- 3.RJ45 Network Interface
4. USB-TYPE B
5. Power LED

1.3 Interface definition

- 1) RJ45 interface

Sequence	RJ45Signal
1	ETH_TX+
2	ETH_TX-
3	ETH_RX+
4	NC
5	NC

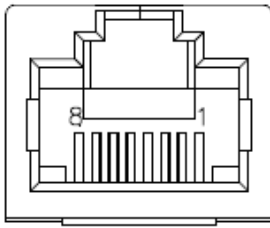

6	ETH_RX-
7	NC
8	NC

2) USB-TYPE B interface

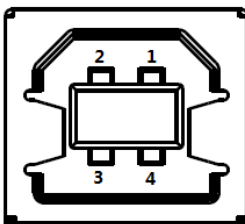

Sequence	USB-TYPE B Signal
1	Not connect
2	D-
3	D+
4	GND

2. Product Technology Features

2.1 Product Technology Specifications

Port	a DC JACK power port a RJ45 network port a USB B DEVICE port supporting USB2.0
Power	Every Charge output: 5.0VDC 1.0A Power adapter: input 100-240V AC, 50/60Hz; output 12.0V DC 3.33A
Size and Weight	Size : 311mmx127.8mmx91mm Net Weight : 0.76kg Gross Weight : 1.50kg

2.2 Environmental Conditions

Environmental conditions for running, storing and delivering the product :

Temperature	Running	0°C ~ 40°C
	Storage and Delivery	-20°C ~ 70°C
Humidity	Running	10% ~ 90%
	Storage and Delivery	5% ~ 90% (40°C)

2.3 Product Functions

The base has three main functions as below:

- Place EX pos on the base to get charged.
- Place EX pos on the base. Connect the USB type-B to computer to extend the USB port.
- Serves as a router. EX pos can connect to the base via WiFi to extend the network.

2.4 Instructions

- If AXIUM EX pos has the shell , we can place it on the base directly.

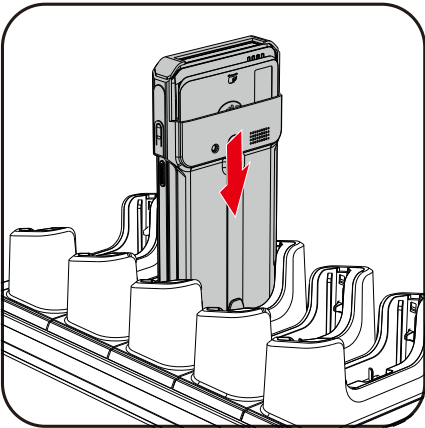

- If AXIUM EX pos does not have the shell , we must check the AXIUM EX pos is EX8000 or EX6000.
- If AXIUM EX pos is EX8000, we find the EX8000 bushings and put them in the base. After that, we can put EX8000 pos on the base.
- If AXIUM EX pos is EX6000, we find the EX6000 bushings and put them in the base. After that, we can put EX6000 pos on the base.
- The bushings can be recognized from the color and words in the bushings.
- The color of EX8000 bushings is black C.
- The color of EX6000 bushings is cool grey.

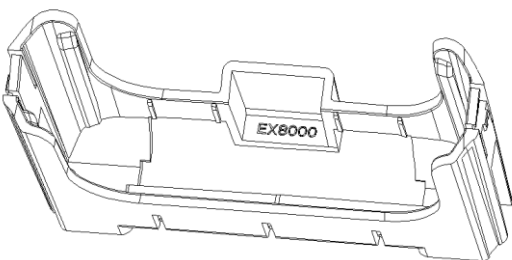

3. WiFi Connection

3.1 Connect EX pos to the base WiFi

- Power on the base.
- Check the SSID and password from the label on the back of base.
- Click “Settings” menu on EX pos, and then click “Network and Internet”, enter “ Wi-Fi” and select the base SSID to connect.(step 1~4)
 - ✧ (WiFi Password please refer to the rear label for details)
- After that , EX pos can use the RJ45 network of the base.

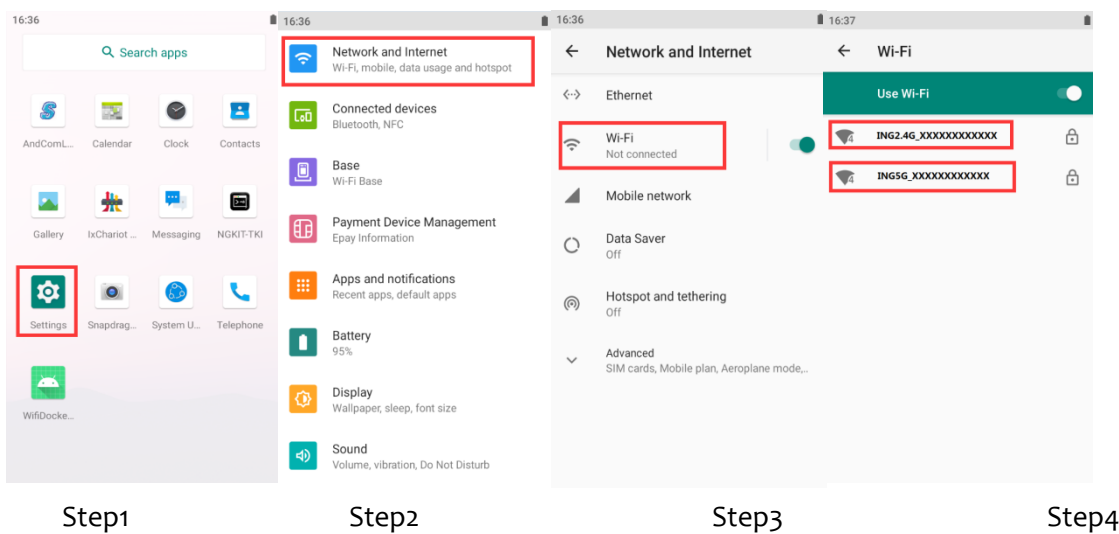

3.2 Web Setting of base

The base can be set from the web.

- Use a computer to connect the base via WiFi.
- The web setting IP of base is 192.168.47.1. Login name is Admin. Password is the Pairing Password.
 - ✧ (Pairing Password please refer to the rear label for details)
- User can get the status of base on the status page.

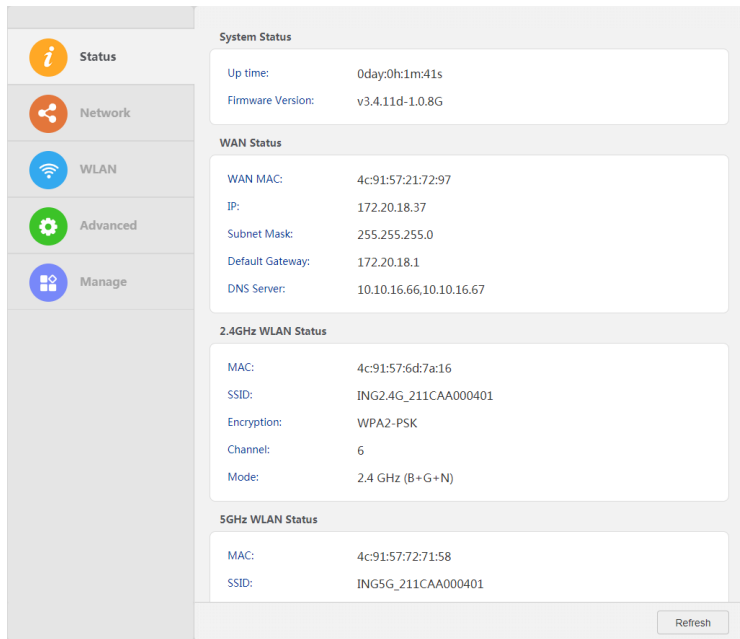

- User can get and change the Ethernet parameter on the Network page.

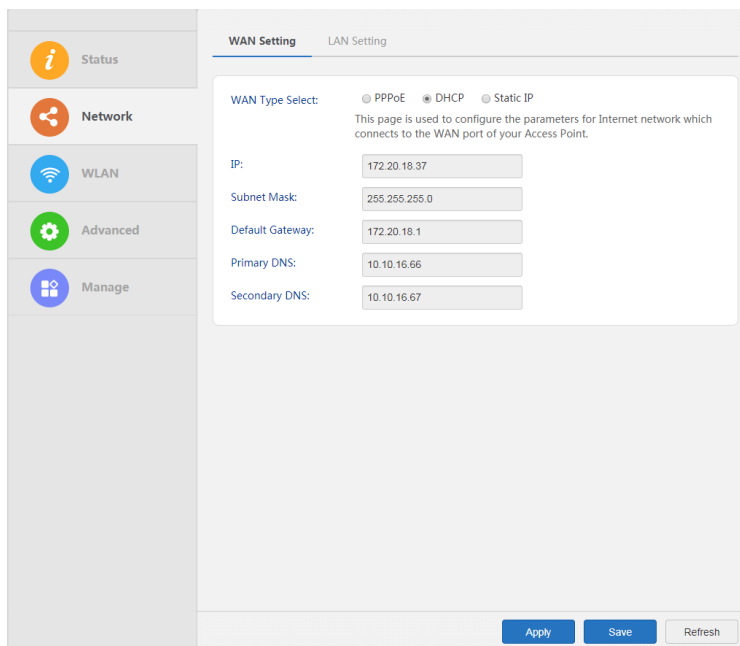

- User can get and change the WLAN parameter on the WLAN page.

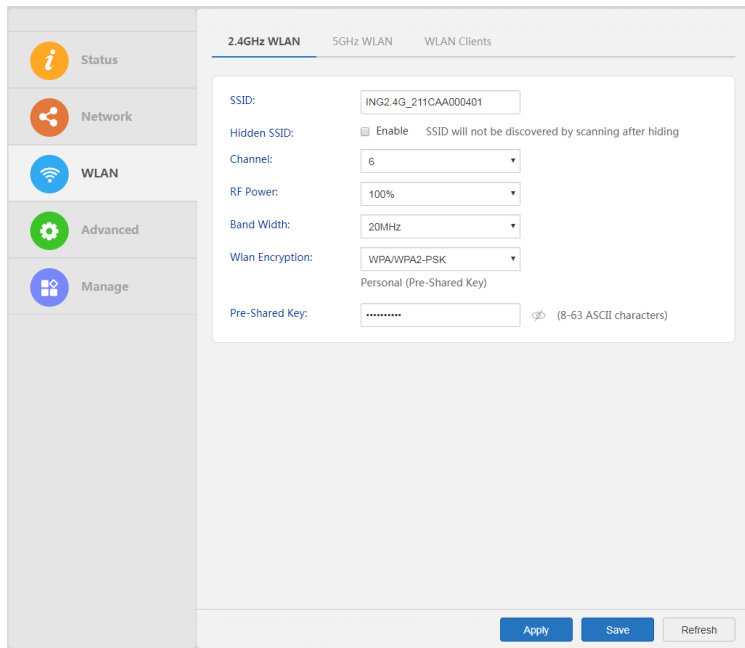

- User can change the operating mode, enable DMZ or set static DHCP on the Advanced page.

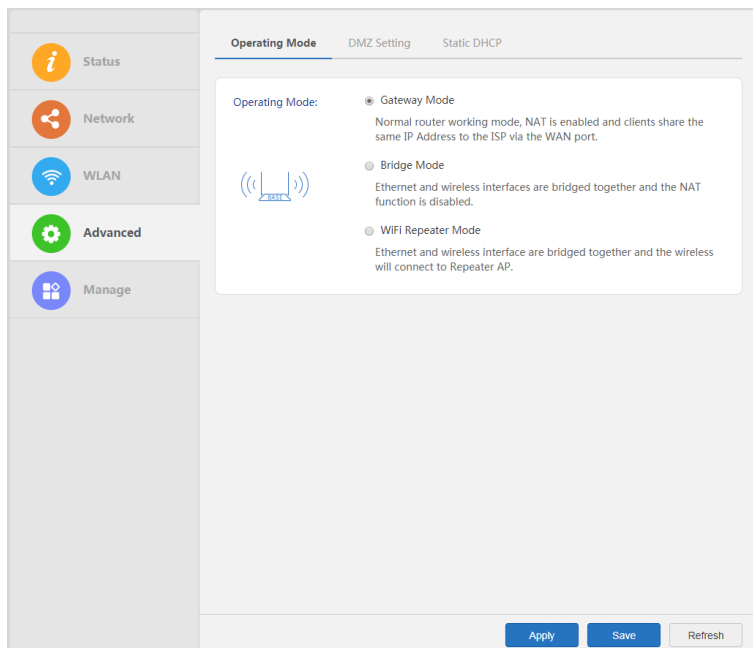

- User can update the firmware of base, save and reload the settings, change the password on the Manage page.

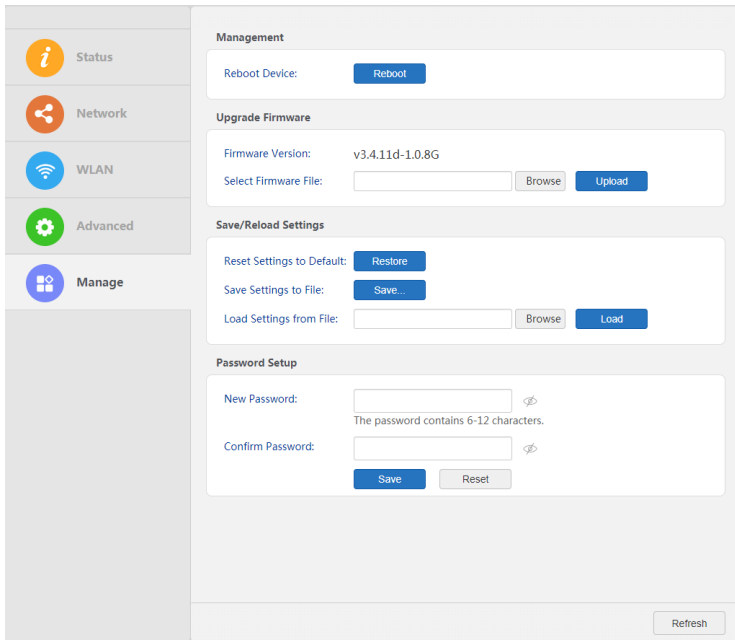

3.3 Restore factory Setting

- Use sharp to click the RESET button for 3 seconds to restore the factory setting of the base.
- The position of RESET button is in chapter 1.2.

4. BASE Setting From EX pos

4.1 Get the Admin permission

- First, connect EX pos to the base via chapter 3.1.
- Click “Settings” menu on EX pos, and then click “Base”, input the Pairing Password [Step1].
 - ✧ (Pairing Password please refer to the rear label for details)
- Click the grey button beside the SSID “ING2.4G_XXXXXX” [Step2].
- After that, we can check the Version of base in the menu. [Step3].

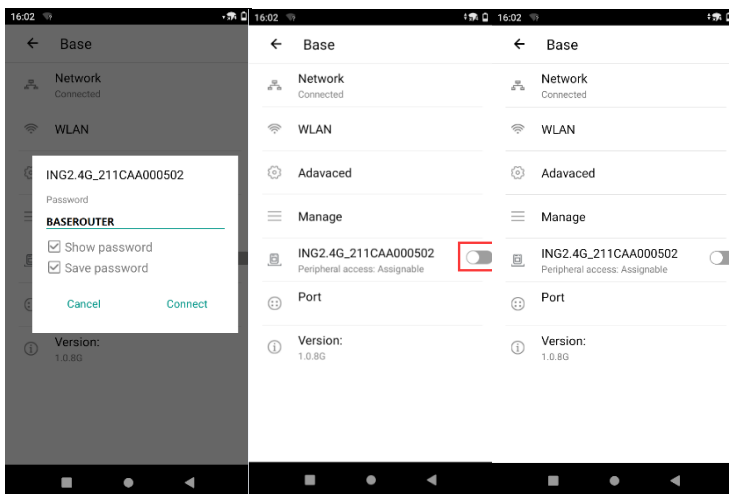

Step1

Step2 Step3

4.2 Ethernet Parameter Setting

Procedures:

- Tab on “Network” enter WAN Setting or LAN Setting menu.
- Enter WAN Setting to get and set the WAN parameter.
- Enter LAN Setting to get and set the LAN parameter.

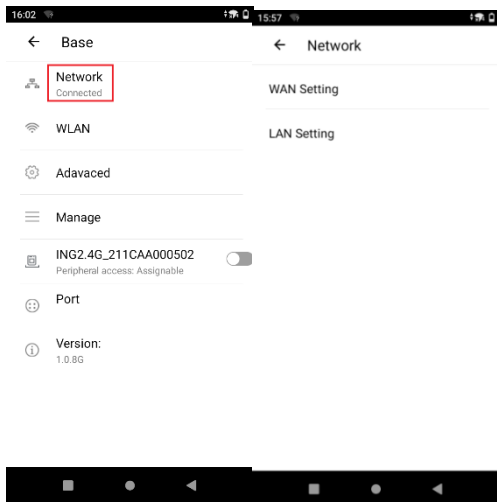

Step 1 Step 2

4.3 WLAN Parameter Setting

- Enter WLAN menu.[Step1]
- We can click “2.4GHz WLAN” to set 2.4G parameter and click “5GHz WLAN” to set 5GHz WLAN.[Step2]
- We can set channel,RF power,band width and get WLAN MAC on the menu.[Step3,4]

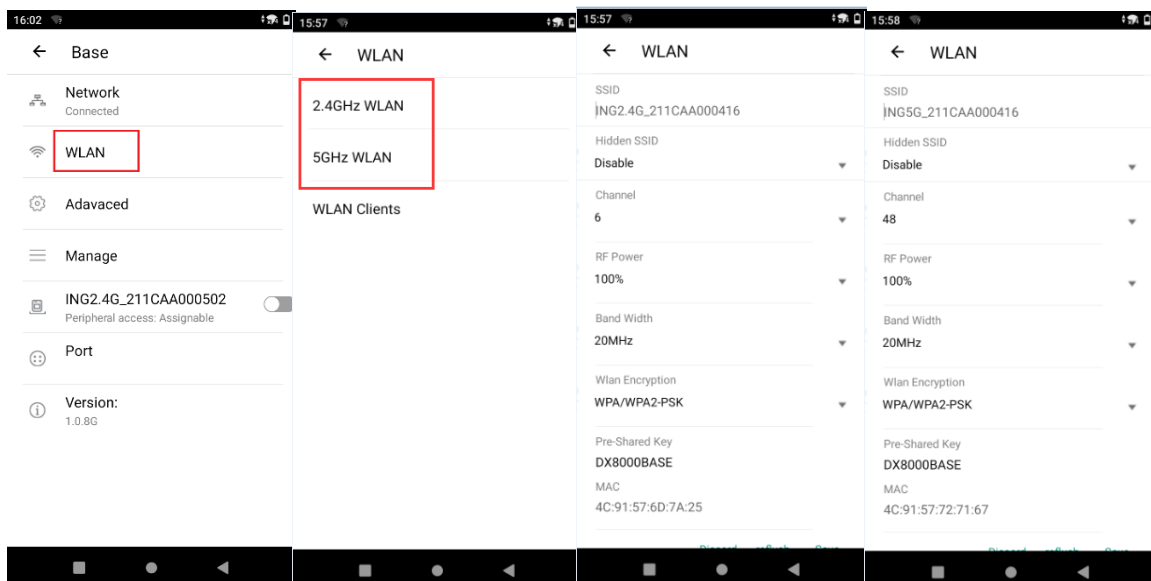

Step 1

Step 2

Step 3

Step 4

4.4 Advanced Setting

- Enter advanced menu.
- We can set the operating mode, DMZ and static DHCP of the base [Chart 1].
- In operating mode, we can set the base work in different mode [Chart 2].
- We can set DMZ [Chart 3] and add static DHCP [Chart 4].

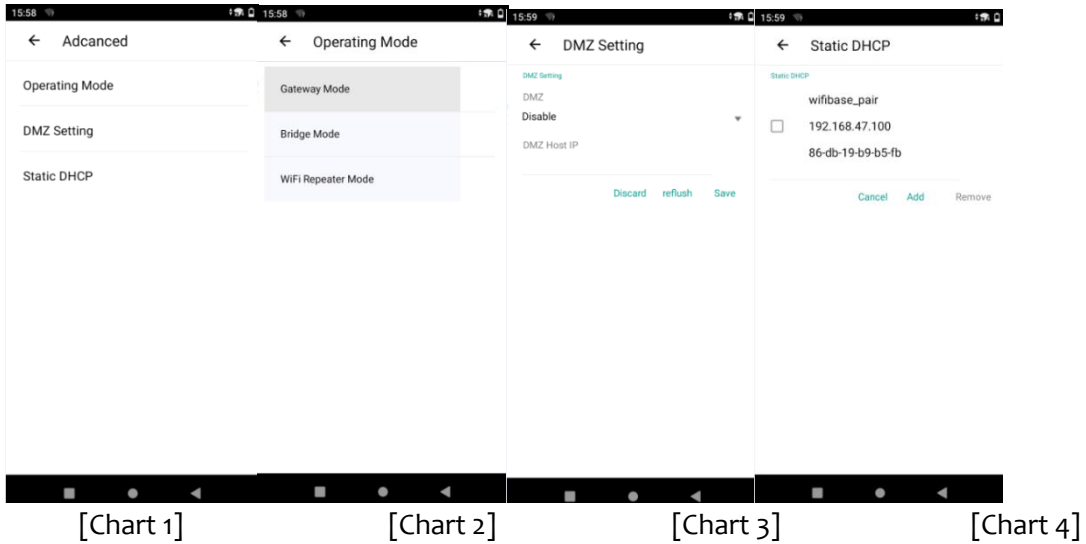

4.5 Operating Mode

4.5.1 Gateway Mode

- ADSL/ONU distribute the IP to base ETH port.
- Base distribute the IP to EX pos
- ADSL/ONU and EX pos are not in the same network segment.



4.5.2 Bridge Mode

- Base distribute the IP to the computer and EX pos.
- They are in the same network segment .

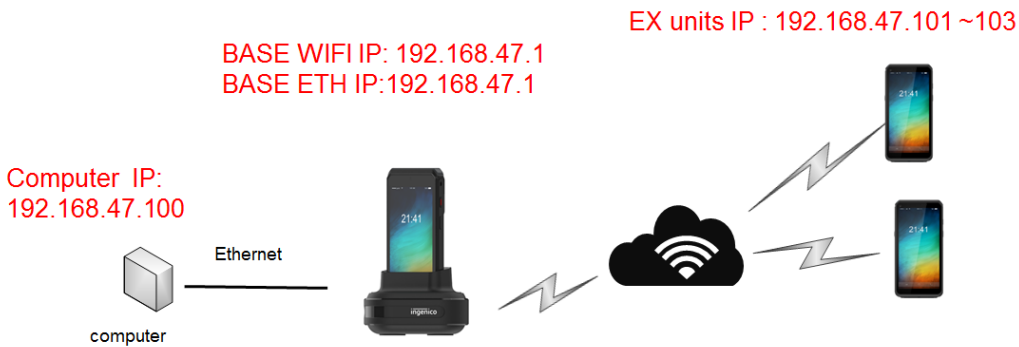

4.5.3 WiFi Repeater Mode

- It is a mode to expand coverage of base.
- For example , Ex pos is too far away to connect Base A. So we can put Base B between Base A and EX pos.
- Set Base B to repeat the Base A. EX pos can connect to internet via Base B.

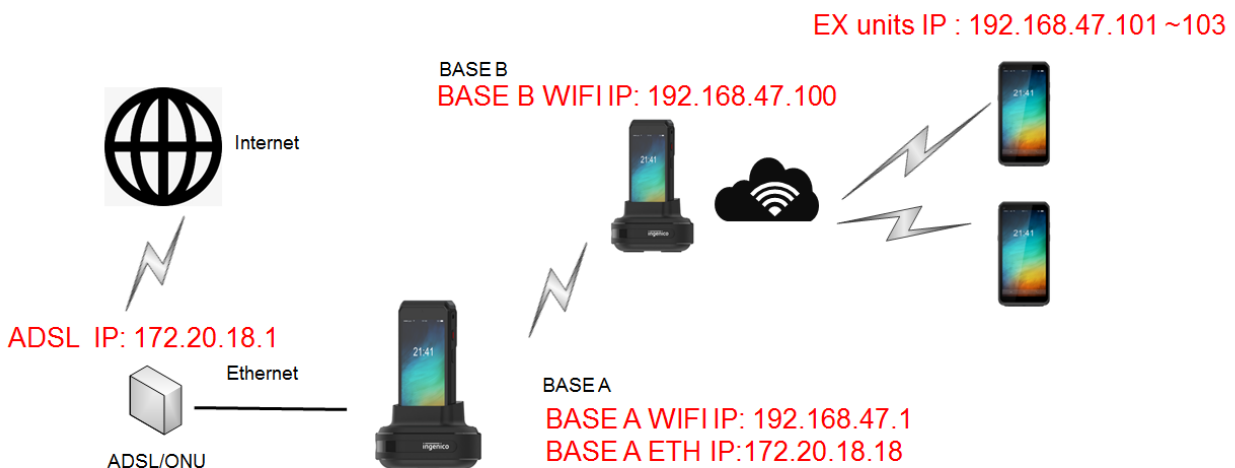

4.6 Management Setting

- In management menu, we can upgrade the firmware of base.

- First,we use software manager to install the wifidockfirmware.apk in EX pos,as follow :

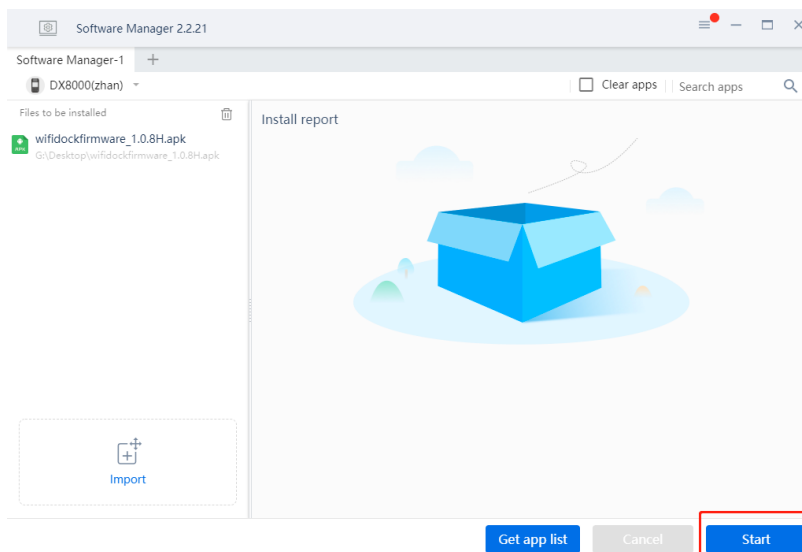

- Second,we get the Admin permission of the base with EX pos via chapter 4.1.Wait for upgrading.[Step1].And get the successful tips[Step2]. Check the version of the base[Step3].

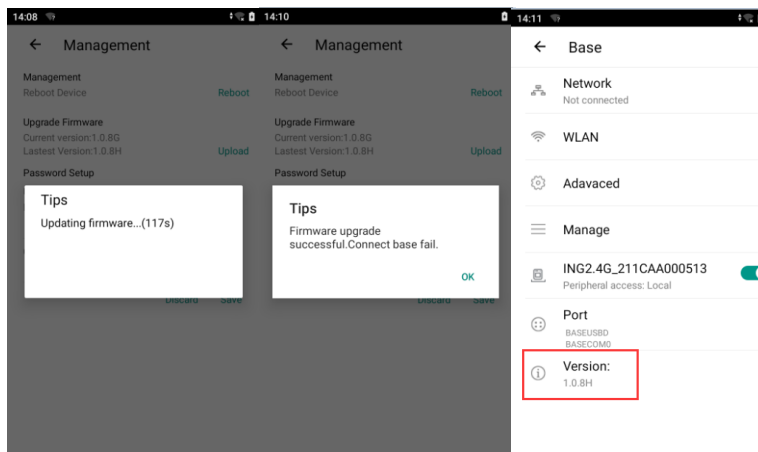

[Step1][Step2][Step3]

6. FAQs

Q1: The base fails to connect EX pos.

- Cause1: EX pos WLAN is not yet opened.
- Solution: Open WLAN via the drop-down box of EX pos.
- Cause 2: EX pos is placed too far away from base.
- Solution: Place and connect the devices within 20 meters.
- Cause 3: The password of EX posbase is changed .
- Solution: Input the correct password ,or restore factory setting to get the default password.

Q2: Why mobile phone can not search the 5G WiFi?

- Solution: Check whether mobile phone can support 5G WiFi.

7. Notes

- ✧ Prevent the terminal from sun exposure, high temperature, moisture and other mean conditions.
- ✧ Cut off the power before cleaning the device and wipe the main body with dry cloth.
- ✧ When the following abnormal phenomena occur, stop running the device immediately, cut off the power supply, and report to the service provider as soon as possible:
 - 1) harsh noise heard during operation.
 - 2) impurities or water found in the machine.
 - 3) Unpleasant smell found during operation.

8. Delivery and Storage

Deliver the device in normal way, avoiding rain and snow, sun exposure and mechanical impact. The product should be stored in the original box. The box should be at least 15cm away from the floor, at least 50cm from the wall, heat source, cold source, window or air inlet.

9. Power Adapter

The base can only be connected to the adapter which is provided with AXIUM EX-MBASE-W1.

WARNING

The power adapter provided is specially designed for ingenico AXIUM EX-MBASE-W1. Do not use any other power supply. The use of a power supply with apparently similar voltage/current characteristics may damage your terminal.

ATTENTION

L'adaptateur secteur fourni est spécialement conçu pour l'ingenico AXIUM EX-MBASE-W1. N'utilisez aucun autre bloc d'alimentation. L'utilisation d'une alimentation avec des caractéristiques de tension / courant apparemment similaires peut endommager votre terminal.

10. Standard

FCC WARNING

This device complies with part 15 of the FCC Rules. Operation is subject to the following two conditions:

- (1) This device may not cause harmful interference, and
- (2) this device must accept any interference received, including interference that may cause undesired operation.

Any Changes or modifications not expressly approved by the party responsible for compliance could void the user's authority to operate the equipment

The antennas used for this transmitter must be co-located or operating in conjunction with any other antenna or transmitter.

RF exposure

The antenna of the product, under normal use condition is at least 20cm away from the body of the user. Warning statement to the user for keeping 20cm separation distance and the prohibition of operating to a person has been printed on the user manual. So, this product under normal use is located on electromagnetic far field between the human body.

Note: This equipment has been tested and found to comply with the limits for a Class B digital device, pursuant to part 15 of the FCC Rules. These limits are designed to provide reasonable protection against harmful interference in a residential installation. This equipment generates, uses and can radiate radio frequency energy and, if not installed and used in accordance with the instructions, may cause harmful interference to radio communications. However, there is no guarantee that interference will not occur in a particular installation. If this equipment does cause harmful interference to radio or television reception, which can be determined by turning the equipment off and on, the user is encouraged to try to correct the interference by one or more of the following measures:

- Reorient or relocate the receiving antenna.
- Increase the separation between the equipment and receiver.
- Connect the equipment into an outlet on a circuit different from that to which the receiver is connected.
- Consult the dealer or an experienced radio/TV technician for help.

ISED/C WARNING

This device complies with Innovation, Science and Economic Development Canada license - exempt RSS standard (s). Operation is subject to the following two conditions:

- (1) this device may not cause interference, and
- (2) this device must accept any interference, including interference that may cause undesired operation of the device.

Le présent appareil est conforme aux CNR d'ISED applicables aux appareils radio exempts de licence.

L'exploitation est autorisée aux deux conditions suivantes:

- (1) l'appareil ne doit pas produire de brouillage, et (2) l'utilisateur de l'appareil doit accepter tout brouillage radioélectrique subi, même si le brouillage est susceptible d'en compromettre le fonctionnement.

RF exposure

The antenna of the product, under normal use condition is at least 20cm away from the body of the user. Warning statement to the user for keeping 20cm separation distance and the prohibition of operating to a person has been printed on the user manual. So, this product under normal use is located on electromagnetic far field between the human body.

Exposition aux RF

L'antenne du produit, dans des conditions normales d'utilisation, est à au moins 20 cm du corps de l'utilisateur. Une déclaration d'avertissement à l'utilisateur pour maintenir une distance de séparation de 20 cm et l'interdiction d'opérer à une personne a été imprimée sur le manuel de l'utilisateur. Ainsi, ce produit en utilisation normale est localisé sur un champ électromagnétique éloigné entre le corps humain.

In accordance with the Innovation Regulations, Science and Canada Economic Development, this radio transmitter may operate with an antenna of a type and maximum (or lower) gain approved for the transmitter by Industry Canada. In order to reduce the risk of radio interference to other users, the antenna type and its gain must be chosen so that the equivalent isotropically radiated power (e.i.r.p) does not exceed the intensity required by the antenna establishing a satisfactory communication.

5GHz Wifi should be used indoor only.

Le Wifi 5 GHz doit être utilisé à l'intérieur uniquement

Environment (WEEE, Batteries and packaging)

This product is labeled in accordance with European Directives 2012/19/EU concerning Waste Electrical and Electronic Equipment (WEEE) and 2013/56/EU concerning Batteries and Accumulators. Those provisions are requiring producers and manufacturers to become liable for take-back, treatment and recycling upon end of life of equipment and batteries.

THE PRODUCT



The crossed-out waste bin stuck on the product or its accessories means that the product belongs to the family of electrical and electronic equipment, and waste batteries must not be thrown away but collected separately and recycled.

Please contact your retailers for more detailed information about the compliance solution in place for disposing of your old product and used batteries.

Packaging waste must also be collected separately to assure a proper disposal and recycling.

In this way you can participate in the re-use and upgrading of Electrical and Electronic Equipment Waste, which can have an effect on the environment and human health.

This Document is Copyright © 2021 by ingenico Group. ingenico retains full copyright ownership, rights and protection in all material contained in this document. The recipient can receive this document on the condition that he will keep the document confidential and will not use its contents in any form or by any means, except as agreed beforehand, without the prior written permission of ingenico. Moreover,

nobody is authorized to place this document at the disposal of any third party without the prior written permission of ingenico. If such permission is granted, it will be subject to the condition that the recipient ensures that any other recipient of this document, or information contained therein, is held responsible to ingenico for the confidentiality of that information.

Care has been taken to ensure that the content of this document is as accurate as possible. ingenico however declines any responsibility for inaccurate, incomplete or outdated information. The contents of this document may change from time to time without prior notice, and do not create, specify, modify or replace any new or prior contractual obligations agreed upon in writing between ingenico and the user.

ingenico is not responsible for any use of this device, which would be non-consistent with the present document.

All trademarks used in this document remain the property of their rightful owners.

WWW.ingenico.com

28-32,boulevard de Grenelle, 75015 Paris - France/ (T)+33(0)1 58 01 80 00 / (F)+33 (0)1 58 01 91 35
Ingenico-SA au capital de 47 656 332 / 317 218 758 RCS Nanterre