



福州中天迅通信技术有限公司

Fuzhou ZHONGTIANXUN Communication Technology Co., Ltd

项目名称(Project Name): DX4000-WIFI/BT/GPS

天线型号(Antenna model): ZTX-DX4000-W/B/G-ANT

A

物料编码(Item number): E.03.00758

MPN 码 (MPN) : B0680319D

日期 (Date) : 2022-10-19

设计公司: 福州中天迅通信技术有限公司

Design company: Fuzhou zhongtianxxun communication technology Co., Ltd

设计人员: 谢恩元

Designer: Enyuan xie

电 话: 18718685346

Tel: 18718685346

测试人员: 谢恩元

Tester: Enyuan xie

电 话: 18718685346

Tel: 18718685346



福州中天迅通信技术有限公司

Fuzhou ZHONGTIANXUN Communication Technology Co., Ltd



版本 version	日期 date	状态 status
A1	2022-7-28	规格书制定。 First issue.
A2	2022-8-12	增加性能数据，更新结构图纸。 Add performance data and update structural drawings.
A3	2022-9-22	油墨颜色更改为绿色。 The color of the ink is changed to green.
A4	2022-10-19	FPC 线路更新；性能数据更新。 The FPC is updated; Performance data update.





## 目 录 (Catalog)

1. 名词解释 (Explanation of Nouns) .....	4
2. 测试设备 (Test equipment) .....	4
3. 适用频段 (Applied frequency band) .....	4
4. 测试指标和数据图表 (Test project) .....	5~9
4.1 驻波图 (VSWR) .....	5
4.2 无源效率 (Antenna passive test) .....	6~7
4.3 有源数据 (Active test data) .....	8
4.4 2D 方向图 (2D directional diagram) .....	9~10
4.5 3D 方向图 (3D directional diagram) .....	11
4.6 装配图 (Environment treatment) .....	12
5. 阻抗匹配要求 (Matching circuit) .....	13
6. 天线外形图 (Mechanical Specification) .....	14
7. 包装作业指导 (The packing way) .....	15~16







## 4. 测试指标和数据图表 (Test project)

### 4.1 驻波图 (VSWR)

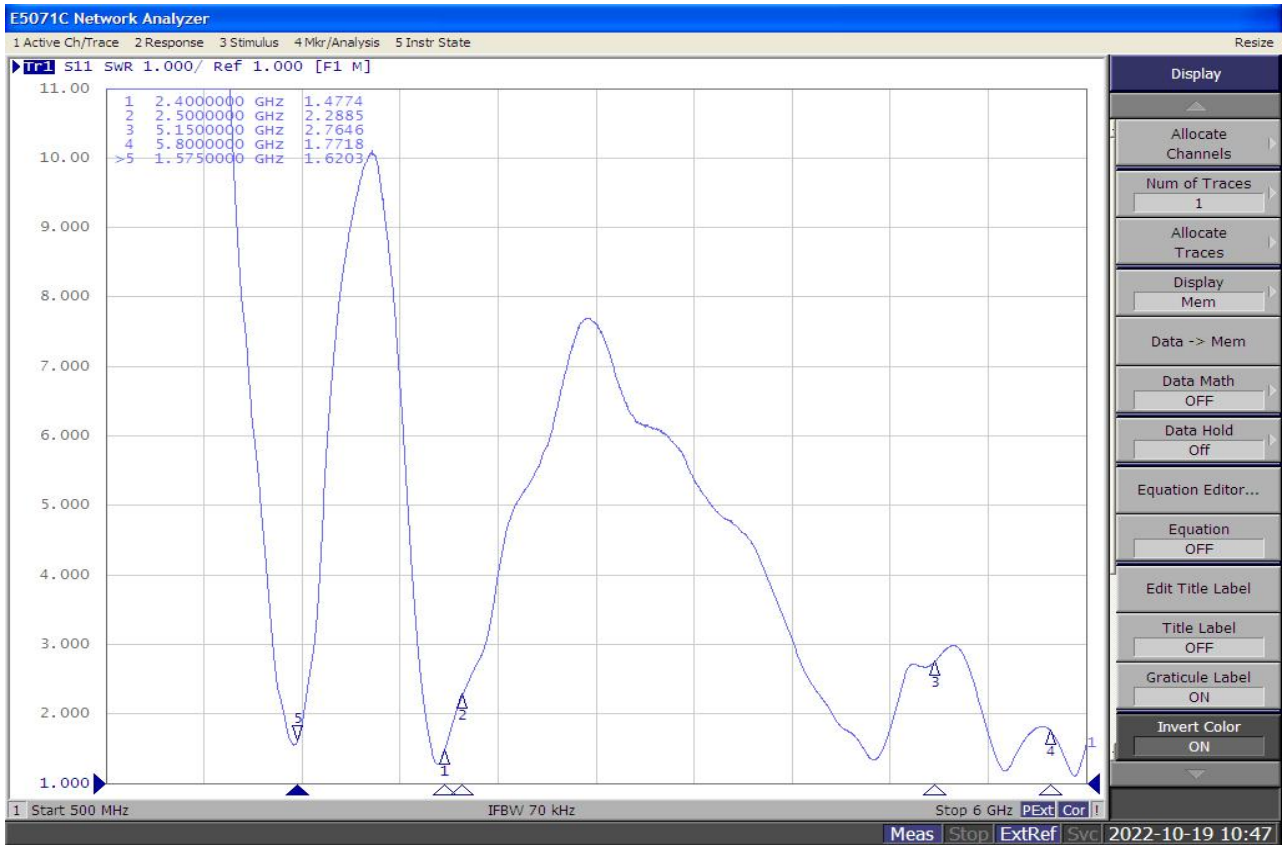



4.2 无源效率 (Antenna passive test)

chNo	Freq	Gain	Efficiency_Pcent
1	1550	1.431809345	53.35490673
2	1555	1.368862074	53.23531227
3	1560	1.18064628	53.00547856
4	1565	0.972934752	52.35116369
5	1570	0.739833284	50.83419291
6	1575	0.477347165	49.30307792
7	1580	0.251883813	46.93301559
8	1585	0.174571983	44.95622102
9	1590	0.080563822	43.82757802
10	1595	0.115434259	43.39184203
11	1600	0.47080072	48.52431942
12	2400	3.660512	52.93266384
13	2410	3.646782075	53.92010142
14	2420	3.596783807	53.89005567
15	2430	3.209762402	51.66125355
16	2440	2.803878145	48.12362952
17	2450	2.59793305	47.55840247
18	2460	2.221151777	46.02688385
19	2470	2.222397655	45.58263822





福州中天迅通信技术有限公司

Fuzhou ZHONGTIANXUN Communication Technology Co., Ltd

20	2480	1.995242846	42.51399035
21	2490	1.698865397	40.16907549
22	2500	1.663540342	40.21044804
23	5150	-0.947226739	20.46196298
24	5190	-2.217612891	20.78553552
25	5230	-1.466630181	21.10360283
26	5270	-2.375193704	20.45997934
27	5310	-2.204328098	21.76028288
28	5350	-1.462196818	26.95693371
29	5390	-1.764997283	22.8739593
30	5430	-2.093954961	21.74340176
31	5470	-2.632565511	24.74699225
32	5510	-3.204410401	22.40633843
33	5550	-3.267575609	24.54885197
34	5590	-2.608698508	25.89377454
35	5630	-3.482268771	22.72785678
36	5670	-2.246035769	27.32758689
37	5710	-2.877752023	23.3947757
38	5750	-2.292719632	19.34308241
39	5790	-2.559914543	20.97133168
40	5830	-2.129948303	22.18224728
41	5850	-2.810204816	21.06226567



福州中天迅通信技术有限公司

Fuzhou ZHONGTIANXUN Communication Technology Co., Ltd



4.3 有源数据 (Active test data)

频段	参数\信道	1	6	11
WIFI-11B	TRP	12.98	13.24	13.65
	TIS	-76.52	-77.18	-76.73
频段	参数\信道	1	6	11
WIFI-11G	TRP	11.99	12.47	12.75
	TIS	-65.35	-65.67	-65.74
频段	参数\信道	1	6	11
WIFI-11GN	TRP	11.41	12.12	12.36
	TIS	-62.29	-62.75	-62.74







4.4 2D 方向图 (2D directional diagram)

1575MHz

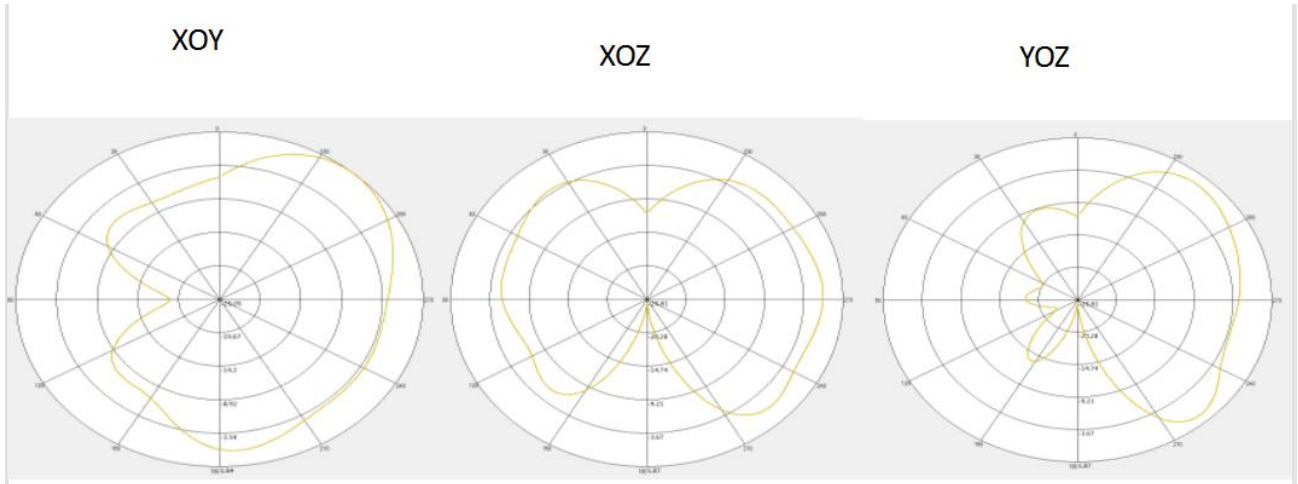

2450MHz

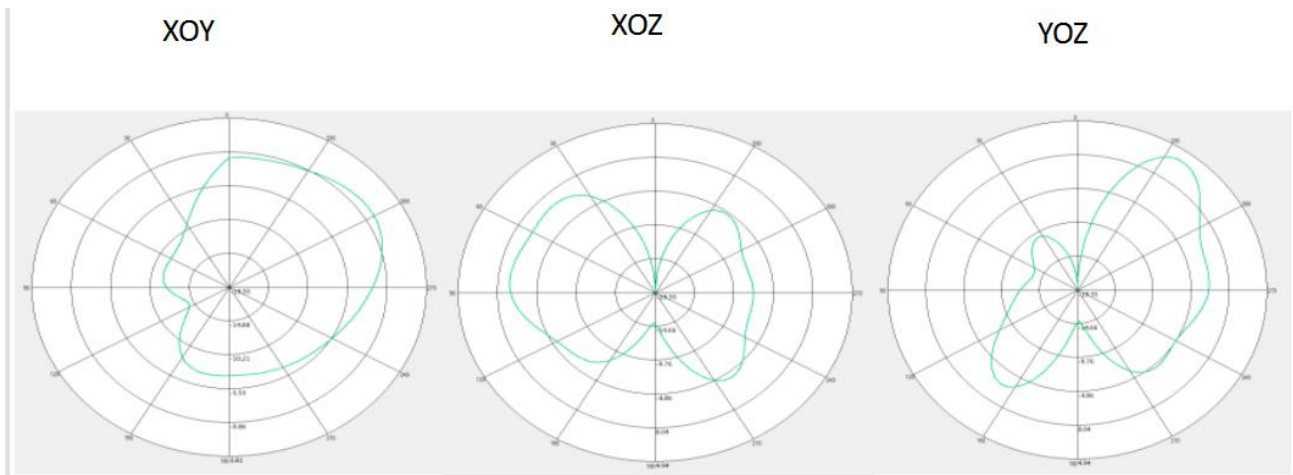



福州中天迅通信技术有限公司

Fuzhou ZHONGTIANXUN Communication Technology Co., Ltd

5510MHz

XOY

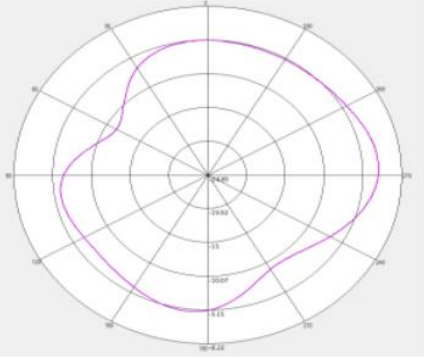

XOZ

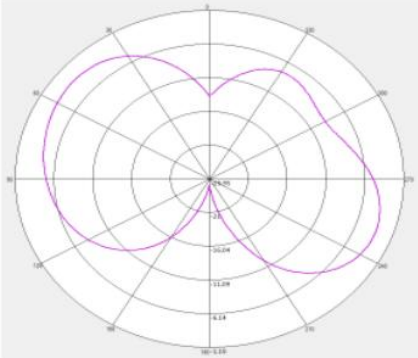

YOZ

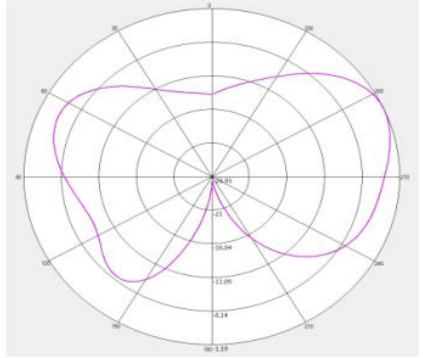

福州中天迅通信技术有限公司

Fuzhou ZHONGTIANXUN Communication Technology Co., Ltd



4.5 3D 方向图 (3D directional diagram)

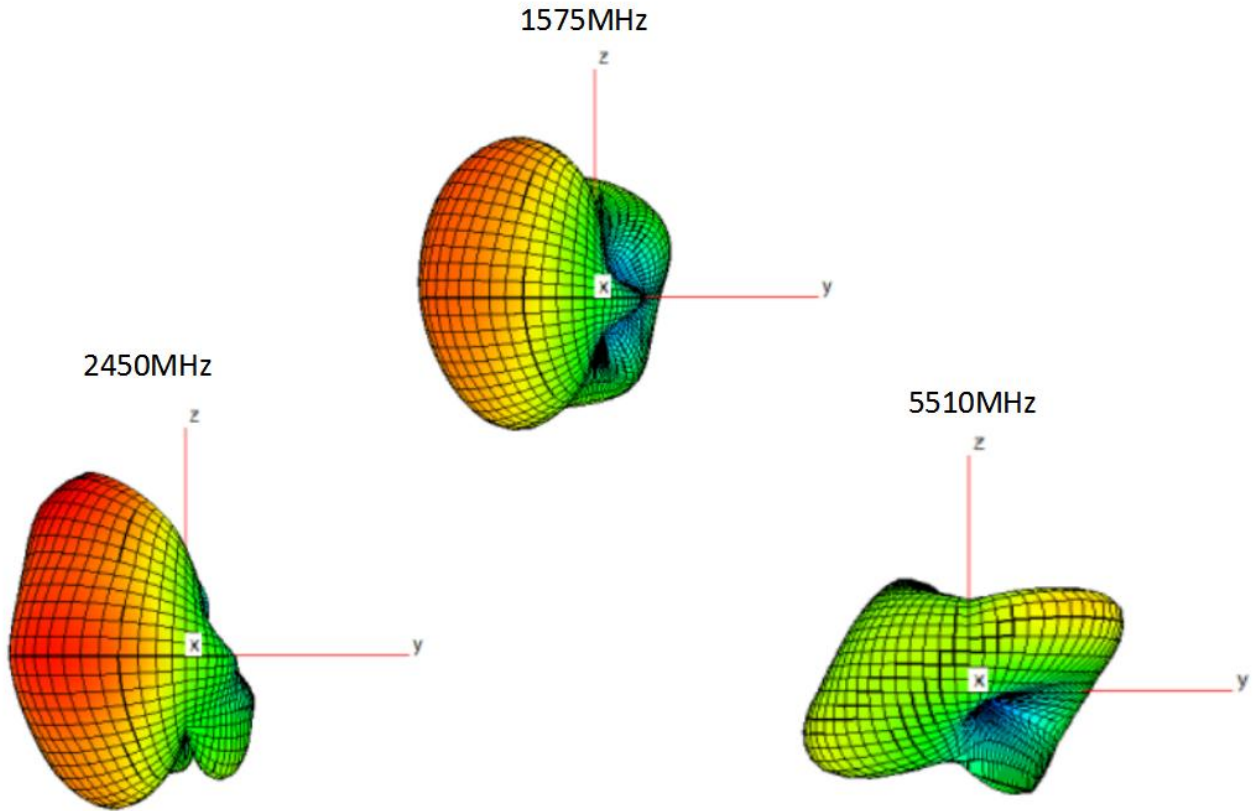



#### 4.6 装配图 (Environment treatment)

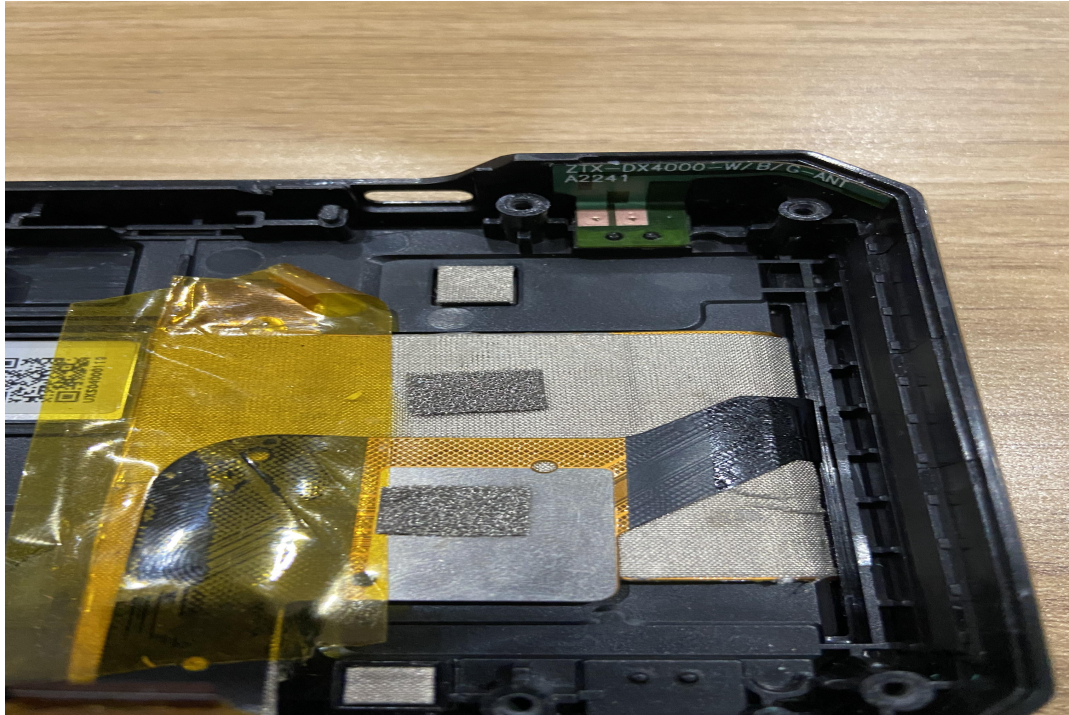



## 5. 匹配说明 (Matching circuit)

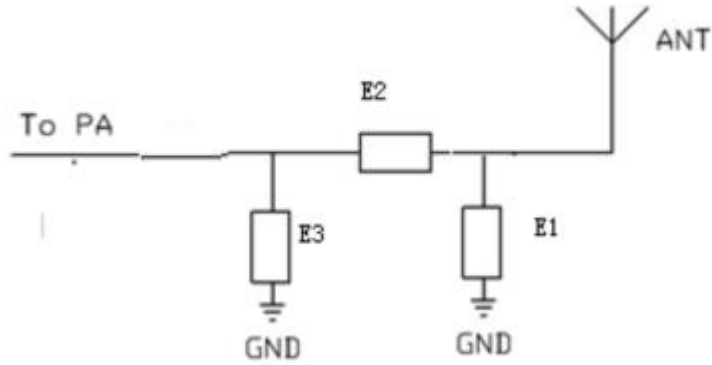

Matching description	WIFI/BT/GPS
E1	NC
E2	0 Ω
E3	NC





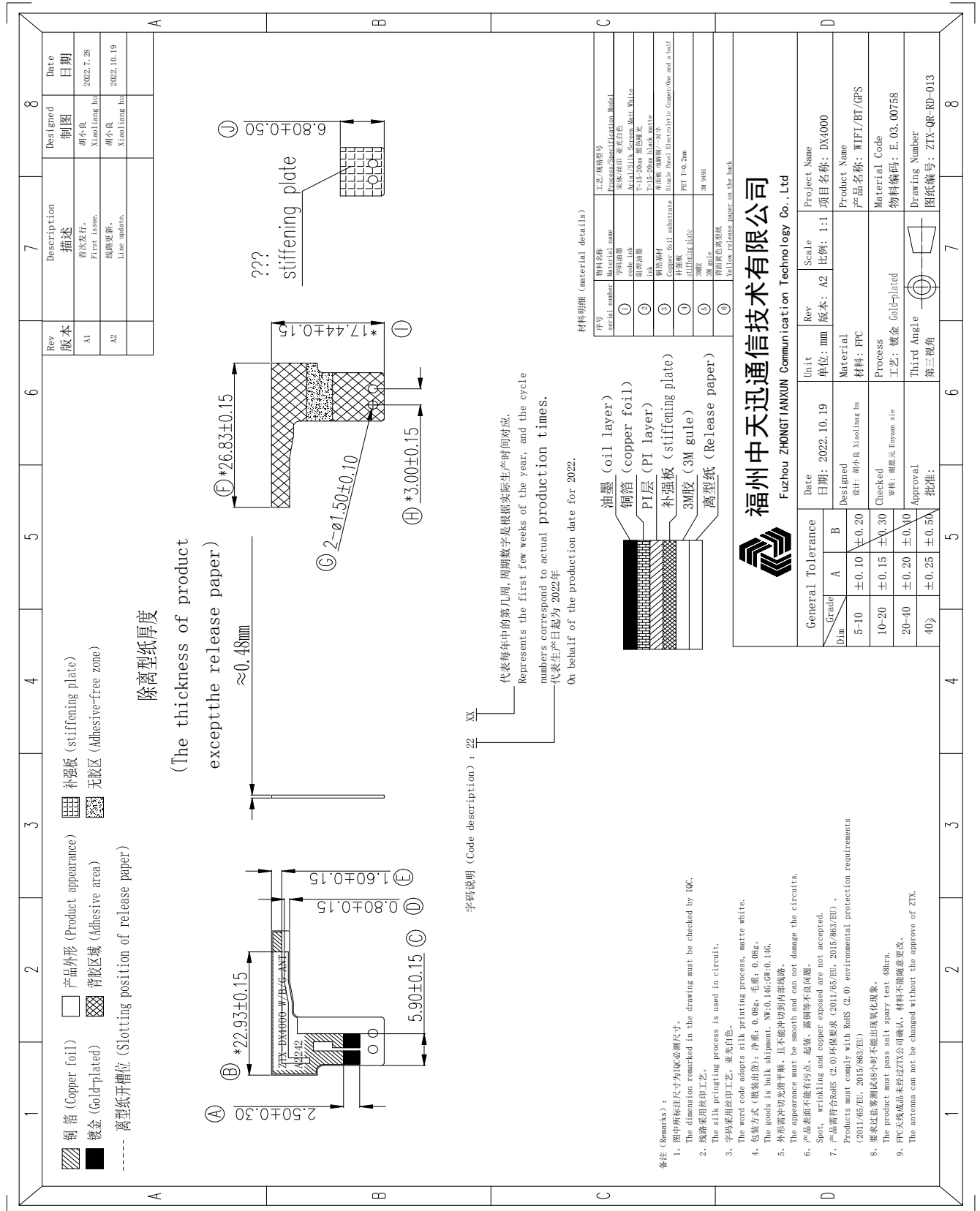

6. 天线外形图 (Mechanical Specification)



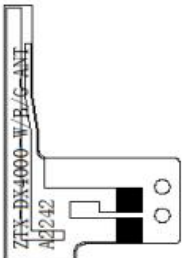
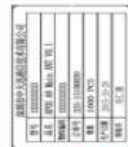

7. 包装作业指导 (The packing way)

福州中天迅通信技术有限公司 Fuzhou ZHONGTIANXUN Communication Technology Co., Ltd					作业指导书				
产品名称	产品型号	文件编号	版本	工序号/名称	工序工时	日产量			
三合一	DX4000	ZTX-QD-WI-024	A1	包装	/	/			
<p>作业方法 (自检该工序作业合格格后,方能流入下一道工序)</p> <p><b>注意事项:</b></p> <ol style="list-style-type: none"> <li>1. 发现重量有超出公差范围时,须对数量进行清点</li> <li>2. 外箱只允许有1个物料标签,其余如有多余标签时须将其清理干净。</li> <li>3. 条码标签在贴于外箱时,应尽量平整,避免应起皱影响客户入库。</li> <li>4. 条码需清晰可扫描</li> </ol>									
<p>1. 产品采用单PCS出货,每(100pcs)产品用90*130mmPE封口膜</p>  <p>2. 每个160*240mmPE开口膜袋装10小袋(1000PCS),尾数除外;</p>  <p>3. 外箱上除标签贴外,不能有任何丝印(即空白纸箱)出货;</p> <p>4. 将包装好的产品装入纸箱,每箱数量根据订单数量要求进行数量确认,保证每箱装入的数量正确。</p> <p>5. 在装好产品的箱子上将外箱标签及物料追溯码,ROHS贴于外箱的右上角,打印标签内容包括(生产产家,型号,产品名称,客户编码,数量,订单号,日期,QA检验,)</p>   <p>图1: 确认数量</p> <p>图2: 每10小袋用大PE袋包装</p> <p>图3: 小标签及追溯码</p> <p>图4: 贴外箱标签,封箱</p>									
物料编号			物料名称及规格		用量	工装夹具			
			纸箱(45*32.5*21)cm		1	电子秤			
			PE封口袋(90*130)mm		200	封口机			
			PE开口袋(160*240)mm		20				
修订内容					修订日期	修订人			
版本									
制订	胡小良	审核	易爱玲	品质确认	胡春梅	批准			
						张武民			



