

TEST REPORT

Test report no.: 1-4862/17-01-04



Testing laboratory

CTC advanced GmbH

Untertuerkheimer Strasse 6 – 10
66117 Saarbruecken / Germany
Phone: + 49 681 5 98 - 0
Fax: + 49 681 5 98 - 9075
Internet: <http://www.ctcadvanced.com>
e-mail: mail@ctcadvanced.com

Accredited Testing Laboratory:

The testing laboratory (area of testing) is accredited according to DIN EN ISO/IEC 17025 (2005) by the Deutsche Akkreditierungsstelle GmbH (DAkkS). The accreditation is valid for the scope of testing procedures as stated in the accreditation certificate with the registration number: D-PL-12076-01-01

Applicant

Ingenico Group

9 Avenue de la Gare Rovaltain
26958 Valence Cedex 9 / FRANCE
Contact: Jean-Baptiste Palisse
e-mail: jean-baptiste.palisse@ingenico.com
Phone: +33 4 75 84 21 74

Manufacturer

Ingenico Group

9 Avenue de la Gare Rovaltain
26958 Valence Cedex 9 / FRANCE

Test standard/s

47 CFR Part 15 Title 47 of the Code of Federal Regulations; Chapter I; Part 15 - Radio frequency devices
RSS - 247 Issue 2 Digital Transmission Systems (DTSs), Frequency Hopping Systems (FHSs) and Licence - Exempt Local Area Network (LE-LAN) Devices

For further applied test standards please refer to section 3 of this test report.

Test Item

Kind of test item: Payment terminal
Model name: DESK3500 CL/ETH/MOD/WiFi
FCC ID: XKB-D3500CLWI
IC: 2586D-D3500CLWI
UNII bands:
Frequency: 5150 MHz to 5250 MHz; 5250 MHz to 5350 MHz; 5470 MHz to 5725 MHz; 5725 MHz to 5850 MHz
Technology tested: WLAN (DFS for Client only)
Antenna: Integrated antenna
Power supply: 110 V AC / 8 V DC by AC/DC mains adapter PSM24W-080L6
Temperature range: 0°C to +40°C



This test report is electronically signed and valid without handwritten signature. For verification of the electronic signatures, the public keys can be requested at the testing laboratory.

Test report authorized:

René Oelmann
Lab Manager
Radio Communications & EMC

Test performed:

David Lang
Lab Manager
Radio Communications & EMC

1 Table of contents

| | | |
|----------------|--|-----------|
| 1 | Table of contents | 2 |
| 2 | General information | 3 |
| 2.1 | Notes and disclaimer | 3 |
| 2.2 | Application details | 3 |
| 2.3 | Test laboratories sub-contracted | 3 |
| 3 | Test standard/s and references | 4 |
| 4 | Test environment | 5 |
| 5 | Test item | 5 |
| 5.1 | General description | 5 |
| 5.2 | Additional information | 5 |
| 6 | Measurement uncertainty | 6 |
| 7 | Summary of measurement results | 6 |
| 8 | Additional comments | 7 |
| 9 | RF measurements | 8 |
| 9.1 | Description of test setup | 8 |
| 9.1.1 | Conducted measurements..... | 9 |
| 9.2 | Parameters of DFS test signals | 10 |
| 9.2.1 | DFS Detection Thresholds for Master Devices as well as Client Devices With Radar Detection | 10 |
| 9.2.2 | DFS Response Requirement Values..... | 10 |
| 9.2.3 | Radar Test Waveforms..... | 11 |
| 9.3 | Test preparation | 13 |
| 9.3.1 | Channel loading | 13 |
| 9.3.2 | 99% Bandwidth to determine the U-NII-bandwidth | 14 |
| 9.3.3 | Radar burst timing signal | 15 |
| 9.4 | Test results (prior to use of a channel) | 16 |
| 9.5 | Test results (during normal operation) | 16 |
| 9.5.1 | Channel move time / channel closing transmission time..... | 16 |
| 9.5.1 | Non-Occupancy Period..... | 18 |
| 10 | Observations | 19 |
| Annex A | Glossary | 19 |
| Annex B | Document history | 20 |
| Annex C | Accreditation Certificate | 20 |

2 General information

2.1 Notes and disclaimer

The test results of this test report relate exclusively to the test item specified in this test report. CTC advanced GmbH does not assume responsibility for any conclusions and generalizations drawn from the test results with regard to other specimens or samples of the type of the equipment represented by the test item.

The test report may only be reproduced or published in full. Reproduction or publication of extracts from the report requires the prior written approval of CTC advanced GmbH.

The testing service provided by CTC advanced GmbH has been rendered under the current "General Terms and Conditions for CTC advanced GmbH".

CTC advanced GmbH will not be liable for any loss or damage resulting from false, inaccurate, inappropriate or incomplete product information provided by the customer.

Under no circumstances does the CTC advanced GmbH test report include any endorsement or warranty regarding the functionality, quality or performance of any other product or service provided.

Under no circumstances does the CTC advanced GmbH test report include or imply any product or service warranties from CTC advanced GmbH, including, without limitation, any implied warranties of merchantability, fitness for purpose, or non-infringement, all of which are expressly disclaimed by CTC advanced GmbH.

All rights and remedies regarding vendor's products and services for which CTC advanced GmbH has prepared this test report shall be provided by the party offering such products or services and not by CTC advanced GmbH. In no case this test report can be considered as a Letter of Approval.

This test report is electronically signed and valid without handwritten signature. For verification of the electronic signatures, the public keys can be requested at the testing laboratory.

2.2 Application details

| | |
|------------------------------------|------------|
| Date of receipt of order: | 2017-09-25 |
| Date of receipt of test item: | 2017-11-28 |
| Start of test: | 2017-12-07 |
| End of test: | 2017-12-09 |
| Person(s) present during the test: | -/- |

2.3 Test laboratories sub-contracted

None

3 Test standard/s and references

| Test standard | Date | Description |
|-------------------|---------------|--|
| 47 CFR Part 15 | | Title 47 of the Code of Federal Regulations; Chapter I; Part 15 - Radio frequency devices |
| RSS - 247 Issue 2 | February 2017 | Digital Transmission Systems (DTSs), Frequency Hopping Systems (FHSs) and Licence - Exempt Local Area Network (LE-LAN) Devices |

| Guidance | Version | Description |
|----------------------|---------|---|
| UNII: KDB 789033 D02 | v01r04 | Guidelines for Compliance Testing of Unlicensed National Information Infrastructure (U-NII) Devices - Part 15, Subpart E |
| UNII: KDB 905462 D02 | v02 | Compliance measurement procedures for unlicensed - national information infrastructure devices operating in the 5250 - 5350 MHz and 5470 - 5725 MHz bands incorporating dynamic frequency selection |
| UNII: KDB 905462 D03 | v01r02 | Client Without DFS New Rules |
| UNII: KDB 905462 D04 | v01 | Operational Modes for DFS Testing New Rules |

4 Test environment

| | | |
|---------------------------|---|---|
| Temperature | : T _{nom} T _{max} T _{min} | +22 °C during room temperature tests No tests under extreme temperature conditions required. No tests under extreme temperature conditions required. |
| Relative humidity content | : | 55 % |
| Barometric pressure | : | 1021 hpa |
| Power supply | : V _{nom} V _{max} V _{min} | 110 V AC / 8 V DC by AC/DC mains adapter PSM24W-080L6 No tests under extreme voltage conditions required. No tests under extreme voltage conditions required. |

5 Test item

5.1 General description

| | | |
|----------------------------|---|--|
| Kind of test item | : | Payment terminal |
| Type identification | : | DESK3500 CL/ETH/MOD/WiFi |
| HMN | : | -/- |
| PMN | : | Desk/3500 |
| HVIN | : | Desk/3500 CL/Eth/Mod/WiFi |
| FVIN | : | -/- |
| S/N serial number | : | Conducted unit: 161937313301064301110726 |
| HW hardware status | : | 01 |
| SW software status | : | OS_038002 HTB_0084 |
| Frequency band | : | UNII bands: 5150 MHz to 5250 MHz; 5250 MHz to 5350 MHz; 5470 MHz to 5725 MHz; 5725 MHz to 5850 MHz |
| Type of radio transmission | : | OFDM |
| Use of frequency spectrum | : | |
| Type of modulation | : | (D)BPSK, (D)QPSK, 16 – QAM, 64 – QAM |
| Number of channels | : | 20 MHz: 24 40 MHz: 11 |
| Antenna | : | Integrated antenna |
| Power supply | : | 110 V AC / 8 V DC by AC/DC mains adapter PSM24W-080L6 |
| Temperature range | : | 0°C to +40°C |

5.2 Additional information

The content of the following annexes is defined in the QA. It may be that not all of the listed annexes are necessary for this report, thus some values in between may be missing.

Test setup- and EUT-photos are included in test report: 1-4862/17-01-01_AnnexA
1-4862/17-01-01_AnnexB

6 Measurement uncertainty

| Measurement uncertainty | |
|----------------------------------|-------------|
| Test case | Uncertainty |
| Frequency accuracy (radar burst) | 0.1 Hz |
| Level accuracy (radar burst) | ± 0.8 dB |

7 Summary of measurement results

| | |
|-------------------------------------|--|
| <input checked="" type="checkbox"/> | No deviations from the technical specifications were ascertained |
| <input type="checkbox"/> | There were deviations from the technical specifications ascertained |
| <input checked="" type="checkbox"/> | This test report is only a partial test report. The content and verdict of the performed test cases are listed below. |

| TC Identifier | Description | Verdict | Date | Remark |
|---------------|------------------------|---------|------------|----------|
| DFS-Testing | CFR Part 15, FCC 06-96 | Pass | 2017-12-12 | DFS only |

| Test Standard Clause | Test Case | Bandwidth | C | NC | NA | NP | Remark |
|--------------------------------|---|-----------|-------------------------------------|--------------------------|-------------------------------------|--------------------------|--------|
| 7.8.1*3 | U-NII Detection Bandwidth | -/- | <input type="checkbox"/> | <input type="checkbox"/> | <input checked="" type="checkbox"/> | <input type="checkbox"/> | *1*2*3 |
| §15.407 (h)(2) | DFS Detection Threshold | -/- | <input type="checkbox"/> | <input type="checkbox"/> | <input checked="" type="checkbox"/> | <input type="checkbox"/> | *1*2*3 |
| §15.407 (h)(2) (ii) & 7.8.2*3 | Channel Availability Check Time | -/- | <input type="checkbox"/> | <input type="checkbox"/> | <input checked="" type="checkbox"/> | <input type="checkbox"/> | *1*3 |
| §15.407 (h)(2) (iv) & 7.8.3*3 | Non-Occupancy Period | -/- | <input checked="" type="checkbox"/> | <input type="checkbox"/> | <input type="checkbox"/> | <input type="checkbox"/> | *2 |
| §15.407 (h)(2) (iii) & 7.8.2*3 | Channel Move Time / Channel Closing Transmission Time | 40 MHz | <input checked="" type="checkbox"/> | <input type="checkbox"/> | <input type="checkbox"/> | <input type="checkbox"/> | *2 |
| 7.8.3 & 7.8.4*3 | In-Service Monitoring / Statistical Performance Check | -/- | <input type="checkbox"/> | <input type="checkbox"/> | <input checked="" type="checkbox"/> | <input type="checkbox"/> | *2*3 |

Abbreviations/References:

- C Compliant
- NC Not compliant
- NA Not applicable
- NP Not performed
- *1 Prior to use of a channel
- *2 During normal operation
- *3 Not applicable for Client Devices without radar detection.

8 Additional comments

Reference documents: None

Special test descriptions: All tests except the In-Service Monitoring are conducted with Pulse Type 0.

A sample with temporary antenna connector was provided to perform the measurements in a conducted way.

Configuration descriptions: Iperf was used to generate the required channel load (duty cycle greater 17 percent).

DFS functionality: Master device
 Client with radar detection
 Client without radar detection

9 RF measurements

9.1 Description of test setup

Typically, the calibrations of the test apparatus are commissioned to and performed by an accredited calibration laboratory. The calibration intervals are determined in accordance with the DIN EN ISO/IEC 17025. In addition to the external calibrations, the laboratory executes comparison measurements with other calibrated test systems or effective verifications. Weekly chamber inspections and range calibrations are performed. Where possible, RF generating and signaling equipment as well as measuring receivers and analyzers are connected to an external high-precision 10 MHz reference (GPS-based or rubidium frequency standard).

In order to simplify the identification of the equipment used at some special tests, some items of test equipment and ancillaries can be provided with an identifier or number in the equipment list below (Lab/Item).

Agenda: Kind of Calibration

| | | | |
|------|--|-----|--|
| k | calibration / calibrated | EK | limited calibration |
| ne | not required (k, ev, izw, zw not required) | zw | cyclical maintenance (external cyclical maintenance) |
| ev | periodic self verification | izw | internal cyclical maintenance |
| Ve | long-term stability recognized | g | blocked for accredited testing |
| vkl! | Attention: extended calibration interval | * | next calibration ordered / currently in progress |
| NK! | Attention: not calibrated | | |

9.1.1 Conducted measurements

Setup

Figure 1 shows a setup whereby the UUT is a RLAN device operating in slave mode, without Radar Interference Detection function. This setup also contains a RLAN device operating in master mode. The radar test signals are injected into the master device. The UUT (slave device) is associated with the master device.

Figure 1 shows an example

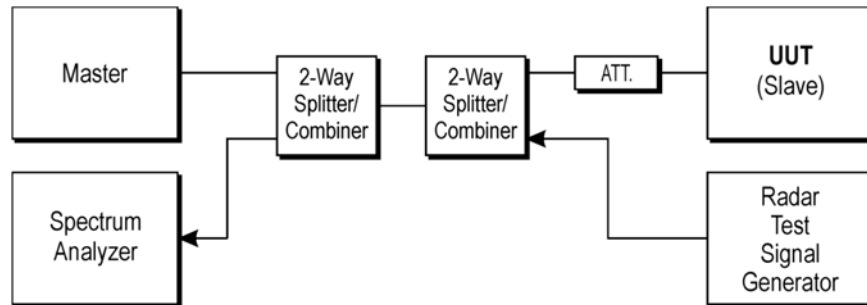

Figure 1: Setup

RPP = SG - CA

(RPP-radar pulse power; SG-signal generator power; CA-loss signal path)

Example calculation:

$$RPP [dBm] = -30.0 [dBm] - 33.0 [dB] = -63.0 [dBm]$$

Equipment table:

| No. | Lab / Item | Equipment | Type | Manufacturer | Serial No. | INV. No Cetecom | Kind of Calibration | Last Calibration | Next Calibration |
|-----|------------|--|------------------------------------|----------------|-------------------|-----------------|---------------------|------------------|------------------|
| 1 | A | Vector Signal Generator | SMU200A | R&S | 101633 | 300003496 | k | 24.01.2017 | 23.01.2020 |
| 2 | A | Spectrum Analyzer 9kHz to 30GHz - 140...+30dBm | FSP30 | R&S | 100886 | 300003575 | k | 24.01.2017 | 23.01.2019 |
| 3 | A | DFS-test site | div. Splitter, Cables, Attenuators | Mini-Circuits | na | 300004557 | ev | -/- | -/- |
| 4 | A | Notebook | Latitude 15 6000 Series | Dell | | 300004737 | ne | -/- | -/- |
| 5 | A* | Dual Band Gigabit Router | RT-AC68U | Asus | F11MOH056666 | 400001244 | ne | -/- | -/- |
| 6 | A | PC | ExOne | F+W | 2890296v001 | 300005102 | ne | -/- | -/- |
| 7 | A | RF-Cable DFS-Tester No. 1 | Enviroflex 316 D | Huber & Suhner | Batch no. 1560522 | 400001257 | ev | -/- | -/- |
| 8 | A | RF-Cable DFS-Tester No. 6 | Enviroflex 316 D | Huber & Suhner | Batch no. 1560522 | 400001262 | ev | -/- | -/- |
| 9 | A | Shielding Box | JRE2218 | JRE Test LLC | 0001110 | 400001265 | ne | -/- | -/- |

* FCC ID: MSQ-RTAC68U

9.2 Parameters of DFS test signals

9.2.1 DFS Detection Thresholds for Master Devices as well as Client Devices With Radar Detection

| Maximum Transmit Power EIRP | Value (see note) |
|--|---------------------|
| ≥ 200 mW | -64 dBm |
| < 200 mW and power spectral density < 10 dBm/MHz | -62 dBm |
| < 200 mW and That do not meet the power spectral density < 10 dBm/MHz | -64 dBm |

Note 1: This is the level at the input of the receiver assuming a 0 dBi receive antenna.
 Note 2: Throughout these test procedures an additional 1 dB has been added to the amplitude of the test transmission waveforms to account for variations in measurement equipment. This will ensure that the test signal is at or above the detection threshold level to trigger a DFS response.
 Note3: EIRP is based on the highest antenna gain. For MIMO devices refer to KDB Publication 662911 D01.

9.2.2 DFS Response Requirement Values

| Parameter | Value |
|-----------------------------------|---|
| Non-occupancy period | minimum 30 minutes |
| Channel Availability Check Time | 60 seconds |
| Channel Move Time | 10 seconds See Note 1. |
| Channel Closing Transmission Time | 200 milliseconds + an aggregate of 60 milliseconds over remaining 10 second period. See Notes 1 and 2. |
| U-NII Detection Bandwidth | Minimum 100% of the U-NII 99% transmission power bandwidth. See Note 3. |

Note 1: Channel Move Time and the Channel Closing Transmission Time should be performed with Radar Type 0. The measurement timing begins at the end of the Radar Type 0 burst.
 Note 2: The Channel Closing Transmission Time is comprised of 200 milliseconds starting at the beginning of the Channel Move Time plus any additional intermittent control signals required to facilitate a Channel move (an aggregate of 60 milliseconds) during the remainder of the 10 second period. The aggregate duration of control signals will not count quiet periods in between transmissions.
 Note 3: During the U-NII Detection Bandwidth detection test, radar type 0 should be used. For each frequency step the minimum percentage of detection is 90 percent. Measurements are performed with no data traffic.

9.2.3 Radar Test Waveforms

This section provides the parameters for required test waveforms, minimum percentage of successful detections, and the minimum number of trials that must be used for determining DFS conformance.

Short Pulse Radar Test Waveforms

| Radar Type | Pulse Width (µsec) | PRI (µsec) | Number of Pulses | Minimum Percentage of Successful Detection | Minimum Number of Trials |
|--|--------------------|---|---|--|--------------------------|
| 0 | 1 | 1428 | 18 | See Note 1 | See Note 1 |
| 1 | 1 | Test A: 15 unique PRI values randomly selected from the list of 23 PRI values in Table 5a | Roundup $\left\{ \left(\frac{1}{360} \right) \cdot \left(\frac{19 \cdot 10^6}{\text{PRI}_{\mu\text{sec}}} \right) \right\}$ | 60% | 30 |
| | | Test B: 15 unique PRI values randomly selected within the range of 518-3066 µsec, with a minimum increment of 1 µsec, excluding PRI values selected in Test A | | | |
| 2 | 1-5 | 150-230 | 23-29 | 60% | 30 |
| 3 | 6-10 | 200-500 | 16-18 | 60% | 30 |
| 4 | 11-20 | 200-500 | 12-16 | 60% | 30 |
| Aggregate (Radar Types 1-4) | | | | 80% | 120 |
| Note 1: Short Pulse Radar Type 0 should be used for the detection bandwidth test, channel move time, and channel closing time tests. | | | | | |

A minimum of 30 unique waveforms are required for each of the Short Pulse Radar Types 2 through 4.

Pulse Repetition Intervals Values for Test A

| Pulse Repetition Frequency Number | Pulse Repetition Frequency (Pulses Per Second) | Pulse Repetition Interval (Microseconds) |
|-----------------------------------|--|--|
| 1 | 1930.5 | 518 |
| 2 | 1858.7 | 538 |
| 3 | 1792.1 | 558 |
| 4 | 1730.1 | 578 |
| 5 | 1672.2 | 598 |
| 6 | 1618.1 | 618 |
| 7 | 1567.4 | 638 |
| 8 | 1519.8 | 658 |
| 9 | 1474.9 | 678 |
| 10 | 1432.7 | 698 |
| 11 | 1392.8 | 718 |
| 12 | 1355 | 738 |
| 13 | 1319.3 | 758 |
| 14 | 1285.3 | 778 |
| 15 | 1253.1 | 798 |
| 16 | 1222.5 | 818 |
| 17 | 1193.3 | 838 |
| 18 | 1165.6 | 858 |
| 19 | 1139 | 878 |
| 20 | 1113.6 | 898 |
| 21 | 1089.3 | 918 |
| 22 | 1066.1 | 938 |
| 23 | 326.2 | 3066 |

Long Pulse Radar Test Waveform

| Radar Type | Pulse Width (µsec) | Chirp Width (MHz) | PRI (µsec) | Number of Pulses per Burst | Number of Bursts | Minimum Percentage of Successful Detection | Minimum Number of Trails |
|------------|--------------------|-------------------|------------|----------------------------|------------------|--|--------------------------|
| 5 | 50-100 | 5-20 | 1000-2000 | 1-3 | 8-20 | 80% | 30 |

The parameters for this waveform are randomly chosen. Thirty unique waveforms are required for the Long Pulse Radar Type waveforms.

Frequency Hopping Radar Test Waveform

| Radar Type | Pulse Width (µsec) | Chirp Width (MHz) | Pulses per Hop | Hopping Rate (kHz) | Hopping Sequence Length (msec) | Minimum Percentage of Successful Detection | Minimum Number of Trails |
|------------|--------------------|-------------------|----------------|--------------------|--------------------------------|--|--------------------------|
| 6 | 1 | 333 | 9 | 0.333 | 300 | 70% | 30 |

For the Frequency Hopping Radar Type, the same Burst parameters are used for each waveform. The hopping sequence is different for each waveform and a 100-length segment is selected from the hopping sequence defined.

The first frequency in a hopping sequence is selected randomly from the group of 475 integer frequencies from 5250 – 5724 MHz. Next, the frequency that was just chosen is removed from the group and a frequency is randomly selected from the remaining 474 frequencies in the group. This process continues until all 475 frequencies are chosen for the set.

9.3 Test preparation

9.3.1 Channel loading

Timing plots are required with calculations demonstrating a minimum channel loading of approximately 17% or greater. For example, channel loading can be estimated by setting the spectrum analyzer for zero span and approximate the Time On/ (Time On + Off Time). This can be done with any appropriate channel BW and modulation type.

HT40-Mode: Calculated duty cycle = 29.1%

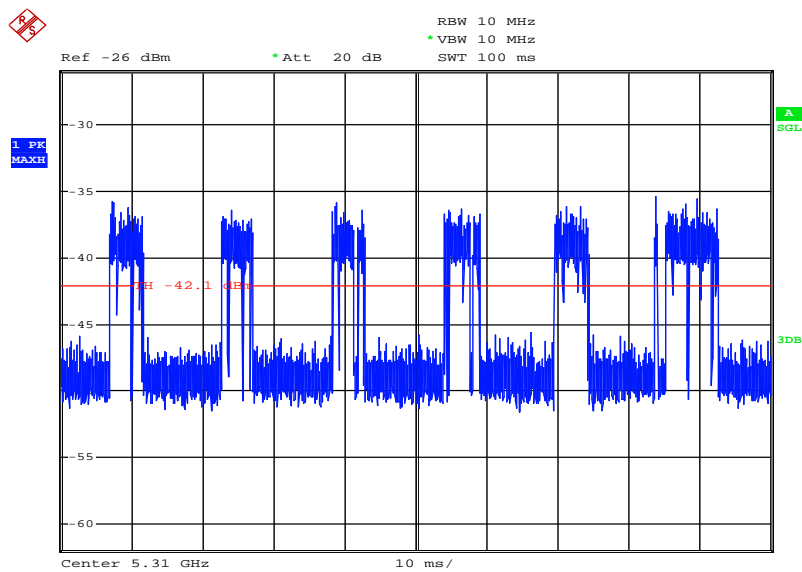

Date: 7.DEC.2017 13:08:35

Plot 1

9.3.2 99% Bandwidth to determine the U-NII-bandwidth

HT40-Mode: 36.9 MHz

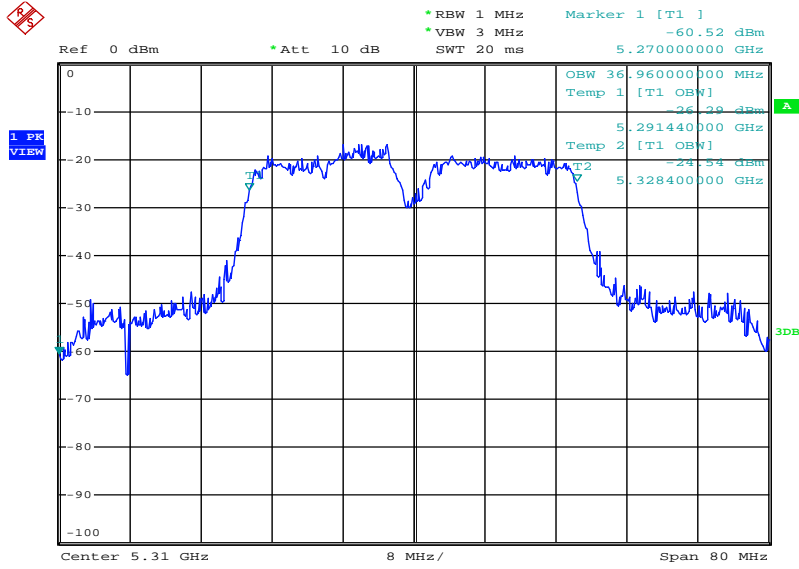

Date: 7.DEC.2017 14:35:10

Plot 2

9.3.3 Radar burst timing signal

To accurately determine the channel closing time and channel closing transmission time the spectrum analyser is triggered at the end of the radar burst (see marker at $t = 0$ ms).

Example plot (for demonstration)

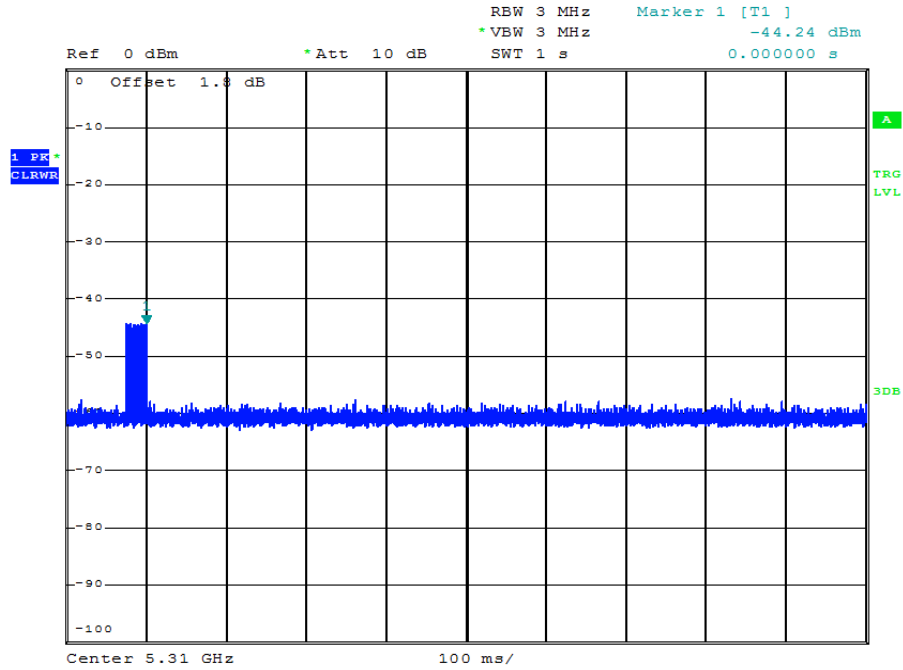

Plot 3

9.4 Test results (prior to use of a channel)

Not applicable.

9.5 Test results (during normal operation)

9.5.1 Channel move time / channel closing transmission time

After a radar's presence is detected, all transmissions shall cease on the operating channel within 10 seconds. Transmissions during this period shall consist of normal traffic for a maximum of 200 ms after detection of the radar signal. In addition, intermittent management and control signals can be sent during the remaining time to facilitate vacating the operating channel not exceeding 60ms.

The test is performed during normal operation with the highest bandwidth supported by the DUT.

Channel Closing Time

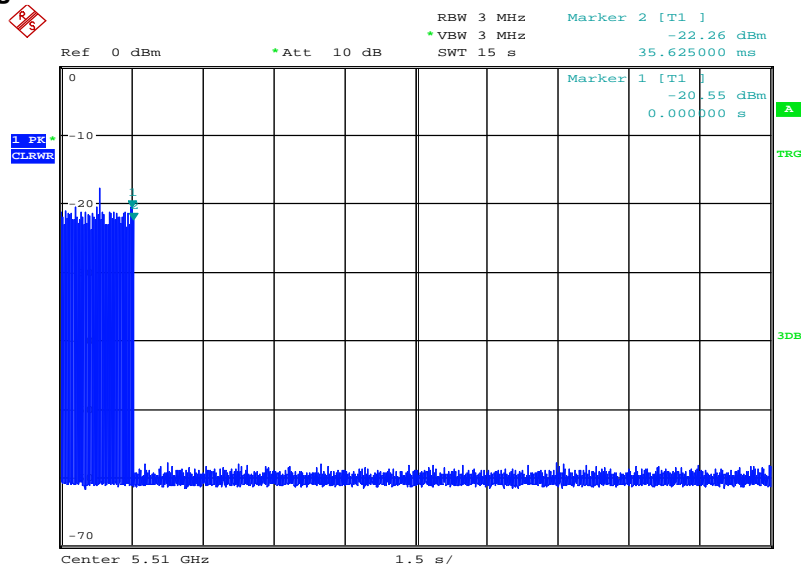

Date: 7.DEC.2017 13:17:14

Plot 4

Note: With Marker 1 at the end of the radar pulse ($t = 0$ ms) the Channel Closing Time is determined by setting a Delta-Marker to the point where the last transmission occurred. The Channel Closing Time is 36ms.

Channel Closing Transmission Time

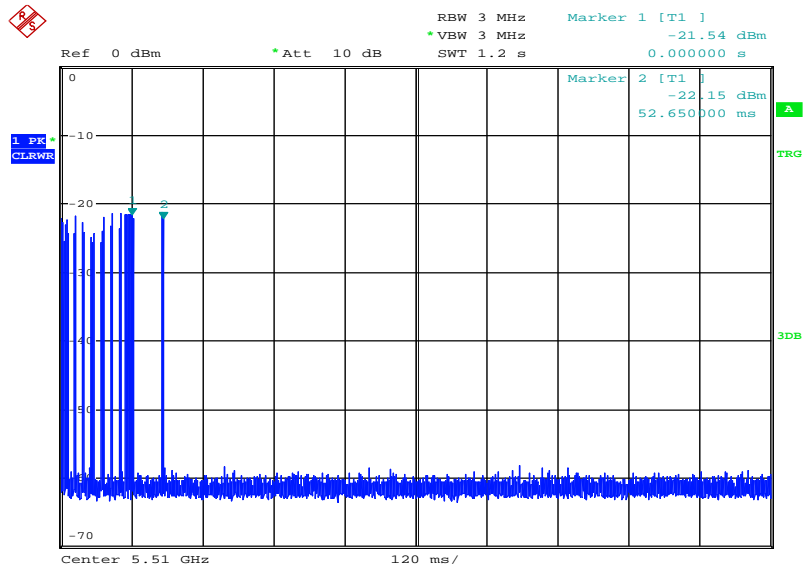

Date: 7.DEC.2017 13:21:33

Plot 5

Note: The accumulated transmission time is calculated by the number of bins occurring after $t = 0$ ms multiplied with the Time-per-sweep point-factor resulting from the Sweep Time and number of Sweep Points of the Spectrum Analyser.
 The Channel Closing Transmission Time is 1.3ms.

9.5.1 Non-Occupancy Period

A channel that has been flagged as containing a radar system, either by a channel availability check or in-service monitoring, is subject to a non-occupancy period of at least 30 minutes. The non occupancy period starts at the time when the radar system is detected.

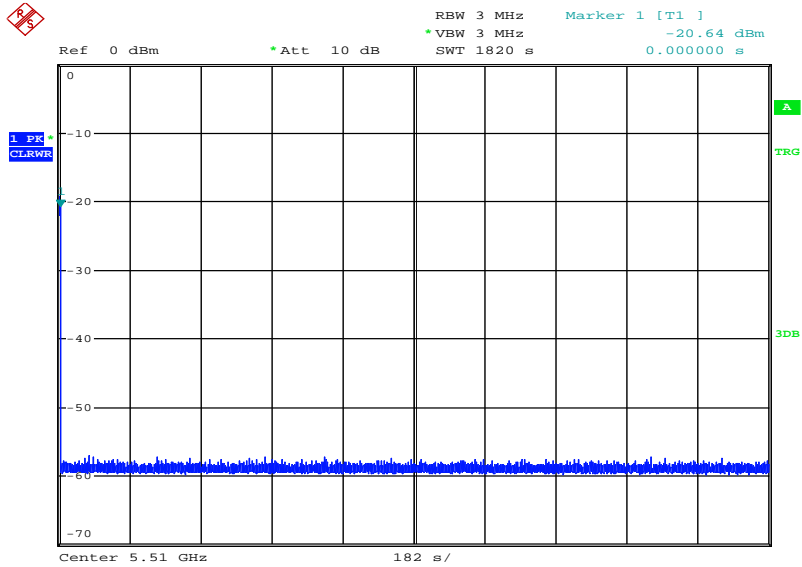

Date: 9.DEC.2017 13:59:04

10 Observations

No observations except those reported with the single test cases have been made.

Annex A Glossary

| | |
|------------------|--|
| EUT | Equipment under test |
| DUT | Device under test |
| UUT | Unit under test |
| GUE | GNSS User Equipment |
| EN | European Standard |
| FCC | Federal Communications Commission |
| FCC ID | Company Identifier at FCC |
| IC | Industry Canada |
| PMN | Product marketing name |
| HMN | Host marketing name |
| HVIN | Hardware version identification number |
| FVIN | Firmware version identification number |
| EMC | Electromagnetic Compatibility |
| HW | Hardware |
| SW | Software |
| Inv. No. | Inventory number |
| S/N or SN | Serial number |
| C | Compliant |
| NC | Not compliant |
| NA | Not applicable |
| NP | Not performed |
| PP | Positive peak |
| QP | Quasi peak |
| AVG | Average |
| OC | Operating channel |
| OCW | Operating channel bandwidth |
| OBW | Occupied bandwidth |
| OOB | Out of band |
| DFS | Dynamic frequency selection |
| CAC | Channel availability check |
| OP | Occupancy period |
| NOP | Non occupancy period |
| DC | Duty cycle |
| PER | Packet error rate |
| CW | Clean wave |
| MC | Modulated carrier |
| WLAN | Wireless local area network |
| RLAN | Radio local area network |
| DSSS | Dynamic sequence spread spectrum |
| OFDM | Orthogonal frequency division multiplexing |

Annex B Document history

| Version | Applied changes | Date of release |
|---------|-----------------|-----------------|
| -/- | Initial release | 2017-12-12 |

Annex C Accreditation Certificate

| first page | last page |
|---|--|
|  <p>Deutsche Akkreditierungsstelle GmbH</p> <p>Entrusted according to Section 8 subsection 1 AkkStelleG in connection with Section 1 subsection 1 AkkStelleGBV Signatory to the Multilateral Agreements of EA, ILAC and IAF for Mutual Recognition</p> <p>Accreditation</p> <p>The Deutsche Akkreditierungsstelle GmbH attests that the testing laboratory CTC advanced GmbH Untertürkheimer Straße 6-10, 66117 Saarbrücken</p> <p>is competent under the terms of DIN EN ISO/IEC 17025:2005 to carry out tests in the following fields: Telecommunication</p> <p>The accreditation certificate shall only apply in connection with the notice of accreditation of 02.06.2017 with the accreditation number D-PL-12076-01 and is valid until 21.04.2021. It comprises the cover sheet, the reverse side of the cover sheet and the following annex with a total of 43 pages.</p> <p>Registration number of the certificate: D-PL-12076-01-03</p> <p>Frankfurt, 02.06.2017</p> <p>Dipl.-Ing. (FH) Ralf Peter Head of Division</p> |  <p>Deutsche Akkreditierungsstelle GmbH</p> <p>Office Berlin Spittelmarkt 10 10117 Berlin</p> <p>Office Frankfurt am Main Europa-Allee 52 60327 Frankfurt am Main</p> <p>Office Braunschweig Bundesallee 100 38116 Braunschweig</p> <p>The publication of extracts of the accreditation certificate is subject to the prior written approval by Deutsche Akkreditierungsstelle GmbH (DAkKS). Exempted is the unchanged form of separate disseminations of the cover sheet by the conformity assessment body mentioned overleaf.</p> <p>No impression shall be made that the accreditation also extends to fields beyond the scope of accreditation attested by DAkKS.</p> <p>The accreditation was granted pursuant to the Act on the Accreditation Body (AkkStelleG) of 31 July 2009 (Federal Law Gazette I p. 2625) and the Regulation (EC) No 765/2008 of the European Parliament and of the Council of 9 July 2008 setting out the requirements for accreditation and market surveillance relating to the marketing of products (Official Journal of the European Union L 218 of 9 July 2008, p. 30). DAkKS is a signatory to the Multilateral Agreements for Mutual Recognition of the European co-operation for Accreditation (EA), International Accreditation Forum (IAF) and International Laboratory Accreditation Cooperation (ILAC). The signatories to these agreements recognise each other's accreditations.</p> <p>The up-to-date state of membership can be retrieved from the following websites: EA: www.european-accreditation.org ILAC: www.ilac.org IAF: www.iaf.nu</p> |

Note: The current certificate annex is published on the website (link see below) of the Accreditation Body DAkKS or may be received by CTC advanced GmbH on request

<http://www.dakks.de/as/ast/d/D-PL-12076-01-03.pdf>