

## TEST REPORT

Test report no.: 1-4862/17-01-03



### Testing laboratory

**CTC advanced GmbH**

Untertuerkheimer Strasse 6 – 10  
66117 Saarbruecken / Germany

Phone: + 49 681 5 98 - 0

Fax: + 49 681 5 98 - 9075

Internet: <http://www.ctcadvanced.com>

e-mail: [mail@ctcadvanced.com](mailto:mail@ctcadvanced.com)

**Accredited Testing Laboratory:**

The testing laboratory (area of testing) is accredited according to DIN EN ISO/IEC 17025 (2005) by the Deutsche Akkreditierungsstelle GmbH (DAkkS)

The accreditation is valid for the scope of testing procedures as stated in the accreditation certificate with the registration number: D-PL-12076-01-01

### Applicant

**Ingenico Group**

9 Avenue de la Gare Rovaltain  
26958 Valence Cedex 9 / FRANCE

Phone: -/-

Fax: -/-

Contact: Jean-Baptiste Palisse

e-mail: [jean-baptiste.palisse@ingenico.com](mailto:jean-baptiste.palisse@ingenico.com)

Phone: +33 4 75 84 21 74

### Manufacturer

**Ingenico Group**

9 Avenue de la Gare Rovaltain  
26958 Valence Cedex 9 / FRANCE

### Test standard/s

47 CFR Part 15	Title 47 of the Code of Federal Regulations; Chapter I; Part 15 - Radio frequency devices
RSS - 247 Issue 2	Digital Transmission Systems (DTSs), Frequency Hopping Systems (FHSs) and Licence - Exempt Local Area Network (LE-LAN) Devices
RSS - Gen Issue 4	Spectrum Management and Telecommunications Radio Standards Specifications - General Requirements and Information for the Certification of Radio Apparatus

For further applied test standards please refer to section 3 of this test report.

### Test Item

<b>Kind of test item:</b>	<b>Payment terminal</b>
<b>Model name:</b>	<b>DESK3500 CL/ETH/MOD/WiFi</b>
<b>FCC ID:</b>	<b>XKB-D3500CLWI</b>
<b>IC:</b>	<b>2586D-D3500CLWI</b>
	UNII bands:
Frequency:	5150 MHz to 5250 MHz; 5250 MHz to 5350 MHz; 5470 MHz to 5725 MHz; 5725 MHz to 5850 MHz
Technology tested:	WLAN
Antenna:	Integrated antenna
Power supply:	110 V AC / 8 V DC by AC/DC mains adapter PSM24W-080L6
Temperature range:	0°C to +40°C



This test report is electronically signed and valid without handwritten signature. For verification of the electronic signatures, the public keys can be requested at the testing laboratory.

### Test report authorized:

Mihail Dorongovskij  
Lab Manager  
Radio Communications & EMC

### Test performed:

Marco Bertolino  
Lab Manager  
Radio Communications & EMC

## 1 Table of contents

1	Table of contents.....	2
2	General information .....	3
2.1	Notes and disclaimer .....	3
2.2	Application details .....	3
2.3	Test laboratories sub-contracted .....	3
3	Test standard/s and references.....	4
4	Test environment .....	5
5	Test item .....	5
5.1	General description.....	5
5.2	Additional information .....	5
6	Description of the test setup .....	6
6.1	Shielded semi anechoic chamber .....	7
6.2	Shielded fully anechoic chamber .....	8
6.3	Radiated measurements > 18 GHz .....	9
6.4	AC conducted .....	10
6.5	Conducted measurements with peak power meter & spectrum analyzer.....	11
7	Sequence of testing .....	12
7.1	Sequence of testing radiated spurious 9 kHz to 30 MHz .....	12
7.2	Sequence of testing radiated spurious 30 MHz to 1 GHz .....	13
7.3	Sequence of testing radiated spurious 1 GHz to 18 GHz .....	14
7.4	Sequence of testing radiated spurious above 18 GHz .....	15
8	Measurement uncertainty.....	16
9	Summary of measurement results .....	17
10	Additional comments.....	18
11	Measurement results .....	20
11.1	Identify worst case data rate.....	20
11.2	Antenna gain.....	21
11.3	Duty cycle.....	29
11.4	Maximum output power .....	30
11.4.1	Maximum output power according to FCC requirements .....	30
11.4.2	Maximum output power according to IC requirements .....	50
11.5	Power spectral density .....	71
11.5.1	Power spectral density according to FCC requirements .....	71
11.5.2	Power spectral density according to IC requirements .....	79
11.6	Minimum emission bandwidth for the band 5.725-5.85 GHz .....	87
11.7	Spectrum bandwidth / 26 dB bandwidth .....	94
11.8	Occupied bandwidth / 99% emission bandwidth .....	115
11.9	Band edge compliance radiated .....	135
11.10	Spurious emissions radiated < 30 MHz.....	141
11.11	TX spurious emissions radiated .....	152
11.12	RX spurious emissions radiated.....	214
11.13	Spurious emissions conducted < 30 MHz .....	218
12	Observations .....	220
Annex A	Glossary .....	221
Annex B	Document history .....	222
Annex C	Accreditation Certificate .....	222

## 2 General information

### 2.1 Notes and disclaimer

The test results of this test report relate exclusively to the test item specified in this test report. CTC advanced GmbH does not assume responsibility for any conclusions and generalizations drawn from the test results with regard to other specimens or samples of the type of the equipment represented by the test item.

The test report may only be reproduced or published in full. Reproduction or publication of extracts from the report requires the prior written approval of CTC advanced GmbH.

The testing service provided by CTC advanced GmbH has been rendered under the current "General Terms and Conditions for CTC advanced GmbH".

CTC advanced GmbH will not be liable for any loss or damage resulting from false, inaccurate, inappropriate or incomplete product information provided by the customer.

Under no circumstances does the CTC advanced GmbH test report include any endorsement or warranty regarding the functionality, quality or performance of any other product or service provided.

Under no circumstances does the CTC advanced GmbH test report include or imply any product or service warranties from CTC advanced GmbH, including, without limitation, any implied warranties of merchantability, fitness for purpose, or non-infringement, all of which are expressly disclaimed by CTC advanced GmbH.

All rights and remedies regarding vendor's products and services for which CTC advanced GmbH has prepared this test report shall be provided by the party offering such products or services and not by CTC advanced GmbH.

In no case this test report can be considered as a Letter of Approval.

This test report is electronically signed and valid without handwritten signature. For verification of the electronic signatures, the public keys can be requested at the testing laboratory.

### 2.2 Application details

Date of receipt of order:	2017-09-25
Date of receipt of test item:	2017-10-04
Start of test:	2017-10-04
End of test:	2017-11-25
Person(s) present during the test:	-/-

### 2.3 Test laboratories sub-contracted

None

### 3 Test standard/s and references

Test standard	Date	Description
47 CFR Part 15	-/-	Title 47 of the Code of Federal Regulations; Chapter I; Part 15 - Radio frequency devices
RSS - 247 Issue 2	February 2017	Digital Transmission Systems (DTSs), Frequency Hopping Systems (FHSs) and Licence - Exempt Local Area Network (LE-LAN) Devices
RSS - Gen Issue 4	November 2014	Spectrum Management and Telecommunications Radio Standards Specifications - General Requirements and Information for the Certification of Radio Apparatus

Guidance	Version	Description
UNII: KDB 789033 D02	v01r04	Guidelines for Compliance Testing of Unlicensed National Information Infrastructure (U-NII) Devices - Part 15, Subpart E
ANSI C63.4-2014	-/-	American national standard for methods of measurement of radio-noise emissions from low-voltage electrical and electronic equipment in the range of 9 kHz to 40 GHz
ANSI C63.10-2013	-/-	American national standard of procedures for compliance testing of unlicensed wireless devices



## 6 Description of the test setup

Typically, the calibrations of the test apparatus are commissioned to and performed by an accredited calibration laboratory. The calibration intervals are determined in accordance with the DIN EN ISO/IEC 17025. In addition to the external calibrations, the laboratory executes comparison measurements with other calibrated test systems or effective verifications. Weekly chamber inspections and range calibrations are performed. Where possible, RF generating and signaling equipment as well as measuring receivers and analyzers are connected to an external high-precision 10 MHz reference (GPS-based or rubidium frequency standard).

In order to simplify the identification of the equipment used at some special tests, some items of test equipment and ancillaries can be provided with an identifier or number in the equipment list below (Lab/Item).

### **Agenda:** Kind of Calibration

k	calibration / calibrated	EK	limited calibration
ne	not required (k, ev, izw, zw not required)	zw	cyclical maintenance (external cyclical maintenance)
ev	periodic self verification	izw	internal cyclical maintenance
Ve	long-term stability recognized	g	blocked for accredited testing
vK!	Attention: extended calibration interval		
NK!	Attention: not calibrated	*)	next calibration ordered / currently in progress

## 6.1 Shielded semi anechoic chamber

The radiated measurements are performed in vertical and horizontal plane in the frequency range from 30 MHz to 1 GHz in semi-anechoic chambers. The EUT is positioned on a non-conductive support with a height of 0.80 m above a conductive ground plane that covers the whole chamber. The receiving antennas are conform to specifications ANSI C63. These antennas can be moved over the height range between 1.0 m and 4.0 m in order to search for maximum field strength emitted from EUT. The measurement distances between EUT and receiving antennas are indicated in the test setups for the various frequency ranges. For each measurement, the EUT is rotated in all three axes until the maximum field strength is received. The wanted and unwanted emissions are received by spectrum analyzers where the detector modes and resolution bandwidths over various frequency ranges are set according to requirement ANSI C63.

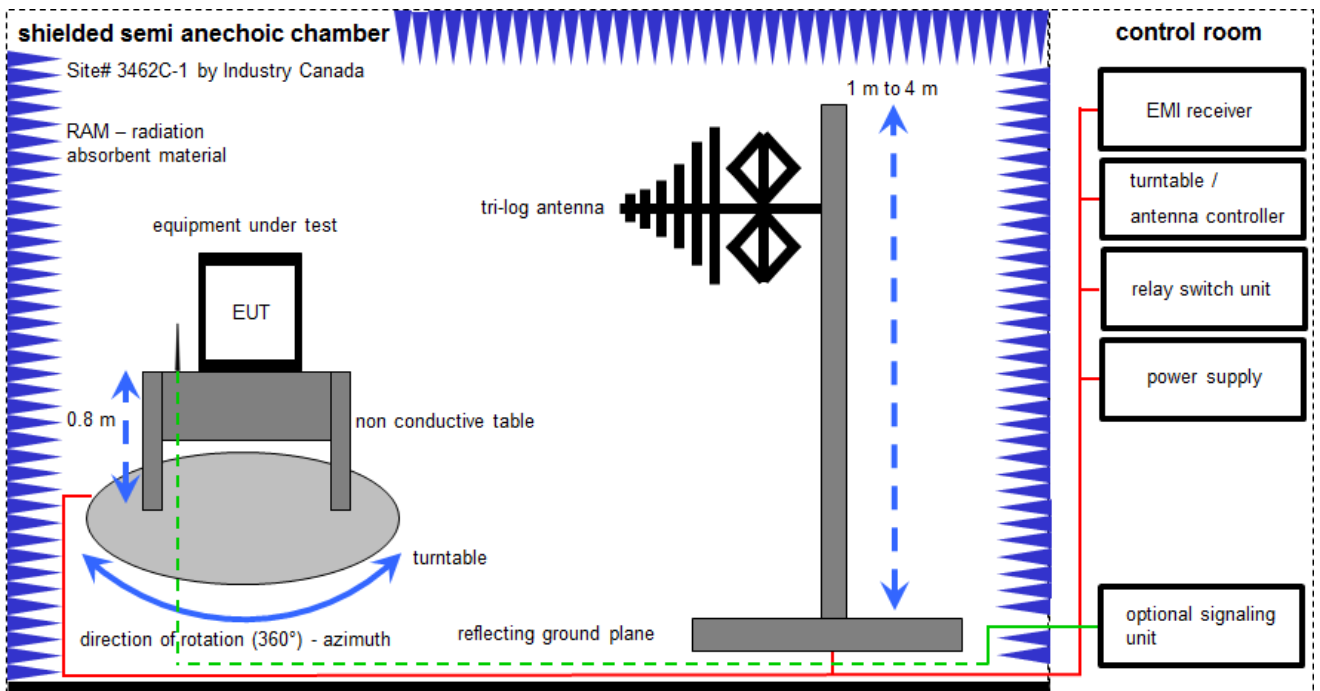

Measurement distance: tri-log antenna 10 meter

$$FS = UR + CL + AF$$

(FS-field strength; UR-voltage at the receiver; CL-loss of the cable; AF-antenna factor)

Example calculation:

$$FS [dB\mu V/m] = 12.35 [dB\mu V/m] + 1.90 [dB] + 16.80 [dB/m] = 31.05 [dB\mu V/m] (35.69 \mu V/m)$$

**Equipment table:**

No.	Lab / Item	Equipment	Type	Manufacturer	Serial No.	INV. No.	Kind of Calibration	Last Calibration	Next Calibration
1	A	Switch-Unit	3488A	HP	2719A14505	300000368	ev	-/-	-/-
2	A	Meßkabine 1	HF-Absorberhalle	MWB AG 300023		300000551	ne	-/-	-/-
3	A	EMI Test Receiver	ESCI 3	R&S	100083	300003312	k	01.02.2017	31.01.2018
4	A	Analyzer-Reference-System (Harmonics and Flicker)	ARS 16/1	SPS	A3509 07/0 0205	300003314	Ve	-/-	-/-
5	A	Antenna Tower	Model 2175	ETS-Lindgren	64762	300003745	izw	-/-	-/-
6	A	Positioning Controller	Model 2090	ETS-Lindgren	64672	300003746	izw	-/-	-/-
7	A	Turntable Interface-Box	Model 105637	ETS-Lindgren	44583	300003747	izw	-/-	-/-
8	A	TRILOG Broadband Test-Antenna 30 MHz - 3 GHz	VULB9163	Schwarzbeck	295	300003787	k	25.04.2016	25.04.2018

## 6.2 Shielded fully anechoic chamber

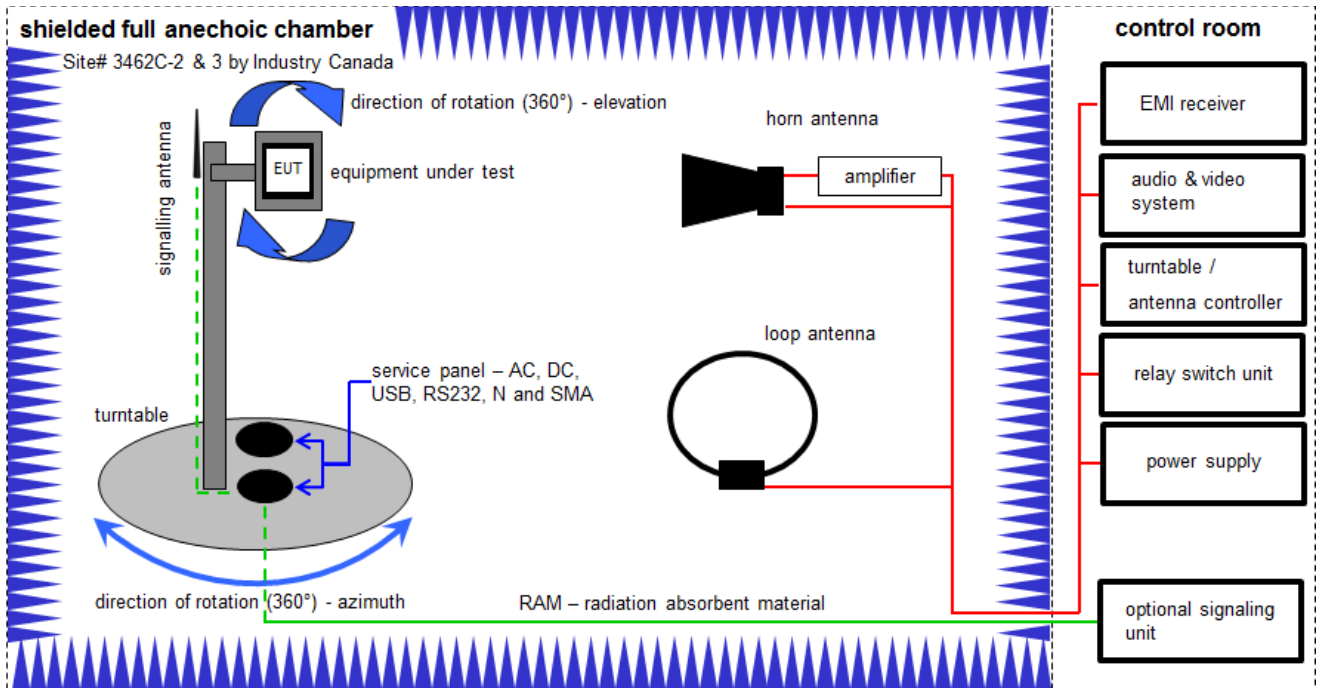

Measurement distance: horn antenna 3 meter; loop antenna 3 meter / 1 meter

$$FS = UR + CA + AF$$

(FS-field strength; UR-voltage at the receiver; CA-loss of the signal path; AF-antenna factor)

Example calculation:

$$FS [dB\mu V/m] = 40.0 [dB\mu V/m] + (-35.8) [dB] + 32.9 [dB/m] = 37.1 [dB\mu V/m] (71.61 \mu V/m)$$

### Equipment table:

No.	Lab / Item	Equipment	Type	Manufacturer	Serial No.	INV. No.	Kind of Calibration	Last Calibration	Next Calibration
1	A	Active Loop Antenna 9 kHz to 30 MHz	6502	EMCO	2210	300001015	k	07.07.2017	06.07.2019
2	A, B, C	Anechoic chamber	FAC 3/5m	MWB / TDK	87400/02	300000996	ev	-/-	-/-
3	B, C	Double-Ridged Wavguide Horn Antenna 1-18.0GHz	3115	EMCO	9107-3697	300001605	v IKI!	14.02.2017	13.02.2019
4	A, B, C	Switch / Control Unit	3488A	HP	*	300000199	ne	-/-	-/-
5	A, B, C	Variable isolating transformer	MPL IEC625 Bus Variable isolating transformer	Erfi	91350	300001155	ne	-/-	-/-
6	B	Band Reject filter	WRCG2400/2483-2375/2505-50/10SS	Wainwright	11	300003351	ev	-/-	-/-
7	A, B, C	EMI Test Receiver 20Hz- 26,5GHz	ESU26	R&S	100037	300003555	k	31.01.2017	30.01.2018
8	B	Highpass Filter	WHK1.1/15G-10SS	Wainwright	3	300003255	ev	-/-	-/-
9	B	Highpass Filter	WHKX7.0/18G-8SS	Wainwright	19	300003790	ne	-/-	-/-
10	B	Broadband Amplifier 0.5-18 GHz	CBLU5184540	CERNEX	22049	300004481	ev	-/-	-/-
11	A, B, C	4U RF Switch Platform	L4491A	Agilent Technologies	MY50000037	300004509	ne	-/-	-/-
12	A, B, C	NEXIO EMV-Software	BAT EMC V3.16.0.49	EMCO	-/-	300004682	ne	-/-	-/-
13	A, B, C	PC	ExOne	F+W	-/-	300004703	ne	-/-	-/-



### 6.3 Radiated measurements > 18 GHz

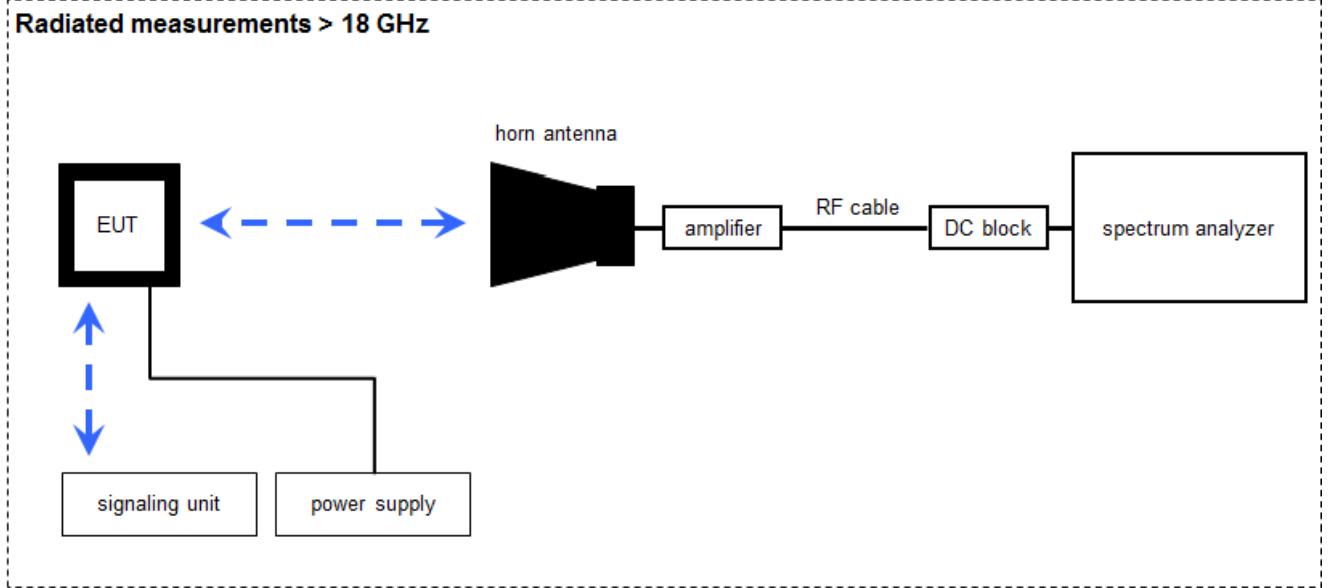

Measurement distance: horn antenna 50 cm

$$FS = UR + CA + AF$$

(FS-field strength; UR-voltage at the receiver; CA-loss signal path & distance correction; AF-antenna factor)

Example calculation:

$$FS [dB\mu V/m] = 40.0 [dB\mu V/m] + (-60.1) [dB] + 36.74 [dB/m] = 16.64 [dB\mu V/m] (6.79 \mu V/m)$$

#### Equipment table:

No.	Lab / Item	Equipment	Type	Manufacturer	Serial No.	INV. No.	Kind of Calibration	Last Calibration	Next Calibration
1	A	Horn Antenna 18,0-40,0 GHz	LHAF180	Microw.Devel	39180-103-022	300001748	k	22.05.2015	22.05.2018
2	A	Signal Analyzer 40 GHz	FSV40	R&S	101042	300004517	k	25.01.2017	24.01.2018
3	A	RF-Cable	ST18/SMAm/SMAm/48	Huber & Suhner	Batch no. 600918	400001182	ev	-/-	-/-
4	A	RF-Cable	ST18/SMAm/SMAm/48	Huber & Suhner	Batch no. 127377	400001183	ev	-/-	-/-
5	A	DC-Blocker 0.1-40 GHz	8141A	Inmet	-/-	400001185	ev	-/-	-/-
6	A	Amplifier 2-40 GHz	JS32-02004000-57-5P	MITEQ	1777200	300004541	ev	-/-	-/-

## 6.4 AC conducted

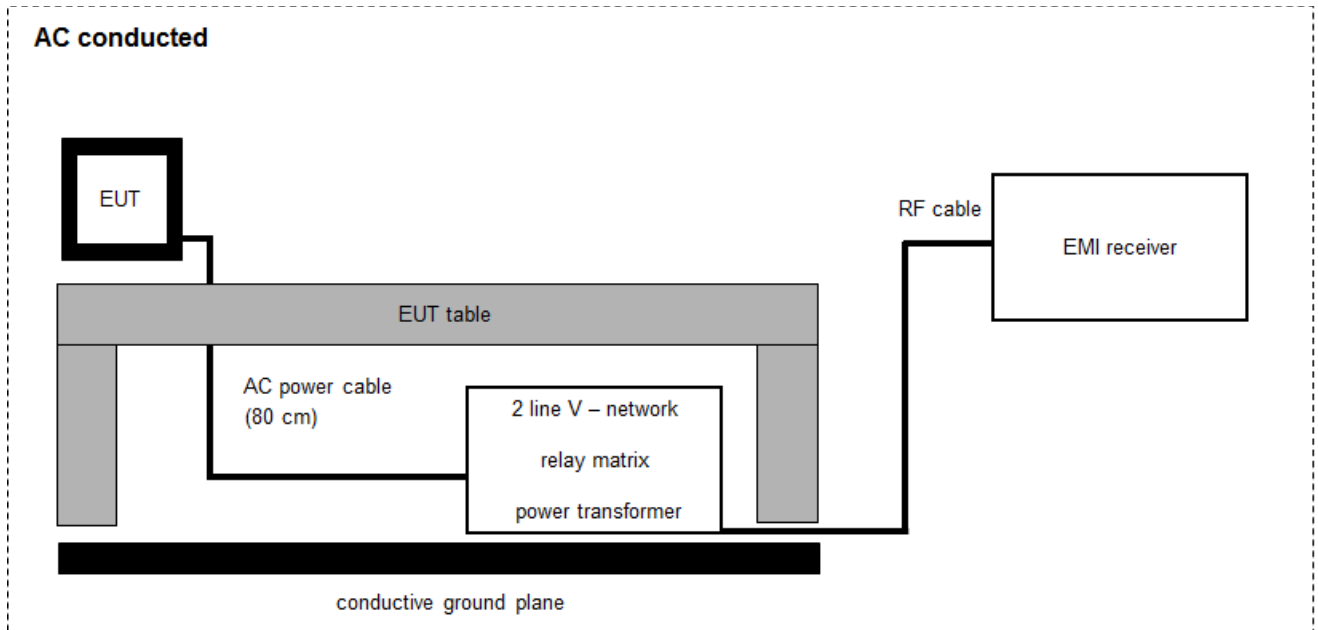

$$FS = UR + CF + VC$$

(FS-field strength; UR-voltage at the receiver; CR-loss of the cable and filter; VC-correction factor of the ISN)

Example calculation:

$$FS [dB\mu V/m] = 37.62 [dB\mu V/m] + 9.90 [dB] + 0.23 [dB] = 47.75 [dB\mu V/m] (244.06 \mu V/m)$$

### Equipment table:

No.	Lab / Item	Equipment	Type	Manufacturer	Serial No.	INV. No.	Kind of Calibration	Last Calibration	Next Calibration
1	A	Two-line V-Network (LISN) 9 kHz to 30 MHz	ESH3-Z5	R&S	893045/004	300000584	k	31.01.2017	30.01.2018
2	A	RF-Filter-section	85420E	HP	3427A00162	300002214	k	27.11.2006	-/-
3	A	AC-Spannungsquelle variabel	MV2616-V	EM-Test	0397-12	300003259	k	11.12.2015	11.12.2017
4	A	Hochpass 150 kHz	EZ-25	R&S	100010	300003798	ev	-/-	-/-
5	A	EMI Test Receiver	ESCI 3	R&S	100083	300003312	k	01.02.2017	31.01.2018
6	A	Customer Notebook	-/-	Dell	P1250643	Ingenico #2	-/-	-/-	-/-

## 6.5 Conducted measurements with peak power meter & spectrum analyzer

### Conducted measurements normal conditions

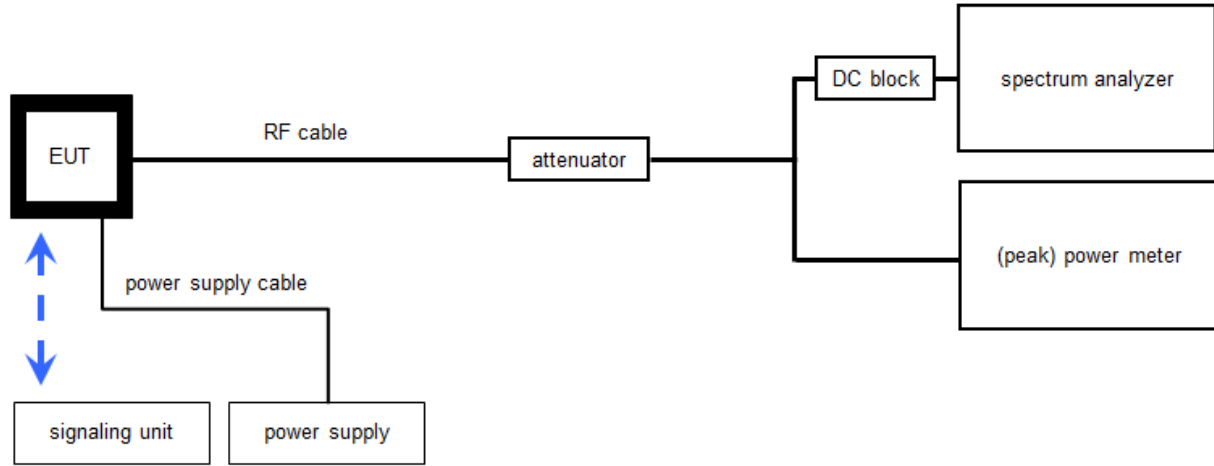

OP = AV + CA  
(OP-output power; AV-analyzer value; CA-loss signal path)

#### Example calculation:

OP [dBm] = 6.0 [dBm] + 11.7 [dB] = 17.7 [dBm] (58.88 mW)

#### Equipment table:

No.	Lab / Item	Equipment	Type	Manufacturer	Serial No.	INV. No.	Kind of Calibration	Last Calibration	Next Calibration
1	A	Signal Analyzer 40 GHz	FSV40	R&S	101042	300004517	k	25.01.2017	24.01.2018
2	A, B	Isolating Transformer	RT5A	Grundig	12780	300001166	ev	-/-	-/-
3	A, B	PC-WLAN Tester	Intel Core i3 3220/3,3 GHz, Prozessor	-/-	2V2403033A45 23	300004589	ne	-/-	-/-
4	A, B	Teststand	Teststand Custom Sequence Editor	National Instruments GmbH	-/-	300004590	ne	-/-	-/-
5	B	Power Sensor	NRP-Z81	R&S	-/-	300003780	k	26.01.2017	25.01.2019
6	A, B	RF-Cable	ST18/SMAm/SMAm/60	Huber & Suhner	Batch no. 606844	400001181	ev	-/-	-/-
7	A, B	DC-Blocker 0.1-40 GHz	8141A	Inmet	-/-	400001185	ev	-/-	-/-
8	A, B	Coax Attenuator 10 dB 2W 0-40 GHz	MCL BW-K10-2W44+	Mini Circuits	-/-	400001186	ev	-/-	-/-
9	A, B	Synchron Power Meter	SPM-4	CTC	1	400001294	ev	-/-	-/-
10	A, B	Hygro-Thermometer	5-45C, 20-100rF	-/-	-/-	400000108	ev	-/-	-/-

## 7 Sequence of testing

### 7.1 Sequence of testing radiated spurious 9 kHz to 30 MHz

#### Setup

- The equipment is set up to simulate normal operation mode as described in the user manual or defined by the manufacturer.
- If the EUT is a tabletop system, it is placed on a table with 0.8 m height.
- If the EUT is a floor standing device, it is placed directly on the turn table.
- Auxiliary equipment and cables are positioned to simulate normal operation conditions as described in ANSI C 63.4.
- The AC power port of the EUT (if available) is connected to a power outlet below the turntable.
- Measurement distance is 3 m (see ANSI C 63.4) – see test details.
- EUT is set into operation.

#### Premeasurement\*

- The turntable rotates from 0° to 315° using 45° steps.
- The antenna height is 1 m.
- At each turntable position the analyzer sweeps with positive-peak detector to find the maximum of all emissions.

#### Final measurement

- Identified emissions during the pre-measurement are maximized by the software by rotating the turntable from 0° to 360°.
- Loop antenna is rotated about its vertical axis for maximum response at each azimuth about the EUT. (For certain applications, the loop antenna plane may also need to be positioned horizontally at the specified distance from the EUT)
- The final measurement is done in the position (turntable and elevation) causing the highest emissions with quasi-peak (as described in ANSI C 63.4).
- Final levels, frequency, measuring time, bandwidth, turntable position, correction factor, margin to the limit and limit will be recorded. A plot with the graph of the premeasurement and the limit is stored.

\*)Note: The sequence will be repeated three times with different EUT orientations.

## 7.2 Sequence of testing radiated spurious 30 MHz to 1 GHz

### Setup

- The equipment is set up to simulate normal operation mode as described in the user manual or defined by the manufacturer.
- If the EUT is a tabletop system, a table with 0.8 m height is used, which is placed on the ground plane.
- If the EUT is a floor standing device, it is placed on the ground plane with insulation between both.
- Auxiliary equipment and cables are positioned to simulate normal operation conditions as described in ANSI C 63.4.
- The AC power port of the EUT (if available) is connected to a power outlet below the turntable.
- Measurement distance is 10 m or 3 m (see ANSI C 63.4) – see test details.
- EUT is set into operation.

### Premeasurement

- The turntable rotates from 0° to 315° using 45° steps.
- The antenna is polarized vertical and horizontal.
- The antenna height changes from 1 m to 3 m.
- At each turntable position, antenna polarization and height the analyzer sweeps three times in peak to find the maximum of all emissions.

### Final measurement

- The final measurement is performed for at least six highest peaks according to the requirements of the ANSI C63.4.
- Based on antenna and turntable positions at which the peak values are measured the software maximize the peaks by changing turntable position  $\pm 45^\circ$  and antenna height between 1 and 4 m.
- The final measurement is done with quasi-peak detector (as described in ANSI C 63.4).
- Final levels, frequency, measuring time, bandwidth, antenna height, antenna polarization, turntable angle, correction factor, margin to the limit and limit are recorded. A plot with the graph of the premeasurement with marked maximum final results and the limit is stored.

### 7.3 Sequence of testing radiated spurious 1 GHz to 18 GHz

#### Setup

- The equipment is set up to simulate normal operation mode as described in the user manual or defined by the manufacturer.
- If the EUT is a tabletop system, a 2-axis positioner with 1.5 m height is used.
- If the EUT is a floor standing device, it is placed directly on the turn table.
- Auxiliary equipment and cables are positioned to simulate normal operation conditions as described in ANSI C 63.4.
- The AC power port of the EUT (if available) is connected to a power outlet below the turntable.
- Measurement distance is 3 m (see ANSI C 63.4) – see test details.
- EUT is set into operation.

#### Premeasurement

- The turntable rotates from 0° to 315° using 45° steps.
- The antenna is polarized vertical and horizontal.
- The antenna height is 1.5 m.
- At each turntable position and antenna polarization the analyzer sweeps with positive peak detector to find the maximum of all emissions.

#### Final measurement

- The final measurement is performed for at least six highest peaks according to the requirements of the ANSI C63.4.
- Based on antenna and turntable positions at which the peak values are measured the software maximizes the peaks by rotating the turntable from 0° to 360°. This measurement is repeated for different EUT-table positions (0° to 150° in 30°-steps) and for both antenna polarizations.
- The final measurement is done in the position (turntable, EUT-table and antenna polarization) causing the highest emissions with Peak and RMS detector (as described in ANSI C 63.4).
- Final levels, frequency, measuring time, bandwidth, turntable position, EUT-table position, antenna polarization, correction factor, margin to the limit and limit are recorded. A plot with the graph of the premeasurement with marked maximum final results and the limit is stored.

## 7.4 Sequence of testing radiated spurious above 18 GHz

### Setup

- The equipment is set up to simulate normal operation mode as described in the user manual or defined by the manufacturer.
- Auxiliary equipment and cables are positioned to simulate normal operation conditions as described in ANSI C 63.4.
- The AC power port of the EUT (if available) is connected to a power outlet.
- The measurement distance is as appropriate (e.g. 0.5 m).
- The EUT is set into operation.

### Premeasurement

- The test antenna is handheld and moved carefully over the EUT to cover the EUT's whole sphere and different polarizations of the antenna.

### Final measurement

- The final measurement is performed at the position and antenna orientation causing the highest emissions with Peak and RMS detector (as described in ANSI C 63.4).
- Final levels, frequency, measuring time, bandwidth, correction factor, margin to the limit and limit are recorded. A plot with the graph of the premeasurement and the limit is stored.

## 8 Measurement uncertainty

Measurement uncertainty	
Test case	Uncertainty
Antenna gain	± 3 dB
Power spectral density	± 1.5 dB
Spectrum bandwidth	± 100 kHz (depends on the used RBW)
Occupied bandwidth	± 100 kHz (depends on the used RBW)
Maximum output power	± 1.5 dB
Minimum emissions bandwidth	± 100 kHz (depends on the used RBW)
Spurious emissions conducted	± 3 dB
Spurious emissions radiated below 30 MHz	± 3 dB
Spurious emissions radiated 30 MHz to 1 GHz	± 3 dB
Spurious emissions radiated 1 GHz to 12.75 GHz	± 3.7 dB
Spurious emissions radiated above 12.75 GHz	± 4.5 dB
Spurious emissions conducted below 30 MHz (AC conducted)	± 2.6 dB



## 9 Summary of measurement results

<input type="checkbox"/>	No deviations from the technical specifications were ascertained
<input type="checkbox"/>	There were deviations from the technical specifications ascertained
<input checked="" type="checkbox"/>	This test report is only a partial test report. The content and verdict of the performed test cases are listed below.

TC Identifier	Description	Verdict	Date	Remark
RF-Testing	CFR Part 15 RSS 247, Issue 2	See table	2017-11-29	-/-

Test specification clause	Test case	Temperature conditions	Power source voltages	C	NC	NA	NP	Remark
-/-	Output power verification (cond.)	Nominal	Nominal	-/-				-/-
-/-	Antenna gain	Nominal	Nominal	-/-				-/-
U-NII Part 15	Duty cycle	Nominal	Nominal	-/-				-/-
§15.407(a) RSS - 247 (6.2.1.1) RSS - 247 (6.2.2.1) RSS - 247 (6.2.3.1) RSS - 247 (6.2.4.1)	Maximum output power (conducted & radiated)	Nominal	Nominal	<input checked="" type="checkbox"/>	<input type="checkbox"/>	<input type="checkbox"/>	<input type="checkbox"/>	-/-
§15.407(a) RSS - 247 (6.2.1.1) RSS - 247 (6.2.2.1) RSS - 247 (6.2.3.1) RSS - 247 (6.2.4.1)	Power spectral density	Nominal	Nominal	<input checked="" type="checkbox"/>	<input type="checkbox"/>	<input type="checkbox"/>	<input type="checkbox"/>	-/-
RSS - 247 (6.2.4.1)	Spectrum bandwidth 6dB bandwidth	Nominal	Nominal	<input checked="" type="checkbox"/>	<input type="checkbox"/>	<input type="checkbox"/>	<input type="checkbox"/>	-/-
§15.407(a) RSS - 247 (6.2.1.2)	Spectrum bandwidth 26dB bandwidth	Nominal	Nominal	<input checked="" type="checkbox"/>	<input type="checkbox"/>	<input type="checkbox"/>	<input type="checkbox"/>	-/-
RSS Gen clause 6.6	Spectrum bandwidth 99% bandwidth	Nominal	Nominal	-/-				-/-
§15.205 RSS - 247 (6.2.1.2) RSS - 247 (6.2.2.2) RSS - 247 (6.2.3.2) RSS - 247 (6.2.4.2)	Band edge compliance radiated	Nominal	Nominal	<input checked="" type="checkbox"/>	<input type="checkbox"/>	<input type="checkbox"/>	<input type="checkbox"/>	-/-
§15.407(b) RSS - 247 (6.2.1.2) RSS - 247 (6.2.2.2) RSS - 247 (6.2.3.2) RSS - 247 (6.2.4.2)	TX spurious emissions radiated	Nominal	Nominal	<input checked="" type="checkbox"/>	<input type="checkbox"/>	<input type="checkbox"/>	<input type="checkbox"/>	-/-
§15.109 RSS-Gen	RX spurious emissions radiated	Nominal	Nominal	<input checked="" type="checkbox"/>	<input type="checkbox"/>	<input type="checkbox"/>	<input type="checkbox"/>	-/-
§15.209(a) RSS-Gen	Spurious emissions radiated < 30 MHz	Nominal	Nominal	<input checked="" type="checkbox"/>	<input type="checkbox"/>	<input type="checkbox"/>	<input type="checkbox"/>	-/-
§15.107(a) §15.207	Spurious emissions conducted emissions < 30 MHz	Nominal	Nominal	<input checked="" type="checkbox"/>	<input type="checkbox"/>	<input type="checkbox"/>	<input type="checkbox"/>	-/-
§15.407 RSS - 247 (6.3)	DFS	Nominal	Nominal	-/-				See report 1-4862/17-01-04

**Notes:**

<b>C:</b> Compliant	<b>NC:</b> Not compliant	<b>NA:</b> Not applicable	<b>NP:</b> Not performed
---------------------	--------------------------	---------------------------	--------------------------

## 10 Additional comments

Reference documents: DFS report: 1-4862\_17-01-04

Special test descriptions:

Channel	36	40	44	48	52	56	60	64	100	120	140	149	157	165
11a	13	13	13	13	13	13	13	13	13	13	13	13	13	13
11n-20	12	12	12	12	12	12	12	12	12	12	12	12	12	12
11n-40	9	9	9	9	9	9	9	9	6	9	9	9	9	9

In addition to the power table above, Ingenico calibration files were used. These files have a relevant impact on the performance and spectral appearance of each channel

Configuration descriptions: None

Provided channels:

Channels with 20 MHz channel bandwidth:

U-NII-1 & U-NII-2A (5150 MHz to 5250 MHz & 5250 MHz to 5350 MHz) channel number & centre frequency								
<b>channel</b>	<b>36</b>	<b>40</b>	44	<b>48</b>	<b>52</b>	56	<b>60</b>	<b>64</b>
<b>f<sub>c</sub> / MHz</b>	<b>5180</b>	<b>5200</b>	5220	<b>5240</b>	<b>5260</b>	5280	<b>5300</b>	<b>5320</b>

U-NII-2C (5470 MHz to 5725 MHz) channel number & centre frequency											
<b>channel</b>	<b>100</b>	104	108	112	116	<b>120</b>	124	128	132	136	<b>140</b>
<b>f<sub>c</sub> / MHz</b>	<b>5500</b>	5520	5540	5560	5580	<b>5600</b>	5620	5640	5660	5680	<b>5700</b>

U-NII-3 (5725 MHz to 5850 MHz) channel number & centre frequency					
<b>channel</b>	<b>149</b>	153	<b>157</b>	161	<b>165</b>
<b>f<sub>c</sub> / MHz</b>	<b>5745</b>	5765	<b>5785</b>	5805	<b>5825</b>

Channels with 40 MHz channel bandwidth:

U-NII-1 & U-NII-2A (5150 MHz to 5250 MHz & 5250 MHz to 5350 MHz) channel number & centre frequency					
<b>channel</b>	<b>38</b>	42	<b>46</b>	<b>54</b>	<b>62</b>
<b>f<sub>c</sub> / MHz</b>	<b>5190</b>	5210	<b>5230</b>	<b>5270</b>	<b>5310</b>

U-NII-2C (5470 MHz to 5725 MHz) channel number & centre frequency					
<b>channel</b>	<b>102</b>	110	<b>118</b>	126	<b>134</b>
<b>f<sub>c</sub> / MHz</b>	<b>5510</b>	5550	<b>5590</b>	5630	<b>5670</b>

U-NII-3 (5725 MHz to 5850 MHz) channel number & centre frequency		
<b>channel</b>	<b>151</b>	<b>159</b>
<b>f<sub>c</sub> / MHz</b>	<b>5755</b>	<b>5795</b>

Note: The channels used for the tests were marked in bold in the list.

- Test mode:
- No test mode available.  
lperf was used to ping another device with the largest support packet size
  - Special software is used.  
EUT is transmitting pseudo random data by itself
- Antennas and transmit operating modes:
- Operating mode 1 (single antenna)
    - *Equipment with 1 antenna,*
    - *Equipment with 2 diversity antennas operating in switched diversity mode by which at any moment in time only 1 antenna is used,*
    - *Smart antenna system with 2 or more transmit/receive chains, but operating in a mode where only 1 transmit/receive chain is used)*
  - Operating mode 2 (multiple antennas, no beamforming)
    - *Equipment operating in this mode contains a smart antenna system using two or more transmit/receive chains simultaneously but without beamforming.*
  - Operating mode 3 (multiple antennas, with beamforming)
    - *Equipment operating in this mode contains a smart antenna system using two or more transmit/receive chains simultaneously with beamforming.  
In addition to the antenna assembly gain (G), the beamforming gain (Y) may have to be taken into account when performing the measurements.*

## 11 Measurement results

### 11.1 Identify worst case data rate

**Measurement:**

All modes of the module will be measured with an average/peak power meter to identify the maximum transmission power on mid channel. In the case that only one or two channels are available, only these will be measured.

In further tests only the identified worst case modulation scheme or bandwidth will be measured.

**Measurement parameters:**

Measurement parameter	
Detector:	Peak
Sweep time:	Auto
Resolution bandwidth:	3 MHz
Video bandwidth:	3 MHz
Trace mode:	Max hold
Used test setup:	See chapter 6.5 – B
Measurement uncertainty:	See chapter 8

**Results:**

OFDM – mode	Modulation scheme / bandwidth					
	U-NII-1 & U-NII-2A		U-NII-2C		U-NII-3	
	Low channel	high channel	Low channel	high channel	Low channel	high channel
a – mode	6Mbit/s	6Mbit/s	6Mbit/s	6Mbit/s	6Mbit/s	6Mbit/s
n/ac HT20 – mode	MCS0	MCS0	MCS0	MCS0	MCS0	MCS0
n/ac HT40 – mode	MCS0	MCS0	MCS0	MCS0	MCS0	MCS0

## 11.2 Antenna gain

### Description:

The antenna gain of the complete system is calculated by the difference of radiated power in EIRP and the conducted power of the module.

### Measurement parameters:

Measurement parameter	
Detector:	Peak
Sweep time:	Auto
Resolution bandwidth:	3 MHz
Video bandwidth:	3 MHz
Trace mode:	Max. hold
Test setup:	See chapter 6.2 – C (radiated) See chapter 6.5 – A (conducted)
Measurement uncertainty:	See chapter 8

### Limits:

Antenna Gain
6 dBi / > 6 dBi output power and power density reduction required

**Results:**

U-NII-1 (5150 MHz to 5250 MHz)	Antenna gain		
	Lowest channel	Middle channel	Highest channel
Conducted power / dBm @ 3 MHz RBW	14.4	14.3	13.8
Radiated power / dBm @ 3 MHz RBW	18.3	18.1	17.4
Gain / dBi calculated	4.0	3.8	3.6

U-NII-2A (5250 MHz to 5350 MHz)	Antenna gain		
	Lowest channel	Middle channel	Highest channel
Conducted power / dBm @ 3 MHz RBW	13.9	14.3	14.9
Radiated power / dBm @ 3 MHz RBW	18.1	18.7	19.6
Gain / dBi calculated	4.2	4.4	4.7

U-NII-2C (5470 MHz to 5725 MHz)	Antenna gain		
	Lowest channel	Middle channel	Highest channel
Conducted power / dBm @ 3 MHz RBW	17.3	15.0	14.7
Radiated power / dBm @ 3 MHz RBW	22.6	19.5	18.2
Gain / dBi calculated	5.3	4.5	3.5

U-NII-3 (5725 MHz to 5850 MHz)	Antenna gain		
	Lowest channel	Middle channel	Highest channel
Conducted power / dBm @ 3 MHz RBW	15.4	15.0	16.0
Radiated power / dBm @ 3 MHz RBW	19.3	18.4	19.1
Gain / dBi calculated	3.9	3.4	3.1

**Plots (conducted):**

**Plot 1:** U-NII-1; lowest channel

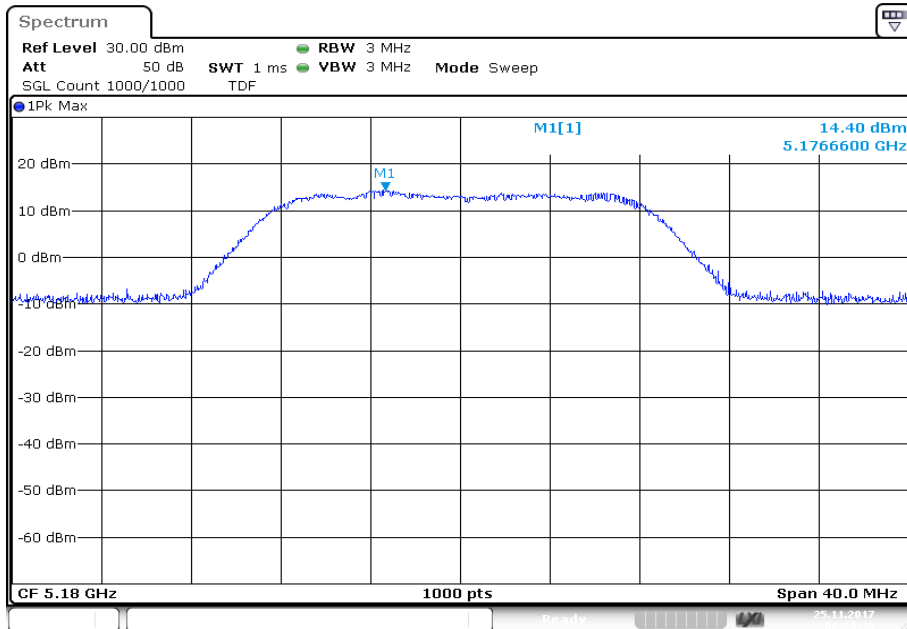

Date: 25.NOV.2017 06:28:49

**Plot 2:** U-NII-1; middle channel

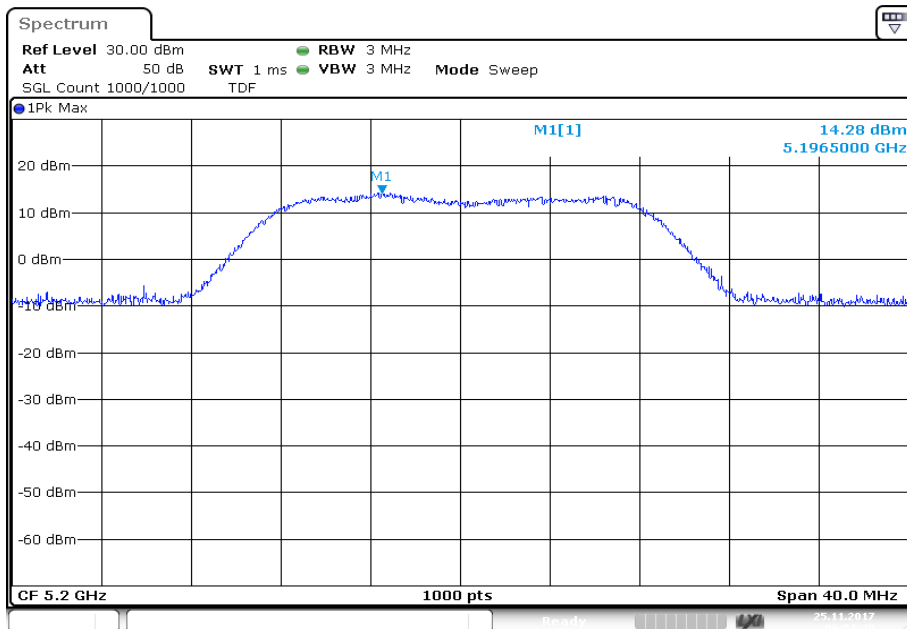

Date: 25.NOV.2017 06:51:30

**Plot 3:** U-NII-1; highest channel

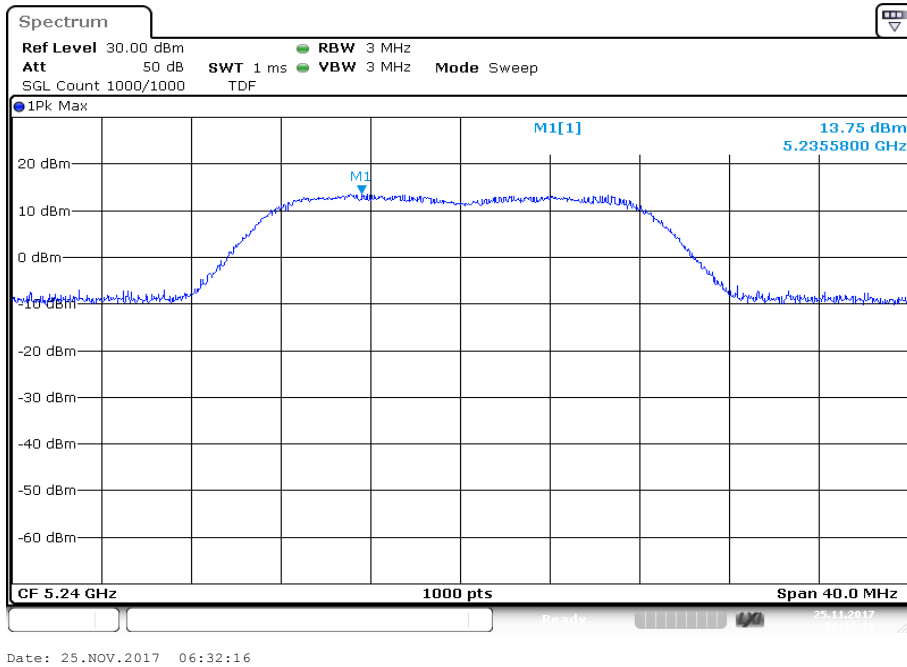

**Plot 4:** U-NII-2A; lowest channel

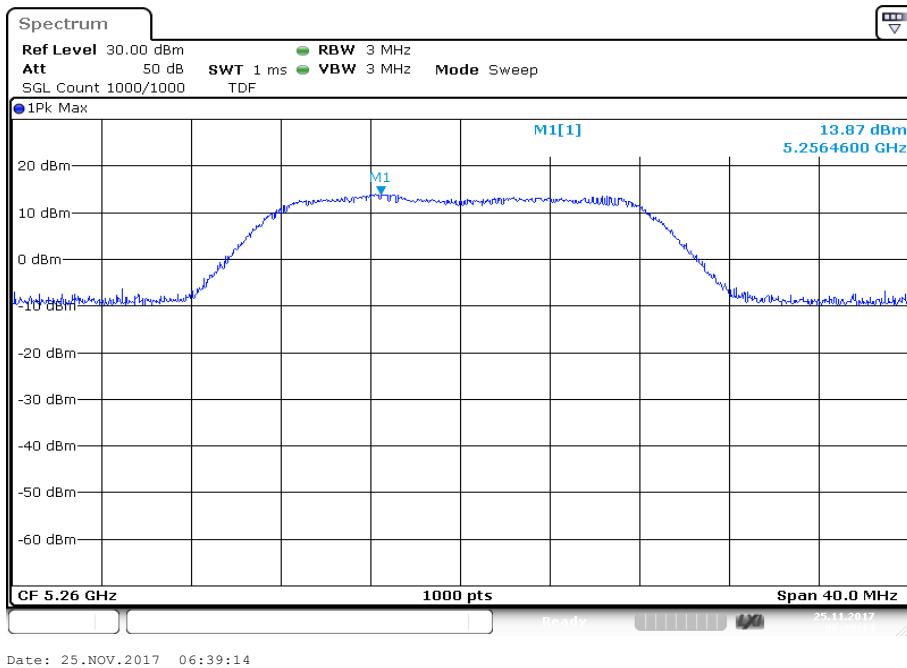





**Plot 7:** U-NII-2C; lowest channel

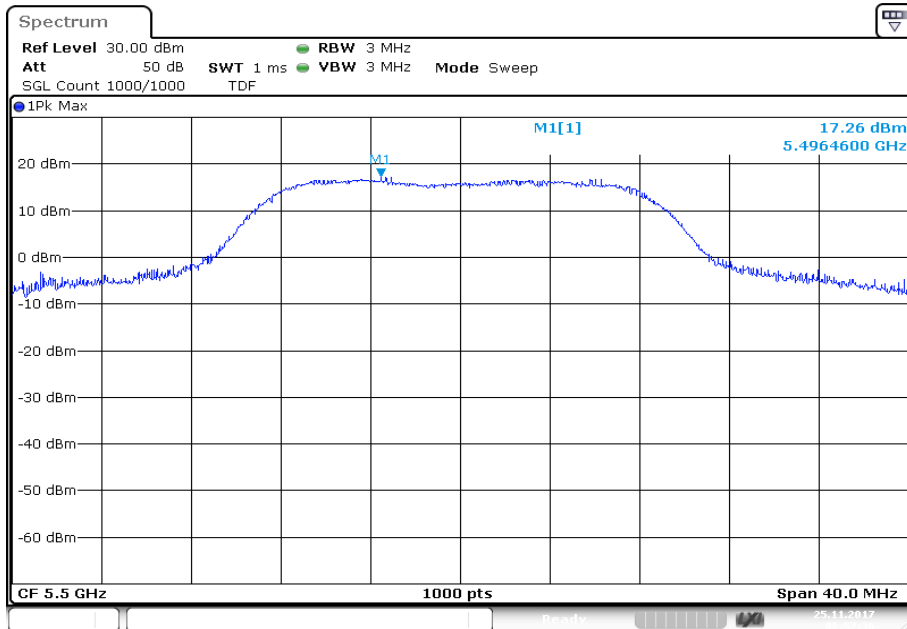

Date: 25.NOV.2017 06:57:36

**Plot 8:** U-NII-2C; middle channel

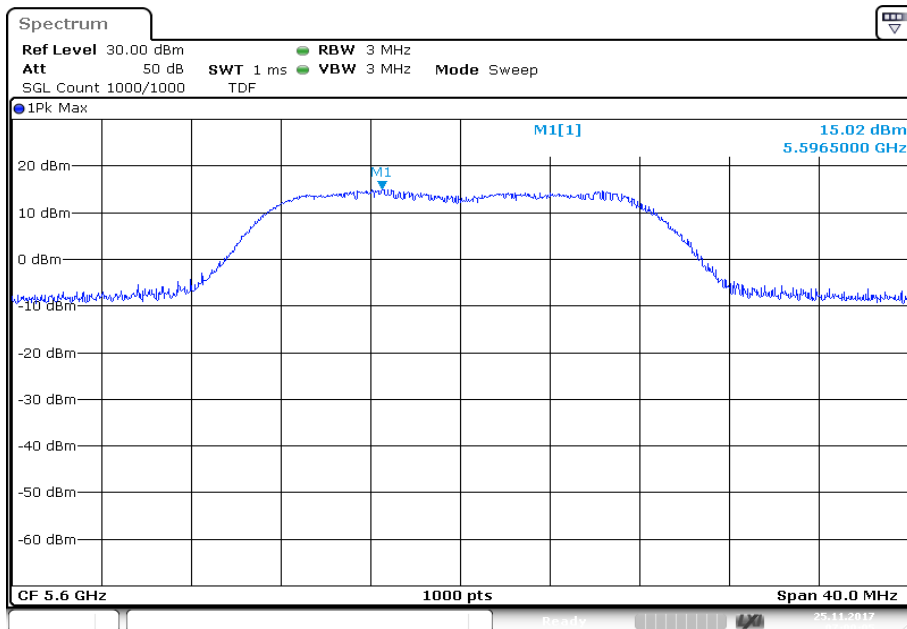

Date: 25.NOV.2017 07:00:06

**Plot 9:** U-NII-2C; highest channel

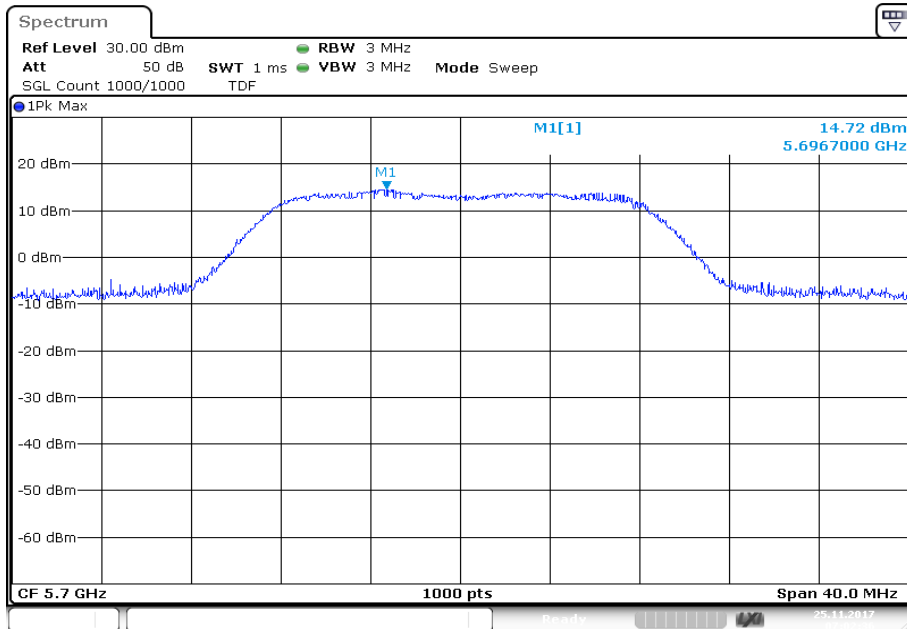

Date: 25.NOV.2017 07:02:36

**Plot 10:** U-NII-3; lowest channel

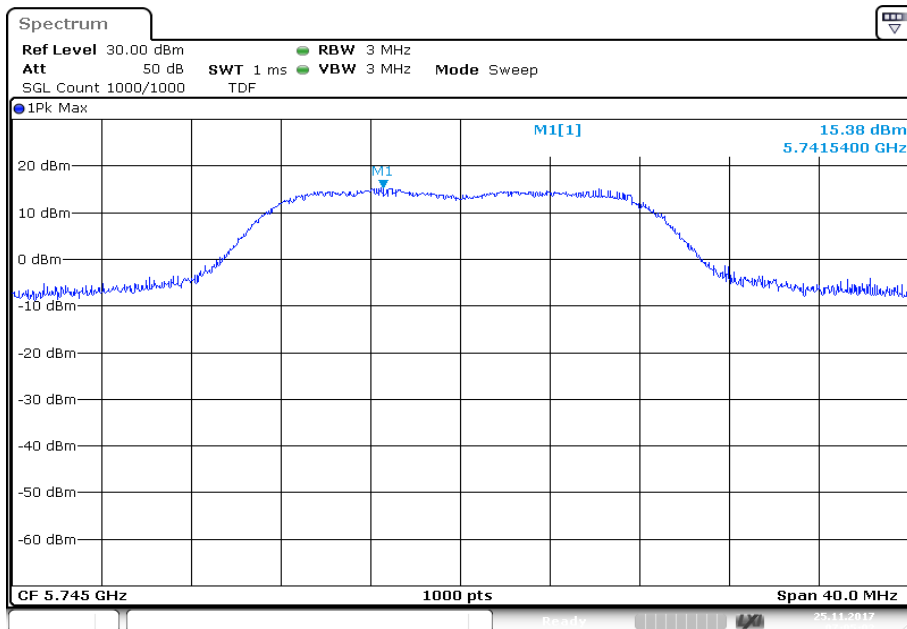

Date: 25.NOV.2017 07:05:02

Plot 11: U-NII-3; middle channel

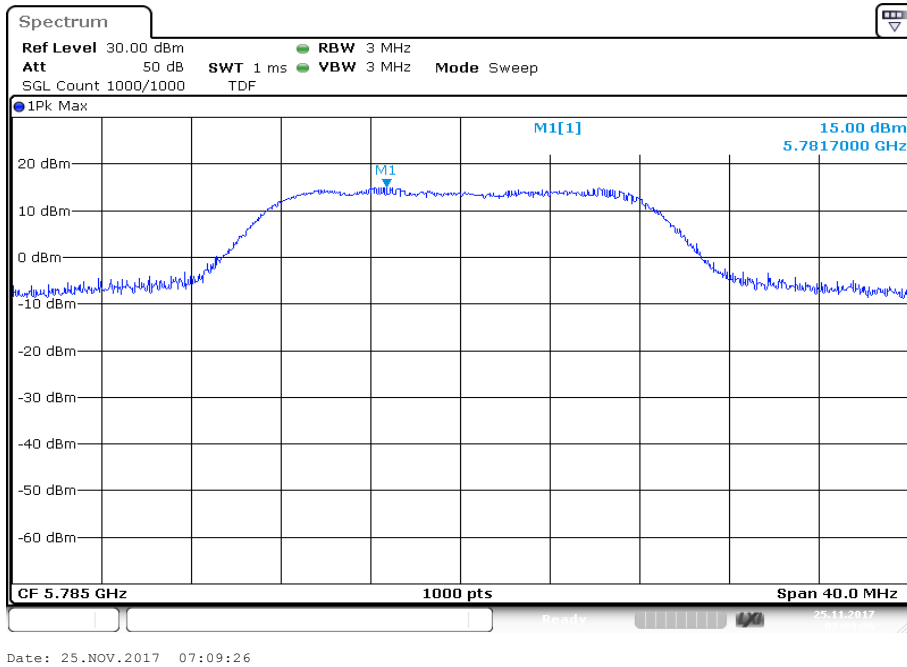

Plot 12: U-NII-3; highest channel

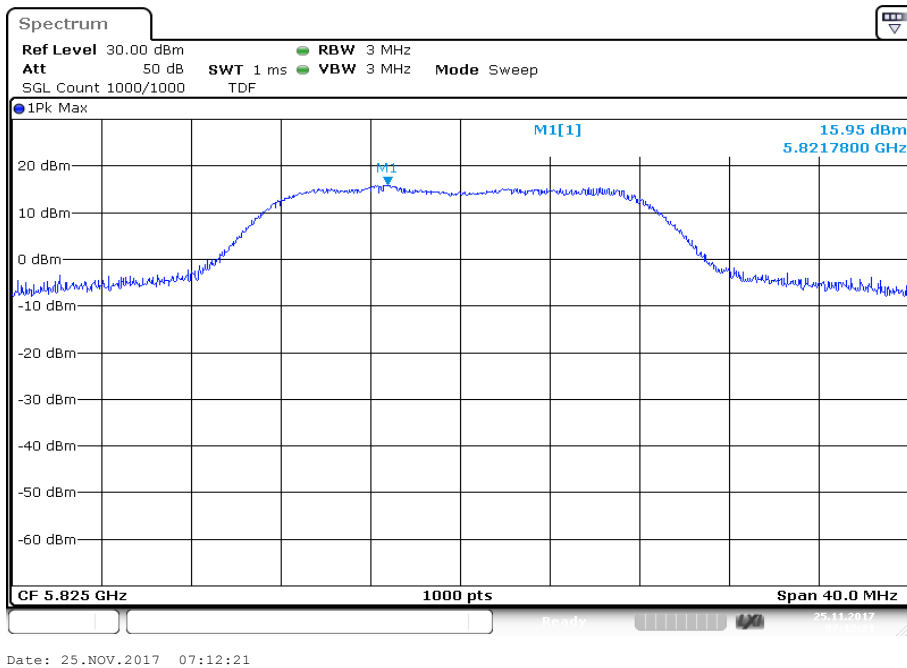

## 11.3 Duty cycle

### Description:

The duty cycle is necessary to compute the maximum power during an actual transmission. The shown plots and values are to show an example of the measurement procedure. The real value is measured direct during the power measurement or power density measurement. The correction value is shown in each plot of these measurements.

### Measurement:

Measurement parameter	
According to: KDB789033 D02, B.	
Detector:	Peak
Sweep time:	Auto
Resolution bandwidth:	10 MHz
Video bandwidth:	10 MHz
Span:	Zero
Trace mode:	Video trigger / view / single sweep
Used test setup:	See chapter 6.5 – A
Measurement uncertainty:	See chapter 8

### Results:

Duty cycle and correction factor:

OFDM – mode	Calculation method			
	$T_{on} (D2_{plot}) * 100 / T_{complete} (D3_{plot}) = \text{duty cycle}$ $10 * \log(\text{duty cycle}) = \text{correction factor}$			
	$T_{on} (D2_{plot})$	$T_{complete} (D3_{plot})$	Duty cycle	Correction factor
a – mode	-/-	-/-	100 %	0.0 dB
n/ac HT20 – mode	-/-	-/-	100 %	0.0 dB
n/ac HT40 – mode	-/-	-/-	100 %	0.0 dB
ac HT80 – mode	-/-	-/-	100 %	0.0 dB
ac HT160 – mode	-/-	-/-	100 %	0.0 dB

## 11.4 Maximum output power

### 11.4.1 Maximum output power according to FCC requirements

**Description:**

Measurement of the maximum output power conducted

**Measurement:**

Measurement parameter	
According to: KDB789033 D02, E.2.e.	
Detector:	RMS
Sweep time:	$\geq 10 \cdot (\text{swp points}) \cdot (\text{total on/off time})$
Resolution bandwidth:	1 MHz
Video bandwidth:	3 MHz
Span:	> EBW
Trace mode:	Max hold
Analyzer function	Band power / channel power Interval > 26 dB EBW
Used test setup:	See chapter 6.5 – A
Measurement uncertainty:	See chapter 8

**Limits:**

Radiated output power	Conducted output power for mobile equipment
Conducted power + 6 dBi antenna gain	250mW 5.150-5.250 GHz The lesser one of 250mW or 11 dBm + 10 log Bandwidth 5.250-5.350 GHz 250mW or 11 dBm + 10 log Bandwidth 5.470-5.725 GHz (where Bandwidth is the 26dB Bandwidth [MHz]) 1W 5.725-5.85 GHz

**Results:**

a	Maximum output power conducted [dBm]		
	<b>U-NII-1 (5150 MHz to 5250 MHz)</b>		
	Lowest channel	Middle channel	Highest channel
	11.8	11.8	11.6
	<b>U-NII-2A (5250 MHz to 5350 MHz)</b>		
	Lowest channel	Middle channel	Highest channel
	11.7	12.6	12.7
	<b>U-NII-2C (5470 MHz to 5725 MHz)</b>		
	Lowest channel	Middle channel	Highest channel
	15.0	13.6	12.2
	<b>U-NII-3 (5725 MHz to 5850 MHz)</b>		
	Lowest channel	Middle channel	Highest channel
	13.1	12.9	13.6

**Results:**

n/ac HT20	Maximum output power conducted [dBm]		
	<b>U-NII-1 (5150 MHz to 5250 MHz)</b>		
	Lowest channel	Middle channel	Highest channel
	10.3	10.3	10.2
	<b>U-NII-2A (5250 MHz to 5350 MHz)</b>		
	Lowest channel	Middle channel	Highest channel
	10.4	11.4	11.3
	<b>U-NII-2C (5470 MHz to 5725 MHz)</b>		
	Lowest channel	Middle channel	Highest channel
	14.2	11.5	11.4
	<b>U-NII-3 (5725 MHz to 5850 MHz)</b>		
	Lowest channel	Middle channel	Highest channel
	11.7	11.6	12.4

**Results:**

<b>n/ac HT40</b>	<b>Maximum output power conducted [dBm]</b>		
	<b>U-NII-1 (5150 MHz to 5250 MHz)</b>		
	Lowest channel		Highest channel
	5.3		5.1
	<b>U-NII-2A (5250 MHz to 5350 MHz)</b>		
	Lowest channel		Highest channel
	5.7		6.6
	<b>U-NII-2C (5470 MHz to 5725 MHz)</b>		
	Lowest channel	Middle channel	Highest channel
	9.5	9.1	7.7
	<b>U-NII-3 (5725 MHz to 5850 MHz)</b>		
	Lowest channel		Highest channel
	8.9		8.7



**Plots:** a – mode

**Plot 1:** U-NII-1; lowest channel

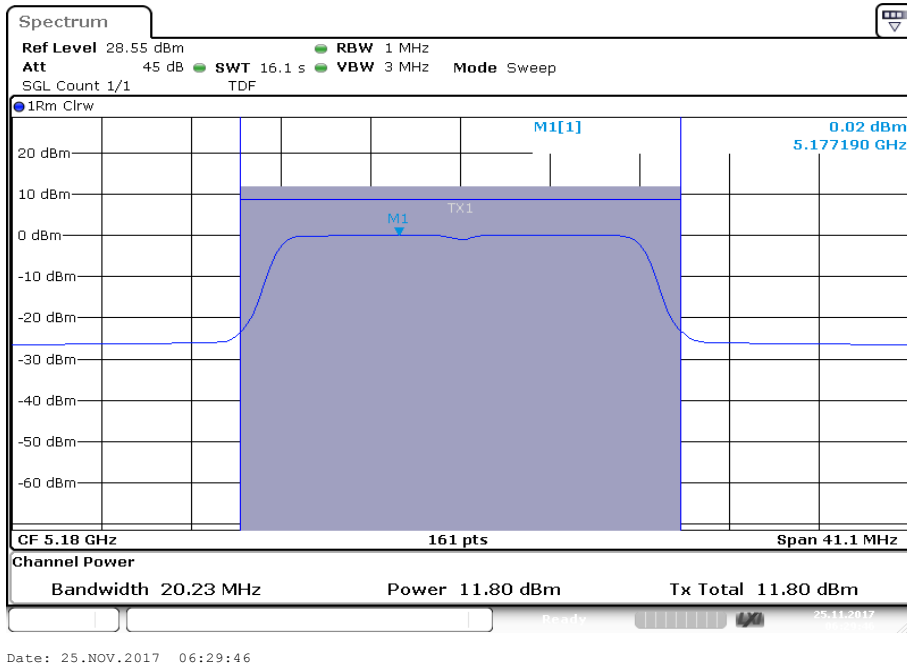

**Plot 2:** U-NII-1; middle channel

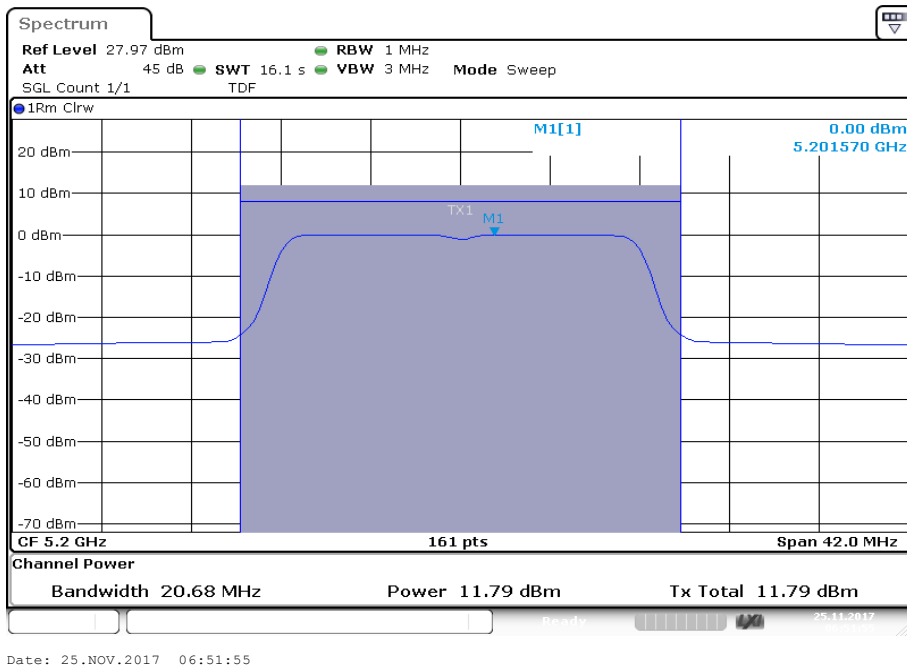

**Plot 3:** U-NII-1; highest channel

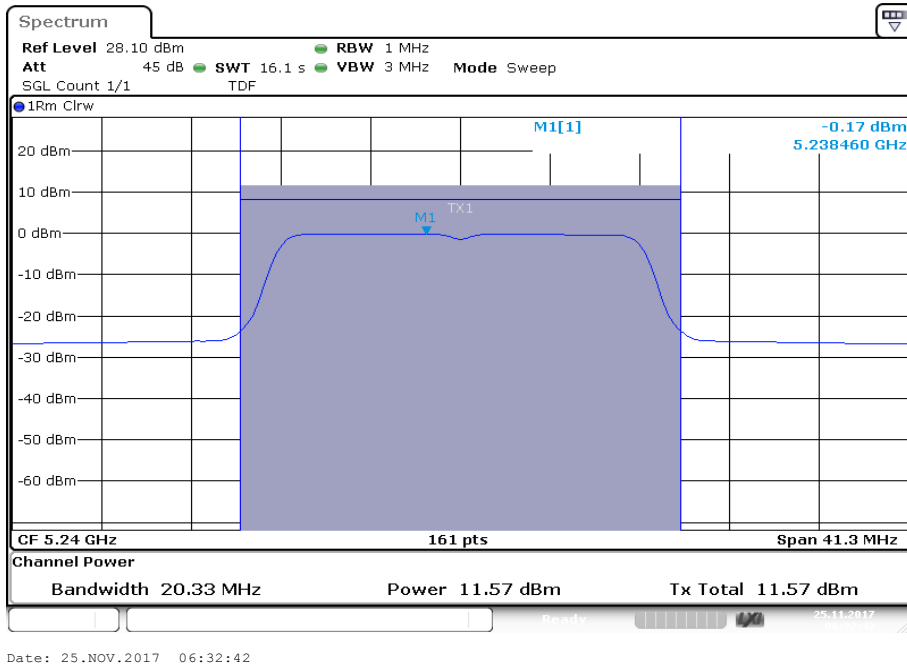

**Plot 4:** U-NII-2A; lowest channel

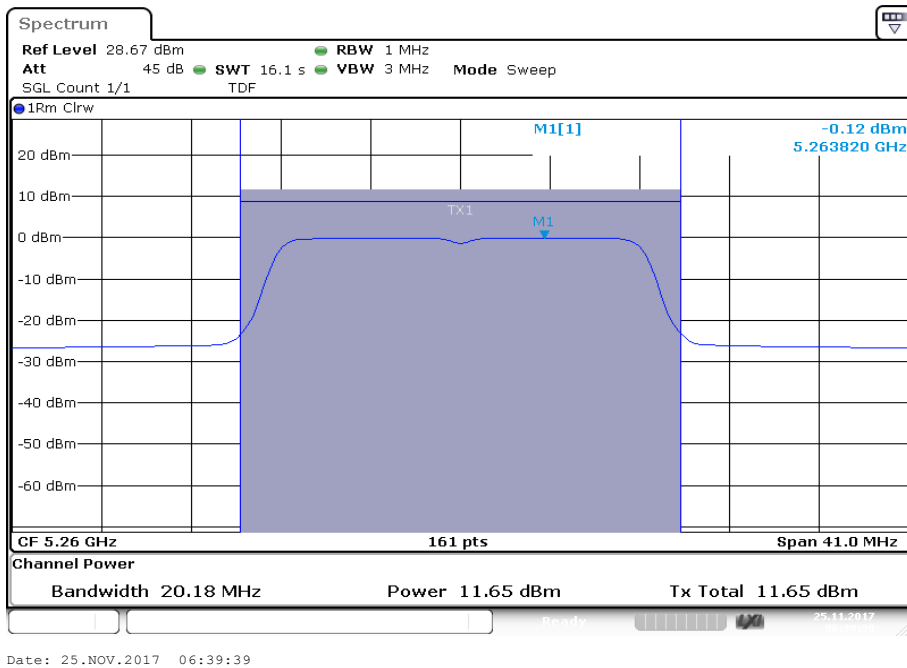

**Plot 5:** U-NII-2A; middle channel

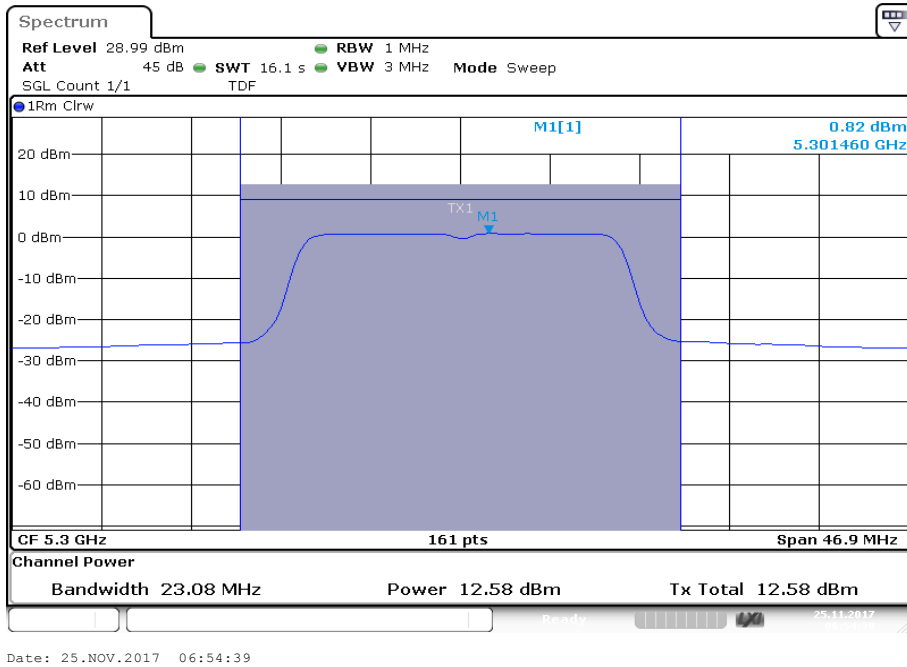

**Plot 6:** U-NII-2A; highest channel

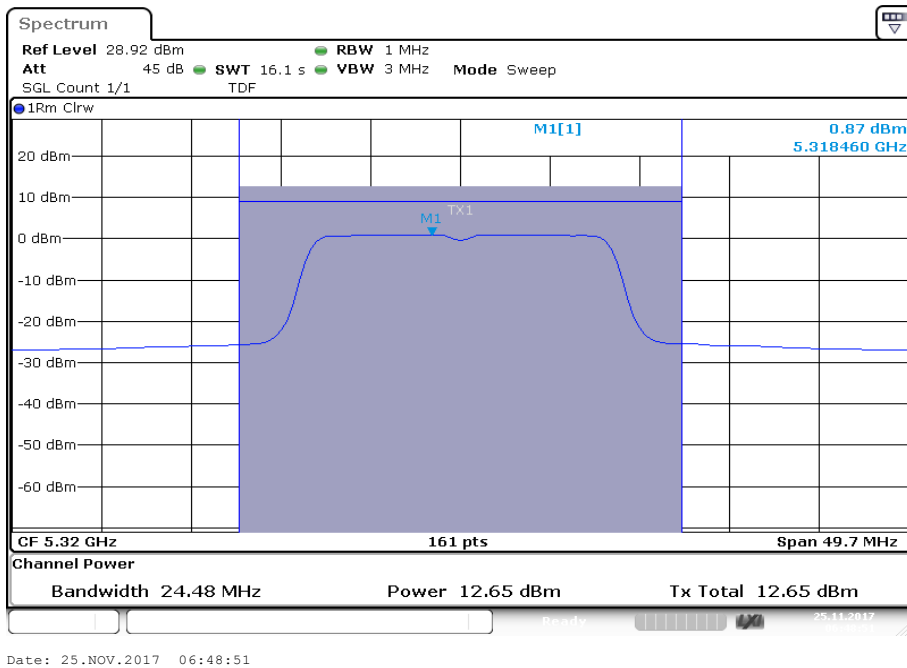

**Plot 7:** U-NII-2C; lowest channel

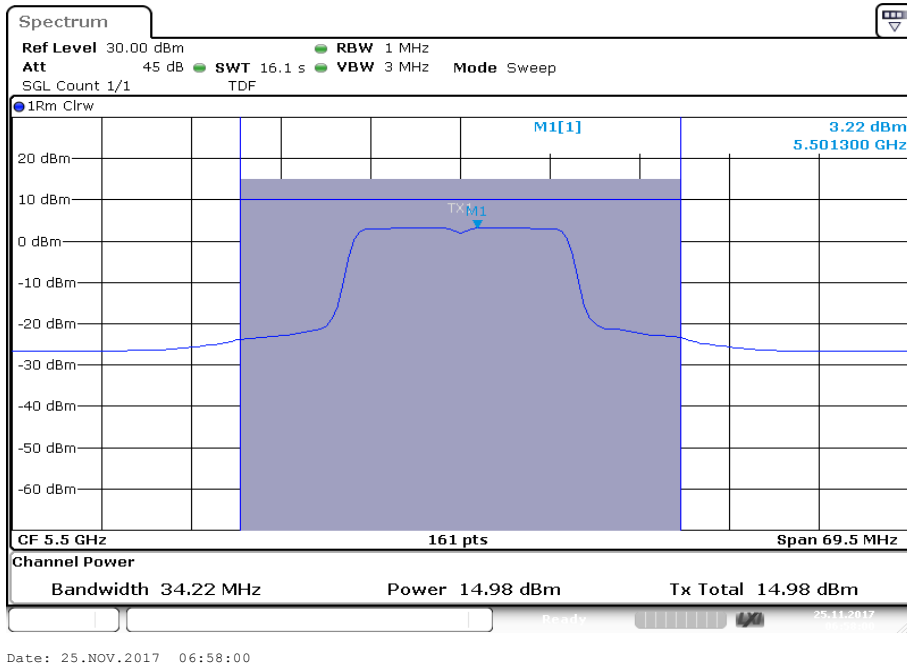

**Plot 8:** U-NII-2C; middle channel

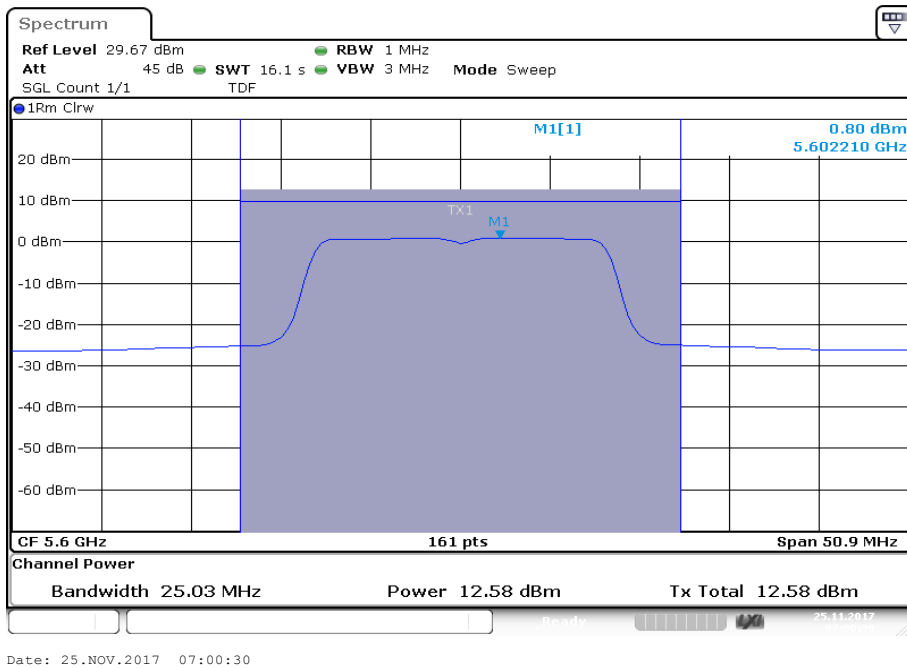

**Plot 9:** U-NII-2C; highest channel

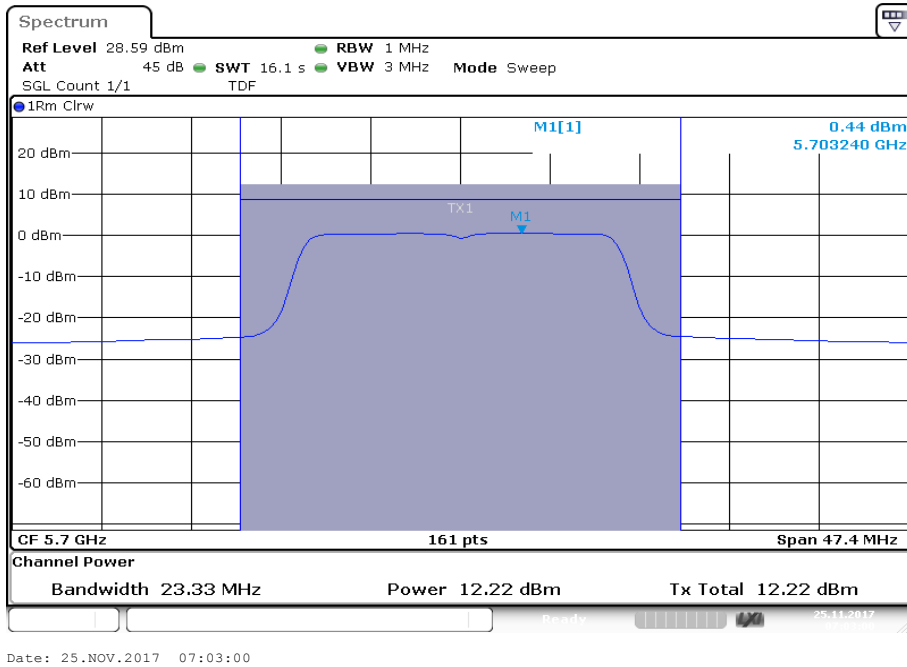

**Plot 10:** U-NII-3; lowest channel

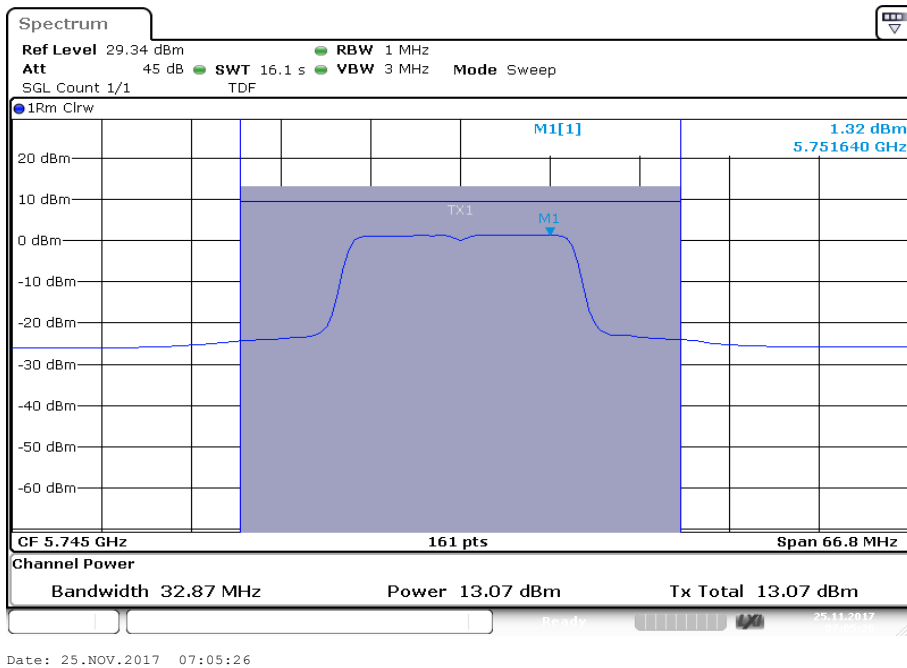

**Plot 11:** U-NII-3; middle channel

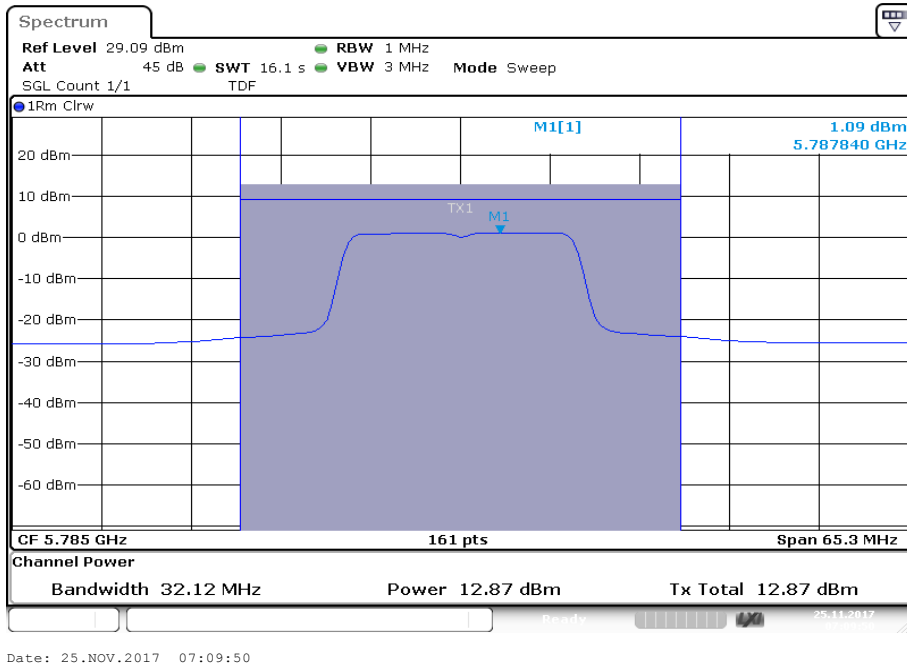

**Plot 12:** U-NII-3; highest channel

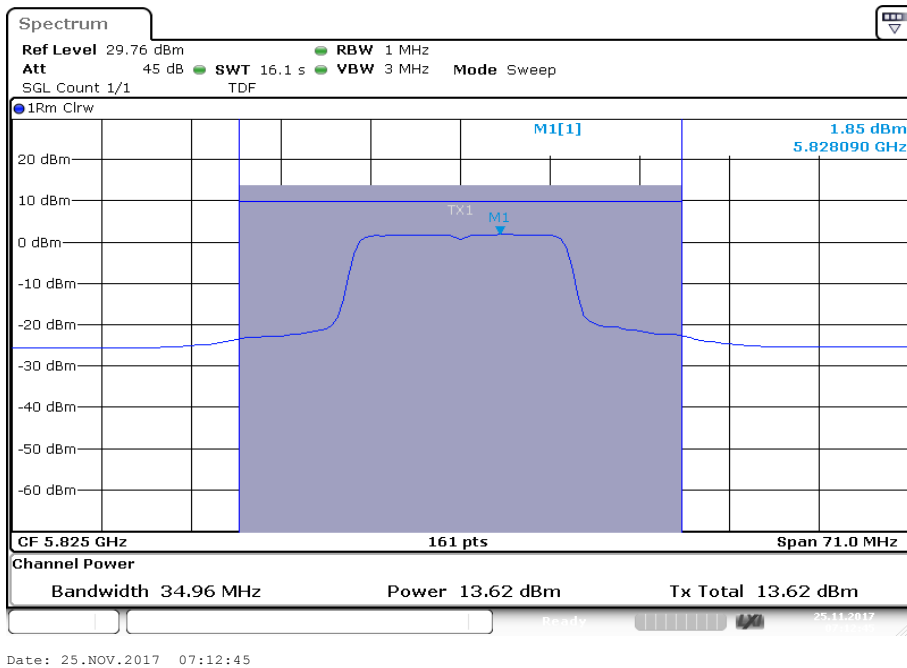

**Plots:** n/ac HT20 – mode

**Plot 1:** U-NII-1; lowest channel

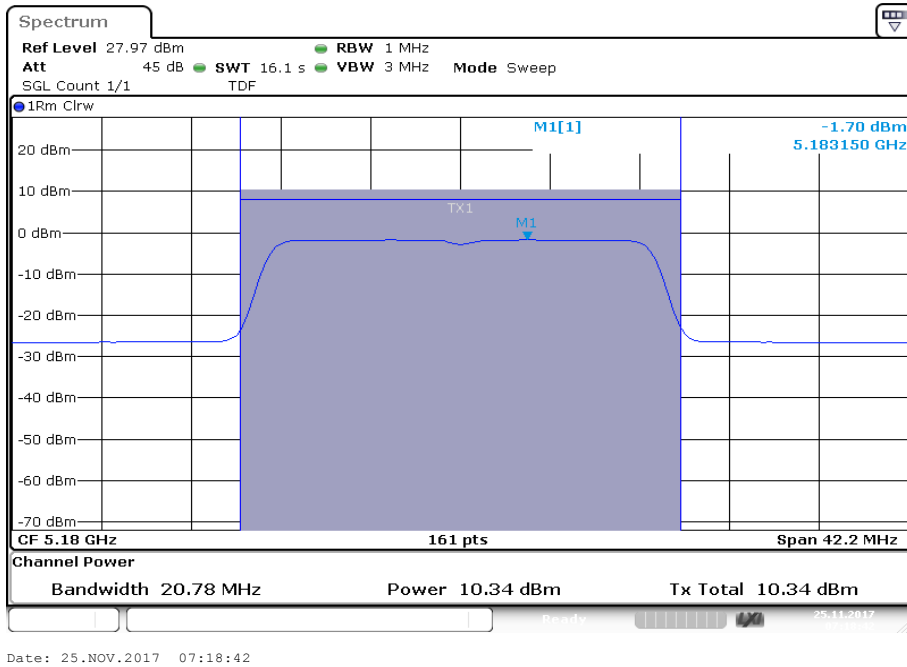

**Plot 2:** U-NII-1; middle channel

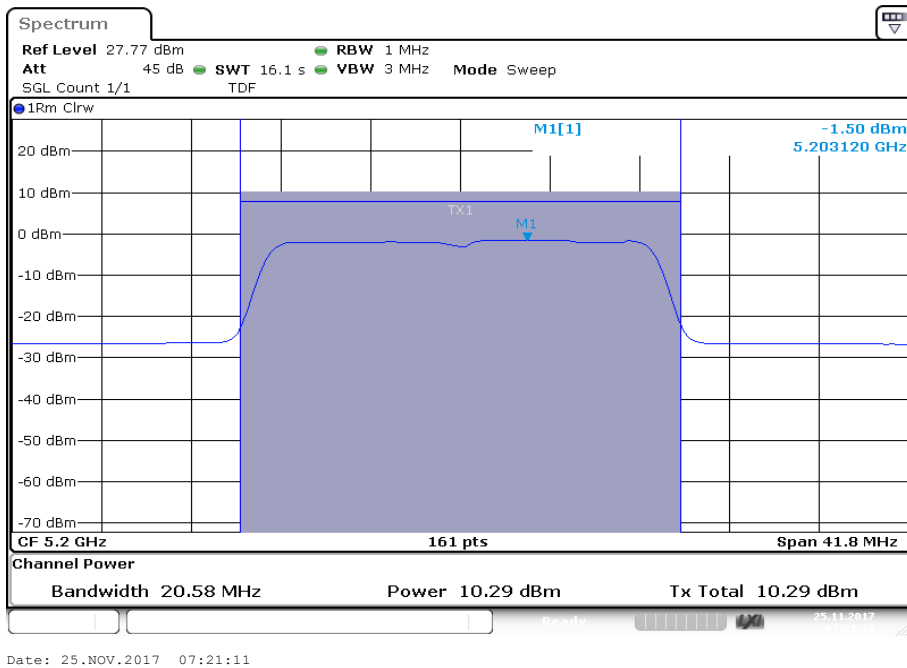

**Plot 3:** U-NII-1; highest channel

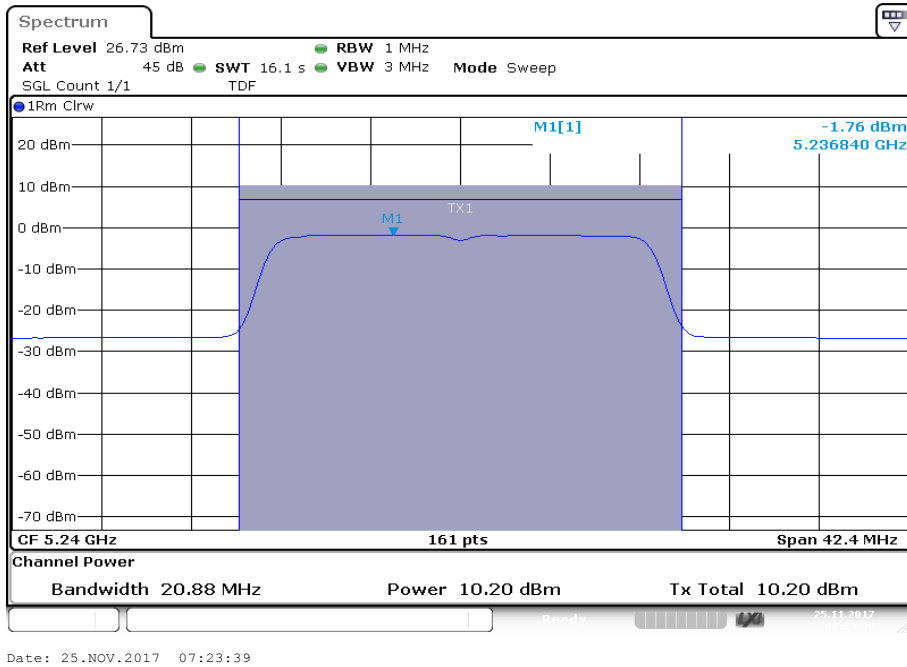

**Plot 4:** U-NII-2A; lowest channel

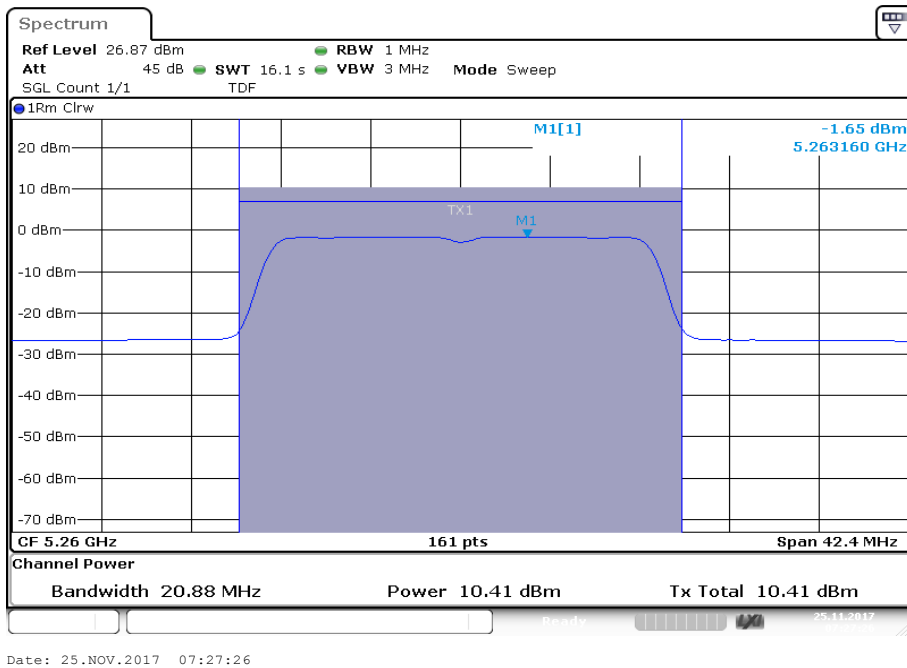



**Plot 5:** U-NII-2A; middle channel

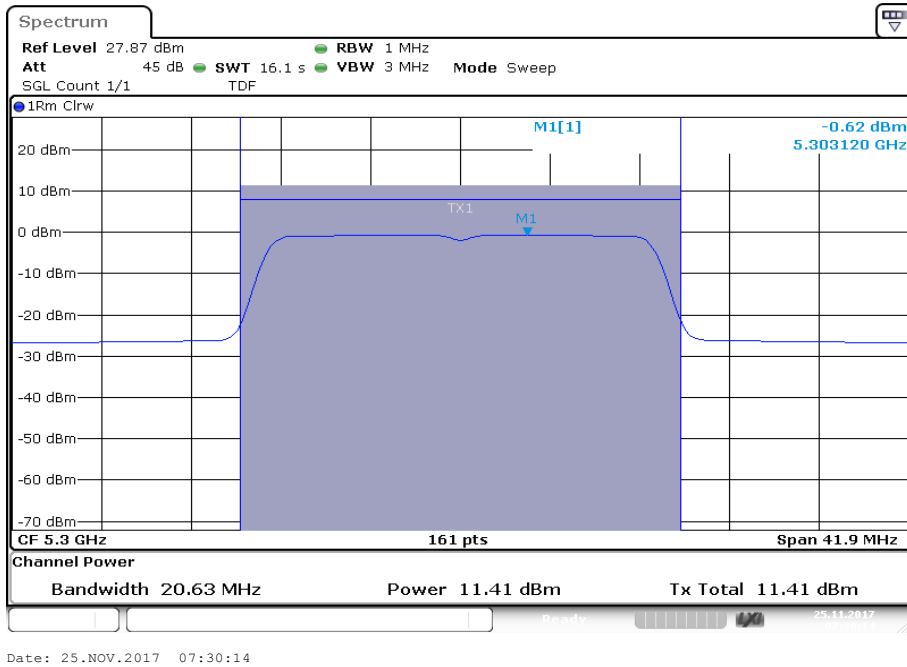

**Plot 6:** U-NII-2A; highest channel

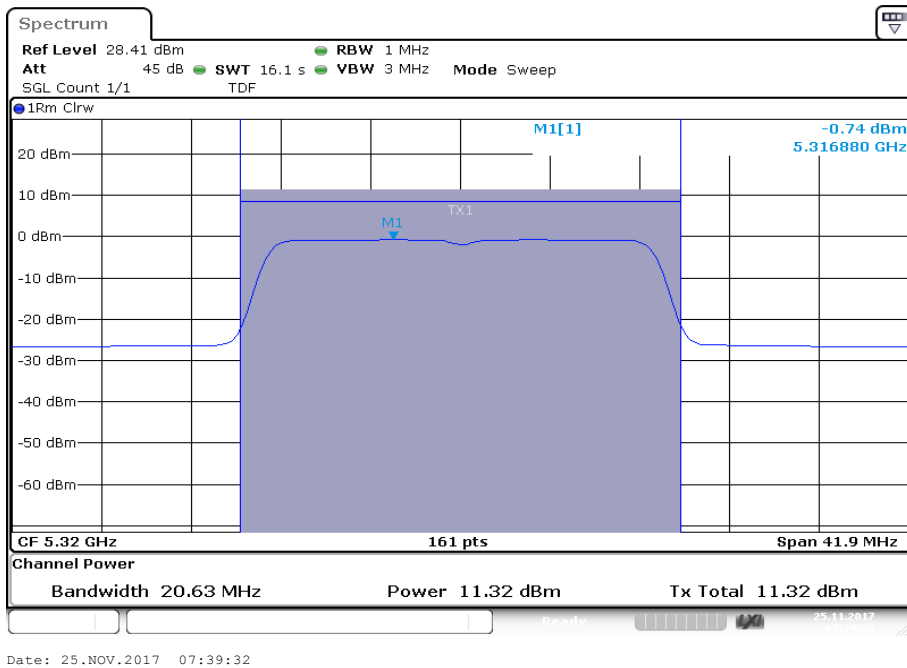

**Plot 7:** U-NII-2C; lowest channel

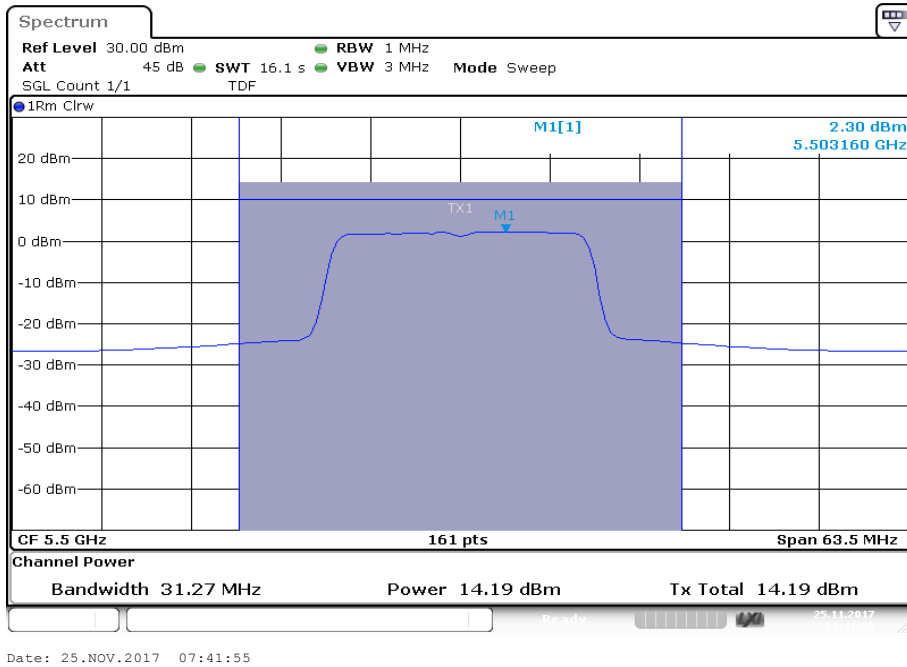

**Plot 8:** U-NII-2C; middle channel

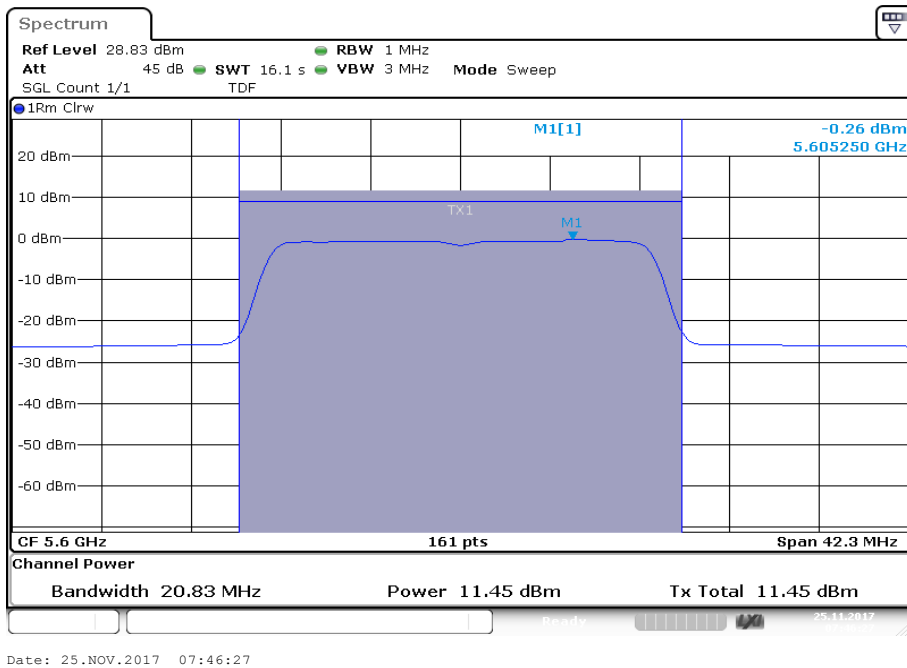

**Plot 9:** U-NII-2C; highest channel

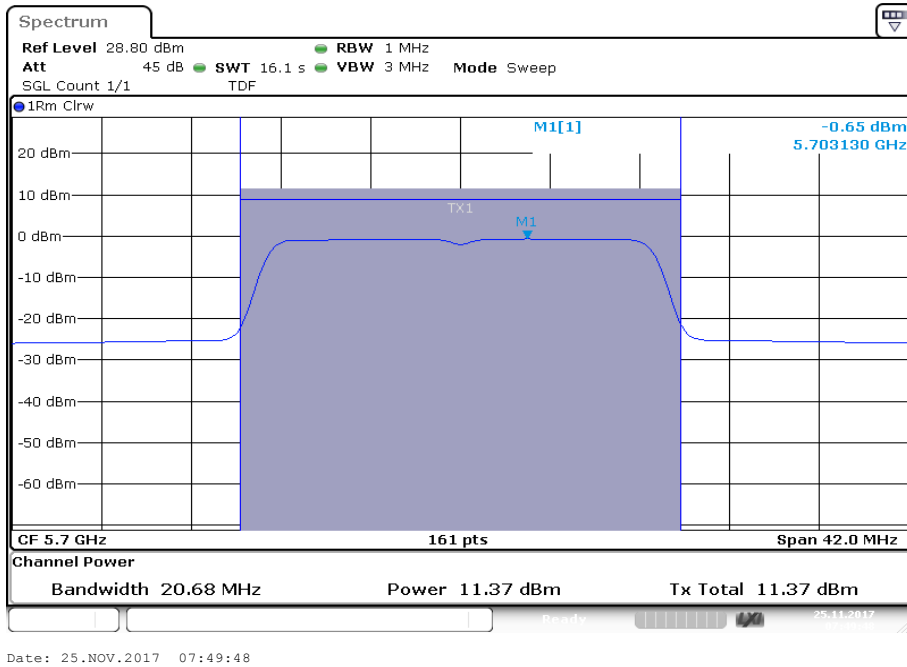

**Plot 10:** U-NII-3; lowest channel

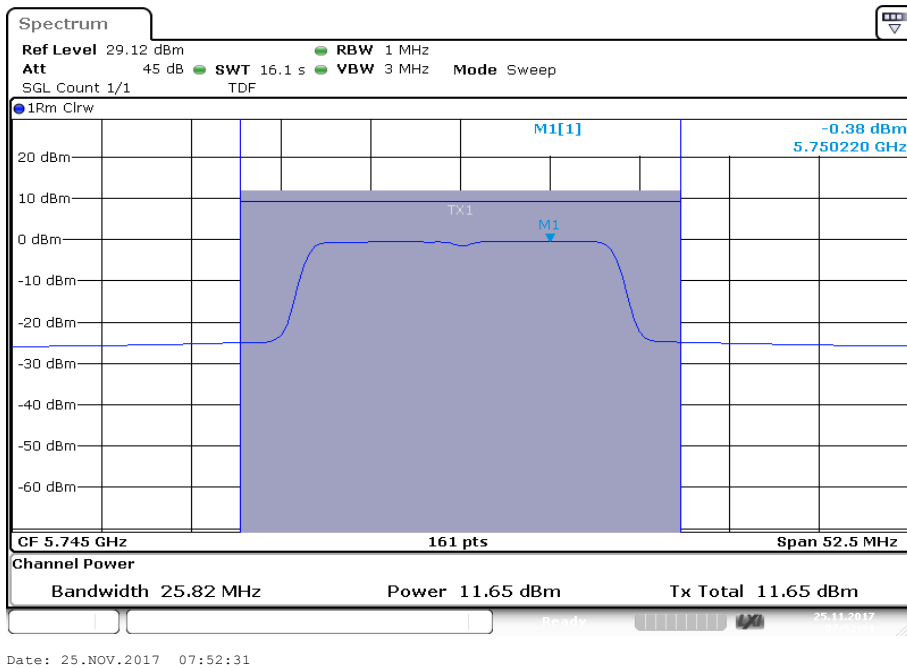

**Plot 11:** U-NII-3; middle channel

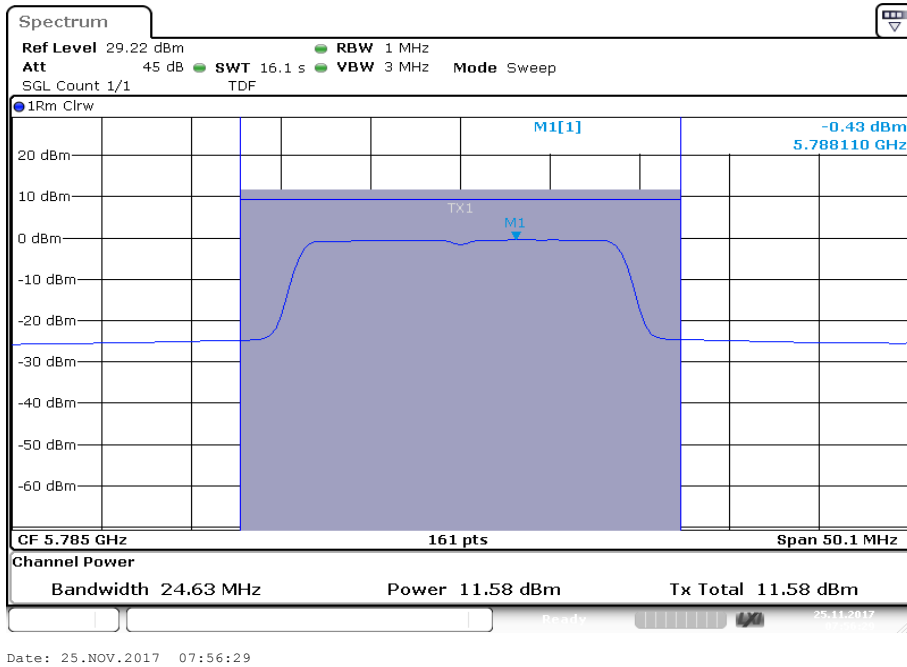

**Plot 12:** U-NII-3; highest channel

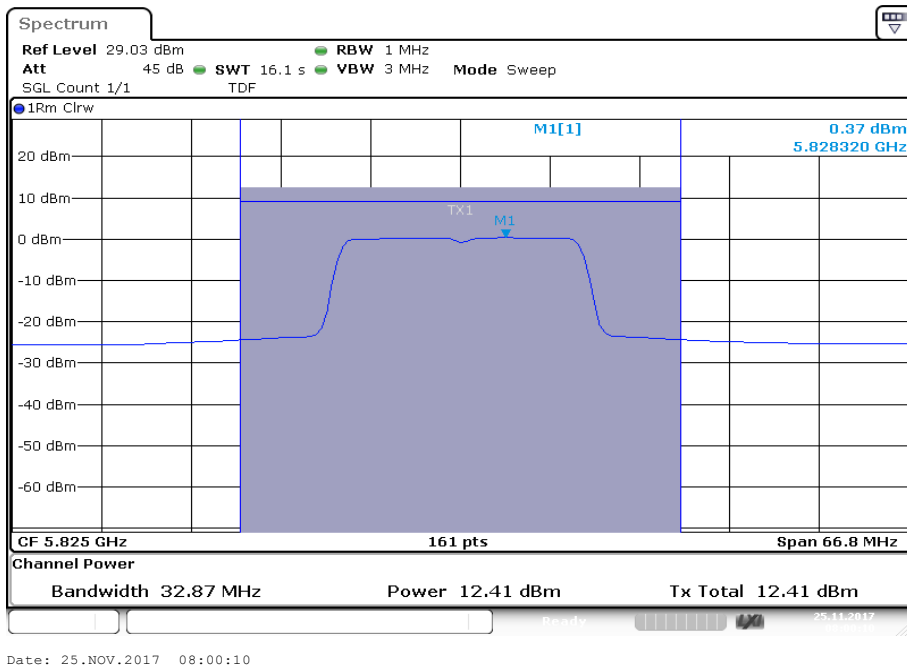

**Plots:** n/ac HT40 – mode

**Plot 1:** U-NII-1; lowest channel

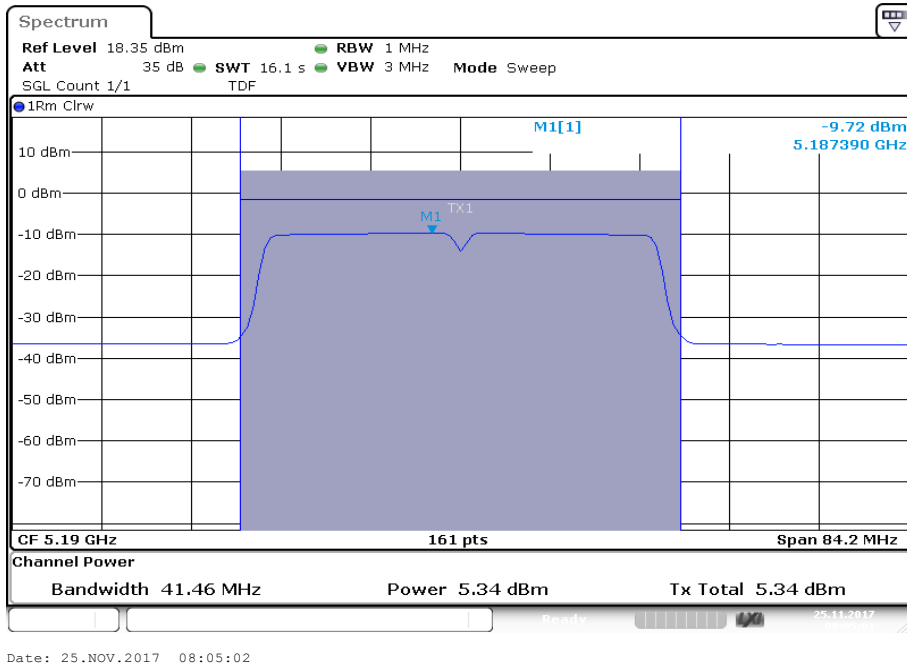

**Plot 2:** U-NII-1; highest channel

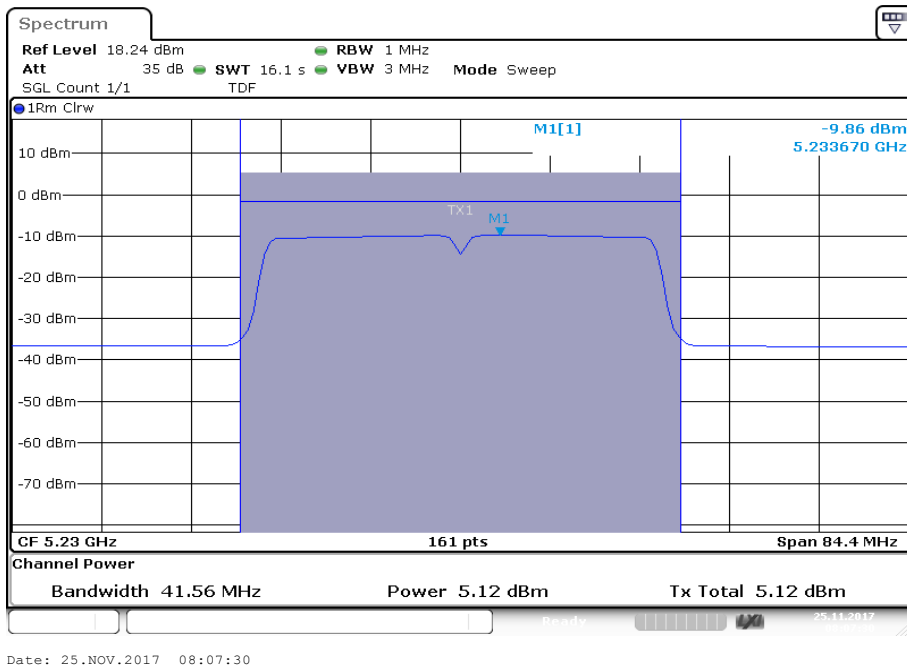

**Plot 3:** U-NII-2A; lowest channel

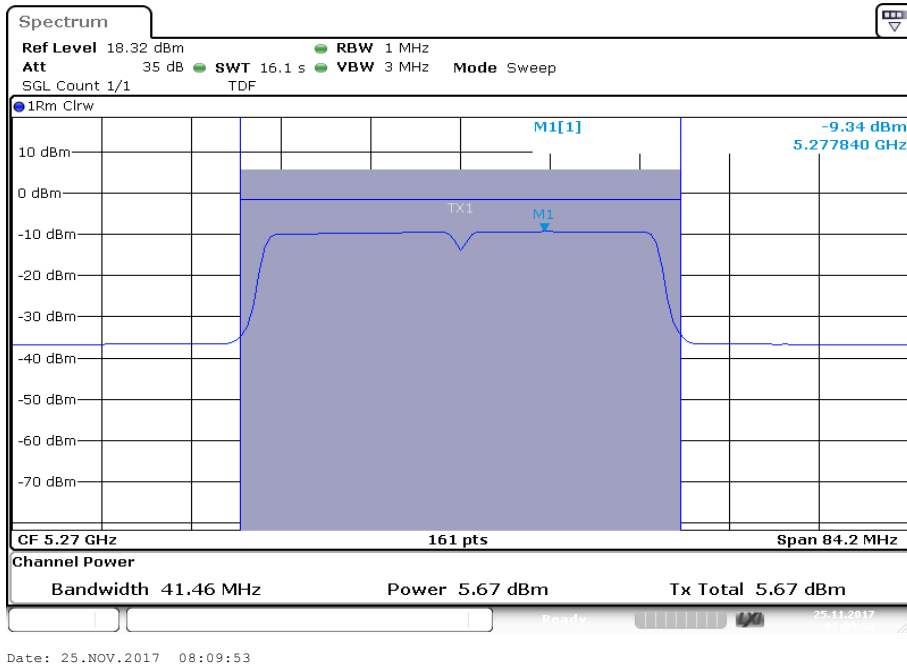

**Plot 4:** U-NII-2A; highest channel

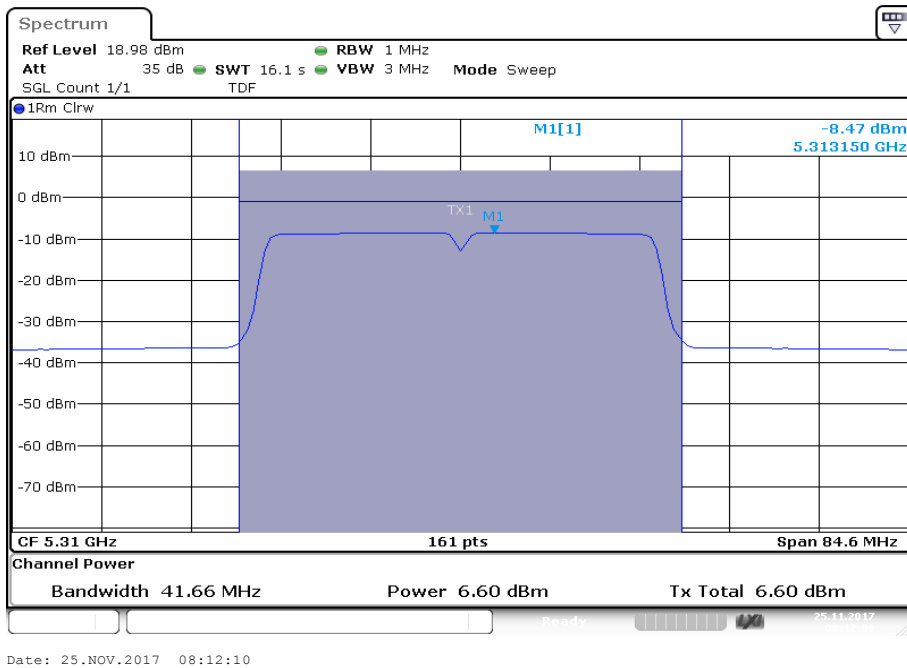

**Plot 5:** U-NII-2C; lowest channel

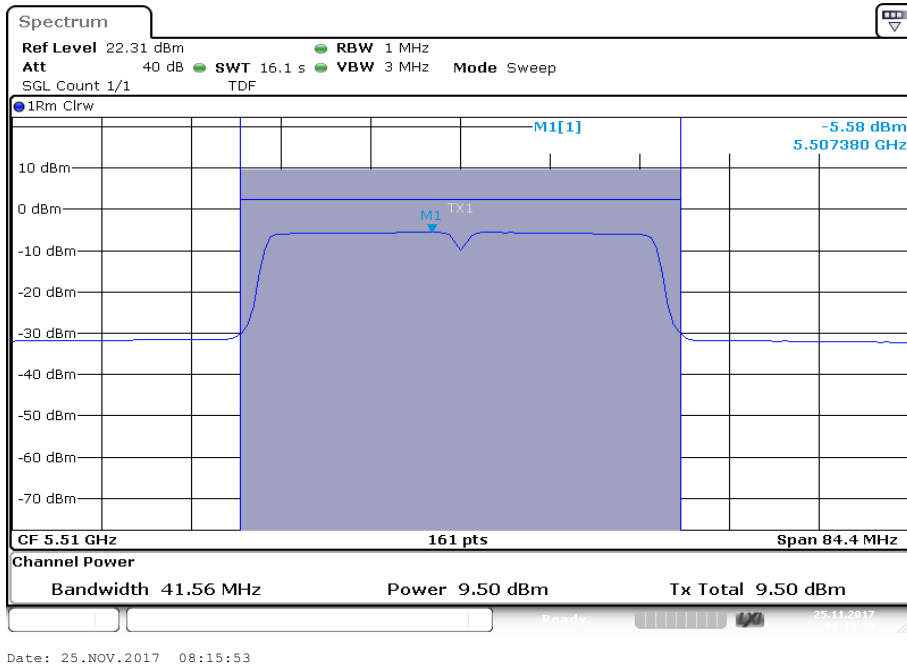

**Plot 6:** U-NII-2C; middle channel

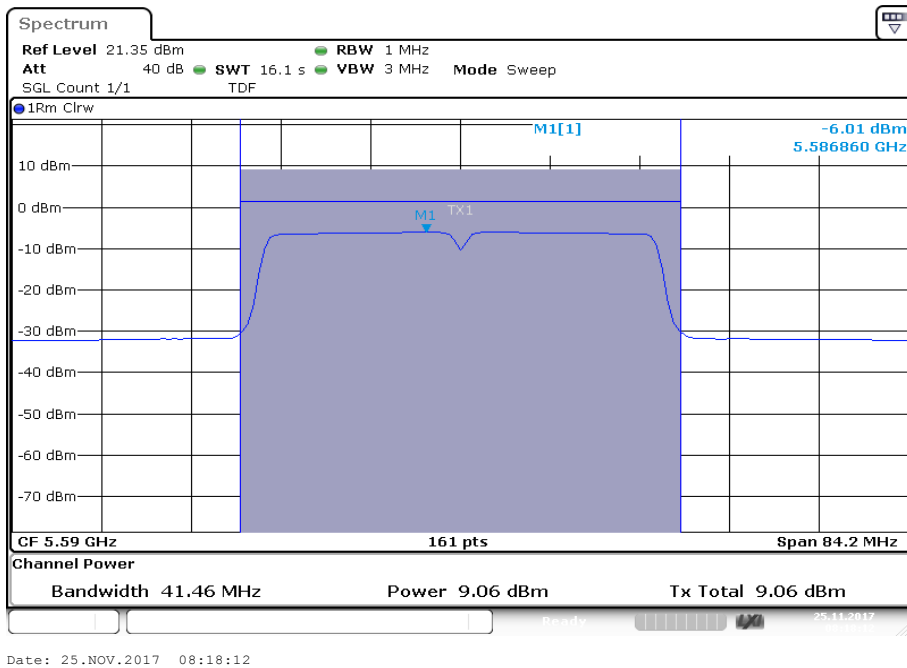

**Plot 7:** U-NII-2C; highest channel

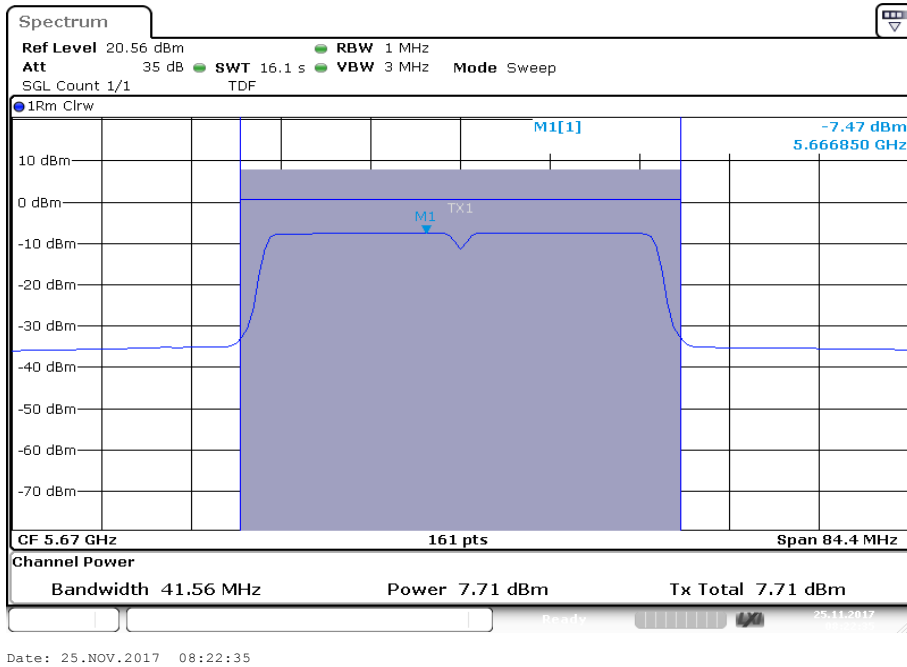

**Plot 8:** U-NII-3; lowest channel

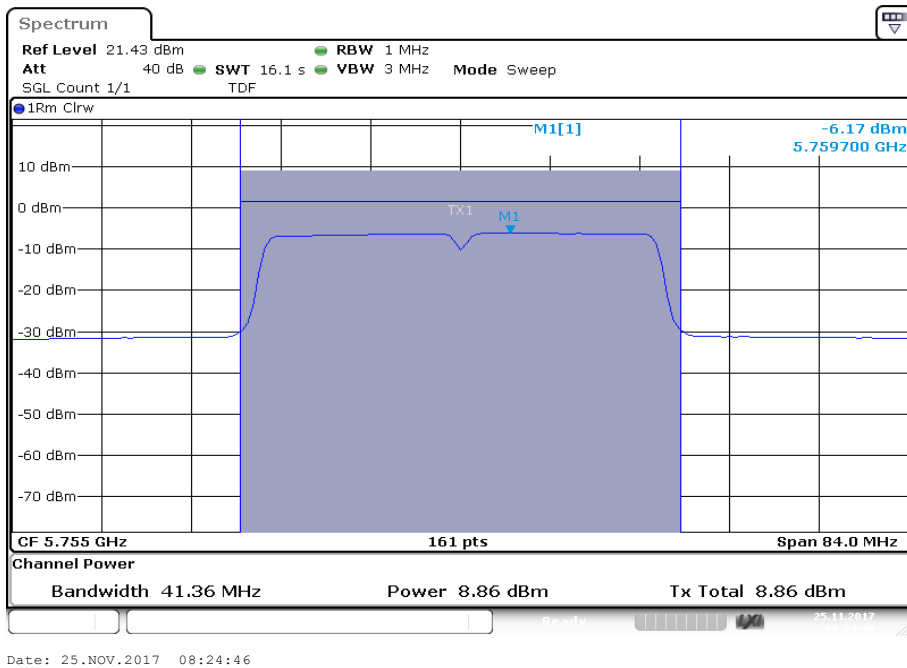



**Plot 9:** U-NII-3; highest channel

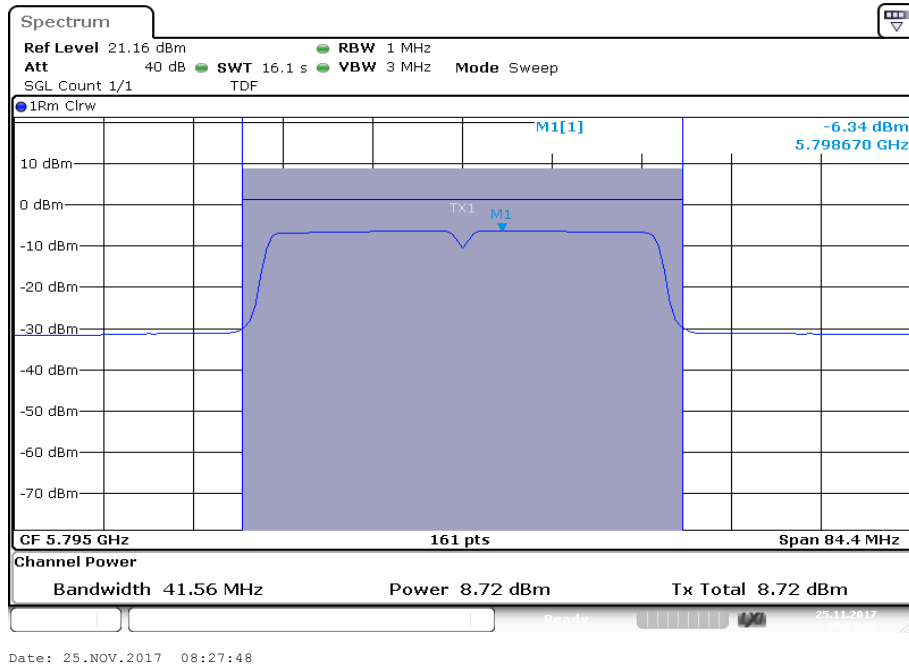

### 11.4.2 Maximum output power according to IC requirements

**Description:**

Measurement of the maximum output power conducted + radiated

**Measurement:**

Measurement parameter	
Detector:	RMS
Sweep time:	$\geq 10 \cdot (\text{swp points}) \cdot (\text{total on/off time})$
Resolution bandwidth:	1 MHz
Video bandwidth:	$\geq 3$ MHz
Span:	> EBW
Trace mode:	Max hold
Analyzer function	Band power / channel power Interval > 99% OBW
Used test setup:	See chapter 6.5 – A
Measurement uncertainty:	See chapter 8

**Limits:**

Radiated output power	Conducted output power for mobile equipment
The lesser one of 200 mW or 10 dBm + 10 log Bandwidth 5.150-5.250 GHz 1 W or 17 dBm + 10 log Bandwidth 5.250-5.350 GHz 1 W or 17 dBm + 10 log Bandwidth 5.470-5.725 GHz (where Bandwidth is the 99% Bandwidth [MHz]) Conducted power + 6dBi antenna gain 5.725-5.825 GHz	The lesser one of 250mW or 11 dBm + 10 log Bandwidth 5.250-5.350 GHz 250mW or 11 dBm + 10 log Bandwidth 5.470-5.725 GHz (where Bandwidth is the 99% Bandwidth [MHz]) 1W 5.725-5.825 GHz

**Results:**

<b>a</b>	<b>Maximum output power [dBm]</b>		
	<b>U-NII-1 (5150 MHz to 5250 MHz)</b>		
	Lowest channel	Middle channel	Highest channel
	Conducted		
	12.0	11.6	11.4
	Radiated (calculated – see chapter antenna gain)		
	16.0	15.4	15.0
	<b>U-NII-2A (5250 MHz to 5350 MHz)</b>		
	Lowest channel	Middle channel	Highest channel
	Conducted		
	11.5	12.4	12.5
	Radiated (calculated – see chapter antenna gain)		
	15.7	16.8	17.2
	<b>U-NII-2C (5470 MHz to 5725 MHz)</b>		
	Lowest channel	Middle channel	Highest channel
	Conducted		
	14.8	12.4	12.1
	Radiated (calculated – see chapter antenna gain)		
	20.1	16.9	15.6
	<b>U-NII-3 (5725 MHz to 5850 MHz)</b>		
Lowest channel	Middle channel	Highest channel	
Conducted			
12.9	12.7	13.8	
Radiated (calculated – see chapter antenna gain)			
16.8	16.1	16.9	

**Results:**

<b>n/ac HT20</b>	<b>Maximum output power [dBm]</b>		
	<b>U-NII-1 (5150 MHz to 5250 MHz)</b>		
	Lowest channel	Middle channel	Highest channel
	Conducted		
	10.5	10.4	10.1
	Radiated (calculated – see chapter antenna gain)		
	14.5	14.2	13.7
	<b>U-NII-2A (5250 MHz to 5350 MHz)</b>		
	Lowest channel	Middle channel	Highest channel
	Conducted		
	10.3	11.3	11.2
	Radiated (calculated – see chapter antenna gain)		
	14.5	15.7	15.9
	<b>U-NII-2C (5470 MHz to 5725 MHz)</b>		
	Lowest channel	Middle channel	Highest channel
	Conducted		
	14.2	11.5	11.2
	Radiated (calculated – see chapter antenna gain)		
	19.5	16.0	14.7
	<b>U-NII-3 (5725 MHz to 5850 MHz)</b>		
	Lowest channel	Middle channel	Highest channel
Conducted			
11.5	11.4	12.7	
Radiated (calculated – see chapter antenna gain)			
15.4	14.8	15.8	

**Results:**

<b>n/ac HT40</b>	<b>Maximum output power [dBm]</b>		
	<b>U-NII-1 (5150 MHz to 5250 MHz)</b>		
	Lowest channel		Highest channel
	Conducted		
	5.3		5.0
	Radiated (calculated – see chapter antenna gain)		
	9.3		8.6
	<b>U-NII-2A (5250 MHz to 5350 MHz)</b>		
	Lowest channel		Highest channel
	Conducted		
	5.6		6.5
	Radiated (calculated – see chapter antenna gain)		
	9.8		11.2
	<b>U-NII-2C (5470 MHz to 5725 MHz)</b>		
	Lowest channel	Middle channel	Highest channel
	Conducted		
	9.4	9.0	7.6
	Radiated (calculated – see chapter antenna gain)		
	14.7	13.5	11.1
	<b>U-NII-3 (5725 MHz to 5850 MHz)</b>		
	Lowest channel		Highest channel
	Conducted		
	8.7		8.6
	Radiated (calculated – see chapter antenna gain)		
12.6		11.7	

**Plots:** a – mode

**Plot 1:** U-NII-1; lowest channel

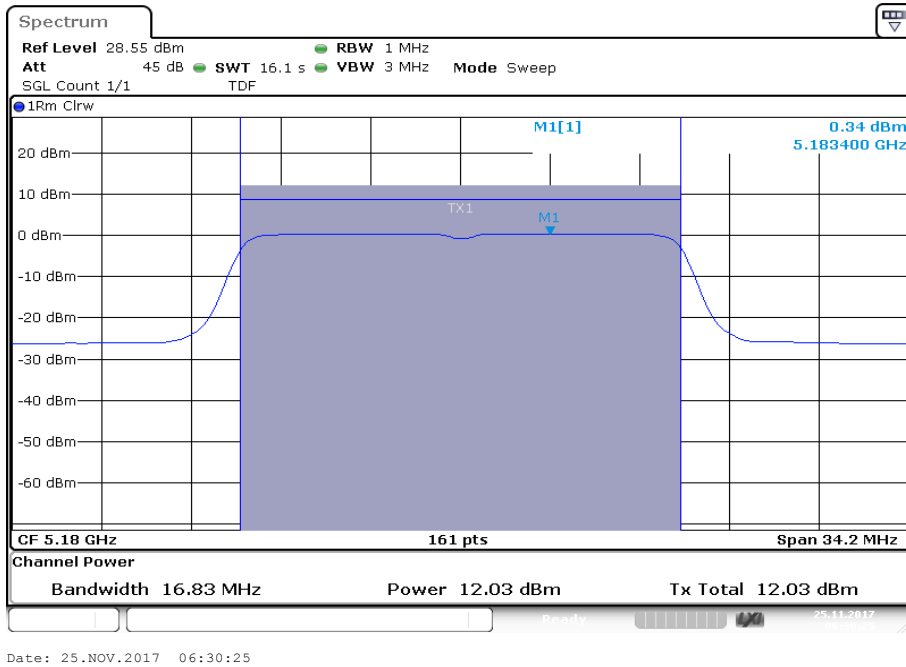

**Plot 2:** U-NII-1; middle channel

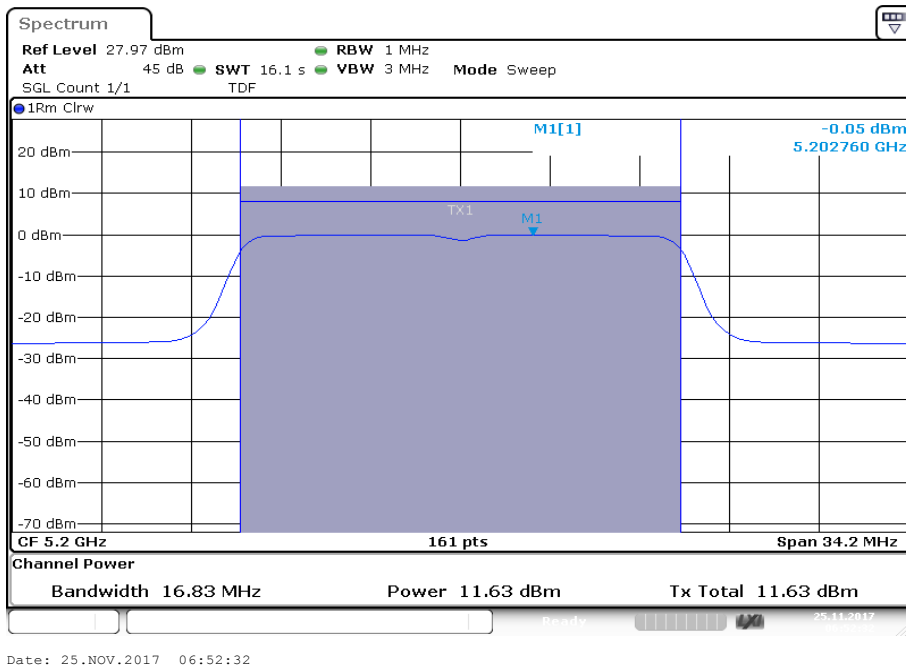

**Plot 3:** U-NII-1; highest channel

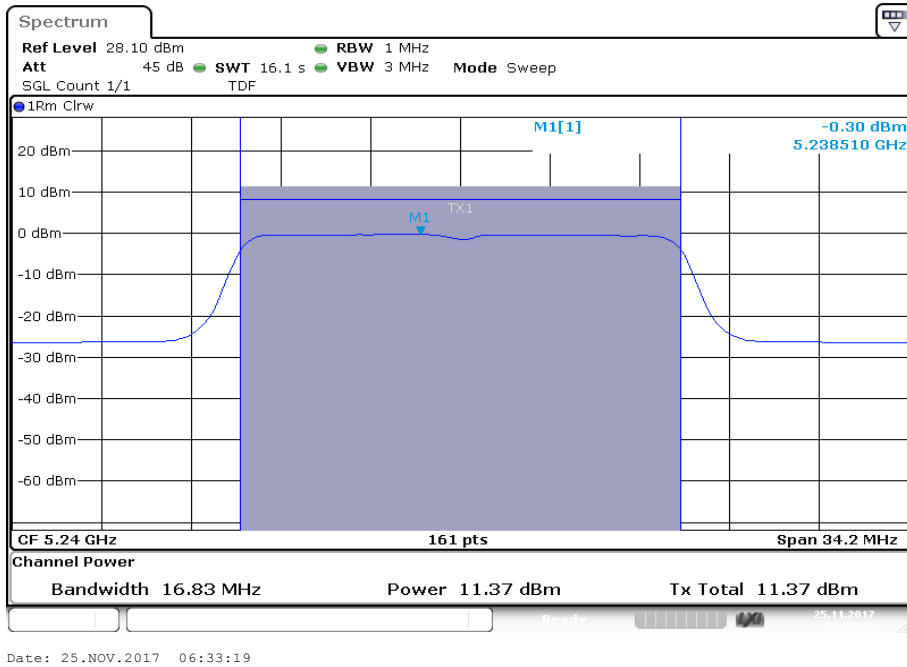

**Plot 4:** U-NII-2A; lowest channel

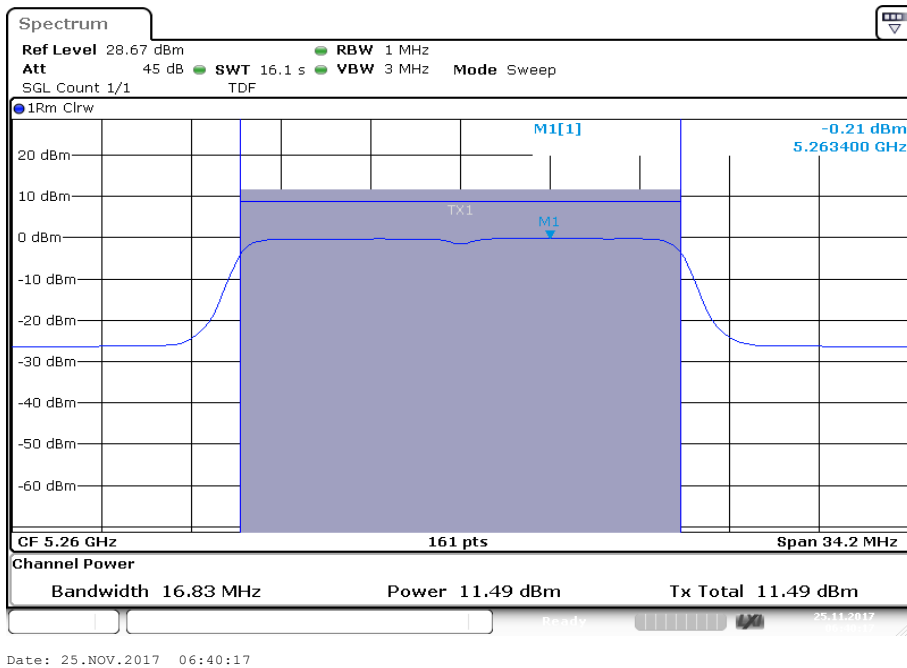

**Plot 5:** U-NII-2A; middle channel

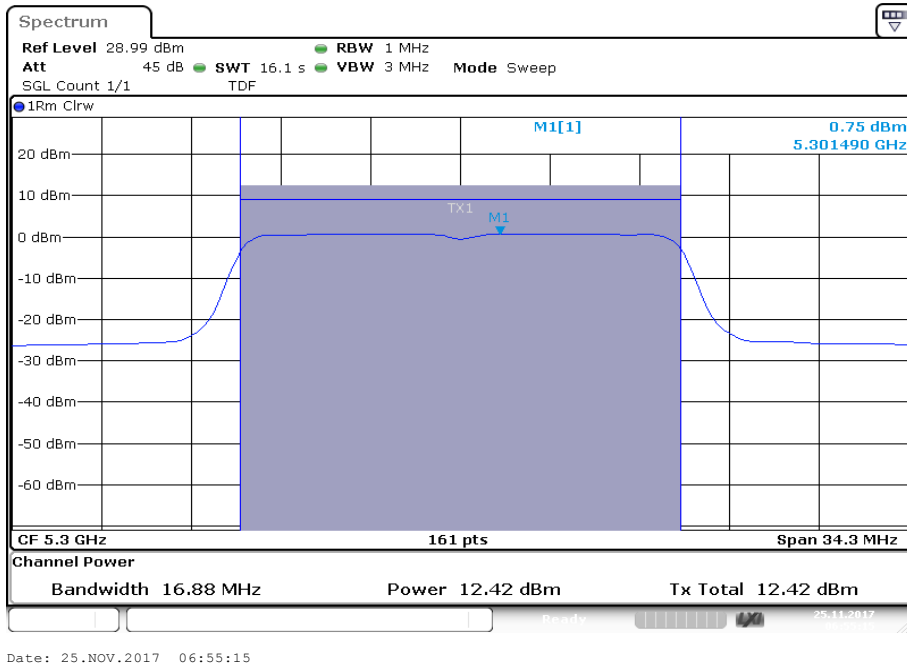

**Plot 6:** U-NII-2A; highest channel

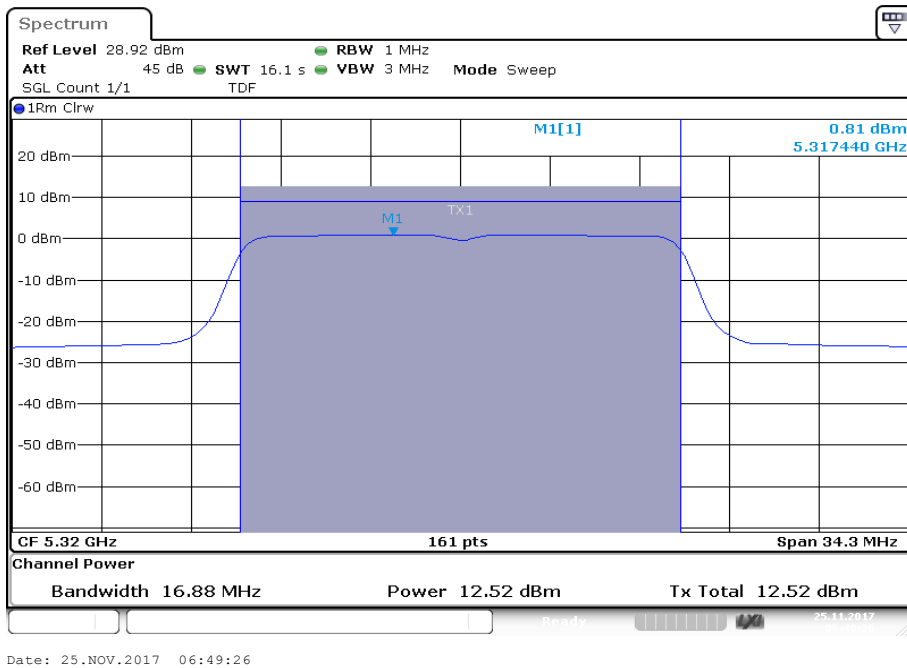



**Plot 7:** U-NII-2C; lowest channel

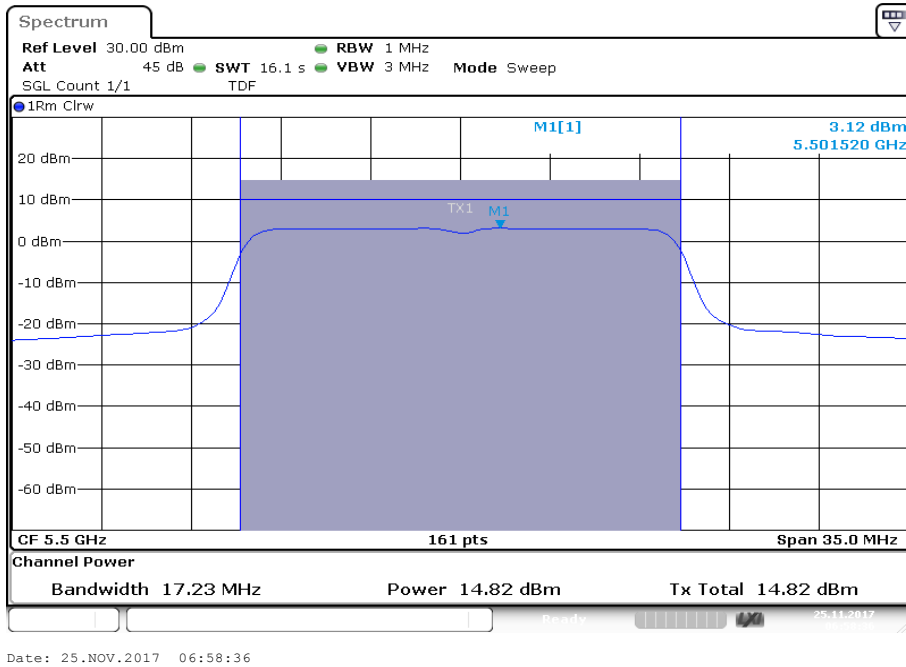

**Plot 8:** U-NII-2C; middle channel

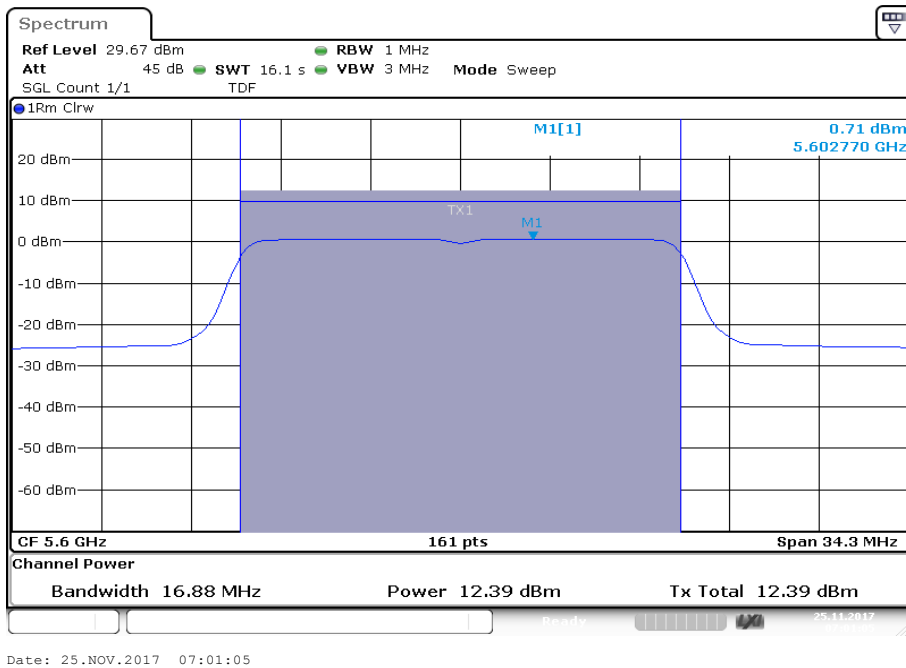

**Plot 9:** U-NII-2C; highest channel

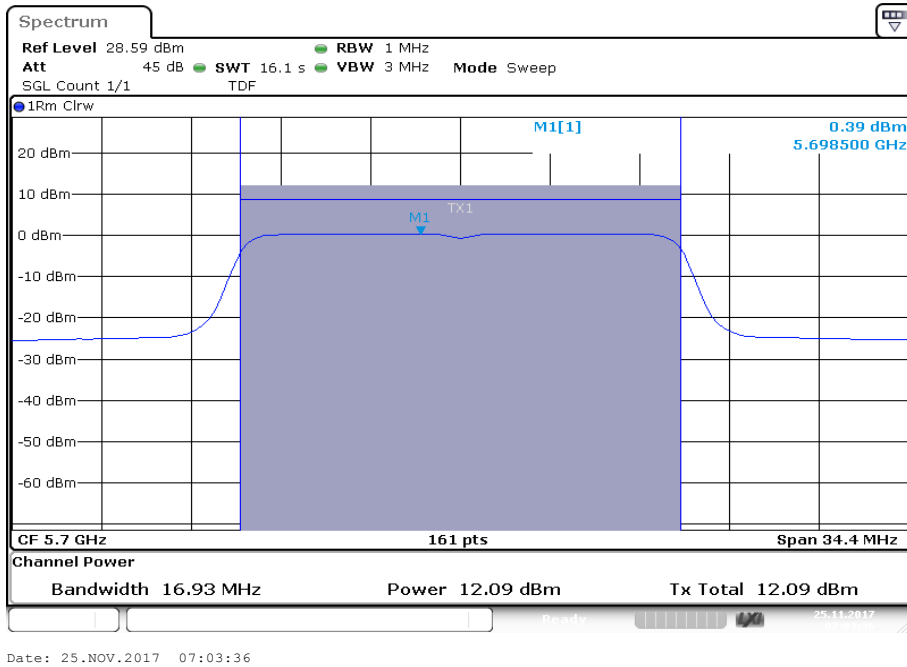

**Plot 10:** U-NII-3; lowest channel

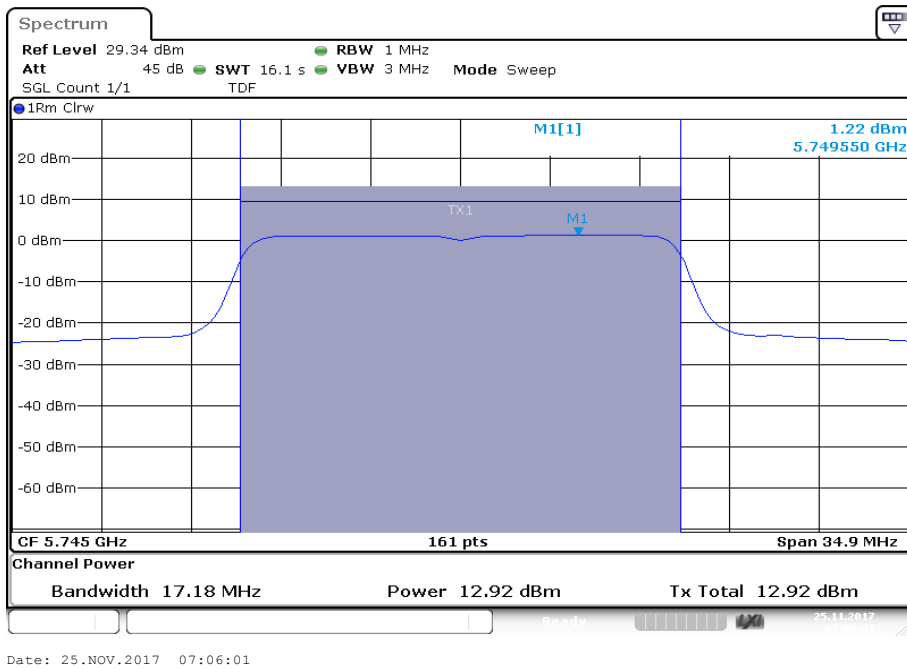

**Plot 11:** U-NII-3; middle channel

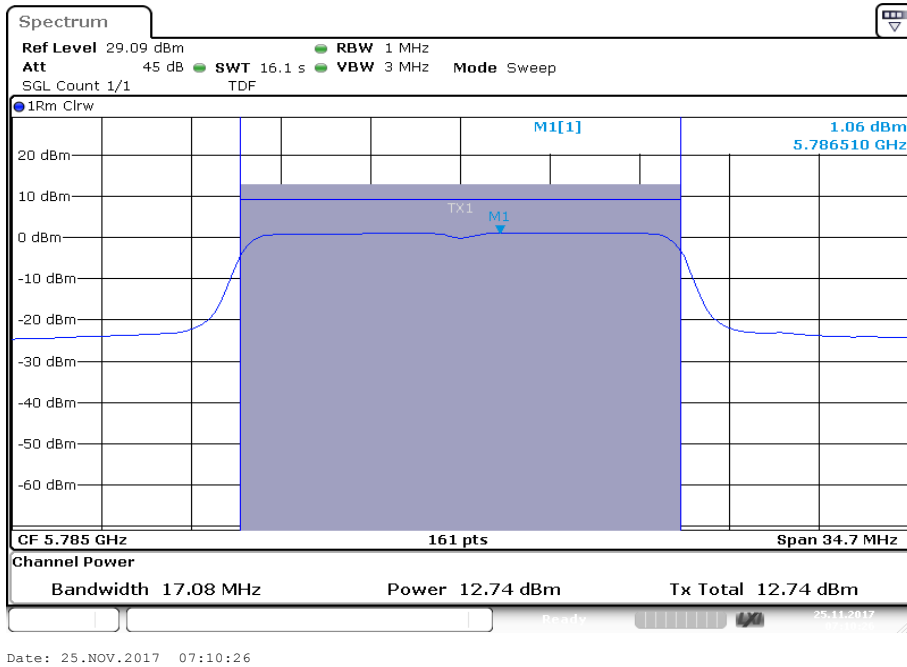

**Plot 12:** U-NII-3; highest channel

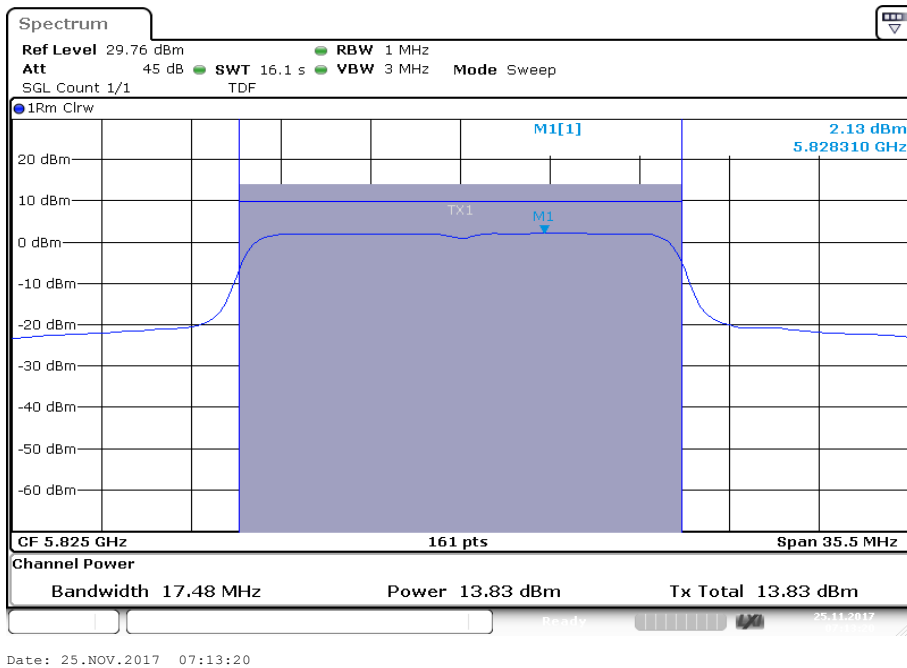

**Plots:** n/ac HT20 – mode

**Plot 1:** U-NII-1; lowest channel

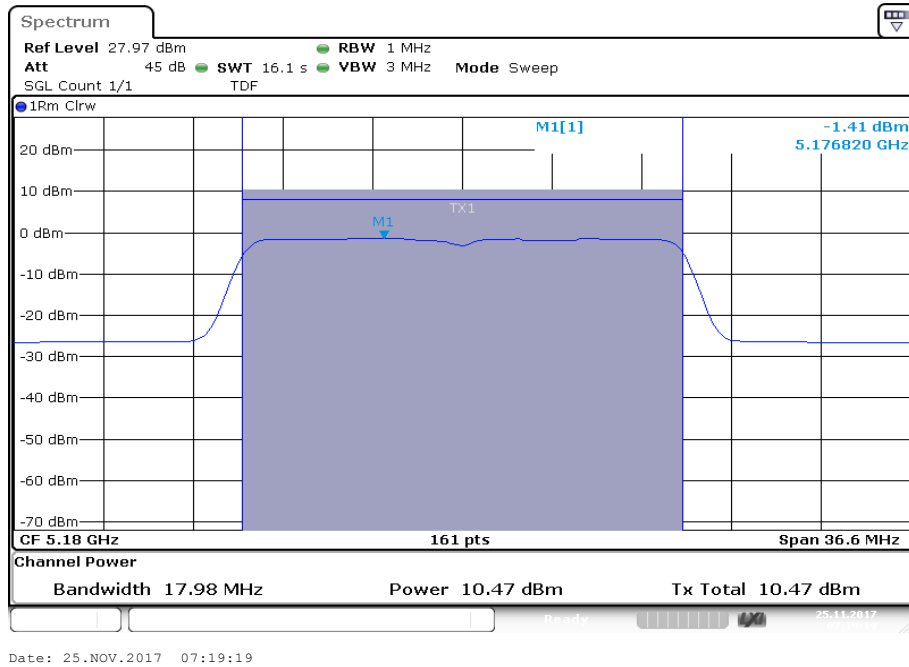

**Plot 2:** U-NII-1; middle channel

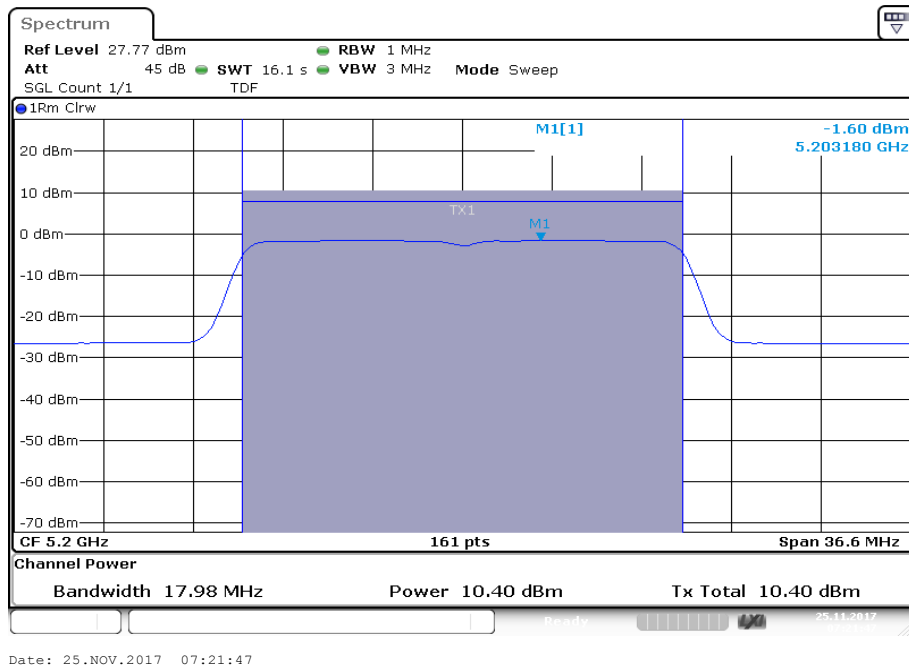

**Plot 3:** U-NII-1; highest channel

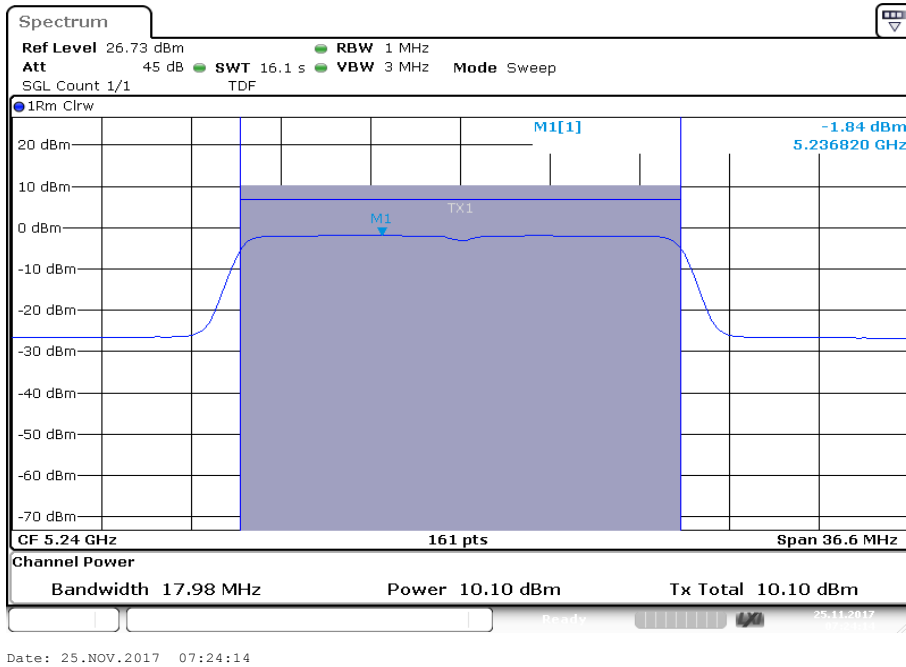

**Plot 4:** U-NII-2A; lowest channel

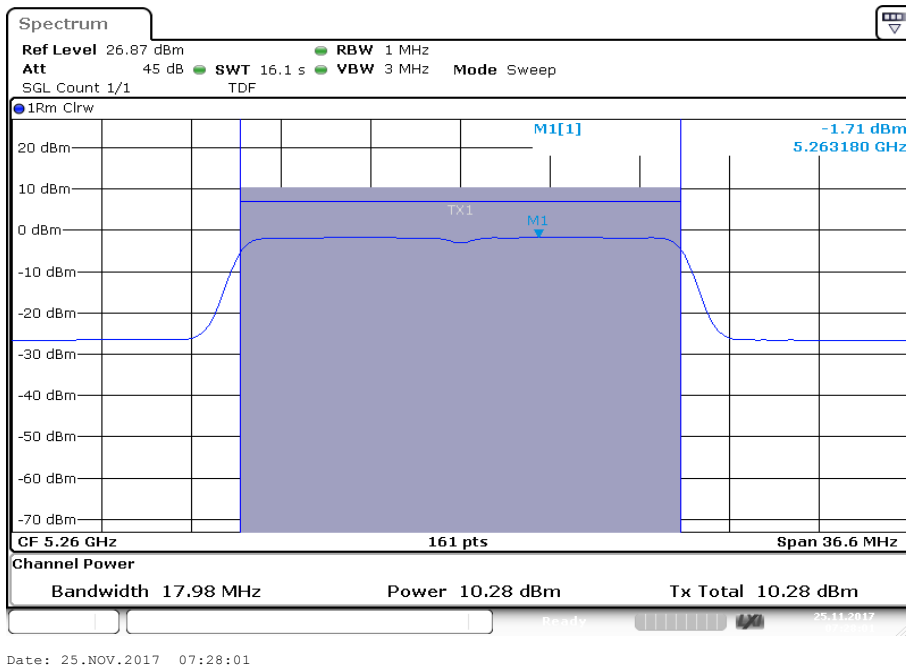

**Plot 5:** U-NII-2A; middle channel

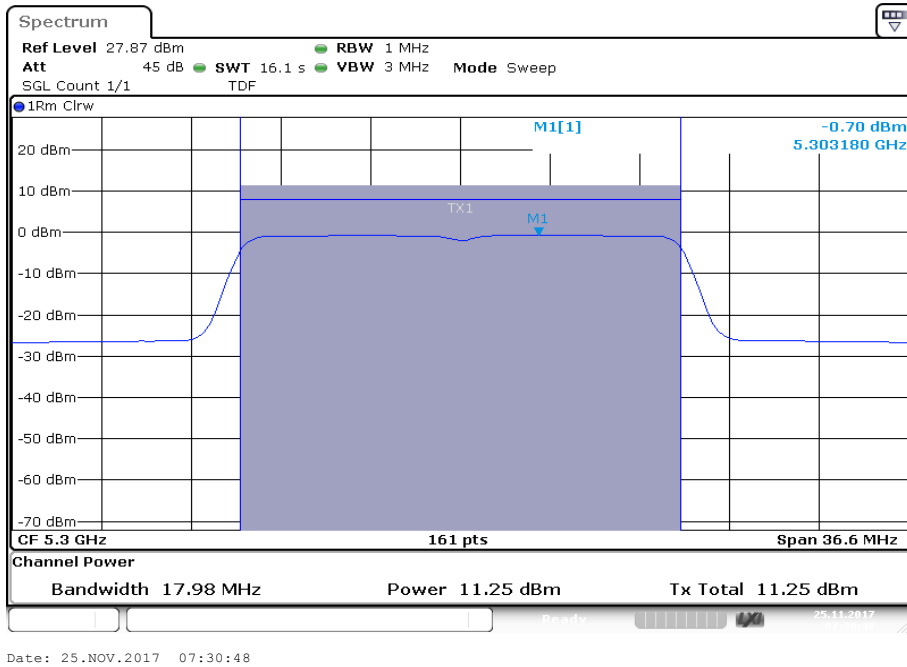

**Plot 6:** U-NII-2A; highest channel

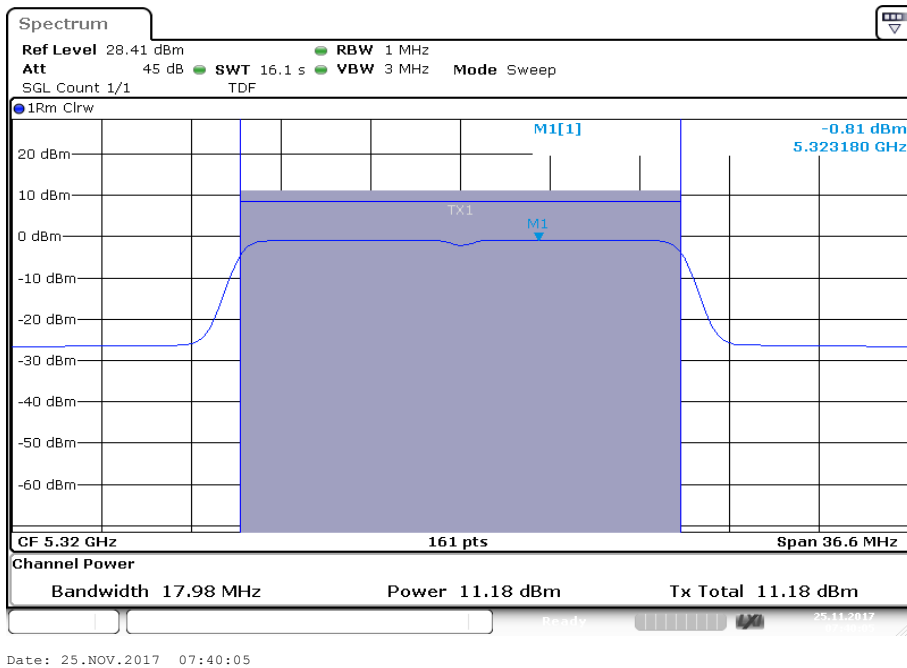

**Plot 7:** U-NII-2C; lowest channel

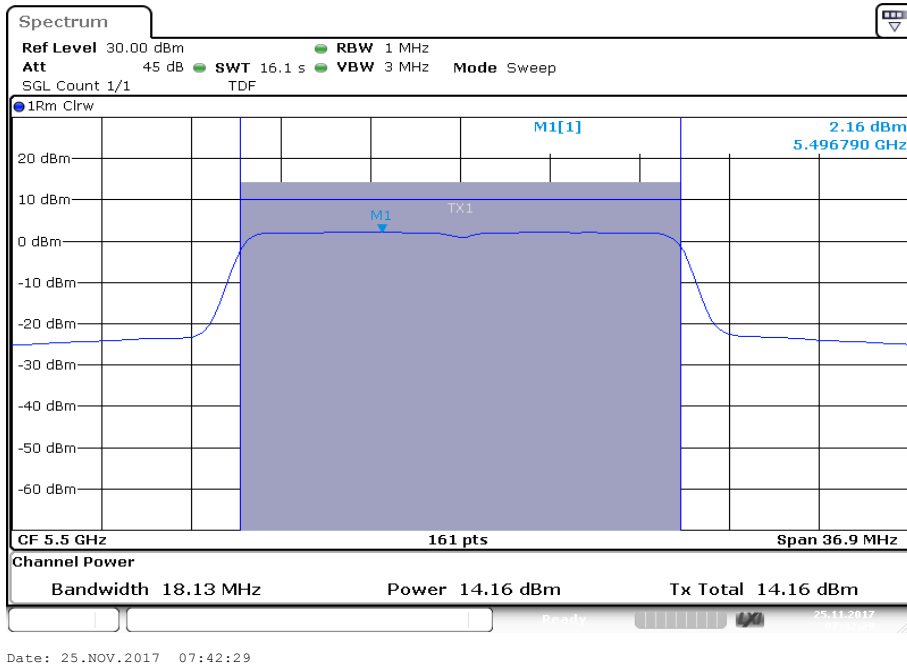

**Plot 8:** U-NII-2C; middle channel

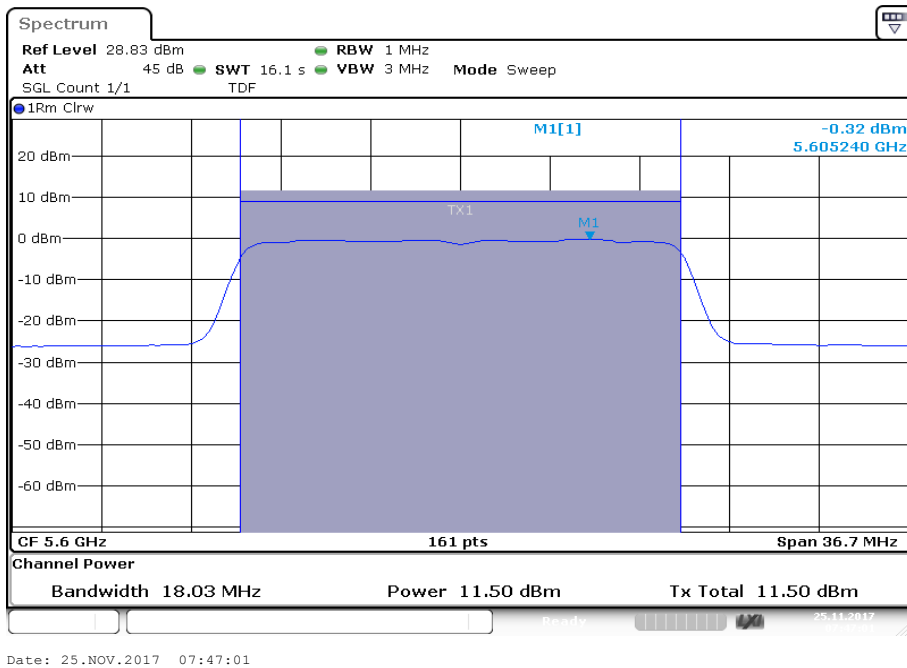

**Plot 9:** U-NII-2C; highest channel

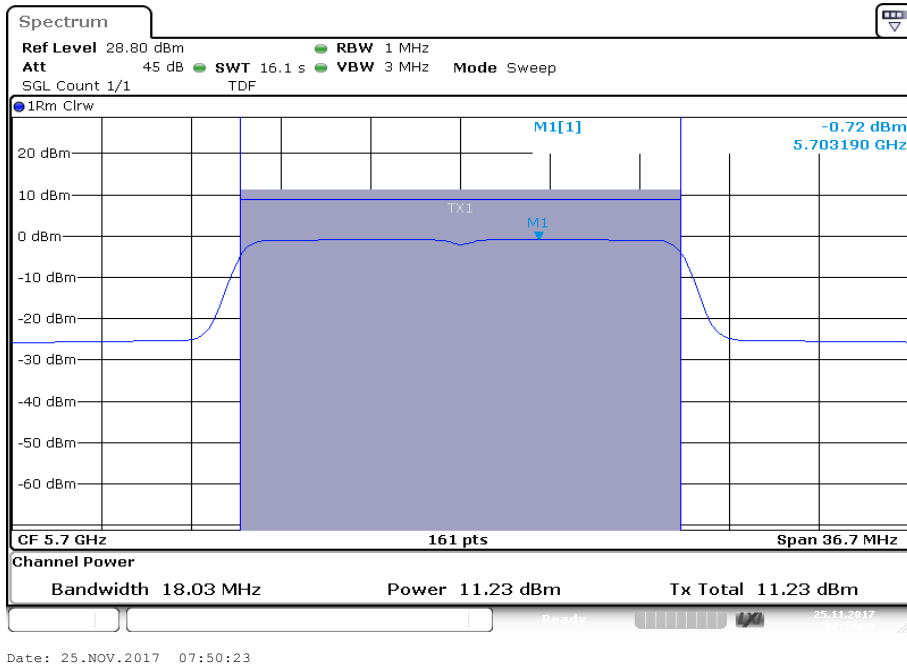

**Plot 10:** U-NII-3; lowest channel

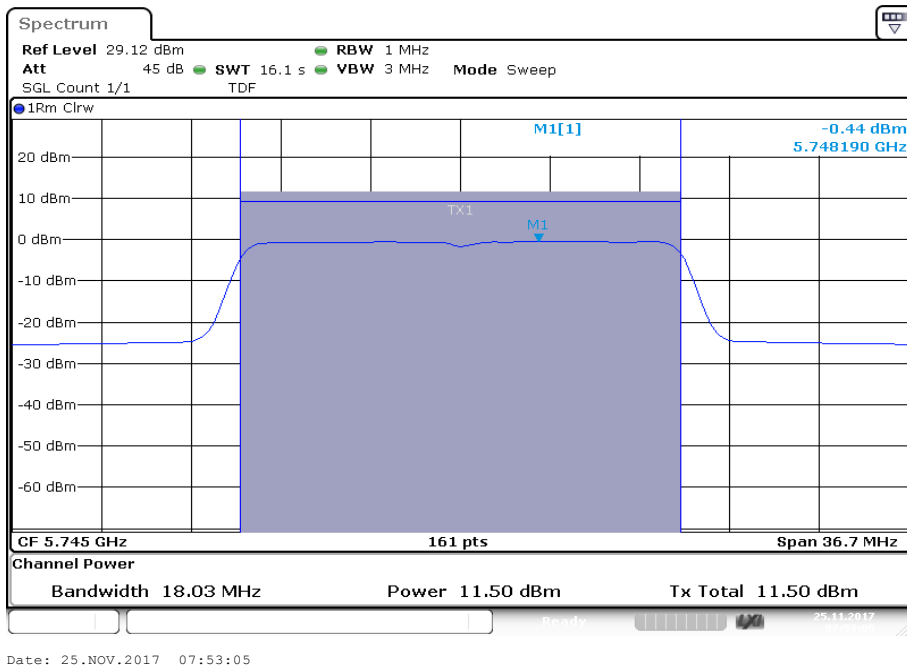



**Plot 11:** U-NII-3; middle channel

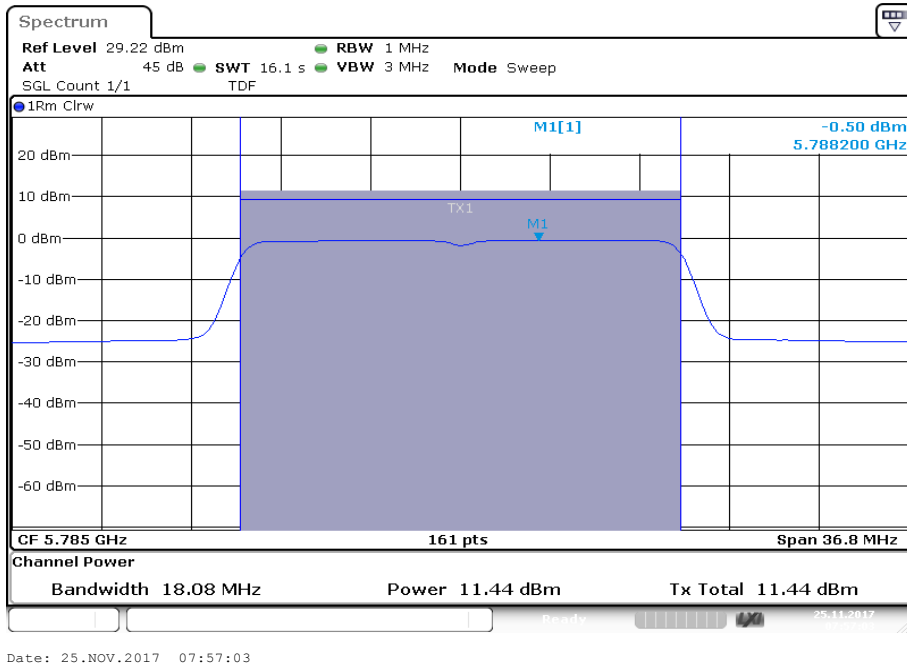

**Plot 12:** U-NII-3; highest channel

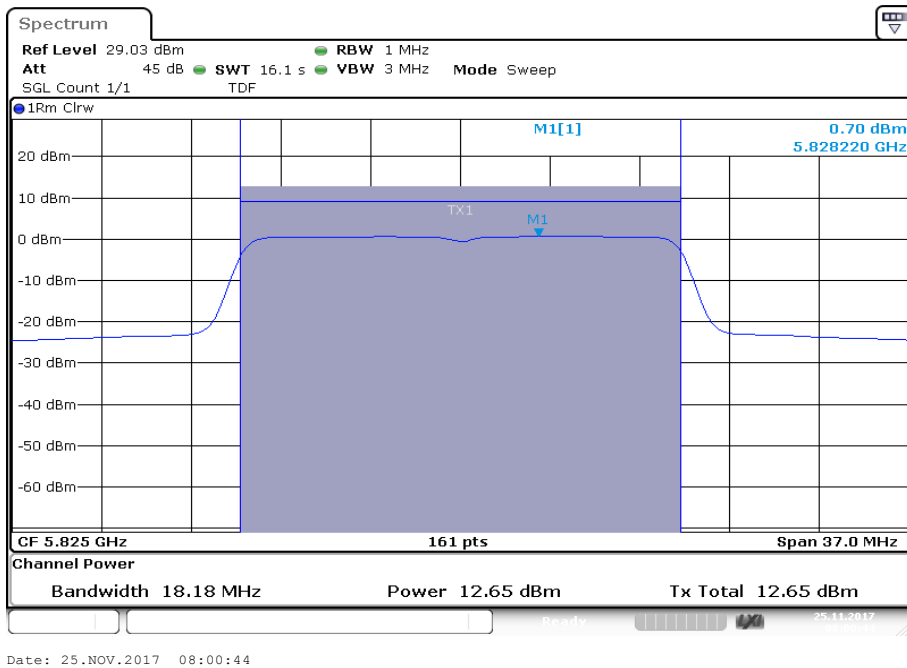

**Plots:** n/ac HT40 – mode

**Plot 1:** U-NII-1; lowest channel

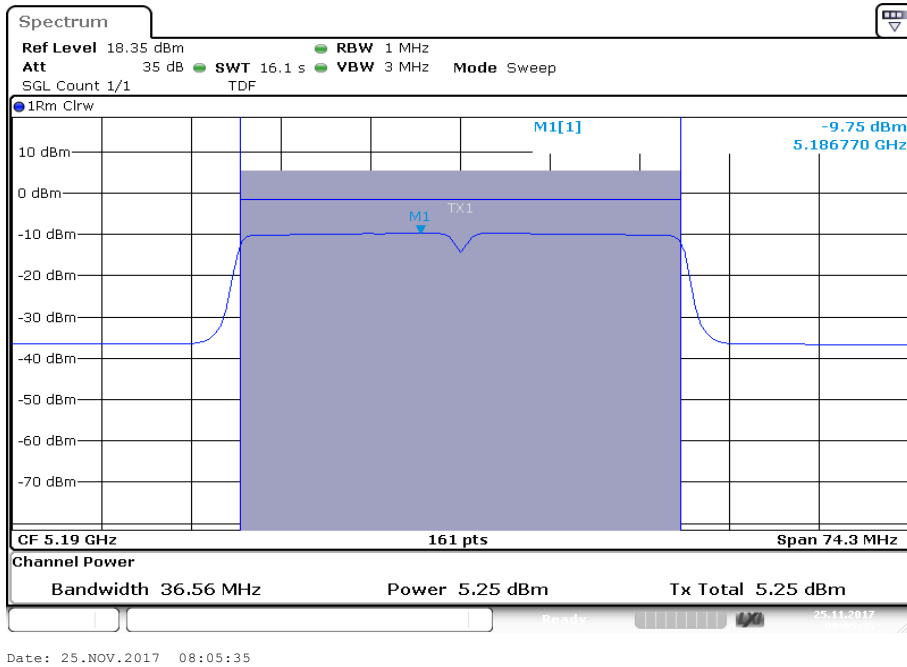

**Plot 2:** U-NII-1; highest channel

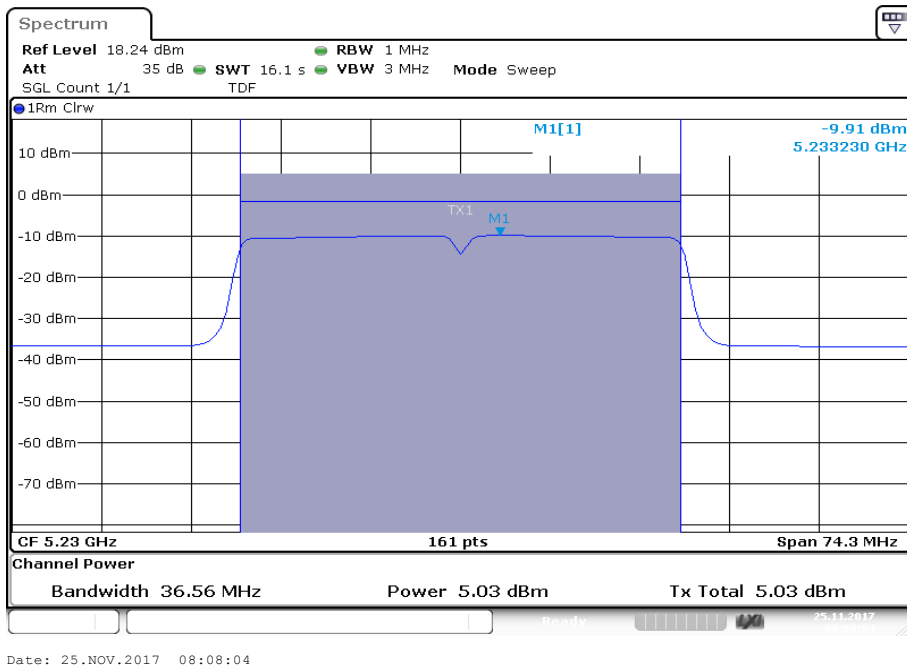

**Plot 3:** U-NII-2A; lowest channel

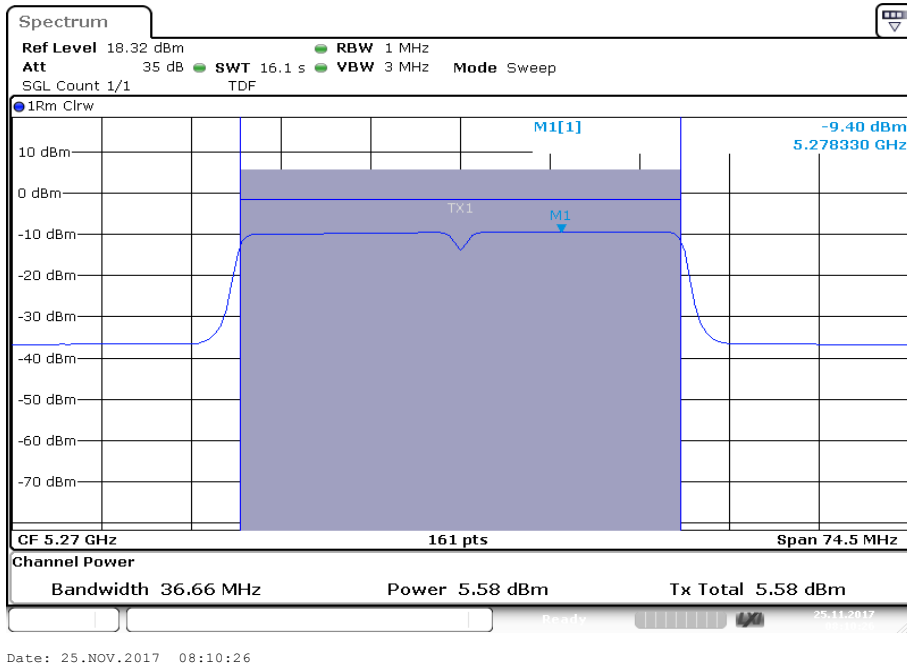

**Plot 4:** U-NII-2A; highest channel

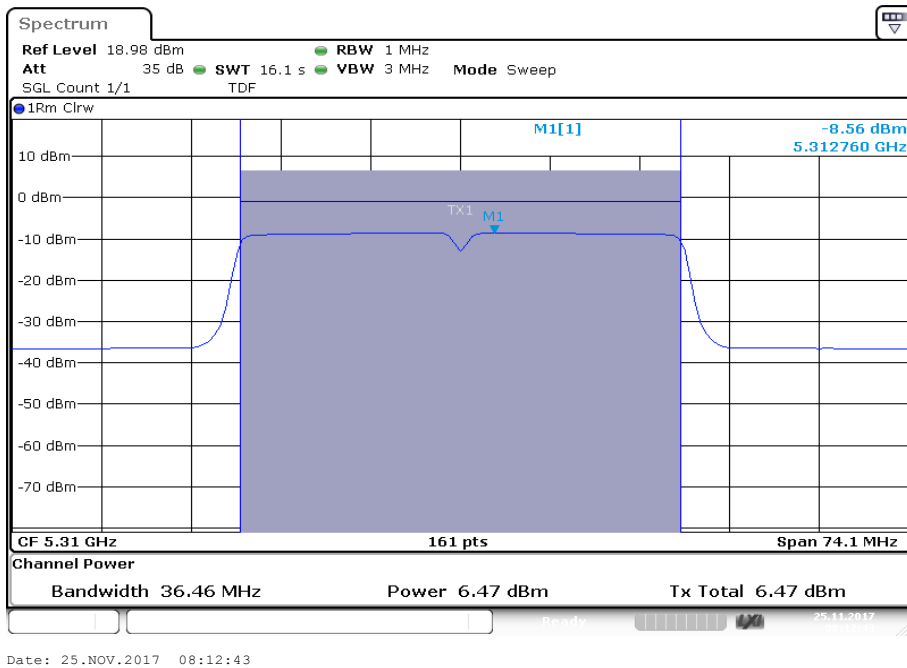

**Plot 5:** U-NII-2C; lowest channel

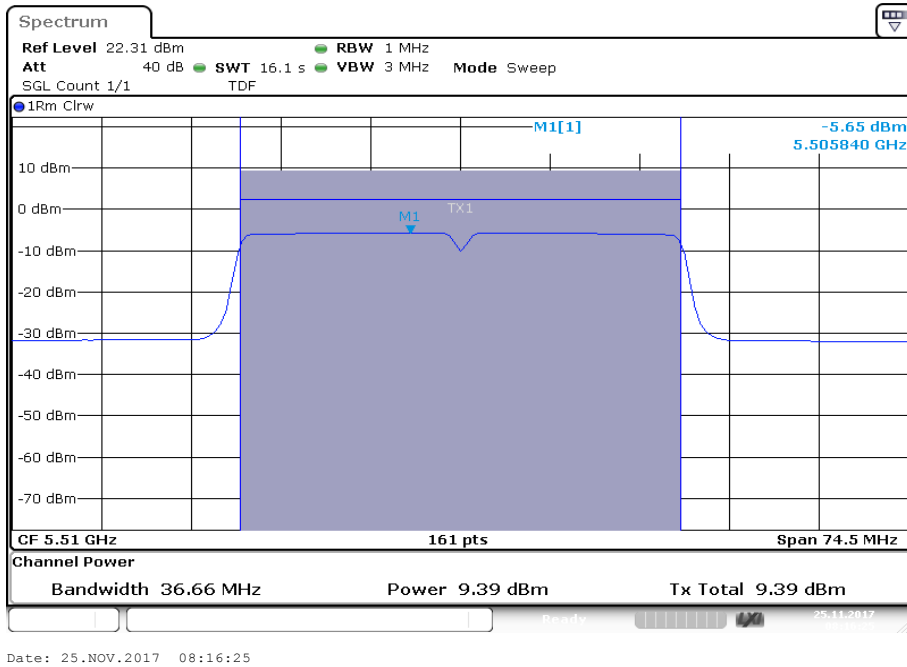

**Plot 6:** U-NII-2C; middle channel

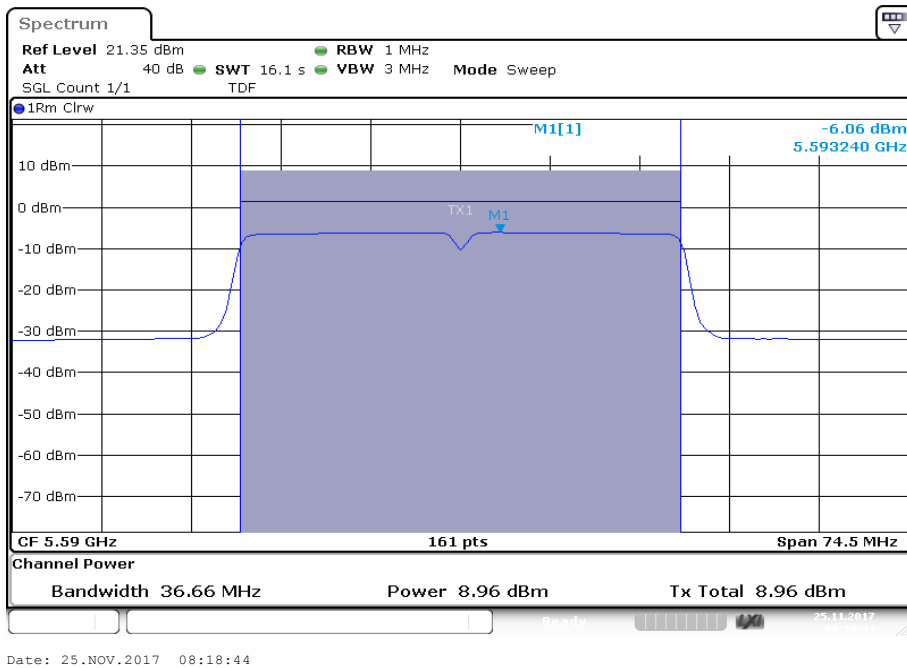

**Plot 7:** U-NII-2C; highest channel

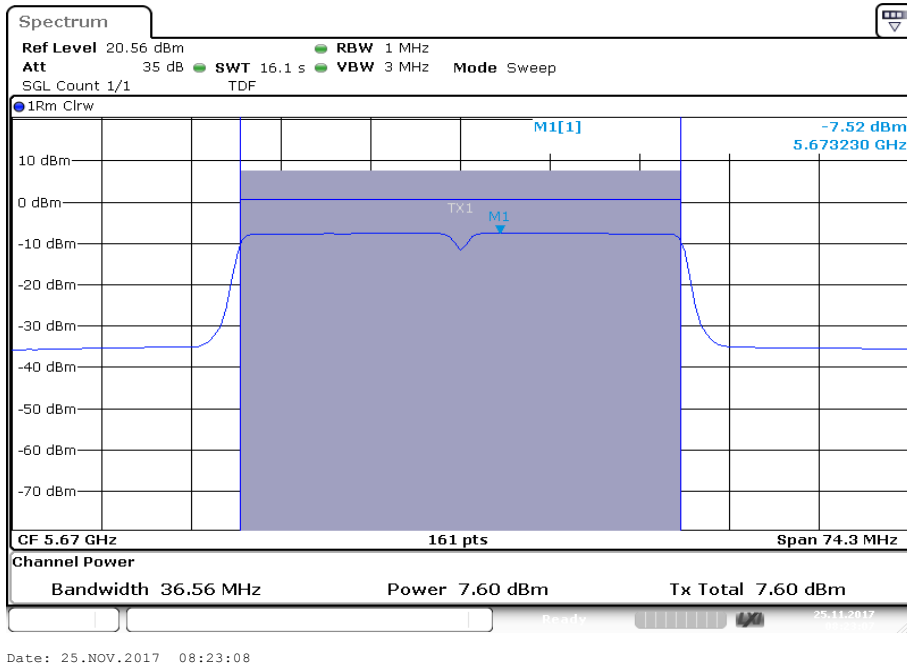

**Plot 8:** U-NII-3; lowest channel

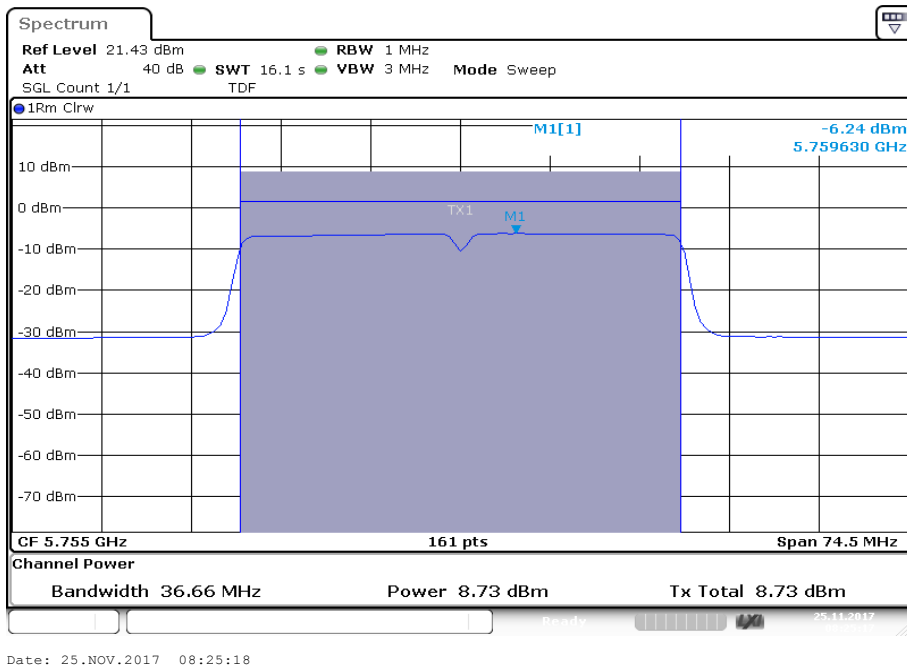

**Plot 9:** U-NII-3; highest channel

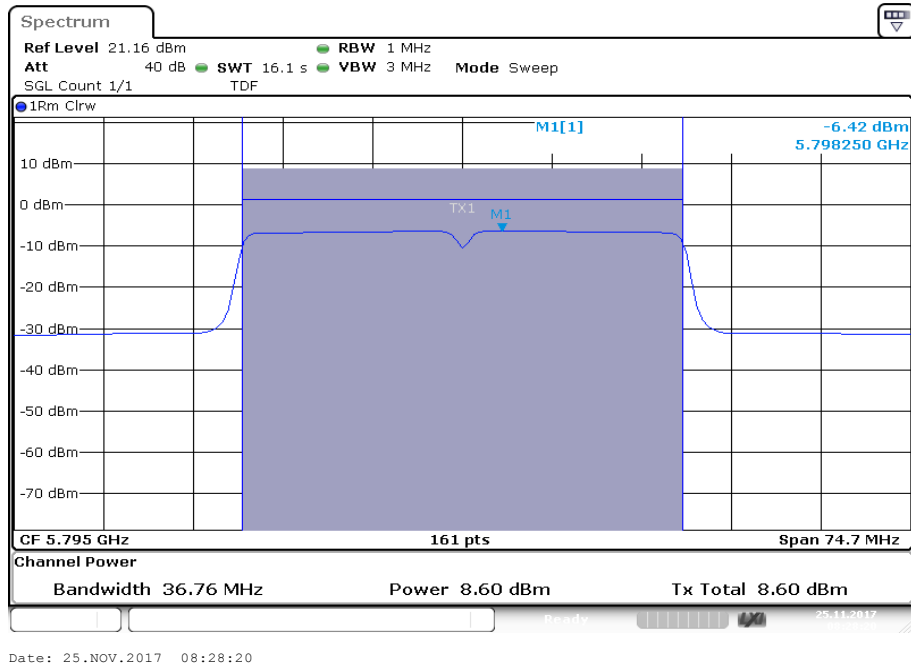

## 11.5 Power spectral density

### 11.5.1 Power spectral density according to FCC requirements

#### Description:

Measurement of the power spectral density of a digital modulated system. The measurement is repeated at the lowest, middle and highest channel.

#### Measurement:

Measurement parameter	
According to: KDB789033 D02, F.	
Detector:	RMS
Sweep time:	$\geq 10 * (\text{swp points}) * (\text{total on/off time})$
Resolution bandwidth:	1 MHz for U-NII-1/2A & 2C 500 kHz for U-NII-3
Video bandwidth:	$\geq 3xRBW$
Span:	> EBW
Trace mode:	Max hold
Used test setup:	See chapter 6.5 – A
Measurement uncertainty:	See chapter 8

#### Limits:

Power Spectral Density
power spectral density conducted $\leq 11$ dBm in any 1 MHz band (band 5150 – 5250 MHz)
power spectral density conducted $\leq 11$ dBm in any 1 MHz band (band 5250 – 5350 MHz)
power spectral density conducted $\leq 11$ dBm in any 1 MHz band (band 5470 – 5725 MHz)
power spectral density conducted $\leq 30$ dBm in any 500 kHz band (band 5725 – 5850 MHz)

**Results:**

a	Power spectral density (dBm/1MHz or dBm/500kHz)		
	<b>U-NII-1 (5150 MHz to 5250 MHz)</b>		
	Lowest channel	Middle channel	Highest channel
	0.02	0.00	-0.17
	<b>U-NII-2A (5250 MHz to 5350 MHz)</b>		
	Lowest channel	Middle channel	Highest channel
	-0.12	0.82	0.87
	<b>U-NII-2C (5470 MHz to 5725 MHz)</b>		
	Lowest channel	Middle channel	Highest channel
	3.22	0.80	0.44
	<b>U-NII-3 (5725 MHz to 5850 MHz)</b>		
	Lowest channel	Middle channel	Highest channel
	-1.38	-1.85	-0.82

**Results:**

n/ac HT20	Power spectral density (dBm/1MHz or dBm/500kHz)		
	<b>U-NII-1 (5150 MHz to 5250 MHz)</b>		
	Lowest channel	Middle channel	Highest channel
	-1.70	-1.50	-1.76
	<b>U-NII-2A (5250 MHz to 5350 MHz)</b>		
	Lowest channel	Middle channel	Highest channel
	-1.65	-0.62	-0.74
	<b>U-NII-2C (5470 MHz to 5725 MHz)</b>		
	Lowest channel	Middle channel	Highest channel
	2.30	-0.26	-0.65
	<b>U-NII-3 (5725 MHz to 5850 MHz)</b>		
	Lowest channel	Middle channel	Highest channel
	-2.95	-3.11	-2.14



**Results:**

<b>n/ac HT40</b>	<b>Power spectral density (dBm/1MHz or dBm/500kHz)</b>		
	<b>U-NII-1 (5150 MHz to 5250 MHz)</b>		
	Lowest channel		Highest channel
	-9.72		-9.86
	<b>U-NII-2A (5250 MHz to 5350 MHz)</b>		
	Lowest channel		Highest channel
	-9.34		-8.47
	<b>U-NII-2C (5470 MHz to 5725 MHz)</b>		
	Lowest channel	Middle channel	Highest channel
	-5.58	-6.01	-7.47
	<b>U-NII-3 (5725 MHz to 5850 MHz)</b>		
	Lowest channel		Highest channel
	-9.34		-9.55

**Plots:** a – mode

**Plot 1:** U-NII-3; lowest channel

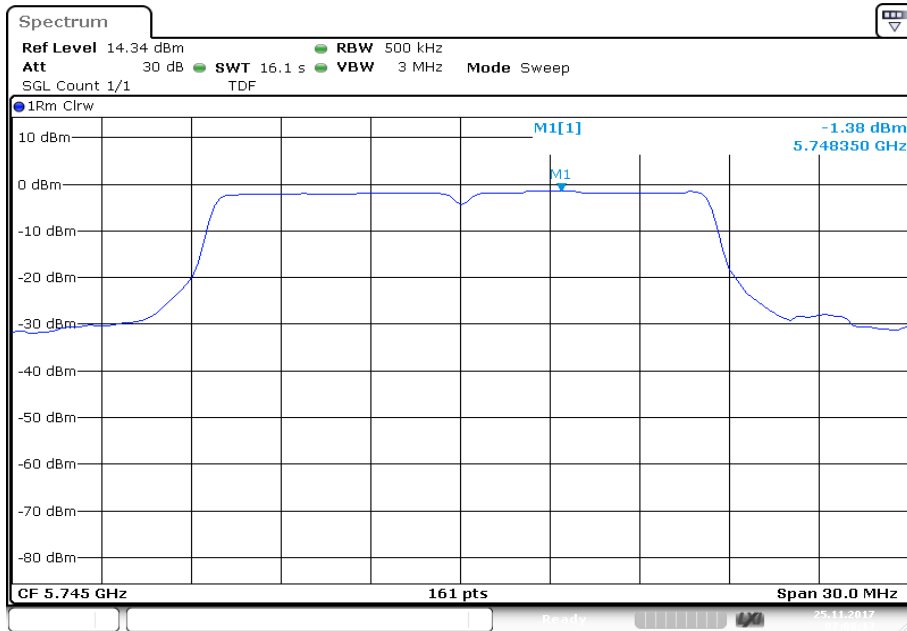

Date: 25.NOV.2017 07:08:14

**Plot 2:** U-NII-3; middle channel

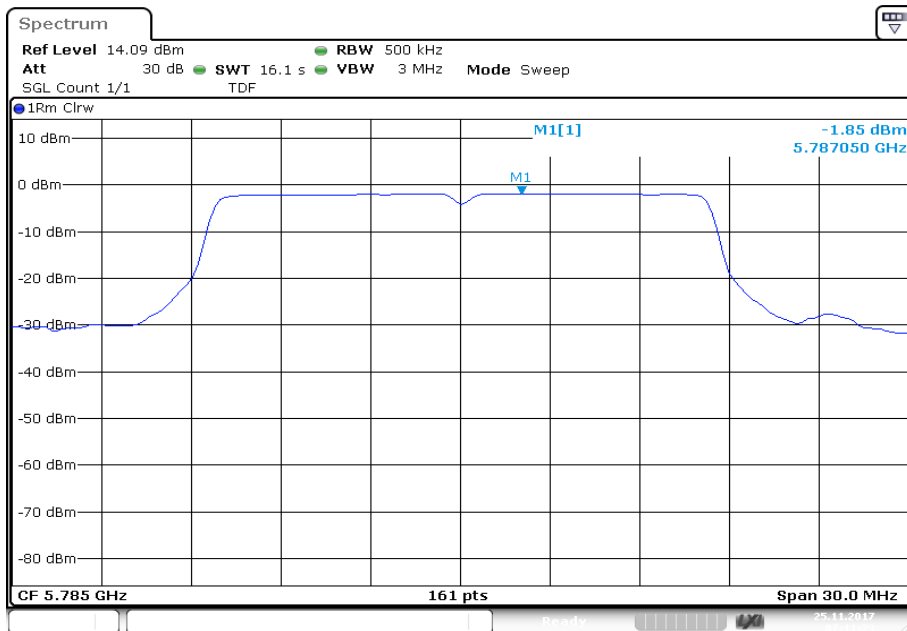

Date: 25.NOV.2017 07:11:23

**Plot 3:** U-NII-3; highest channel

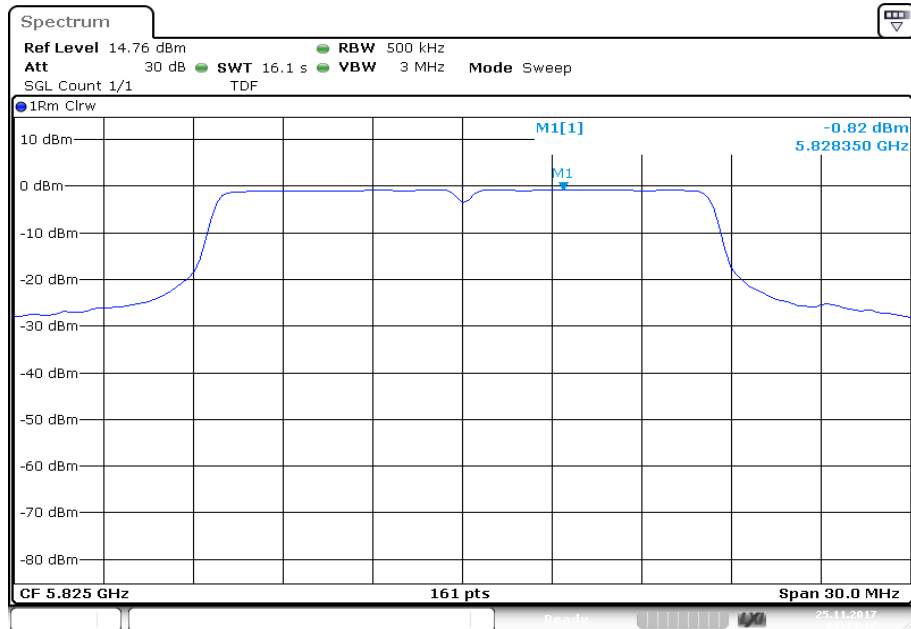

Date: 25.NOV.2017 07:14:17

**Plots:** n/ac HT20 – mode

**Plot 1:** U-NII-3; lowest channel

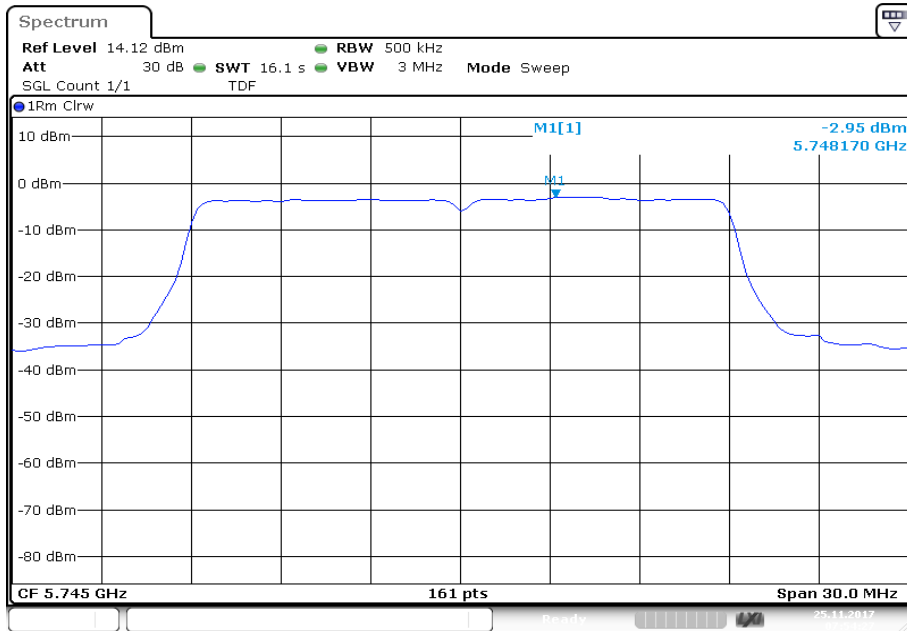

**Plot 2:** U-NII-3; middle channel

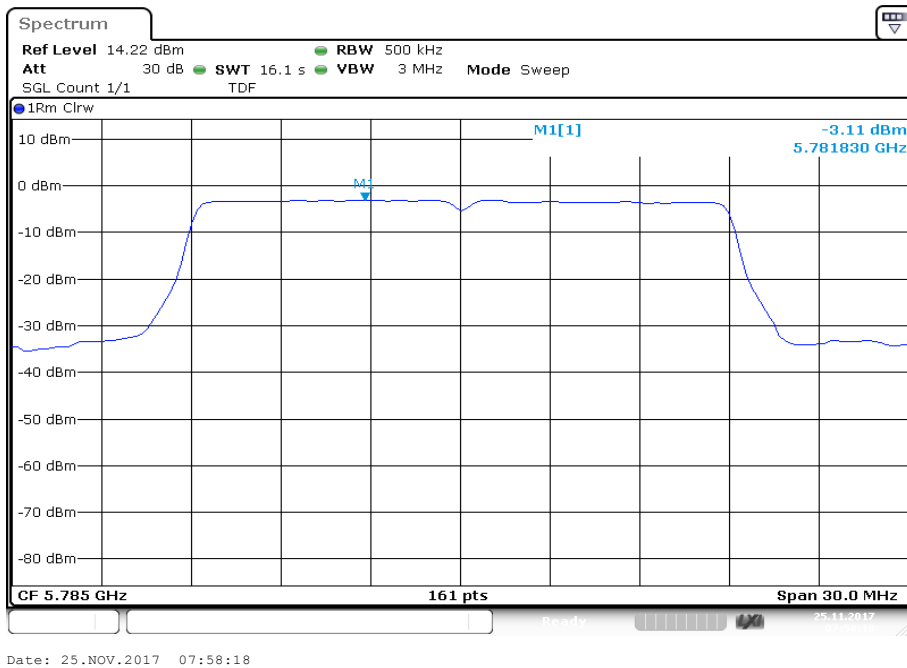

**Plot 3:** U-NII-3; highest channel

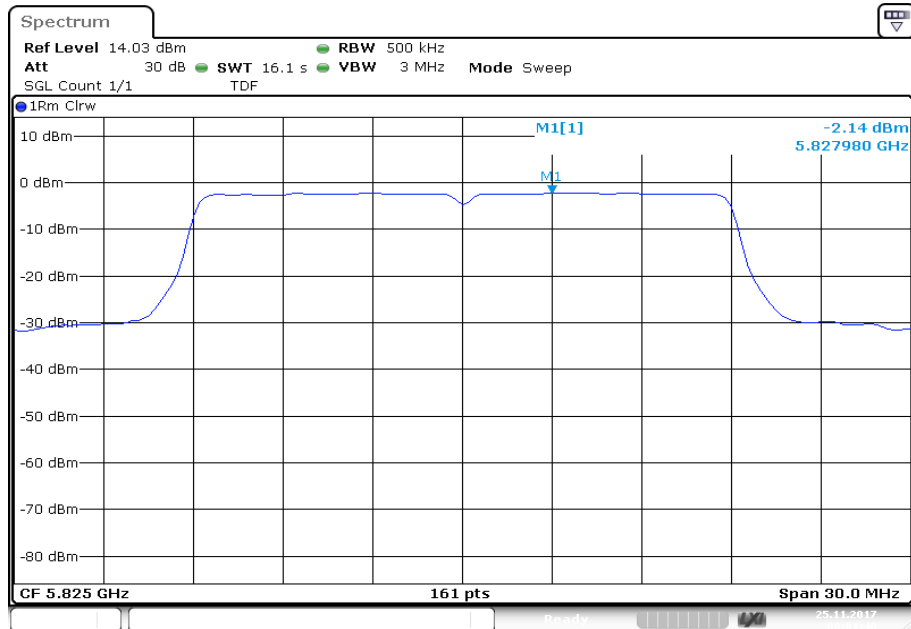

Date: 25.NOV.2017 08:01:40

**Plots:** n/ac HT40 – mode

**Plot 1:** U-NII-3; lowest channel

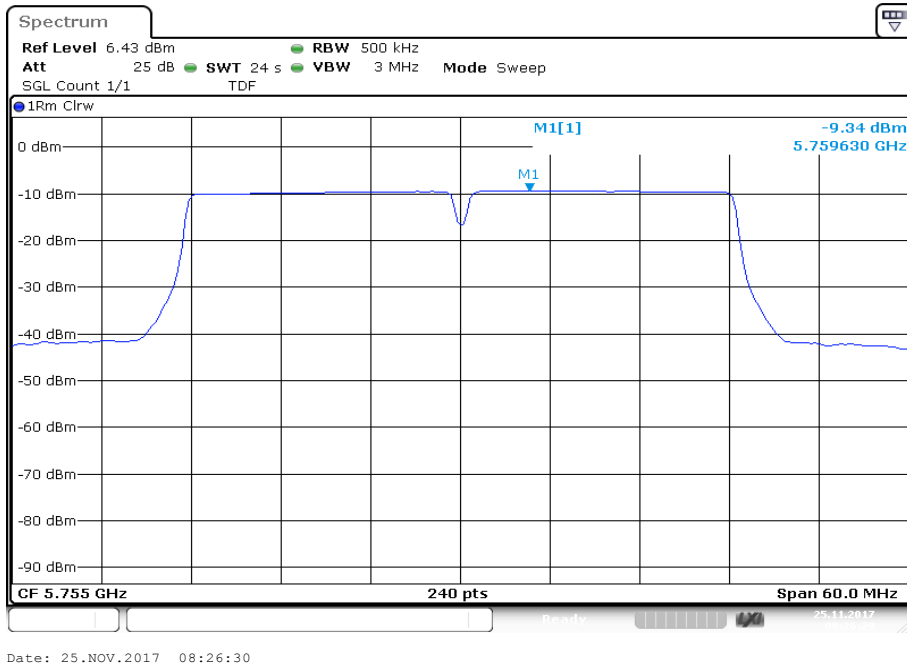

**Plot 2:** U-NII-3; highest channel

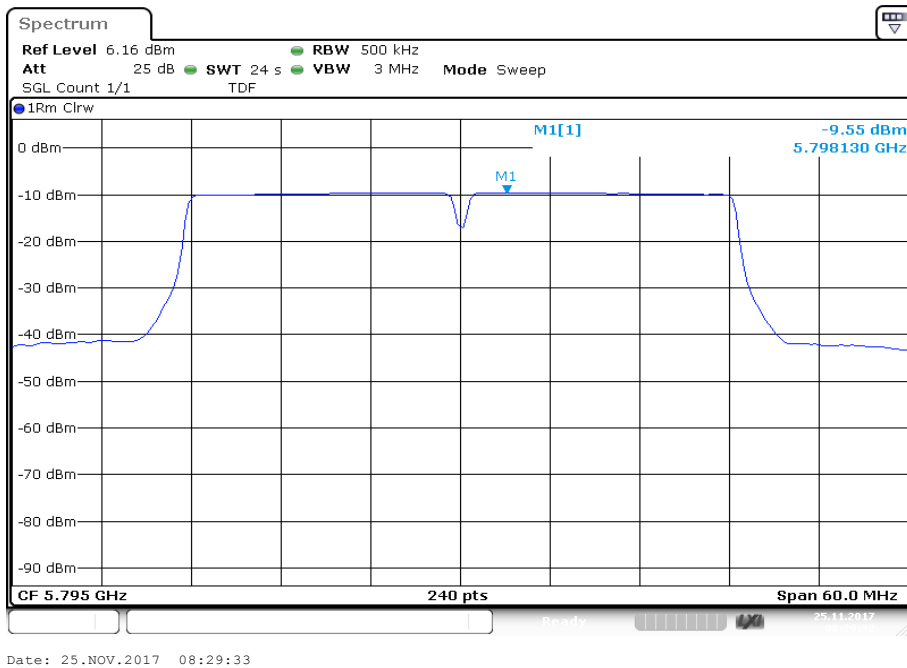

## 11.5.2 Power spectral density according to IC requirements

### Description:

Measurement of the power spectral density of a digital modulated system. The measurement is repeated at the lowest, middle and highest channel.

### Measurement:

Measurement parameter	
Detector:	RMS
Sweep time:	$\geq 10 \cdot (\text{swp points}) \cdot (\text{total on/off time})$
Resolution bandwidth:	1 MHz for U-NII-1/2A & 2C 500 kHz for U-NII-3
Video bandwidth:	$\geq 3 \cdot \text{RBW}$
Span:	$> \text{EBW}$
Trace mode:	Max hold
Used test setup:	See chapter 6.5 – A
Measurement uncertainty:	See chapter 8

### Limits:

Power Spectral Density
power spectral density e.i.r.p. $\leq 10$ dBm in any 1 MHz band (band 5150 – 5250 MHz)
power spectral density conducted $\leq 11$ dBm in any 1 MHz band (band 5250 – 5350 MHz)
power spectral density conducted $\leq 11$ dBm in any 1 MHz band (band 5470 – 5725 MHz)
power spectral density conducted $\leq 30$ dBm in any 500 kHz band (band 5725 – 5850 MHz)

**Results:**

a	Power spectral density (dBm/1MHz or dBm/500kHz)		
	U-NII-1 (5150 MHz to 5250 MHz)		
	Lowest channel	Middle channel	Highest channel
	Conducted		
	0.34	-0.05	-0.30
	Radiated (calculated – see chapter antenna gain)		
	4.34	3.75	3.30
	U-NII-2A (5250 MHz to 5350 MHz)		
	Lowest channel	Middle channel	Highest channel
	-0.21	0.75	0.81
	U-NII-2C (5470 MHz to 5725 MHz)		
	Lowest channel	Middle channel	Highest channel
	3.12	0.71	0.39
	U-NII-3 (5725 MHz to 5850 MHz)		
	Lowest channel	Middle channel	Highest channel
-1.46	-1.86	-0.78	

**Results:**

n/ac HT20	Power spectral density (dBm/1MHz or dBm/500kHz)		
	U-NII-1 (5150 MHz to 5250 MHz)		
	Lowest channel	Middle channel	Highest channel
	Conducted		
	-1.41	-1.60	-1.84
	Radiated (calculated – see chapter antenna gain)		
	2.59	2.20	1.76
	U-NII-2A (5250 MHz to 5350 MHz)		
	Lowest channel	Middle channel	Highest channel
	-1.71	-0.70	-0.81
	U-NII-2C (5470 MHz to 5725 MHz)		
	Lowest channel	Middle channel	Highest channel
	2.16	-0.32	-0.72
	U-NII-3 (5725 MHz to 5850 MHz)		
	Lowest channel	Middle channel	Highest channel
-3.08	-3.17	-2.13	



**Results:**

<b>n/ac HT40</b>	<b>Power spectral density (dBm/1MHz or dBm/500kHz)</b>		
	<b>U-NII-1 (5150 MHz to 5250 MHz)</b>		
	Lowest channel		Highest channel
	Conducted		
	-9.75		-9.91
	Radiated (calculated – see chapter antenna gain)		
	-5.75		-6.31
	<b>U-NII-2A (5250 MHz to 5350 MHz)</b>		
	Lowest channel		Highest channel
	-9.40		-8.56
	<b>U-NII-2C (5470 MHz to 5725 MHz)</b>		
	Lowest channel	Middle channel	Highest channel
	-5.65	-6.06	-7.52
	<b>U-NII-3 (5725 MHz to 5850 MHz)</b>		
	Lowest channel		Highest channel
-9.32		-9.53	

**Plots:** a – mode

**Plot 1:** U-NII-3; lowest channel

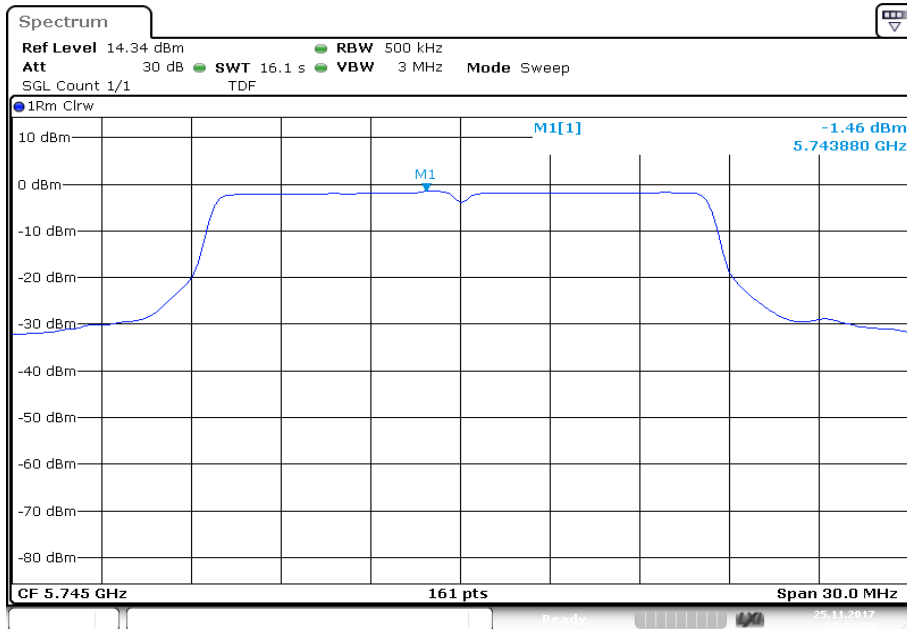

Date: 25.NOV.2017 07:07:54

**Plot 2:** U-NII-3; middle channel

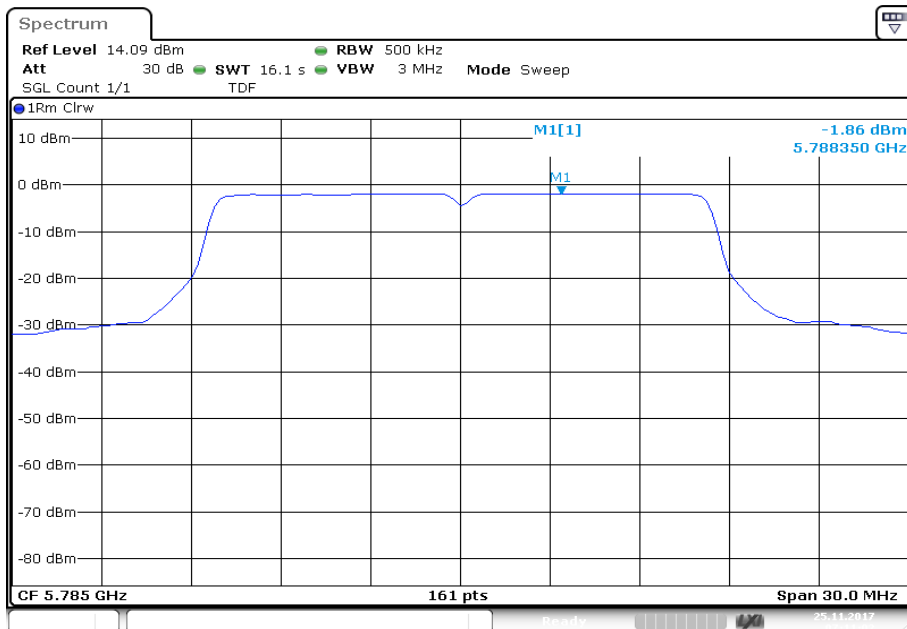

Date: 25.NOV.2017 07:11:02

**Plot 3:** U-NII-3; highest channel

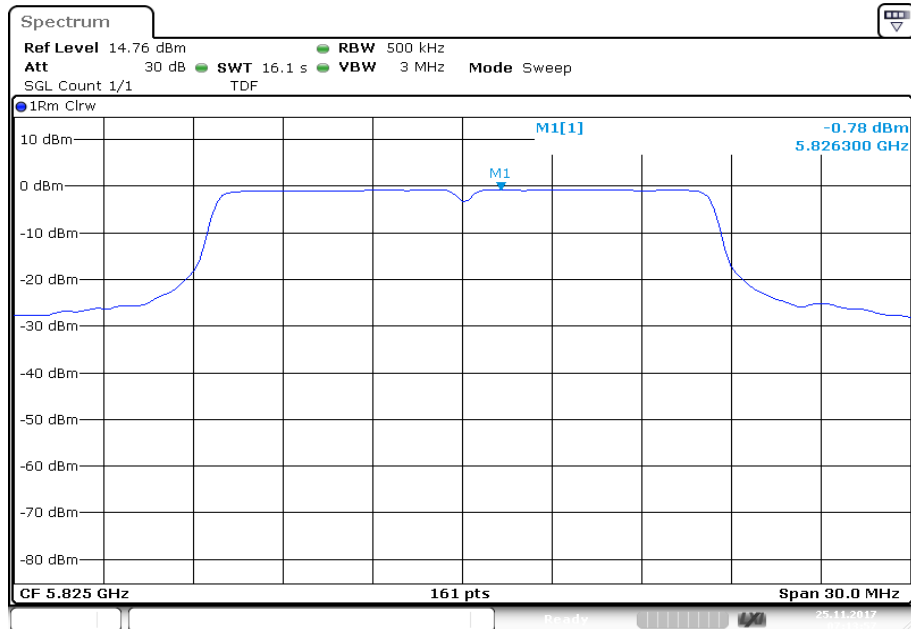

Date: 25.NOV.2017 07:13:57

**Plots:** n/ac HT20 – mode

**Plot 1:** U-NII-3; lowest channel

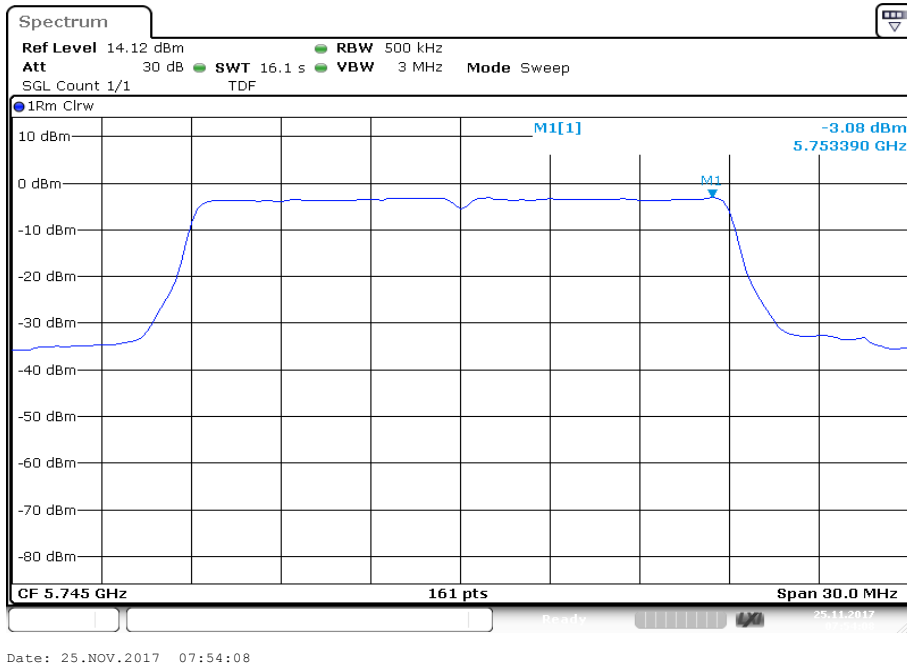

**Plot 2:** U-NII-3; middle channel

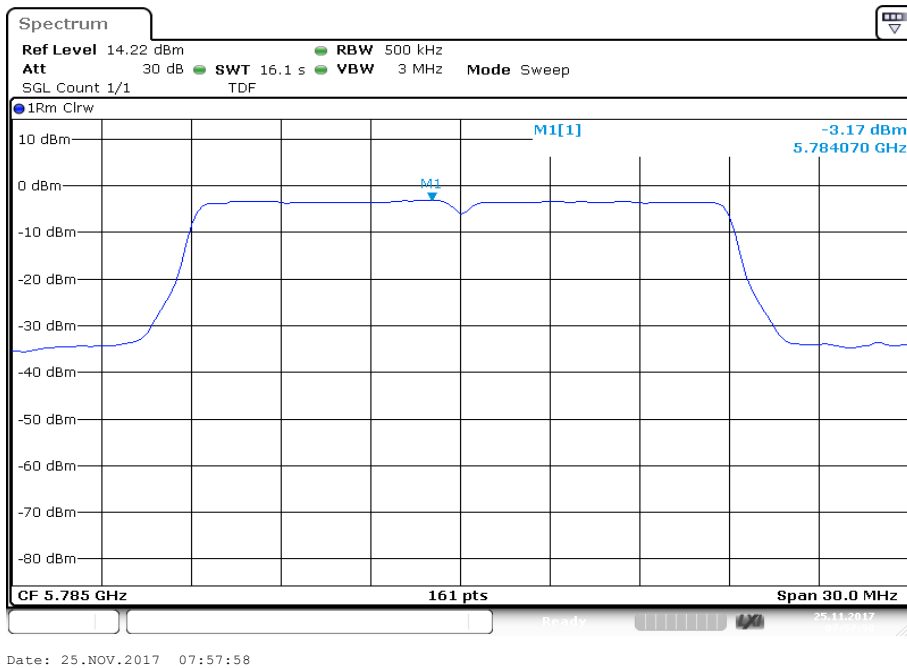

**Plot 3:** U-NII-3; highest channel

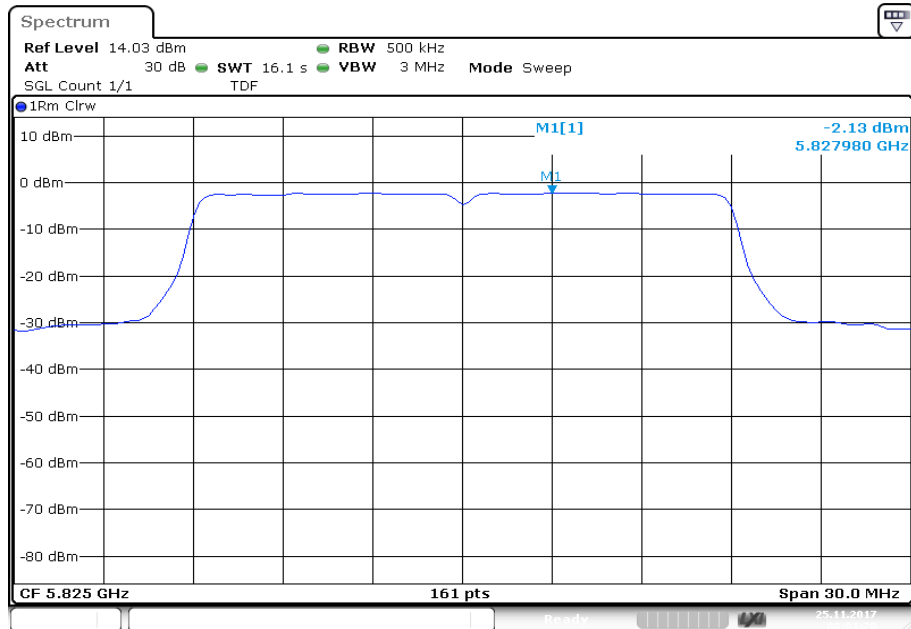

Date: 25.NOV.2017 08:01:20

**Plots:** n/ac HT40 – mode

**Plot 1:** U-NII-3; lowest channel

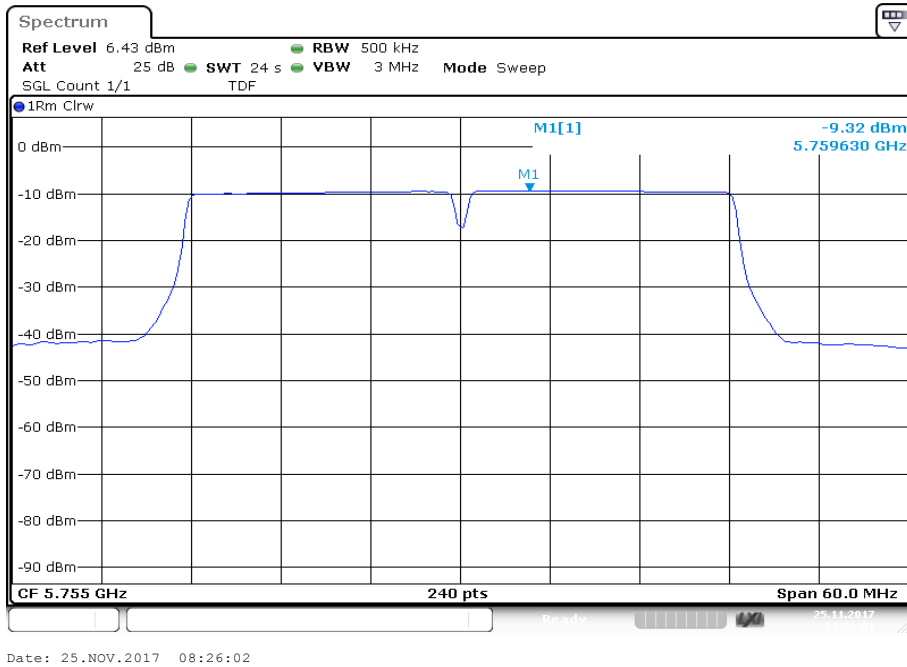

**Plot 2:** U-NII-3; highest channel

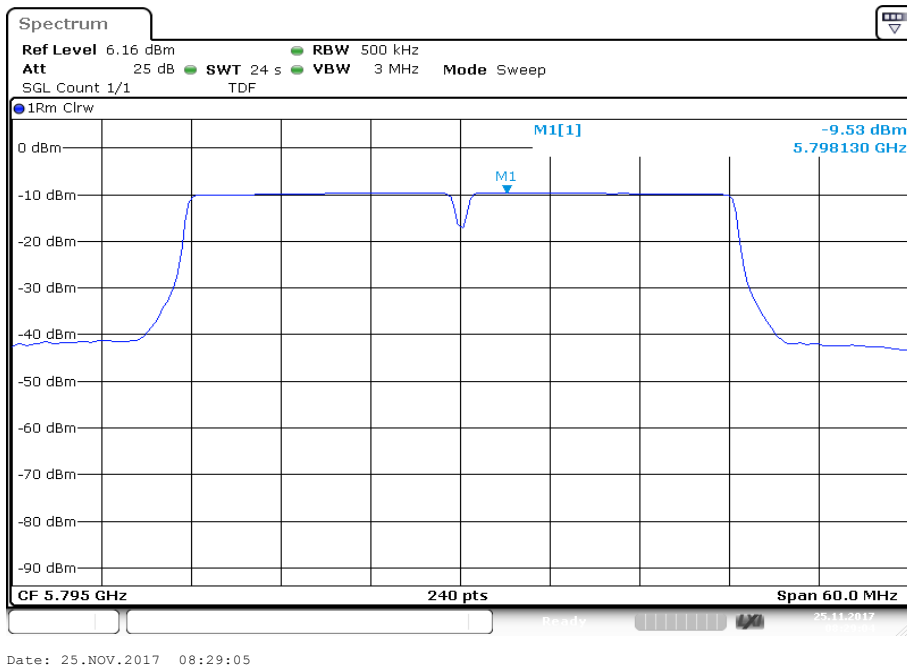

## 11.6 Minimum emission bandwidth for the band 5.725-5.85 GHz

### Description:

Measurement of the 6 dB bandwidth of the modulated signal.

### Measurement:

Measurement parameter	
According to: KDB789033 D02, C.2.	
Detector:	Peak
Sweep time:	Auto
Resolution bandwidth:	100 kHz
Video bandwidth:	300 kHz
Span:	40 MHz
Measurement procedure:	Using marker to find -6dBc frequencies
Trace mode:	Max hold (allow trace to stabilize)
Used test setup:	See chapter 6.5 – A
Measurement uncertainty:	See chapter 8

### Limits:

FCC	IC
The minimum 6 dB bandwidth shall be at least 500 kHz.	

**Results:**

<b>a</b>	<b>6 dB emission bandwidth (MHz)</b>		
	<b>U-NII-3 (5725 MHz to 5850 MHz)</b>		
	Lowest channel	Middle channel	Highest channel
	16.60	16.57	16.60

**Results:**

<b>n/ac HT20</b>	<b>6 dB emission bandwidth (MHz)</b>		
	<b>U-NII-3 (5725 MHz to 5850 MHz)</b>		
	Lowest channel	Middle channel	Highest channel
	17.86	17.86	17.65

**Results:**

<b>n/ac HT40</b>	<b>6 dB emission bandwidth (MHz)</b>	
	<b>U-NII-3 (5725 MHz to 5850 MHz)</b>	
	Lowest channel	Highest channel
	36.68	36.68



**Plots:** a – mode

**Plot 1:** U-NII-3; lowest channel

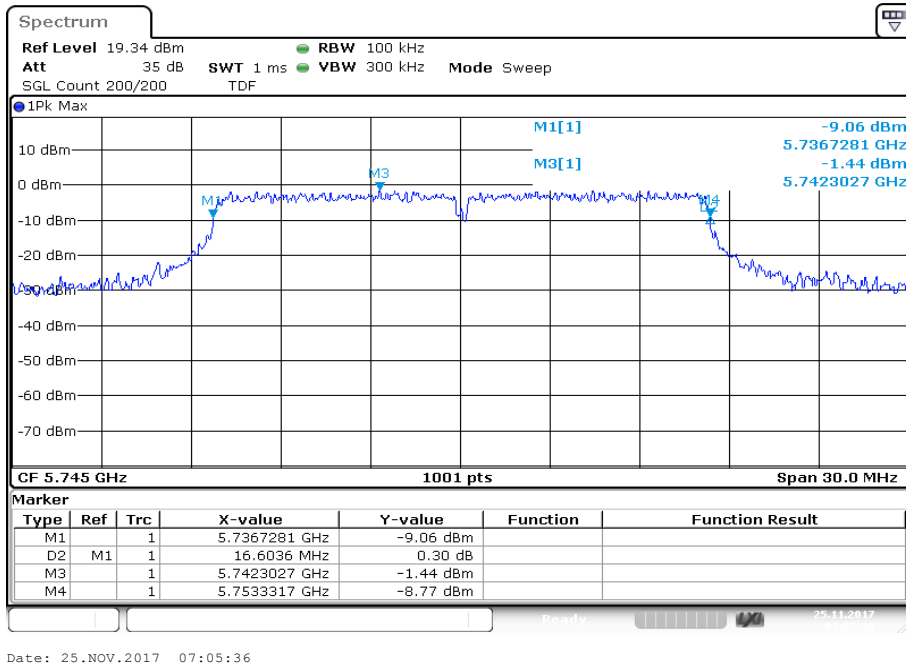

**Plot 2:** U-NII-3; middle channel

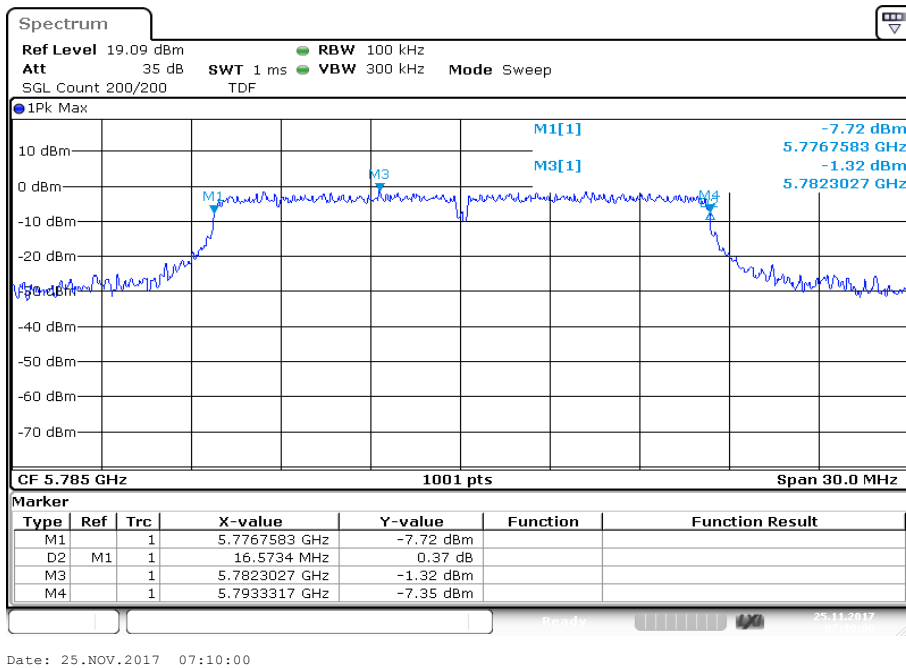

**Plot 3:** U-NII-3; highest channel

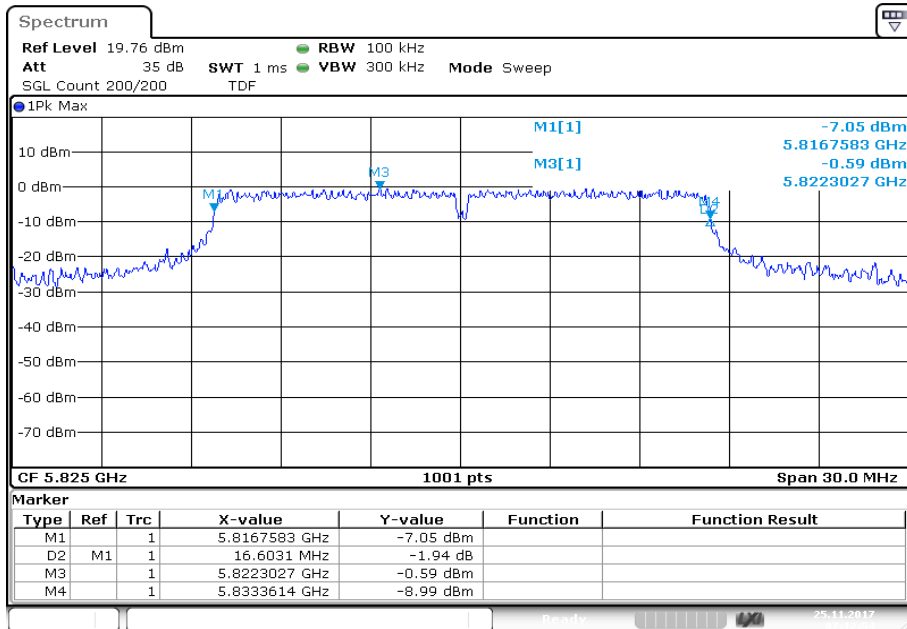

Date: 25.NOV.2017 07:12:54

**Plots:** n/ac HT20 – mode

**Plot 1:** U-NII-3; lowest channel

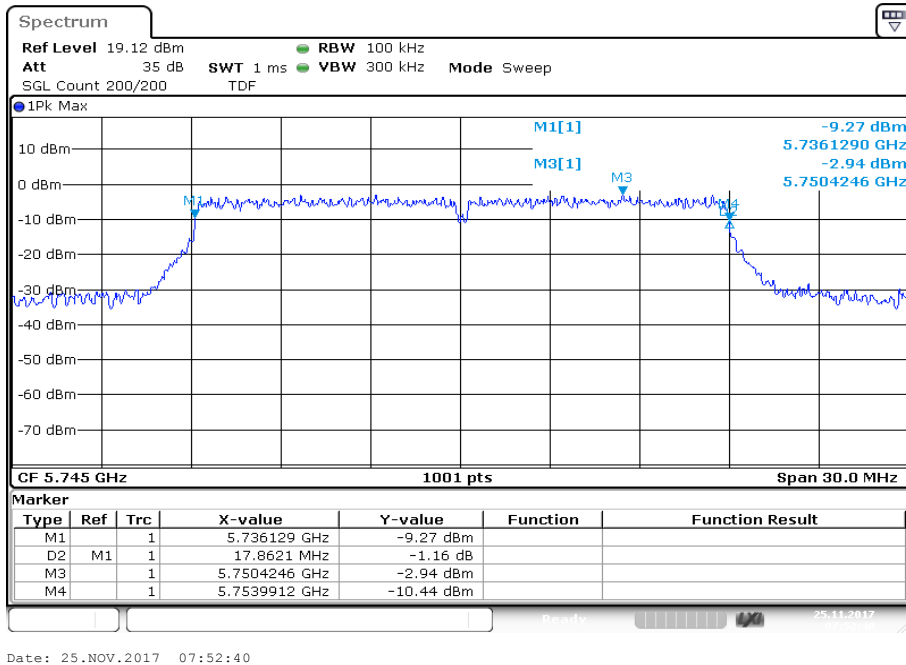

**Plot 2:** U-NII-3; middle channel

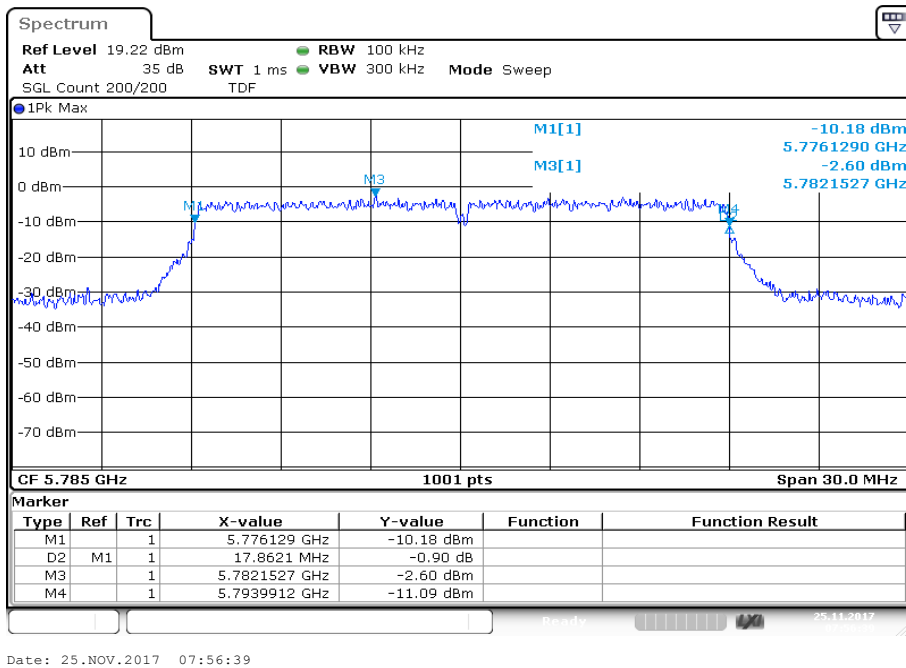

**Plot 3:** U-NII-3; highest channel

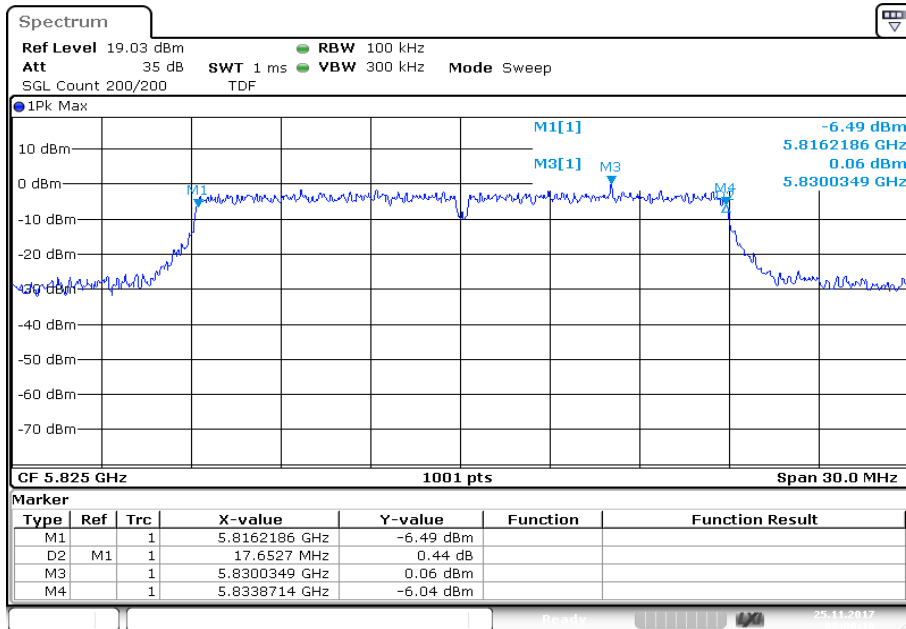

Date: 25.NOV.2017 08:00:19

**Plots:** n/ac HT40 – mode

**Plot 1:** U-NII-3; lowest channel

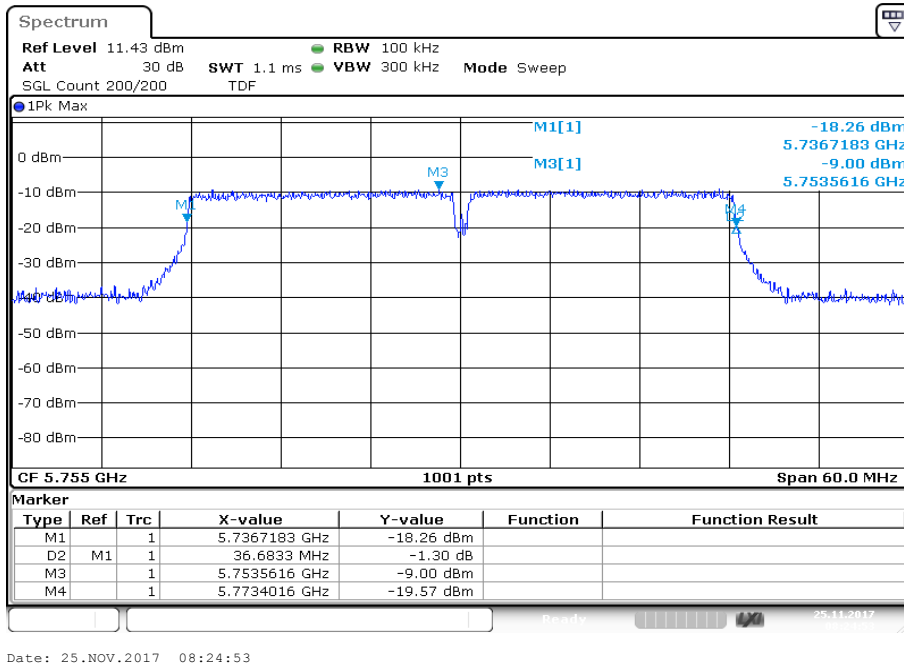

**Plot 2:** U-NII-3; highest channel

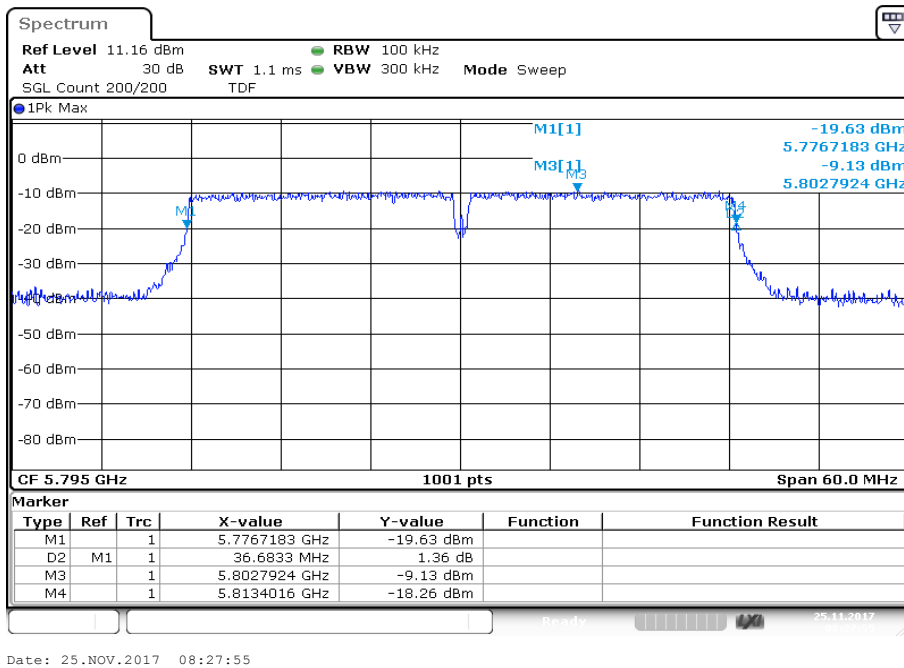

## 11.7 Spectrum bandwidth / 26 dB bandwidth

### Description:

Measurement of the 26 dB bandwidth of the modulated signal.

### Measurement:

Measurement parameter	
According to: KDB789033 D02, C.1.	
Detector:	Peak
Sweep time:	Auto
Resolution bandwidth:	1% EBW
Video bandwidth:	≥ RBW
Span:	> Complete signal
Trace mode:	Max hold
Used test setup:	see chapter 6.5 – A
Measurement uncertainty:	see chapter 8

### Limits:

Spectrum Bandwidth – 26 dB Bandwidth
<p><b>IC:</b> Any unwanted emissions that fall into the band 5250-5350 MHz shall be attenuated below the channel power by at least 26 dB, when measured using a resolution bandwidth between 1 and 5% of the occupied bandwidth (i.e. 99% bandwidth), above 5250 MHz. The 26 dB bandwidth may fall into the 5250-5350 MHz band; however, if the occupied bandwidth also falls within the 5250-5350 MHz band, the transmission is considered as intentional and the devices shall comply with all requirements in the band 5250-5350 MHz including implementing dynamic frequency selection (DFS) and TPC, on the portion of the emission that resides in the 5250-5350 MHz band.</p> <p><b>FCC:</b> Radar Detection Function of Dynamic Frequency Selection (DFS). U-NII devices operating with any part of its 26 dB emission bandwidth in the 5.25-5.35 GHz and 5.47-5.725 GHz bands shall employ a DFS radar detection mechanism to detect the presence of radar systems and to avoid co-channel operation with radar systems.</p>

**Results:**

<b>a</b>	<b>26 dB bandwidth (MHz)</b>		
	<b>U-NII-1 (5150 MHz to 5250 MHz)</b>		
	Lowest channel	Middle channel	Highest channel
	20.23	20.68	20.33
	Lowest frequency		Highest frequency
	5170.0100		5250.040
	<b>U-NII-2A (5250 MHz to 5350 MHz)</b>		
	Lowest channel	Middle channel	Highest channel
	20.18	23.08	24.48
	<b>U-NII-2C (5470 MHz to 5725 MHz)</b>		
	Lowest channel	Middle channel	Highest channel
	34.22	25.03	23.33
	<b>U-NII-3 (5725 MHz to 5850 MHz)</b>		
	Lowest channel	Middle channel	Highest channel
	32.87	32.12	34.97
	Lowest frequency		Highest frequency
5728.916		5843.282	

Note: For DFS see report 1-4862/17-01-04

**Results:**

<b>n/ac HT20</b>	<b>26 dB bandwidth (MHz)</b>		
	<b>U-NII-1 (5150 MHz to 5250 MHz)</b>		
	Lowest channel	Middle channel	Highest channel
	20.78	20.58	20.88
	Lowest frequency		Highest frequency
	5169.760		5250.440
	<b>U-NII-2A (5250 MHz to 5350 MHz)</b>		
	Lowest channel	Middle channel	Highest channel
	20.88	20.63	20.63
	<b>U-NII-2C (5470 MHz to 5725 MHz)</b>		
	Lowest channel	Middle channel	Highest channel
	31.27	20.83	20.68
	<b>U-NII-3 (5725 MHz to 5850 MHz)</b>		
	Lowest channel	Middle channel	Highest channel
	25.82	24.63	32.87
Lowest frequency		Highest frequency	
5734.111		5842.932	

Note: For DFS see report 1-4862/17-01-04



**Results:**

<b>n/ac HT40</b>	<b>26 dB bandwidth (MHz)</b>		
	<b>U-NII-1 (5150 MHz to 5250 MHz)</b>		
	Lowest channel		Highest channel
	41.46		41.56
	Lowest frequency		Highest frequency
	5169.320		5250.979
	<b>U-NII-2A (5250 MHz to 5350 MHz)</b>		
	Lowest channel		Highest channel
	41.46		41.66
	<b>U-NII-2C (5470 MHz to 5725 MHz)</b>		
	Lowest channel	Middle channel	Highest channel
	41.56	41.46	41.56
	<b>U-NII-3 (5725 MHz to 5850 MHz)</b>		
	Lowest channel		Highest channel
	41.36		41.56
	Lowest frequency		Highest frequency
5734.421		5815.879	

**Plots:** a – mode

**Plot 1:** U-NII-1; lowest channel

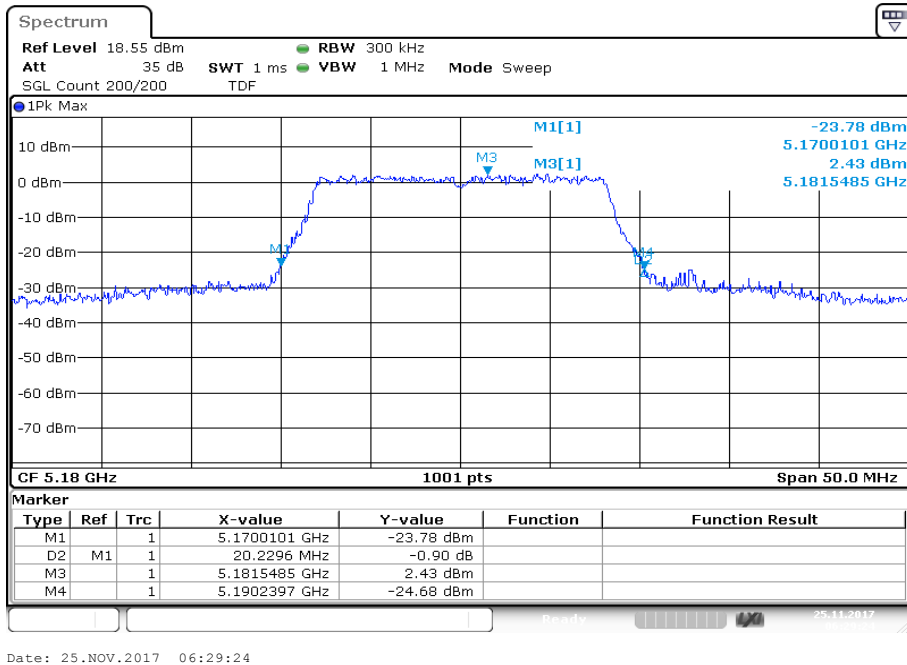

**Plot 2:** U-NII-1; middle channel

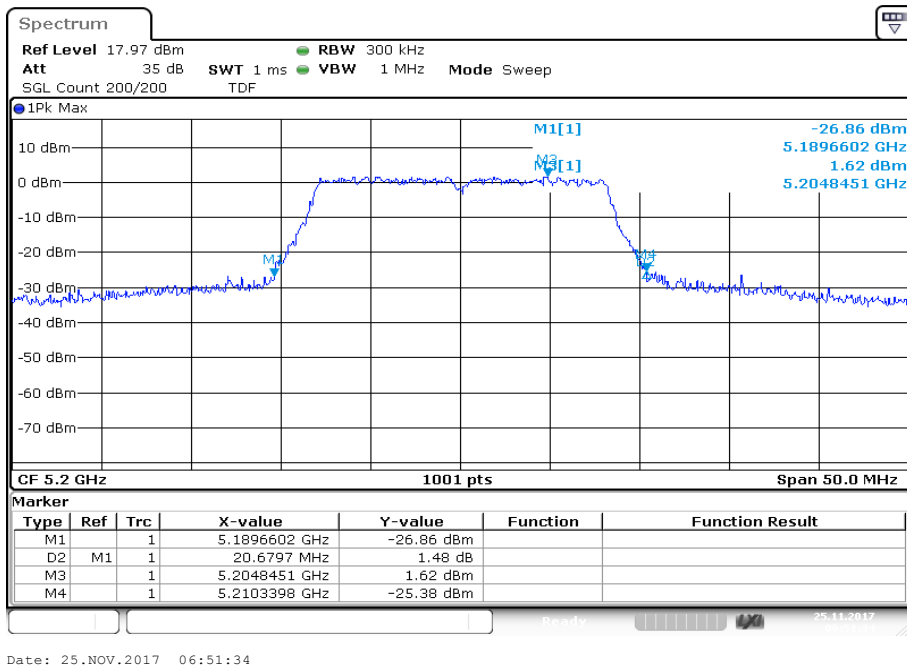

**Plot 3:** U-NII-1; highest channel

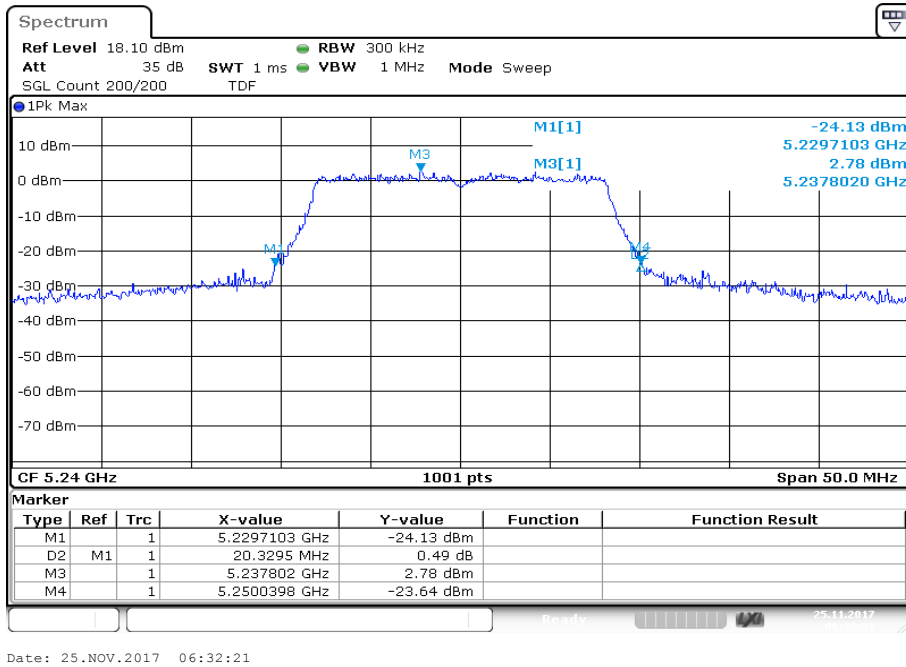

**Plot 4:** U-NII-2A; lowest channel

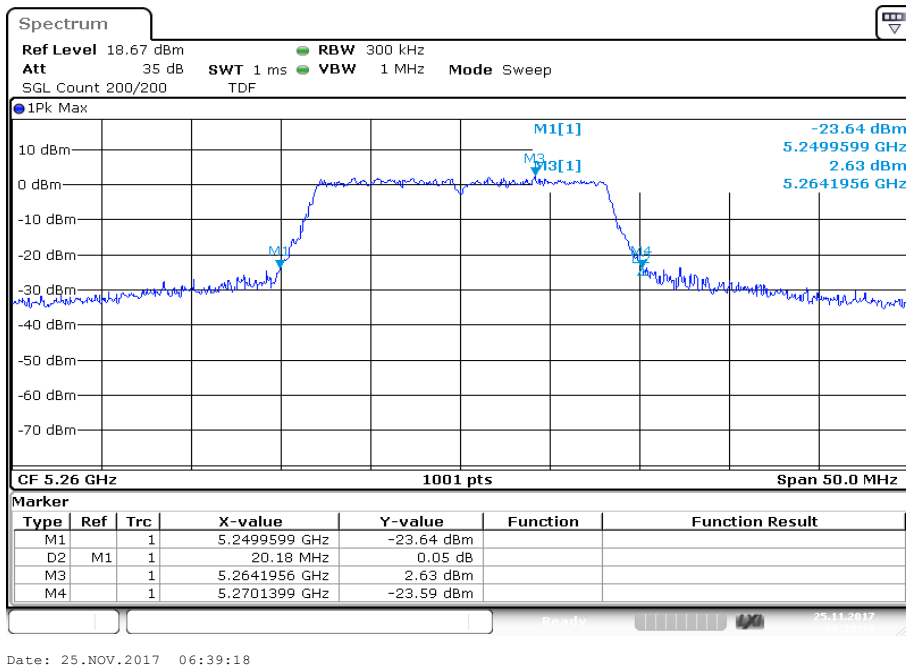

Plot 5: U-NII-2A; middle channel

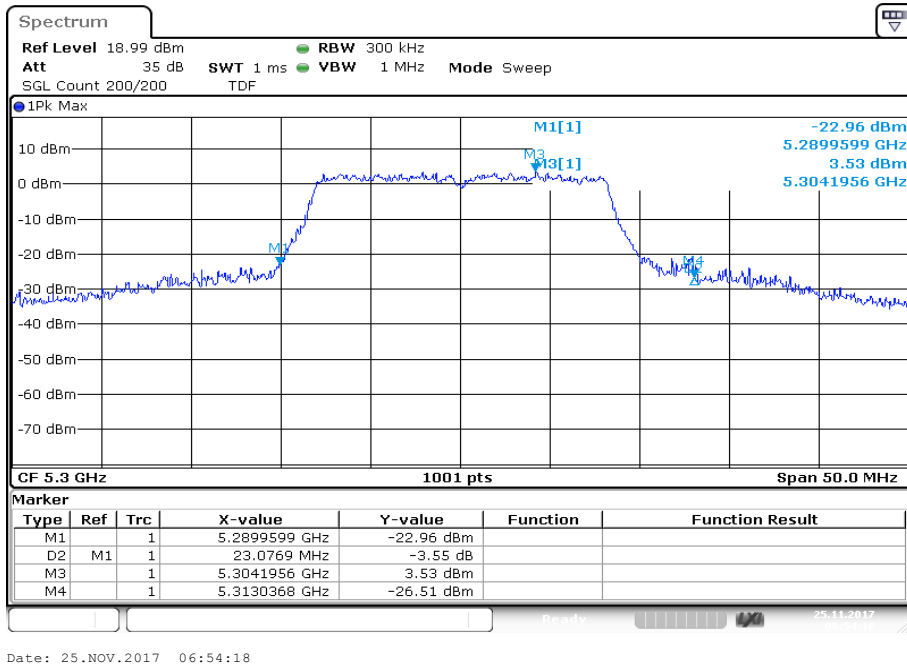

Plot 6: U-NII-2A; highest channel

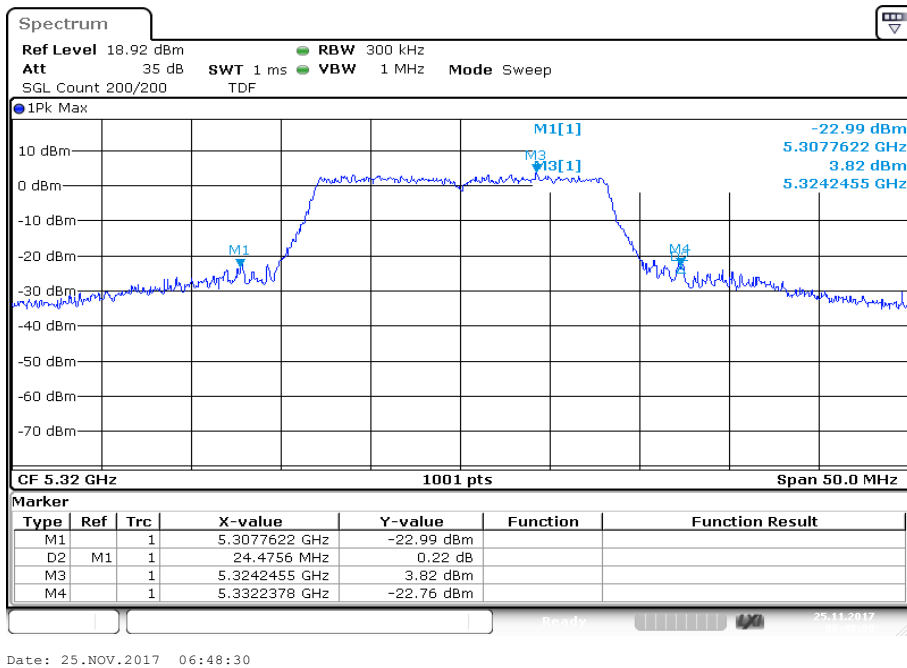

**Plot 7:** U-NII-2C; lowest channel

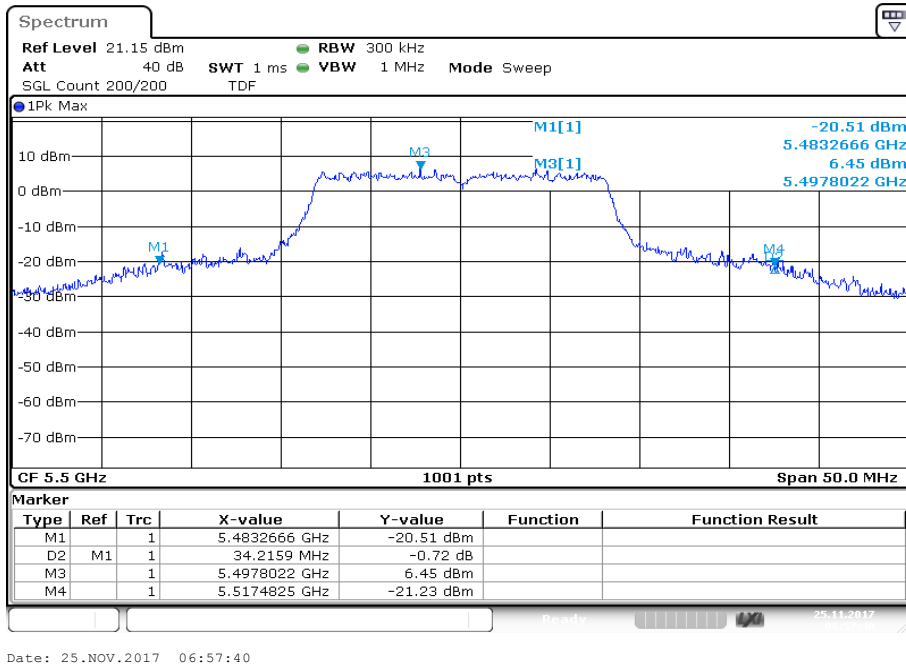

**Plot 8:** U-NII-2C; middle channel

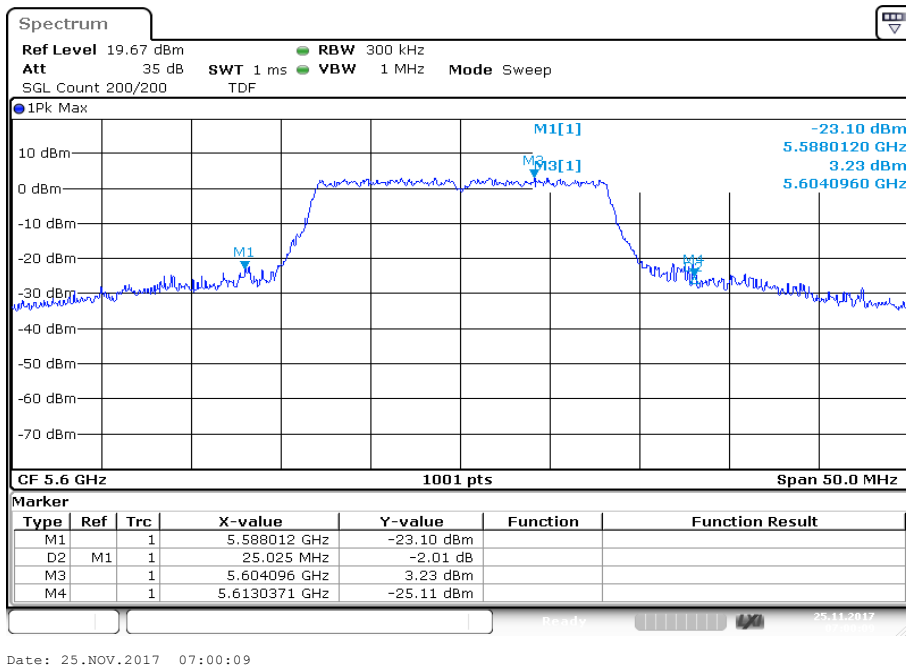

**Plot 9:** U-NII-2C; highest channel

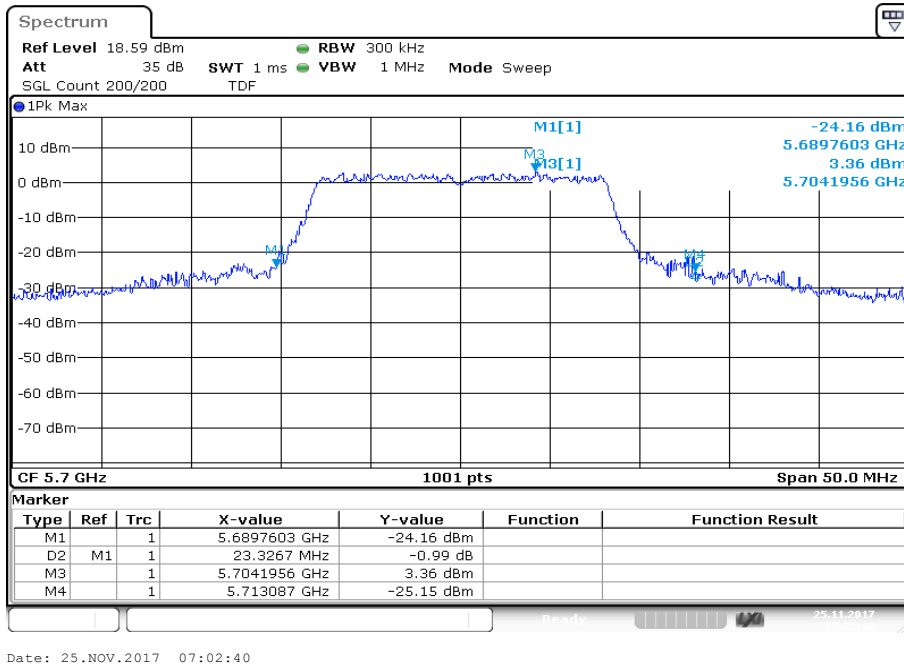

**Plot 10:** U-NII-3; lowest channel

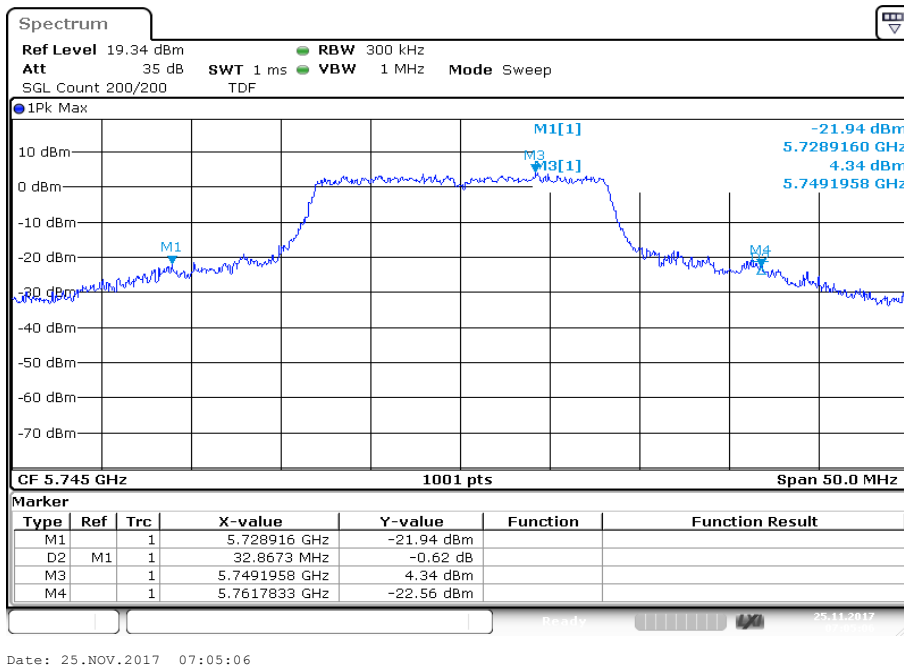

Plot 11: U-NII-3; middle channel

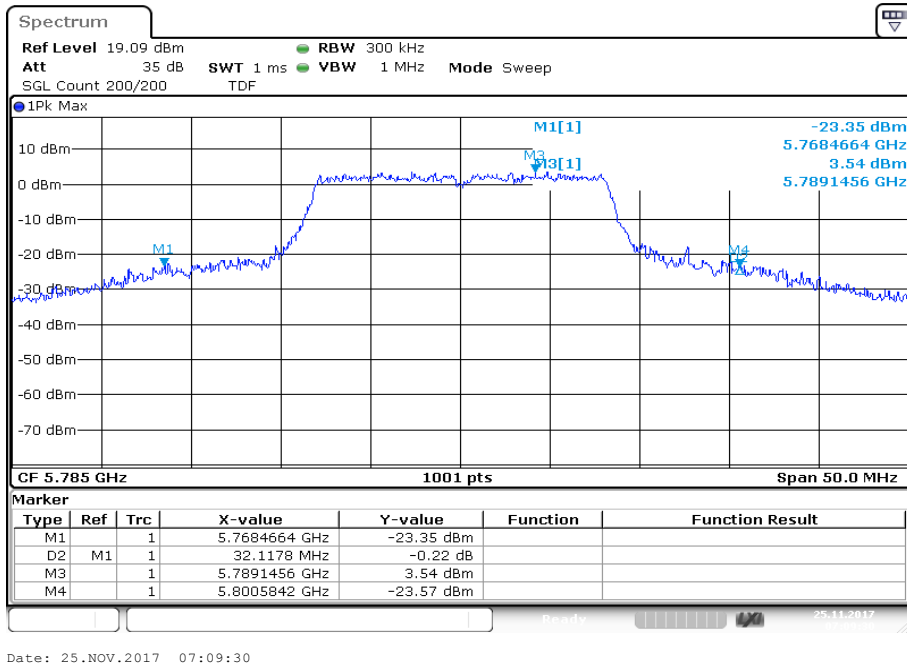

Plot 12: U-NII-3; highest channel

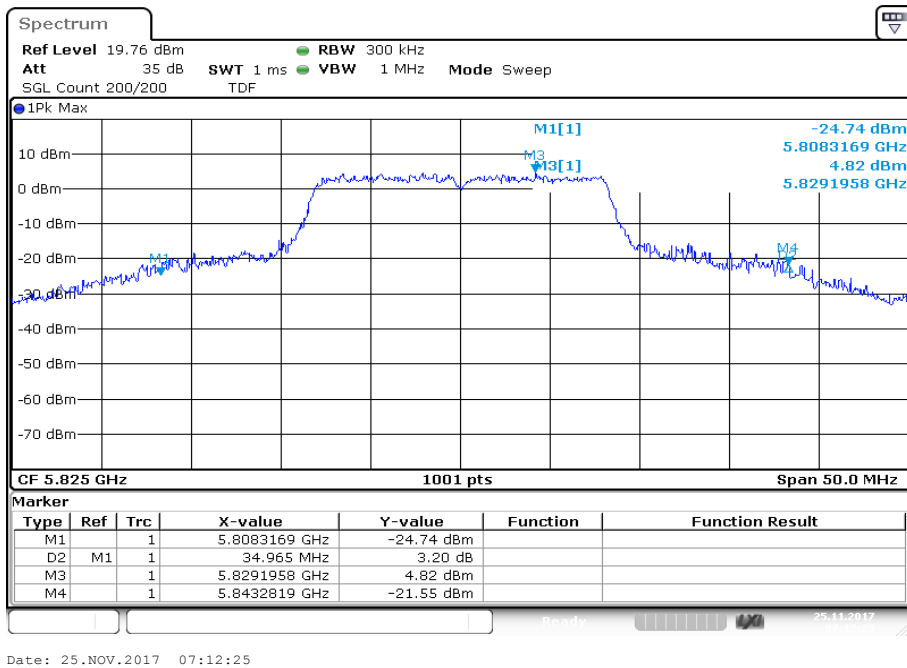

**Plots:** n/ac HT20 – mode

**Plot 1:** U-NII-1; lowest channel

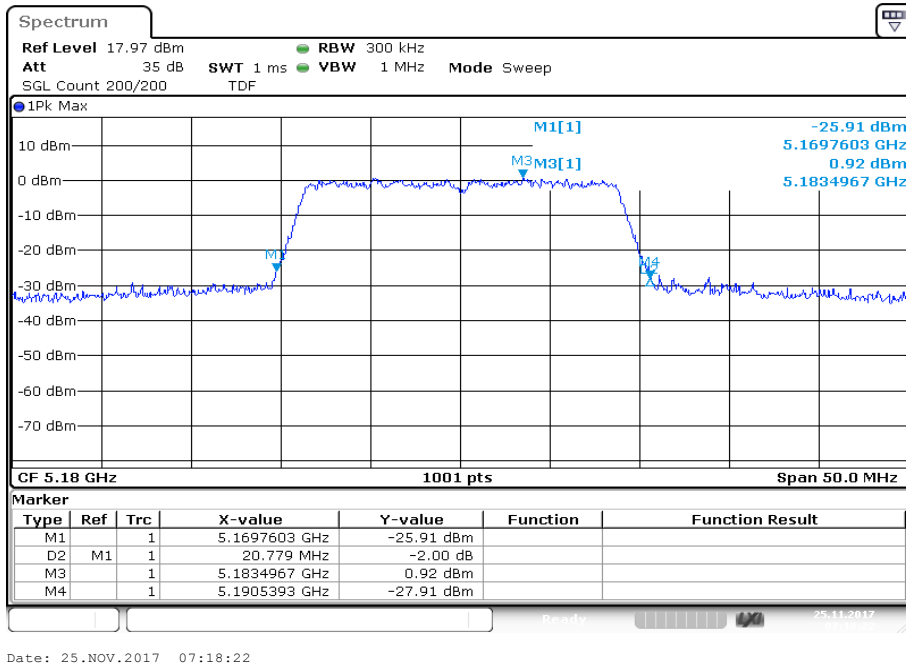

**Plot 2:** U-NII-1; middle channel

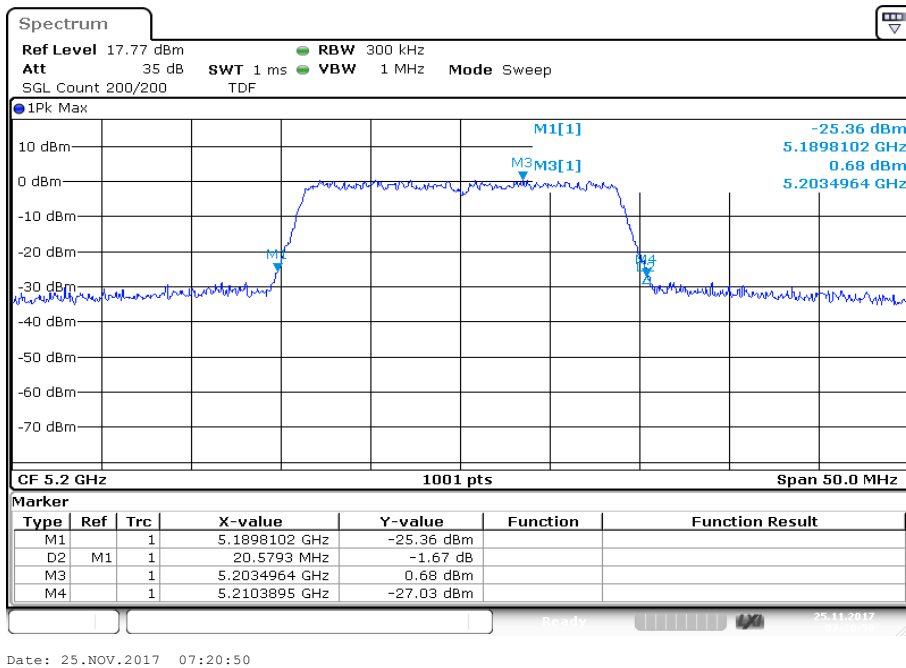



**Plot 3:** U-NII-1; highest channel

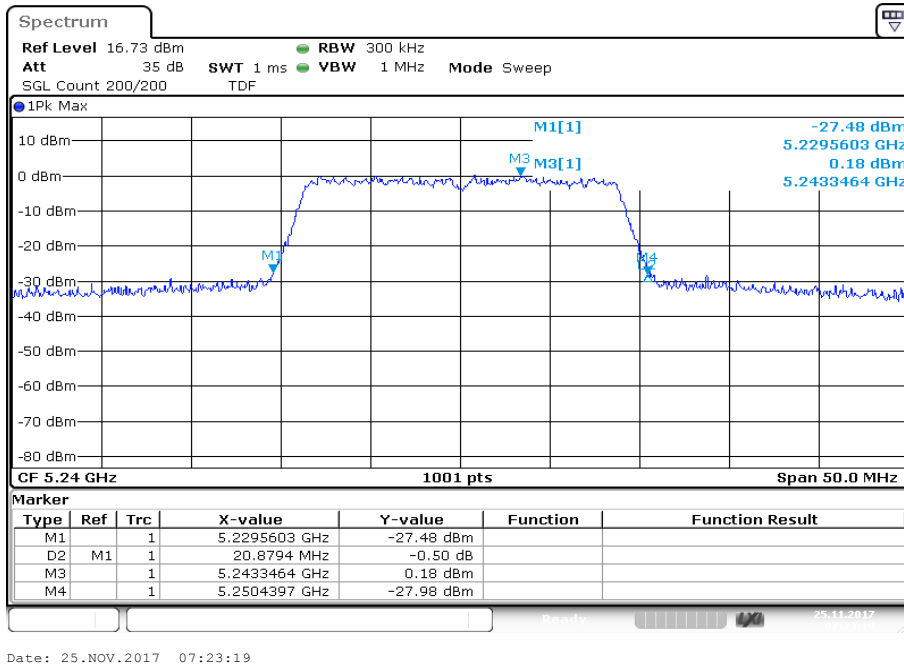

**Plot 4:** U-NII-2A; lowest channel

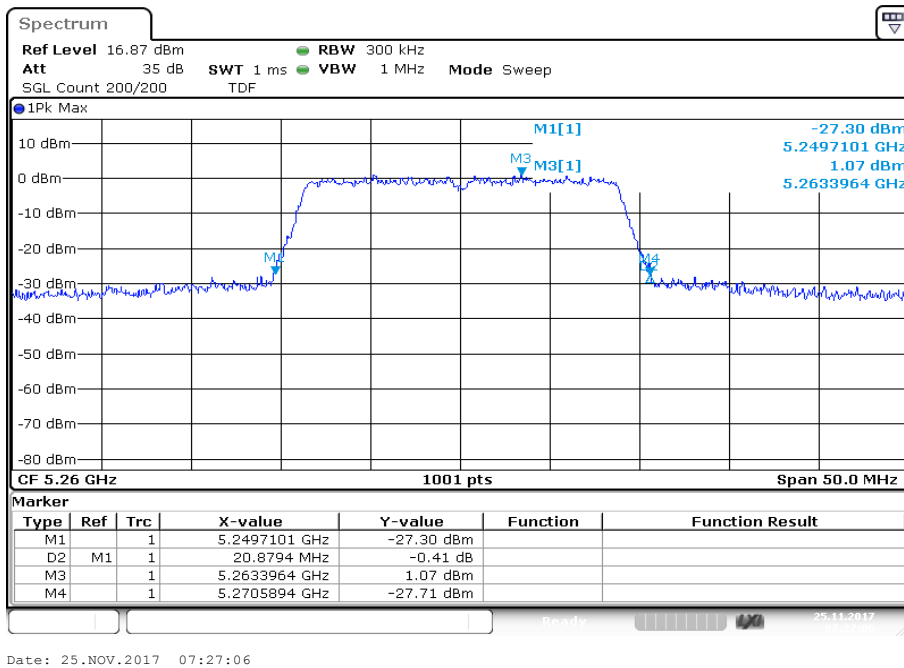

**Plot 5:** U-NII-2A; middle channel

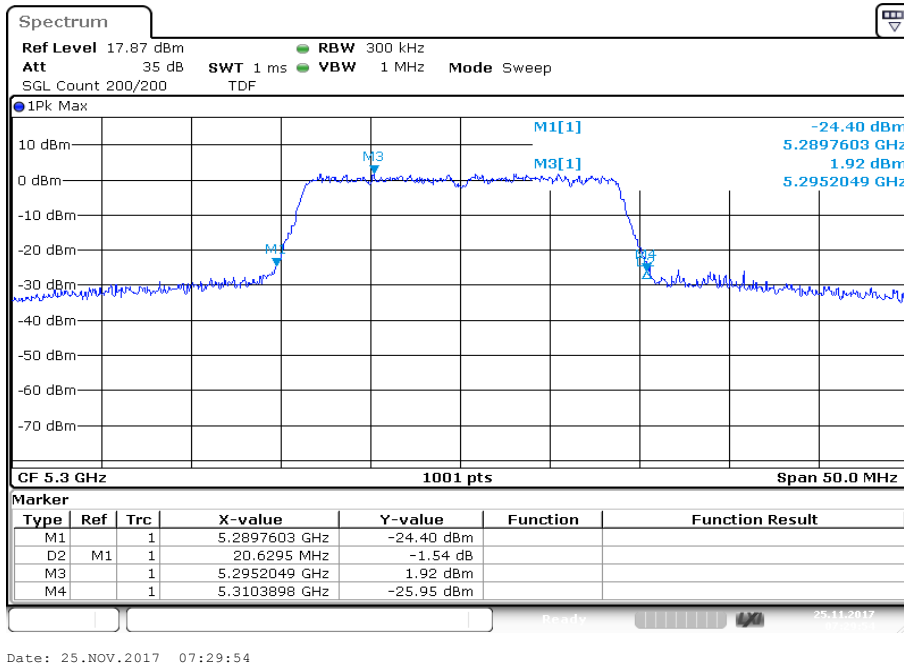

**Plot 6:** U-NII-2A; highest channel

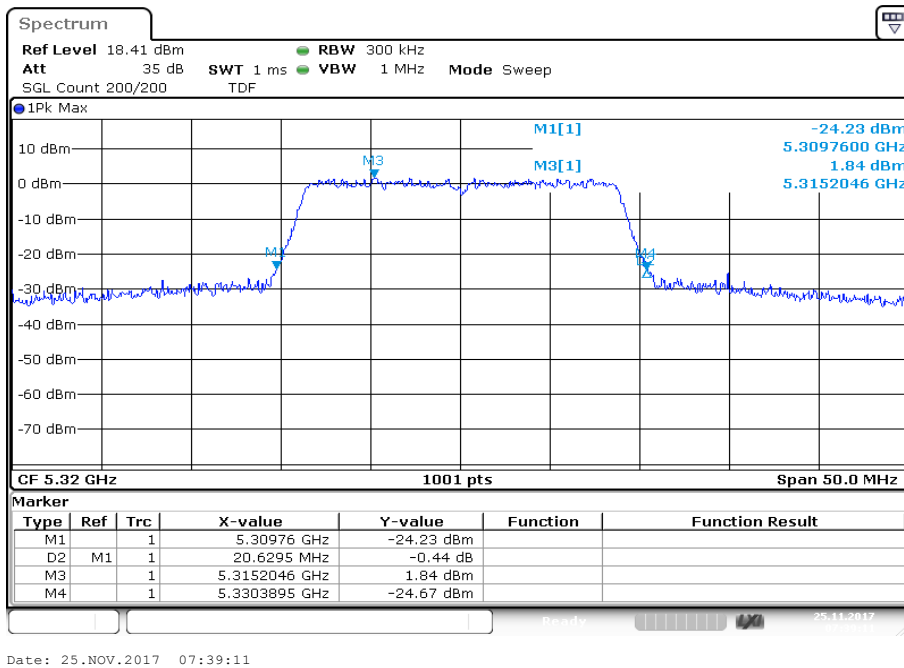

**Plot 7:** U-NII-2C; lowest channel

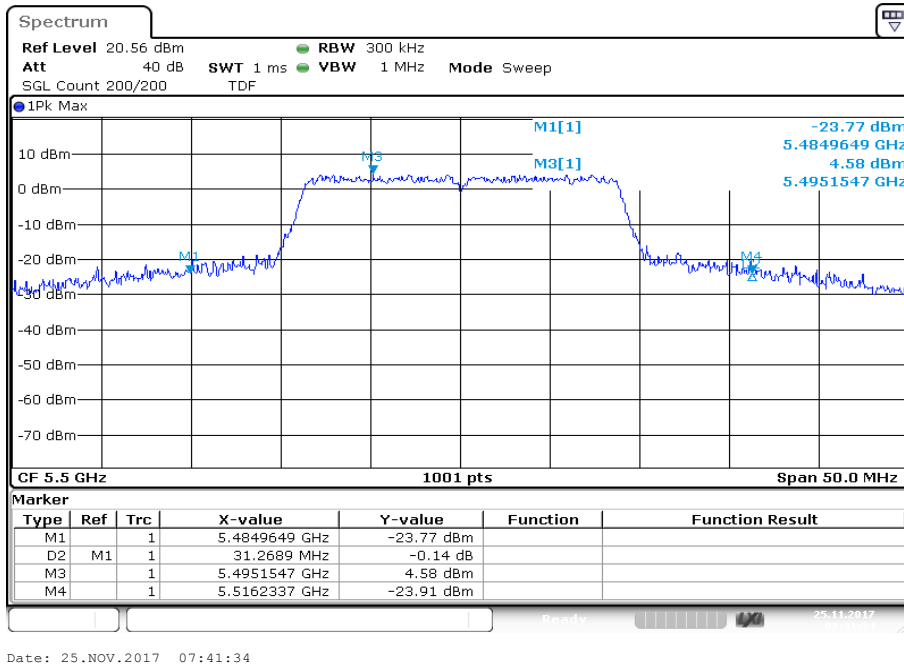

**Plot 8:** U-NII-2C; middle channel

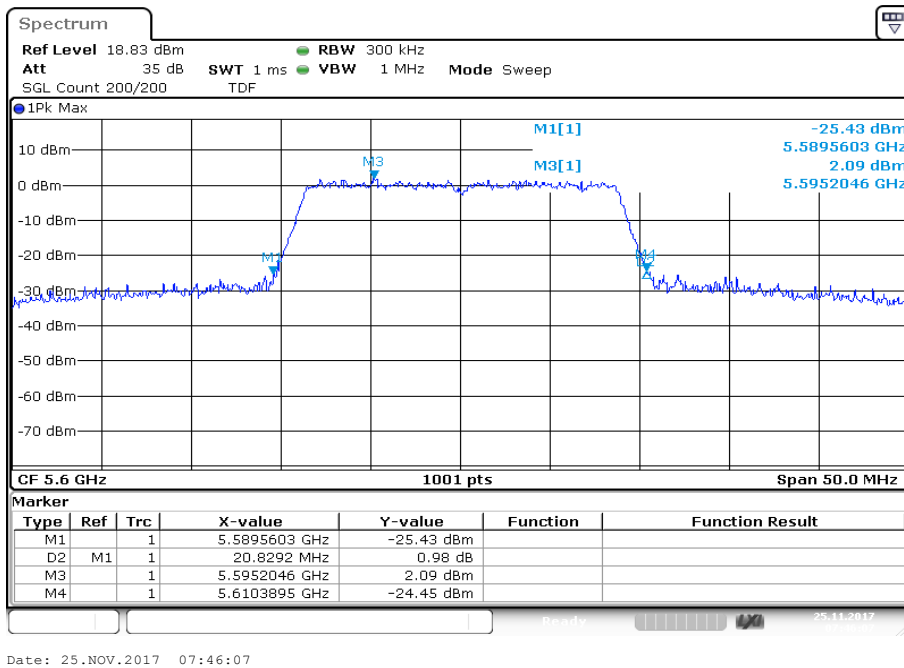

**Plot 9:** U-NII-2C; highest channel

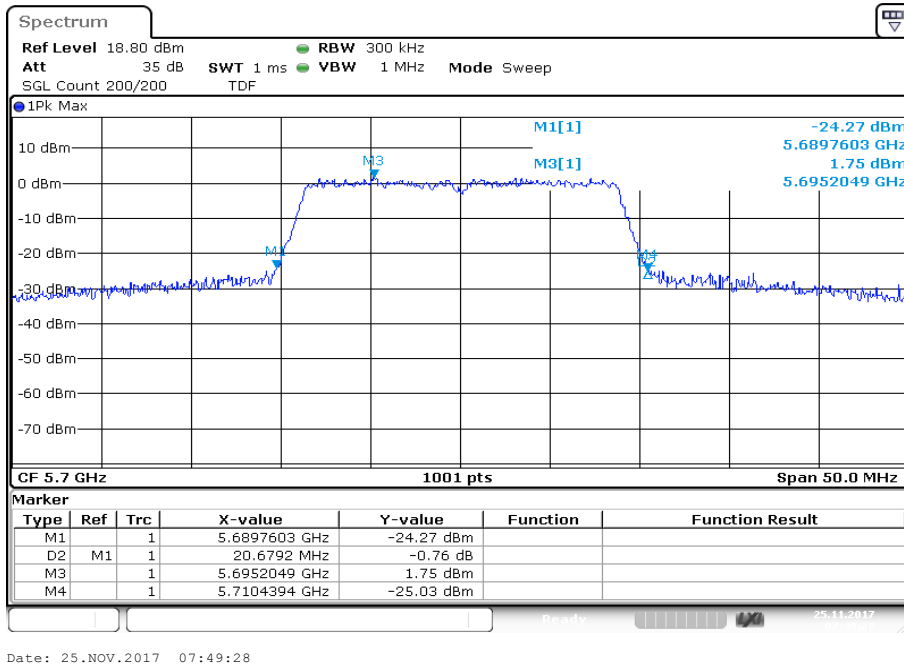

**Plot 10:** U-NII-3; lowest channel

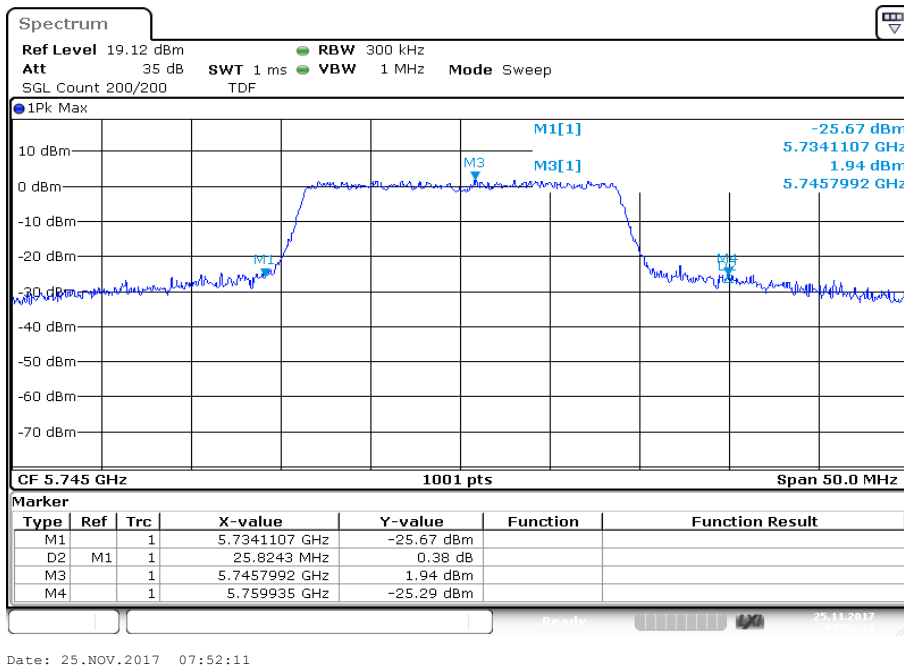

Plot 11: U-NII-3; middle channel

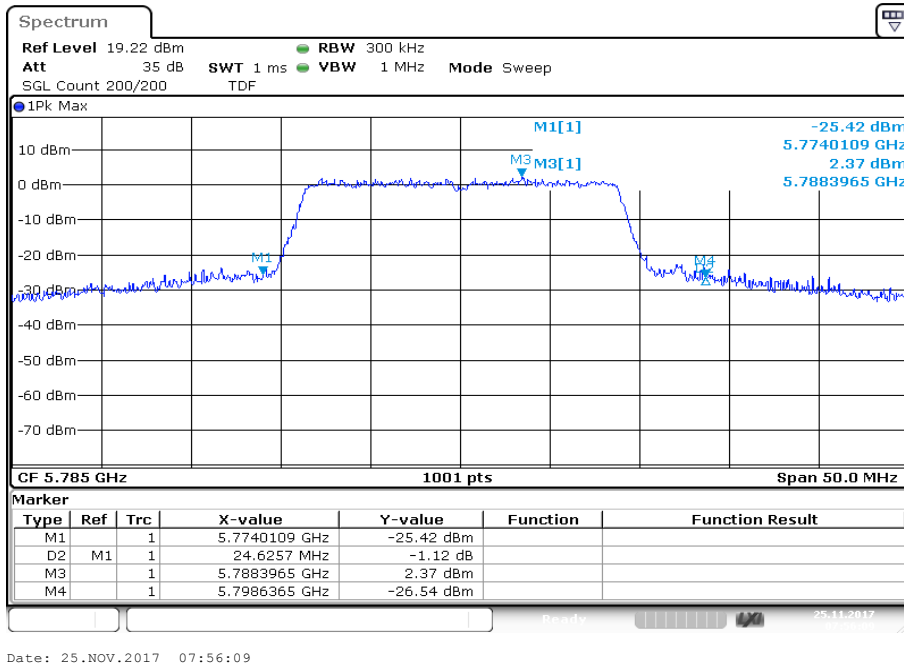

Plot 12: U-NII-3; highest channel

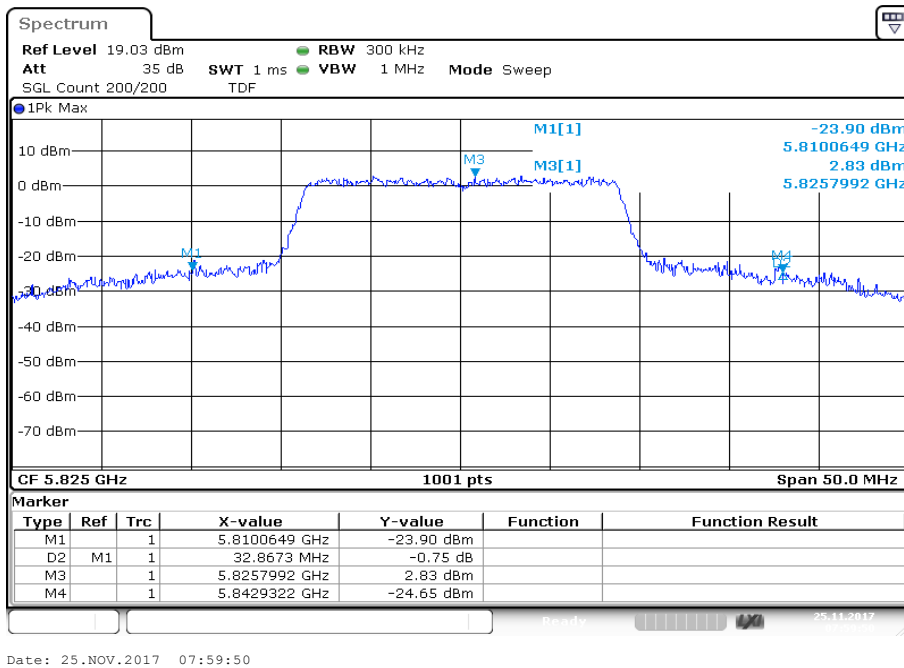

**Plots:** n/ac HT40 – mode

**Plot 1:** U-NII-1; lowest channel

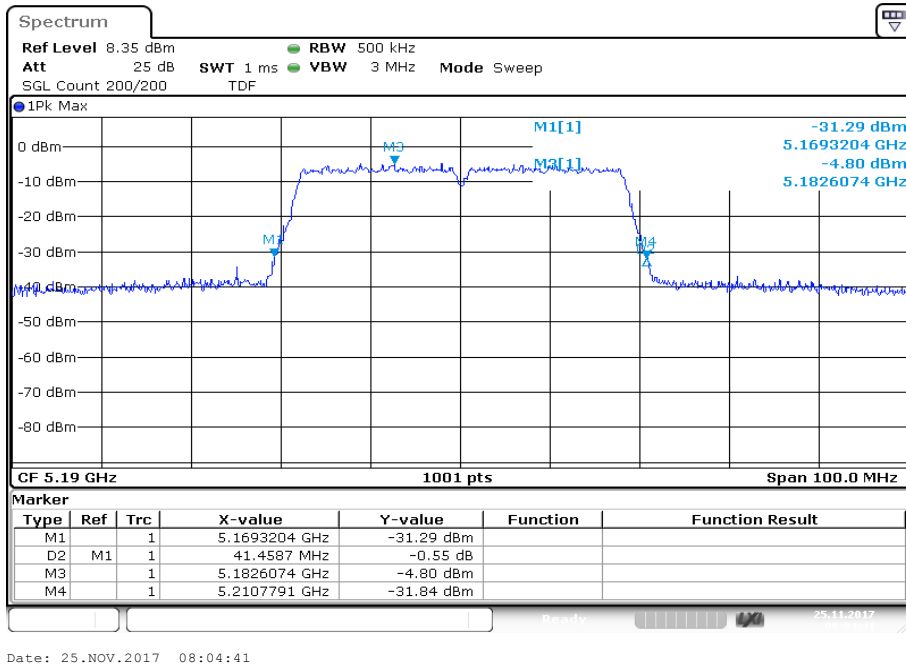

**Plot 2:** U-NII-1; highest channel

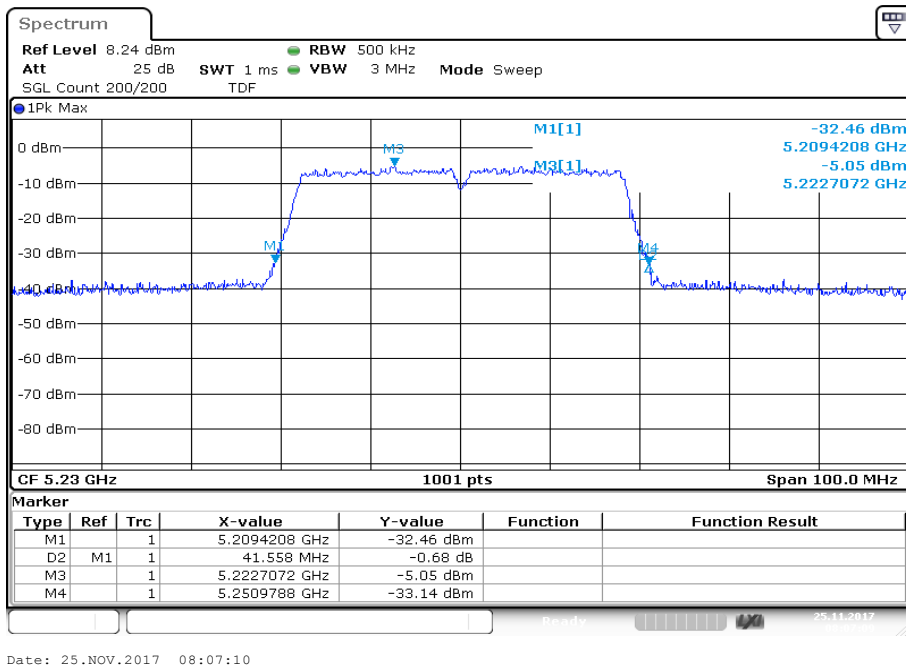

**Plot 3:** U-NII-2A; lowest channel

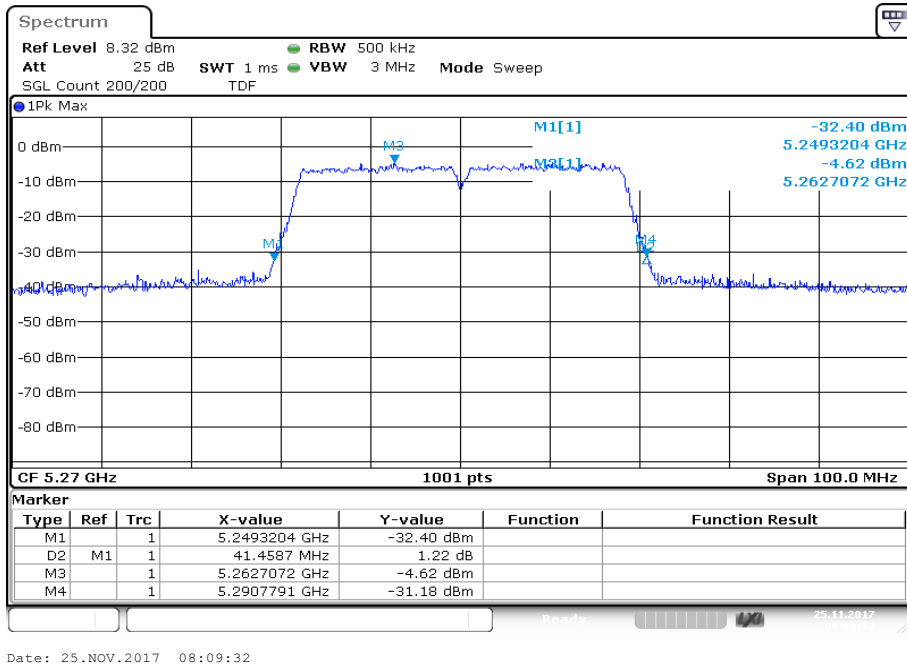

**Plot 4:** U-NII-2A; highest channel

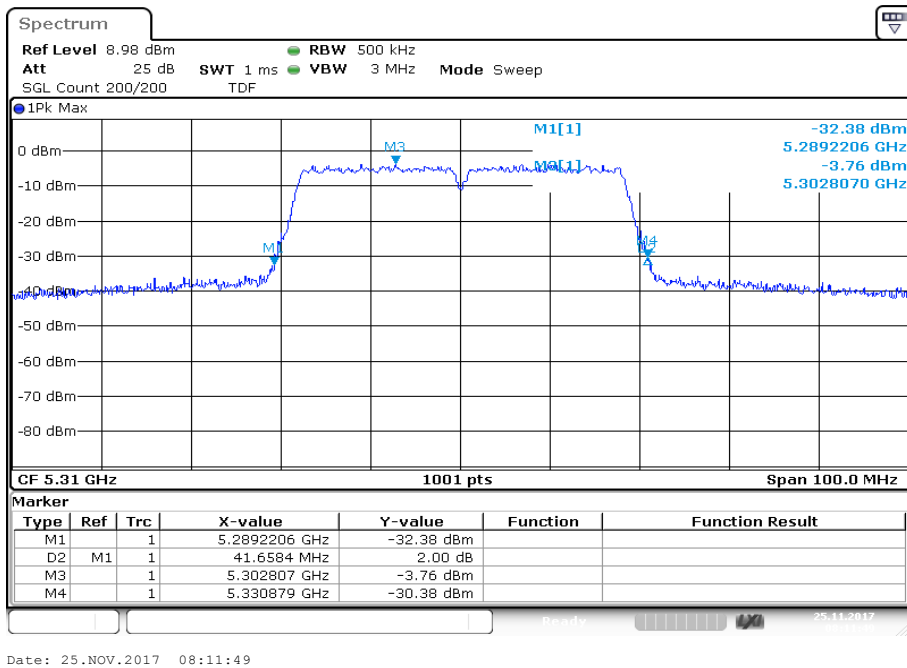

**Plot 5:** U-NII-2C; lowest channel

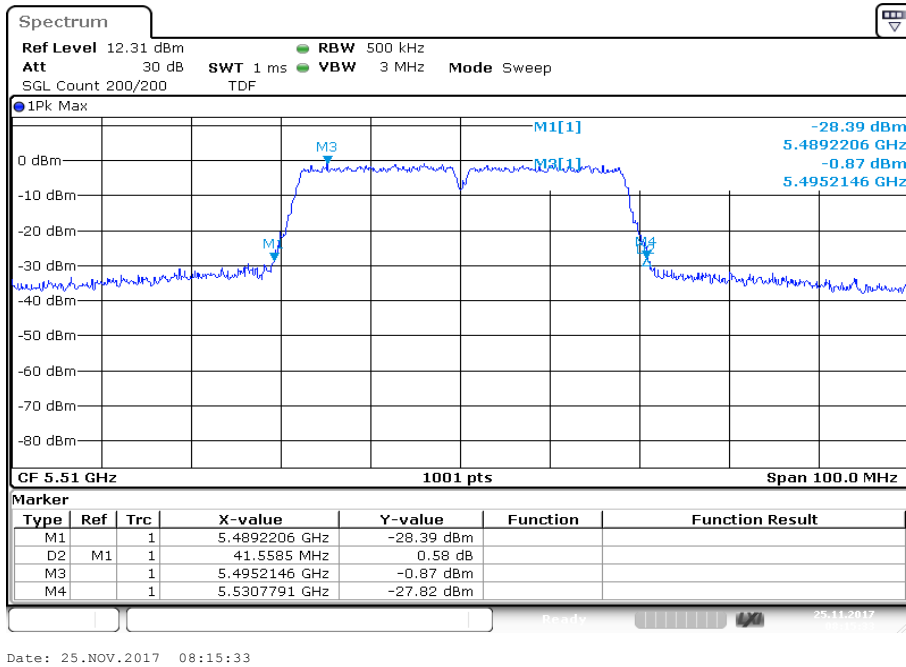

**Plot 6:** U-NII-2C; middle channel

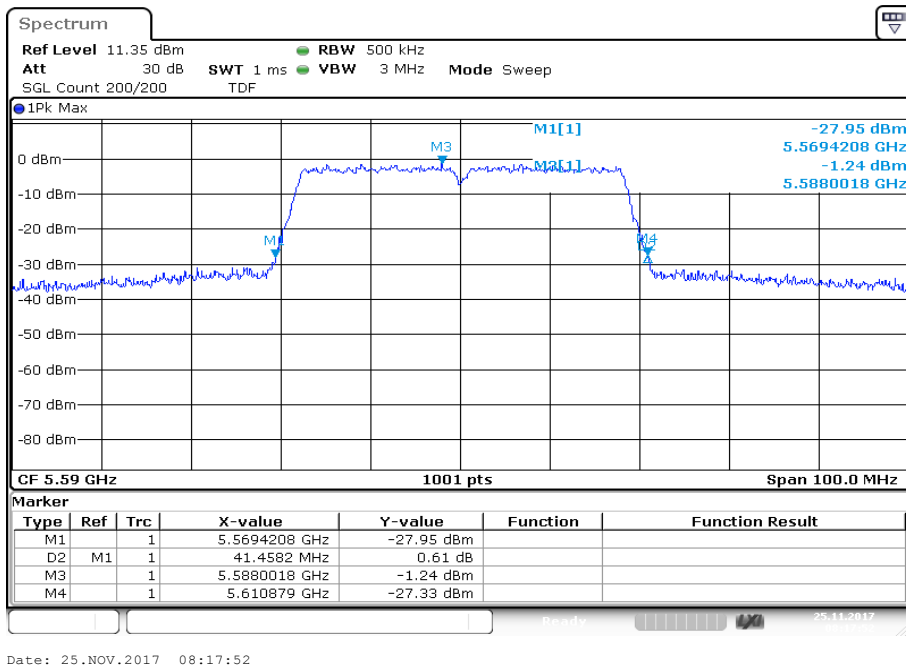



**Plot 7:** U-NII-2C; highest channel

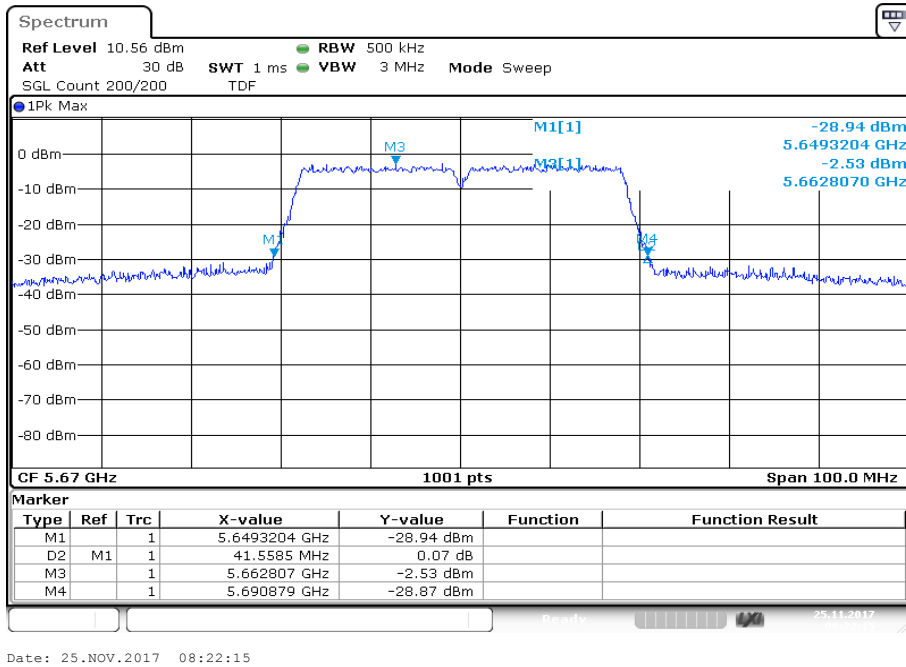

**Plot 8:** U-NII-3; lowest channel

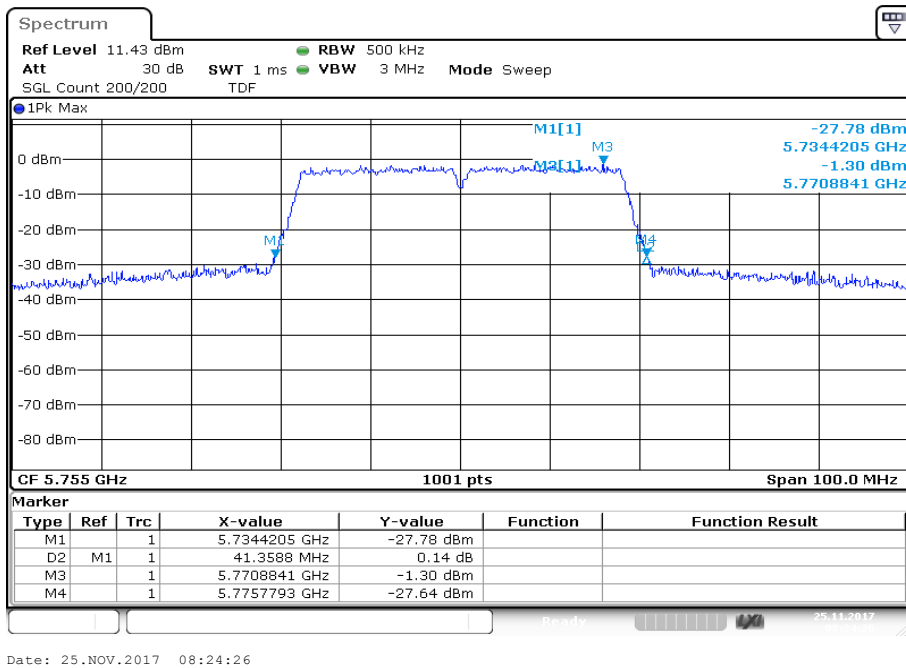

**Plot 9:** U-NII-3; highest channel

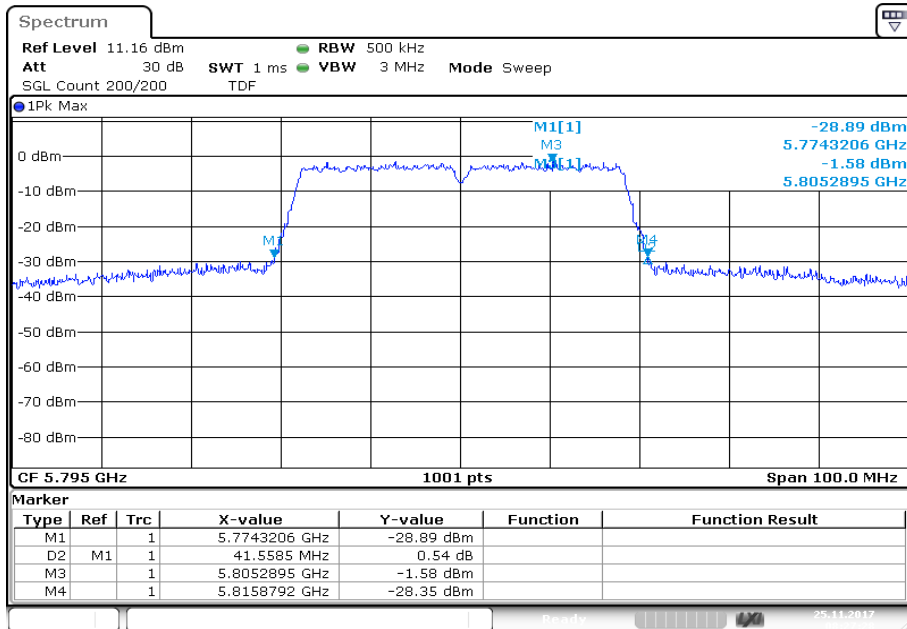

Date: 25.NOV.2017 08:27:28