



TEST REPORT

Test report no.: 1-6927/18-02-02-B



Testing laboratory

CTC advanced GmbH

Untertuerkheimer Strasse 6 – 10
66117 Saarbruecken / Germany
Phone: + 49 681 5 98 - 0
Fax: + 49 681 5 98 - 9075
Internet: <http://www.ctcadvanced.com>
e-mail: mail@ctcadvanced.com

Accredited Testing Laboratory:

The testing laboratory (area of testing) is accredited according to DIN EN ISO/IEC 17025 (2005) by the Deutsche Akkreditierungsstelle GmbH (DAkkS). The accreditation is valid for the scope of testing procedures as stated in the accreditation certificate with the registration number: D-PL-12076-01-03

Applicant

Ingenico Group

9 Avenue de la Gare Rovaltain
26958 Valence Cedex 9 / FRANCE
Phone: -/-
Contact: Nicolas Jacquemont
e-mail: nicolas.jacquemont@ingenico.com
Phone: +33475842123

Manufacturer

Ingenico Group

28-32, boulevard de Grenelle
75015 Paris / FRANCE

Test standard/s

| | |
|----------------------------|---|
| FCC - Title 47 CFR Part 15 | FCC - Title 47 of the Code of Federal Regulations; Chapter I; Part 15 - Radio frequency devices |
| RSS - 247 Issue 2 | Digital Transmission Systems (DTSs), Frequency Hopping Systems (FHSs) and Licence - Exempt Local Area Network (LE-LAN) Devices |
| RSS - Gen Issue 5 | Spectrum Management and Telecommunications Radio Standards Specification - General Requirements for Compliance of Radio Apparatus |

For further applied test standards please refer to section 3 of this test report.

Test Item

| | |
|---------------------------|--------------------------------------|
| Kind of test item: | Axium Docking Station |
| Model name: | Axium Dock |
| FCC ID: | XKB-AXIDOCKBT |
| IC: | 2586D-AXIDOCKBT |
| Frequency: | DTS band 2400 MHz to 2483.5 MHz |
| Technology tested: | Bluetooth® LE |
| Antenna: | Integrated antenna |
| Power supply: | 115 V AC by mains adapter WM32W-080I |
| Temperature range: | -10°C to +50°C |



This test report is electronically signed and valid without handwritten signature. For verification of the electronic signatures, the public keys can be requested at the testing laboratory.

Test report authorized:

p.o.

Marco Bertolino
Lab Manager
Radio Communications & EMC

Test performed:

Mihail Dorongovskij
Lab Manager
Radio Communications & EMC

1 Table of contents

| | | |
|---------|---|----|
| 1 | Table of contents | 2 |
| 2 | General information | 3 |
| 2.1 | Notes and disclaimer | 3 |
| 2.2 | Application details..... | 3 |
| 2.3 | Test laboratories sub-contracted | 3 |
| 3 | Test standard/s and references | 4 |
| 4 | Test environment..... | 5 |
| 5 | Test item..... | 5 |
| 5.1 | General description..... | 5 |
| 5.2 | Additional information | 5 |
| 6 | Sequence of testing | 6 |
| 6.1 | Sequence of testing radiated spurious 9 kHz to 30 MHz..... | 6 |
| 6.2 | Sequence of testing radiated spurious 30 MHz to 1 GHz..... | 7 |
| 6.3 | Sequence of testing radiated spurious 1 GHz to 18 GHz..... | 8 |
| 6.4 | Sequence of testing radiated spurious above 18 GHz | 9 |
| 7 | Description of the test setup..... | 10 |
| 7.1 | Shielded semi anechoic chamber..... | 11 |
| 7.2 | Shielded fully anechoic chamber | 12 |
| 7.3 | Radiated measurements > 18 GHz..... | 13 |
| 7.4 | Conducted measurements | 14 |
| 7.5 | AC conducted | 15 |
| 8 | Measurement uncertainty | 16 |
| 9 | Summary of measurement results | 17 |
| 10 | Additional comments..... | 18 |
| 11 | Measurement results | 19 |
| 11.1 | System gain..... | 19 |
| 11.2 | Power spectral density..... | 20 |
| 11.3 | DTS bandwidth – 6 dB bandwidth | 24 |
| 11.4 | Occupied bandwidth – 99% emission bandwidth..... | 28 |
| 11.5 | Maximum output power..... | 32 |
| 11.6 | Detailed spurious emissions @ the band edge - conducted | 36 |
| 11.7 | Band edge compliance radiated..... | 39 |
| 11.8 | TX spurious emissions conducted | 42 |
| 11.9 | Spurious emissions radiated below 30 MHz..... | 47 |
| 11.10 | Spurious emissions radiated 30 MHz to 1 GHz..... | 52 |
| 11.11 | Spurious emissions radiated above 1 GHz..... | 60 |
| 11.12 | Spurious emissions conducted below 30 MHz (AC conducted)..... | 69 |
| Annex A | Glossary..... | 72 |
| Annex B | Document history | 73 |
| Annex C | Accreditation Certificate – D-PL-12076-01-04 | 73 |
| Annex D | Accreditation Certificate – D-PL-12076-01-05 | 74 |

2 General information

2.1 Notes and disclaimer

The test results of this test report relate exclusively to the test item specified in this test report. CTC advanced GmbH does not assume responsibility for any conclusions and generalizations drawn from the test results with regard to other specimens or samples of the type of the equipment represented by the test item.

The test report may only be reproduced or published in full. Reproduction or publication of extracts from the report requires the prior written approval of CTC advanced GmbH.

The testing service provided by CTC advanced GmbH has been rendered under the current "General Terms and Conditions for CTC advanced GmbH".

CTC advanced GmbH will not be liable for any loss or damage resulting from false, inaccurate, inappropriate or incomplete product information provided by the customer.

Under no circumstances does the CTC advanced GmbH test report include any endorsement or warranty regarding the functionality, quality or performance of any other product or service provided.

Under no circumstances does the CTC advanced GmbH test report include or imply any product or service warranties from CTC advanced GmbH, including, without limitation, any implied warranties of merchantability, fitness for purpose, or non-infringement, all of which are expressly disclaimed by CTC advanced GmbH.

All rights and remedies regarding vendor's products and services for which CTC advanced GmbH has prepared this test report shall be provided by the party offering such products or services and not by CTC advanced GmbH. In no case this test report can be considered as a Letter of Approval.

This test report is electronically signed and valid without handwritten signature. For verification of the electronic signatures, the public keys can be requested at the testing laboratory.

This test report replaces the test report with the number 1-6927/18-02-02-A and dated 2019-03-13.

2.2 Application details

| | |
|------------------------------------|------------|
| Date of receipt of order: | 2018-09-06 |
| Date of receipt of test item: | 2018-12-03 |
| Start of test: | 2018-12-03 |
| End of test: | 2018-12-06 |
| Person(s) present during the test: | -/- |

2.3 Test laboratories sub-contracted

None

3 Test standard/s and references

| Test standard | Date | Description |
|----------------------------|---------------|--|
| FCC - Title 47 CFR Part 15 | -/- | FCC - Title 47 of the Code of Federal Regulations; Chapter I; Part 15 - Radio frequency devices |
| RSS - 247 Issue 2 | February 2017 | Digital Transmission Systems (DTSs), Frequency Hopping Systems (FHSs) and Licence - Exempt Local Area Network (LE-LAN) Devices |
| RSS - Gen Issue 5 | April 2018 | Spectrum Management and Telecommunications Radio Standards Specification - General Requirements for Compliance of Radio Apparatus |

| Guidance | Version | Description |
|---------------------|---------|--|
| DTS: KDB 558074 D01 | v05 | GUIDANCE FOR COMPLIANCE MEASUREMENTS ON DIGITAL TRANSMISSION SYSTEM, FREQUENCY HOPPING SPREAD SPECTRUM SYSTEM, AND HYBRID SYSTEM DEVICES OPERATING UNDER SECTION 15.247 OF THE FCC RULES |
| ANSI C63.4-2014 | -/- | American national standard for methods of measurement of radio-noise emissions from low-voltage electrical and electronic equipment in the range of 9 kHz to 40 GHz |
| ANSI C63.10-2013 | -/- | American national standard of procedures for compliance testing of unlicensed wireless devices |

4 Test environment

| | | | |
|---------------------------|---|-------------------------------------|--|
| Temperature | : | T_{nom} T_{max} T_{min} | +22 °C during room temperature tests No tests under extreme environmental conditions required. No tests under extreme environmental conditions required. |
| Relative humidity content | : | | 55 % |
| Barometric pressure | : | | 1021 hpa |
| Power supply | : | V_{nom} V_{max} V_{min} | 115 V AC by mains adapter WM32W-080I No tests under extreme environmental conditions required. No tests under extreme environmental conditions required. |

5 Test item

5.1 General description

| | | |
|----------------------------|---|---|
| Kind of test item | : | Axium Docking Station |
| Type identification | : | Axium Dock |
| HMN | : | -/- |
| PMN | : | Axium Dock |
| HVIN | : | AXIUM DOCK /BT |
| FVIN | : | -/- |
| S/N serial number | : | Rad. 182677314261111003191816 Cond. 182677314261111003191820 |
| Hardware status | : | 296235962 |
| Software status | : | BTPRINTER 000220 |
| Firmware status | : | -/- |
| Frequency band | : | DTS band 2400 MHz to 2483.5 MHz |
| Type of radio transmission | : | DSSS |
| Use of frequency spectrum | : | |
| Type of modulation | : | GFSK |
| Number of channels | : | 40 |
| Antenna | : | Integrated antenna |
| Power supply | : | 115 V AC by mains adapter WM32W-080I |
| Temperature range | : | -10°C to +50°C |

5.2 Additional information

The content of the following annexes is defined in the QA. It may be that not all of the listed annexes are necessary for this report, thus some values in between may be missing.

Test setup and EUT photos are included in test report:

- 1-6927/18-02-01_AnnexA
- 1-6927/18-02-01_AnnexB
- 1-6927/18-02-01_AnnexD

6 Sequence of testing

6.1 Sequence of testing radiated spurious 9 kHz to 30 MHz

Setup

- The equipment is set up to simulate normal operation mode as described in the user manual or defined by the manufacturer.
- If the EUT is a tabletop system, it is placed on a table with 0.8 m height.
- If the EUT is a floor standing device, it is placed directly on the turn table.
- Auxiliary equipment and cables are positioned to simulate normal operation conditions as described in ANSI C 63.4.
- The AC power port of the EUT (if available) is connected to a power outlet below the turntable.
- Measurement distance is 3 m (see ANSI C 63.4) – see test details.
- EUT is set into operation.

Premeasurement*

- The turntable rotates from 0° to 315° using 45° steps.
- The antenna height is 1 m.
- At each turntable position the analyzer sweeps with positive-peak detector to find the maximum of all emissions.

Final measurement

- Identified emissions during the pre-measurement are maximized by the software by rotating the turntable from 0° to 360°.
- Loop antenna is rotated about its vertical axis for maximum response at each azimuth about the EUT. (For certain applications, the loop antenna plane may also need to be positioned horizontally at the specified distance from the EUT)
- The final measurement is done in the position (turntable and elevation) causing the highest emissions with quasi-peak (as described in ANSI C 63.4).
- Final levels, frequency, measuring time, bandwidth, turntable position, correction factor, margin to the limit and limit will be recorded. A plot with the graph of the premeasurement and the limit is stored.

*)Note: The sequence will be repeated three times with different EUT orientations.

6.2 Sequence of testing radiated spurious 30 MHz to 1 GHz

Setup

- The equipment is set up to simulate normal operation mode as described in the user manual or defined by the manufacturer.
- If the EUT is a tabletop system, a table with 0.8 m height is used, which is placed on the ground plane.
- If the EUT is a floor standing device, it is placed on the ground plane with insulation between both.
- Auxiliary equipment and cables are positioned to simulate normal operation conditions as described in ANSI C 63.4.
- The AC power port of the EUT (if available) is connected to a power outlet below the turntable.
- Measurement distance is 10 m or 3 m (see ANSI C 63.4) – see test details.
- EUT is set into operation.

Premeasurement

- The turntable rotates from 0° to 315° using 45° steps.
- The antenna is polarized vertical and horizontal.
- The antenna height changes from 1 m to 3 m.
- At each turntable position, antenna polarization and height the analyzer sweeps three times in peak to find the maximum of all emissions.

Final measurement

- The final measurement is performed for at least six highest peaks according to the requirements of the ANSI C63.4.
- Based on antenna and turntable positions at which the peak values are measured the software maximize the peaks by changing turntable position $\pm 45^\circ$ and antenna height between 1 and 4 m.
- The final measurement is done with quasi-peak detector (as described in ANSI C 63.4).
- Final levels, frequency, measuring time, bandwidth, antenna height, antenna polarization, turntable angle, correction factor, margin to the limit and limit are recorded. A plot with the graph of the premeasurement with marked maximum final results and the limit is stored.

6.3 Sequence of testing radiated spurious 1 GHz to 18 GHz

Setup

- The equipment is set up to simulate normal operation mode as described in the user manual or defined by the manufacturer.
- If the EUT is a tabletop system, a 2-axis positioner with 1.5 m height is used.
- If the EUT is a floor standing device, it is placed directly on the turn table.
- Auxiliary equipment and cables are positioned to simulate normal operation conditions as described in ANSI C 63.4.
- The AC power port of the EUT (if available) is connected to a power outlet below the turntable.
- Measurement distance is 3 m (see ANSI C 63.4) – see test details.
- EUT is set into operation.

Premeasurement

- The turntable rotates from 0° to 315° using 45° steps.
- The antenna is polarized vertical and horizontal.
- The antenna height is 1.5 m.
- At each turntable position and antenna polarization the analyzer sweeps with positive peak detector to find the maximum of all emissions.

Final measurement

- The final measurement is performed for at least six highest peaks according to the requirements of the ANSI C63.4.
- Based on antenna and turntable positions at which the peak values are measured the software maximizes the peaks by rotating the turntable from 0° to 360°. This measurement is repeated for different EUT-table positions (0° to 150° in 30°-steps) and for both antenna polarizations.
- The final measurement is done in the position (turntable, EUT-table and antenna polarization) causing the highest emissions with Peak and RMS detector (as described in ANSI C 63.4).
- Final levels, frequency, measuring time, bandwidth, turntable position, EUT-table position, antenna polarization, correction factor, margin to the limit and limit are recorded. A plot with the graph of the premeasurement with marked maximum final results and the limit is stored.

6.4 Sequence of testing radiated spurious above 18 GHz

Setup

- The equipment is set up to simulate normal operation mode as described in the user manual or defined by the manufacturer.
- Auxiliary equipment and cables are positioned to simulate normal operation conditions as described in ANSI C 63.4.
- The AC power port of the EUT (if available) is connected to a power outlet.
- The measurement distance is as appropriate (e.g. 0.5 m).
- The EUT is set into operation.

Premeasurement

- The test antenna is handheld and moved carefully over the EUT to cover the EUT's whole sphere and different polarizations of the antenna.

Final measurement

- The final measurement is performed at the position and antenna orientation causing the highest emissions with Peak and RMS detector (as described in ANSI C 63.4).
- Final levels, frequency, measuring time, bandwidth, correction factor, margin to the limit and limit are recorded. A plot with the graph of the premeasurement and the limit is stored.

7 Description of the test setup

Typically, the calibrations of the test apparatus are commissioned to and performed by an accredited calibration laboratory. The calibration intervals are determined in accordance with the DIN EN ISO/IEC 17025. In addition to the external calibrations, the laboratory executes comparison measurements with other calibrated test systems or effective verifications. Weekly chamber inspections and range calibrations are performed. Where possible, RF generating and signaling equipment as well as measuring receivers and analyzers are connected to an external high-precision 10 MHz reference (GPS-based or rubidium frequency standard).

In order to simplify the identification of the equipment used at some special tests, some items of test equipment and ancillaries can be provided with an identifier or number in the equipment list below (Lab/Item).

Agenda: Kind of Calibration

| | | | |
|------|--|-----|--|
| k | calibration / calibrated | EK | limited calibration |
| ne | not required (k, ev, izw, zw not required) | zw | cyclical maintenance (external cyclical maintenance) |
| ev | periodic self verification | izw | internal cyclical maintenance |
| Ve | long-term stability recognized | g | blocked for accredited testing |
| v/k! | Attention: extended calibration interval | | |
| NK! | Attention: not calibrated | *) | next calibration ordered / currently in progress |

7.1 Shielded semi anechoic chamber

The radiated measurements are performed in vertical and horizontal plane in the frequency range from 30 MHz to 1 GHz in semi-anechoic chambers. The EUT is positioned on a non-conductive support with a height of 0.80 m above a conductive ground plane that covers the whole chamber. The receiving antennas are conform to specifications ANSI C63. These antennas can be moved over the height range between 1.0 m and 4.0 m in order to search for maximum field strength emitted from EUT. The measurement distances between EUT and receiving antennas are indicated in the test setups for the various frequency ranges. For each measurement, the EUT is rotated in all three axes until the maximum field strength is received. The wanted and unwanted emissions are received by spectrum analyzers where the detector modes and resolution bandwidths over various frequency ranges are set according to requirement ANSI C63.

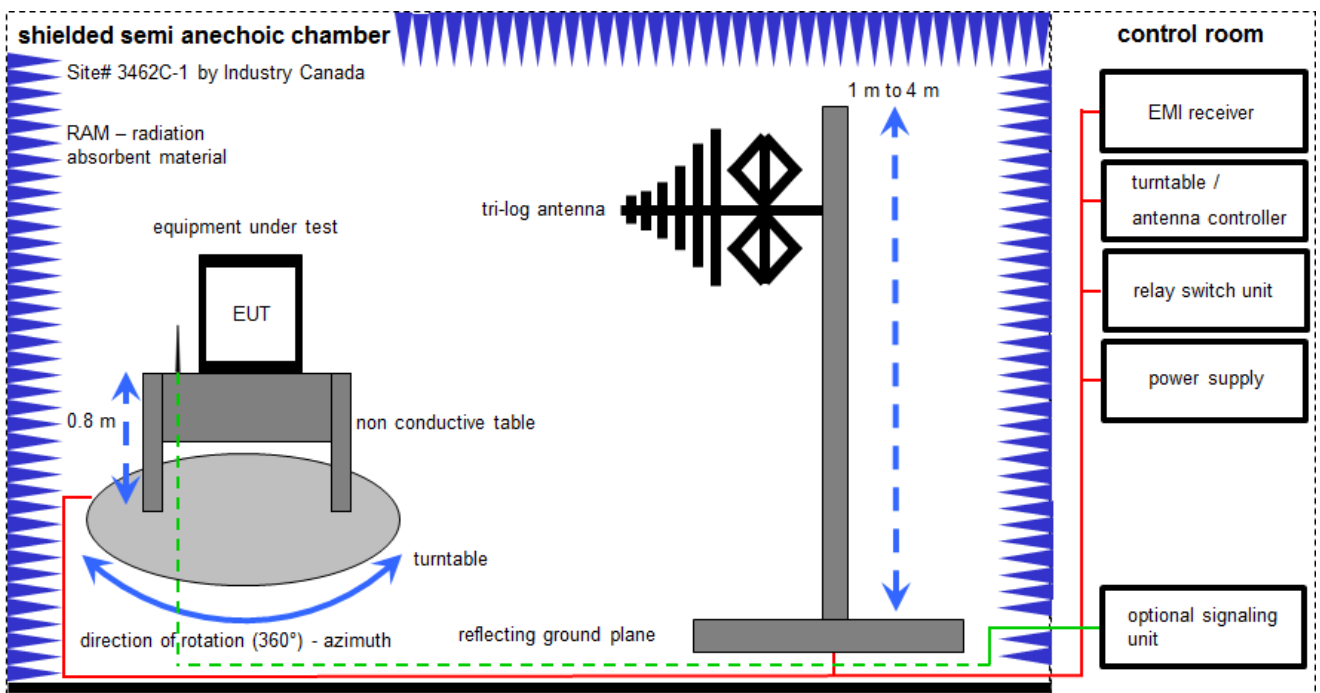

Measurement distance: tri-log antenna 10 meter
EMC32 software version: 10.30.0

FS = UR + CL + AF
(FS-field strength; UR-voltage at the receiver; CL-loss of the cable; AF-antenna factor)

Example calculation:

FS [dBµV/m] = 12.35 [dBµV/m] + 1.90 [dB] + 16.80 [dB/m] = 31.05 [dBµV/m] (35.69 µV/m)

Equipment table:

| No. | Lab / Item | Equipment | Type | Manufacturer | Serial No. | INV. No. | Kind of Calibration | Last Calibration | Next Calibration |
|-----|------------|--|------------------|-------------------------------|------------|-----------|---------------------|------------------|------------------|
| 1 | A | Switch-Unit | 3488A | HP | 2719A14505 | 300000368 | ev | -/- | -/- |
| 2 | A | Meßkabine 1 | HF-Absorberhalle | MWB AG 300023 | -/- | 300000551 | ne | -/- | -/- |
| 3 | A | EMI Test Receiver | ESCI 3 | R&S | 100083 | 300003312 | k | 15.12.2017 | 14.12.2018 |
| 4 | A | Antenna Tower | Model 2175 | ETS-Lindgren | 64762 | 300003745 | izw | -/- | -/- |
| 5 | A | Positioning Controller | Model 2090 | ETS-Lindgren | 64672 | 300003746 | izw | -/- | -/- |
| 6 | A | Turntable Interface-Box | Model 105637 | ETS-Lindgren | 44583 | 300003747 | izw | -/- | -/- |
| 7 | A | TRILOG Broadband Test-Antenna 30 MHz - 3 GHz | VULB9163 | Schwarzbeck Mess - Elektronik | 371 | 300003854 | vIK! | 24.11.2017 | 23.11.2020 |

7.2 Shielded fully anechoic chamber

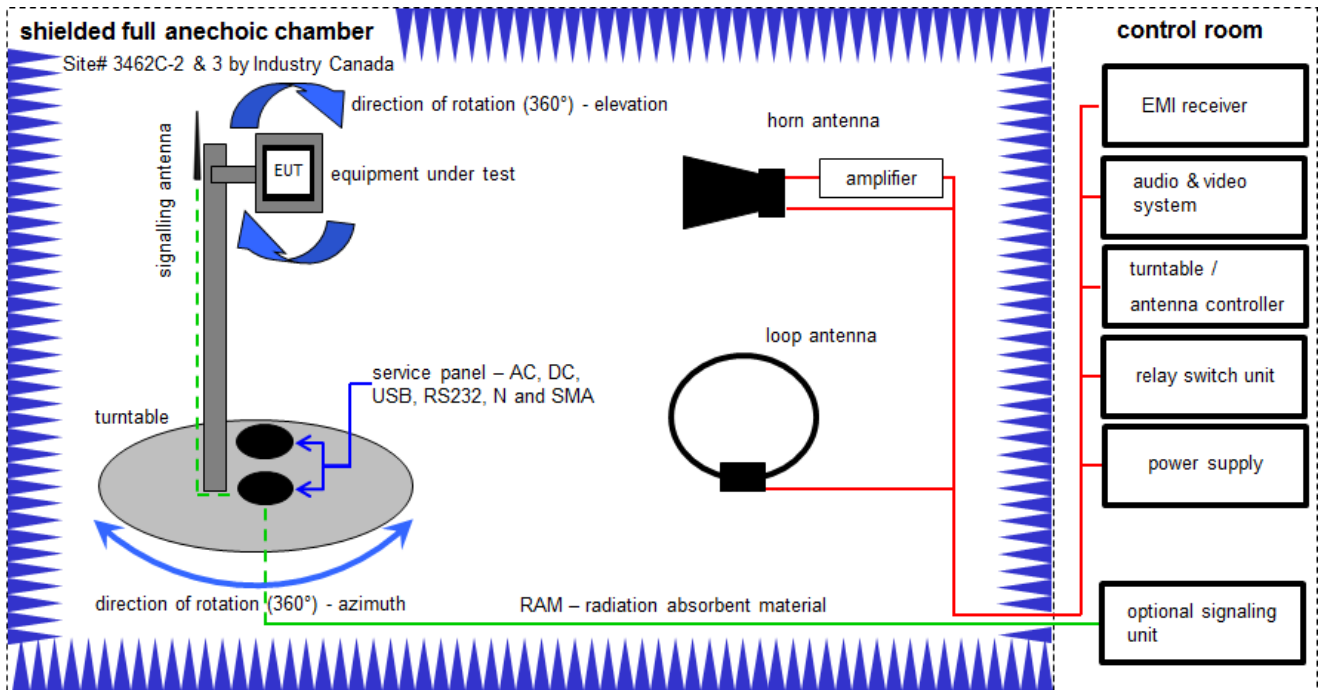

Measurement distance: horn antenna 3 meter; loop antenna 3 meter
EMC32 software version: 10.30.0

FS = UR + CA + AF
(FS-field strength; UR-voltage at the receiver; CA-loss of the signal path; AF-antenna factor)

Example calculation:

FS [dBµV/m] = 40.0 [dBµV/m] + (-35.8) [dB] + 32.9 [dB/m] = 37.1 [dBµV/m] (71.61 µV/m)

Equipment table:

| No. | Lab / Item | Equipment | Type | Manufacturer | Serial No. | INV. No. | Kind of Calibration | Last Calibration | Next Calibration |
|-----|------------|--|-------------------------------------|----------------------|------------|-----------|---------------------|------------------|------------------|
| 1 | C | Active Loop Antenna 9 kHz to 30 MHz | 6502 | EMCO | 2210 | 300001015 | k | 07.07.2017 | 06.07.2019 |
| 2 | A, B, C | Anechoic chamber | FAC 3/5m | MWB / TDK | 87400/02 | 300000996 | ev | -/- | -/- |
| 3 | A, B | Double-Ridged Waveguide Horn Antenna 1-18.0GHz | 3115 | EMCO | 9107-3697 | 300001605 | vIKII | 14.02.2017 | 13.02.2019 |
| 4 | A, B, C | Switch / Control Unit | 3488A | HP | * | 300000199 | ne | -/- | -/- |
| 5 | A | Band Reject filter | WRCG2400/2483- 2375/2505-50/10SS | Wainwright | 11 | 300003351 | ev | -/- | -/- |
| 6 | A, B, C | EMI Test Receiver 20Hz- 26,5GHz | ESU26 | R&S | 100037 | 300003555 | k | 20.12.2017 | 19.12.2018 |
| 7 | A, B | Highpass Filter | WHK1.1/15G-10SS | Wainwright | 3 | 300003255 | ev | -/- | -/- |
| 8 | A, B | Highpass Filter | WHKX7.0/18G-8SS | Wainwright | 19 | 300003790 | ne | -/- | -/- |
| 9 | A, B | Broadband Amplifier 0.5-18 GHz | CBLU5184540 | CERNEX | 22049 | 300004481 | ev | -/- | -/- |
| 10 | A, B, C | 4U RF Switch Platform | L4491A | Agilent Technologies | MY50000037 | 300004509 | ne | -/- | -/- |
| 11 | A, B, C | NEXIO EMV- Software | BAT EMC V3.16.0.49 | EMCO | -/- | 300004682 | ne | -/- | -/- |
| 12 | A, B, C | PC | ExOne | F+W | -/- | 300004703 | ne | -/- | -/- |
| 13 | A, B, C | DC power supply, 60Vdc, 50A, 1200 W | 6032A | HP | 2818A03450 | 300001040 | vIKII | 12.12.2017 | 11.12.2020 |

7.3 Radiated measurements > 18 GHz

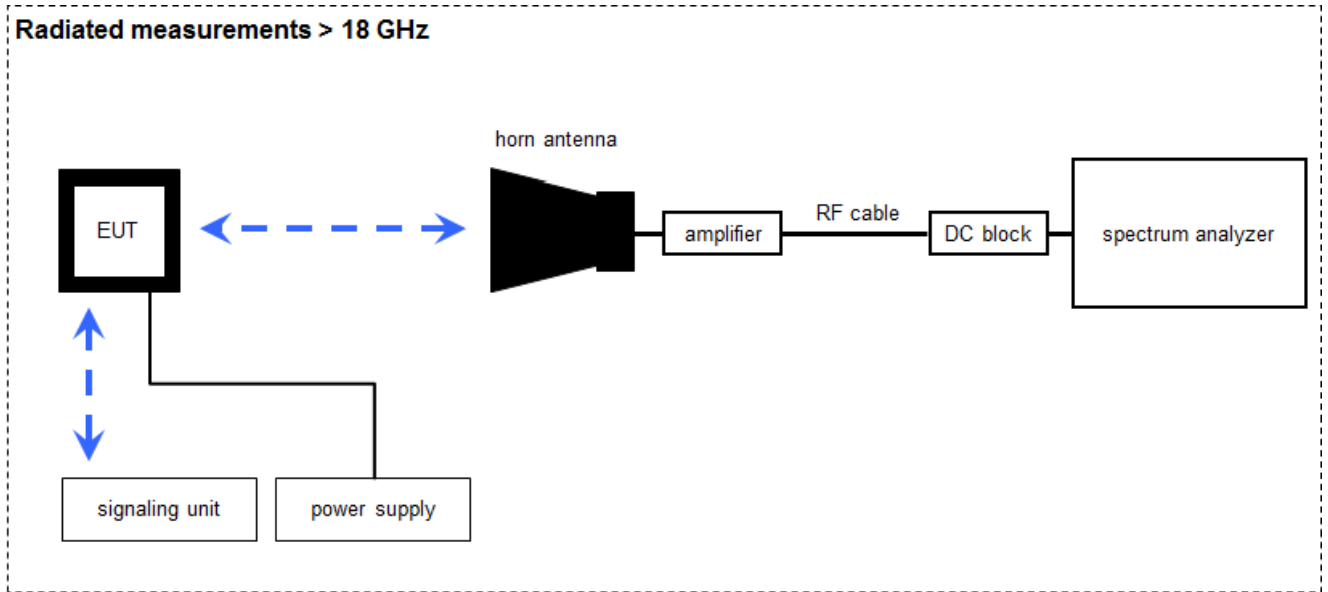

Measurement distance: horn antenna 50 cm

$$FS = UR + CA + AF$$

(FS-field strength; UR-voltage at the receiver; CA-loss signal path & distance correction; AF-antenna factor)

Example calculation:

$$FS [dB\mu V/m] = 40.0 [dB\mu V/m] + (-60.1) [dB] + 36.74 [dB/m] = 16.64 [dB\mu V/m] (6.79 \mu V/m)$$

Equipment table:

| No. | Lab / Item | Equipment | Type | Manufacturer | Serial No. | INV. No. | Kind of Calibration | Last Calibration | Next Calibration |
|-----|------------|--------------------------------------|---------------------|----------------|------------------|-----------|---------------------|------------------|------------------|
| 1 | A | Amplifier 2-40 GHz | JS32-02004000-57-5P | MITEQ | 1777200 | 300004541 | ev | -/- | -/- |
| 2 | A | RF-Cable | ST18/SMAM/SMAM/48 | Huber & Suhner | Batch no. 600918 | 400001182 | ev | -/- | -/- |
| 3 | A | RF-Cable | ST18/SMAM/SMAM/48 | Huber & Suhner | Batch no. 127377 | 400001183 | ev | -/- | -/- |
| 4 | A | DC-Blocker 0.1-40 GHz | 8141A | Inmet | -/- | 400001185 | ev | -/- | -/- |
| 5 | A | Std. Gain Horn Antenna 18.0-26.5 GHz | 638 | Narda | -/- | 300000486 | k | 13.12.2017 | 12.12.2019 |
| 6 | A | Signal Analyzer 40 GHz | FSV40 | R&S | 101042 | 300004517 | k | 16.01.2018 | 15.01.2019 |

7.4 Conducted measurements

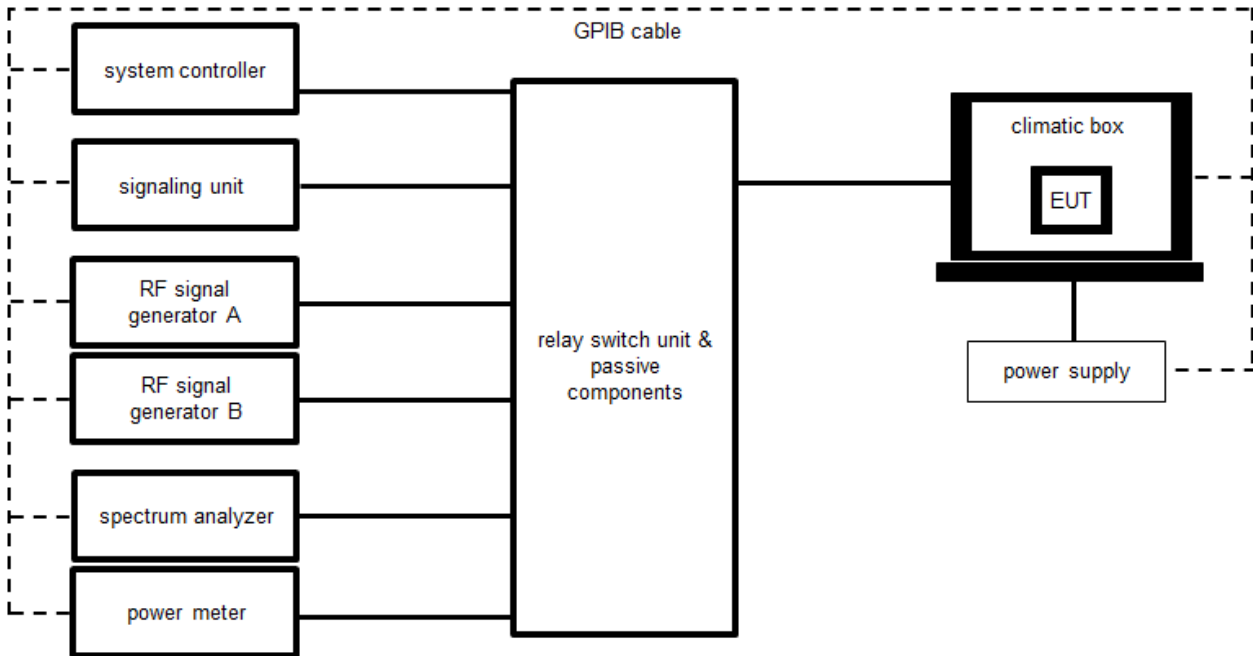

OP = AV + CA
(OP-output power; AV-analyzer value; CA-loss signal path)

Example calculation:

OP [dBm] = 6.0 [dBm] + 11.7 [dB] = 17.7 [dBm] (58.88 mW)

Equipment table:

| No. | Lab / Item | Equipment | Type | Manufacturer | Serial No. | INV. No. | Kind of Calibration | Last Calibration | Next Calibration |
|-----|------------|-----------------------|-------------------|----------------|------------------|-----------|---------------------|------------------|------------------|
| 1 | A | Switch / Control Unit | 3488A | HP | | 300000929 | ne | -/- | -/- |
| 2 | A | Directional Coupler | 101020010 | Krytar | 70215 | 300002840 | ev | -/- | -/- |
| 3 | A | DC-Blocker | 8143 | Inmet Corp. | none | 300002842 | ne | -/- | -/- |
| 4 | A | Powersplitter | 6005-3 | Inmet Corp. | | 300002841 | ev | -/- | -/- |
| 5 | A | Signal Analyzer 30GHz | FSV30 | R&S | 103170 | 300004855 | k | 30.01.2017 | 29.01.2019 |
| 6 | A | RF-Cable | ST18/SMAm/SMAm/48 | Huber & Suhner | Batch no. 699866 | 400001189 | ev | -/- | -/- |
| 7 | A | RF-Cable | ST18/SMAm/SMAm/48 | Huber & Suhner | Batch no. 14844 | 400001190 | ev | -/- | -/- |

7.5 AC conducted

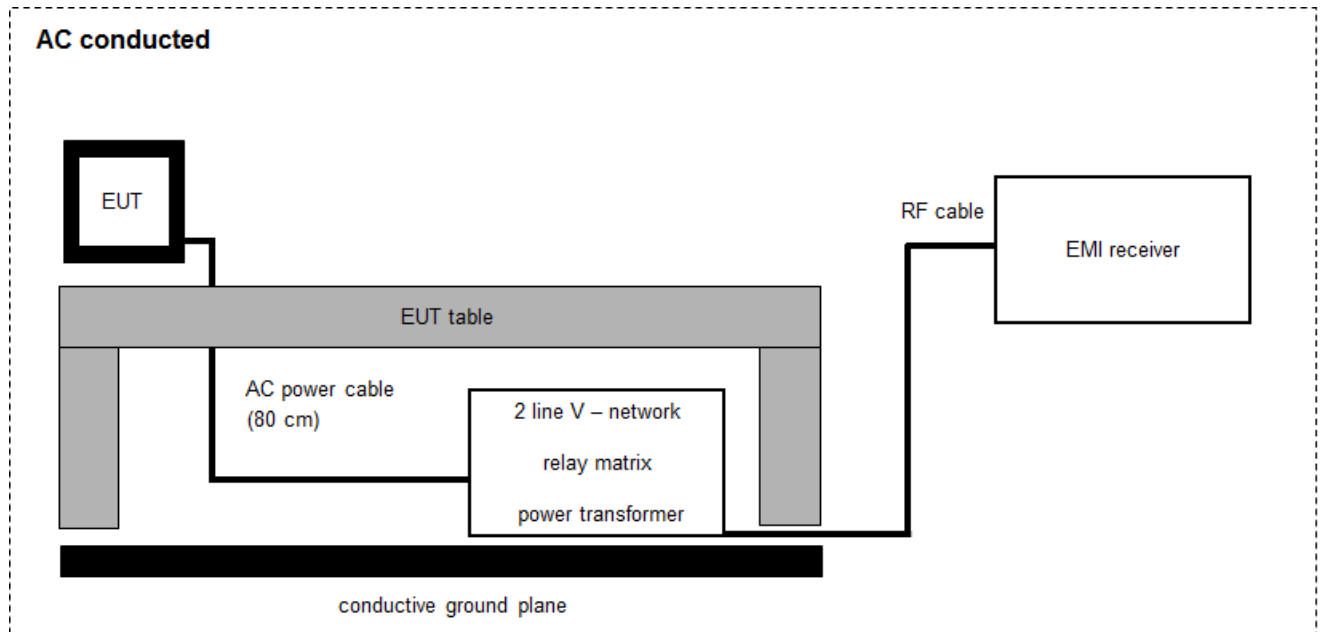

FS = UR + CF + VC

(FS-field strength; UR-voltage at the receiver; CR-loss of the cable and filter; VC-correction factor of the ISN)

Example calculation:

FS [dB μ V/m] = 37.62 [dB μ V/m] + 9.90 [dB] + 0.23 [dB] = 47.75 [dB μ V/m] (244.06 μ V/m)

Equipment table:

| No. | Lab / Item | Equipment | Type | Manufacturer | Serial No. | INV. No. | Kind of Calibration | Last Calibration | Next Calibration |
|-----|------------|---|---------|----------------------|------------|-----------|---------------------|------------------|------------------|
| 1 | A | Two-line V-Network (LISN) 9 kHz to 30 MHz | ESH3-Z5 | R&S | 892475/017 | 300002209 | vIKII | 13.12.2017 | 12.12.2019 |
| 2 | A | RF-Filter-section | 85420E | HP | 3427A00162 | 300002214 | NK! | -/- | -/- |
| 3 | A | Hochpass 150 kHz | EZ-25 | R&S | 100010 | 300003798 | ev | -/- | -/- |
| 4 | A | MXE EMI Receiver 20 Hz to 26,5 GHz | N9038A | Agilent Technologies | MY51210197 | 300004405 | k | 18.12.2017 | 17.12.2018 |
| 5 | A | Bluetooth Tester | CBT35 | R&S | 100635 | 300003907 | NK! | -/- | -/- |

8 Measurement uncertainty

| Measurement uncertainty | |
|--|--|
| Test case | Uncertainty |
| Antenna gain | ± 3 dB |
| Spectrum bandwidth | ± 21.5 kHz absolute; ± 15.0 kHz relative |
| Maximum output power | ± 1 dB |
| Detailed conducted spurious emissions @ the band edge | ± 1 dB |
| Band edge compliance radiated | ± 3 dB |
| Spurious emissions conducted | ± 3 dB |
| Spurious emissions radiated below 30 MHz | ± 3 dB |
| Spurious emissions radiated 30 MHz to 1 GHz | ± 3 dB |
| Spurious emissions radiated 1 GHz to 12.75 GHz | ± 3.7 dB |
| Spurious emissions radiated above 12.75 GHz | ± 4.5 dB |
| Spurious emissions conducted below 30 MHz (AC conducted) | ± 2.6 dB |

9 Summary of measurement results

| | |
|-------------------------------------|--|
| <input checked="" type="checkbox"/> | No deviations from the technical specifications were ascertained |
| <input type="checkbox"/> | There were deviations from the technical specifications ascertained |
| <input type="checkbox"/> | This test report is only a partial test report. The content and verdict of the performed test cases are listed below. |

| TC Identifier | Description | Verdict | Date | Remark |
|---------------|-----------------------------------|------------|------------|--------|
| RF-Testing | CFR Part 15 RSS - 247, Issue 2 | See table! | 2019-03-17 | -/- |

| Test specification clause | Test case | Guideline | Temperature conditions | Power source voltages | Mode | C | NC | NA | NP | Remark |
|--|--|---|------------------------|-----------------------|------------------|-------------------------------------|--------------------------|--------------------------|--------------------------|--------|
| §15.247(b)(4) RSS - 247 / 5.4 (4) | System gain | -/- | Nominal | Nominal | 1 Msps | <input checked="" type="checkbox"/> | <input type="checkbox"/> | <input type="checkbox"/> | <input type="checkbox"/> | -/- |
| §15.247(e) RSS - 247 / 5.2 (b) | Power spectral density | KDB 558074 DTS clause: 8.4 | Nominal | Nominal | 1 Msps 2 Msps | <input checked="" type="checkbox"/> | <input type="checkbox"/> | <input type="checkbox"/> | <input type="checkbox"/> | -/- |
| §15.247(a)(2) RSS - 247 / 5.2 (a) | DTS bandwidth – 6 dB bandwidth | KDB 558074 DTS clause: 8.2 | Nominal | Nominal | 1 Msps 2 Msps | <input checked="" type="checkbox"/> | <input type="checkbox"/> | <input type="checkbox"/> | <input type="checkbox"/> | -/- |
| RSS Gen clause 4.6.1 | Occupied bandwidth | -/- | Nominal | Nominal | 1 Msps 2 Msps | <input checked="" type="checkbox"/> | <input type="checkbox"/> | <input type="checkbox"/> | <input type="checkbox"/> | -/- |
| §15.247(b)(3) RSS - 247 / 5.4 (4) | Maximum output power | KDB 558074 DTS clause: 8.3.1.1 | Nominal | Nominal | 1 Msps 2 Msps | <input checked="" type="checkbox"/> | <input type="checkbox"/> | <input type="checkbox"/> | <input type="checkbox"/> | -/- |
| §15.247(d) RSS - 247 / 5.5 | Detailed spurious emissions @ the band edge - conducted | KDB 558074 DTS clause: 8.5 | Nominal | Nominal | 1 Msps 2 Msps | <input checked="" type="checkbox"/> | <input type="checkbox"/> | <input type="checkbox"/> | <input type="checkbox"/> | -/- |
| §15.205 RSS - 247 / 5.5 RSS - Gen | Band edge compliance radiated | KDB 558074 DTS clause: 8.7.2 or 8.7.3 | Nominal | Nominal | 1 Msps 2 Msps | <input checked="" type="checkbox"/> | <input type="checkbox"/> | <input type="checkbox"/> | <input type="checkbox"/> | -/- |
| §15.247(d) RSS - 247 / 5.5 | TX spurious emissions conducted | KDB 558074 DTS clause: 8.5 | Nominal | Nominal | 1 Msps 2 Msps | <input checked="" type="checkbox"/> | <input type="checkbox"/> | <input type="checkbox"/> | <input type="checkbox"/> | -/- |
| §15.209(a) RSS - Gen | Spurious emissions radiated below 30 MHz | -/- | Nominal | Nominal | 1 Msps 2 Msps | <input checked="" type="checkbox"/> | <input type="checkbox"/> | <input type="checkbox"/> | <input type="checkbox"/> | -/- |
| 15.247(d) RSS - 247 / 5.5 §15.109 RSS - Gen | Spurious emissions radiated 30 MHz to 1 GHz | -/- | Nominal | Nominal | 1 Msps 2 Msps | <input checked="" type="checkbox"/> | <input type="checkbox"/> | <input type="checkbox"/> | <input type="checkbox"/> | -/- |
| §15.247(d) RSS - 247 / 5.5 §15.109 RSS - Gen | Spurious emissions radiated above 1 GHz | -/- | Nominal | Nominal | 1 Msps 2 Msps | <input checked="" type="checkbox"/> | <input type="checkbox"/> | <input type="checkbox"/> | <input type="checkbox"/> | -/- |
| §15.107(a) §15.207 | Conducted emissions below 30 MHz (AC conducted) | -/- | Nominal | Nominal | 1 Msps | <input checked="" type="checkbox"/> | <input type="checkbox"/> | <input type="checkbox"/> | <input type="checkbox"/> | -/- |

Note: C = Compliant; NC = Not compliant; NA = Not applicable; NP = Not performed

10 Additional comments

The Bluetooth® word mark and logos are owned by the Bluetooth SIG Inc. and any use of such marks by CTC advanced GmbH is under license.

Reference documents: ICO-OPE-05146_Axium_Dock_Printer_BLE_DTM_agreement_procedure.pdf
Test report no. 1-6173_18-02-03-A

Special test descriptions: The radiated tests between 1 GHz and 18 GHz were performed with a permanent connection between the USB interface and the notebook. Please see the document 1-6927/18-02-01_AnnexD for photo documentation of the test setup.

Configuration descriptions:

| Bluetooth Low Energy | |
|---|----------------|
| Longest Supported payload (37 – 255 Byte) | Tx: 37, RX: 37 |
| LE 1M PHY supported | Yes |
| LE 2M PHY supported | Yes |
| Stable Modulation Index supported (SMI) | No |
| LE Coded PHY supported (S=2) | No |
| LE Coded PHY supported (S=8) | No |

- Test mode:
- Bluetooth LE Test mode enabled (EUT is controlled over CMW)
 - Special software is used.
EUT is transmitting pseudo random data by itself
- Antennas and transmit operating modes:
- Operating mode 1 (single antenna)
 - Equipment with 1 antenna,
 - Equipment with 2 diversity antennas operating in switched diversity mode by which at any moment in time only 1 antenna is used,
 - Smart antenna system with 2 or more transmit/receive chains, but operating in a mode where only 1 transmit/receive chain is used)
 - Operating mode 2 (multiple antennas, no beamforming)
 - Equipment operating in this mode contains a smart antenna system using two or more transmit/receive chains simultaneously but without beamforming.
 - Operating mode 3 (multiple antennas, with beamforming)
 - Equipment operating in this mode contains a smart antenna system using two or more transmit/receive chains simultaneously with beamforming.
In addition to the antenna assembly gain (G), the beamforming gain (Y) may have to be taken into account when performing the measurements.

11 Measurement results

11.1 System gain

Limits:

| FCC | IC |
|---|----|
| 6 dBi / > 6 dBi output power and power density reduction required | |

Results: Extracted from test report no. 1-6173_18-02-03-A

| | 2402 MHz | 2440 MHz | 2480 MHz |
|--------------------------|----------|----------|----------|
| Gain [dBi] Calculated | 3.1 | 3.1 | 3.1 |

11.2 Power spectral density

Description:

Measurement of the power spectral density of a digital modulated system.

| Measurement parameters | |
|-------------------------|----------------------|
| Detector | Peak |
| Sweep time | Auto |
| Resolution bandwidth | 3 kHz |
| Video bandwidth | 10 kHz |
| Span | ≥ EBW |
| Trace mode | Max hold |
| Test setup | See sub clause 7.4 A |
| Measurement uncertainty | See sub clause 8 |

Limits:

| FCC | IC |
|--|----|
| Power spectral density | |
| For digitally modulated systems the transmitter power spectral density conducted from the transmitter to the antenna shall not be greater than 8 dBm in any 3 kHz band during any time interval of continuous transmission or over 1.0 second if the transmission exceeds 1.0-second duration. | |

Results:

| | Frequency | | |
|---|-----------|----------|----------|
| | 2402 MHz | 2440 MHz | 2480 MHz |
| Power spectral density [dBm / 3kHz] 1 Msps | -18.2 | -19.0 | -18.4 |
| Power spectral density [dBm / 3kHz] 2 Msps | -20.6 | -21.6 | -20.7 |

Plots:

Plot 1: lowest channel, 1 Msps

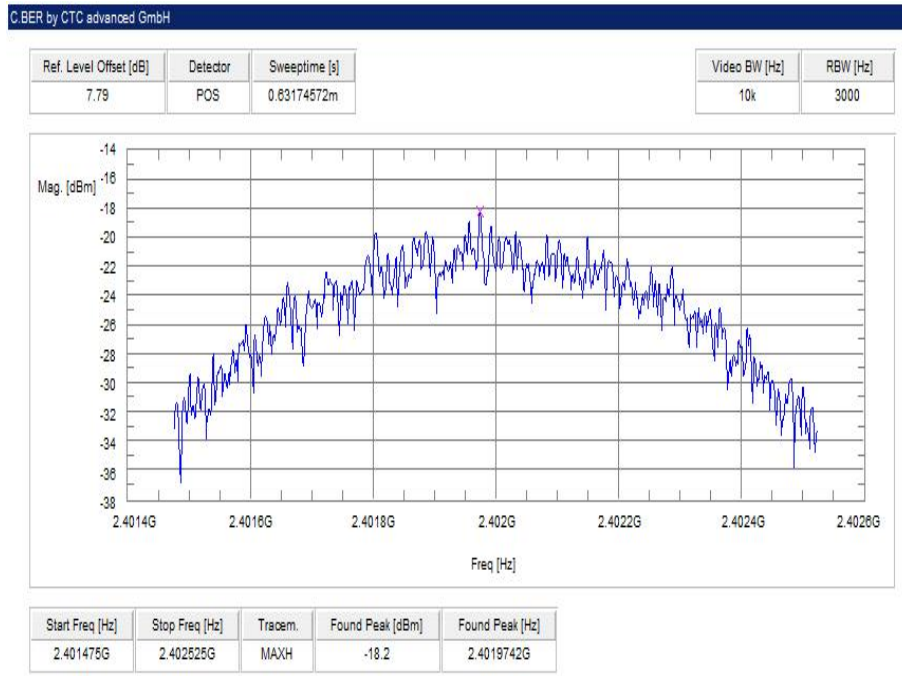

Plot 2: mid channel, 1 Msps

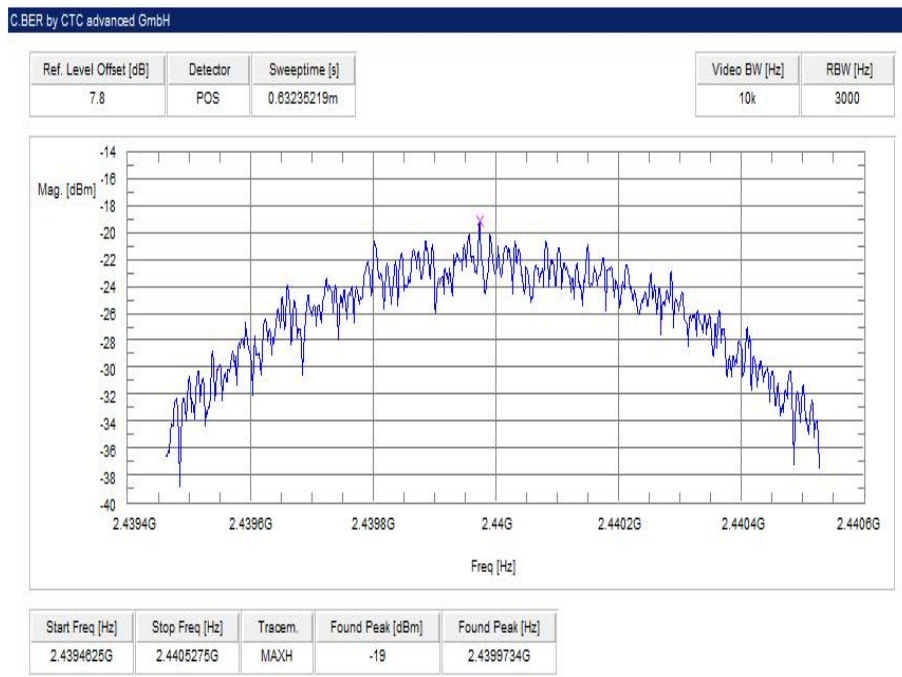

Plot 3: highest channel, 1 Msp

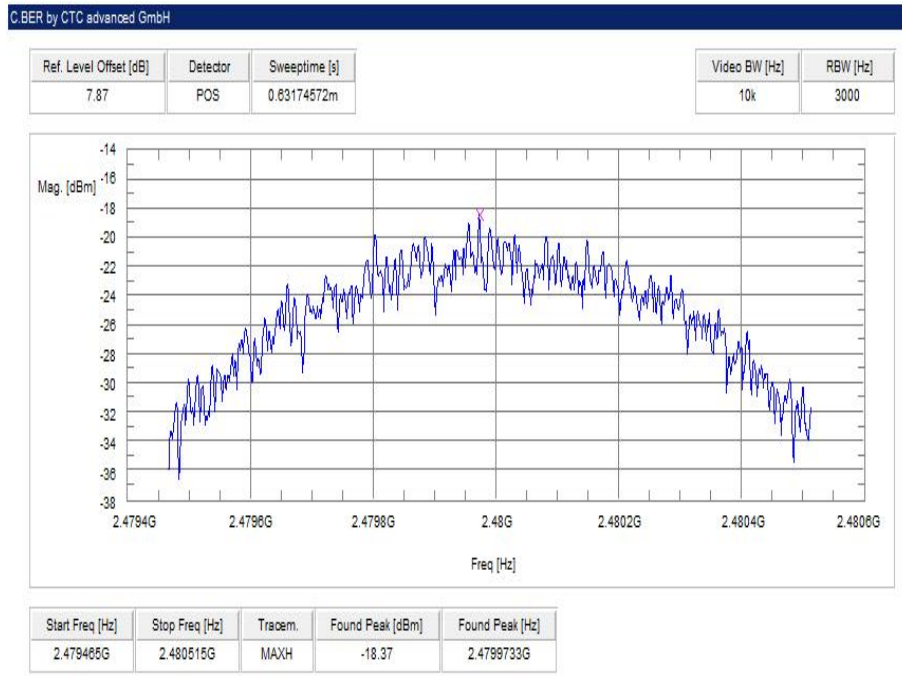

Plot 4: lowest channel, 2 Msp

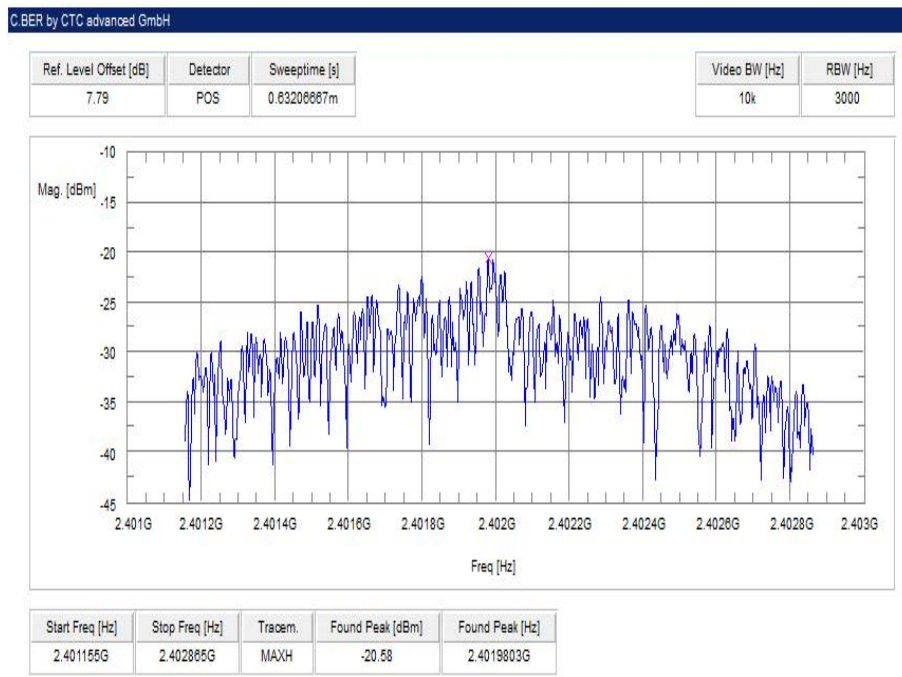

Plot 5: mid channel, 2 Msps

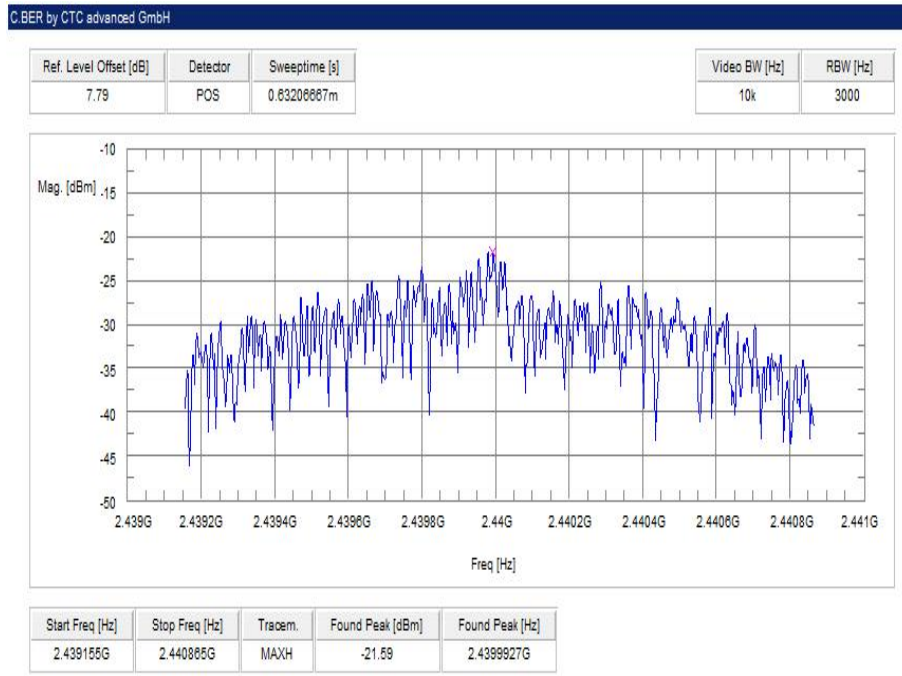

Plot 6: highest channel, 2 Msps

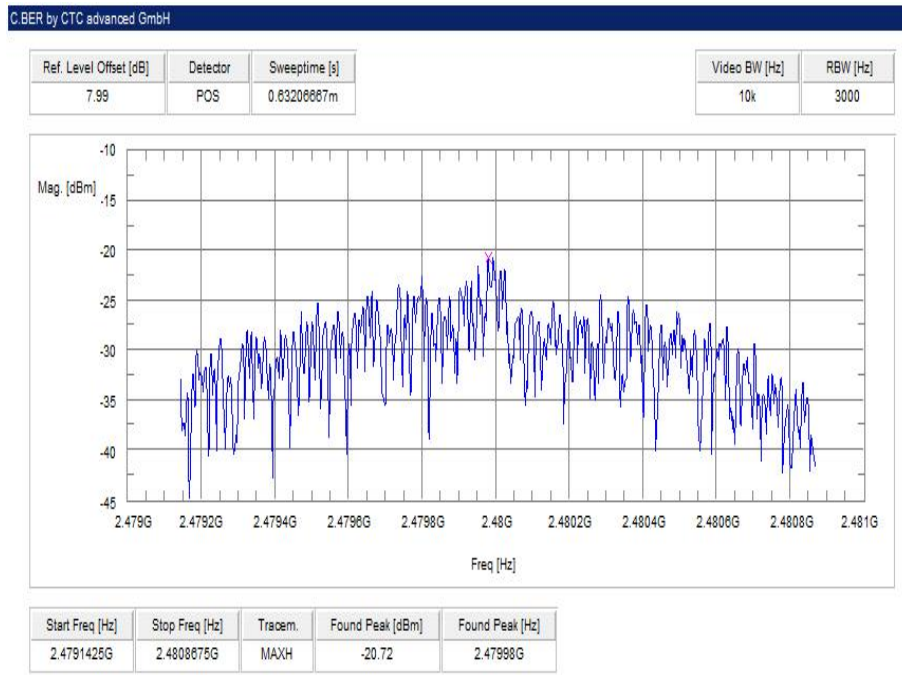

11.3 DTS bandwidth – 6 dB bandwidth

Description:

Measurement of the 6 dB bandwidth of the modulated signal.

| Measurement parameters | |
|-------------------------|-------------------------------------|
| Detector | Peak |
| Sweep time | Auto |
| Resolution bandwidth | 100 kHz |
| Video bandwidth | 300 kHz |
| Span | 5 MHz |
| Measurement procedure | Using 3 marker (max + 2x-6dB) |
| Trace mode | Max hold (allow trace to stabilize) |
| Test setup | See sub clause 7.4 A |
| Measurement uncertainty | See sub clause 8 |

Limits:

| FCC | IC |
|---|----|
| DTS bandwidth – 6 dB bandwidth | |
| Systems using digital modulation techniques may operate in the 2400–2483.5 MHz band. The minimum 6 dB bandwidth shall be at least 500 kHz. | |

Results:

| | Frequency | | |
|--|-----------|----------|----------|
| | 2402 MHz | 2440 MHz | 2480 MHz |
| 6 dB bandwidth [kHz] 1 Msps | 700 | 710 | 700 |
| 6 dB bandwidth [kHz] 2 Msps | 1140 | 1140 | 1150 |

Plots:

Plot 1: lowest channel, 1 Msp



Plot 2: mid channel, 1 Msp



Plot 3: highest channel, 1 Msp



Plot 4: lowest channel, 2 Msp

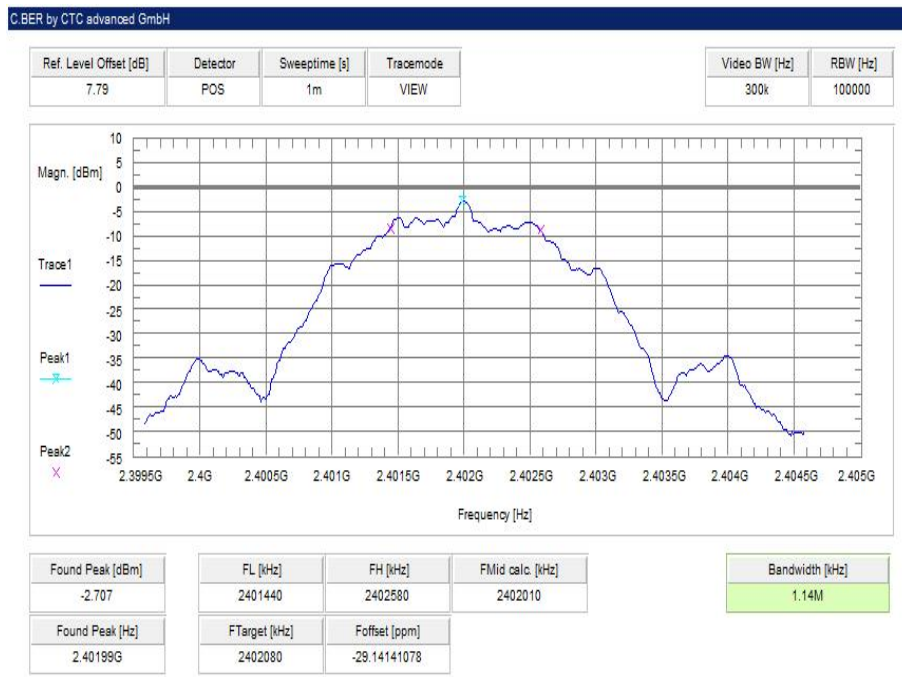

Plot 5: mid channel, 2 Msp

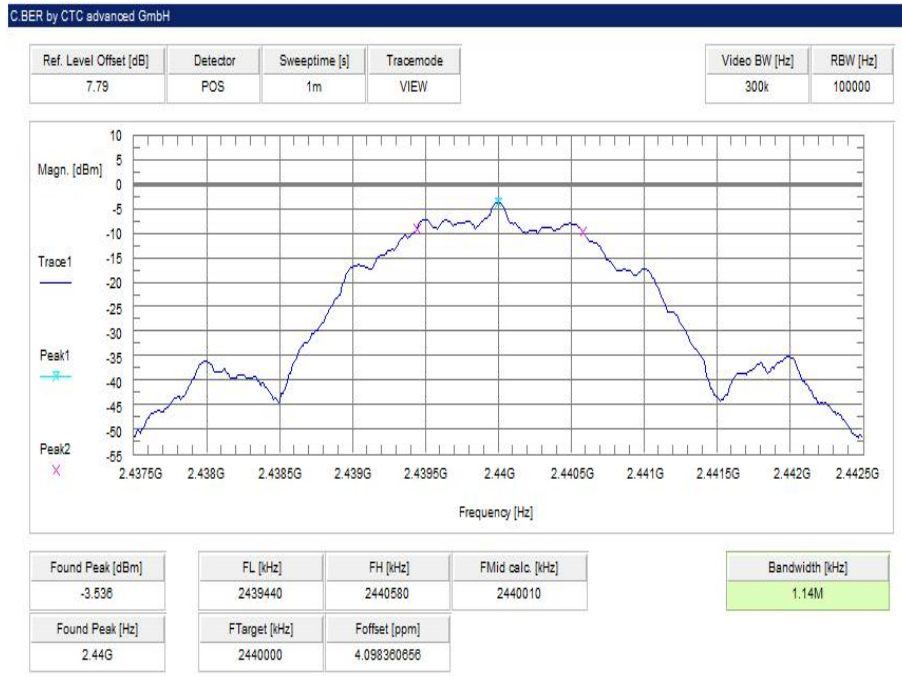

Plot 6: highest channel, 2 Msp



11.4 Occupied bandwidth – 99% emission bandwidth

Description:

Measurement of the 99% bandwidth of the modulated signal acc. RSS-GEN.

| Measurement parameters | |
|-------------------------|---|
| Detector | Peak |
| Sweep time | Auto |
| Resolution bandwidth | 30 kHz |
| Video bandwidth | 100 kHz |
| Span | 5 MHz |
| Measurement procedure | Measurement of the 99% bandwidth using the integration function of the analyzer |
| Trace mode | Max hold (allow trace to stabilize) |
| Test setup | See sub clause 7.4 A |
| Measurement uncertainty | See sub clause 8 |

Usage:

| -/- | IC |
|---|----|
| Occupied bandwidth – 99% emission bandwidth | |
| OBW is necessary for emission designator | |

Results:

| | Frequency | | |
|---------------------------------------|-----------|----------|----------|
| | 2402 MHz | 2440 MHz | 2480 MHz |
| 99% bandwidth [kHz] 1 Msps | 1057 | 1057 | 1057 |
| 99% bandwidth [kHz] 2 Msps | 2035 | 2035 | 2035 |

Plots:

Plot 1: lowest channel, 1 Msps

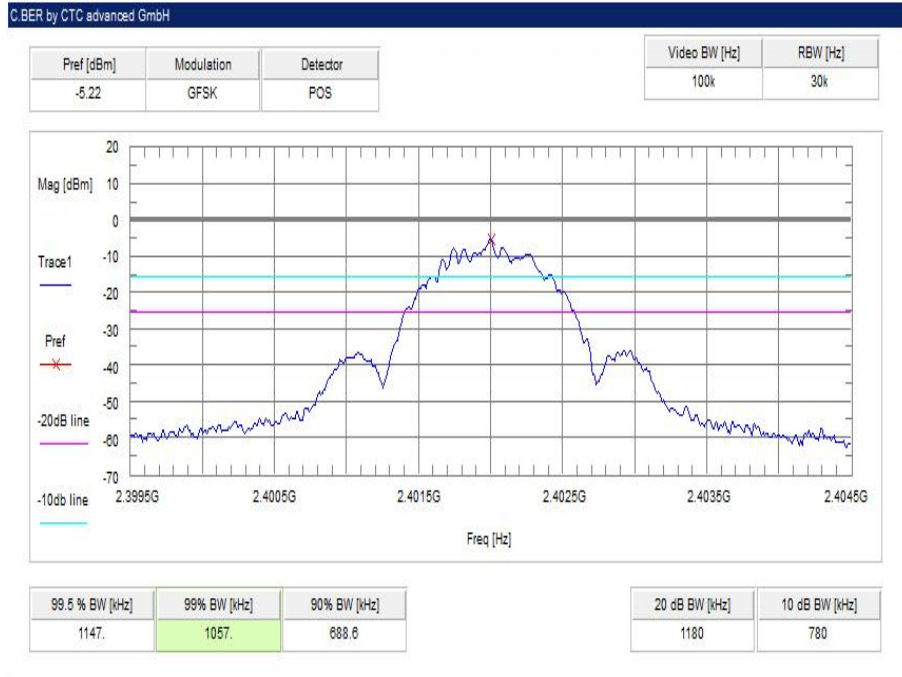

Plot 2: mid channel, 1 Msps

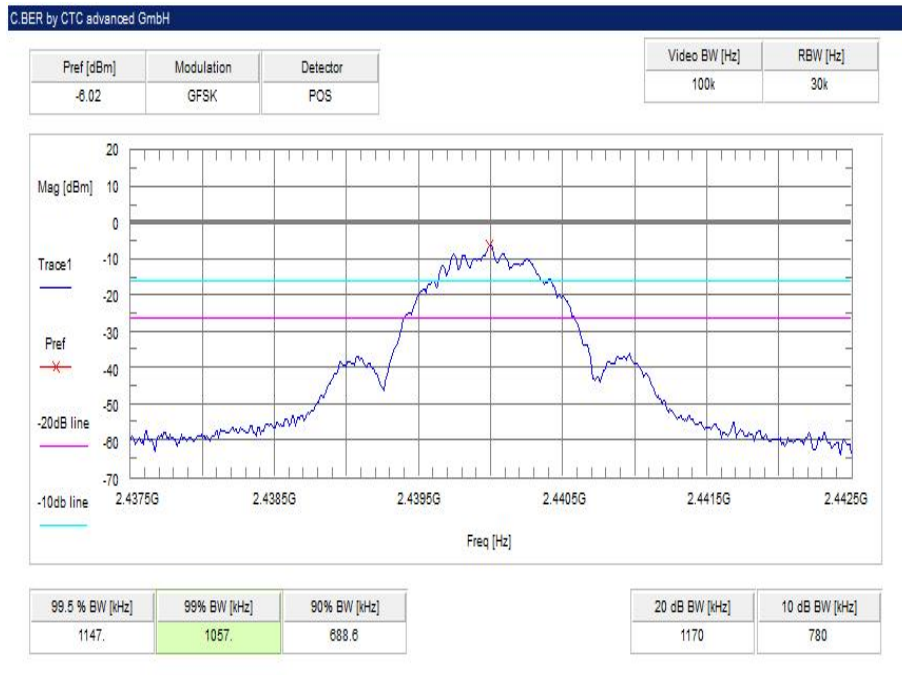

Plot 3: highest channel, 1 Msp

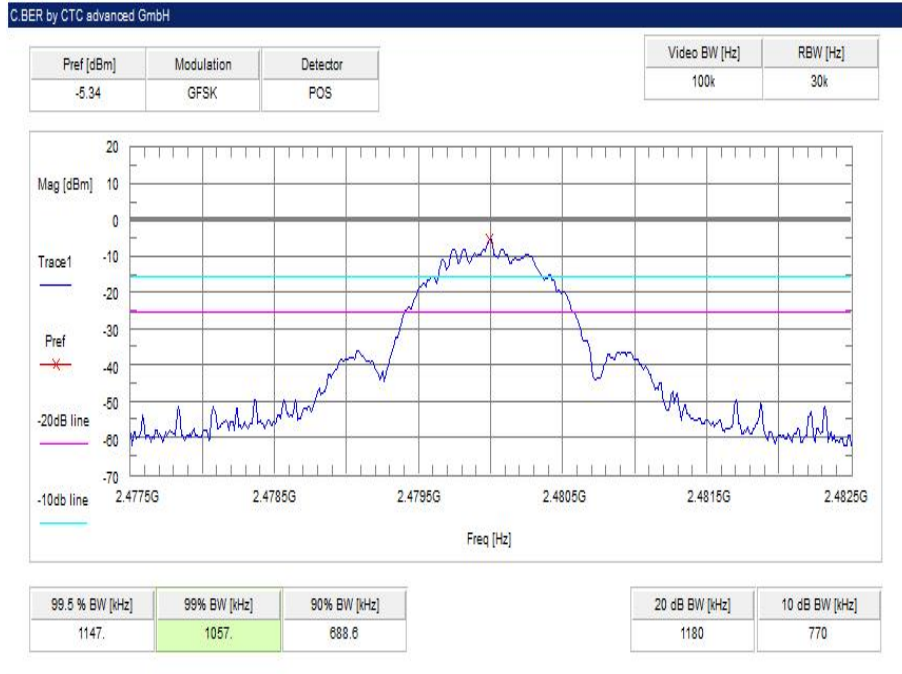

Plot 4: lowest channel, 2 Msp

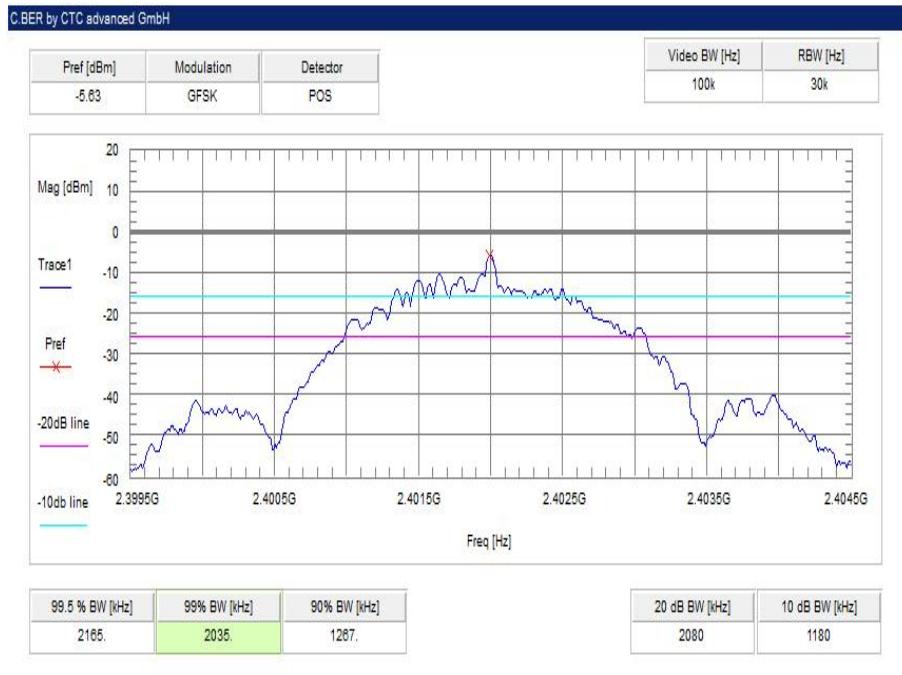

Plot 5: mid channel, 2 Msps



Plot 6: highest channel, 2 Msps



11.5 Maximum output power

Description:

Measurement of the maximum output power conducted and radiated. EUT in single channel mode.

| Measurement parameters | |
|-------------------------|----------------------|
| Detector | Peak |
| Sweep time | Auto |
| Resolution bandwidth | 3 MHz |
| Video bandwidth | 10 MHz |
| Span | 10 MHz |
| Trace mode | Max hold |
| Test setup | See sub clause 7.4 A |
| Measurement uncertainty | See sub clause 8 |

Limits:

| FCC | IC |
|--|----|
| Maximum output power | |
| Conducted: 1.0 W – antenna gain max. 6 dBi | |

Results:

| | Frequency | | |
|--|-----------|----------|----------|
| | 2402 MHz | 2440 MHz | 2480 MHz |
| Maximum output power conducted [dBm] 1 Msps | -2.6 | -3.4 | -2.6 |
| Maximum output power conducted [dBm] 2 Msps | -2.5 | -3.4 | -2.5 |

Plots:

Plot 1: lowest channel, 1 Msps

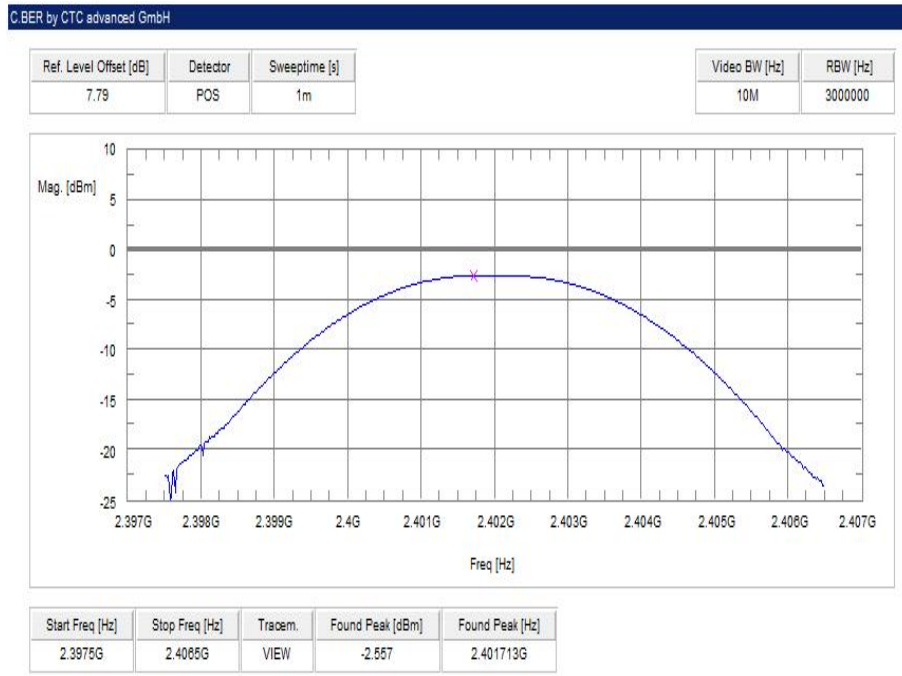

Plot 2: mid channel, 1 Msps

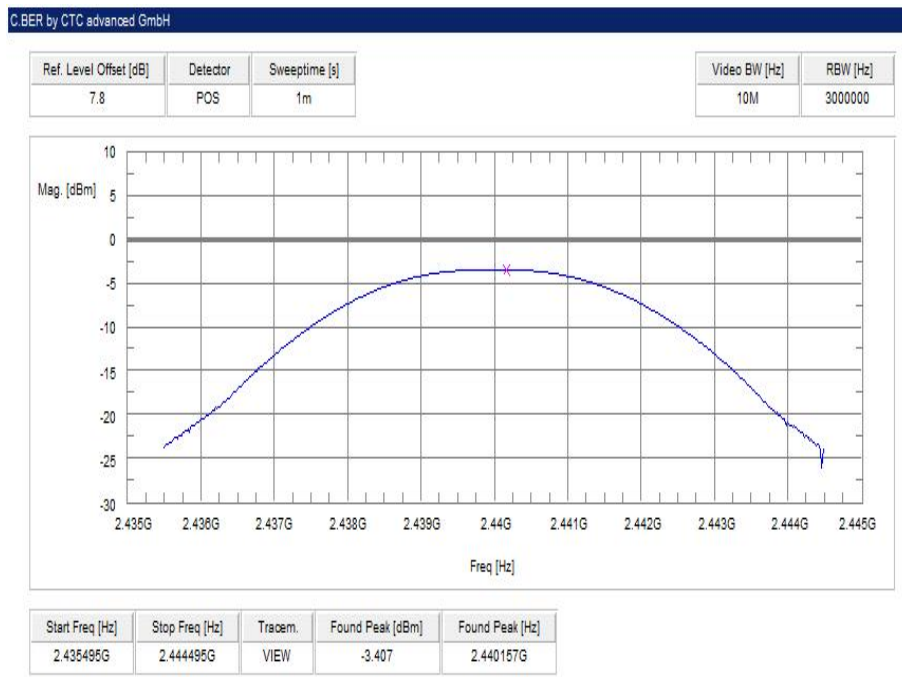

Plot 3: highest channel, 1 Msp

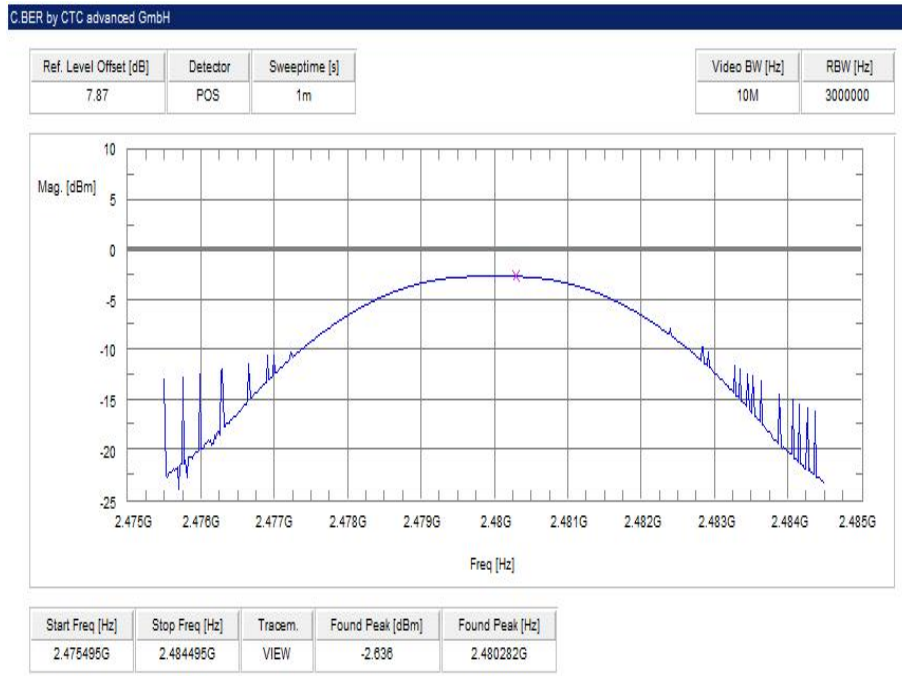

Plot 4: lowest channel, 2 Msp



Plot 5: mid channel, 2 Msps

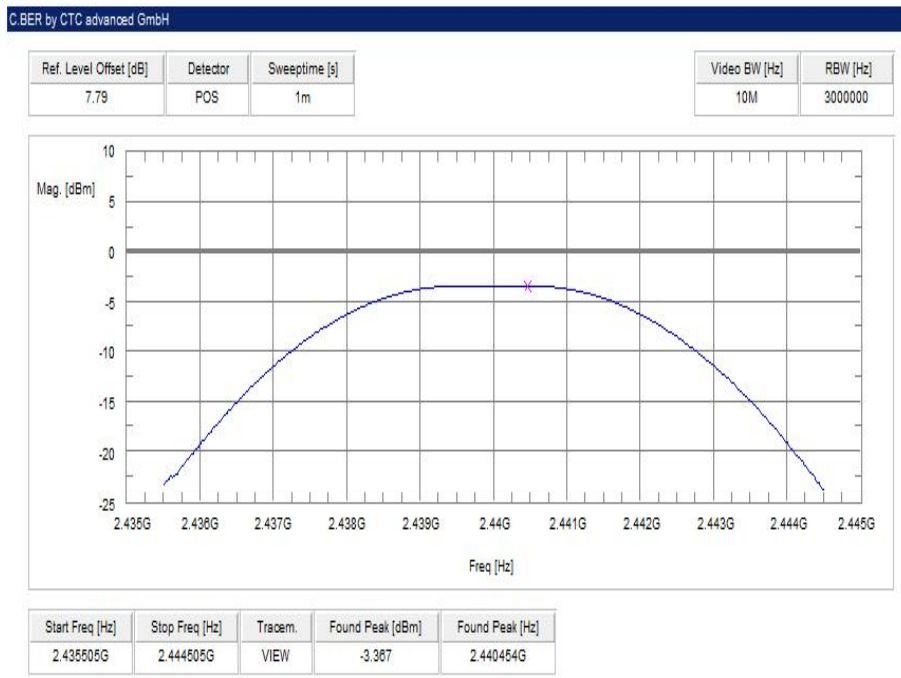

Plot 6: highest channel, 2 Msps



11.6 Detailed spurious emissions @ the band edge - conducted

Description:

Measurement of the conducted band edge compliance. EUT is measured at the lower and upper band edge in single channel.

| Measurement parameters | |
|-------------------------|---|
| Detector | Peak |
| Sweep time | Auto |
| Resolution bandwidth | 100 kHz |
| Video bandwidth | 300 kHz / 500 kHz |
| Span | Lower Band Edge: 2395 – 2405 MHz higher Band Edge: 2478 – 2489 MHz |
| Trace mode | Max hold |
| Test setup | See sub clause 7.4 A |
| Measurement uncertainty | See sub clause 8 |

Limits:

| FCC | IC |
|--|----|
| <p>In any 100 kHz bandwidth outside the frequency band in which the spread spectrum or digitally modulated intentional radiator is operating, the radio frequency power that is produced by the intentional radiator shall be at least 20 dB below that in the 100 kHz bandwidth within the band that contains the highest level of the desired power, based on either an RF conducted or a radiated measurement. Attenuation below the general limits specified in Section 15.209(a) is not required.</p> | |

Result:

| Scenario | Spurious band edge conducted [dB] |
|-----------------|-----------------------------------|
| Data rate | 1 Msps |
| Lower band edge | > 20 dB |
| Upper band edge | > 20 dB |
| Data rate | 2 Msps |
| Lower band edge | > 20 dB |
| Upper band edge | > 20 dB |

Plots:

Plot 1: Lower band edge, 1 Msp



Plot 2: Upper band edge, 1 Msp

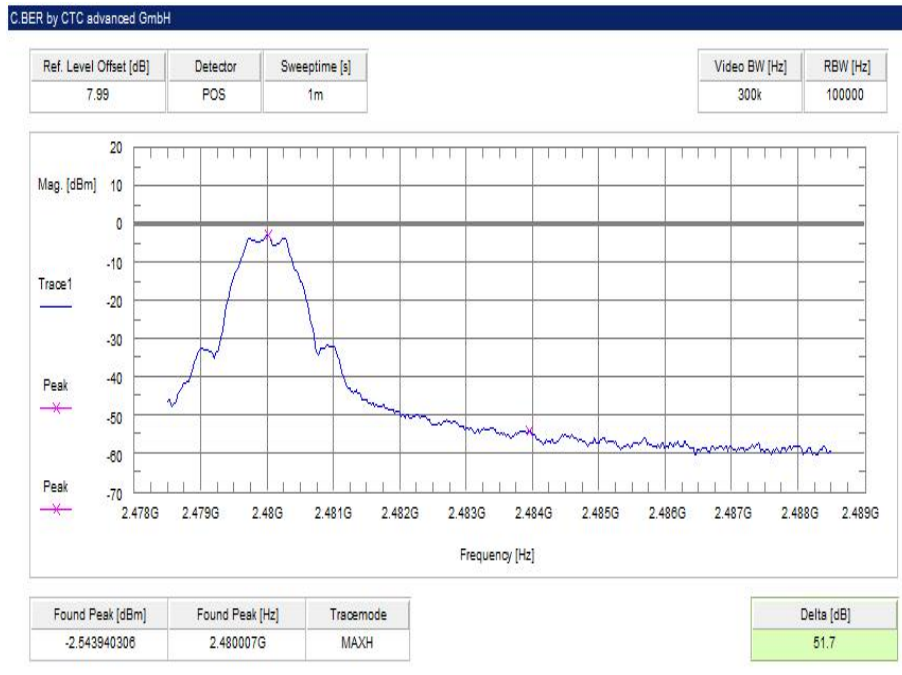

Plot 3: Lower band edge, 2 Msp



Plot 4: Upper band edge, 2 Msp

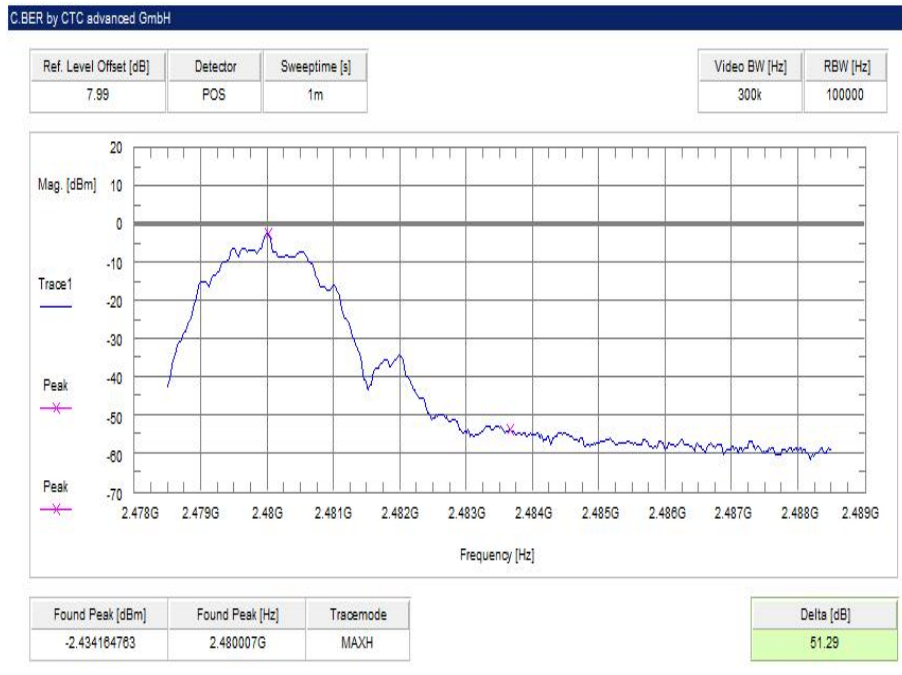

11.7 Band edge compliance radiated

Description:

Measurement of the radiated band edge compliance. The EUT is turned in the position that results in the maximum level at the band edge. Then a sweep over the corresponding restricted band is performed. The EUT is set to single channel mode and the transmit frequency 2402 MHz for the lower restricted band and 2480 MHz for the upper restricted band. Measurement distance is 3m.

| Measurement parameters | |
|-------------------------|---|
| Detector | Peak / RMS |
| Sweep time | Auto |
| Resolution bandwidth | 1 MHz |
| Video bandwidth | 3 MHz |
| Span | Lower Band: 2300 – 2400 MHz higher Band: 2480 – 2500 MHz |
| Trace mode | Max hold |
| Test setup | See sub clause 7.2 B |
| Measurement uncertainty | See sub clause 8 |

Limits:

| FCC | IC |
|---|----|
| Band edge compliance radiated | |
| <p>In any 100 kHz bandwidth outside the frequency band in which the spread spectrum or digitally modulated intentional radiator is operating, the radio frequency power that is produced by the intentional radiator shall be at least 20 dB below that in the 100 kHz bandwidth within the band that contains the highest level of the desired power, based on either an RF conducted or a radiated measurement. Attenuation below the general limits specified in Section 15.209(a) is not required. In addition, radiated emissions which fall in the restricted bands, as defined in Section 15.205(a), must also comply with the radiated emission limits specified in Section 15.209(a) (see Section 5.205(c)).</p> | |
| 54 dB μ V/m AVG 74 dB μ V/m Peak | |

Result:

| Scenario | Band edge compliance radiated [dB μ V/m] |
|-----------------------|--|
| Data rate | 1 Msps |
| Lower restricted band | < 54 AVG / < 74 PP |
| Upper restricted band | < 54 AVG / < 74 PP |
| Data rate | 2 Msps |
| Lower restricted band | < 54 AVG / < 74 PP |
| Upper restricted band | < 54 AVG / < 74 PP |

Plots:

Plot 1: Lower restricted band, 1 Msps

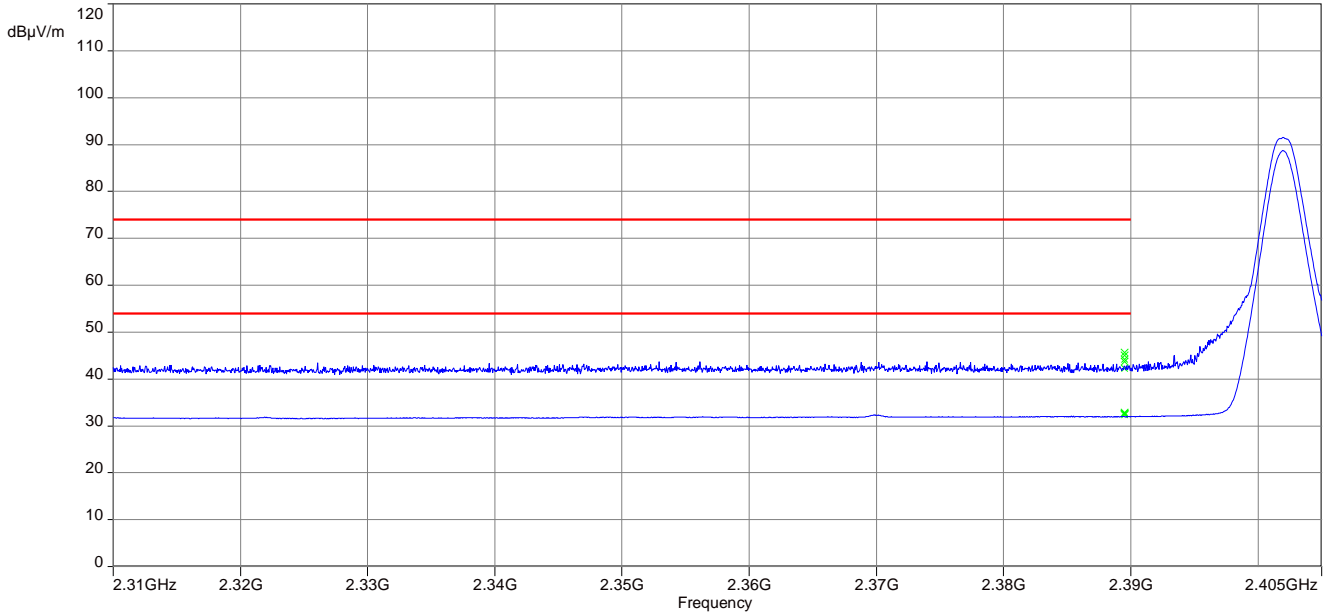

Plot 2: Upper restricted band, 1 Msps

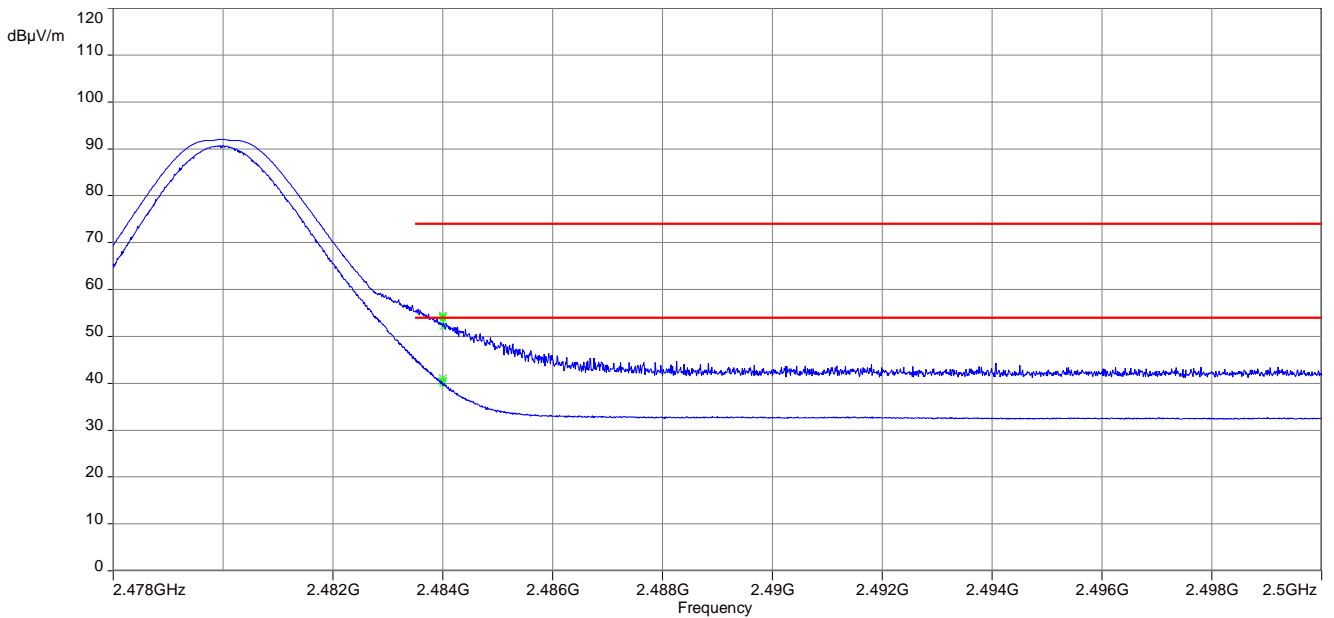

Plot 3: Lower restricted band, 2 Msps

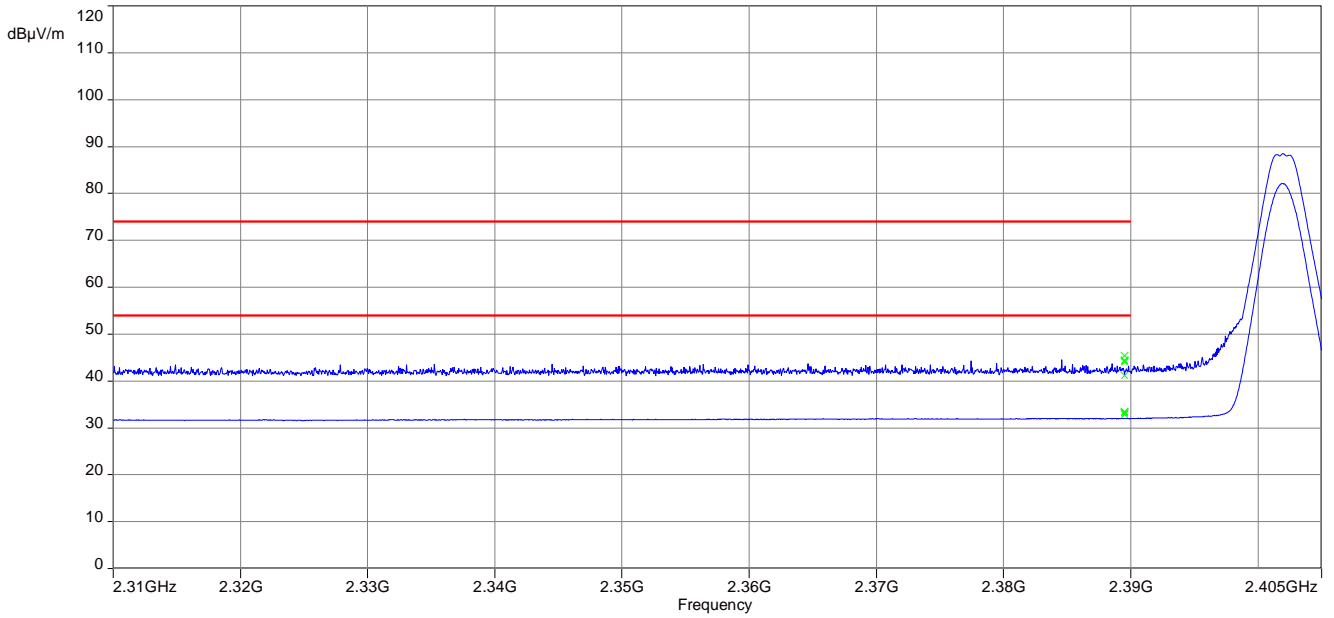

Plot 4: Upper restricted band, 2 Msps

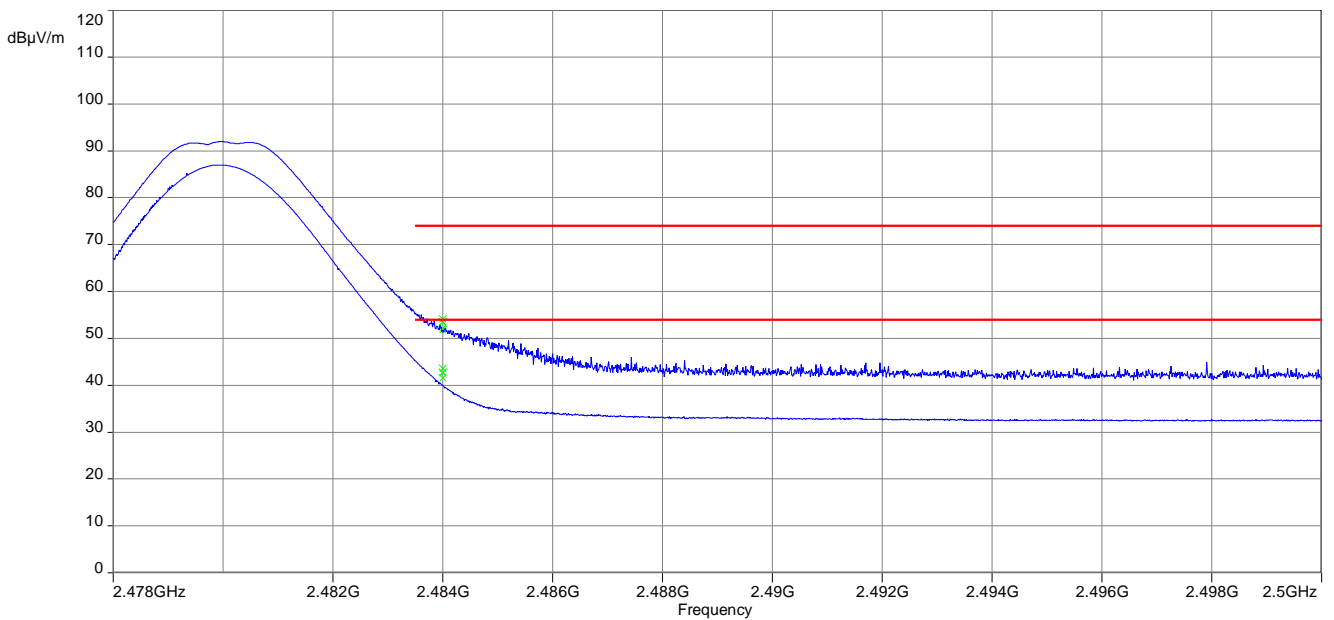

11.8 TX spurious emissions conducted

Description:

Measurement of the conducted spurious emissions in transmit mode. The EUT is set to single channel mode and the transmit frequencies are 2402 MHz, 2440 MHz and 2480 MHz.

| Measurement parameters | |
|-------------------------|----------------------|
| Detector | Peak |
| Sweep time | Auto |
| Resolution bandwidth | 100 kHz |
| Video bandwidth | 300 kHz or 500 kHz |
| Span | 9 kHz to 25 GHz |
| Trace mode | Max hold |
| Test setup | See sub clause 7.4 A |
| Measurement uncertainty | See sub clause 8 |

Limits:

| FCC | IC |
|---|----|
| TX spurious emissions conducted | |
| <p>In any 100 kHz bandwidth outside the frequency band in which the spread spectrum or digitally modulated intentional radiator is operating, the radio frequency power that is produced by the intentional radiator shall be at least 20 dB below that in the 100 kHz bandwidth within the band that contains the highest level of the desired power, based on either an RF conducted or a radiated measurement. Attenuation below the general limits specified in Section 15.209(a) is not required</p> | |

Results: 1 Msps

| TX spurious emissions conducted | | | | | |
|--|--|-----------------------------|-----------------------------------|--|---------------------|
| f [MHz] | | amplitude of emission [dBm] | limit max. allowed emission power | actual attenuation below frequency of operation [dB] | results |
| 2402 | | -3.0 | 30 dBm | | Operating frequency |
| All detected emissions are compliant with the -20 dBc limit! | | | -20 dBc | | compliant |
| | | | | | |
| | | | | | |
| 2440 | | -3.8 | 30 dBm | | Operating frequency |
| All detected emissions are compliant with the -20 dBc limit! | | | -20 dBc | | compliant |
| | | | | | |
| | | | | | |
| 2480 | | -2.8 | 30 dBm | | Operating frequency |
| All detected emissions are compliant with the -20 dBc limit! | | | -20 dBc | | compliant |
| | | | | | |
| | | | | | |

Results: 2 Msps

| TX spurious emissions conducted | | | | | |
|--|--|-----------------------------|-----------------------------------|--|---------------------|
| f [MHz] | | amplitude of emission [dBm] | limit max. allowed emission power | actual attenuation below frequency of operation [dB] | results |
| 2402 | | -3.0 | 30 dBm | | Operating frequency |
| All detected emissions are compliant with the -20 dBc limit! | | | -20 dBc | | compliant |
| | | | | | |
| | | | | | |
| 2440 | | -3.8 | 30 dBm | | Operating frequency |
| All detected emissions are compliant with the -20 dBc limit! | | | -20 dBc | | compliant |
| | | | | | |
| | | | | | |
| 2480 | | -2.8 | 30 dBm | | Operating frequency |
| All detected emissions are compliant with the -20 dBc limit! | | | -20 dBc | | compliant |
| | | | | | |
| | | | | | |

Plots:

Plot 1: lowest channel, 1 Msp

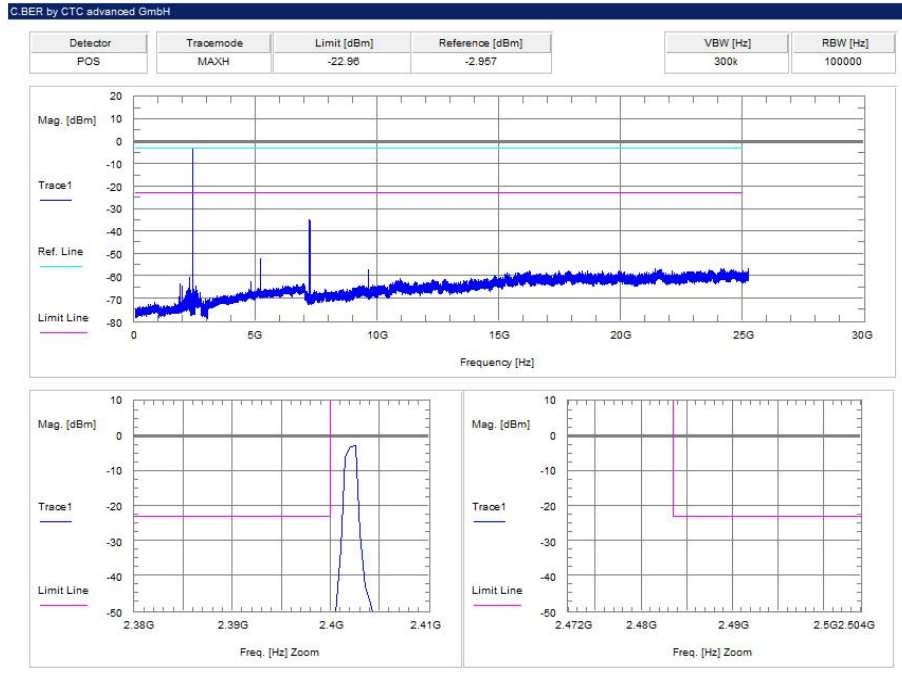

Plot 2: mid channel, 1 Msp

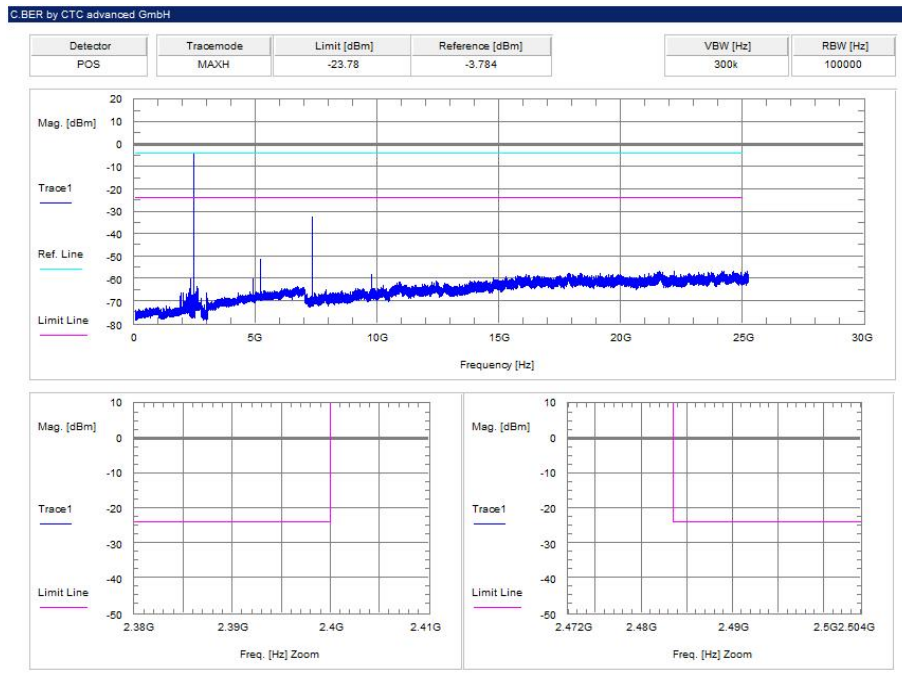

Plot 3: highest channel, 1 Msp

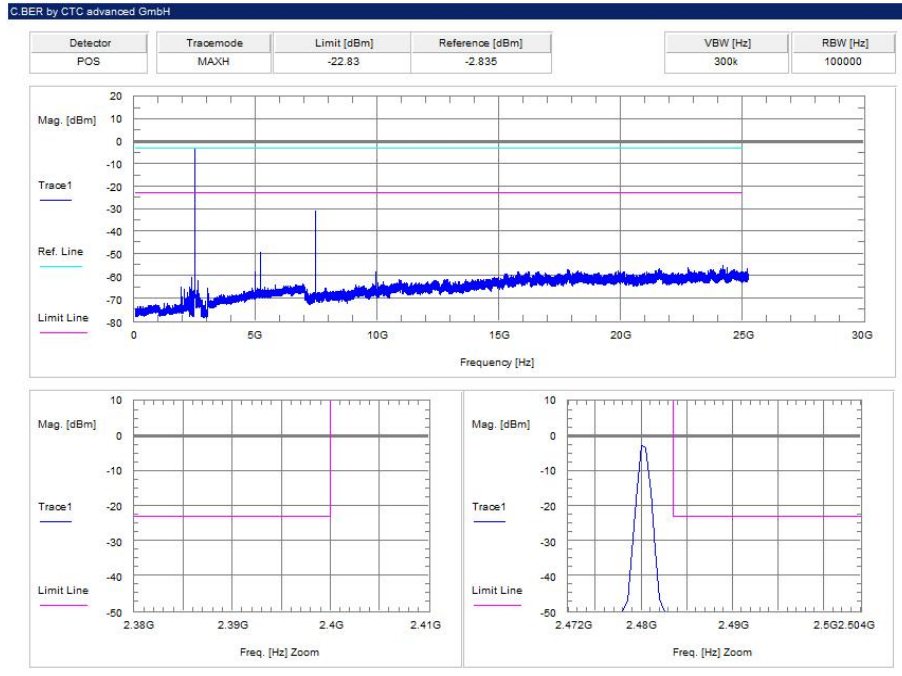

Plot 4: lowest channel, 2 Msp

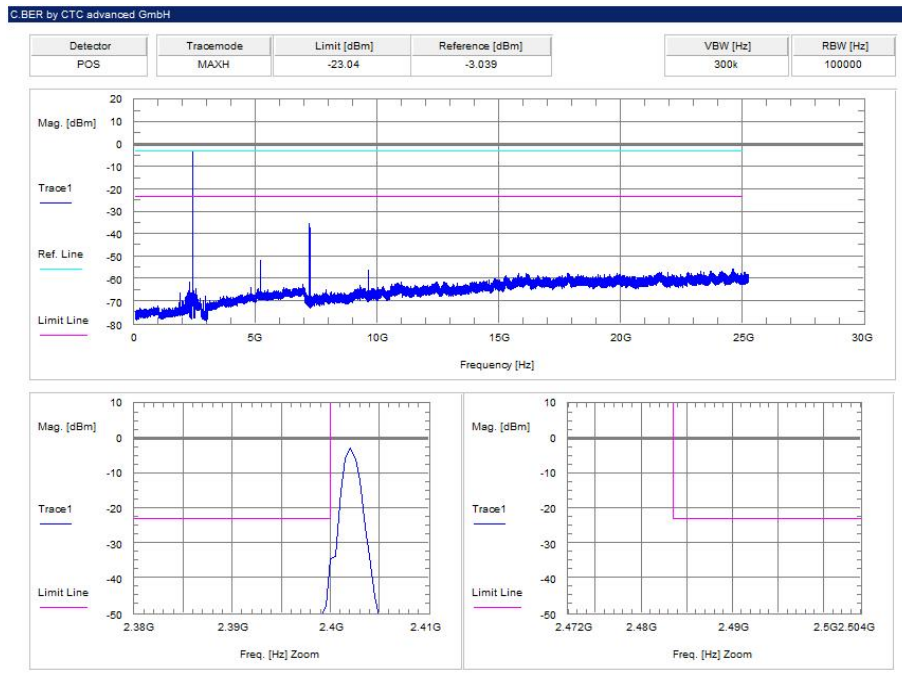

Plot 5: mid channel, 2 Msps

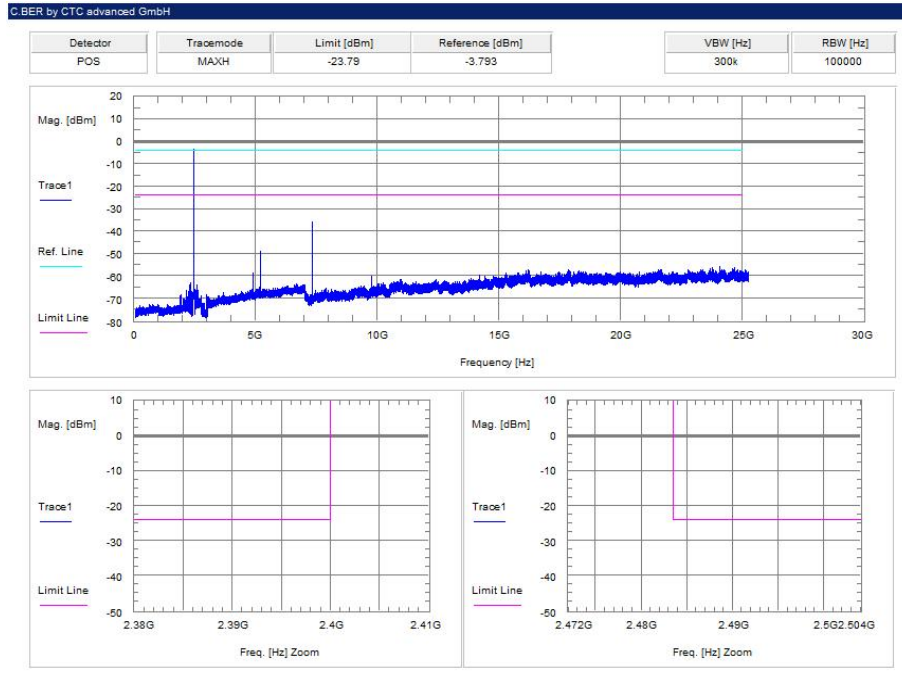

Plot 6: highest channel, 2 Msps

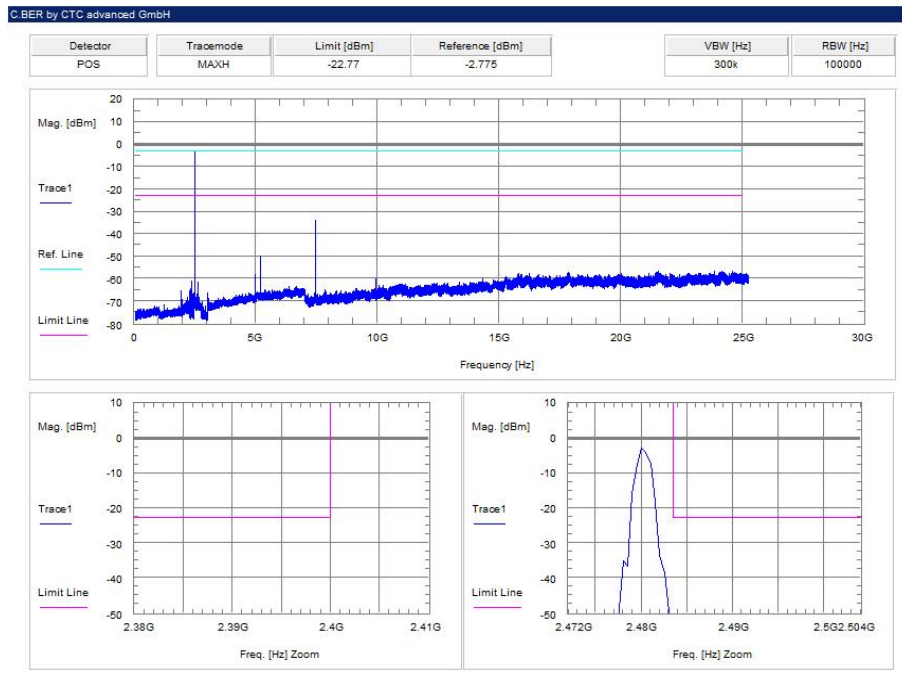

11.9 Spurious emissions radiated below 30 MHz

Description:

Measurement of the radiated spurious emissions in transmit mode below 30 MHz. The EUT is set to single channel mode and the transmit frequencies are 2402 MHz, 2440 MHz and 2480 MHz. The measurement is performed in the mode with the highest output power. The limits are recalculated to a measurement distance of 3 m according the ANSI C63.10.

| Measurement parameters | |
|-------------------------|---|
| Detector | Peak / Quasi peak |
| Sweep time | Auto |
| Resolution bandwidth | F < 150 kHz: 200 Hz F > 150 kHz: 9 kHz |
| Video bandwidth | F < 150 kHz: 1 kHz F > 150 kHz: 30 kHz |
| Span | 9 kHz to 30 MHz |
| Trace mode | Max hold |
| Test setup | See sub clause 7.2 C |
| Measurement uncertainty | See sub clause 8 |

Limits:

| FCC | | IC |
|---|-------------------------|----------------------|
| TX spurious emissions radiated below 30 MHz | | |
| Frequency (MHz) | Field strength (dBµV/m) | Measurement distance |
| 0.009 – 0.490 | 2400/F(kHz) | 300 |
| 0.490 – 1.705 | 24000/F(kHz) | 30 |
| 1.705 – 30.0 | 30 | 30 |

Results: 1 Msps

| TX spurious emissions radiated below 30 MHz [dB μ V/m] | | |
|---|----------|----------------------|
| F [MHz] | Detector | Level [dB μ V/m] |
| All detected emissions are more than 20 dB below the limit. | | |
| | | |
| | | |

Results: 2 Msps

| TX spurious emissions radiated below 30 MHz [dB μ V/m] | | |
|---|----------|----------------------|
| F [MHz] | Detector | Level [dB μ V/m] |
| All detected emissions are more than 20 dB below the limit. | | |
| | | |
| | | |

Plots:

Plot 1: 9 kHz to 30 MHz, 2402 MHz, transmit mode, 1 Msps

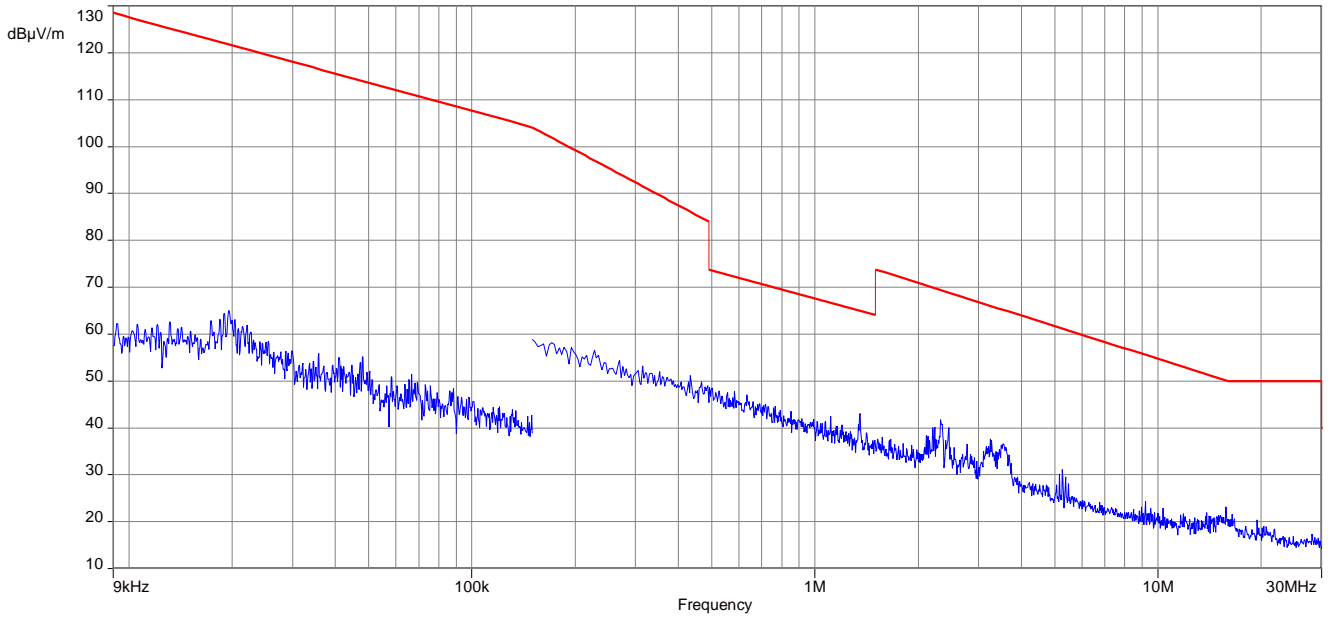

Plot 2: 9 kHz to 30 MHz, 2440 MHz, transmit mode, 1 Msps

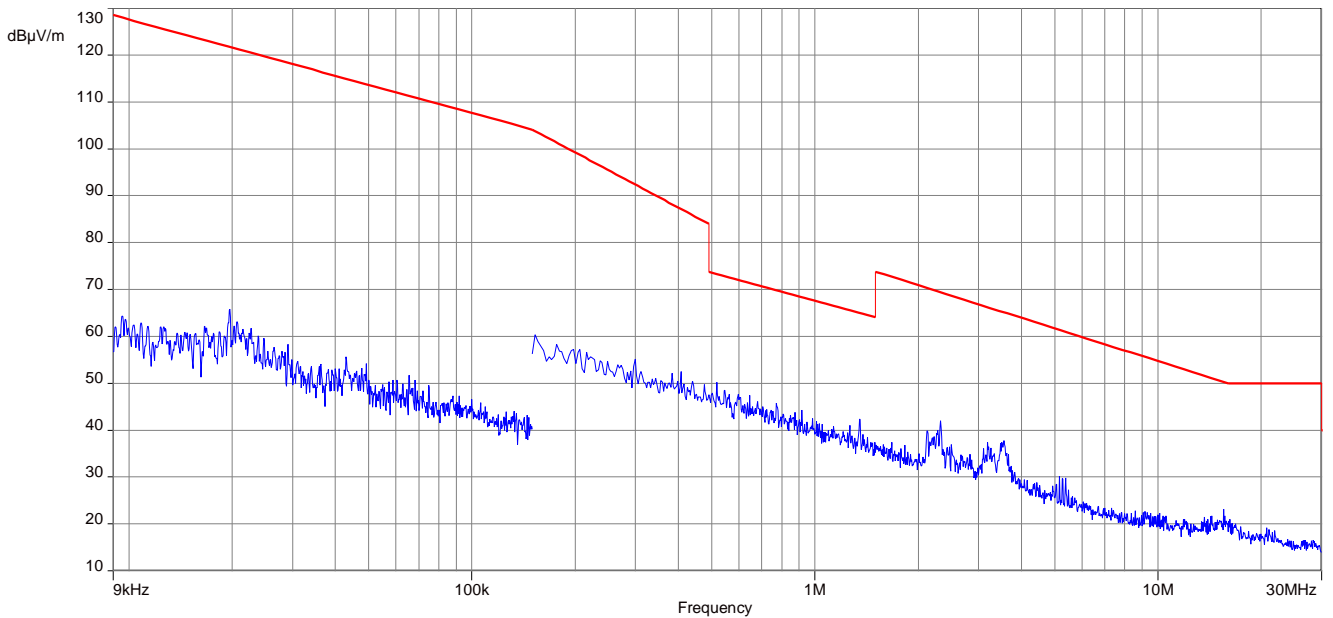

Plot 3: 9 kHz to 30 MHz, 2480 MHz, transmit mode, 1 Msps

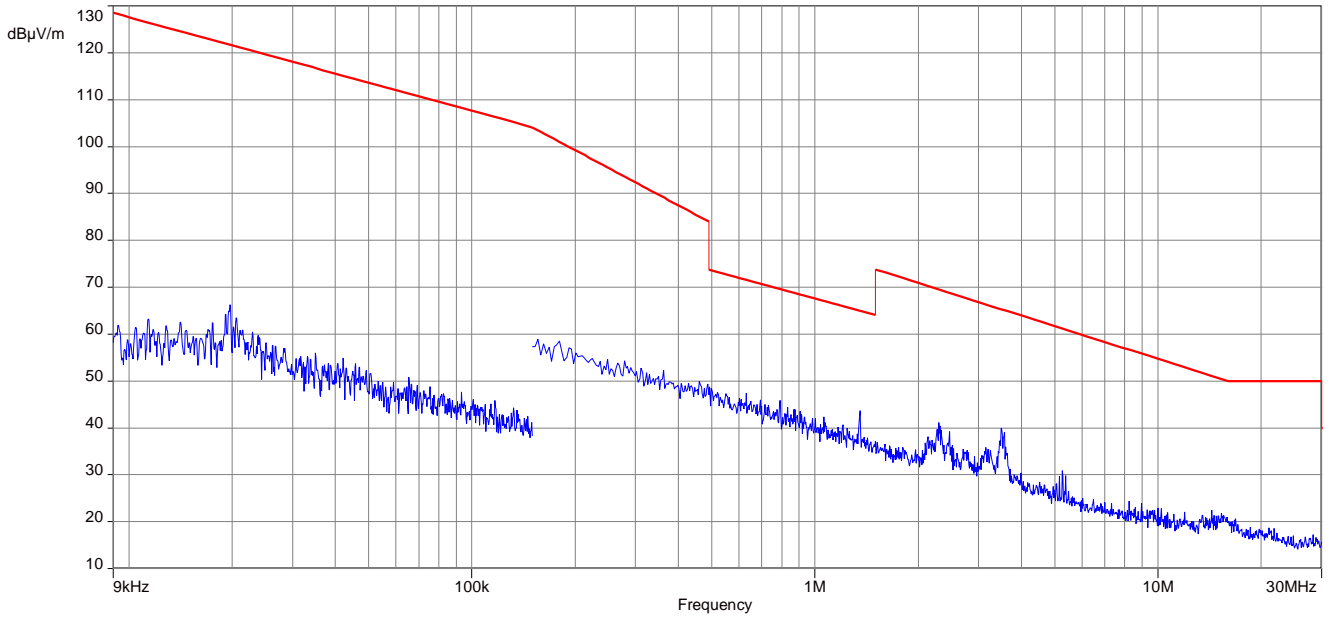

Plot 4: 9 kHz to 30 MHz, 2402 MHz, transmit mode, 2 Msps

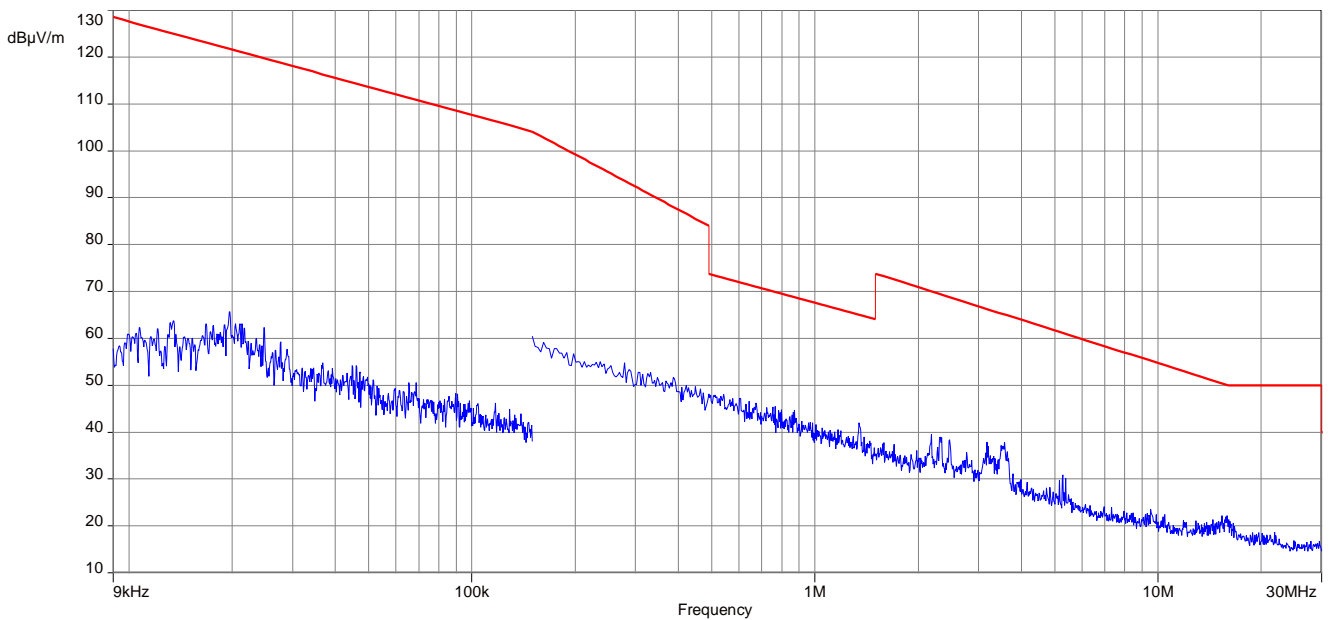

Plot 5: 9 kHz to 30 MHz, 2440 MHz, transmit mode, 2 Msps

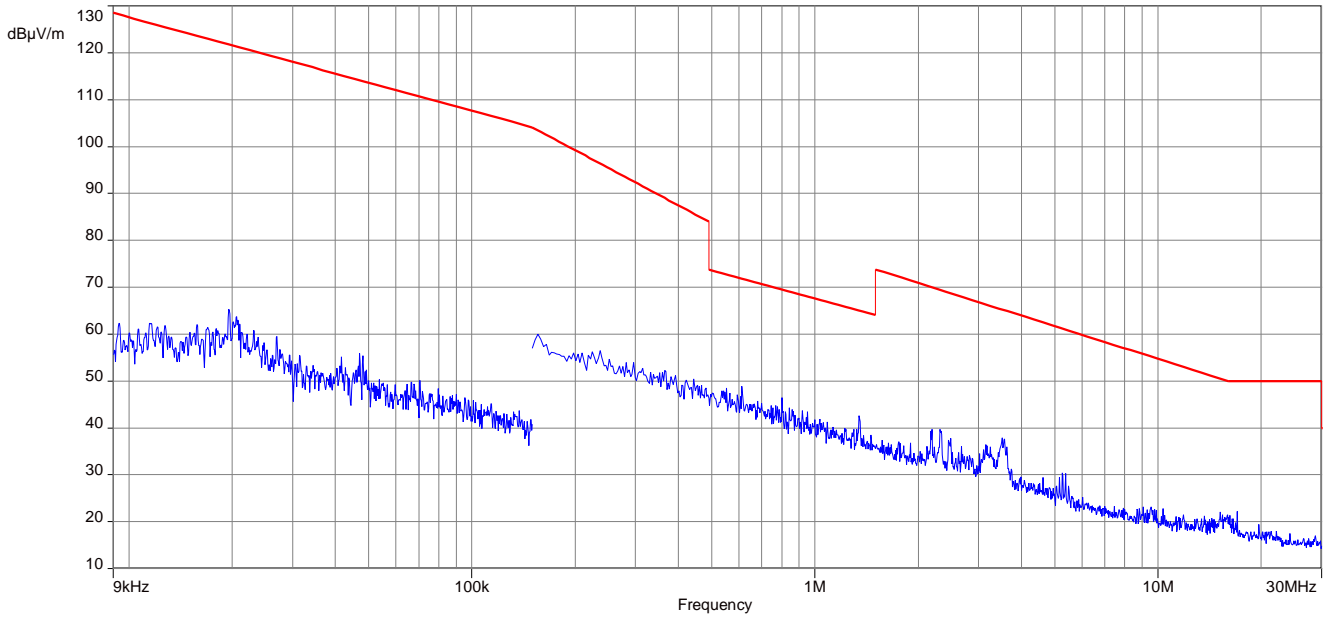

Plot 6: 9 kHz to 30 MHz, 2480 MHz, transmit mode, 2 Msps

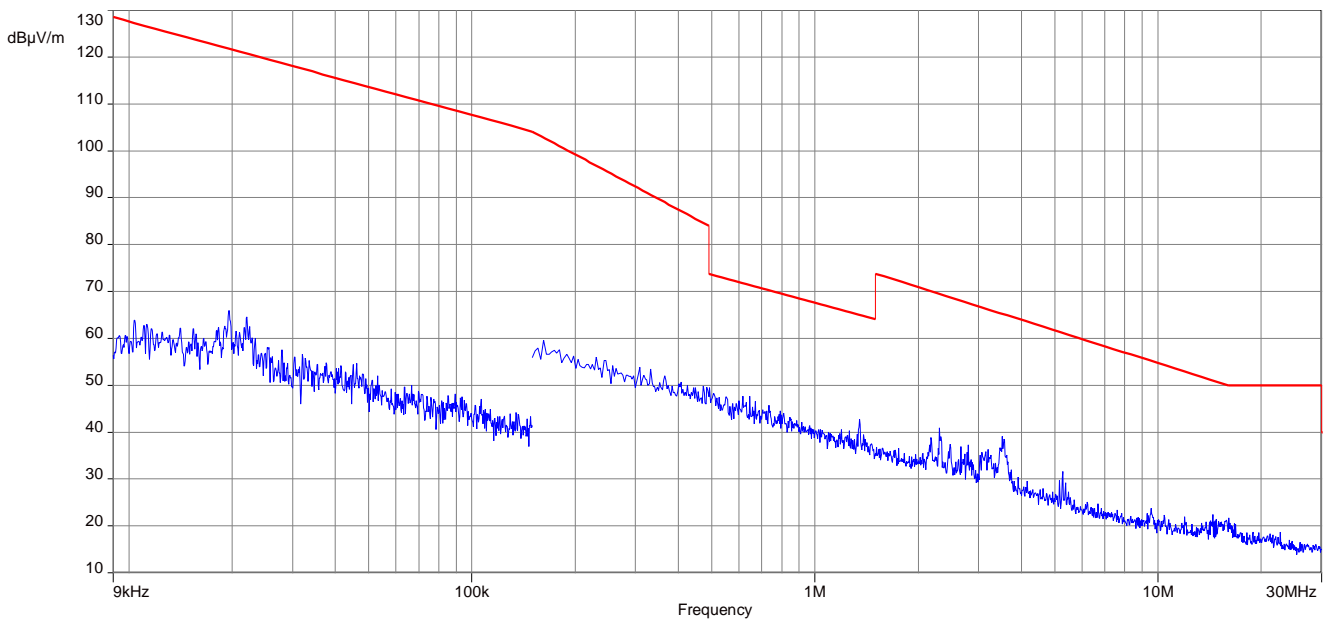

11.10 Spurious emissions radiated 30 MHz to 1 GHz

Description:

Measurement of the radiated spurious emissions in transmit mode. The EUT is set to single channel mode and the transmit frequencies are 2402 MHz, 2440 MHz and 2480 MHz.

| Measurement parameters | |
|-------------------------|----------------------|
| Detector | Peak / Quasi Peak |
| Sweep time | Auto |
| Resolution bandwidth | 120 kHz |
| Video bandwidth | 3 x RBW |
| Span | 30 MHz to 1 GHz |
| Trace mode | Max hold |
| Measured modulation | GFSK |
| Test setup | See sub clause 7.1 A |
| Measurement uncertainty | See sub clause 8 |

Limits:

| FCC | | IC |
|--|-------------------------|----------------------|
| TX spurious emissions radiated | | |
| In any 100 kHz bandwidth outside the frequency band in which the spread spectrum or digitally modulated intentional radiator is operating, the radio frequency power that is produced by the intentional radiator shall be at least 20 dB below that in the 100 kHz bandwidth within the band that contains the highest level of the desired power, based on either an RF conducted or a radiated measurement. Attenuation below the general limits specified in Section 15.209(a) is not required. In addition, radiated emissions which fall in the restricted bands, as defined in §15.205(a), must also comply with the radiated emission limits specified in §15.209(a) (see §15.205(c)). | | |
| §15.209 | | |
| Frequency (MHz) | Field strength (dBµV/m) | Measurement distance |
| 30 - 88 | 30.0 | 10 |
| 88 – 216 | 33.5 | 10 |
| 216 – 960 | 36.0 | 10 |
| Above 960 | 54.0 | 3 |

Plots: Transmit mode

Plot 1: 30 MHz to 1 GHz, TX mode, 2402 MHz, vertical & horizontal polarization, 1 Msp

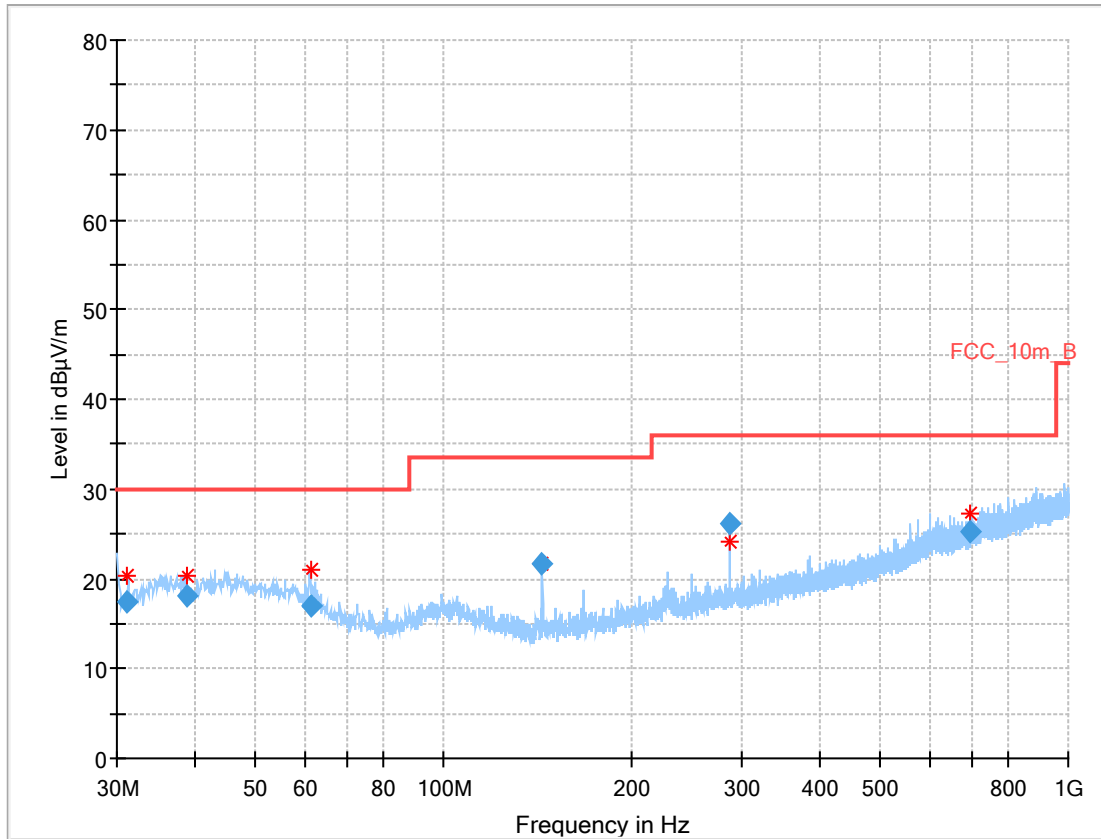

Final results:

| Frequency (MHz) | QuasiPeak (dBµV/m) | Limit (dBµV/m) | Margin (dB) | Meas. Time (ms) | Bandwidth (kHz) | Height (cm) | Pol | Azimuth (deg) | Corr. (dB) |
|-----------------|--------------------|----------------|-------------|-----------------|-----------------|-------------|-----|---------------|------------|
| 31.135 | 17.40 | 30.0 | 12.60 | 1000 | 120 | 160.0 | H | 248.0 | 13.2 |
| 38.742 | 18.20 | 30.0 | 11.80 | 1000 | 120 | 98.0 | V | 350.0 | 14.2 |
| 61.583 | 17.08 | 30.0 | 12.92 | 1000 | 120 | 160.0 | V | 180.0 | 12.6 |
| 143.998 | 21.57 | 33.5 | 11.93 | 1000 | 120 | 98.0 | V | 17.0 | 9.9 |
| 288.002 | 26.08 | 36.0 | 9.92 | 1000 | 120 | 160.0 | V | 200.0 | 14.3 |
| 698.172 | 25.36 | 36.0 | 10.64 | 1000 | 120 | 98.0 | V | 9.0 | 21.1 |

Plot 2: 30 MHz to 1 GHz, TX mode, 2440 MHz, vertical & horizontal polarization, 1 Msp/s

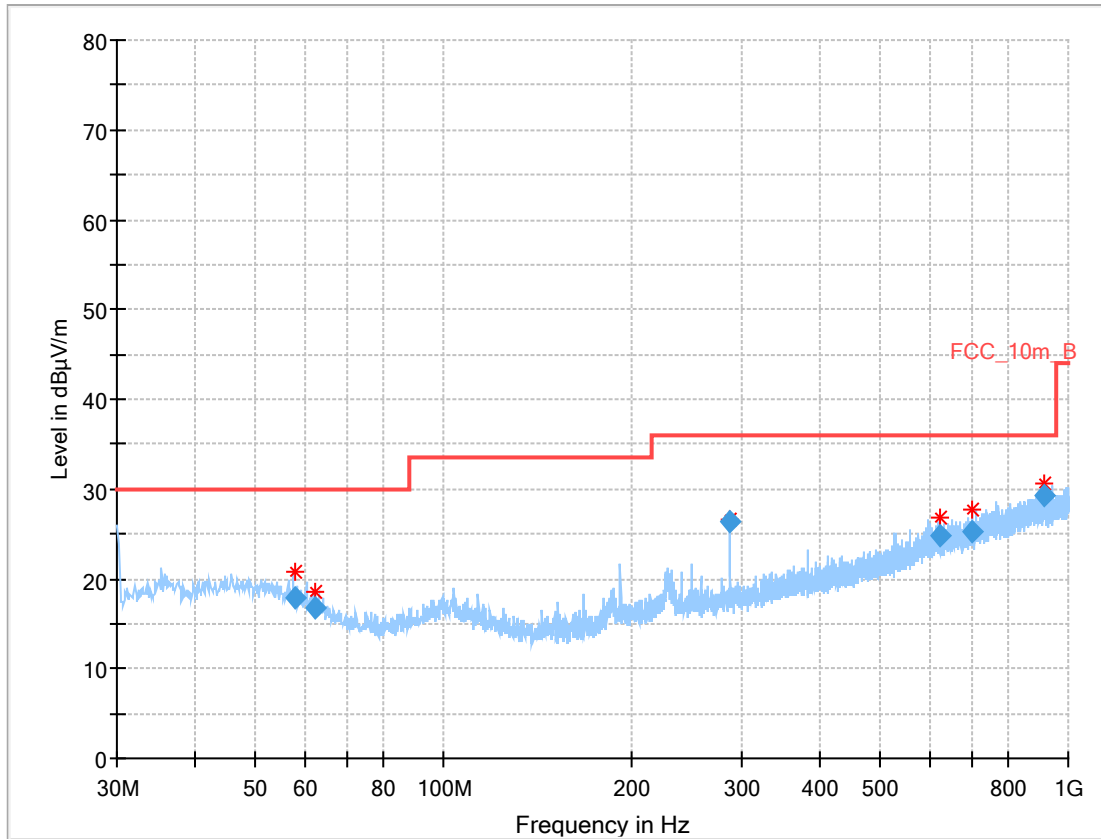

Final results:

| Frequency (MHz) | QuasiPeak (dBµV/m) | Limit (dBµV/m) | Margin (dB) | Meas. Time (ms) | Bandwidth (kHz) | Height (cm) | Pol | Azimuth (deg) | Corr. (dB) |
|-----------------|--------------------|----------------|-------------|-----------------|-----------------|-------------|-----|---------------|------------|
| 57.773 | 17.87 | 30.0 | 12.13 | 1000 | 120 | 101.0 | V | 334.0 | 13.5 |
| 62.121 | 16.81 | 30.0 | 13.19 | 1000 | 120 | 160.0 | V | 9.0 | 12.5 |
| 288.007 | 26.43 | 36.0 | 9.57 | 1000 | 120 | 101.0 | V | 220.0 | 14.3 |
| 624.741 | 24.71 | 36.0 | 11.29 | 1000 | 120 | 101.0 | V | 235.0 | 20.6 |
| 699.291 | 25.35 | 36.0 | 10.65 | 1000 | 120 | 101.0 | H | 0.0 | 21.1 |
| 914.560 | 29.33 | 36.0 | 6.67 | 1000 | 120 | 160.0 | V | 34.0 | 23.9 |

Plot 3: 30 MHz to 1 GHz, TX mode, 2480 MHz, vertical & horizontal polarization, 1 Msp

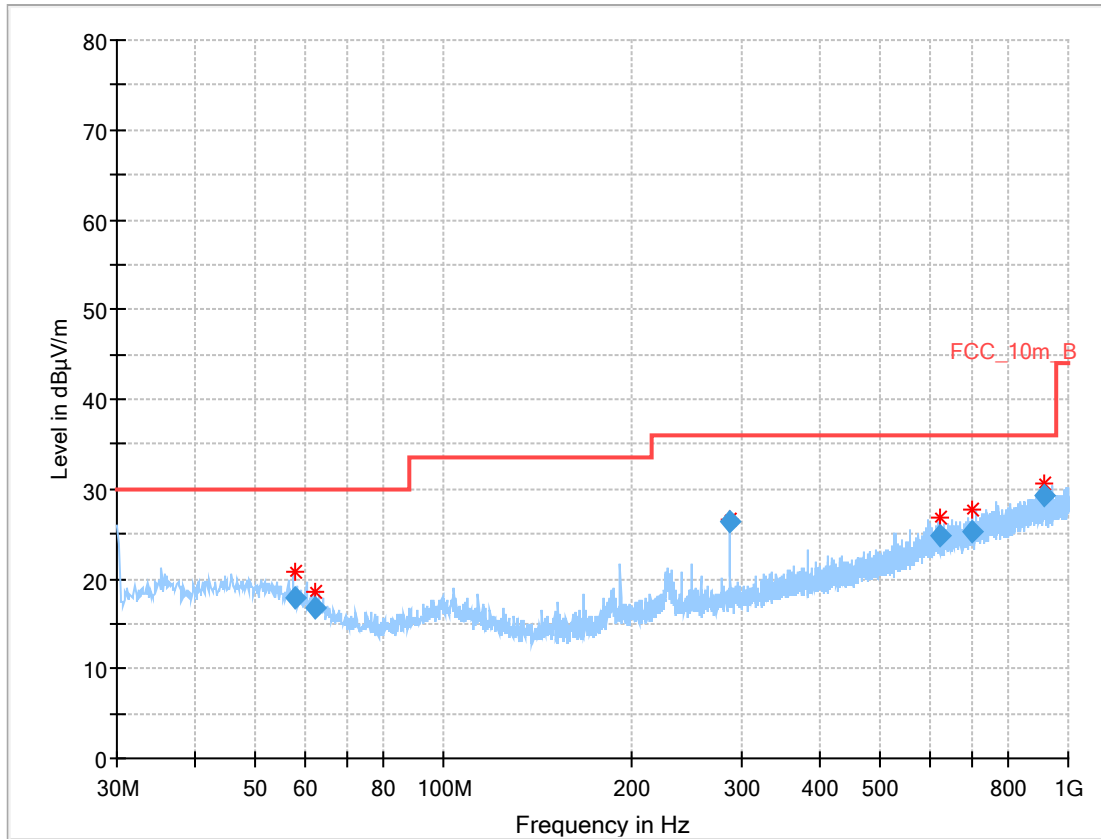

Final results:

| Frequency (MHz) | QuasiPeak (dBµV/m) | Limit (dBµV/m) | Margin (dB) | Meas. Time (ms) | Bandwidth (kHz) | Height (cm) | Pol | Azimuth (deg) | Corr. (dB) |
|-----------------|--------------------|----------------|-------------|-----------------|-----------------|-------------|-----|---------------|------------|
| 57.773 | 17.87 | 30.0 | 12.13 | 1000 | 120 | 101.0 | V | 334.0 | 13.5 |
| 62.121 | 16.81 | 30.0 | 13.19 | 1000 | 120 | 160.0 | V | 9.0 | 12.5 |
| 288.007 | 26.43 | 36.0 | 9.57 | 1000 | 120 | 101.0 | V | 220.0 | 14.3 |
| 624.741 | 24.71 | 36.0 | 11.29 | 1000 | 120 | 101.0 | V | 235.0 | 20.6 |
| 699.291 | 25.35 | 36.0 | 10.65 | 1000 | 120 | 101.0 | H | 0.0 | 21.1 |
| 914.560 | 29.33 | 36.0 | 6.67 | 1000 | 120 | 160.0 | V | 34.0 | 23.9 |

Plot 4: 30 MHz to 1 GHz, TX mode, 2402 MHz, vertical & horizontal polarization, 2 Msp

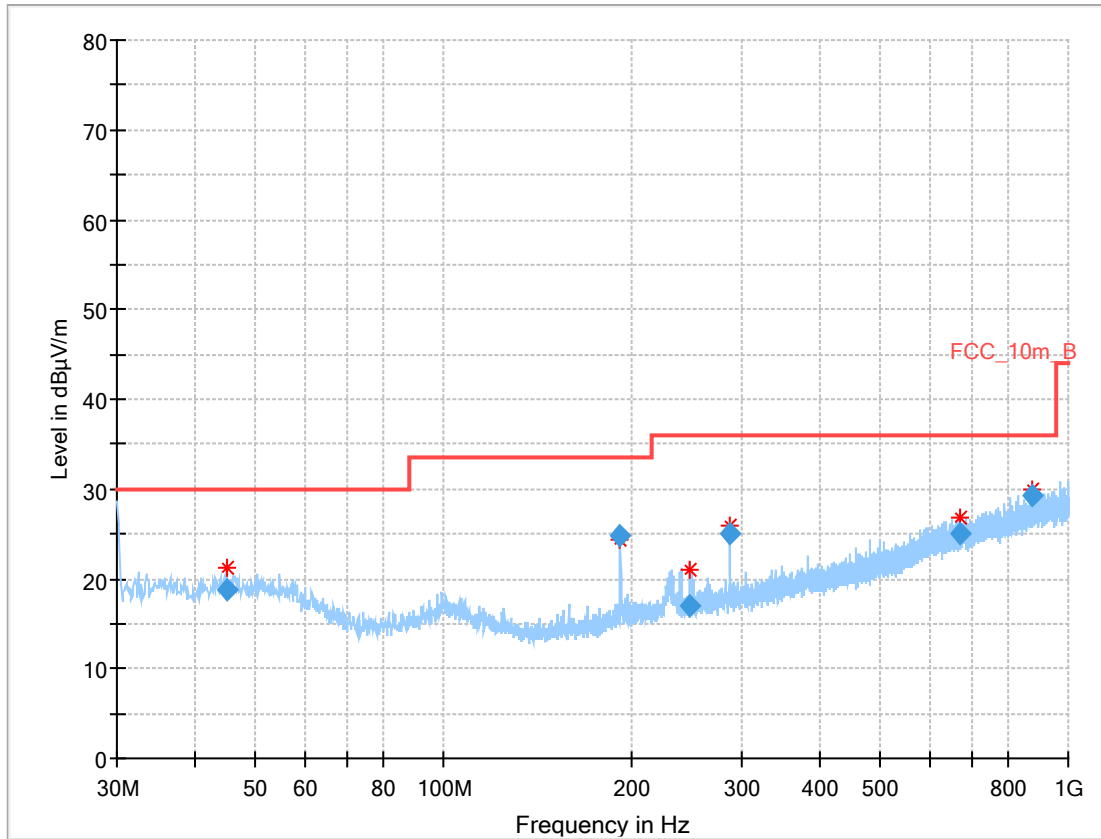

Final results:

| Frequency (MHz) | QuasiPeak (dBµV/m) | Limit (dBµV/m) | Margin (dB) | Meas. Time (ms) | Bandwidth (kHz) | Height (cm) | Pol | Azimuth (deg) | Corr. (dB) |
|-----------------|--------------------|----------------|-------------|-----------------|-----------------|-------------|-----|---------------|------------|
| 44.977 | 18.73 | 30.0 | 11.27 | 1000 | 120 | 98.0 | V | 229.0 | 14.8 |
| 191.993 | 24.91 | 33.5 | 8.59 | 1000 | 120 | 98.0 | V | 293.0 | 12.0 |
| 248.547 | 16.95 | 36.0 | 19.05 | 1000 | 120 | 160.0 | V | 93.0 | 13.6 |
| 287.977 | 25.00 | 36.0 | 11.00 | 1000 | 120 | 98.0 | V | 109.0 | 14.3 |
| 668.934 | 25.02 | 36.0 | 10.98 | 1000 | 120 | 101.0 | H | 261.0 | 20.9 |
| 874.440 | 29.22 | 36.0 | 6.78 | 1000 | 120 | 101.0 | H | 161.0 | 23.5 |

Plot 5: 30 MHz to 1 GHz, TX mode, 2440 MHz, vertical & horizontal polarization, 2 Msp

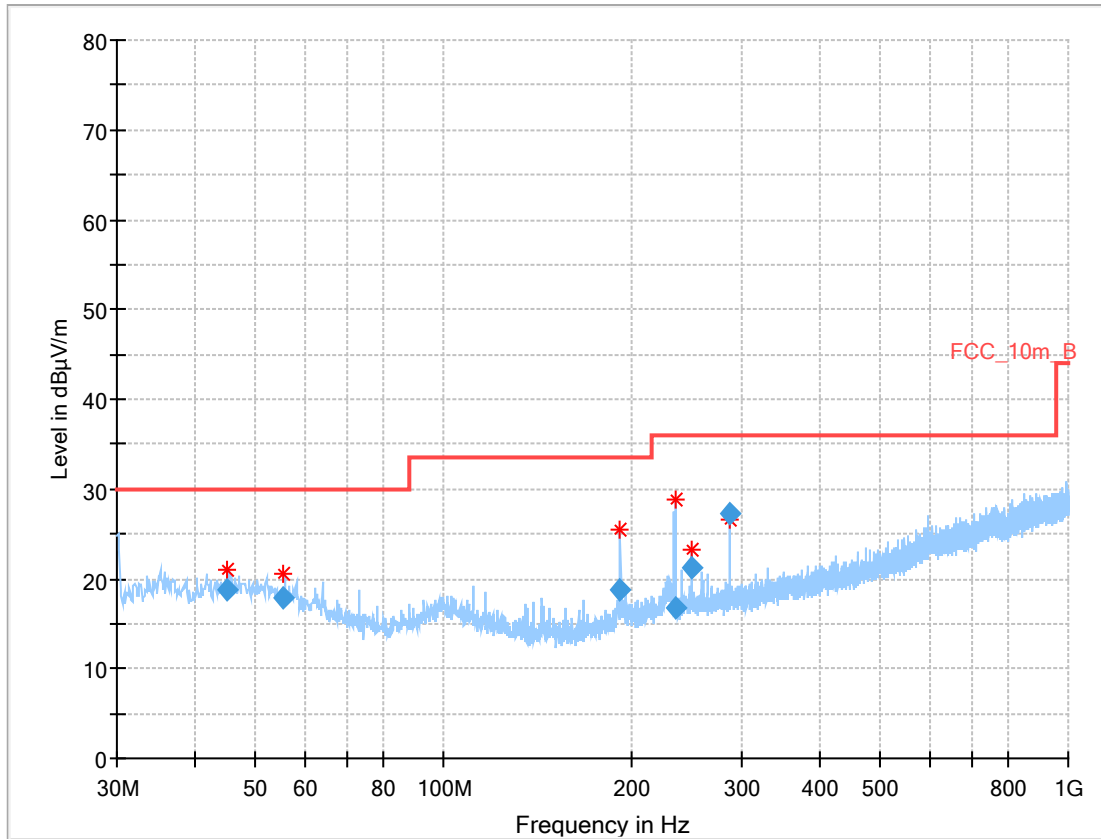

Final results:

| Frequency (MHz) | QuasiPeak (dBµV/m) | Limit (dBµV/m) | Margin (dB) | Meas. Time (ms) | Bandwidth (kHz) | Height (cm) | Pol | Azimuth (deg) | Corr. (dB) |
|-----------------|--------------------|----------------|-------------|-----------------|-----------------|-------------|-----|---------------|------------|
| 45.117 | 18.80 | 30.0 | 11.20 | 1000 | 120 | 98.0 | V | 103.0 | 14.8 |
| 55.384 | 17.97 | 30.0 | 12.03 | 1000 | 120 | 160.0 | V | 340.0 | 14.1 |
| 192.013 | 18.68 | 33.5 | 14.82 | 1000 | 120 | 160.0 | V | 68.0 | 12.0 |
| 234.665 | 16.84 | 36.0 | 19.16 | 1000 | 120 | 160.0 | V | 350.0 | 13.3 |
| 250.018 | 21.22 | 36.0 | 14.78 | 1000 | 120 | 98.0 | V | 159.0 | 13.7 |
| 288.005 | 27.28 | 36.0 | 8.72 | 1000 | 120 | 98.0 | V | 185.0 | 14.3 |

Plot 6: 30 MHz to 1 GHz, TX mode, 2480 MHz, vertical & horizontal polarization, 2 Msps

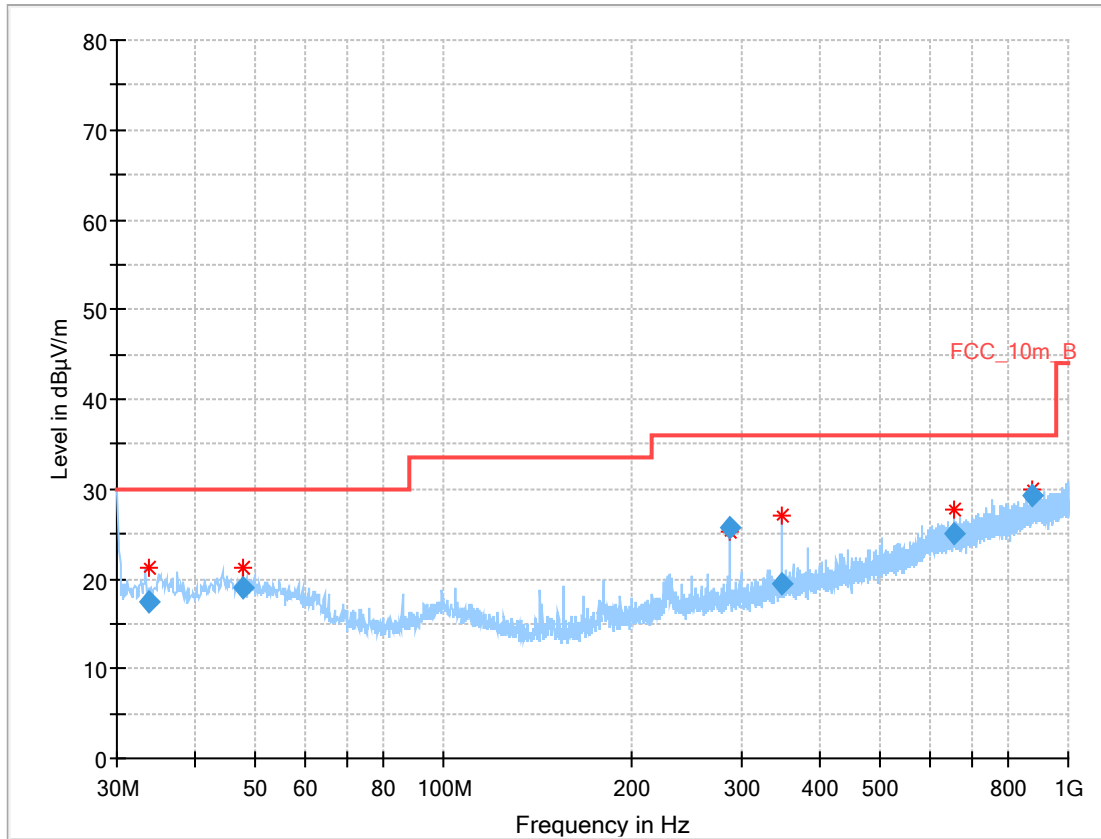

Final results:

| Frequency (MHz) | QuasiPeak (dBµV/m) | Limit (dBµV/m) | Margin (dB) | Meas. Time (ms) | Bandwidth (kHz) | Height (cm) | Pol | Azimuth (deg) | Corr. (dB) |
|-----------------|--------------------|----------------|-------------|-----------------|-----------------|-------------|-----|---------------|------------|
| 33.864 | 17.54 | 30.0 | 12.46 | 1000 | 120 | 101.0 | H | 50.0 | 13.6 |
| 47.712 | 18.91 | 30.0 | 11.09 | 1000 | 120 | 160.0 | V | 297.0 | 14.8 |
| 287.993 | 25.66 | 36.0 | 10.34 | 1000 | 120 | 98.0 | V | 190.0 | 14.3 |
| 348.936 | 19.38 | 36.0 | 16.62 | 1000 | 120 | 98.0 | H | 177.0 | 15.9 |
| 658.008 | 24.95 | 36.0 | 11.05 | 1000 | 120 | 101.0 | H | 350.0 | 20.8 |
| 873.709 | 29.18 | 36.0 | 6.82 | 1000 | 120 | 160.0 | V | 338.0 | 23.5 |

Plots: Receiver mode

Plot 1: 30 MHz to 1 GHz, RX / idle – mode, vertical & horizontal polarization

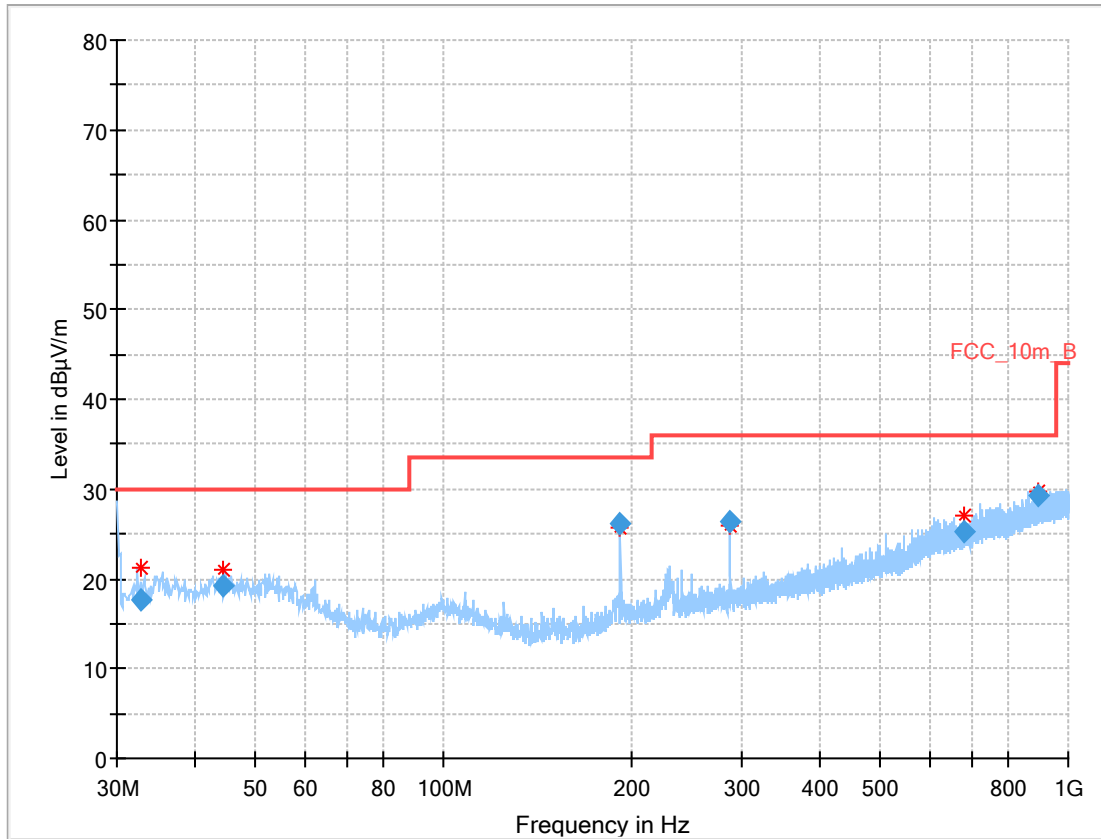

Final results:

| Frequency (MHz) | QuasiPeak (dBµV/m) | Limit (dBµV/m) | Margin (dB) | Meas. Time (ms) | Bandwidth (kHz) | Height (cm) | Pol | Azimuth (deg) | Corr. (dB) |
|-----------------|--------------------|----------------|-------------|-----------------|-----------------|-------------|-----|---------------|------------|
| 32.760 | 17.73 | 30.0 | 12.27 | 1000 | 120 | 101.0 | H | 349.0 | 13.4 |
| 44.210 | 19.20 | 30.0 | 10.80 | 1000 | 120 | 100.0 | V | 57.0 | 14.7 |
| 191.994 | 26.25 | 33.5 | 7.25 | 1000 | 120 | 98.0 | V | 254.0 | 12.0 |
| 288.012 | 26.26 | 36.0 | 9.74 | 1000 | 120 | 98.0 | V | 215.0 | 14.3 |
| 680.278 | 25.15 | 36.0 | 10.85 | 1000 | 120 | 160.0 | V | 85.0 | 21.0 |
| 897.676 | 29.33 | 36.0 | 6.67 | 1000 | 120 | 160.0 | H | 122.0 | 23.8 |

11.11 Spurious emissions radiated above 1 GHz

Description:

Measurement of the radiated spurious emissions in transmit mode. The EUT is set to single channel mode and the transmit frequencies are 2402 MHz, 2440 MHz and 2480 MHz.

| Measurement parameters | |
|-------------------------|---|
| Detector | Peak / RMS |
| Sweep time | Auto |
| Resolution bandwidth | 1 MHz |
| Video bandwidth | 3 x RBW |
| Span | 1 GHz to 26 GHz |
| Trace mode | Max hold |
| Measured modulation | GFSK |
| Test setup | See sub clause 7.2 A (1 GHz - 18 GHz) See sub clause 7.3 A (18 GHz - 26 GHz) |
| Measurement uncertainty | See sub clause 8 |

Limits:

| FCC | IC | |
|--|-------------------------|----------------------|
| TX spurious emissions radiated | | |
| In any 100 kHz bandwidth outside the frequency band in which the spread spectrum or digitally modulated intentional radiator is operating, the radio frequency power that is produced by the intentional radiator shall be at least 20 dB below that in the 100 kHz bandwidth within the band that contains the highest level of the desired power, based on either an RF conducted or a radiated measurement. Attenuation below the general limits specified in Section 15.209(a) is not required. In addition, radiated emissions which fall in the restricted bands, as defined in §15.205(a), must also comply with the radiated emission limits specified in §15.209(a) (see §15.205(c)). | | |
| §15.209 | | |
| Frequency (MHz) | Field strength (dBµV/m) | Measurement distance |
| Above 960 | 54.0 (Average) | 3 |
| Above 960 | 74.0 (Peak) | 3 |

Results: Transmitter mode, 1 Msps

| TX spurious emissions radiated [dBµV/m] | | | | | | | | |
|---|----------|----------------|----------|----------|----------------|----------|----------|----------------|
| 2402 MHz | | | 2440 MHz | | | 2480 MHz | | |
| F [MHz] | Detector | Level [dBµV/m] | F [MHz] | Detector | Level [dBµV/m] | F [MHz] | Detector | Level [dBµV/m] |
| 1332 | Peak | 50.5 | 1332 | Peak | 50.5 | 1332 | Peak | 50.5 |
| | AVG | 30.5 | | AVG | 30.5 | | AVG | 30.5 |
| 3697 | Peak | 46.2 | 7320 | Peak | 58.4 | 7440 | Peak | 59.4 |
| | AVG | 34.6 | | AVG | 52.7 | | AVG | 53.8 |
| | Peak | | | Peak | | | Peak | |
| | AVG | | | AVG | | | AVG | |

Results: Transmitter mode, 2 Msps

| TX spurious emissions radiated [dBµV/m] | | | | | | | | |
|---|----------|----------------|----------|----------|----------------|----------|----------|----------------|
| 2402 MHz | | | 2440 MHz | | | 2480 MHz | | |
| F [MHz] | Detector | Level [dBµV/m] | F [MHz] | Detector | Level [dBµV/m] | F [MHz] | Detector | Level [dBµV/m] |
| 1332 | Peak | 54.1 | 1332 | Peak | 54.1 | 1332 | Peak | 54.1 |
| | AVG | 34.2 | | AVG | 34.2 | | AVG | 34.2 |
| | Peak | | 7320 | Peak | 58.6 | 7440 | Peak | 58.8 |
| | AVG | | | AVG | 52.3 | | AVG | 52.2 |
| | Peak | | | Peak | | | Peak | |
| | AVG | | | AVG | | | AVG | |

Results: Receiver mode

| RX spurious emissions radiated [dBµV/m] | | |
|---|----------|----------------|
| F [MHz] | Detector | Level [dBµV/m] |
| All detected emissions are more than 20 dB below the limit. | | |
| | Peak | |
| | AVG | |

Note: The limit was recalculated with 20 dB / decade (Part 15.31) for all radiated spurious emissions 30 MHz to 1 GHz from 3 meter limit to a 10 meter distance. (40dB/decade for emissions < 30MHz)

Plots: Transmitter mode

Plot 1: 1 GHz to 18 GHz, TX mode, 2402 MHz, vertical & horizontal polarization, 1 Msps

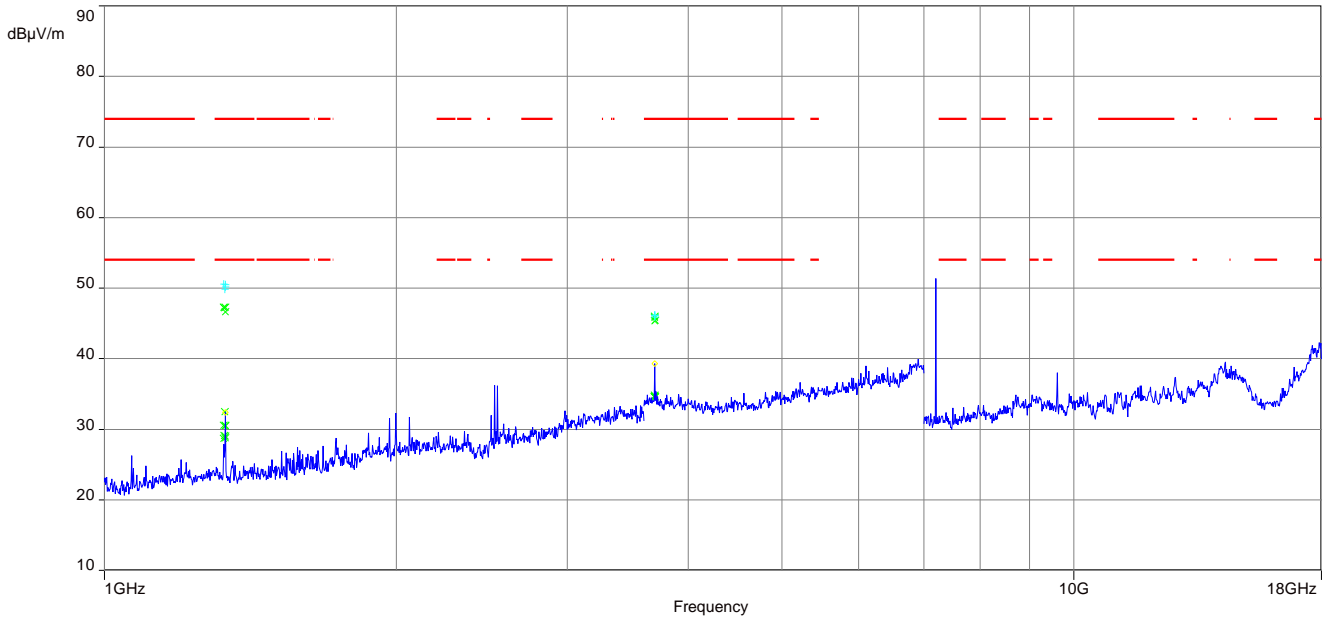

The carrier signal is notched with a 2.4 GHz band rejection filter.

Plot 2: 18 GHz to 26 GHz, TX mode, 2402 MHz, vertical & horizontal polarization, 1 Msps

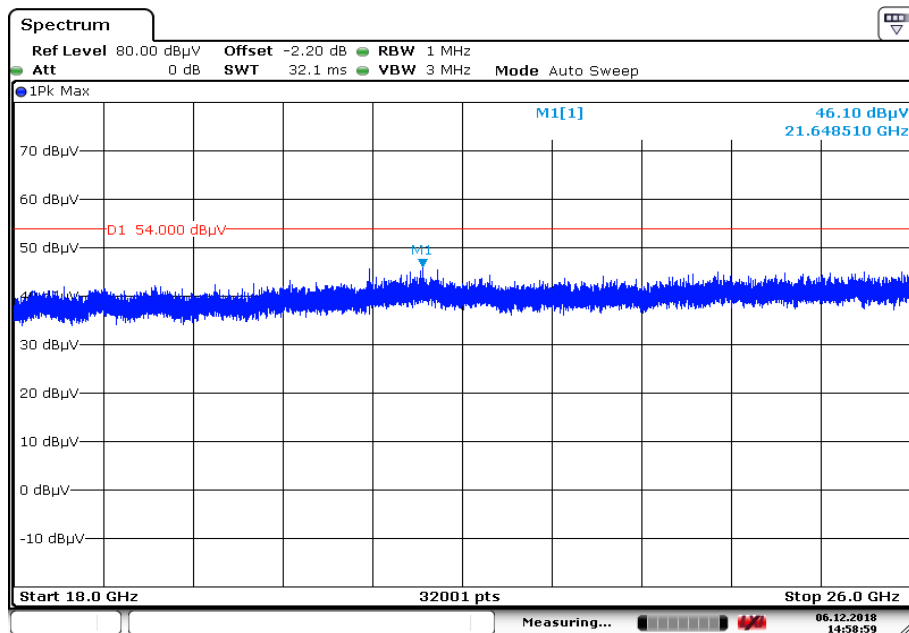

Date: 6 DEC 2018 14:58:59

Plot 3: 1 GHz to 18 GHz, TX mode, 2440 MHz, vertical & horizontal polarization, 1 Msp/s

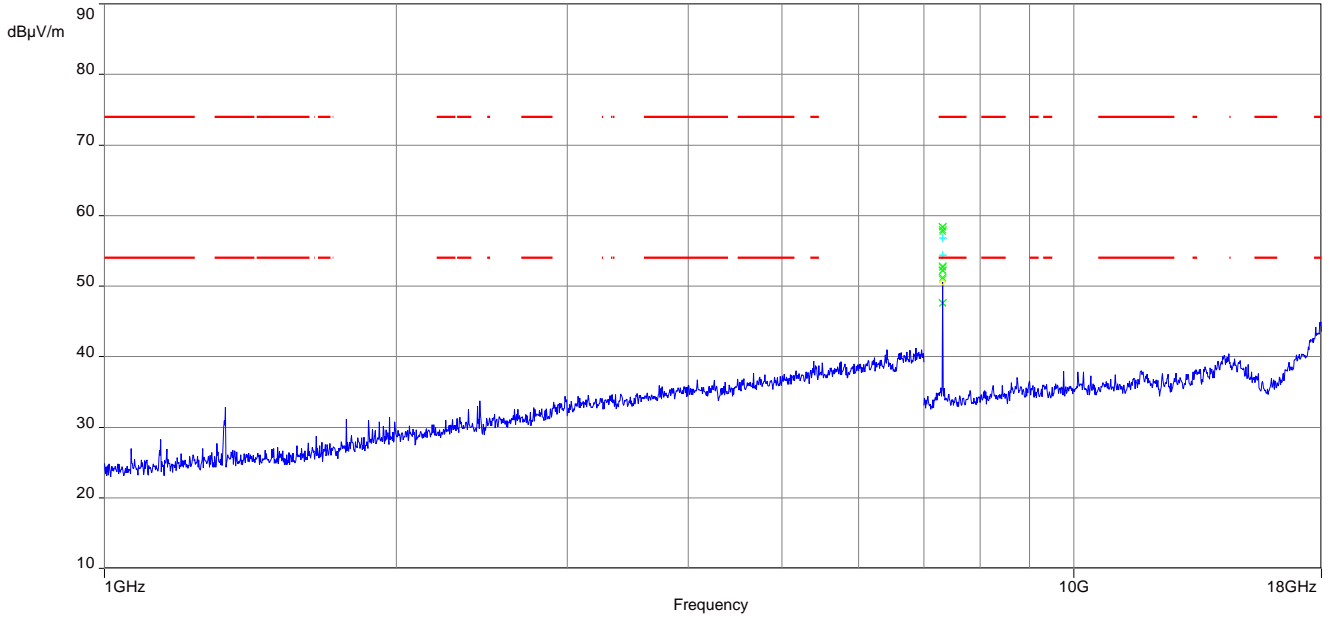

The carrier signal is notched with a 2.4 GHz band rejection filter.

Plot 4: 18 GHz to 26 GHz, TX mode, 2440 MHz, vertical & horizontal polarization, 1 Msp/s

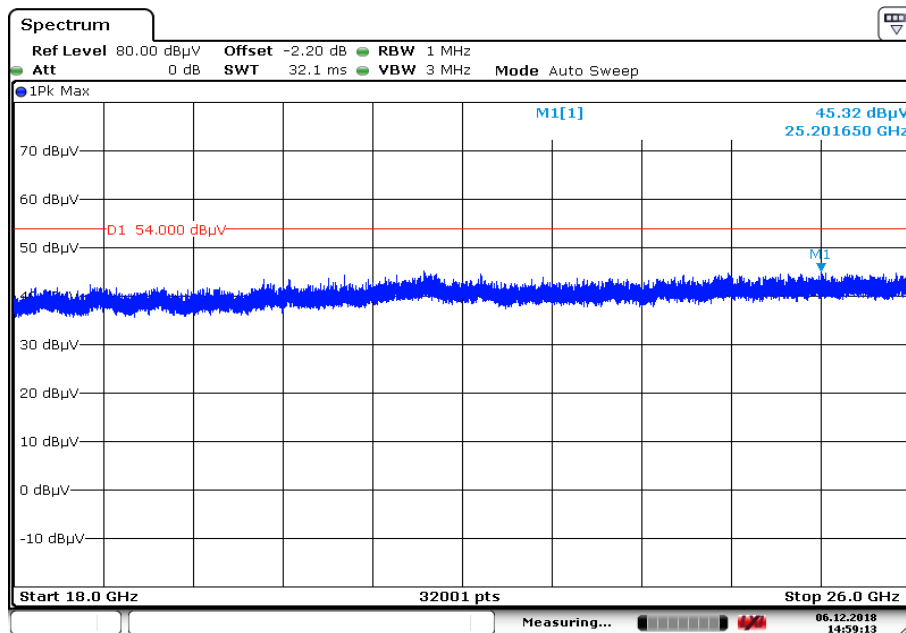

Date: 6 DEC 2018 14:59:13

Plot 5: 1 GHz to 18 GHz, TX mode, 2480 MHz, vertical & horizontal polarization, 1 Msps

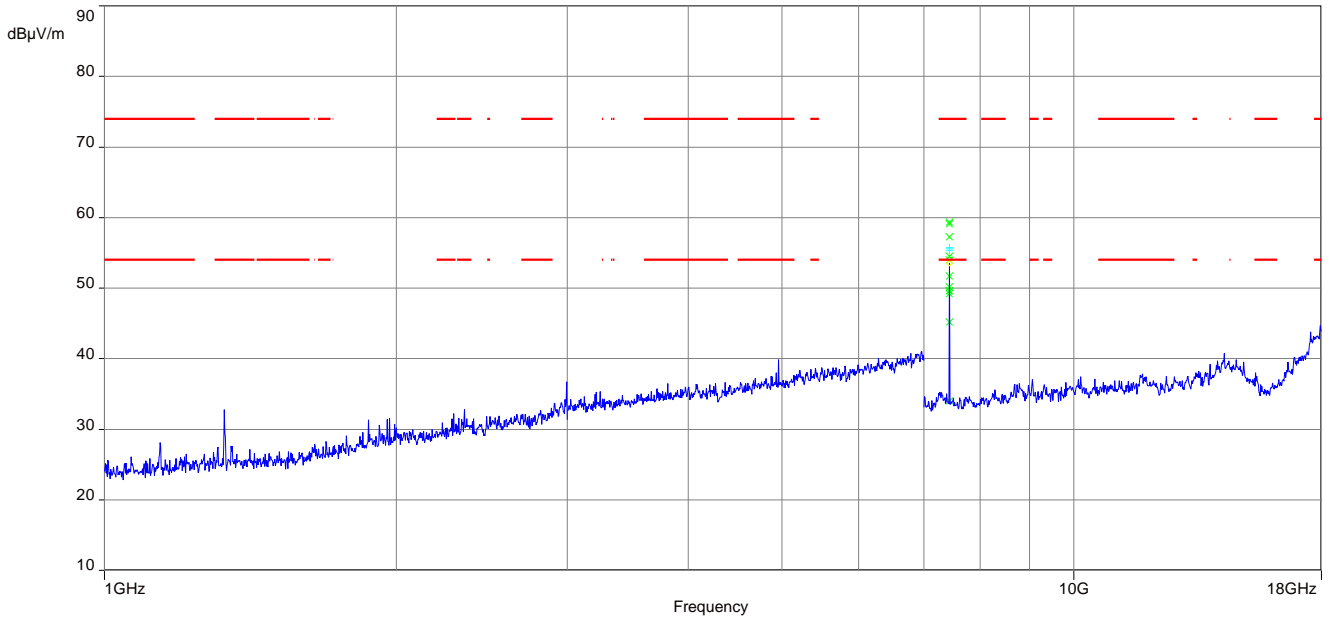

The carrier signal is notched with a 2.4 GHz band rejection filter.

Plot 6: 18 GHz to 26 GHz, TX mode, 2480 MHz, vertical & horizontal polarization, 1 Msps

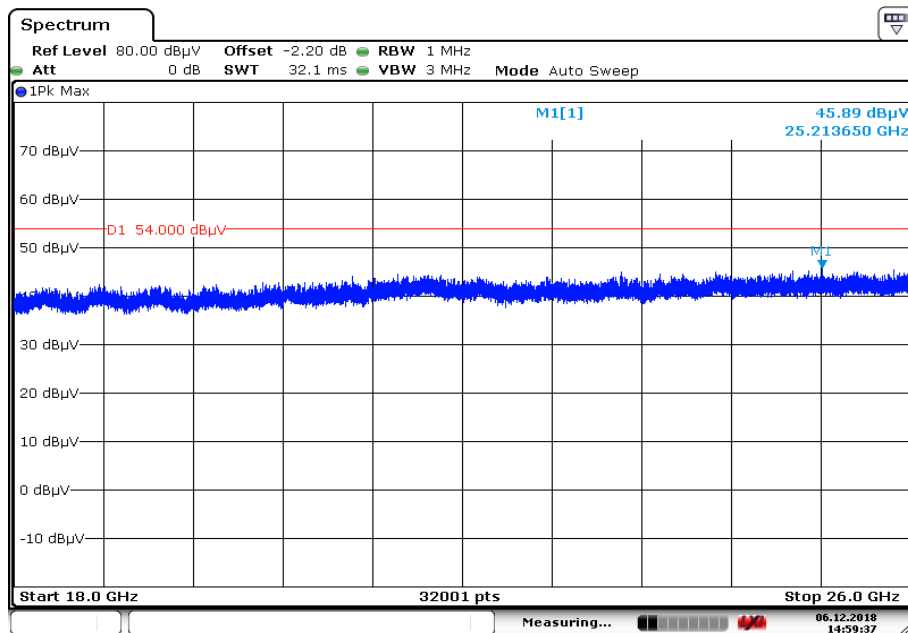

Date: 6 DEC 2018 14:59:37

Plot 7: 1 GHz to 18 GHz, TX mode, 2402 MHz, vertical & horizontal polarization, 2 Msps

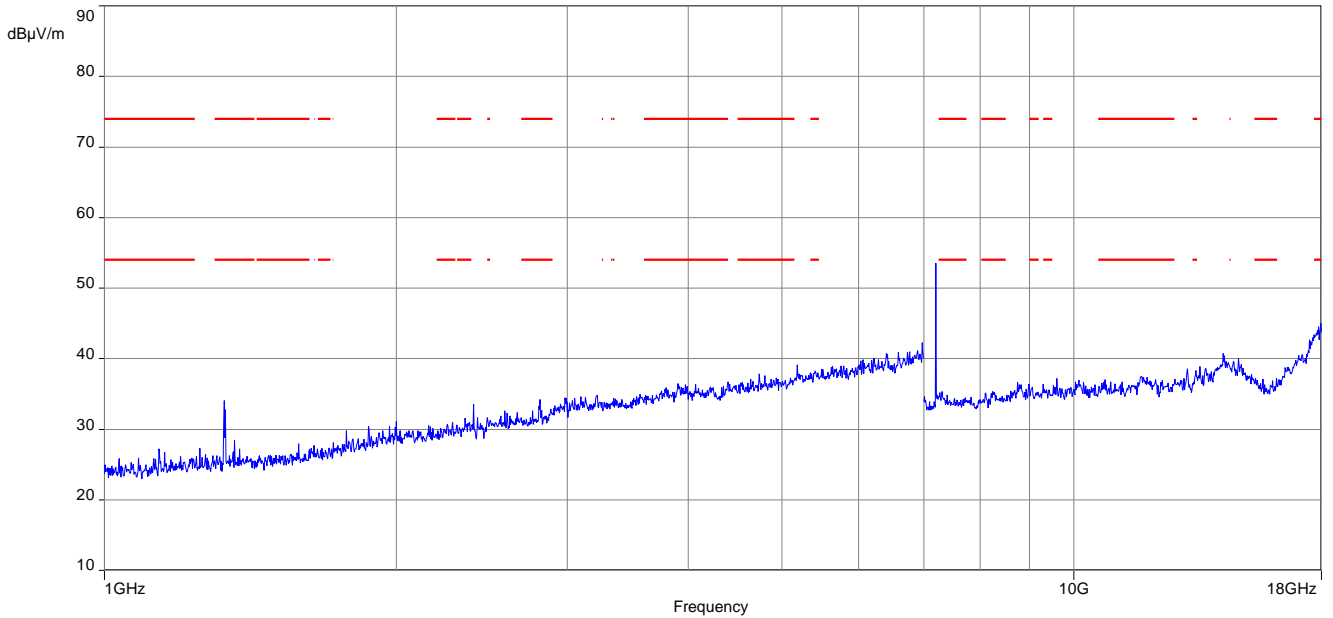

The carrier signal is notched with a 2.4 GHz band rejection filter.

Plot 8: 18 GHz to 26 GHz, TX mode, 2402 MHz, vertical & horizontal polarization, 2 Msps

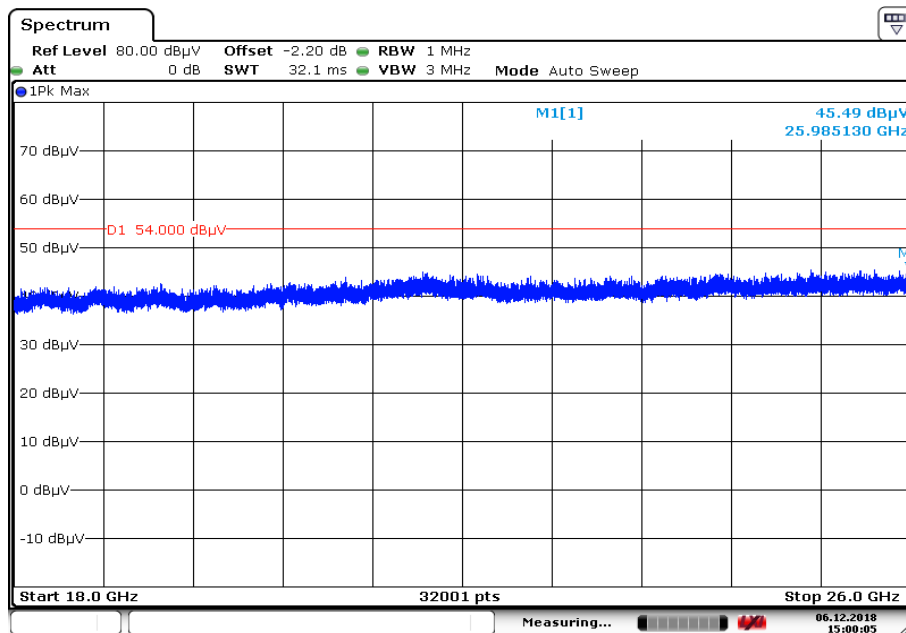

Date: 6 DEC 2018 15:00:05

Plot 9: 1 GHz to 18 GHz, TX mode, 2440 MHz, vertical & horizontal polarization, 2 Msps

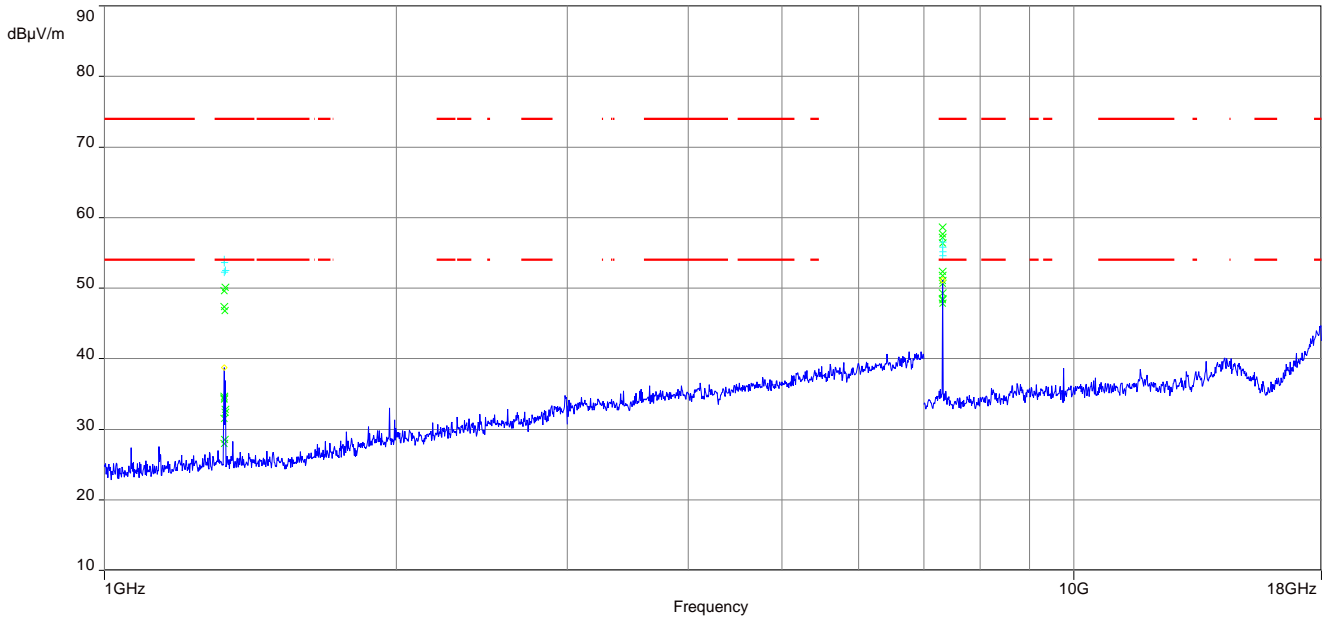

The carrier signal is notched with a 2.4 GHz band rejection filter.

Plot 10: 18 GHz to 26 GHz, TX mode, 2440 MHz, vertical & horizontal polarization, 2 Msps

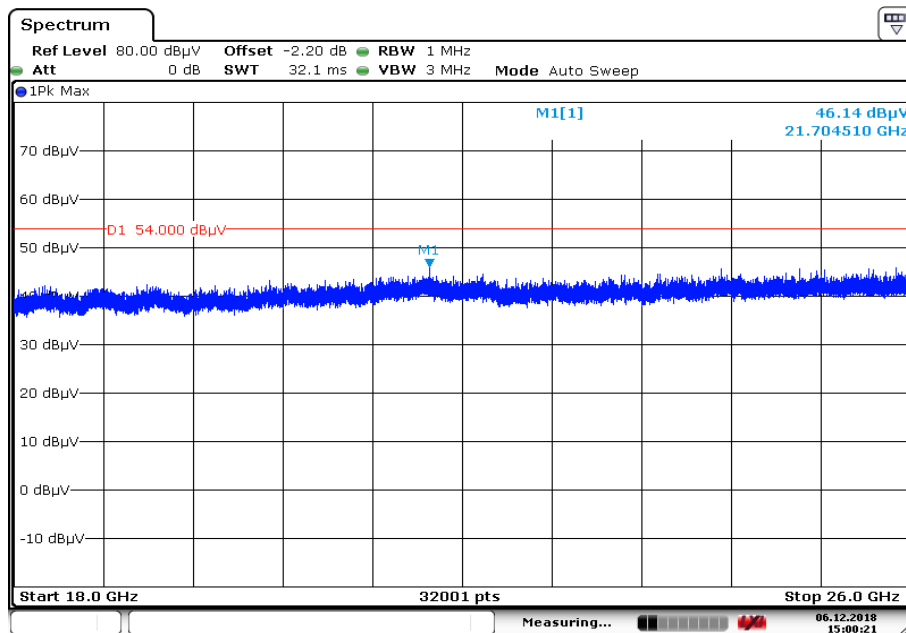

Date: 6 DEC 2018 15:00:21

Plot 11: 1 GHz to 18 GHz, TX mode, 2480 MHz, vertical & horizontal polarization, 2 Msps

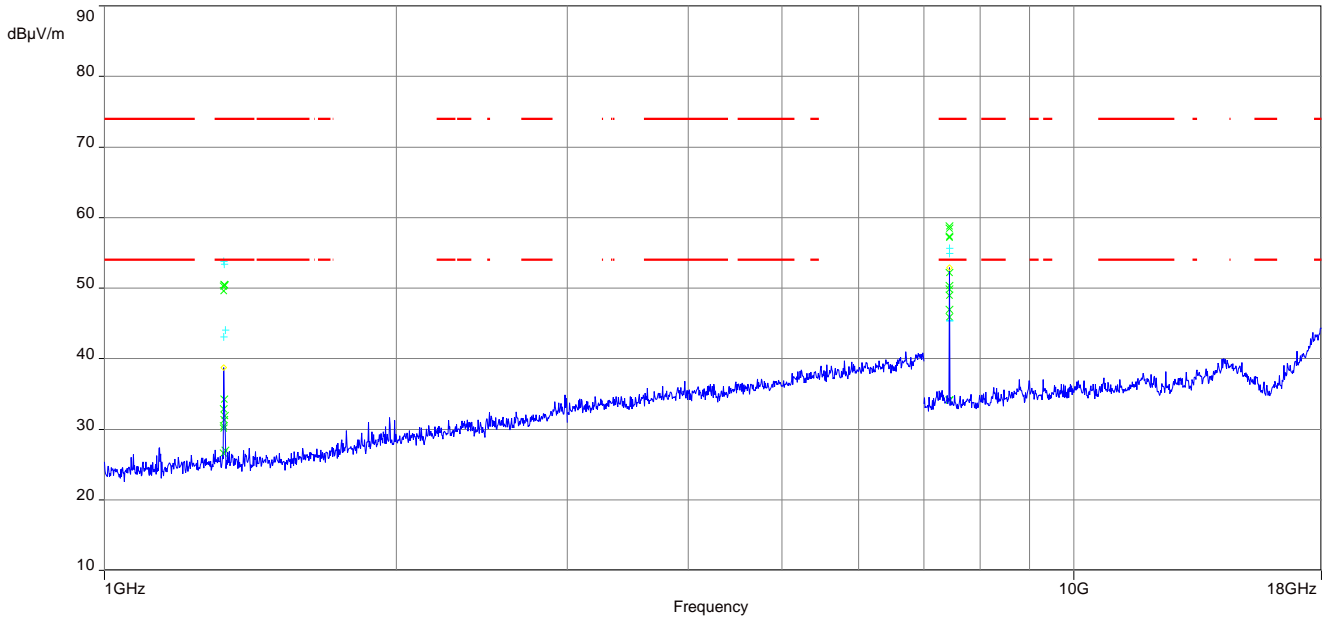

The carrier signal is notched with a 2.4 GHz band rejection filter.

Plot 12: 18 GHz to 26 GHz, TX mode, 2480 MHz, vertical & horizontal polarization, 2 Msps

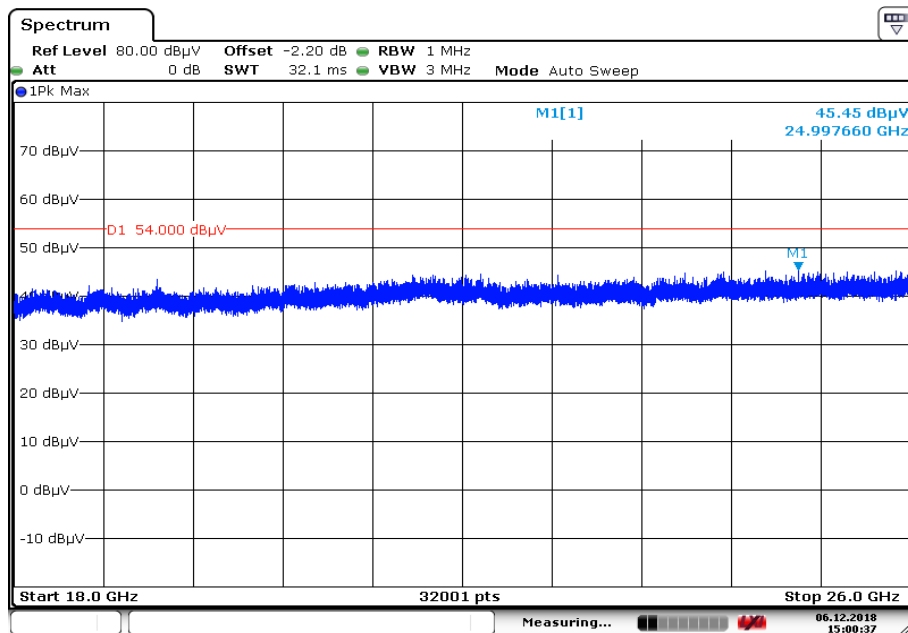

Date: 6 DEC 2018 15:00:36

Plots: Receiver mode

Plot 1: 1 GHz to 18 GHz, RX / idle – mode, vertical & horizontal polarization

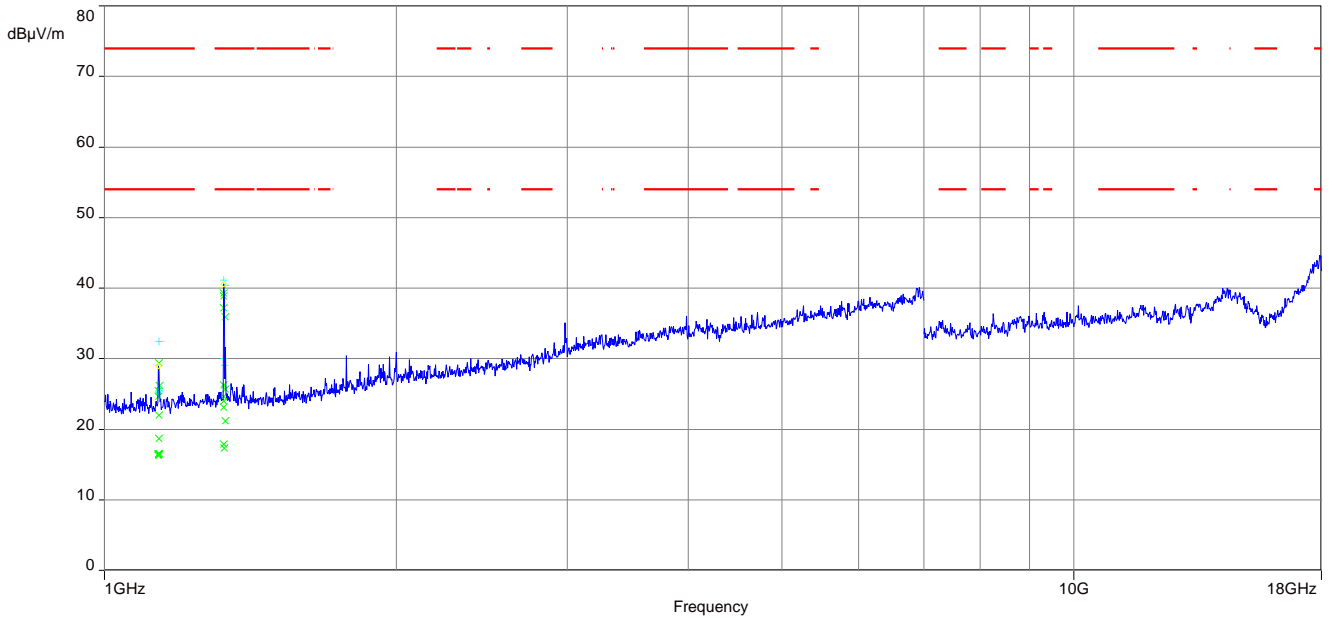

Plot 2: 18 GHz to 26 GHz, RX / idle – mode, vertical & horizontal polarization

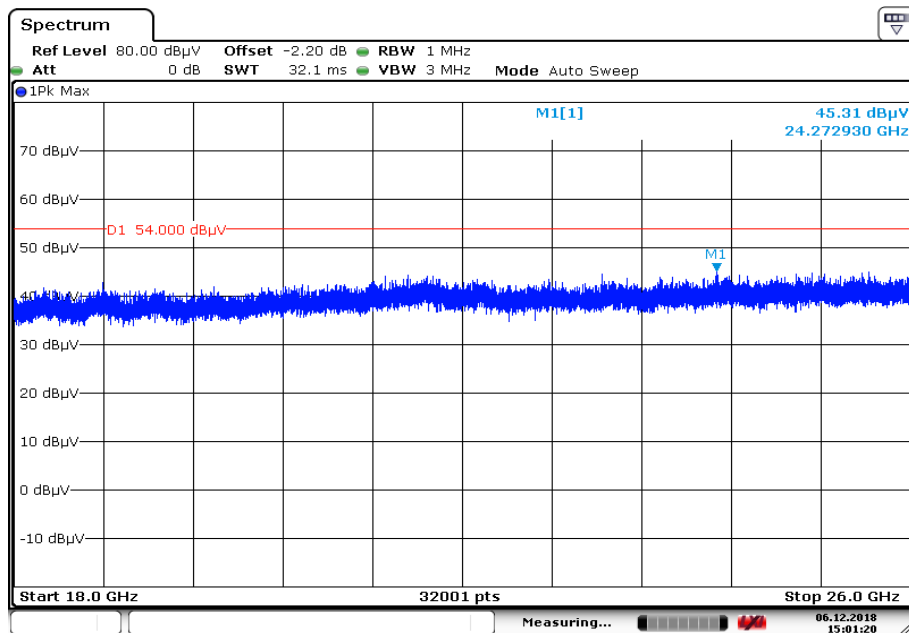

Date: 6 DEC 2018 15:01:21

11.12 Spurious emissions conducted below 30 MHz (AC conducted)

Description:

Measurement of the conducted spurious emissions in transmit mode below 30 MHz. The EUT is set to single channel mode and the transmit frequency is 2440 MHz. This measurement is representative for all channels and modes. If critical peaks are found frequency 2402 MHz and 2480 MHz will be measured too. The measurement is performed in the mode with the highest output power. Both power lines, phase and neutral line, are measured. Found peaks are remeasured with average and quasi peak detection to show compliance to the limits.

| Measurement parameters | |
|-------------------------|--|
| Detector | Peak - Quasi peak / average |
| Sweep time | Auto |
| Resolution bandwidth | F < 150 kHz: 200 Hz F > 150 kHz: 9 kHz |
| Video bandwidth | F < 150 kHz: 1 kHz F > 150 kHz: 100 kHz |
| Span: | 9 kHz to 30 MHz |
| Trace mode: | Max hold |
| Test setup | See sub clause 7.5. A |
| Measurement uncertainty | See sub clause 8 |

Limits:

| FCC | | IC | |
|--|---------------------------|------------------------|--|
| TX spurious emissions conducted < 30 MHz | | | |
| Frequency (MHz) | Quasi-peak (dB μ V/m) | Average (dB μ V/m) | |
| 0.15 – 0.5 | 66 to 56* | 56 to 46* | |
| 0.5 – 5 | 56 | 46 | |
| 5 – 30.0 | 60 | 50 | |

*Decreases with the logarithm of the frequency

Results:

| Spurious emissions conducted < 30 MHz [dB μ V/m] | | |
|--|----------|----------------------|
| F [MHz] | Detector | Level [dB μ V/m] |
| No emissions detected | | |
| | | |
| | | |

Plots:

Plot 1: 150 kHz to 30 MHz, phase line

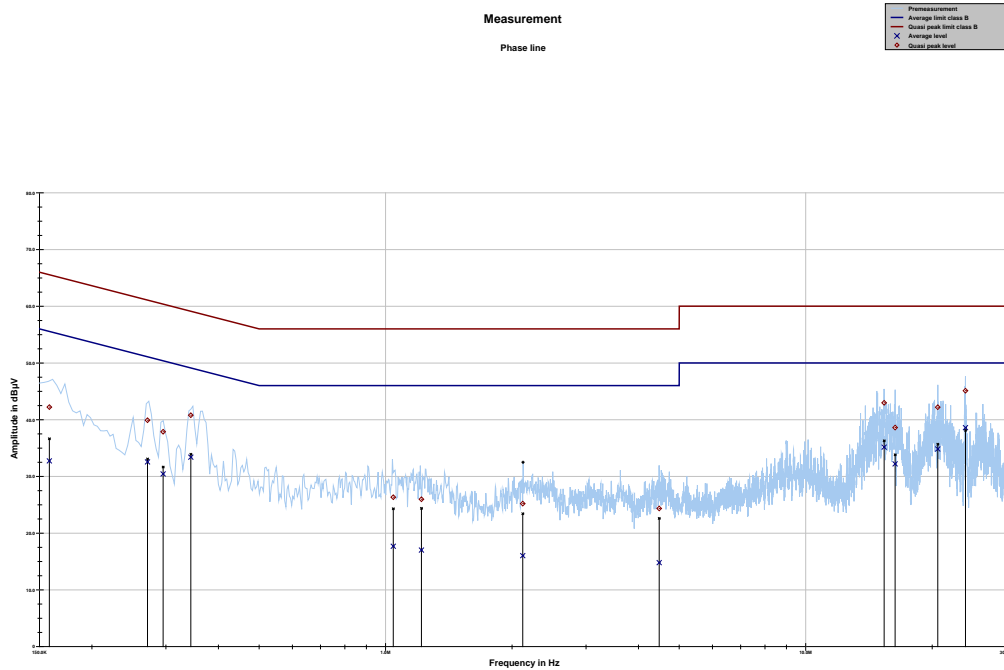

Final results:

| Frequency | Quasi peak level | Margin quasi peak | Limit QP | Average level | Margin average | Limit AV |
|-----------|------------------|-------------------|----------|---------------|----------------|----------|
| MHz | dBµV | dB | dBµV | dBµV | dB | dBµV |
| 0.158400 | 42.21 | 23.34 | 65.547 | 32.73 | 23.03 | 55.760 |
| 0.271199 | 39.90 | 21.18 | 61.081 | 32.55 | 19.99 | 52.537 |
| 0.295478 | 37.87 | 22.50 | 60.369 | 30.43 | 21.41 | 51.843 |
| 0.343890 | 40.78 | 18.32 | 59.109 | 33.38 | 17.08 | 50.460 |
| 1.042956 | 26.33 | 29.67 | 56.000 | 17.69 | 28.31 | 46.000 |
| 1.216904 | 25.97 | 30.03 | 56.000 | 17.01 | 28.99 | 46.000 |
| 2.121311 | 25.20 | 30.80 | 56.000 | 16.03 | 29.97 | 46.000 |
| 4.479615 | 24.35 | 31.65 | 56.000 | 14.80 | 31.20 | 46.000 |
| 15.369555 | 42.97 | 17.03 | 60.000 | 35.16 | 14.84 | 50.000 |
| 16.325692 | 38.60 | 21.40 | 60.000 | 32.21 | 17.79 | 50.000 |
| 20.627188 | 42.19 | 17.81 | 60.000 | 34.83 | 15.17 | 50.000 |
| 24.000734 | 45.11 | 14.89 | 60.000 | 38.58 | 11.42 | 50.000 |

Plot 2: 150 kHz to 30 MHz, neutral line

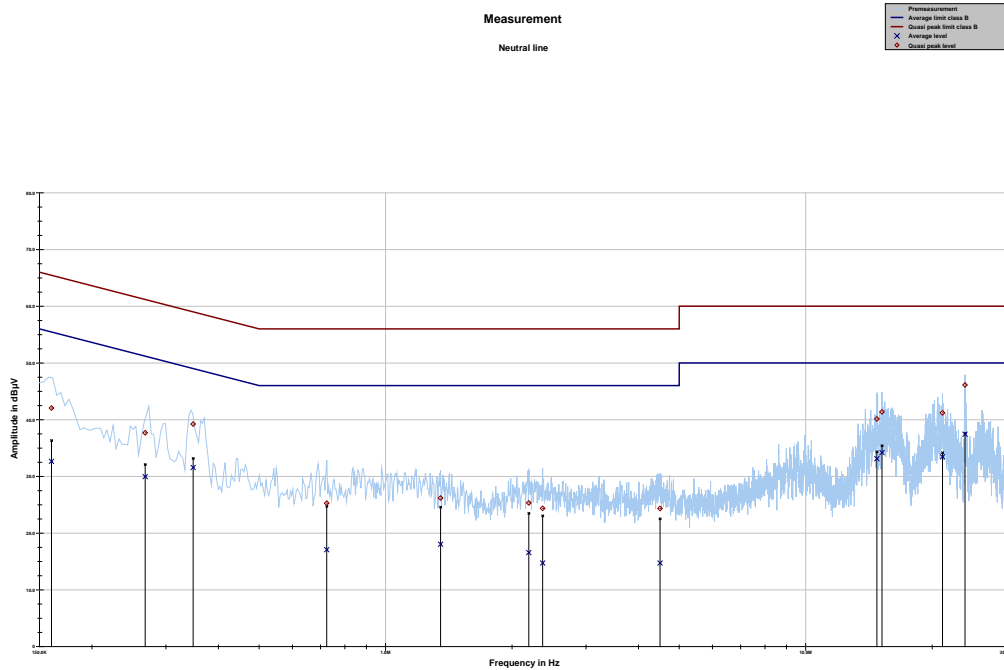

Project ID: 1-6927/18-02-02

Final results:

| Frequency | Quasi peak level | Margin quasi peak | Limit QP | Average level | Margin average | Limit AV |
|-----------|------------------|-------------------|----------|---------------|----------------|----------|
| MHz | dBµV | dB | dBµV | dBµV | dB | dBµV |
| 0.160250 | 42.05 | 23.40 | 65.451 | 32.65 | 23.06 | 55.707 |
| 0.267834 | 37.68 | 23.50 | 61.185 | 29.96 | 22.67 | 52.633 |
| 0.348249 | 39.23 | 19.77 | 59.004 | 31.56 | 18.78 | 50.336 |
| 0.724190 | 25.29 | 30.71 | 56.000 | 17.08 | 28.92 | 46.000 |
| 1.351616 | 26.19 | 29.81 | 56.000 | 18.04 | 27.96 | 46.000 |
| 2.192130 | 25.32 | 30.68 | 56.000 | 16.57 | 29.43 | 46.000 |
| 2.364548 | 24.37 | 31.63 | 56.000 | 14.72 | 31.28 | 46.000 |
| 4.500540 | 24.35 | 31.65 | 56.000 | 14.73 | 31.27 | 46.000 |
| 14.772940 | 40.13 | 19.87 | 60.000 | 33.13 | 16.87 | 50.000 |
| 15.192790 | 41.37 | 18.63 | 60.000 | 34.19 | 15.81 | 50.000 |
| 21.171827 | 41.20 | 18.80 | 60.000 | 33.46 | 16.54 | 50.000 |
| 23.940779 | 46.12 | 13.88 | 60.000 | 37.45 | 12.55 | 50.000 |

Annex A Glossary

| | |
|------------------------|--|
| EUT | Equipment under test |
| DUT | Device under test |
| UUT | Unit under test |
| GUE | GNSS User Equipment |
| ETSI | European Telecommunications Standards Institute |
| EN | European Standard |
| FCC | Federal Communications Commission |
| FCC ID | Company Identifier at FCC |
| IC | Industry Canada |
| PMN | Product marketing name |
| HMN | Host marketing name |
| HVIN | Hardware version identification number |
| FVIN | Firmware version identification number |
| EMC | Electromagnetic Compatibility |
| HW | Hardware |
| SW | Software |
| Inv. No. | Inventory number |
| S/N or SN | Serial number |
| C | Compliant |
| NC | Not compliant |
| NA | Not applicable |
| NP | Not performed |
| PP | Positive peak |
| QP | Quasi peak |
| AVG | Average |
| OC | Operating channel |
| OCW | Operating channel bandwidth |
| OBW | Occupied bandwidth |
| OOB | Out of band |
| DFS | Dynamic frequency selection |
| CAC | Channel availability check |
| OP | Occupancy period |
| NOP | Non occupancy period |
| DC | Duty cycle |
| PER | Packet error rate |
| CW | Clean wave |
| MC | Modulated carrier |
| WLAN | Wireless local area network |
| RLAN | Radio local area network |
| DSSS | Dynamic sequence spread spectrum |
| OFDM | Orthogonal frequency division multiplexing |
| FHSS | Frequency hopping spread spectrum |
| GNSS | Global Navigation Satellite System |
| C/N₀ | Carrier to noise-density ratio, expressed in dB-Hz |

Annex B Document history

| Version | Applied changes | Date of release |
|---------|--|-----------------|
| -/- | Initial release | 2019-01-09 |
| A | FCC ID, ISED number and HVIN changed and editorial changes | 2019-03-13 |
| B | HVIN, PMN changed and editorial changes | 2019-03-17 |

Annex C Accreditation Certificate – D-PL-12076-01-04

| first page | last page |
|--|--|
|  <p>Deutsche Akkreditierungsstelle GmbH</p> <p>Entrusted according to Section 8 subsection 1 AkkStelleG in connection with Section 1 subsection 1 AkkStelleGBV Signatory to the Multilateral Agreements of EA, ILAC and IAF for Mutual Recognition</p> <p>Accreditation </p> <p>The Deutsche Akkreditierungsstelle GmbH attests that the testing laboratory CTC advanced GmbH Untertürkheimer Straße 6-10, 66117 Saarbrücken</p> <p>is competent under the terms of DIN EN ISO/IEC 17025:2005 to carry out tests in the following fields: Telecommunication (TC) and Electromagnetic Compatibility (EMC) for Canadian Standards</p> <p>The accreditation certificate shall only apply in connection with the notice of accreditation of 11.01.2019 with the accreditation number D-PL-12076-01 and is valid until 21.04.2021. It comprises the cover sheet, the reverse side of the cover sheet and the following annex with a total of 7 pages.</p> <p>Registration number of the certificate: D-PL-12076-01-04</p> <p>Frankfurt am Main, 11.01.2019  Dipl. Ing. Uwe Zimmermann Head of Division</p> | <p>Deutsche Akkreditierungsstelle GmbH</p> <p>Office Berlin Spittelmarkt 10 10117 Berlin</p> <p>Office Frankfurt am Main Europa-Allee 52 60327 Frankfurt am Main</p> <p>Office Braunschweig Bundesallee 100 38116 Braunschweig</p> <p>The publication of extracts of the accreditation certificate is subject to the prior written approval by Deutsche Akkreditierungsstelle GmbH (DAkKS). Exempted is the unchanged form of separate disseminations of the cover sheet by the conformity assessment body mentioned overleaf.</p> <p>No impression shall be made that the accreditation also extends to fields beyond the scope of accreditation attested by DAkKS.</p> <p>The accreditation was granted pursuant to the Act on the Accreditation Body (AkkStelleG) of 31 July 2009 (Federal Law Gazette I p. 2625) and the Regulation (EC) No 765/2008 of the European Parliament and of the Council of 9 July 2008 setting out the requirements for accreditation and market surveillance relating to the marketing of products (Official Journal of the European Union L 218 of 9 July 2008, p. 30). DAkKS is a signatory to the Multilateral Agreements for Mutual Recognition of the European co-operation for Accreditation (EA), International Accreditation Forum (IAF) and International Laboratory Accreditation Cooperation (ILAC). The signatories to these agreements recognise each other's accreditations.</p> <p>The up-to-date state of membership can be retrieved from the following websites: EA: www.european-accreditation.org ILAC: www.ilac.org IAF: www.iaf.nu</p> |

Note: The current certificate annex is published on the website (link see below) of the Accreditation Body DAkKS or may be received by CTC advanced GmbH on request

<https://www.dakks.de/as/ast/d/D-PL-12076-01-04.pdf>

Annex D Accreditation Certificate – D-PL-12076-01-05

| first page | last page | | | |
|---|---|--|--|--|
|  <p>Deutsche Akkreditierungsstelle GmbH</p> <p>Entrusted according to Section 8 subsection 1 AkkStelleG in connection with Section 1 subsection 1 AkkStelleGBV Signatory to the Multilateral Agreements of EA, ILAC and IAF for Mutual Recognition</p> <p>Accreditation </p> <p>The Deutsche Akkreditierungsstelle GmbH attests that the testing laboratory CTC advanced GmbH Untertürkheimer Straße 6-10, 66117 Saarbrücken</p> <p>is competent under the terms of DIN EN ISO/IEC 17025:2005 to carry out tests in the following fields: Telecommunication (FCC Requirements)</p> <p>The accreditation certificate shall only apply in connection with the notice of accreditation of 11.01.2019 with the accreditation number D-PL-12076-01 and is valid until 21.04.2021. It comprises the cover sheet, the reverse side of the cover sheet and the following annex with a total of 5 pages.</p> <p>Registration number of the certificate: D-PL-12076-01-05</p> <p>Frankfurt am Main, 11.01.2019  Uwe Zimmermann Head of Division</p> <p><small>See www.dakks.de</small></p> | <p>Deutsche Akkreditierungsstelle GmbH</p> <table border="0"> <tr> <td>Office Berlin Spittelmarkt 10 10117 Berlin</td> <td>Office Frankfurt am Main Europa-Allee 52 60327 Frankfurt am Main</td> <td>Office Braunschweig Bundesallee 100 38116 Braunschweig</td> </tr> </table> <p>The publication of extracts of the accreditation certificate is subject to the prior written approval by Deutsche Akkreditierungsstelle GmbH (DAkkS). Exempted is the unchanged form of separate disseminations of the cover sheet by the conformity assessment body mentioned overleaf.</p> <p>No impression shall be made that the accreditation also extends to fields beyond the scope of accreditation attested by DAkkS.</p> <p>The accreditation was granted pursuant to the Act on the Accreditation Body (AkkStelleG) of 31 July 2009 (Federal Law Gazette I p. 2625) and the Regulation (EC) No 765/2008 of the European Parliament and of the Council of 9 July 2008 setting out the requirements for accreditation and market surveillance relating to the marketing of products (Official Journal of the European Union L 218 of 9 July 2008, p. 30). DAkkS is a signatory to the Multilateral Agreements for Mutual Recognition of the European co-operation for Accreditation (EA), International Accreditation Forum (IAF) and International Laboratory Accreditation Cooperation (ILAC). The signatories to these agreements recognise each other's accreditations.</p> <p>The up-to-date state of membership can be retrieved from the following websites: EA: www.european-accreditation.org ILAC: www.ilac.org IAF: www.iaf.nu</p> | Office Berlin Spittelmarkt 10 10117 Berlin | Office Frankfurt am Main Europa-Allee 52 60327 Frankfurt am Main | Office Braunschweig Bundesallee 100 38116 Braunschweig |
| Office Berlin Spittelmarkt 10 10117 Berlin | Office Frankfurt am Main Europa-Allee 52 60327 Frankfurt am Main | Office Braunschweig Bundesallee 100 38116 Braunschweig | | |

Note: The current certificate annex is published on the website (link see below) of the Accreditation Body DAkkS or may be received by CTC advanced GmbH on request

<https://www.dakks.de/as/ast/d/D-PL-12076-01-05.pdf>

END OF TEST REPORT