



TEST REPORT

Test report no.: 1-6927/18-01-03



BNetzA-CAB-02/21-102

Testing laboratory

CTC advanced GmbH

Untertuerkheimer Strasse 6 – 10

66117 Saarbruecken / Germany

Phone: + 49 681 5 98 - 0

Fax: + 49 681 5 98 - 9075

Internet: <http://www.ctcadvanced.com>

e-mail: mail@ctcadvanced.com

Accredited Testing Laboratory:

The testing laboratory (area of testing) is accredited according to DIN EN ISO/IEC 17025 (2005) by the Deutsche Akkreditierungsstelle GmbH (DAkkS)

The accreditation is valid for the scope of testing procedures as stated in the accreditation certificate with the registration number: D-PL-12076-01-04 and D-PL-12076-01-05

Applicant

Ingenico Group

9 Avenue de la Gare Rovaltain

26958 Valence Cedex 9 / FRANCE

Phone: -/-

Contact: Nicolas Jacquemont

e-mail: nicolas.jacquemont@ingenico.com

Phone: +33 4 75 84 21 23

Manufacturer

Ingenico Group

9 Avenue de la Gare Rovaltain

26958 Valence Cedex 9 / FRANCE

Test standard/s

FCC - Title 47 CFR Part 22

FCC - Title 47 of the Code of Federal Regulations; Chapter I; Part 22 - Public mobile services

FCC - Title 47 CFR Part 24

FCC - Title 47 of the Code of Federal Regulations; Chapter I; Part 24 - Personal communications services

FCC - Title 47 CFR Part 27

FCC - Title 47 of the Code of Federal Regulations; Chapter I; Part 27 - Miscellaneous wireless communications services

For further applied test standards please refer to section 3 of this test report.

Test Item

Kind of test item: Payment terminal
Model name: AXIUM D7 CL/4G/WIFI/BT
FCC ID: XKB-AXICL4GWBT
IC: 2586D-AXICL4GWBT
Frequency: GSM850, PCS1900, WCDMA band 2, 4, 5
Technology tested: GSM, WCDMA
Antenna: Integrated antenna
Power supply: 3.7 V DC by Li-polymer battery
 115 V AC by mains adapter
Temperature range: 0°C to +50°C



This test report is electronically signed and valid without handwritten signature. For verification of the electronic signatures, the public keys can be requested at the testing laboratory.

Test report authorized:

Marco Bertolino
Lab Manager
Radio Communications & EMC

Test performed:

Andreas Luckenbill
Lab Manager
Radio Communications & EMC

1 Table of contents

1	Table of contents	2
2	General information	3
2.1	Notes and disclaimer	3
2.2	Application details.....	3
2.3	Test laboratories sub-contracted	3
3	Test standard/s and references	4
4	Test environment.....	5
5	Test item.....	5
5.1	General description	5
5.2	Additional information	5
6	Description of the test setup.....	6
6.1	Shielded semi anechoic chamber.....	7
6.2	Shielded fully anechoic chamber	8
6.3	Radiated measurements > 18 GHz.....	9
6.4	Conducted measurements	10
7	Measurement uncertainty	11
8	Summary of measurement results	12
8.1	GSM 850.....	12
8.2	PCS 1900	12
8.3	UMTS band II.....	13
8.4	UMTS band IV.....	13
8.5	UMTS band V.....	14
9	Results GSM 850	15
9.1	RF output power	15
9.2	Spurious emissions radiated	21
10	Results PCS 1900.....	27
10.1	RF output power	27
10.2	Spurious emissions radiated.....	33
11	Results UMTS band II	39
11.1	RF output power	39
11.2	Spurious emissions radiated.....	43
12	Results UMTS band IV.....	47
12.1	RF output power	47
12.2	Spurious emissions radiated.....	51
13	Results UMTS band V.....	55
13.1	RF output power	55
13.2	Spurious emissions radiated.....	59
Annex A	Glossary.....	63
Annex B	Document history	64
Annex C	Accreditation Certificate – D-PL-12076-01-04	64
Annex D	Accreditation Certificate – D-PL-12076-01-05	65

2 General information

2.1 Notes and disclaimer

The test results of this test report relate exclusively to the test item specified in this test report. CTC advanced GmbH does not assume responsibility for any conclusions and generalizations drawn from the test results with regard to other specimens or samples of the type of the equipment represented by the test item.

The test report may only be reproduced or published in full. Reproduction or publication of extracts from the report requires the prior written approval of CTC advanced GmbH.

The testing service provided by CTC advanced GmbH has been rendered under the current "General Terms and Conditions for CTC advanced GmbH".

CTC advanced GmbH will not be liable for any loss or damage resulting from false, inaccurate, inappropriate or incomplete product information provided by the customer.

Under no circumstances does the CTC advanced GmbH test report include any endorsement or warranty regarding the functionality, quality or performance of any other product or service provided.

Under no circumstances does the CTC advanced GmbH test report include or imply any product or service warranties from CTC advanced GmbH, including, without limitation, any implied warranties of merchantability, fitness for purpose, or non-infringement, all of which are expressly disclaimed by CTC advanced GmbH.

All rights and remedies regarding vendor's products and services for which CTC advanced GmbH has prepared this test report shall be provided by the party offering such products or services and not by CTC advanced GmbH. In no case this test report can be considered as a Letter of Approval.

This test report is electronically signed and valid without handwritten signature. For verification of the electronic signatures, the public keys can be requested at the testing laboratory.

2.2 Application details

Date of receipt of order:	2018-09-21
Date of receipt of test item:	2018-10-23
Start of test:	2018-10-23
End of test:	2019-04-08
Person(s) present during the test:	-/-

2.3 Test laboratories sub-contracted

None

3 Test standard/s and references

Test standard	Date	Description
FCC - Title 47 CFR Part 22		FCC - Title 47 of the Code of Federal Regulations; Chapter I; Part 22 - Public mobile services
FCC - Title 47 CFR Part 24		FCC - Title 47 of the Code of Federal Regulations; Chapter I; Part 24 - Personal communications services
FCC - Title 47 CFR Part 27		FCC - Title 47 of the Code of Federal Regulations; Chapter I; Part 27 - Miscellaneous wireless communications services
RSS - 132 Issue 3	January 2013	Spectrum Management and Telecommunications Radio Standards Specification - Cellular Telephone Systems Operating in the Bands 824-849 MHz and 869-894 MHz
RSS - 133 Issue 6	January 2018	Spectrum Management and Telecommunications Policy - Radio Standards Specifications, 2 GHz Personal Communication Services
RSS - 139 Issue 3	July 2015	Spectrum Management and Telecommunications Radio Standards Specification - Advanced Wireless Services (AWS) Equipment Operating in the Bands 1710-1755 MHz and 2110-2180 MHz

Guidance	Version	Description
ANSI C63.4-2014	-/-	American national standard for methods of measurement of radio-noise emissions from low-voltage electrical and electronic equipment in the range of 9 kHz to 40 GHz
ANSI C63.26-2015	-/-	American National Standard for Compliance Testing of Transmitters Used in Licensed Radio Services
Power Meas License Systems: KDB 971168 D01	v03r01	Measurement Guidance for Certification of Licensed Digital Transmitters

4 Test environment

Temperature	:	T_{nom} T_{max} T_{min}	+22 °C during room temperature tests No tests under extreme temperature conditions required. No tests under extreme temperature conditions required.
Relative humidity content	:		55 %
Barometric pressure	:		1021 hpa
Power supply	:	V_{nom} V_{max} V_{min}	3.7 V DC by Li-polymer battery 115 V AC by mains adapter No tests under extreme voltage conditions required. No tests under extreme voltage conditions required.

5 Test item

5.1 General description

Kind of test item	:	Payment terminal
Type identification	:	AXIUM D7 CL/4G/WIFI/BT
HMN	:	-/-
PMN	:	Axium D7
HVIN	:	AXIUM D7 CL/4G/WIFI/BT
FVIN	:	4.19.1
S/N serial number	:	Rad. 182677314201129703190743 Cond. 182677314201129703192770
Hardware status	:	296230079
Software status	:	4.19.1
Firmware status	:	-/-
Frequency band	:	GSM850, PCS1900, WCDMA band 2, 4, 5
Type of modulation	:	GMSK, 8-PSK, BPSK, QPSK
Antenna	:	Integrated antenna
Power supply	:	3.7 V DC by Li-polymer battery
Temperature range	:	0°C to +50°C

5.2 Additional information

The content of the following annexes is defined in the QA. It may be that not all of the listed annexes are necessary for this report, thus some values in between may be missing.

Test setup and EUT photos are included in test report:

- 1-6927/18-01-01_AnnexA
- 1-6927/18-01-01_AnnexB
- 1-6927/18-01-01_AnnexD

6 Description of the test setup

Typically, the calibrations of the test apparatus are commissioned to and performed by an accredited calibration laboratory. The calibration intervals are determined in accordance with the DIN EN ISO/IEC 17025. In addition to the external calibrations, the laboratory executes comparison measurements with other calibrated test systems or effective verifications. Weekly chamber inspections and range calibrations are performed. Where possible, RF generating and signaling equipment as well as measuring receivers and analyzers are connected to an external high-precision 10 MHz reference (GPS-based or rubidium frequency standard).

In order to simplify the identification of the equipment used at some special tests, some items of test equipment and ancillaries can be provided with an identifier or number in the equipment list below (Lab/Item).

Agenda: Kind of Calibration

k	calibration / calibrated	EK	limited calibration
ne	not required (k, ev, izw, zw not required)	zw	cyclical maintenance (external cyclical maintenance)
ev	periodic self verification	izw	internal cyclical maintenance
Ve	long-term stability recognized	g	blocked for accredited testing
v/k!	Attention: extended calibration interval		
NK!	Attention: not calibrated	*)	next calibration ordered / currently in progress

6.1 Shielded semi anechoic chamber

The radiated measurements are performed in vertical and horizontal plane in the frequency range from 30 MHz to 1 GHz in semi-anechoic chambers. The EUT is positioned on a non-conductive support with a height of 0.80 m above a conductive ground plane that covers the whole chamber. The receiving antennas are conform to specifications ANSI C63. These antennas can be moved over the height range between 1.0 m and 4.0 m in order to search for maximum field strength emitted from EUT. The measurement distances between EUT and receiving antennas are indicated in the test setups for the various frequency ranges. For each measurement, the EUT is rotated in all three axes until the maximum field strength is received. The wanted and unwanted emissions are received by spectrum analyzers where the detector modes and resolution bandwidths over various frequency ranges are set according to requirement ANSI C63.



Measurement distance: tri-log antenna 10 meter
EMC32 software version: 10.30.0

FS = UR + CL + AF
(FS-field strength; UR-voltage at the receiver; CL-loss of the cable; AF-antenna factor)

Example calculation:

FS [dBµV/m] = 12.35 [dBµV/m] + 1.90 [dB] + 16.80 [dB/m] = 31.05 [dBµV/m] (35.69 µV/m)

Equipment table:

No.	Lab / Item	Equipment	Type	Manufacturer	Serial No.	INV. No.	Kind of Calibration	Last Calibration	Next Calibration
1	A	Universal Radio Communication Tester	CMU200	R&S	832221/055	300002862	NK!	-/-	-/-
2	B	Wideband Radio Communication Tester	CMW500	R&S	102375	300004187	ne	-/-	-/-
3	A, B	Switch-Unit	3488A	HP	2719A14505	300000368	ev	-/-	-/-
4	A, B	Meßkabine 1	HF-Absorberhalle	MWB AG 300023		300000551	ne	-/-	-/-
5	A, B	EMI Test Receiver	ESCI 3	R&S	100083	300003312	k	12.12.2018	11.12.2019
6	A, B	Antenna Tower	Model 2175	ETS-Lindgren	64762	300003745	izw	-/-	-/-
7	A, B	Positioning Controller	Model 2090	ETS-Lindgren	64672	300003746	izw	-/-	-/-
8	A, B	Turntable Interface-Box	Model 105637	ETS-Lindgren	44583	300003747	izw	-/-	-/-
9	A, B	TRILOG Broadband Test-Antenna 30 MHz - 3 GHz	VULB9163	Schwarzbeck Mess - Elektronik	371	300003854	vIK!	24.11.2017	23.11.2020

6.2 Shielded fully anechoic chamber

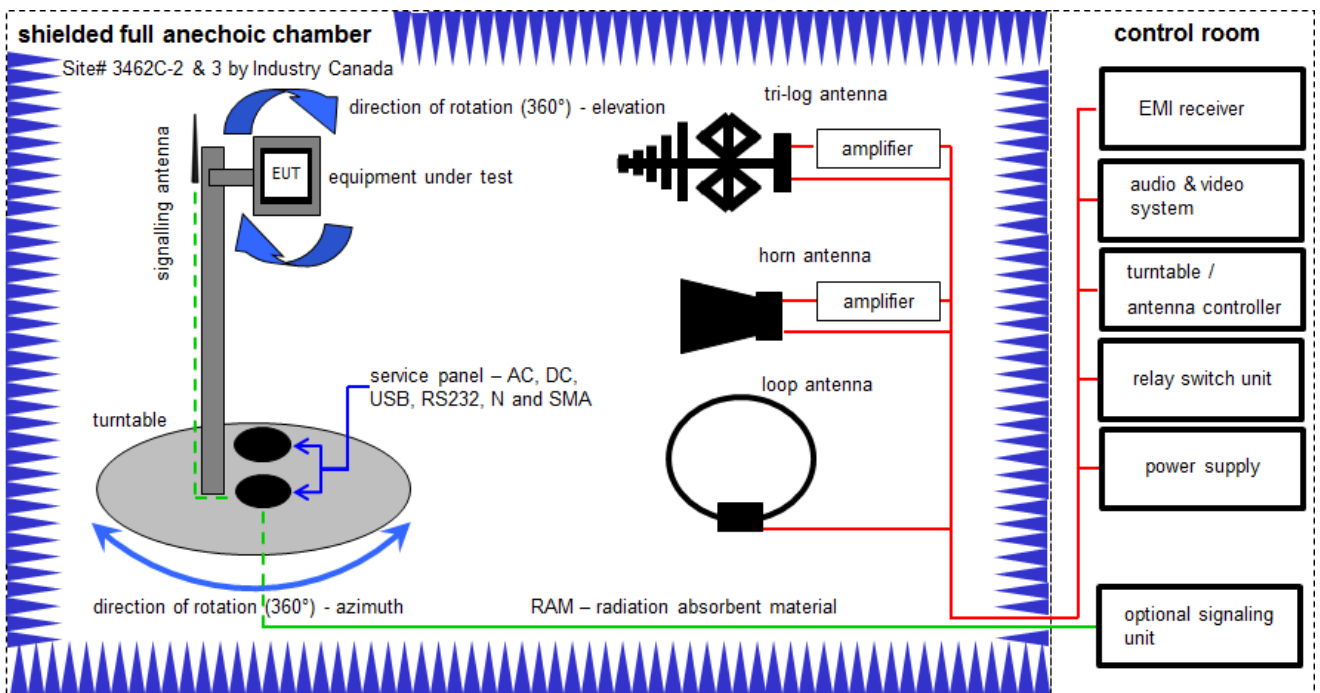

Measurement distance: tri-log antenna and horn antenna 3 meter; loop antenna 3 meter

$$OP = AV + D - G + CA$$

(OP-radiated output power; AV-analyzer value; D-free field attenuation of measurement distance; G-antenna gain+amplifier gain; CA-loss signal path)

Example calculation:

$$OP [dBm] = -65.0 [dBm] + 50 [dB] - 20 [dBi] + 5 [dB] = -30 [dBm] (1 \mu W)$$

Equipment table:

No.	Lab / Item	Equipment	Type	Manufacturer	Serial No.	INV. No.	Kind of Calibration	Last Calibration	Next Calibration
1	C	Active Loop Antenna 9 kHz to 30 MHz	6502	EMCO	2210	300001015	vKI!	07.07.2017	06.07.2019
2	A, B, C	Anechoic chamber	FAC 3/5m	MWB / TDK	87400/02	300000996	ev	-/-	-/-
3	A, B	Double-Ridged Waveguide Horn Antenna 1-18.0GHz	3115	EMCO	8812-3088	300001032	vKI!	07.07.2017	06.07.2019
4	A, B, C	Switch / Control Unit	3488A	HP	*	300000199	ne	-/-	-/-
5	A	Band Reject filter	WRCG1850/1910- 1835/1925-40/8SS	Wainwright	7	300003350	ev	-/-	-/-
6	A	Highpass Filter	WHKX2.9/18G- 12SS	Wainwright	1	300003492	ev	-/-	-/-
7	A, B, C	EMI Test Receiver 9kHz-26,5GHz	ESR26	R&S	101376	300005063	k	19.12.2018	18.12.2019
8	A	Highpass Filter	WHK1.1/15G-10SS	Wainwright	3	300003255	ev	-/-	-/-
9	A	Highpass Filter	WHKX7.0/18G-8SS	Wainwright	19	300003790	ne	-/-	-/-
10	A	Broadband Amplifier 0.5-18 GHz	CBLU5184540	CERNEX	22049	300004481	ev	-/-	-/-
11	A, B, C	4U RF Switch Platform	L4491A	Agilent Technologies	MY50000037	300004509	ne	-/-	-/-
12	A, B, C	NEXIO EMV- Software	BAT EMC V3.16.0.49	EMCO		300004682	ne	-/-	-/-
13	A, B, C	PC	ExOne	F+W		300004703	ne	-/-	-/-
14	A, B, C	Wideband Radio Communication Tester	CMW500	R&S	102375	300004187	ne	-/-	-/-
15	A, B, C	Universal Radio Communication Tester	CMU200	R&S	832221/055	300002862	NK!	-/-	-/-

6.3 Radiated measurements > 18 GHz

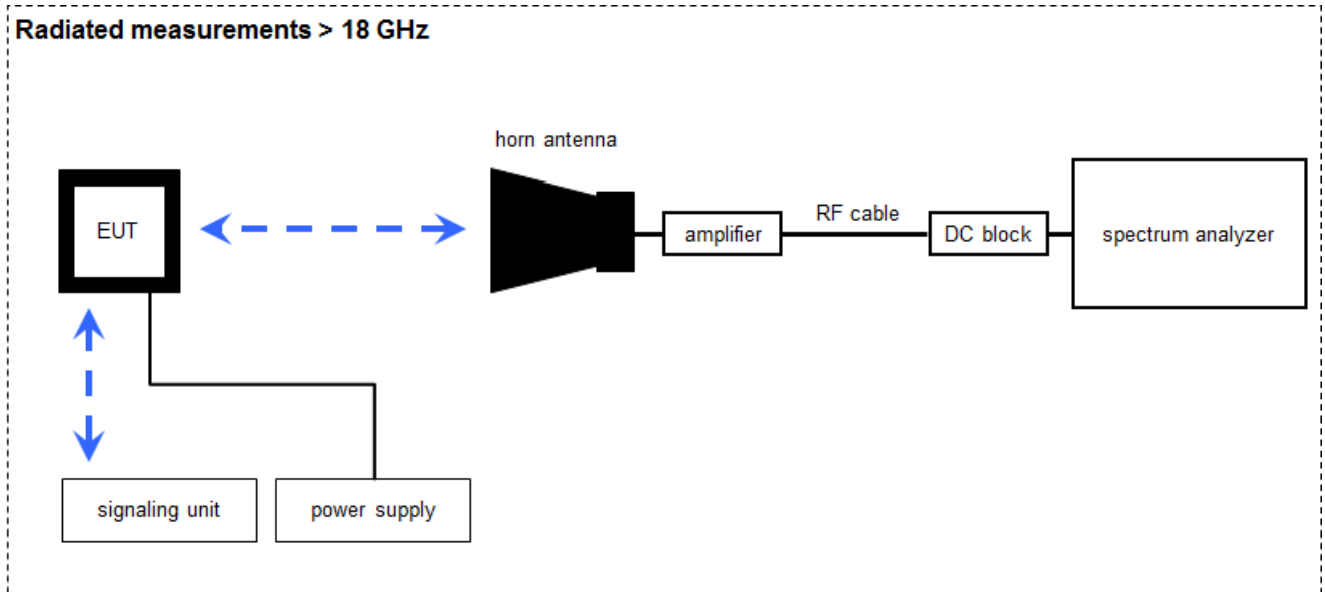

Measurement distance: horn antenna 50 cm

$$OP = AV + D - G + CA$$

(OP-radiated output power; AV-analyzer value; D-free field attenuation of measurement distance; G-antenna gain+amplifier gain; CA-loss signal path)

Example calculation:

$$OP \text{ [dBm]} = -65.0 \text{ [dBm]} + 50.0 \text{ [dB]} - 20.0 \text{ [dBi]} + 5.0 \text{ [dB]} = -30 \text{ [dBm]} (1 \mu\text{W})$$

Equipment table:

No.	Lab / Item	Equipment	Type	Manufacturer	Serial No.	INV. No.	Kind of Calibration	Last Calibration	Next Calibration
1	A	Microwave System Amplifier, 0.5-26.5 GHz	83017A	HP	00419	300002268	ev	-/-	-/-
2	A	Std. Gain Horn Antenna 18.0-26.5 GHz	638	Narda	01096	300000486	vKII	13.12.2017	12.12.2019
3	A	Signal Analyzer 40 GHz	FSV40	R&S	101042	300004517	k	17.12.2018	16.12.2019
4	A	RF-Cable	ST18/SMAm/SMAm/48	Huber & Suhner	Batch no. 600918	400001182	ev	-/-	-/-
5	A	RF-Cable	ST18/SMAm/SMAm/48	Huber & Suhner	Batch no. 127377	400001183	ev	-/-	-/-
6	A	DC-Blocker 0.1-40 GHz	8141A	Inmet	-/-	400001185	ev	-/-	-/-
7	A	Universal Radio Communication Tester	CMU200	R&S	832221/055	300002862	NK!	-/-	-/-
8	A	Wideband Radio Communication Tester	CMW500	R&S	102375	300004187	ne	-/-	-/-

6.4 Conducted measurements

Conducted measurements normal conditions

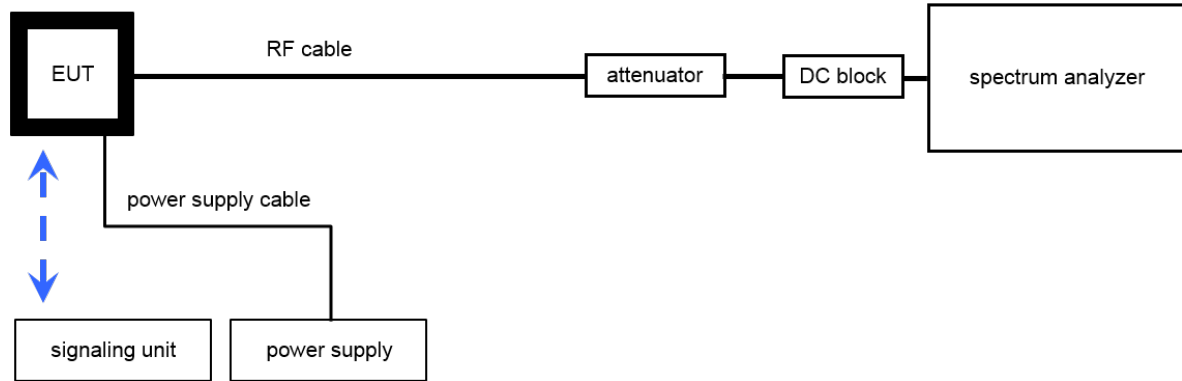

OP = AV + CA
(OP-output power; AV-analyzer value; CA-loss signal path)

Example calculation:

OP [dBm] = 6.0 [dBm] + 11.7 [dB] = 17.7 [dBm] (58.88 mW)

Equipment table:

No.	Lab / Item	Equipment	Type	Manufacturer	Serial No.	INV. No.	Kind of Calibration	Last Calibration	Next Calibration
1	A, B	Hygro-Thermometer	-/, 5-45°C, 20-100%rF	Thies Clima	-/-	400000108	ev	11.05.2018	10.05.2020
2	B	Wideband Radio Communication Tester	CMW500	R&S	102375	300004187	ne	-/-	-/-
3	A, B	Signal Analyzer 40 GHz	FSV40	R&S	101042	300004517	k	17.12.2018	16.12.2019
4	A, B	PC Tester R005	Intel Core i3 3220/3,3 GHz, Prozessor	-/-	2V2403033A4523	300004589	ne	-/-	-/-
5	A, B	Teststand	Teststand Custom Sequence Editor	National Instruments GmbH	-/-	300004590	ne	-/-	-/-
6	A, B	Resistive Power Dividers, DC-40 GHz, 1W	1575	MRC COMPONENTS	-/-	300004671	ne	-/-	-/-
7	A	USB-GPIB-Adapter	GPIB-USB-HS	National Instruments	1829974	400001136	ne	-/-	-/-
8	A, B	RF-Cable	ST18/SMAm/SMAm/72	Huber & Suhner	Batch no. 699714	400001184	ev	-/-	-/-
9	A, B	DC-Blocker 0.1-40 GHz	8141A	Inmet	-/-	400001185	ev	-/-	-/-
10	A, B	Synchron Power Meter	SPM-4	CTC	1	300005580	ev	-/-	-/-
11	A, B	RF-Cable	ST18/SMAm/SMAm/36	Huber & Suhner	Batch no. 601494	400001309	ev	-/-	-/-
12	A	Universal Radio Communication Tester	CMU200	R&S	832221/055	300002862	NK!	-/-	-/-

7 Measurement uncertainty

Measurement uncertainty	
Test case	Uncertainty
RF output power conducted	± 1 dB
RF output power radiated	± 3 dB
Frequency stability	± 20 Hz
Spurious emissions radiated below 30 MHz	± 3 dB
Spurious emissions radiated 30 MHz to 1 GHz	± 3 dB
Spurious emissions radiated 1 GHz to 12.75 GHz	± 3.7 dB
Spurious emissions radiated above 12.75 GHz	± 4.5 dB
Spurious emissions conducted	± 3 dB
Block edge compliance	± 3 dB
Occupied bandwidth	± RBW

8 Summary of measurement results

<input type="checkbox"/>	No deviations from the technical specifications were ascertained
<input type="checkbox"/>	There were deviations from the technical specifications ascertained
<input checked="" type="checkbox"/>	This test report is only a partial test report. The content and verdict of the performed test cases are listed below.

TC identifier	Description	verdict	date	Remark
RF-Testing	CFR Part 22, 24, 27 RSS 132, 133, 139	See table!	2019-04-24	Output power + radiated spurious only

8.1 GSM 850

Test Case	temperature conditions	power source voltages	C	NC	NA	NP	Remark
RF Output Power	Nominal	Nominal	<input checked="" type="checkbox"/>	<input type="checkbox"/>	<input type="checkbox"/>	<input type="checkbox"/>	-/-
Frequency Stability	Nominal	Nominal	<input type="checkbox"/>	<input type="checkbox"/>	<input type="checkbox"/>	<input checked="" type="checkbox"/>	-/-
Spurious Emissions Radiated	Nominal	Nominal	<input checked="" type="checkbox"/>	<input type="checkbox"/>	<input type="checkbox"/>	<input type="checkbox"/>	-/-
Spurious Emissions Conducted	Nominal	Nominal	<input type="checkbox"/>	<input type="checkbox"/>	<input type="checkbox"/>	<input checked="" type="checkbox"/>	-/-
Block Edge Compliance	Nominal	Nominal	<input type="checkbox"/>	<input type="checkbox"/>	<input type="checkbox"/>	<input checked="" type="checkbox"/>	-/-
Occupied Bandwidth	Nominal	Nominal	<input type="checkbox"/>	<input type="checkbox"/>	<input type="checkbox"/>	<input checked="" type="checkbox"/>	-/-

Note: C = Compliant; NC = Not compliant; NA = Not applicable; NP = Not performed

8.2 PCS 1900

Test Case	temperature conditions	power source voltages	C	NC	NA	NP	Remark
RF Output Power	Nominal	Nominal	<input checked="" type="checkbox"/>	<input type="checkbox"/>	<input type="checkbox"/>	<input type="checkbox"/>	-/-
Frequency Stability	Nominal	Nominal	<input type="checkbox"/>	<input type="checkbox"/>	<input type="checkbox"/>	<input checked="" type="checkbox"/>	-/-
Spurious Emissions Radiated	Nominal	Nominal	<input checked="" type="checkbox"/>	<input type="checkbox"/>	<input type="checkbox"/>	<input type="checkbox"/>	-/-
Spurious Emissions Conducted	Nominal	Nominal	<input type="checkbox"/>	<input type="checkbox"/>	<input type="checkbox"/>	<input checked="" type="checkbox"/>	-/-
Block Edge Compliance	Nominal	Nominal	<input type="checkbox"/>	<input type="checkbox"/>	<input type="checkbox"/>	<input checked="" type="checkbox"/>	-/-
Occupied Bandwidth	Nominal	Nominal	<input type="checkbox"/>	<input type="checkbox"/>	<input type="checkbox"/>	<input checked="" type="checkbox"/>	-/-

Note: C = Compliant; NC = Not compliant; NA = Not applicable; NP = Not performed

8.3 UMTS band II

Test Case	temperature conditions	power source voltages	C	NC	NA	NP	Remark
RF Output Power	Nominal	Nominal	<input checked="" type="checkbox"/>	<input type="checkbox"/>	<input type="checkbox"/>	<input type="checkbox"/>	-/-
Frequency Stability	Nominal	Nominal	<input type="checkbox"/>	<input type="checkbox"/>	<input type="checkbox"/>	<input checked="" type="checkbox"/>	-/-
Spurious Emissions Radiated	Nominal	Nominal	<input checked="" type="checkbox"/>	<input type="checkbox"/>	<input type="checkbox"/>	<input type="checkbox"/>	-/-
Spurious Emissions Conducted	Nominal	Nominal	<input type="checkbox"/>	<input type="checkbox"/>	<input type="checkbox"/>	<input checked="" type="checkbox"/>	-/-
Block Edge Compliance	Nominal	Nominal	<input type="checkbox"/>	<input type="checkbox"/>	<input type="checkbox"/>	<input checked="" type="checkbox"/>	-/-
Occupied Bandwidth	Nominal	Nominal	<input type="checkbox"/>	<input type="checkbox"/>	<input type="checkbox"/>	<input checked="" type="checkbox"/>	-/-

Note: C = Compliant; NC = Not compliant; NA = Not applicable; NP = Not performed

8.4 UMTS band IV

Test Case	temperature conditions	power source voltages	C	NC	NA	NP	Remark
RF Output Power	Nominal	Nominal	<input checked="" type="checkbox"/>	<input type="checkbox"/>	<input type="checkbox"/>	<input type="checkbox"/>	-/-
Frequency Stability	Nominal	Nominal	<input type="checkbox"/>	<input type="checkbox"/>	<input type="checkbox"/>	<input checked="" type="checkbox"/>	-/-
Spurious Emissions Radiated	Nominal	Nominal	<input checked="" type="checkbox"/>	<input type="checkbox"/>	<input type="checkbox"/>	<input type="checkbox"/>	-/-
Spurious Emissions Conducted	Nominal	Nominal	<input type="checkbox"/>	<input type="checkbox"/>	<input type="checkbox"/>	<input checked="" type="checkbox"/>	-/-
Block Edge Compliance	Nominal	Nominal	<input type="checkbox"/>	<input type="checkbox"/>	<input type="checkbox"/>	<input checked="" type="checkbox"/>	-/-
Occupied Bandwidth	Nominal	Nominal	<input type="checkbox"/>	<input type="checkbox"/>	<input type="checkbox"/>	<input checked="" type="checkbox"/>	-/-

Note: C = Compliant; NC = Not compliant; NA = Not applicable; NP = Not performed

8.5 UMTS band V

Test Case	temperature conditions	power source voltages	C	NC	NA	NP	Remark
RF Output Power	Nominal	Nominal	<input checked="" type="checkbox"/>	<input type="checkbox"/>	<input type="checkbox"/>	<input type="checkbox"/>	-/-
Frequency Stability	Nominal	Nominal	<input type="checkbox"/>	<input type="checkbox"/>	<input type="checkbox"/>	<input checked="" type="checkbox"/>	-/-
Spurious Emissions Radiated	Nominal	Nominal	<input checked="" type="checkbox"/>	<input type="checkbox"/>	<input type="checkbox"/>	<input type="checkbox"/>	-/-
Spurious Emissions Conducted	Nominal	Nominal	<input type="checkbox"/>	<input type="checkbox"/>	<input type="checkbox"/>	<input checked="" type="checkbox"/>	-/-
Block Edge Compliance	Nominal	Nominal	<input type="checkbox"/>	<input type="checkbox"/>	<input type="checkbox"/>	<input checked="" type="checkbox"/>	-/-
Occupied Bandwidth	Nominal	Nominal	<input type="checkbox"/>	<input type="checkbox"/>	<input type="checkbox"/>	<input checked="" type="checkbox"/>	-/-

Note: C = Compliant; NC = Not compliant; NA = Not applicable; NP = Not performed

9 Results GSM 850

All tests were performed with one timeslot in uplink activated and one timeslot in downlink activated. For each mode the highest output power was determined and used.

9.1 RF output power

Description:

This paragraph contains average power, peak output power, PAPR and ERP measurements for the mobile station.

The plots in this test report represents only an example of the measurements. All plots of this chapter are available on request.

The red line in the measurements indicates the ideal Gaussian distribution for the measured amplitude range.

Measurement:

The mobile was set up for the maximum output power with pseudo random data modulation.

To determine the Peak-To-Average Power Ratio (PAPR) the measurement was performed with the Power Complementary Cumulative Distribution Function (CCDF).

Measurement parameters	
Detector:	Sample
AQT:	See plot
Resolution bandwidth:	1 MHz
Used equipment:	See chapter 6.1 – A & 6.4 – A
Measurement uncertainty:	see chapter 7

Limits:

FCC	IC
+38.45 dBm In measuring transmissions in this band using an average power technique, the peak-to-average ratio (PAR) of the transmission may not exceed 13 dB.	

Results:

Output Power (conducted) GMSK mode			
Frequency (MHz)	Peak Output Power (dBm)	Average Output Power (dBm)	Peak to Average Ratio (dB) CCDF
824.2	32.5	32.2	0.3
836.4	33.0	31.9	1.1
848.8	33.0	32.7	0.3

Output Power (conducted) 8-PSK mode			
Frequency (MHz)	Peak Output Power (dBm)	Average Output Power (dBm)	Peak to Average Ratio (dB) CCDF
824.2	29.9	26.5	3.4
836.4	33.1	27.1	6.0
848.8	33.0	27.0	6.0

Output Power (radiated) GMSK mode	
Frequency (MHz)	Average Output Power (dBm) - ERP
824.2	30.6
836.4	30.0
848.8	30.7

Output Power (radiated) 8-PSK mode	
Frequency (MHz)	Average Output Power (dBm) - ERP
824.2	24.9
836.4	25.2
848.8	25.0

Plots: GMSK

Plot 1: CCDF, channel 128

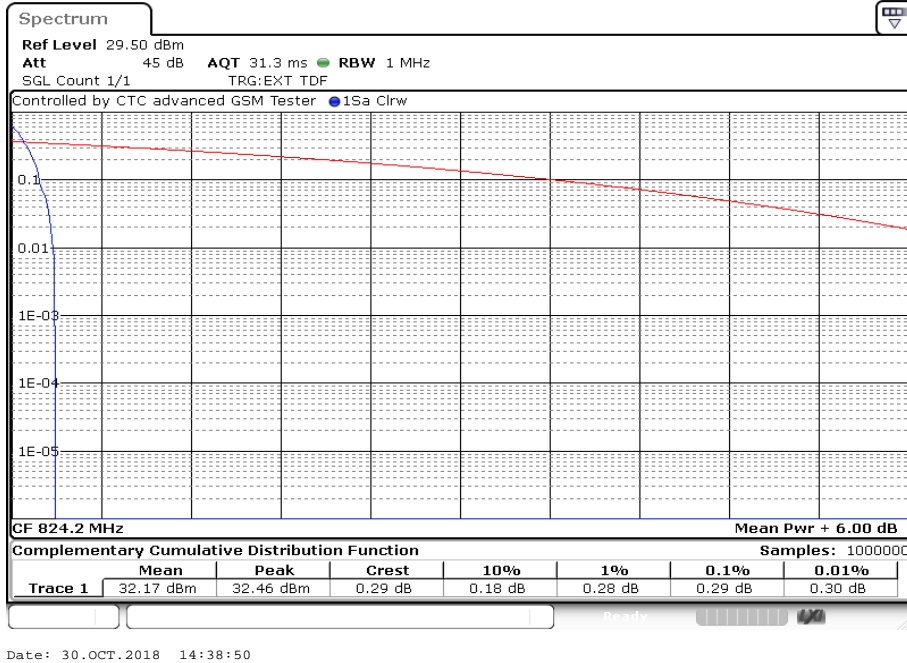

Plot 2: CCDF, channel 189

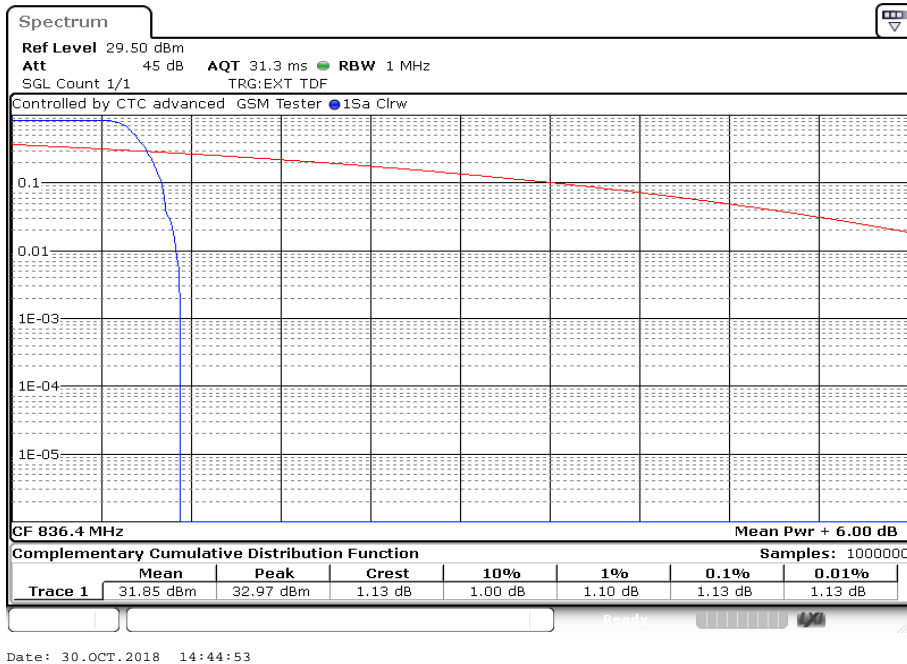

Plot 3: CCDF, channel 251

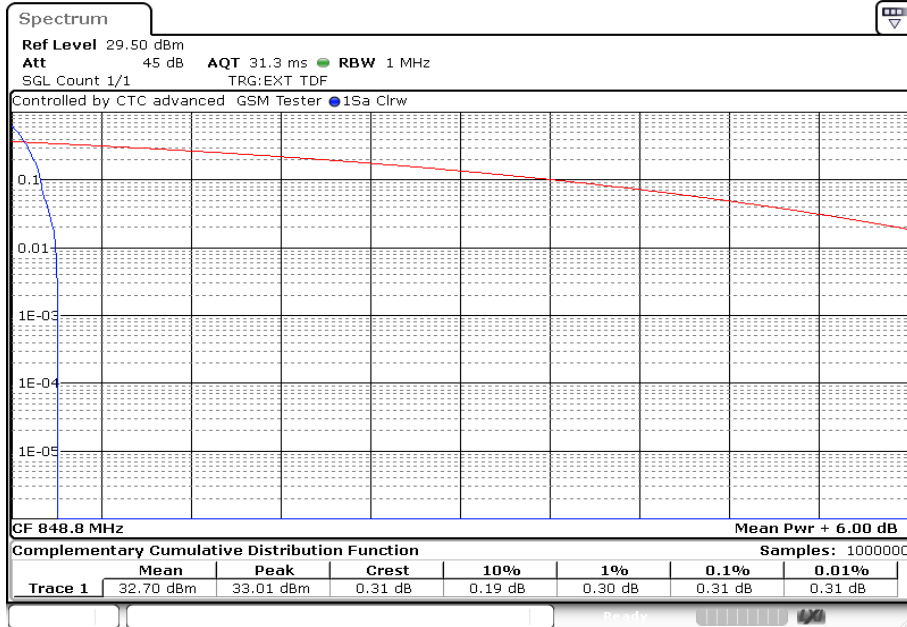

Date: 30.OCT.2018 14:50:17

Plots: 8 PSK

Plot 1: CCDF, channel 128

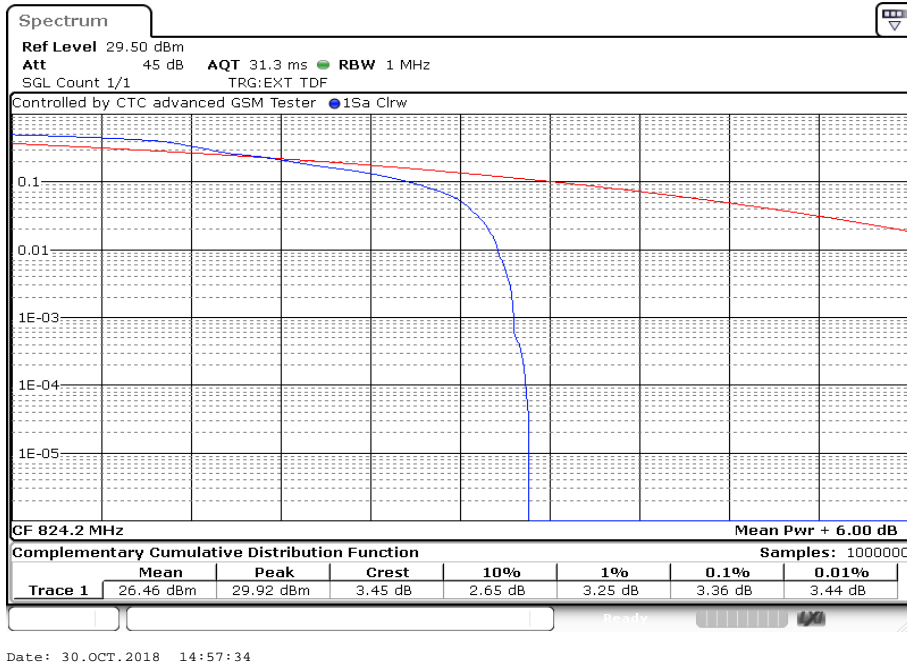

Plot 2: CCDF, channel 189

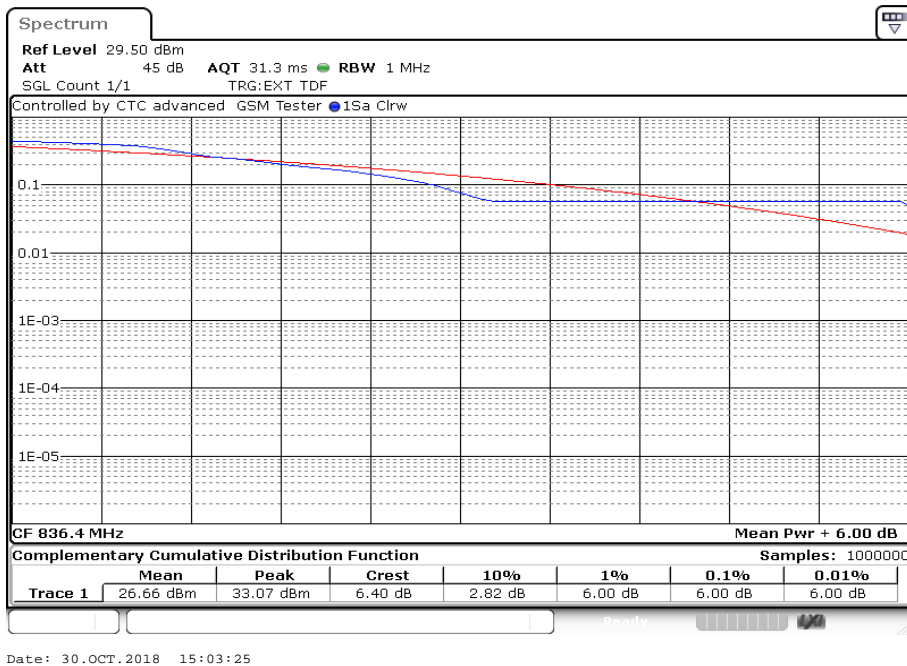

Plot 3: CCDF, channel 251

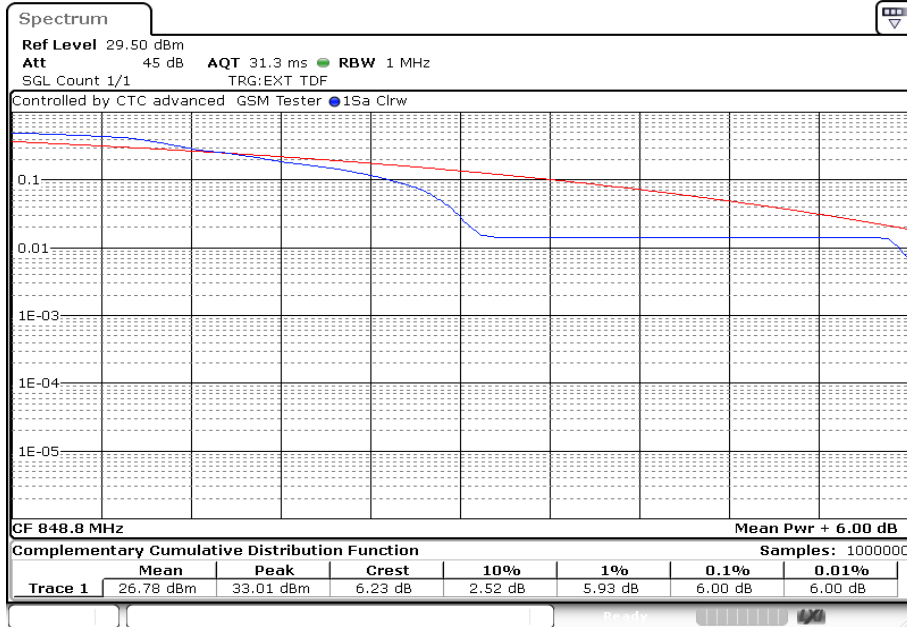

Date: 30.OCT.2018 15:08:44

9.2 Spurious emissions radiated

Description:

The following steps outline the procedure used to measure the radiated emissions from the mobile station. The site is constructed in accordance with ANSI C63.4:2014 requirements and is recognized by the FCC to be in compliance for a 3 and a 10 meter site. The spectrum was scanned from 30 MHz to the 10th harmonic of the highest frequency generated within the equipment, which is the transmitted carrier that can be as high as 848.8 MHz. Measurements made up to 12.75 GHz. The resolution bandwidth is set as outlined in Part 22.917.

Measurement:

Measurement parameters	
Detector:	Peak
Sweep time:	2 s
Resolution bandwidth:	100 kHz
Video bandwidth:	300 kHz
Span:	100 MHz Steps
Trace mode:	Max hold
Used equipment:	See chapter 6.1 – A & C & 6.2 – A
Measurement uncertainty:	See chapter 7

Limits:

FCC	IC
Attenuation $\geq 43 + 10\log(P)$ (P, Power in Watts)	
-13 dBm	

Results GPRS & EGPRS:

Radiated emissions measurements were made only at the center carrier frequency of the GSM-850 band (836.4 MHz). The measurements shows the cabinet radiation in transmit mode. The antenna port can be terminated with 50 Ω .

Spurious emission level (dBm)								
Harmonic	Ch. 128 Freq. (MHz)	Level [dBm]	Harmonic	Ch. 189 Freq. (MHz)	Level [dBm]	Harmonic	Ch. 251 Freq. (MHz)	Level [dBm]
2	1648.4	-	2	1672.8	-	2	1697.6	-
3	2472.6	-	3	2509.2	-	3	2546.4	-
4	3296.8	-	4	3345.6	-	4	3395.2	-
5	4121.0	-	5	4182.0	-	5	4244.0	-
6	4945.2	-	6	5018.4	-	6	5092.8	-
7	5769.4	-	7	5854.8	-	7	5941.6	-
8	6593.6	-	8	6691.2	-	8	6790.4	-
9	7417.8	-	9	7527.6	-	9	7639.2	-
10	8242.0	-	10	8364.0	-	10	8488.0	-

Plots: GMSK

Plot 1: Channel 189 (Traffic mode up to 30 MHz)

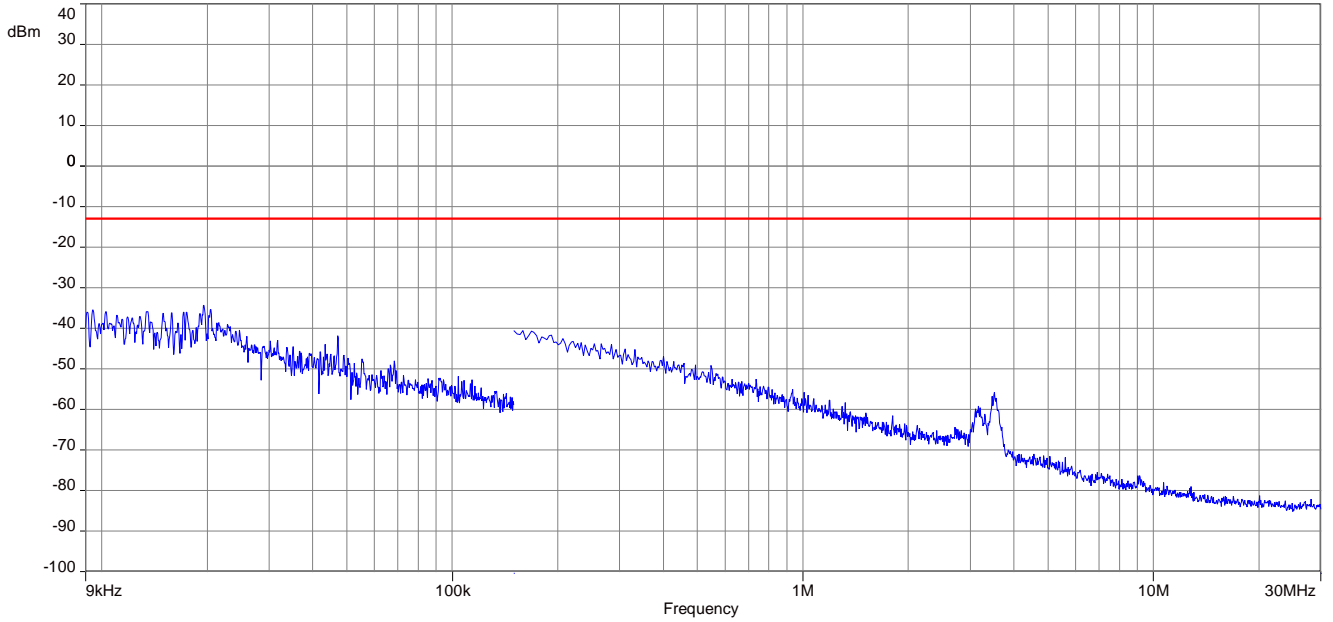

Plot 2: Channel 189 (30 MHz – 1 GHz)

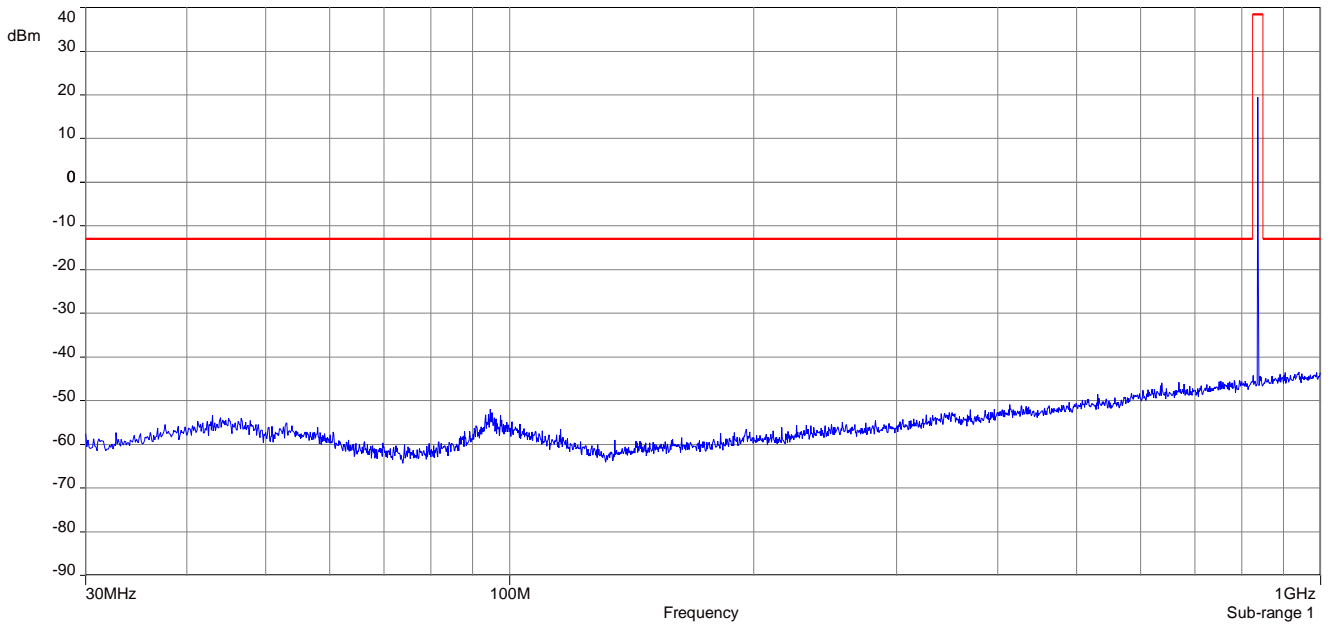

Plot 3: Channel 189 (1 GHz – 12.75 GHz)

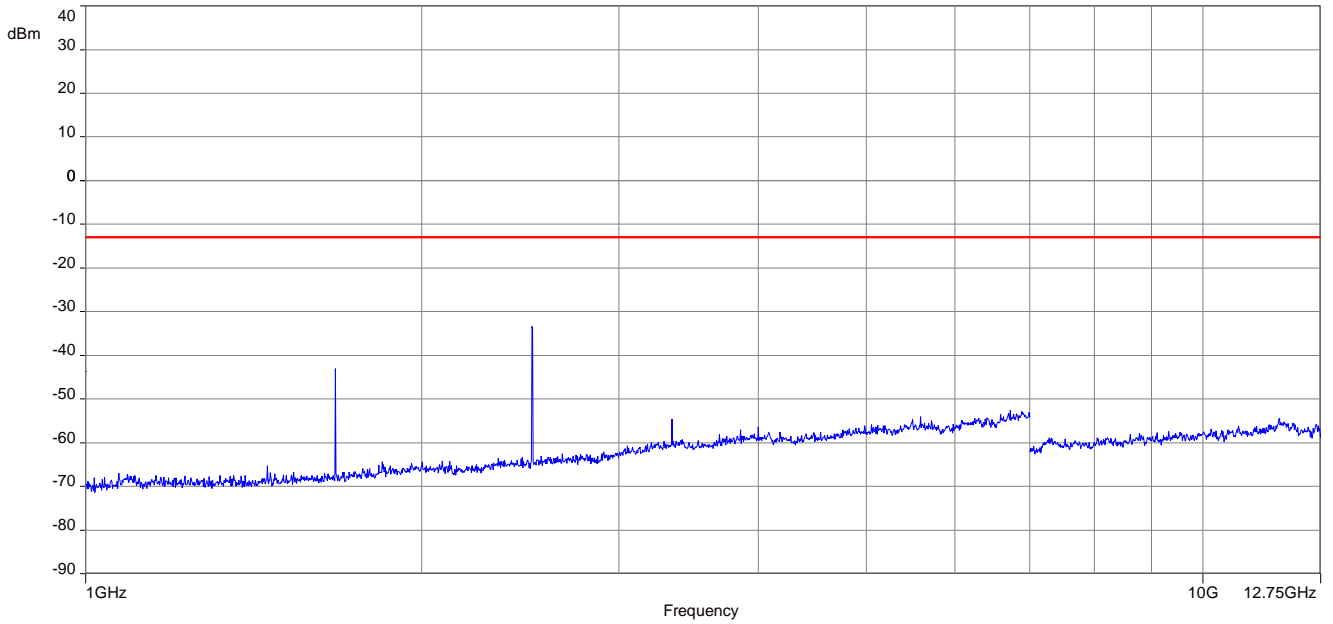

Plots: 8 PSK

Plot 1: Channel 189 (Traffic mode up to 30 MHz)

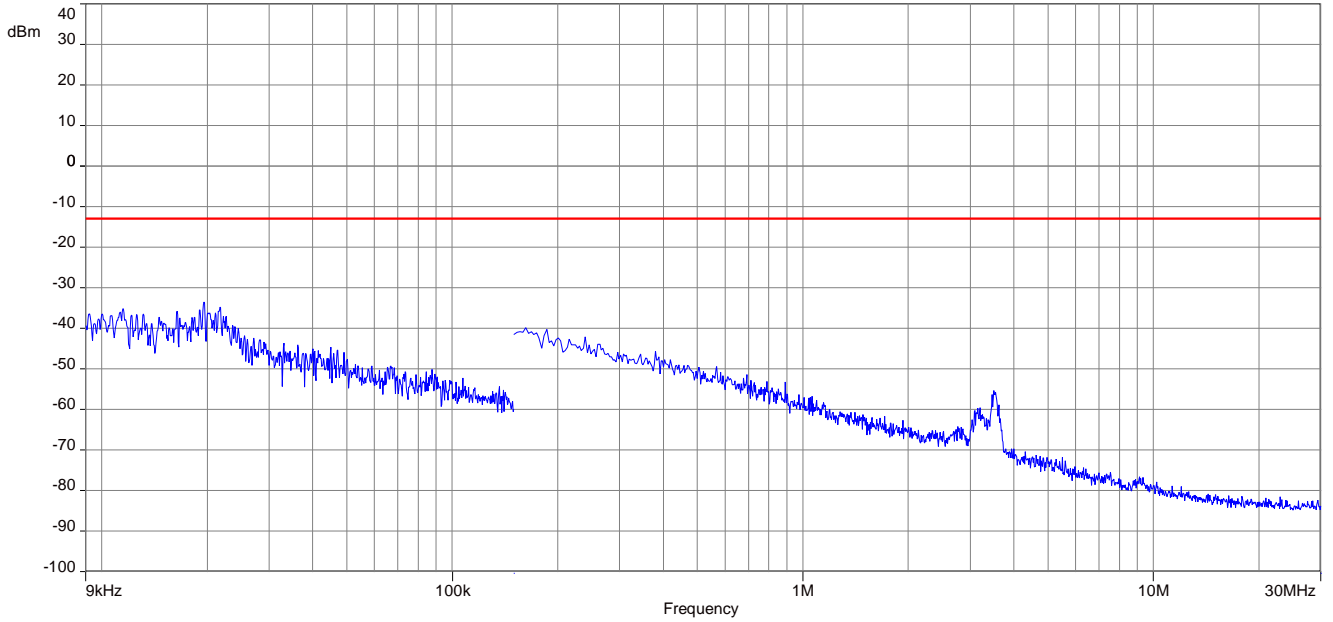

Plot 2: Channel 189 (30 MHz – 1 GHz)

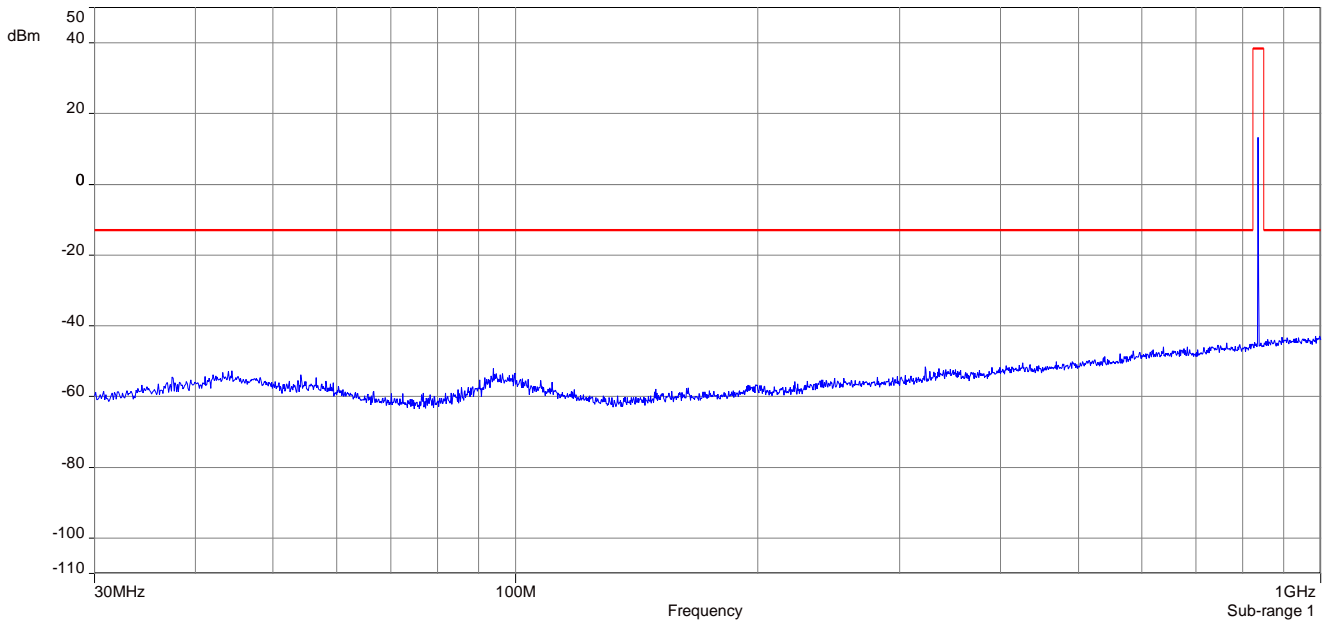

Plot 3: Channel 189 (1 GHz – 12.75 GHz)

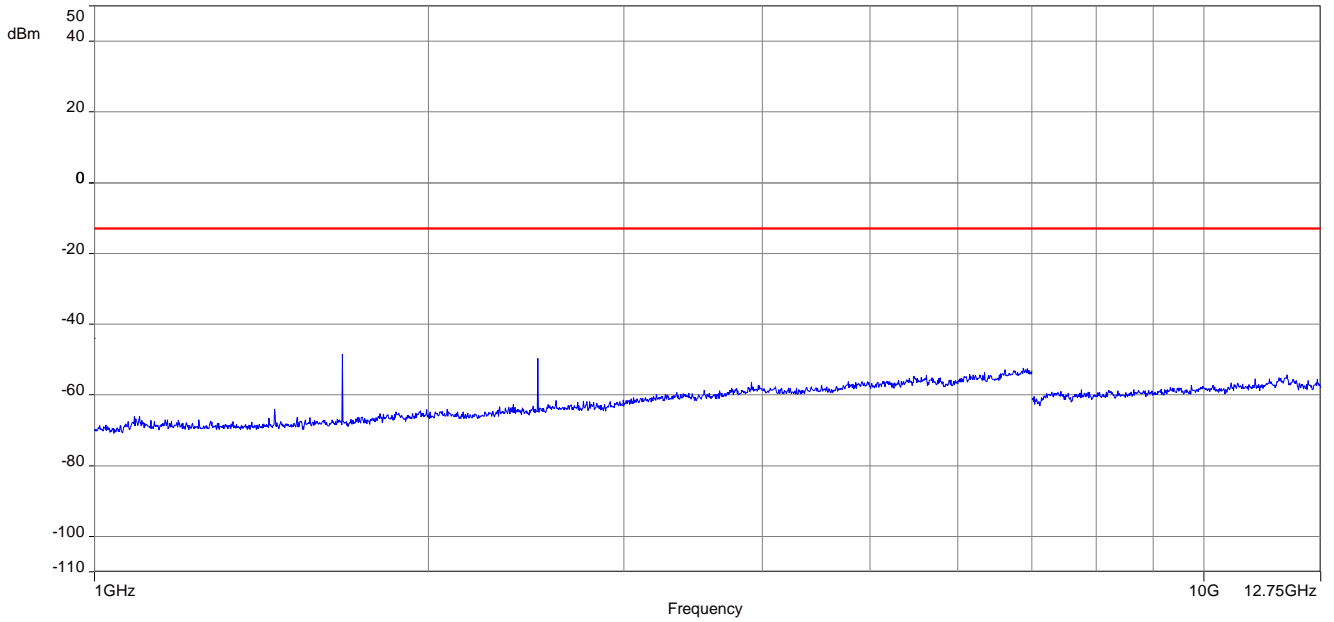

10 Results PCS 1900

All tests were performed with one timeslot in uplink activated and one timeslot in downlink activated. For each mode the highest output power was determined and used.

10.1 RF output power

Description:

This paragraph contains average power, peak output power, PAPR and ERP measurements for the mobile station.

The plots in this test report represents only an example of the measurements. All plots of this chapter are available on request.

The red line in the measurements indicates the ideal Gaussian distribution for the measured amplitude range.

Measurement:

The mobile was set up for the maximum output power with pseudo random data modulation.

To determine the Peak-To-Average Power Ratio (PAPR) the measurement was performed with the Power Complementary Cumulative Distribution Function (CCDF).

Measurement parameters	
Detector:	Sample
AQT:	See plot
Resolution bandwidth:	1 MHz
Used equipment:	See chapter 6.2 – B & 6.4 – A
Measurement uncertainty:	See chapter 7

Limits:

FCC	IC
+33.00 dBm In measuring transmissions in this band using an average power technique, the peak-to-average ratio (PAR) of the transmission may not exceed 13 dB.	

Results:

Output Power (conducted) GMSK mode			
Frequency (MHz)	Peak Output Power (dBm)	Average Output Power (dBm)	Peak to Average Ratio (dB) CCDF
1850.2	28.6	28.0	0.6
1880.0	28.5	27.5	1.0
1909.8	28.4	27.9	0.5

Output Power (conducted) 8-PSK mode			
Frequency (MHz)	Peak Output Power (dBm)	Average Output Power (dBm)	Peak to Average Ratio (dB) CCDF
1850.2	29.2	26.0	3.2
1880.0	29.1	25.1	4.0
1909.8	29.0	25.0	4.0

Output Power (radiated) GMSK mode	
Frequency (MHz)	Average Output Power (dBm) - EIRP
1850.2	27.6
1880.0	25.9
1909.8	25.2

Output Power (radiated) 8-PSK mode	
Frequency (MHz)	Average Output Power (dBm) - EIRP
1850.2	25.6
1880.0	23.5
1909.8	22.3

Plots: GMSK

Plot 1: CCDF, channel 512

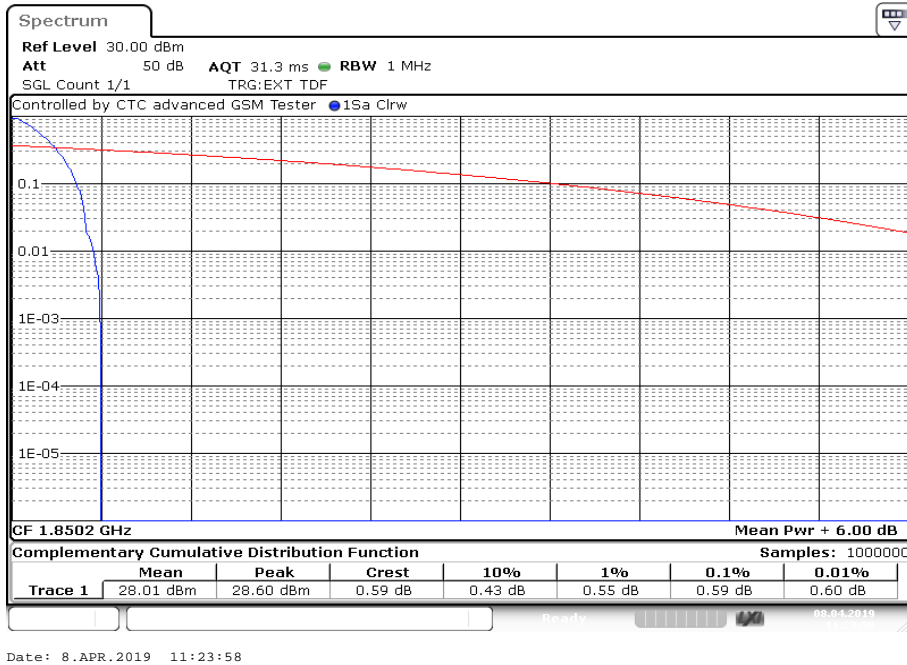

Plot 2: CCDF, channel 661

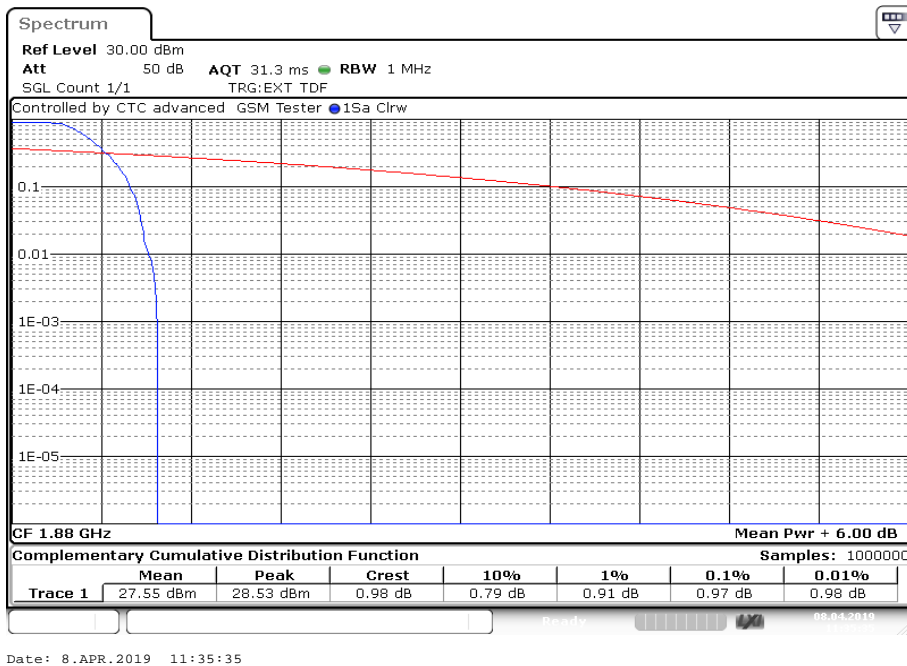

Plot 3: CCDF, channel 810

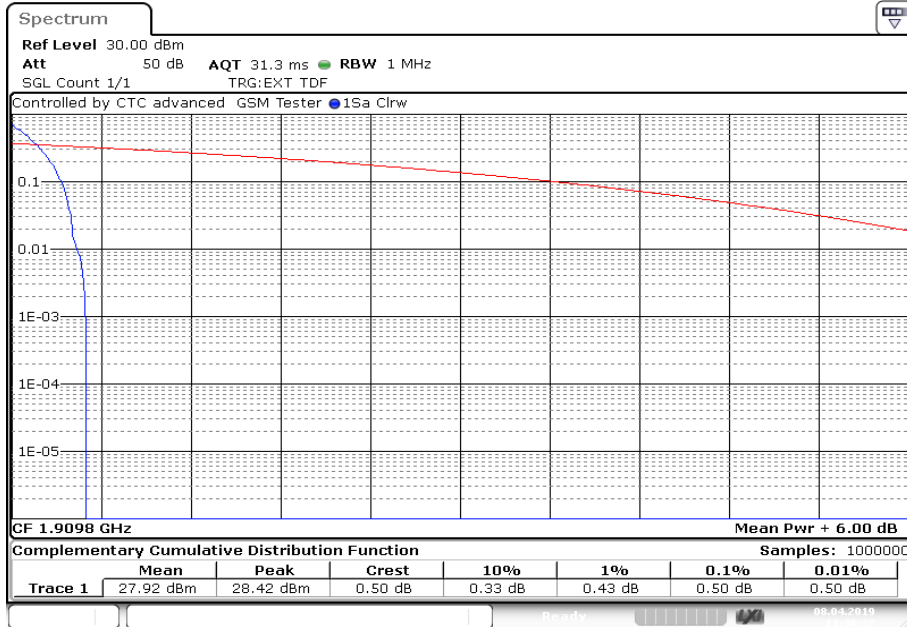

Date: 8.APR.2019 11:46:37

Plots: 8 PSK

Plot 1: CCDF, channel 512

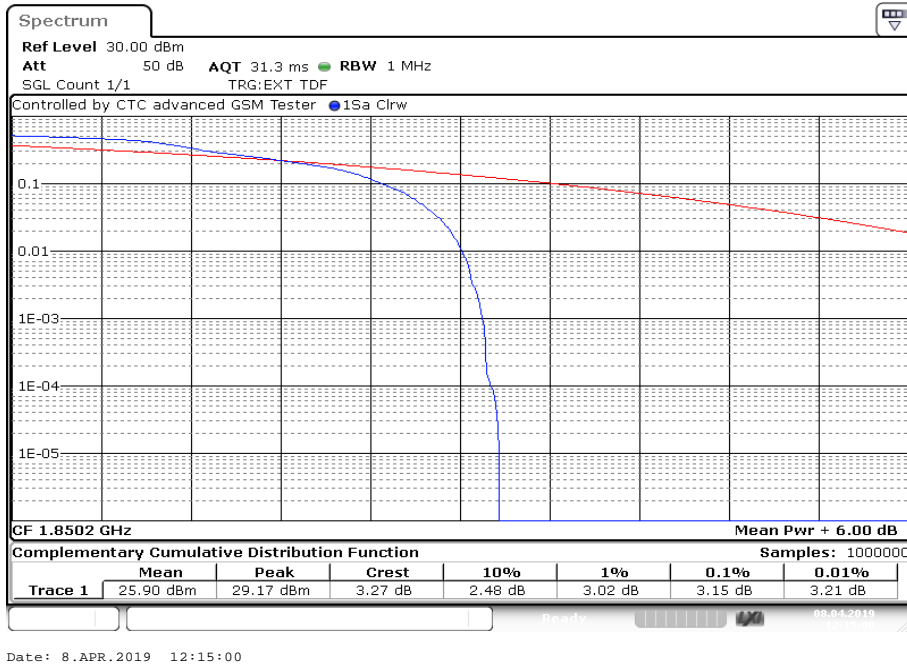

Plot 2: CCDF, channel 661

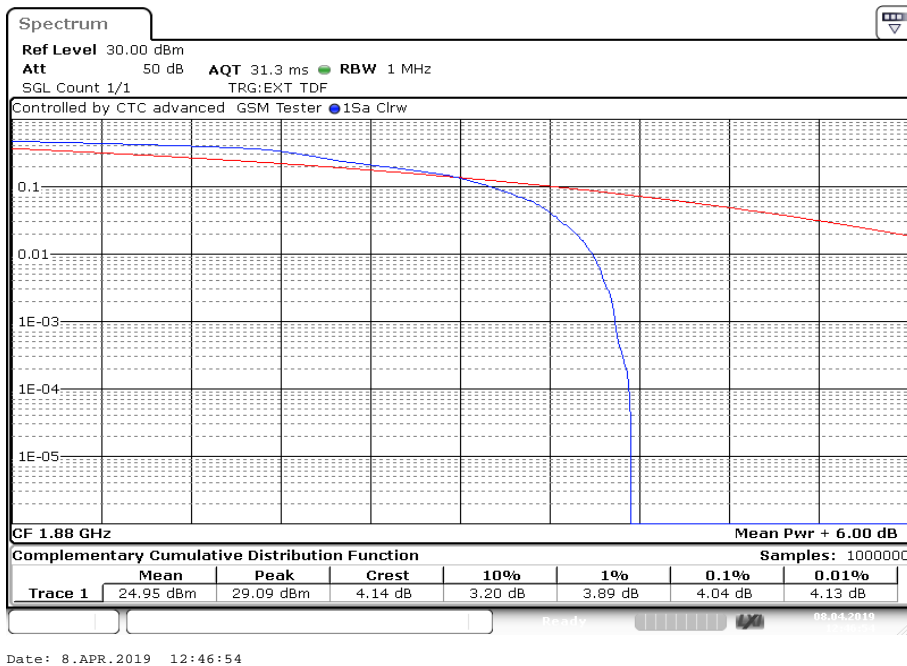

Plot 3: CCDF, channel 810

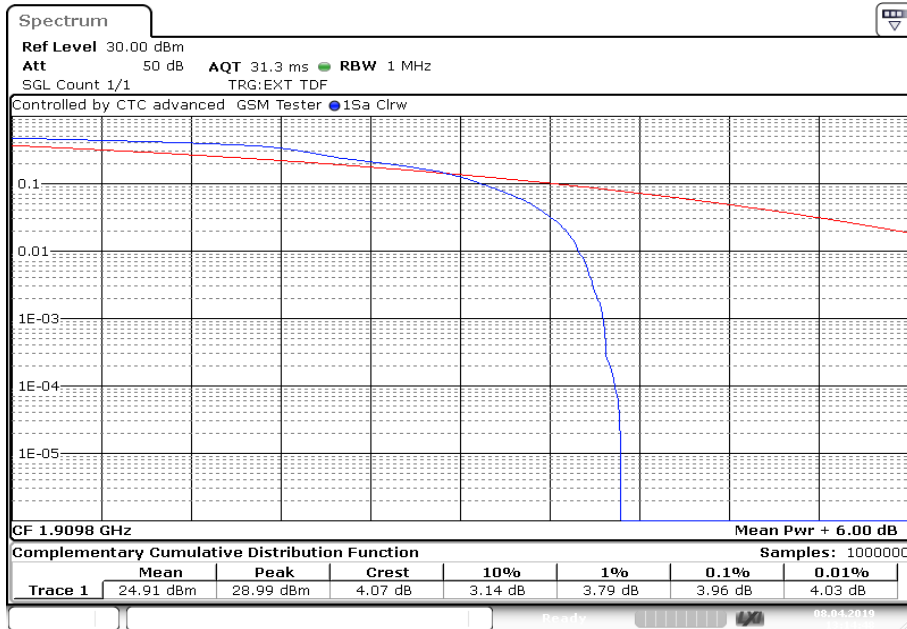

Date: 8.APR.2019 13:14:48

10.2 Spurious emissions radiated

Description:

The following steps outline the procedure used to measure the radiated emissions from the mobile station. The site is constructed in accordance with ANSI C63.4:2014 requirements and is recognized by the FCC to be in compliance for a 3 and a 10 meter site. The spectrum was scanned from 30 MHz to the 10th harmonic of the highest frequency generated within the equipment, which is the transmitted carrier that can be as high as 1910 MHz. Measurement made up to 25 GHz. The resolution bandwidth is set as outlined in Part 24.238.

Measurement:

Measurement parameters	
Detector:	Peak
Sweep time:	2 sec.
Resolution bandwidth:	1 MHz
Video bandwidth:	3 MHz
Span:	100 MHz Steps
Trace mode:	Max hold
Used equipment:	See chapter 6.1 – A, 6.2 – A & C, 6.3 – A
Measurement uncertainty:	See chapter 7

Limits:

FCC	IC
Attenuation $\geq 43 + 10\log(P)$ (P, Power in Watts)	
-13 dBm	

Results GPRS & EGPRS:

Radiated emissions measurements were made only at the center carrier frequencies of the PCS1900 band (1880.0 MHz) to show the compliance with cabinet radiation limits.

Results:

Spurious emission level (dBm)								
Harmonic	Ch. 512 Freq. (MHz)	Level [dBm]	Harmonic	Ch. 661 Freq. (MHz)	Level [dBm]	Harmonic	Ch. 810 Freq. (MHz)	Level [dBm]
2	3700.4	-	2	3760.0	-	2	3819.6	-
3	5550.6	-	3	5640.0	-	3	5729.4	-
4	7400.8	-	4	7520.0	-	4	7639.2	-
5	9251.0	-	5	9400.0	-	5	9549.0	-
6	11101.2	-	6	11280.0	-	6	11458.8	-
7	12951.4	-	7	13160.0	-	7	13368.6	-
8	14801.6	-	8	15040.0	-	8	15278.4	-
9	16651.8	-	9	16920.0	-	9	17188.2	-
10	18502.0	-	10	18800.0	-	10	19098.0	-

Plots: GMSK

Plot 1: Channel 661 (Traffic mode up to 30 MHz)

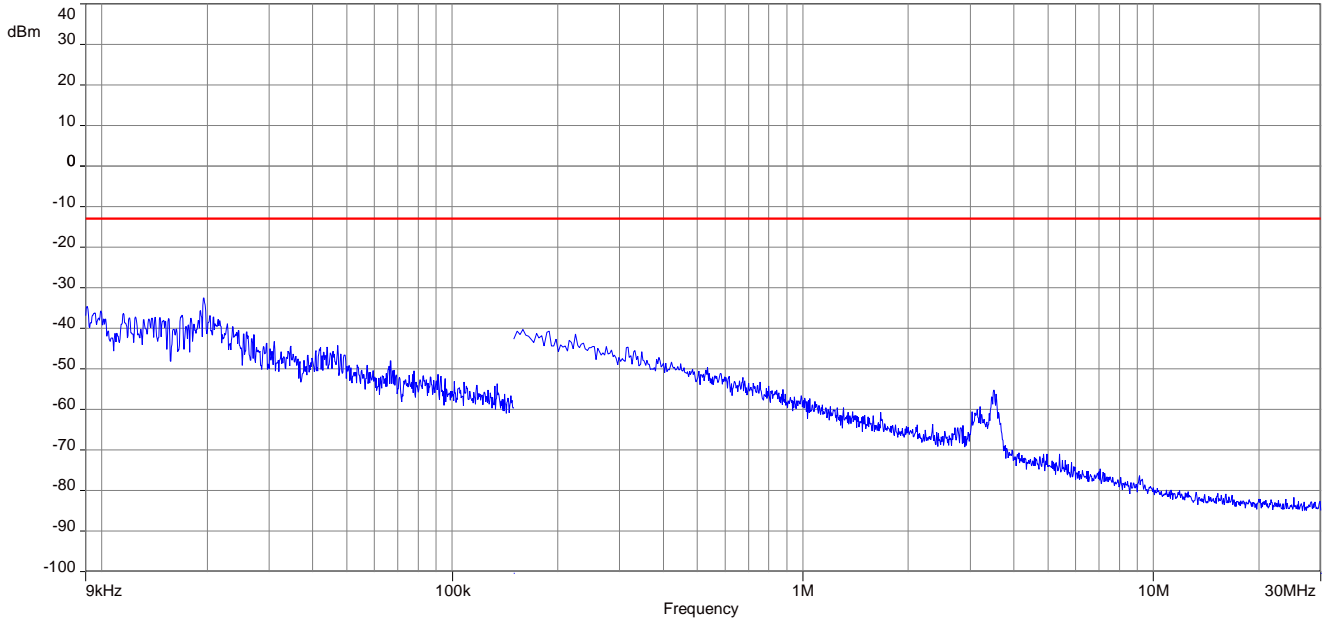

Plot 2: Channel 661 (30 MHz – 1 GHz)

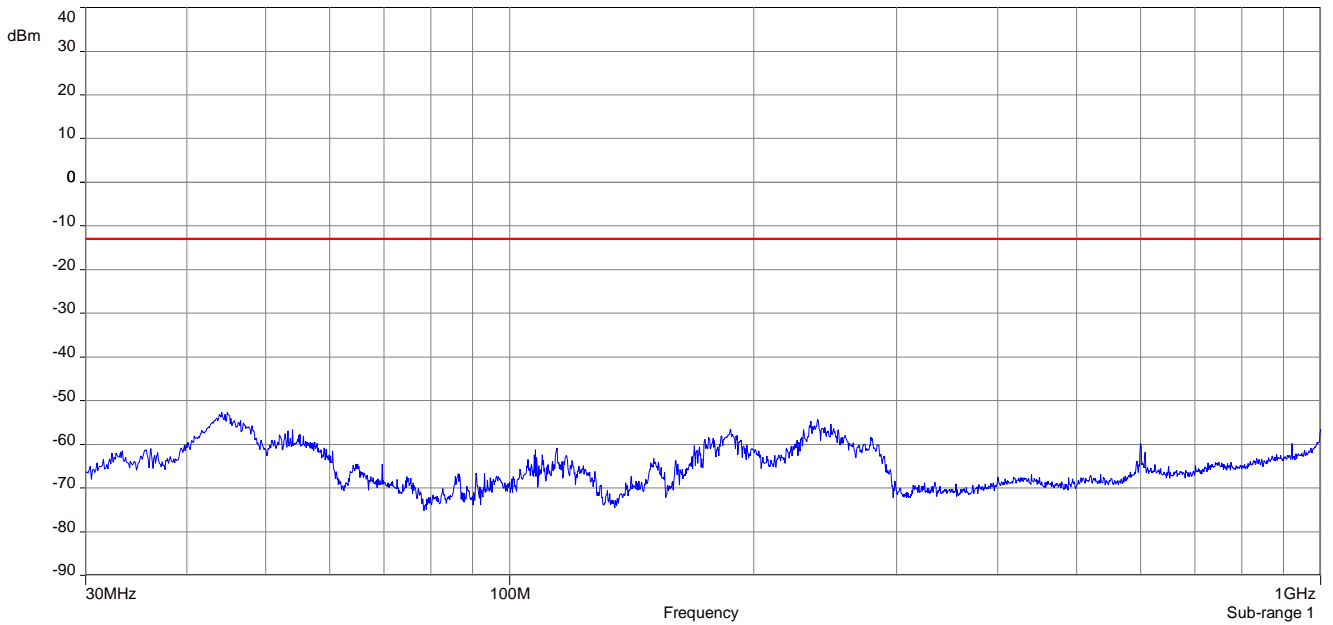

Plot 3: Channel 661 (1 GHz - 18 GHz)

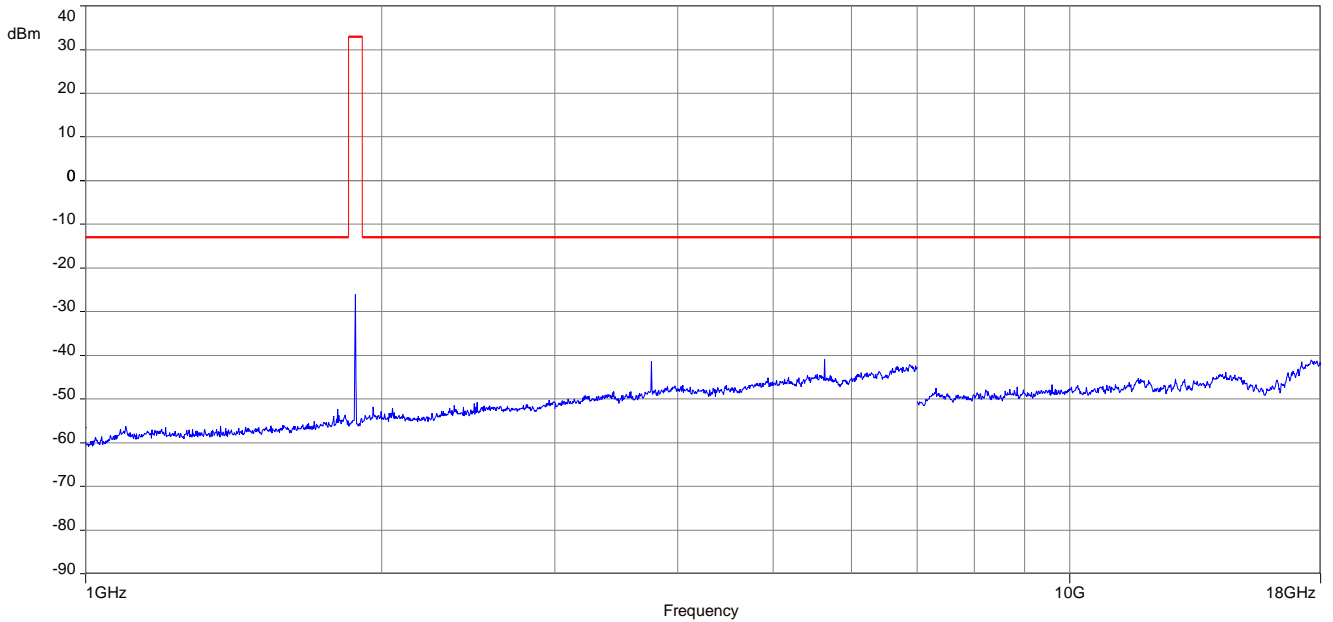

Carrier notched with 1.9 GHz rejection filter

Plot 3: Channel 661 (18 GHz - 26 GHz)

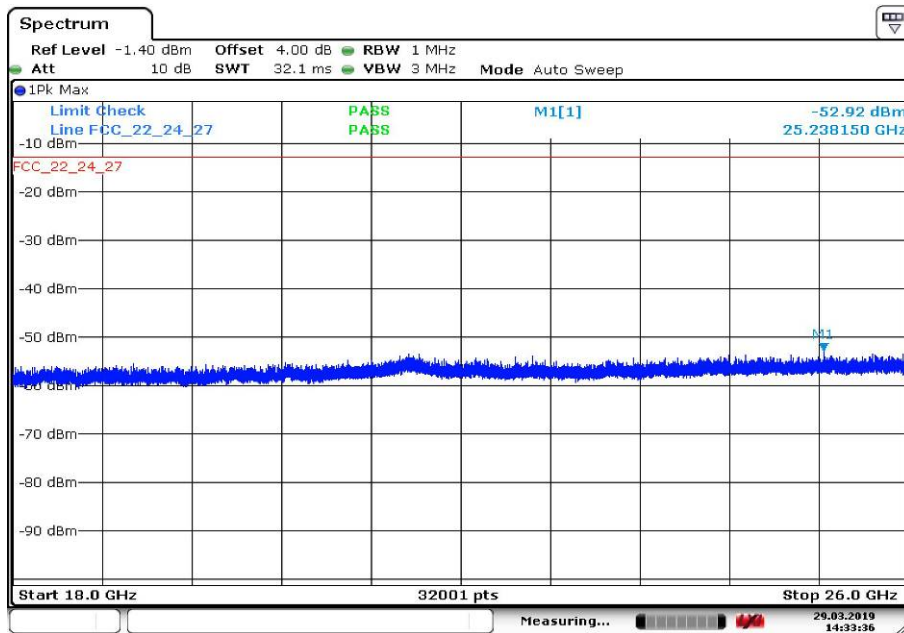

Date: 29.MAR.2019 14:33:37

Plots: 8 PSK

Plot 1: Channel 661 (Traffic mode up to 30 MHz)

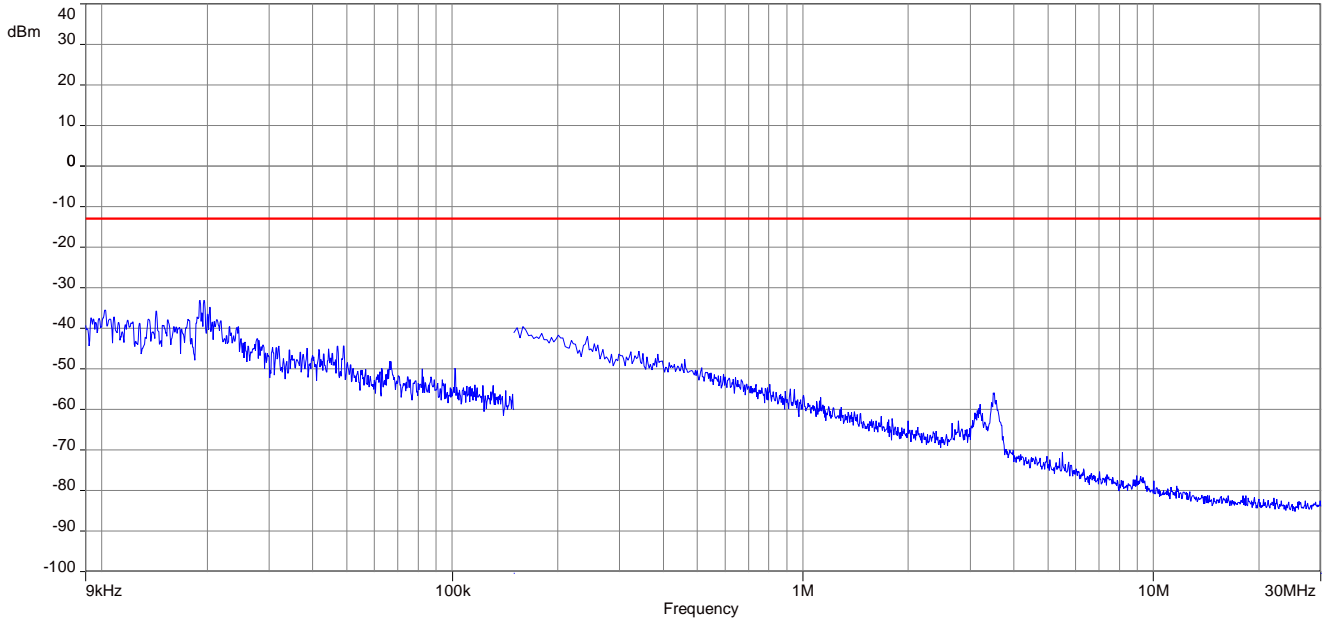

Plot 2: Channel 661 (30 MHz – 1 GHz)

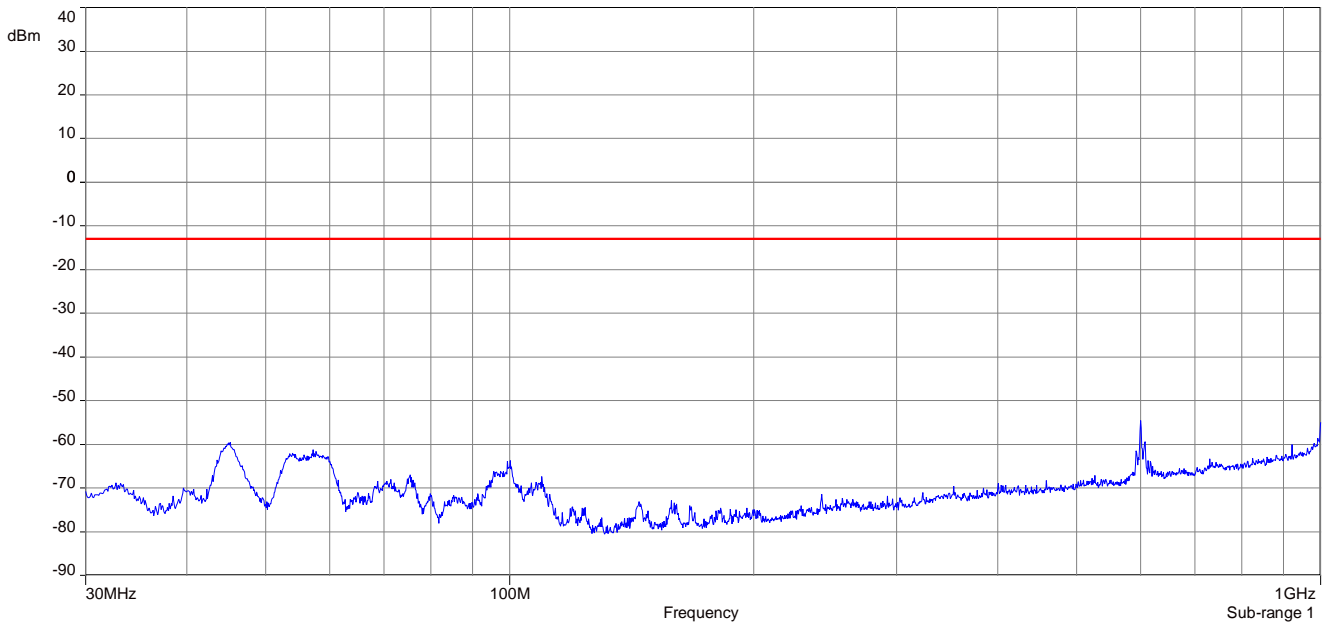

Plot 3: Channel 661 (1 GHz – 18 GHz)

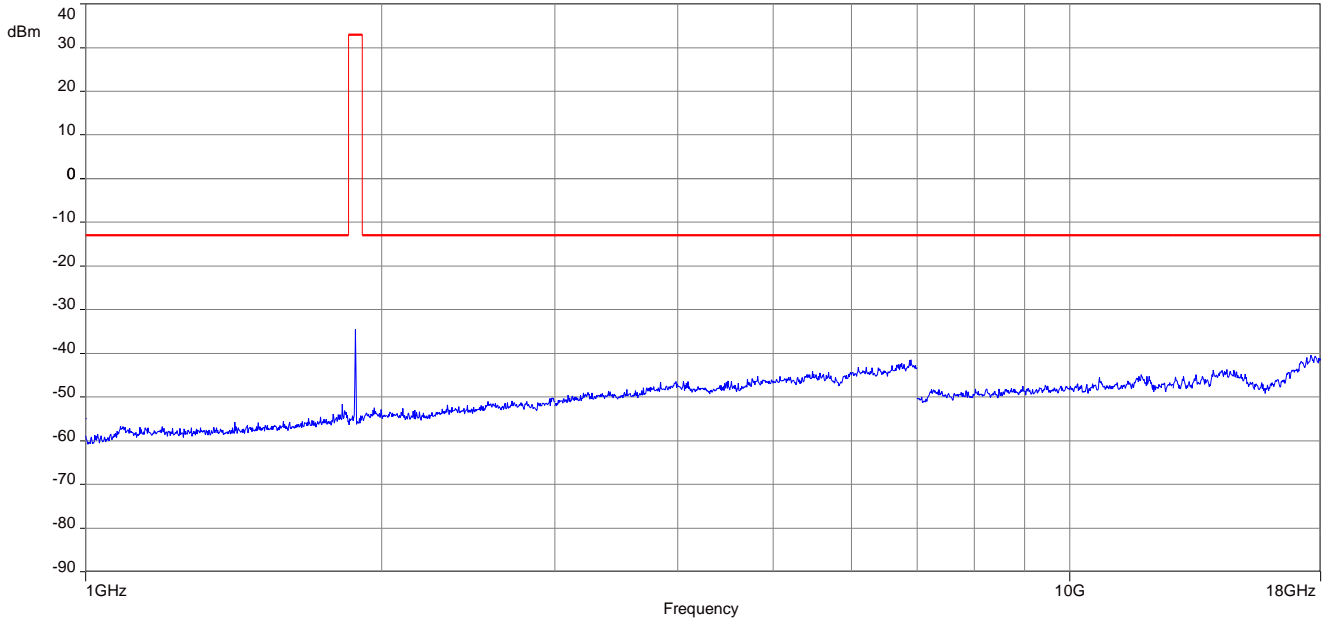

Carrier notched with 1.9 GHz rejection filter

Plot 4: Channel 661 (18 GHz - 26 GHz)

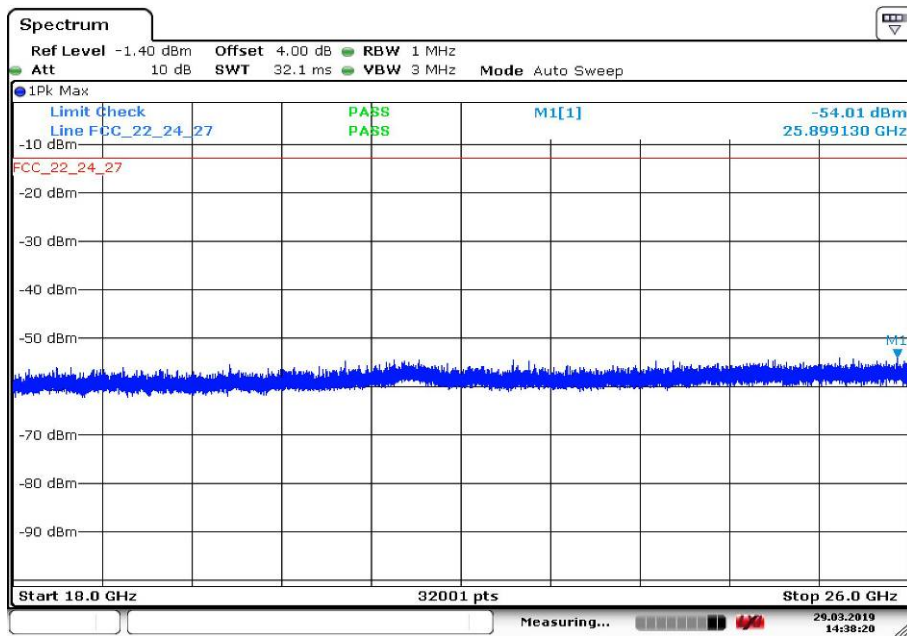

Date: 29. MAR. 2019 14:38:20

11 Results UMTS band II

All UMTS-band measurements are done in WCDMA mode only.

The connection was established with the following setup: WCDMA CS-RMC, Max Power (All Bit up)

11.1 RF output power

Description:

This paragraph contains average power, peak output power and EIRP measurements for the mobile station. In all cases, the peak output power is within the required mask (this mask is specified in the JTC standards, TIA PN3389 Vol. 1 Chap 7, and is no FCC requirement).

Measurement:

The mobile was set up for the maximum output power with pseudo random data modulation.

To determine the Peak-To-Average Power Ratio (PAPR) the measurement was performed with the Power Complementary Cumulative Distribution Function (CCDF).

Measurement parameters	
Detector:	Peak and RMS (Power in Burst)
Sweep time:	Auto
Video bandwidth:	10 MHz
Resolution bandwidth:	10 MHz
Span:	Zero Span
Trace mode:	Max hold
Used equipment:	See chapter 6.2 – B & 6.4 – B
Measurement uncertainty:	See chapter 7

Limits:

FCC	IC
CFR Part 24.232 CFR Part 2.1046	RSS 133
Nominal Peak Output Power	
+33.00 dBm In measuring transmissions in this band using an average power technique, the peak-to-average ratio (PAR) of the transmission may not exceed 13 dB.	

Results:

Output Power (conducted) WCDMA mode		
Frequency (MHz)	Average Output Power (dBm)	Peak to Average Ratio (dB)
1852.4	23.4	2.9
1880.0	23.5	3.0
1907.6	23.5	2.8

Output Power (radiated) WCDMA mode	
Frequency (MHz)	Average Output Power (dBm) - EIRP
1852.4	23.0
1880.0	21.9
1907.6	20.8

Plots:

Plot 1: CCDF, channel 9262

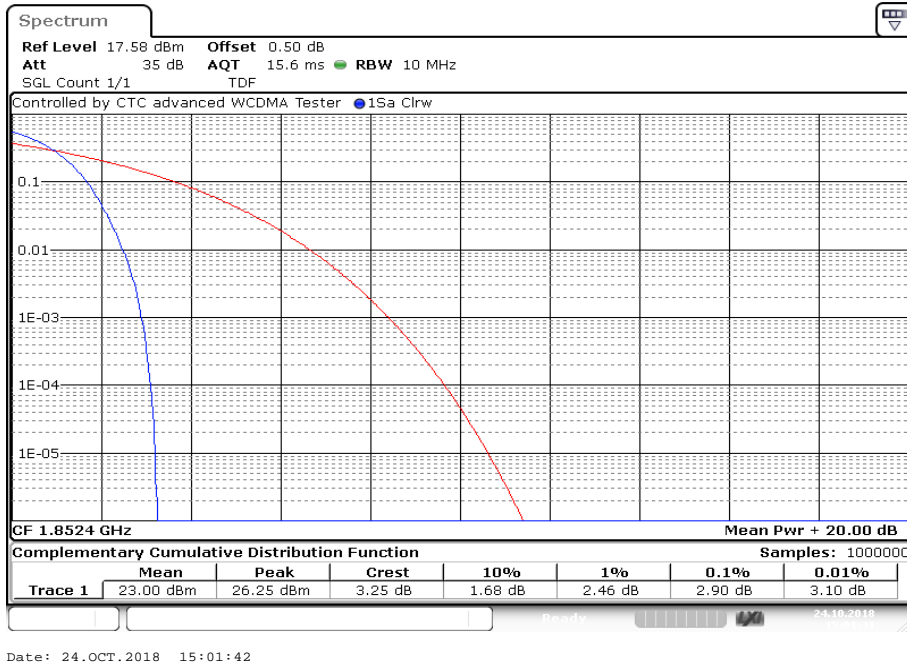

Plot 2: CCDF, channel 9400

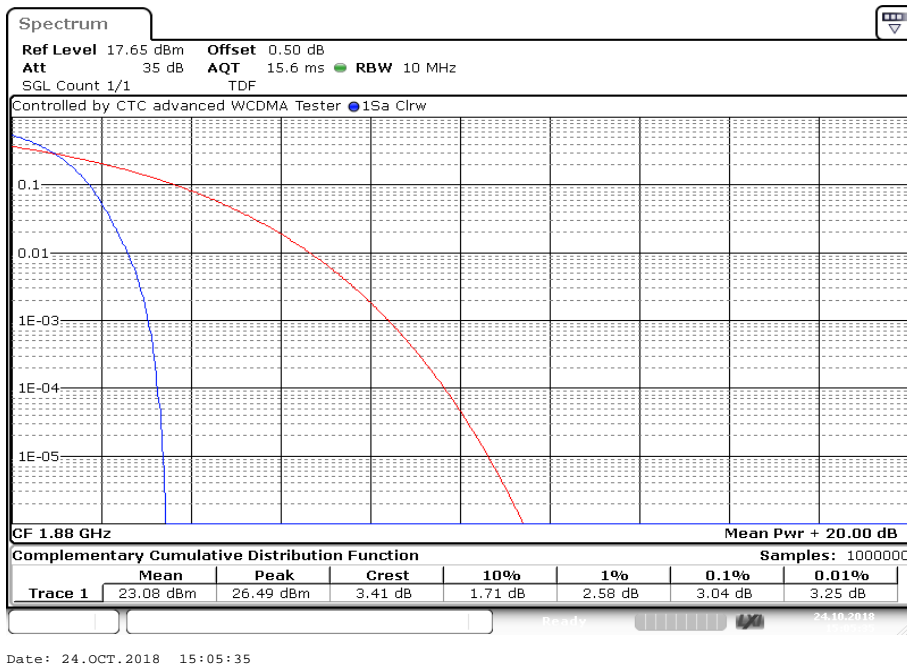

Plot 3: CCDF, channel 9538

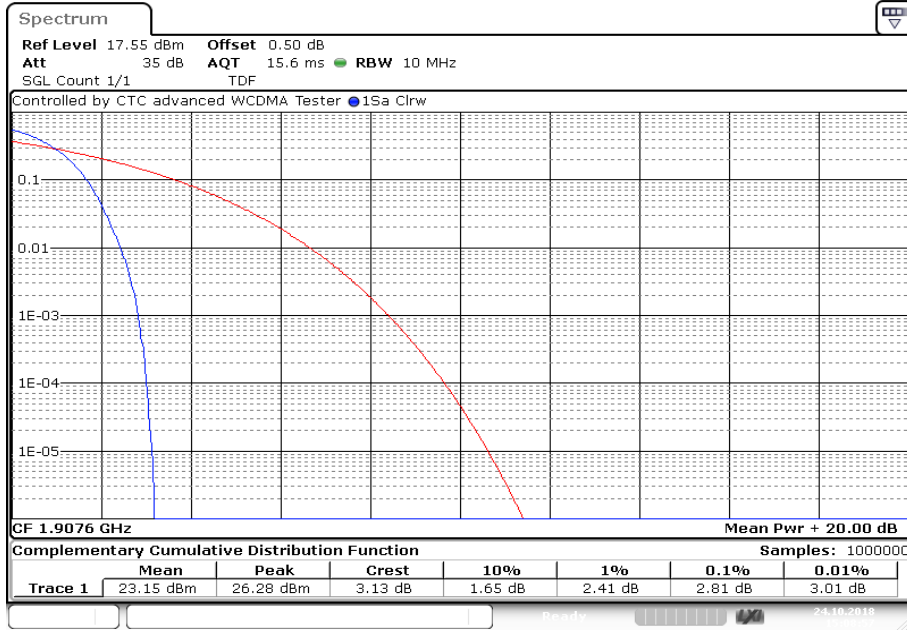

Date: 24.OCT.2018 15:08:57

11.2 Spurious emissions radiated

Description:

The following steps outline the procedure used to measure the radiated emissions from the mobile station. The site is constructed in accordance with ANSI C63.4:2014 requirements and is recognized by the FCC to be in compliance for a 3 and a 10 meter site. The spectrum was scanned from 30 MHz to the 10th harmonic of the highest frequency generated within the equipment, which is the transmitted carrier that can be as high as 1910 MHz. Measurement made up to 25 GHz. The resolution bandwidth is set as outlined in Part 24.238.

Measurement:

Measurement parameters	
Detector:	Peak
Sweep time:	2 sec.
Resolution bandwidth:	1 MHz
Video bandwidth:	3 MHz
Span:	100 MHz Steps
Trace mode:	Max hold
Used equipment:	See chapter 6.1 – B, 6.2 – A & C, 6.3 – B
Measurement uncertainty:	See chapter 7

Limits:

FCC	IC
Attenuation $\geq 43 + 10\log(P)$ (P, Power in Watts)	
-13 dBm	

Results UMTS band II:

Radiated emissions measurements were made only at the center carrier frequencies of the band II (1880.0 MHz) to show the compliance with cabinet radiation limits.

SPURIOUS EMISSION LEVEL (dBm)								
Harmonic	Ch. 9262 Freq. (MHz)	Level [dBm]	Harmonic	Ch. 9400 Freq. (MHz)	Level [dBm]	Harmonic	Ch. 9538 Freq. (MHz)	Level [dBm]
2	3704.8	-	2	3760.0	-	2	3815.2	-
3	5557.2	-	3	5640.0	-	3	5722.8	-
4	7409.6	-	4	7520.0	-	4	7630.4	-
5	9262.0	-	5	9400.0	-	5	9538.0	-
6	11114.4	-	6	11280.0	-	6	11445.6	-
7	12966.8	-	7	13160.0	-	7	13353.2	-
8	14819.2	-	8	15040.0	-	8	15260.8	-
9	16671.6	-	9	16920.0	-	9	17168.4	-
10	18524.0	-	10	18800.0	-	10	19076.0	-

Plots:

Plot 1: Channel 9400 (Traffic mode up to 30 MHz)

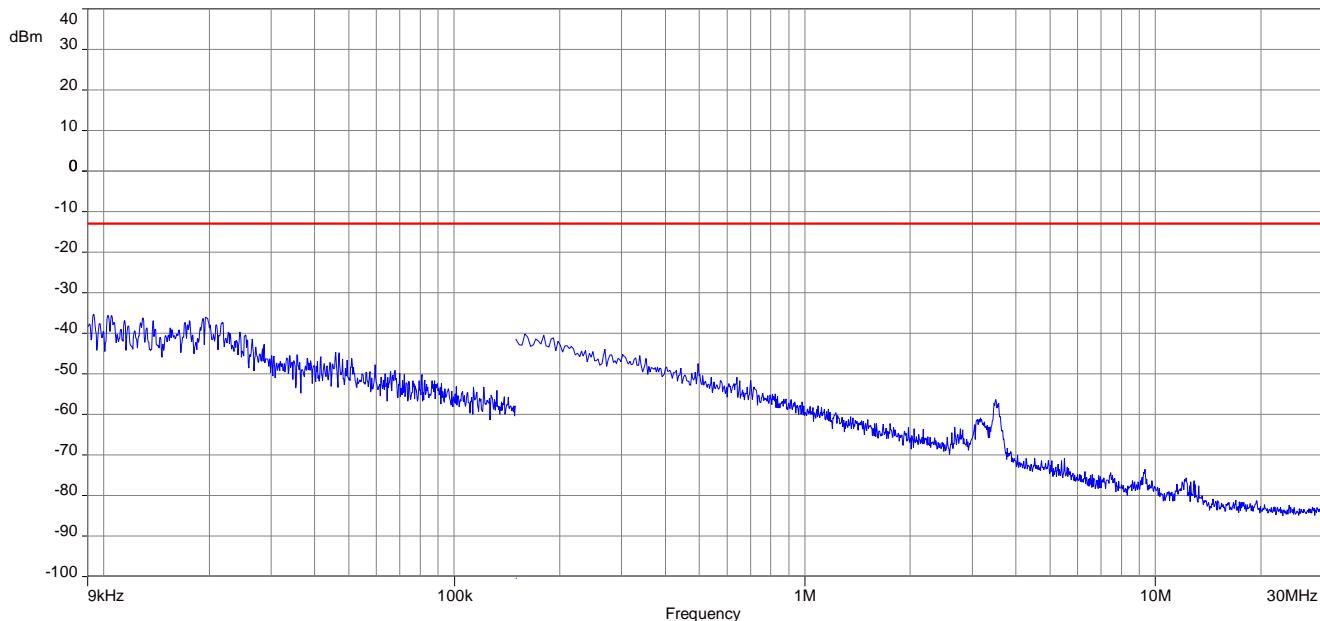

Plot 2: Channel 9400 (30 MHz – 1 GHz)

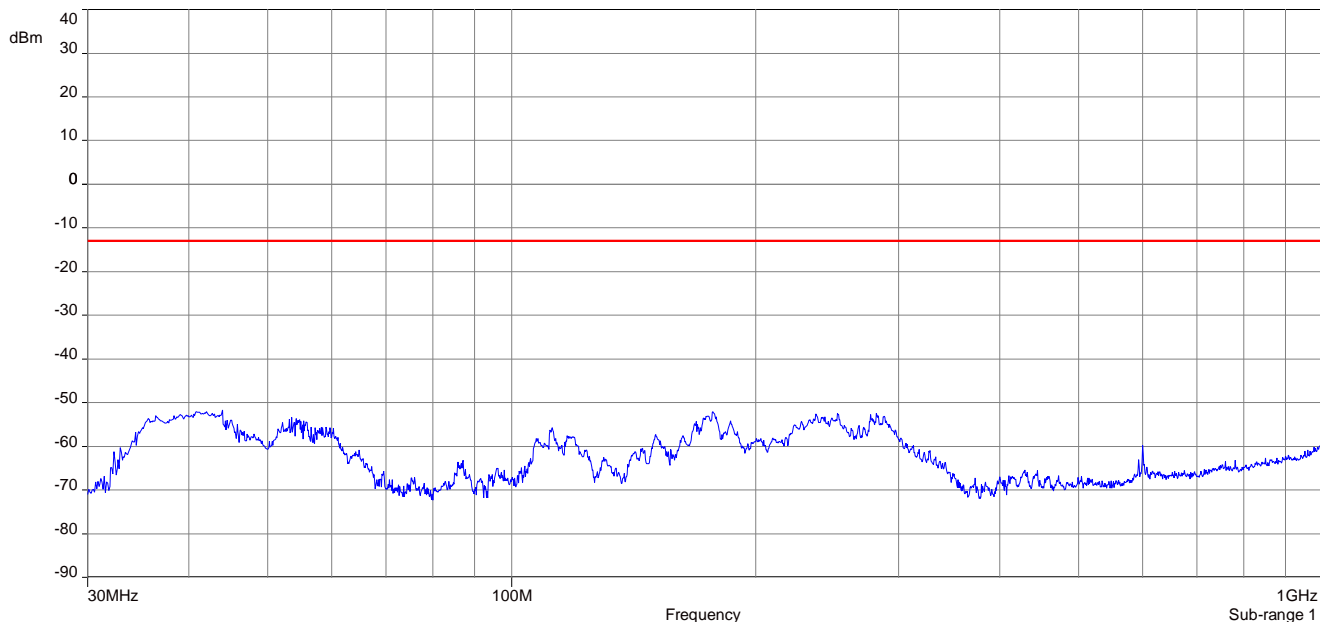

Plot 3: Channel 9400 (1 GHz - 18 GHz)

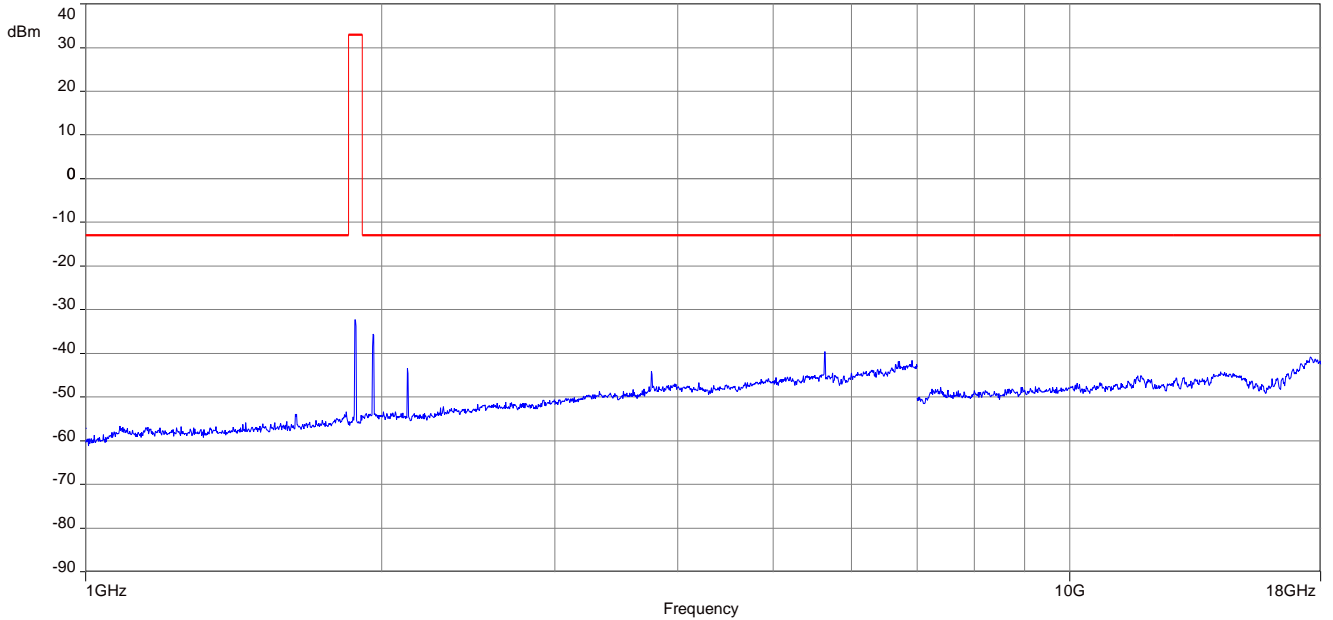

Carrier notched with 1.9 GHz rejection filter

Plot 4: Channel 9400 (18 GHz - 26 GHz)

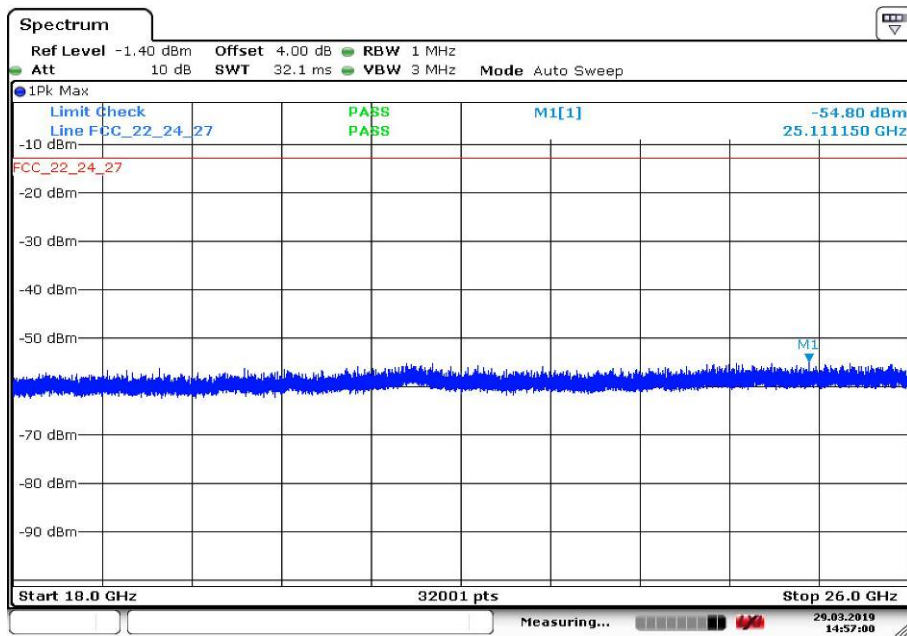

Date: 29. MAR. 2019 14:57:00

12 Results UMTS band IV

All UMTS-band measurements are done in WCDMA mode only.

The connection was established with the following setup: WCDMA CS-RMC, Max Power (All Bit up)

12.1 RF output power

Description:

This paragraph contains average power, peak output power and EIRP measurements for the mobile station. In all cases, the peak output power is within the required mask (this mask is specified in the JTC standards, TIA PN3389 Vol. 1 Chap 7, and is no FCC requirement).

Measurement:

The mobile was set up for the maximum output power with pseudo random data modulation.

To determine the Peak-To-Average Power Ratio (PAPR) the measurement was performed with the Power Complementary Cumulative Distribution Function (CCDF).

Measurement parameters	
Detector:	Peak and RMS (Power in Burst)
Sweep time:	Auto
Video bandwidth:	10 MHz
Resolution bandwidth:	10 MHz
Span:	Zero Span
Trace mode:	Max hold
Used equipment:	See chapter 6.2 – B & 6.4 – B
Measurement uncertainty:	See chapter 7

Limits:

FCC	IC
CFR Part 27.50 CFR Part 2.1046	RSS 139
Nominal Peak Output Power	
+30.00 dBm In measuring transmissions in this band using an average power technique, the peak-to-average ratio (PAR) of the transmission may not exceed 13 dB.	

Results:

Output Power (conducted) WCDMA mode		
Frequency (MHz)	Average Output Power (dBm)	Peak to Average Ratio (dB)
1712.4	23.3	2.7
1732.4	23.4	2.8
1752.6	23.5	2.7

Output Power (radiated) WCDMA mode	
Frequency (MHz)	Average Output Power (dBm) - EIRP
1712.4	23.0
1732.4	23.6
1752.6	25.4

Plots:

Plot 1: CCDF, channel 1312

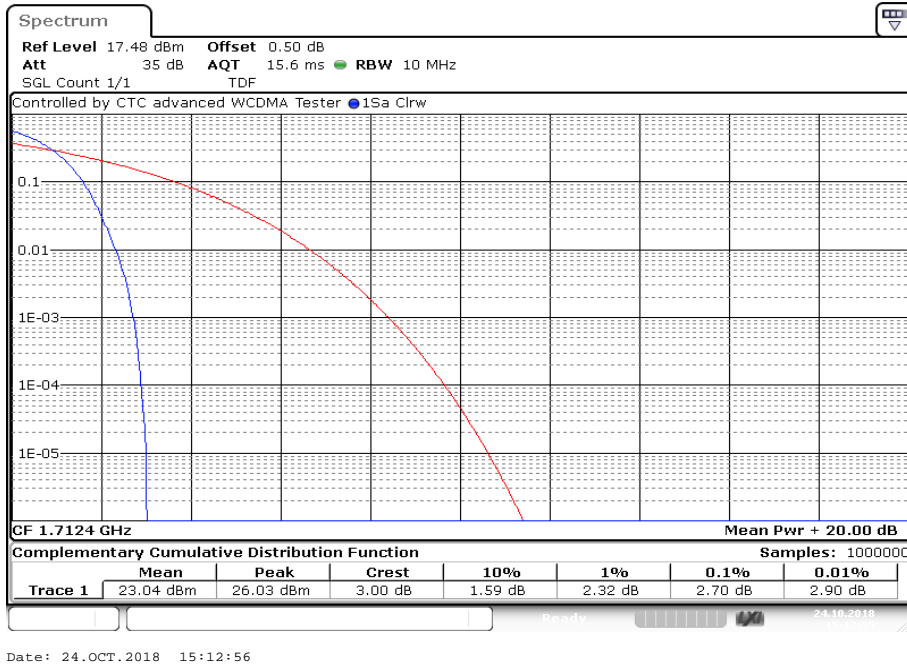

Plot 2: CCDF, channel 1412

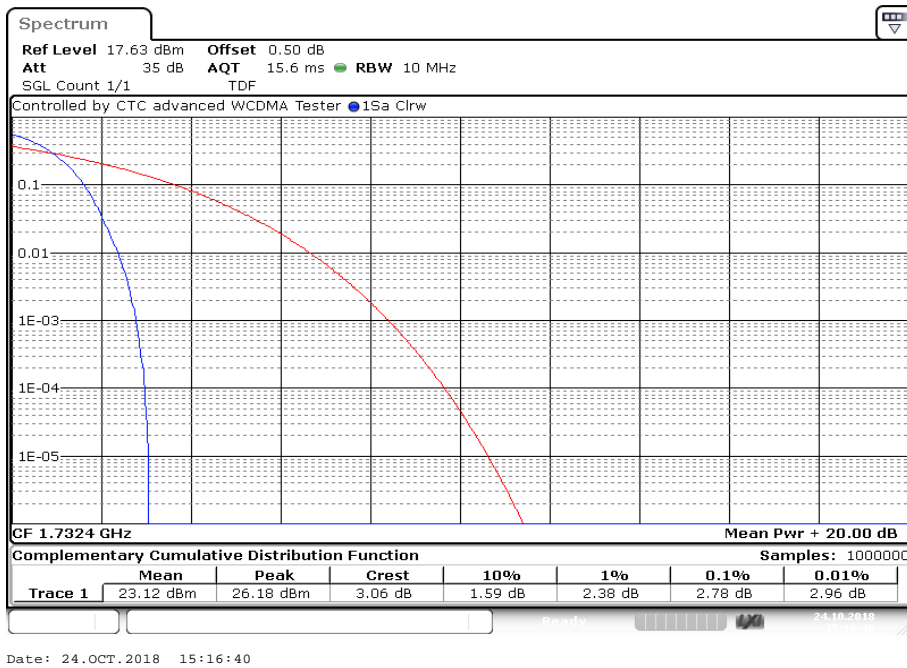

Plot 3: CCDF, channel 1513

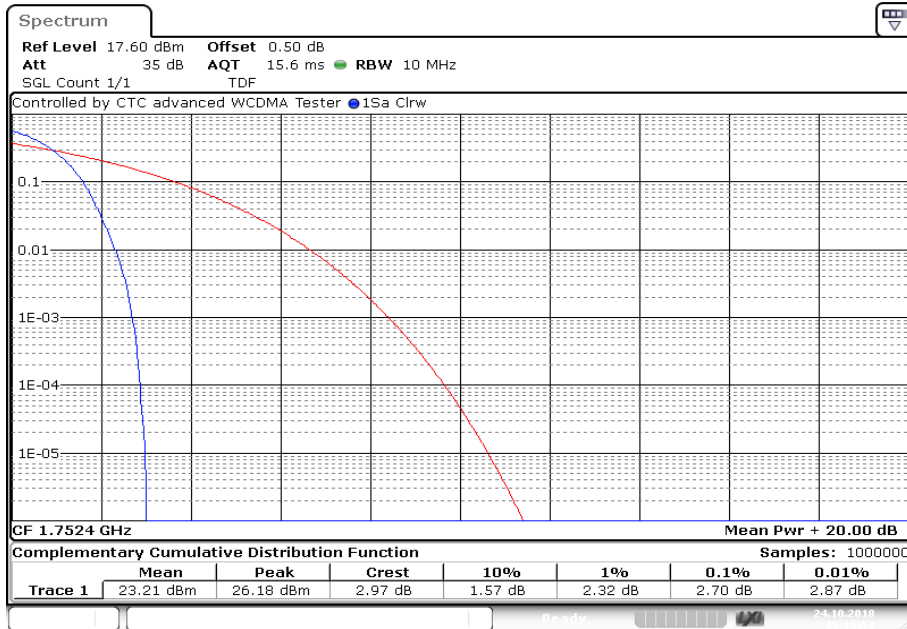

Date: 24.OCT.2018 15:19:52

12.2 Spurious emissions radiated

Description:

The following steps outline the procedure used to measure the radiated emissions from the mobile station. The site is constructed in accordance with ANSI C63.4:2014 requirements and is recognized by the FCC to be in compliance for a 3 and a 10 meter site. The spectrum was scanned from 30 MHz to the 10th harmonic of the highest frequency generated within the equipment, which is the transmitted carrier that can be as high as 1755 MHz. Measurement made up to 25 GHz. The resolution bandwidth is set as outlined in Part 27.53.

Measurement:

Measurement parameters	
Detector:	Peak
Sweep time:	2 sec.
Resolution bandwidth:	1 MHz
Video bandwidth:	3 MHz
Span:	100 MHz Steps
Trace mode:	Max hold
Used equipment:	See chapter 6.1 – B, 6.2 – A & C, 6.3 – B
Measurement uncertainty:	See chapter 7

Limits:

FCC	IC
CFR Part 27.53(g) CFR Part 2.1053	RSS 139
Spurious Emissions Radiated	
Attenuation $\geq 43 + 10\log(P)$ (P, Power in Watts)	
-13 dBm	

Results UMTS band IV:

Radiated emissions measurements were made only at the center carrier frequencies of the band IV (1732.4 MHz) to show the compliance with cabinet radiation limits.

SPURIOUS EMISSION LEVEL (dBm)								
Harmonic	Ch. 1312 Freq. (MHz)	Level [dBm]	Harmonic	Ch. 1412 Freq. (MHz)	Level [dBm]	Harmonic	Ch. 1513 Freq. (MHz)	Level [dBm]
2	3424.8	-	2	3464.8	-	2	3505.2	-
3	5137.2	-	3	5197.2	-	3	5257.8	-
4	6849.6	-	4	6929.6	-	4	7010.4	-
5	8562.0	-	5	8662.0	-	5	8763.0	-
6	10274.4	-	6	10394.4	-	6	10515.6	-
7	11986.8	-	7	12126.8	-	7	12268.2	-
8	13699.2	-	8	13859.2	-	8	14020.8	-
9	15411.6	-	9	15591.6	-	9	15773.4	-
10	17124.0	-	10	17324.0	-	10	17526.0	-

Plots:

Plot 1: Channel 1412 (Traffic mode up to 30 MHz)

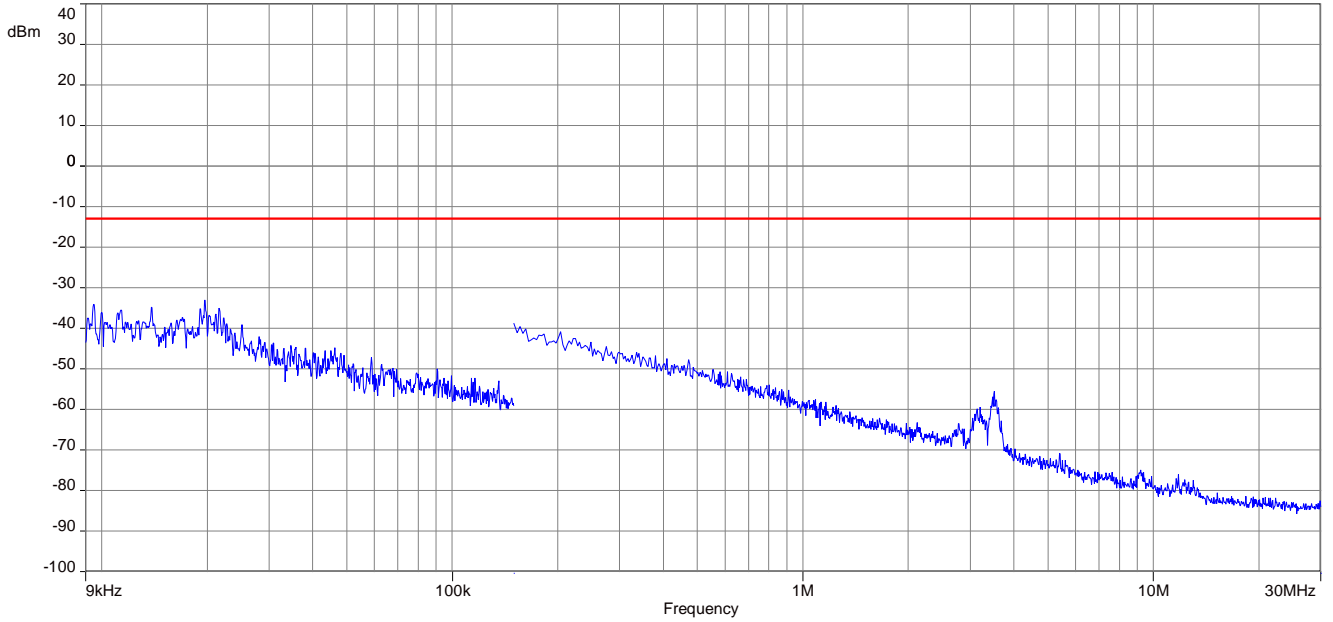

Plot 2: Channel 1412 (30 MHz – 1 GHz)

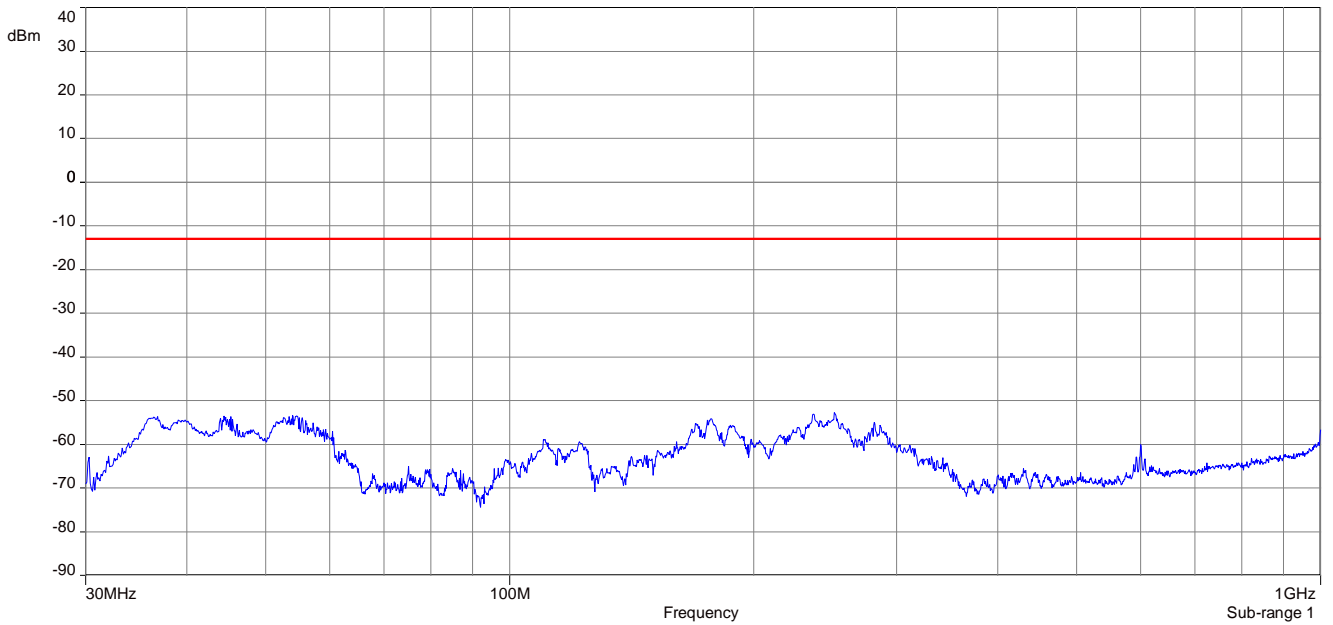

Plot 3: Channel 1412 (1 GHz – 18 GHz)

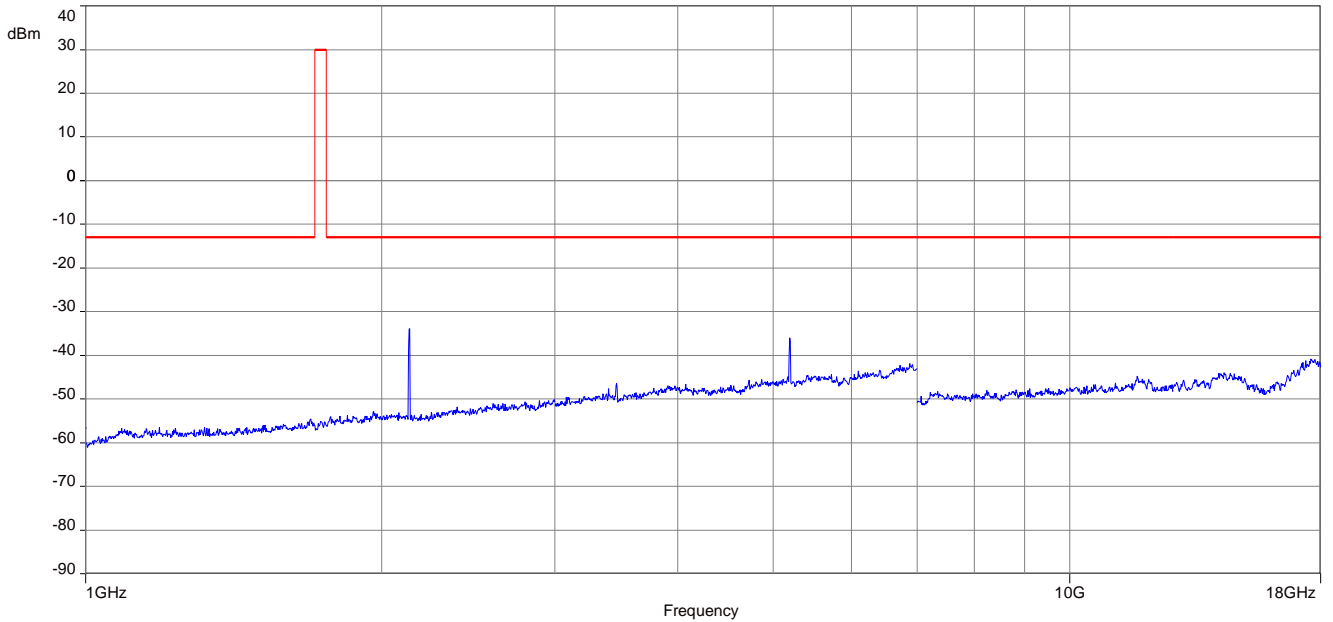

Carrier notched with 1.75 GHz rejection filter

Plot 4: Channel 1412 (18 GHz – 26 GHz)

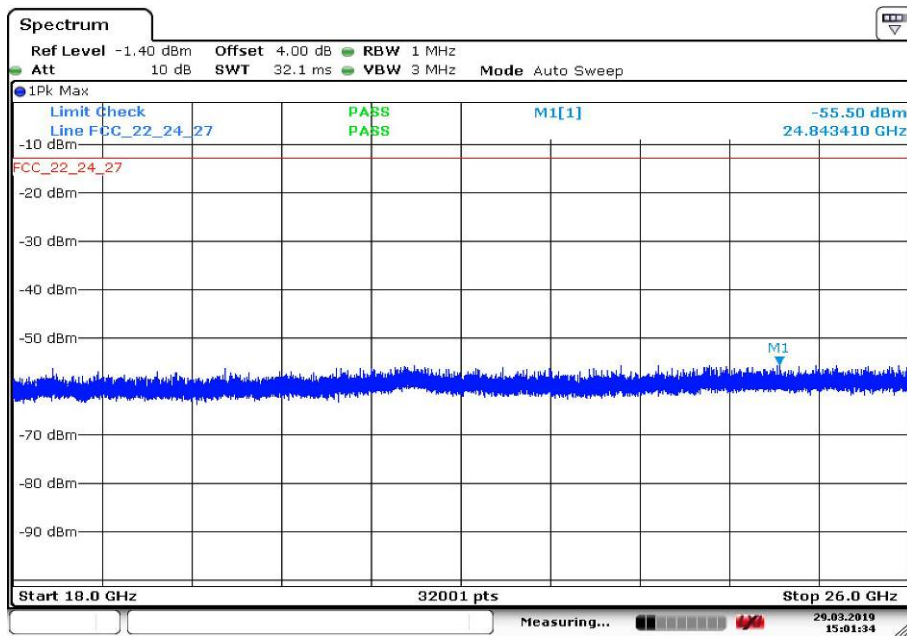

Date: 29.MAR.2019 15:01:34

13 Results UMTS band V

All UMTS-band measurements are done in WCDMA mode only.
The connection was established with the following setup: WCDMA CS-RMC, Max Power (All Bit up)

13.1 RF output power

Description:

This paragraph contains average power, peak output power and ERP measurements for the mobile station. In all cases, the peak output power is within the required mask (this mask is specified in the JTC standards, TIA PN3389 Vol. 1 Chap 7, and is no FCC requirement).

Measurement:

The mobile was set up for the maximum output power with pseudo random data modulation.

To determine the Peak-To-Average Power Ratio (PAPR) the measurement was performed with the Power Complementary Cumulative Distribution Function (CCDF).

Measurement parameters	
Detector:	Peak and RMS (Power in Burst)
Sweep time:	Auto
Video bandwidth:	10 MHz
Resolution bandwidth:	10 MHz
Span:	Zero Span
Trace mode:	Max hold
Used equipment:	See chapter 6.1 – B & 6.4 – B
Measurement uncertainty:	See chapter 7

Limits:

FCC	IC
CFR Part 22.913 CFR Part 2.1046	RSS 132
Nominal Peak Output Power	
+38.45 dBm In measuring transmissions in this band using an average power technique, the peak-to-average ratio (PAR) of the transmission may not exceed 13 dB.	

Results:

Output Power (conducted) WCDMA mode		
Frequency (MHz)	Average Output Power (dBm)	Peak to Average Ratio (dB)
826.4	24.1	3.0
836.0	23.8	3.0
846.6	23.9	2.8

Output Power (radiated) WCDMA mode	
Frequency (MHz)	Average Output Power (dBm) - ERP
826.4	22.5
836.0	21.9
846.6	21.9

Plots:

Plot 1: CCDF, channel 4132

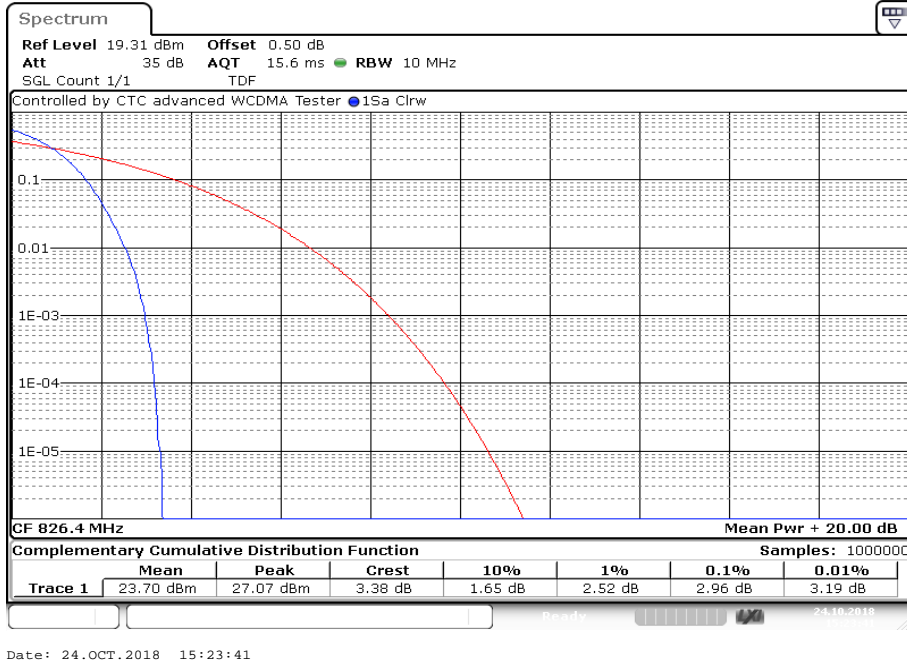

Plot 2: CCDF, channel 4180

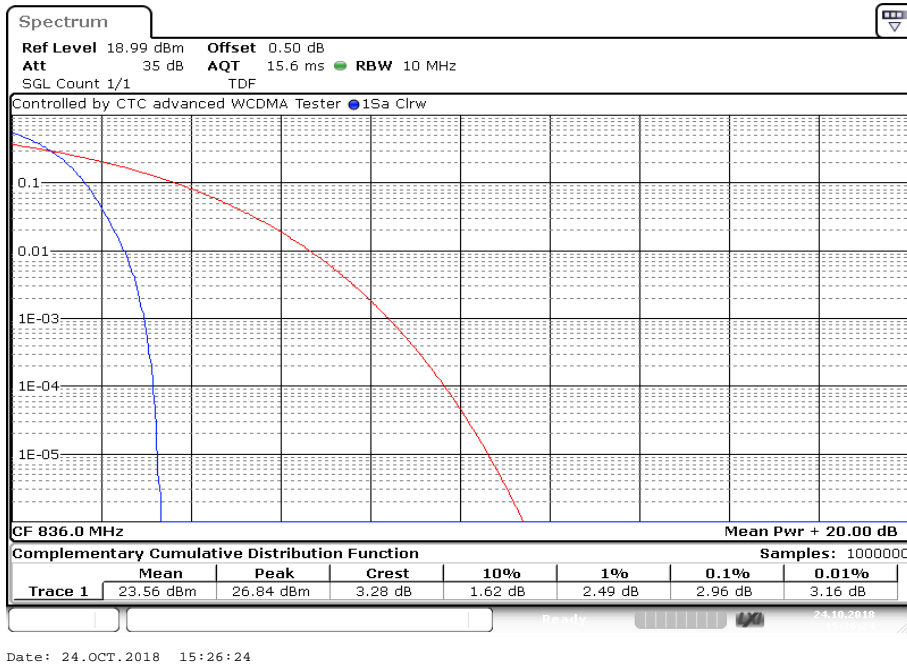

Plot 3: CCDF, channel 4233

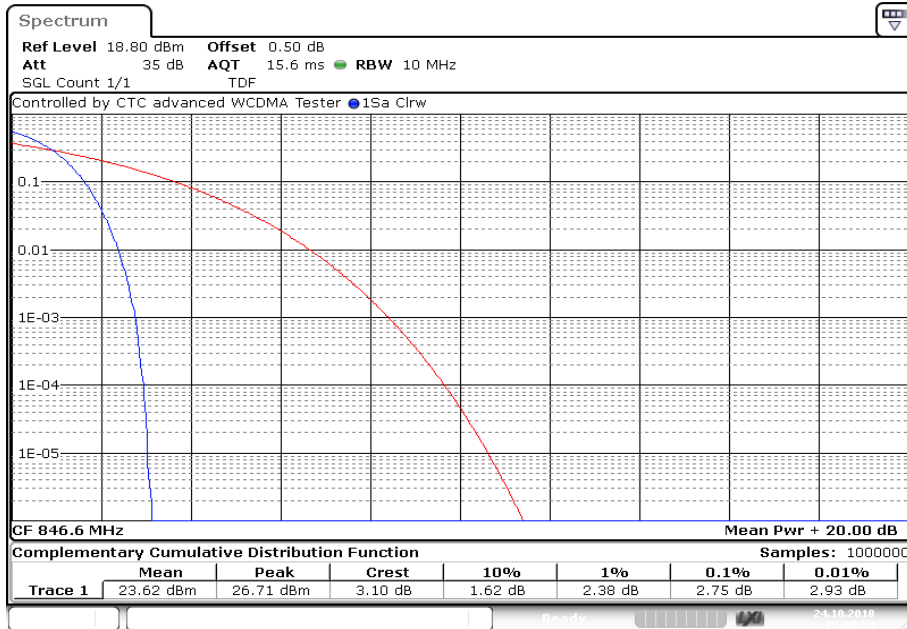

Date: 24.OCT.2018 15:28:35

13.2 Spurious emissions radiated

Description:

The following steps outline the procedure used to measure the radiated emissions from the mobile station. The site is constructed in accordance with ANSI C63.4:2014 requirements and is recognized by the FCC to be in compliance for a 3 and a 10 meter site. The spectrum was scanned from 30 MHz to the 10th harmonic of the highest frequency generated within the equipment, which is the transmitted carrier that can be as high as 848.6 MHz. Measurements made up to 12.75 GHz. The resolution bandwidth is set as outlined in Part 22.917.

Measurement:

Measurement parameters	
Detector:	Peak
Sweep time:	2 s
Resolution bandwidth:	100 kHz
Video bandwidth:	300 kHz
Span:	100 MHz Steps
Trace mode:	Max hold
Used equipment:	See chapter 6.1 – B & 6.2 – A & C
Measurement uncertainty:	See chapter 7

Limits:

FCC	IC
Attenuation $\geq 43 + 10\log(P)$ (P, Power in Watts)	
-13 dBm	

Results UMTS band V:

Radiated emissions measurements were made only at the center carrier frequencies of the band V (836.4 MHz) to show the compliance with cabinet radiation limits.

SPURIOUS EMISSION LEVEL (dBm)								
Harmonic	Ch. 4132 Freq. (MHz)	Level [dBm]	Harmonic	Ch. 4180 Freq. (MHz)	Level [dBm]	Harmonic	Ch. 4233 Freq. (MHz)	Level [dBm]
2	1652.8	-	2	1672.0	-	2	1693.2	-
3	2479.2	-	3	2508.0	-	3	2539.8	-
4	3305.6	-	4	3344.0	-	4	3386.4	-
5	4132.0	-	5	4180.0	-	5	4233.0	-
6	4958.4	-	6	5016.0	-	6	5079.6	-
7	5784.8	-	7	5852.0	-	7	5926.2	-
8	6611.2	-	8	6688.0	-	8	6772.8	-
9	7437.6	-	9	7524.0	-	9	7619.4	-
10	8264.0	-	10	8360.0	-	10	8466.0	-

Plots:

Plot 1: Channel 4180 (Traffic mode up to 30 MHz)

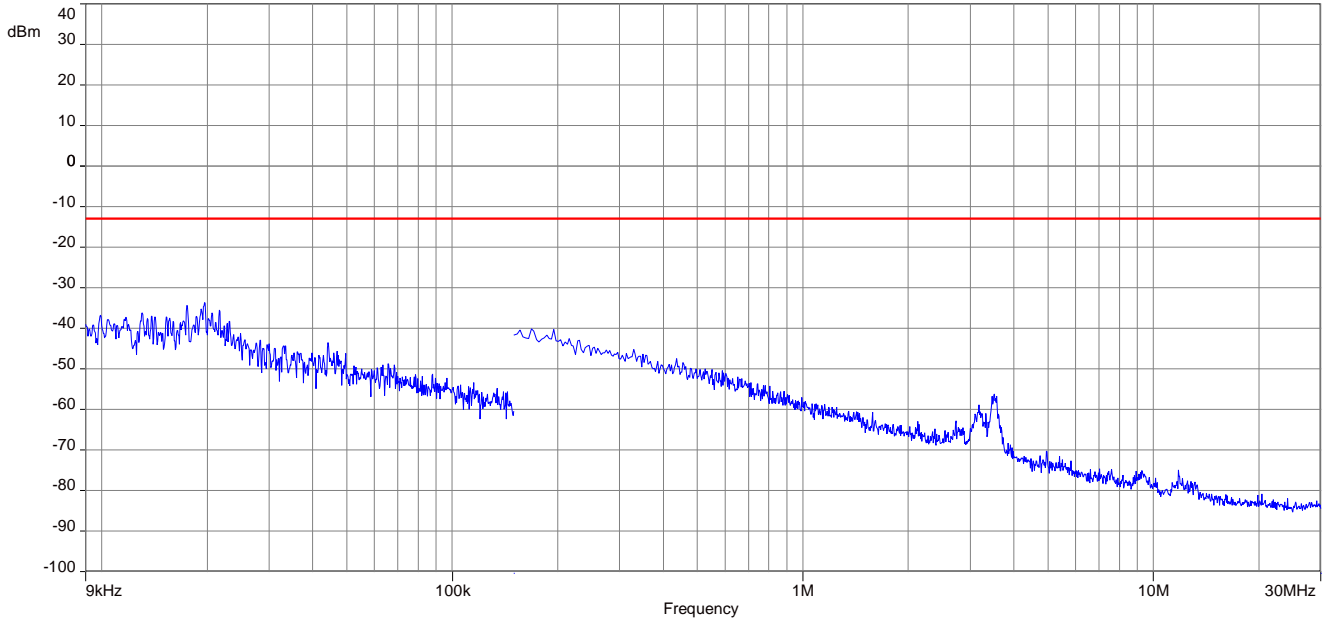

Plot 2: Channel 4180 (30 MHz – 1 GHz)

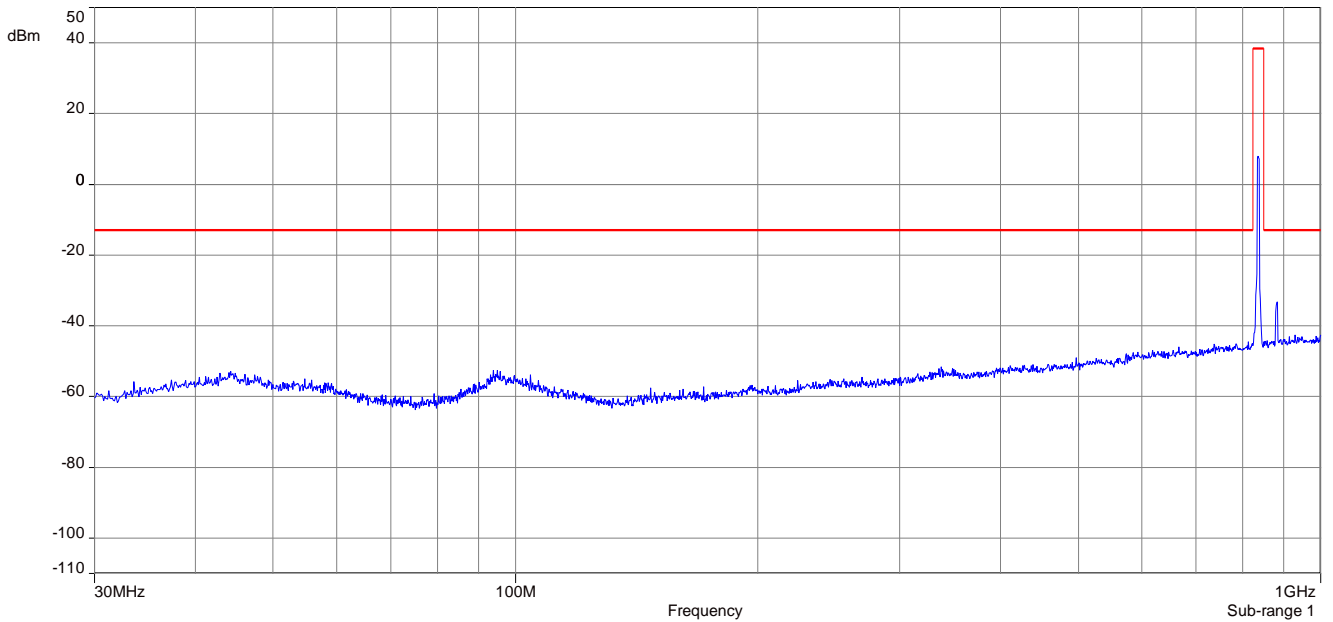

Plot 3: Channel 4180 (1 GHz – 12.75 GHz)

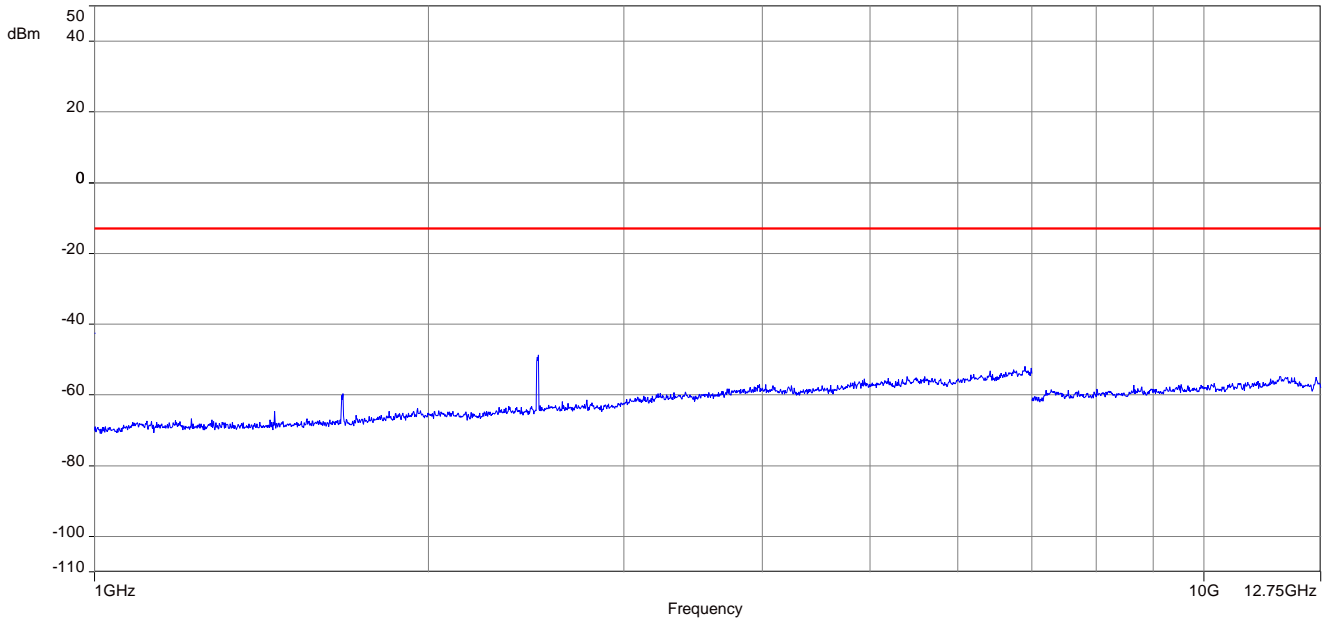

Annex A Glossary

EUT	Equipment under test
DUT	Device under test
UUT	Unit under test
GUE	GNSS User Equipment
ETSI	European Telecommunications Standards Institute
EN	European Standard
FCC	Federal Communications Commission
FCC ID	Company Identifier at FCC
IC	Industry Canada
PMN	Product marketing name
HMN	Host marketing name
HVIN	Hardware version identification number
FVIN	Firmware version identification number
EMC	Electromagnetic Compatibility
HW	Hardware
SW	Software
Inv. No.	Inventory number
S/N or SN	Serial number
C	Compliant
NC	Not compliant
NA	Not applicable
NP	Not performed
PP	Positive peak
QP	Quasi peak
AVG	Average
OC	Operating channel
OCW	Operating channel bandwidth
OBW	Occupied bandwidth
OOB	Out of band
DFS	Dynamic frequency selection
CAC	Channel availability check
OP	Occupancy period
NOP	Non occupancy period
DC	Duty cycle
PER	Packet error rate
CW	Clean wave
MC	Modulated carrier
WLAN	Wireless local area network
RLAN	Radio local area network
DSSS	Dynamic sequence spread spectrum
OFDM	Orthogonal frequency division multiplexing
FHSS	Frequency hopping spread spectrum
GNSS	Global Navigation Satellite System
C/N₀	Carrier to noise-density ratio, expressed in dB-Hz

Annex B Document history

Version	Applied changes	Date of release
-/-	Initial release	2019-04-24

Annex C Accreditation Certificate – D-PL-12076-01-04

first page	last page
 <p>Deutsche Akkreditierungsstelle GmbH</p> <p>Entrusted according to Section 8 subsection 1 AkkStelleG in connection with Section 1 subsection 1 AkkStelleGBV Signatory to the Multilateral Agreements of EA, ILAC and IAF for Mutual Recognition</p> <p>Accreditation </p> <p>The Deutsche Akkreditierungsstelle GmbH attests that the testing laboratory</p> <p>CTC advanced GmbH Untertürkheimer Straße 6-10, 66117 Saarbrücken</p> <p>is competent under the terms of DIN EN ISO/IEC 17025:2005 to carry out tests in the following fields:</p> <p>Telecommunication (TC) and Electromagnetic Compatibility (EMC) for Canadian Standards</p> <p>The accreditation certificate shall only apply in connection with the notice of accreditation of 11.01.2019 with the accreditation number D-PL-12076-01 and is valid until 21.04.2021. It comprises the cover sheet, the reverse side of the cover sheet and the following annex with a total of 7 pages.</p> <p>Registration number of the certificate: D-PL-12076-01-04</p> <p>Frankfurt am Main, 11.01.2019  Dipl.-Biol. Uwe Zimmermann Head of Division</p> <p><small>See reverse coverpage</small></p>	<p>Deutsche Akkreditierungsstelle GmbH</p> <p>Office Berlin Spittelmarkt 10 10117 Berlin</p> <p>Office Frankfurt am Main Europa-Allee 52 60527 Frankfurt am Main</p> <p>Office Braunschweig Bundesallee 100 38116 Braunschweig</p> <p>The publication of extracts of the accreditation certificate is subject to the prior written approval by Deutsche Akkreditierungsstelle GmbH (DAkKS). Exempted is the unchanged form of separate disseminations of the cover sheet by the conformity assessment body mentioned overleaf.</p> <p>No impression shall be made that the accreditation also extends to fields beyond the scope of accreditation attested by DAkKS.</p> <p>The accreditation was granted pursuant to the Act on the Accreditation Body (AkkStelleG) of 31 July 2009 (Federal Law Gazette I p. 2625) and the Regulation (EC) No 765/2008 of the European Parliament and of the Council of 9 July 2008 setting out the requirements for accreditation and market surveillance relating to the marketing of products (Official Journal of the European Union L 218 of 9 July 2008, p. 30). DAkKS is a signatory to the Multilateral Agreements for Mutual Recognition of the European co-operation for Accreditation (EA), International Accreditation Forum (IAF) and International Laboratory Accreditation Cooperation (ILAC). The signatories to these agreements recognise each other's accreditations.</p> <p>The up-to-date state of membership can be retrieved from the following websites: EA: www.european-accreditation.org ILAC: www.ilac.org IAF: www.iaf.eu</p>

Note: The current certificate annex is published on the website (link see below) of the Accreditation Body DAkKS or may be received by CTC advanced GmbH on request

<https://www.dakks.de/as/ast/d/D-PL-12076-01-04.pdf>

Annex D Accreditation Certificate – D-PL-12076-01-05

first page	last page			
 <p>Deutsche Akkreditierungsstelle GmbH</p> <p>Entrusted according to Section 8 subsection 1 AkkStelleG in connection with Section 1 subsection 1 AkkStelleGBV Signatory to the Multilateral Agreements of EA, ILAC and IAF for Mutual Recognition</p> <p>Accreditation </p> <p>The Deutsche Akkreditierungsstelle GmbH attests that the testing laboratory CTC advanced GmbH Untertürkheimer Straße 6-10, 66117 Saarbrücken</p> <p>is competent under the terms of DIN EN ISO/IEC 17025:2005 to carry out tests in the following fields: Telecommunication (FCC Requirements)</p> <p>The accreditation certificate shall only apply in connection with the notice of accreditation of 11.01.2019 with the accreditation number D-PL-12076-01 and is valid until 21.04.2021. It comprises the cover sheet, the reverse side of the cover sheet and the following annex with a total of 5 pages.</p> <p>Registration number of the certificate: D-PL-12076-01-05</p> <p>Frankfurt am Main, 11.01.2019  Dipl.-Biol. Uwe Zimmermann Head of Division</p> <p><small>See annexes on file</small></p>	<p>Deutsche Akkreditierungsstelle GmbH</p> <table border="0"> <tr> <td>Office Berlin Spittelmarkt 10 10117 Berlin</td> <td>Office Frankfurt am Main Europa-Allee 52 60327 Frankfurt am Main</td> <td>Office Braunschweig Bundesallee 100 38116 Braunschweig</td> </tr> </table> <p>The publication of extracts of the accreditation certificate is subject to the prior written approval by Deutsche Akkreditierungsstelle GmbH (DAkkS). Exempted is the unchanged form of separate disseminations of the cover sheet by the conformity assessment body mentioned overleaf.</p> <p>No impression shall be made that the accreditation also extends to fields beyond the scope of accreditation attested by DAkkS.</p> <p>The accreditation was granted pursuant to the Act on the Accreditation Body (AkkStelleG) of 31 July 2009 (Federal Law Gazette I p. 2625) and the Regulation (EC) No 765/2008 of the European Parliament and of the Council of 9 July 2008 setting out the requirements for accreditation and market surveillance relating to the marketing of products (Official Journal of the European Union L 218 of 9 July 2008, p. 30). DAkkS is a signatory to the Multilateral Agreements for Mutual Recognition of the European co-operation for Accreditation (EA), International Accreditation Forum (IAF) and International Laboratory Accreditation Cooperation (ILAC). The signatories to these agreements recognise each other's accreditations.</p> <p>The up-to-date state of membership can be retrieved from the following websites: EA: www.european-accreditation.org ILAC: www.ilac.org IAF: www.iaf.nu</p>	Office Berlin Spittelmarkt 10 10117 Berlin	Office Frankfurt am Main Europa-Allee 52 60327 Frankfurt am Main	Office Braunschweig Bundesallee 100 38116 Braunschweig
Office Berlin Spittelmarkt 10 10117 Berlin	Office Frankfurt am Main Europa-Allee 52 60327 Frankfurt am Main	Office Braunschweig Bundesallee 100 38116 Braunschweig		

Note: The current certificate annex is published on the website (link see below) of the Accreditation Body DAkkS or may be received by CTC advanced GmbH on request

<https://www.dakks.de/as/ast/d/D-PL-12076-01-05.pdf>

END OF TEST REPORT