

EMC TEST REPORT

No. 150500694SHA-001

Applicant : NINGBO COMEN ELECTRONICS
TECHNOLOGY CO., LTD
No.599 Jinda Road, Zhenhai Economic
Development Zone, 315221 Ningbo, P.R. China

Manufacturer : NINGBO COMEN ELECTRONICS
TECHNOLOGY CO., LTD
No.599 Jinda Road, Zhenhai Economic
Development Zone, 315221 Ningbo, P.R. China

Product Name : Adaptor

Type/Model : PA-US1-01W, PA-USA-01W

TEST RESULT : PASS

SUMMARY

The equipment complies with the requirements according to the following standard(s) or specification:

47CFR Part 15 (2014): Radio Frequency Devices (Subpart C)

ANSI C63.10 (2013): American National Standard of Procedures for Compliance Testing of Unlicensed Wireless Devices

RSS-247 Issue 1 (May 2015): Digital Transmission Systems (DTSs), Frequency Hopping Systems (FHSs) and Licence-Exempt Local Area Network (LE-LAN) Devices

RSS-Gen Issue 4 (December 2014): General Requirements for Compliance of Radio Apparatus

Date of issue: July 20, 2015

Prepared by:



Nemo Li (*Project Engineer*)

Reviewed by:



Daniel Zhao (*Reviewer*)



Description of Test Facility

Name: Intertek Testing Service Limited Shanghai
Address: Building No.86, 1198 Qinzhou Road(North), Shanghai 200233, P.R.
China

FCC Registration Number: 236597
IC Assigned Code: 2402B-1

Name of contact: Jonny Jing
Tel: 86 21 61278271
Fax: 86 21 54262353

Content

SUMMARY	1
1 GENERAL INFORMATION	5
1.1 Description of Client.....	5
1.2 Identification of the EUT.....	5
1.3 Technical Specification.....	6
2 TEST SPECIFICATIONS	7
2.1 Standards or specification	7
2.2 Mode of operation during the test.....	7
2.3 Test software list	8
2.4 Test peripherals list	8
2.5 Instrument list	9
2.6 Test Summary	10
3 MINIMUM 6dB BANDWIDTH	11
3.1 Limit.....	11
3.2 Test Configuration	11
3.3 Test Procedure and test setup.....	11
3.4 Test Protocol	12
4 MAXIMUM CONDUCTED OUTPUT POWER	20
4.1 Test limit	20
4.2 Test Configuration	20
4.3 Test procedure and test setup.....	21
4.4 Test protocol	22
5 POWER SPECTRUM DENSITY	23
5.1 Test limit	23
5.2 Test Configuration	23
5.3 Test procedure and test setup.....	24
5.4 Test Protocol	25
6 EMISSION OUTSIDE THE FREQUENCY BAND	33
6.1 Test limit	33
6.2 Test Configuration	33
6.3 Test procedure and test setup.....	33
6.4 Test Protocol	35
7 RADIATED EMISSIONS IN RESTRICTED FREQUENCY BANDS	75
7.1 Test limit	75
7.2 Test Configuration	75
7.3 Test procedure and test setup.....	76
7.4 Test Protocol	77
8 POWER LINE CONDUCTED EMISSION	82
8.1 Limit.....	82
8.2 Test configuration	82
8.3 Test procedure and test set up.....	83
8.4 Test protocol	84
9 OCCUPIED BANDWIDTH	86
9.1 Test limit	86
9.2 Test Configuration	86



9.3 Test procedure and test setup 86
9.4 Test protocol 87

1 GENERAL INFORMATION

1.1 Description of Client

Applicant : NINGBO COMEN ELECTRONICS TECHNOLOGY
CO., LTD
No.599 Jinda Road, Zhenhai Economic Development
Zone, 315221 Ningbo, P.R. China

Name of contact : Mark Shi
Tel : 86 574 86627858
Fax : 86 574 86627878
Email : rd@commen.com

Manufacturer : NINGBO COMEN ELECTRONICS TECHNOLOGY
CO., LTD
No.599 Jinda Road, Zhenhai Economic Development
Zone, 315221 Ningbo, P.R. China

1.2 Identification of the EUT

Product Name : Adaptor
Type/model : PA-US1-01W, PA-USA-01W
FCC ID : XK8-PAUS101W
IC : 8476A-PAUS101W

1.3 Technical Specification

Operation Frequency : 2400~2483.5 MHz;
Band
Type of Modulation : CCK,BPSK,QPSK,DSSS,OFDM
EUT Modes of : 802.11b/g;
Modulation : 802.11n HT20, 802.11n HT40;
Channel Number : 11Channel for 2412MHz~2462MHz for 11b,11g,11n
(HT20);
7 Channel for 2422MHz~2452MHz for 11n(HT40);
Description of EUT : The EUT is an adaptor containing Wi-Fi module and has
only one model.
Port identification : Power ports
Antenna : PCB antenna, 2.18dBi
Rating : 110-125V~, 60Hz
Category of EUT : Class B
EUT type : Table top
 Floor standing
Sample received date : May 28, 2015
Sample Identification : --
No
Date of test : May 28, 2015 – June 18, 2015

2 TEST SPECIFICATIONS

2.1 Standards or specification

47CFR Part 15 (2014)
RSS-247 Issue 1 (May 2015)
RSS-Gen Issue 4 (December 2014)
ANSI C63.10 (2013)
KDB 558074 (v03r03)

2.2 Mode of operation during the test

While testing transmitting mode of EUT, the internal modulation and continuously transmission was applied.

The lowest, middle and highest channel were tested as representatives.

Freq. Band	Modulation	Lowest(MHz)	Middle(MHz)	Highest(MHz)
2400-2483.5 MHz	802.11b	2412	2437	2462
	802.11g	2412	2437	2462
	802.11n(HT20)	2412	2437	2462
	802.11n(HT40)	2422	2437	2452

Test software setting:

The power level setting for 802.11b/g/n is used with SecureCRT software offered by the manufactory.

Mode 1	Frequency (MHz)	Power level Setting	Note
802.11b	2412	32	-
	2437	32	-
	2462	32	-
802.11g	2412	32	-
	2437	32	-
	2462	32	-
802.11n(HT20)	2412	32	-
	2437	32	-
	2462	32	-
802.11n(HT40)	2422	32	-
	2437	32	-
	2452	32	-

Data rate VS Power

The pre-scan for the conducted power with all rates in each modulation and bands was used, and the worst case was found and used in all test cases.

After this pre-scan, we choose the following table of the data rate as the worst case.

Freq. Band	Modulation	Worst case data rate
2400-2483.5MHz	802.11b	1Mbps
	802.11g	6Mbps
	802.11n(HT20)	MCS0
	802.11n(HT40)	MCS0

Duty cycle:

Duty cycle	Duty cycle(x)	Duty cycle factor (dB)
802.11b	1.00	0.00
802.11g	1.00	0.00
802.11n20	1.00	0.00
802.11n40	1.00	0.00

2.3 Test software list

Test Items	Software	Manufacturer	Version
Conducted emission	ESxS-K1	R&S	V2.1.0
Radiated emission	ES-K1	R&S	V1.71

2.4 Test peripherals list

Item No.	Name	Band and Model	Description
1	Laptop computer	HP ProBook 6470b	Only used for configure, not used during the test
2	Incandescent lamp	-	-

2.5 Instrument list

Equipment	Type	Manu.	Internal no.	Cal. Date	Due date
Test Receiver	ESCS 30	R&S	EC 2107	2014-10-21	2015-10-20
Test Receiver	ESIB 26	R&S	EC 3045	2014-10-20	2015-10-19
Test Receiver	ESCI 7	R&S	EC4501	2014-12-29	2015-12-28
Spectrum Analyzer	N9010	Agilent	EC4890	2014-10-21	2015-10-20
Spectrum Analyzer	E4446	Agilent	/	2014-10-21	2015-10-20
Power meter	ML 2495A	Anritsu	EC 4895	2014-10-21	2015-10-20
A.M.N.	ESH2-Z5	R&S	EC 3119	2015-1-9	2016-1-8
Bilog Antenna	CBL 6112D	TESEQ	EC 4206	2015-5-15	2016-5-14
Horn antenna	HF 906	R&S	EC 3049	2015-5-12	2016-5-11
Pre-amplifier	Pre-amp 18	R&S	EC 3222	2015-4-11	2016-4-10
Pre-amplifier	Tpa0118-40	R&S	EC 4792-2	2015-4-11	2016-4-10
Log-period antenna	AT 1080	AR	EC 3044-7	2015-5-21	2016-5-20
Biconical antenna	3109PX	ETS	EC3564	2014-8-25	2015-8-24
Semi-anechoic chamber	-	Albatross project	EC 3048	2015-5-20	2016-5-19
Shielded room	-	Zhongyu	EC 2838	2015-1-12	2016-1-11
Shielded room	-	Zhongyu	EC 2839	2015-1-12	2016-1-11
High Pass Filter	WHKX 1.0/15G-10SS	Wainwright	EC4297-1	2015-2-1	2016-1-31
High Pass Filter	WHKX 2.8/18G-12SS	Wainwright	EC4297-2	2015-2-1	2016-1-31
High Pass Filter	WHKX 7.0/1.8G-8SS	Wainwright	EC4297-3	2015-2-1	2016-1-31
Band Reject Filter	WRCGV 2400/2483-2390/2493-35/10SS	Wainwright	EC4297-4	2015-2-1	2016-1-31
MXG Analog Signal Generator	N5181A	KEYSIGHT	EC5338-2	2014-11-7	2015-11-6
MXG Vector Signal Generator	N51812B	KEYSIGHT	EC5175	2014-12-30	2015-12-29
Power sensor	U2021XA	KEYSIGHT	EC5338-1	2014-10-2	2015-10-1
PXA Signal Analyzer	N9030A	KEYSIGHT	EC5338	2014-11-18	2015-11-17

2.6 Test Summary

This report applies to tested sample only. The test results have been compared directly with the limits, and the measurement uncertainty is recorded. This report shall not be reproduced in part without written approval of Intertek Testing Service Shanghai Limited.

TEST ITEM	FCC REFERENCE	IC REFERENCE	RESULT
Minimum 6dB Bandwidth & Occupied bandwidth	15.247(a)(2)	RSS-247 Issue 1 Annex 5.2	Pass
Maximum peak output power	15.247(b)	RSS-247 Issue 1 Annex 5.4	Pass
Power spectrum density	15.247(e)	RSS-247 Issue 1 Annex 5.2	Pass
Radiated emission	15.205 & 15.209	RSS-Gen Issue 4 Clause 8.9	Pass
Emission outside the frequency band	15.247(d)	RSS-247 Issue 1 Annex 5.5	Pass
Power line conducted emission	15.207	RSS-Gen Issue 4 Clause 8.8	Pass
Occupied bandwidth	-	RSS-Gen Issue 4 Clause 6.6	Tested

Notes: 1: NA =Not Applicable

3 Minimum 6dB Bandwidth

Test result: Pass

3.1 Limit

For systems using digital modulation techniques that may operate in the 902 - 928 MHz, 2400 - 2483.5 MHz and 5725 - 5850 MHz bands, the minimum 6 dB bandwidth shall be at least 500 kHz.

3.2 Test Configuration

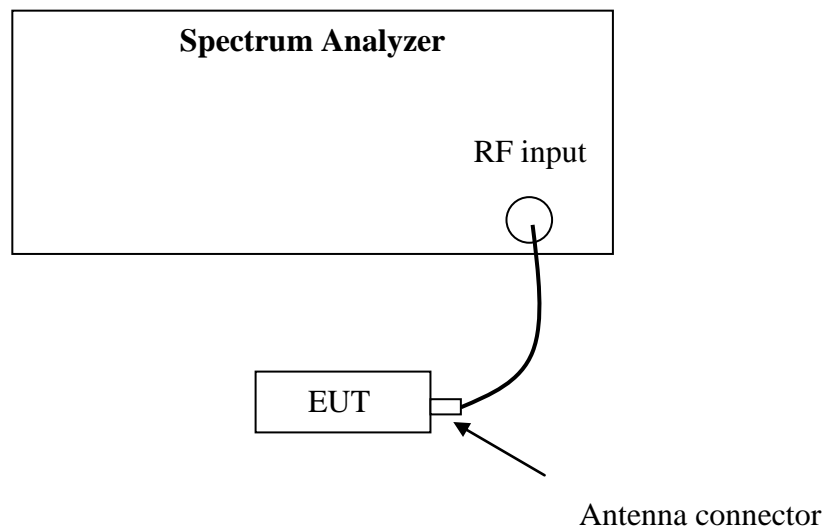

3.3 Test Procedure and test setup

The minimum 6dB bandwidth per FCC §15.247(a)(2) is measured using the Spectrum Analyzer according to DTS test procedure of “KDB558074 D01 DTS Meas Guidance v03r03” for compliance to FCC 47CFR 15.247 requirements (clause 8.2).

- a) Set RBW = 100 kHz.
- b) Set the video bandwidth (VBW) $\geq 3 \times$ RBW.
- c) Detector = Peak.
- d) Trace mode = max hold.
- e) Sweep = auto couple.
- f) Allow the trace to stabilize.
- g) Measure the maximum width of the emission that is constrained by the frequencies associated with the two outermost amplitude points (upper and lower frequencies) that are attenuated by 6 dB relative to the maximum level measured in the fundamental emission.

3.4 Test Protocol

Temperature: 25 °C
Relative Humidity: 55 %

Mode	Channel	Minimum 6dB Bandwidth (MHz)			Limits (MHz)
		Port0	Port 1	Port 2	
802.11b	L	9.12	-	-	> 0.5
	M	9.12	-	-	> 0.5
	H	9.12	-	-	> 0.5

Channel L

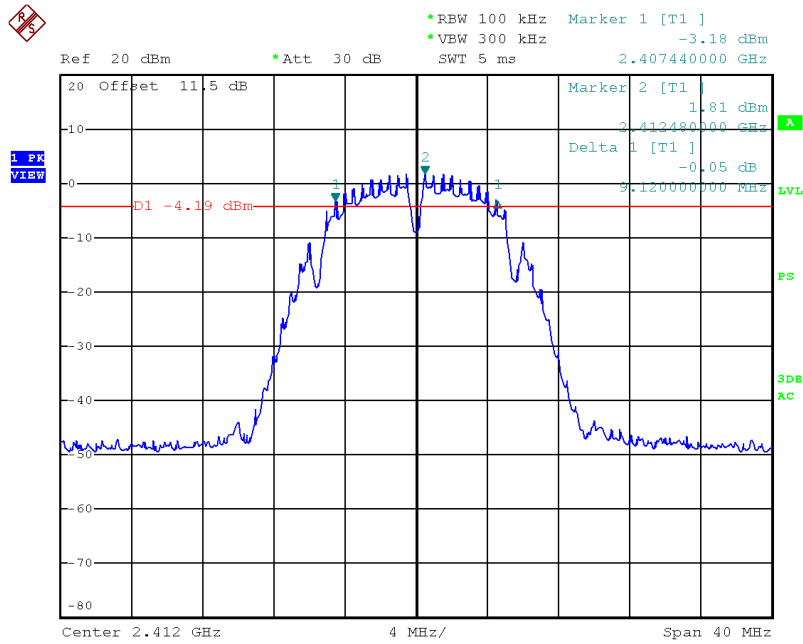

Date: 11.JUN.2015 15:45:22

Channel M

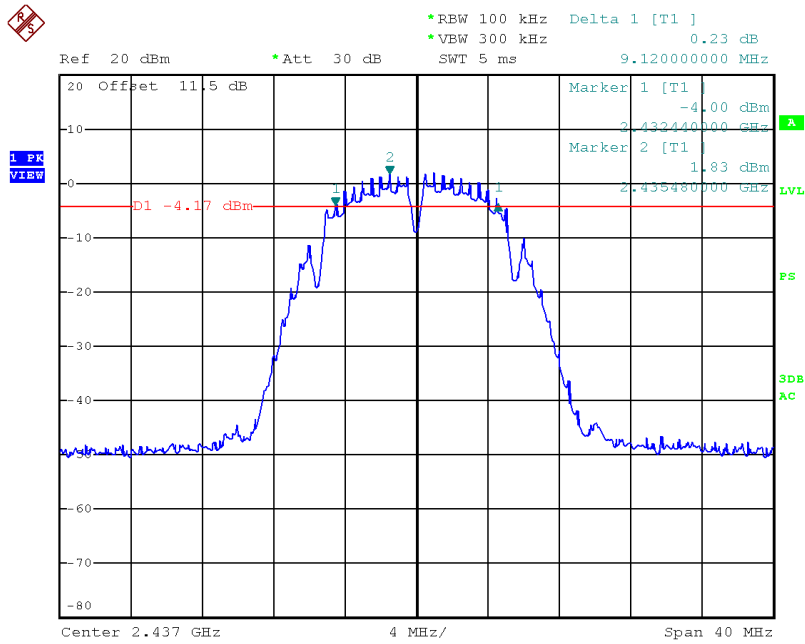

Date: 11.JUN.2015 15:47:22

Channel H

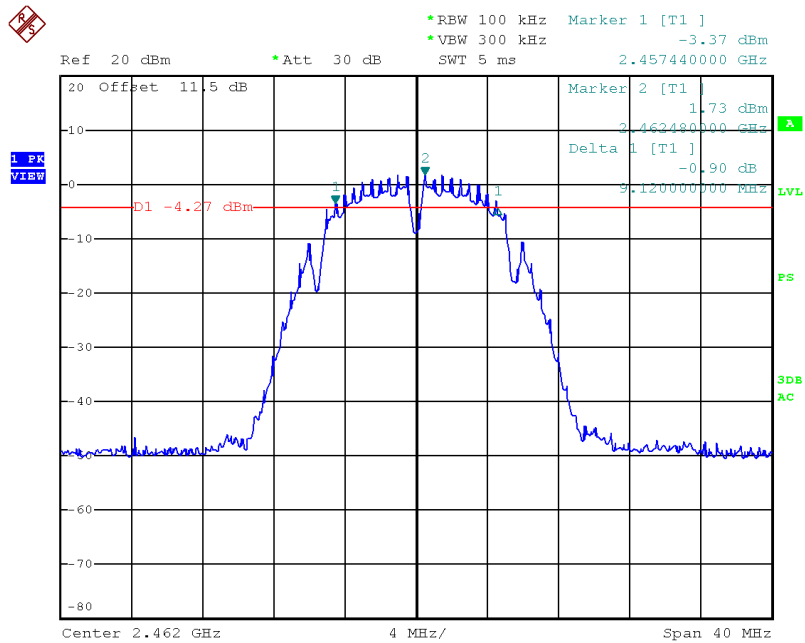

Date: 11.JUN.2015 15:49:09

Channel M

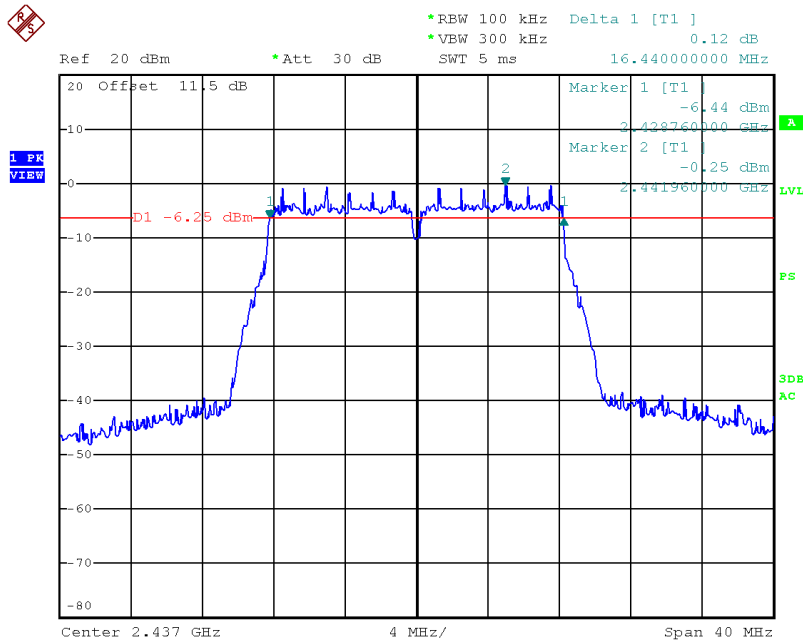

Date: 11.JUN.2015 15:52:03

Channel H

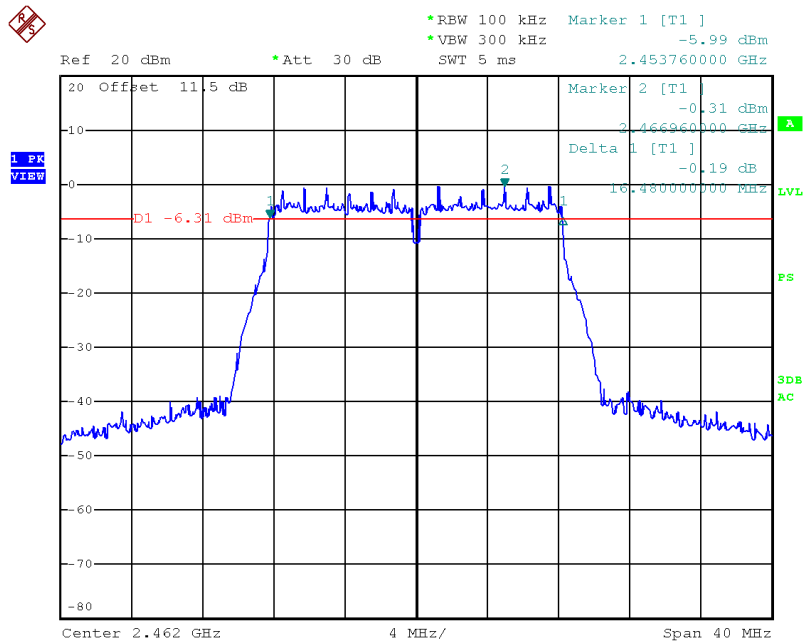

Date: 11.JUN.2015 15:53:13

Mode	Channel	Minimum 6dB Bandwidth (MHz)			Limits (MHz)
		Port0	Port 1	Port 2	
802.11n(HT20)	L	17.68	-	-	> 0.5
	M	17.72	-	-	> 0.5
	H	17.76	-	-	> 0.5

Channel L

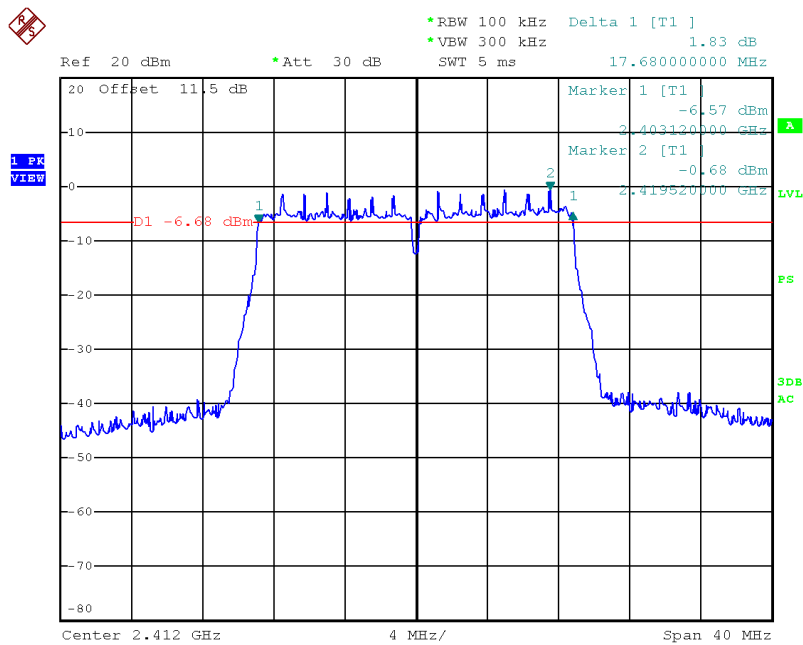

Date: 11.JUN.2015 15:54:40

Channel M

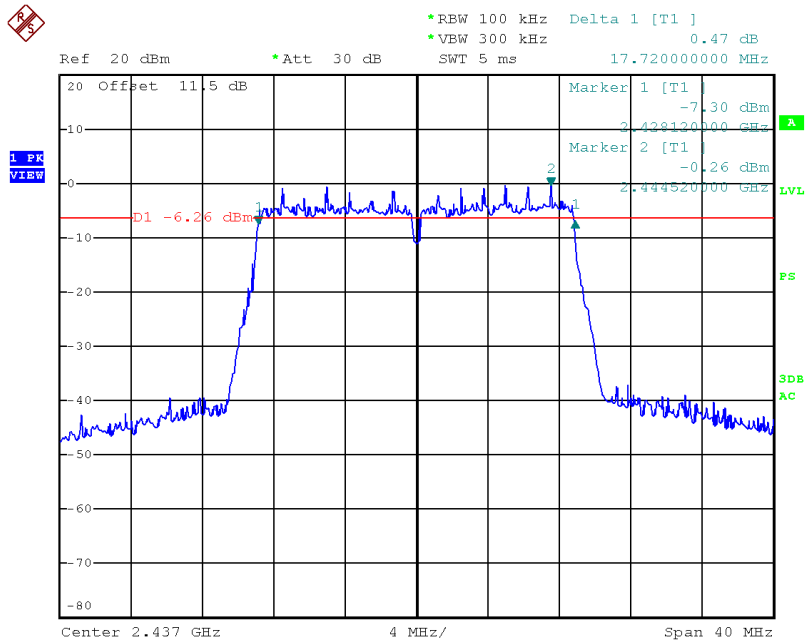

Date: 11.JUN.2015 15:55:55

Channel H

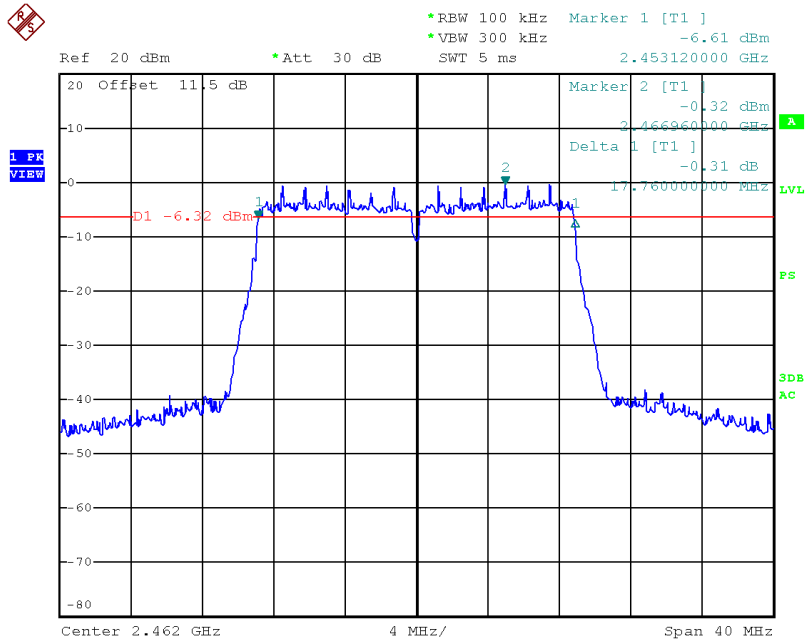

Date: 11.JUN.2015 15:57:02

Mode	Channel	Minimum 6dB Bandwidth (MHz)			Limits (MHz)
		Port0	Port 1	Port 2	
802.11n(HT40)	L	36.16	-	-	> 0.5
	M	36.32	-	-	> 0.5
	H	36.40	-	-	> 0.5

Channel L

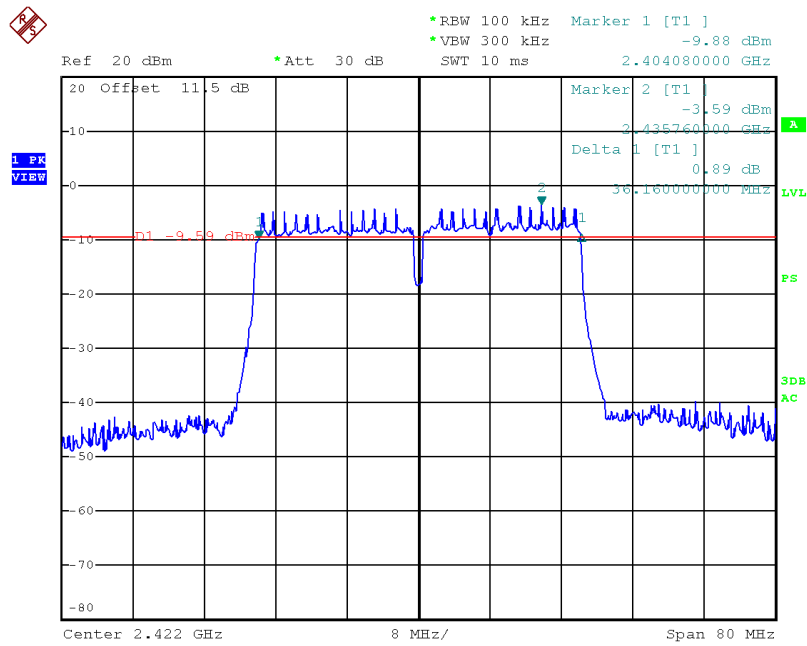

Date: 11.JUN.2015 16:00:03

Channel M

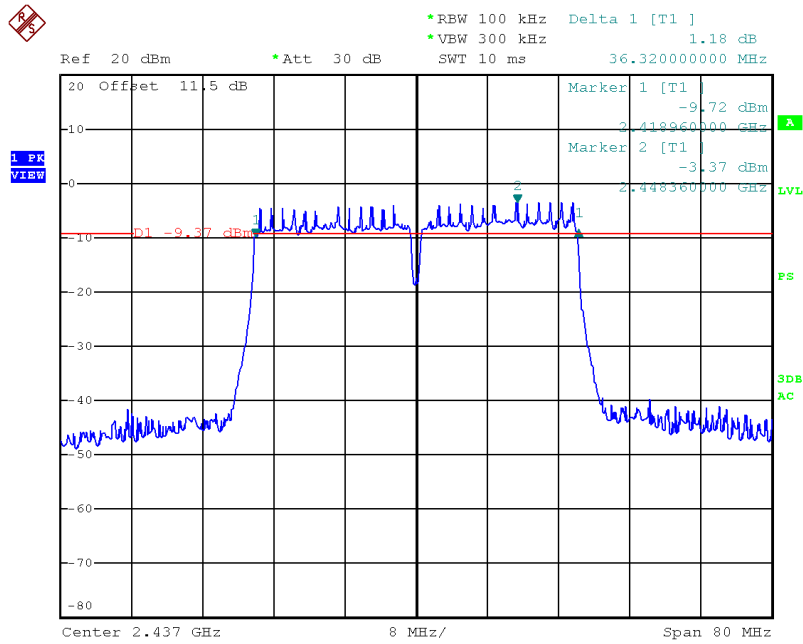

Date: 11.JUN.2015 16:01:19

Channel H

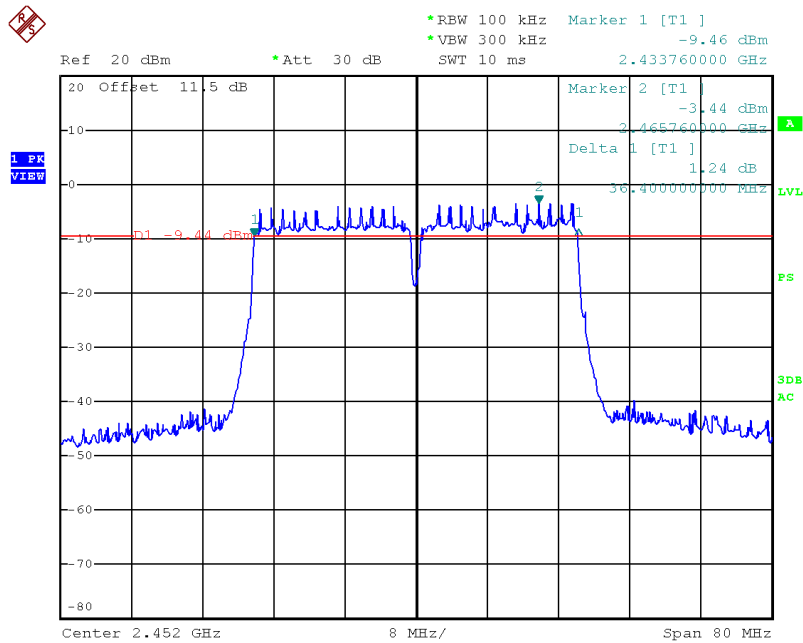

Date: 11.JUN.2015 16:02:52

4 Maximum Conducted Output power

Test result: Pass

4.1 Test limit

- For frequency hopping systems operating in the 2400-2483.5 MHz band employing at least 75 non-overlapping hopping channels, and all frequency hopping systems in the 5725-5850 MHz band: 1 watt
- For all other frequency hopping systems in the 2400-2483.5 MHz band: 0.125 watts
- For systems using digital modulation in the 902-928 MHz, 2400-2483.5 MHz, and 5725-5850 MHz bands: 1 Watt (EIRP: 4 watt).

If the transmitting antenna of directional gain greater than 6dBi is used, the power shall be reduced by the amount in dB that the directional gain of the antenna exceeds 6dBi. If there have a beam forming type, the limit should be the minimum of 30dBm and $30 + (6 - \text{antenna gain} - \text{beam forming gain})$.

4.2 Test Configuration

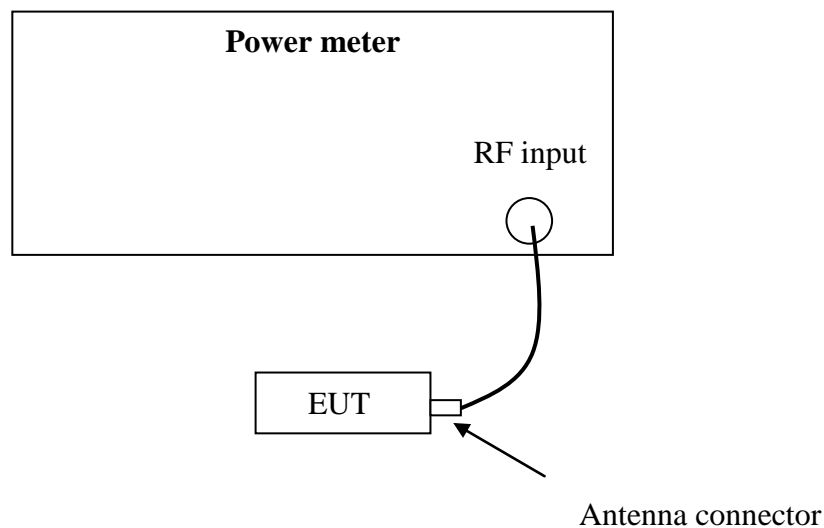

4.3 Test procedure and test setup

The EUT was tested according to DTS test procedure of “KDB558074 D01 DTS Meas Guidance v03r03” for compliance to FCC 47CFR 15.247 requirements (clause 9.1.2).

The maximum peak conducted output power may be measured using a broadband peak RF power meter. The power meter shall have a video bandwidth that is greater than or equal to the DTS bandwidth and shall utilize a fast-responding diode detector.

4.4 Test protocol

Temperature: 25 °C

Relative Humidity: 55 %

Mode	Channel	Reading (dBm)			Total Power (dBm)	Limit (dBm)
		Port0	Port 1	Port 2		
802.11b	L	16.34	-	-	16.34	30
	M	16.80	-	-	16.80	30
	H	16.65	-	-	16.65	30

Mode	Channel	Reading (dBm)			Total Power (dBm)	Limit (dBm)
		Port0	Port 1	Port 2		
802.11g	L	23.90	-	-	23.90	30
	M	24.19	-	-	24.19	30
	H	24.13	-	-	24.13	30

Mode	Channel	Reading (dBm)			Total Power (dBm)	Limit (dBm)
		Port0	Port 1	Port 2		
802.11n (HT20)	L	23.49	-	-	23.17	30
	M	24.15	-	-	23.45	30
	H	24.09	-	-	23.43	30

Mode	Channel	Reading (dBm)			Total Power (dBm)	Limit (dBm)
		Port0	Port 1	Port 2		
802.11n (HT40)	L	23.17	-	-	23.17	30
	M	23.45	-	-	23.45	30
	H	23.43	-	-	23.43	30

The maximum EIRP of the EUT = 24.19dBm + 2.18dBi = 26.37dBm = 433.51mW which is lower than the EIRP limit of RSS-247.

Note:

Reading port x (mW) = $10^{(\text{reading port x (dBm)}/10)}$

x = 0, 1, 2.

Total Power (mW) = reading port 0 (mW) + reading port 1 (mW) + reading port 2 (mW)

Total power (dBm) = $10 * \log(\text{Total power (mW)})$

5 Power spectrum density

Test result: Pass

5.1 Test limit

For digitally modulated systems, the power spectral density conducted from the intentional radiator to the antenna shall not be greater than 8dBm in any 3 kHz band during any time interval of continuous transmission.

If the transmitting antenna of directional gain greater than 6dBi is used, the power shall be reduced by the amount in dB that the directional gain of the antenna exceeds 6dBi. If there have a beam forming type, the limit should be the minimum of 8dBm/MHz and $8 + (6 - \text{antenna gain} - \text{beam forming gain})$.

5.2 Test Configuration

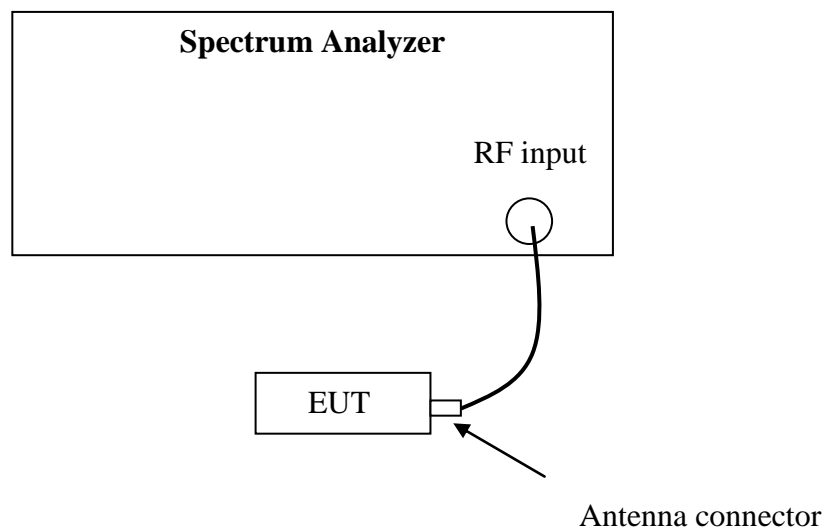

5.3 Test procedure and test setup

The power output per FCC §15.247(e) was tested according to DTS test procedure of “KDB558074 D01 DTS Meas Guidance v03r03” (clause 10.2) for compliance to FCC 47CFR 15.247 requirements.

- a) Set analyzer center frequency to DTS channel center frequency.
- b) Set the span to 1.5 times the *DTS bandwidth*.
- c) Set the RBW to: $3 \text{ kHz} \leq \text{RBW} \leq 100 \text{ kHz}$.
- d) Set the VBW $\geq 3 \times \text{RBW}$.
- e) Detector = peak.
- f) Sweep time = auto couple.
- g) Trace mode = max hold.
- h) Allow trace to fully stabilize.
- i) Use the peak marker function to determine the maximum amplitude level within the RBW.
- j) If measured value exceeds limit, reduce RBW (no less than 3 kHz) and repeat.

5.4 Test Protocol

Temperature: 25 °C
Relative Humidity: 55 %

Mode	Channel	PSD (dBm)			Total PSD (dBm)	Limit (dBm)
		Port 0	Port 1	Port 2		
802.11b	L	1.71	-	-	1.71	8
	M	1.92	-	-	1.92	8
	H	2.26	-	-	2.26	8

Note 1:

$PSD \text{ port } x \text{ (mW)} = 10^{(PSD \text{ port } x \text{ (dBm)} / 10); x = 0, 1, 2.$
 $Total \text{ PSD (mW)} = PSD \text{ port } 0 \text{ (mW)} + PSD \text{ port } 1 \text{ (mW)} + PSD \text{ port } 2 \text{ (mW)}$
 $Total \text{ PSD (dBm)} = 10 * \log (Total \text{ PSD (mW)})$

Channel L

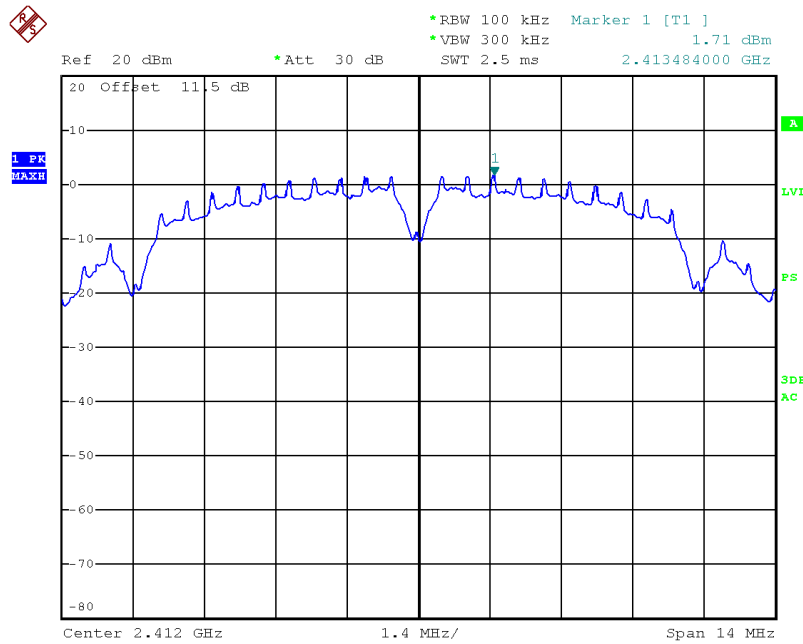

Date: 11.JUN.2015 16:25:48

Channel M

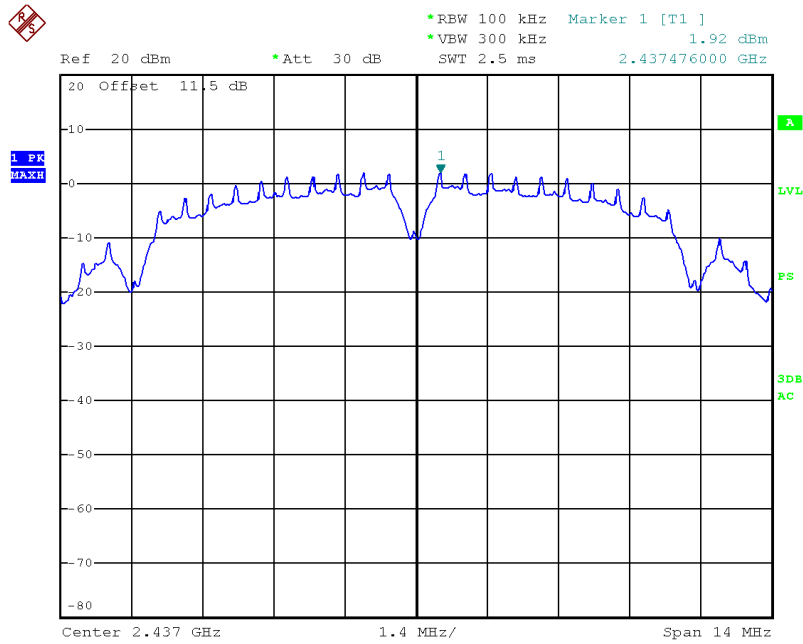

Date: 11.JUN.2015 16:26:30

Channel H

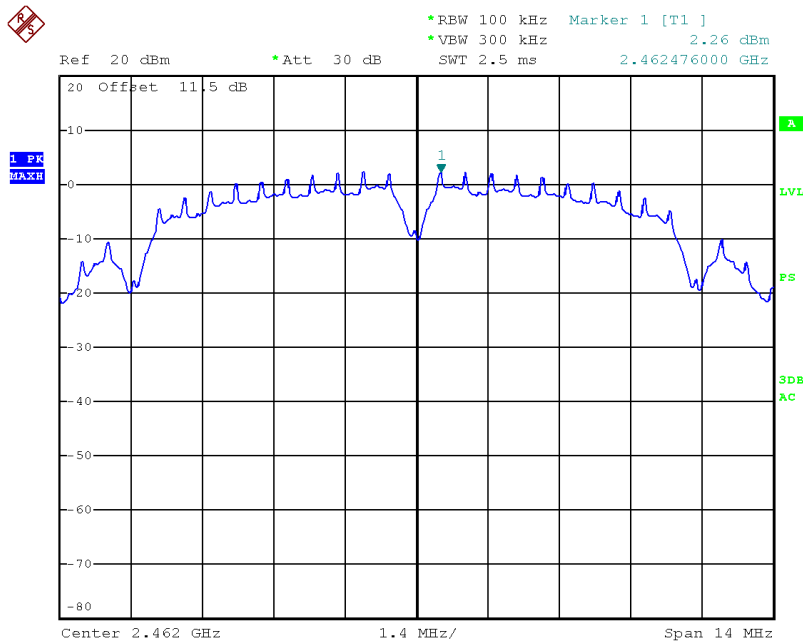

Date: 11.JUN.2015 16:27:14

Mode	Channel	PSD (dBm)			Total PSD (dBm)	Limit (dBm)
		Port 0	Port 1	Port 2		
802.11g	L	-0.41	-	-	-0.41	8
	M	-0.55	-	-	-0.55	8
	H	-0.18	-	-	-0.18	8

Note 1:

$$\text{PSD port } x \text{ (mW)} = 10^{(\text{PSD port } x \text{ (dBm)}/10)}; x = 0, 1, 2.$$

$$\text{Total PSD (mW)} = \text{PSD port 0 (mW)} + \text{PSD port 1 (mW)} + \text{PSD port 2 (mW)}$$

$$\text{Total PSD (dBm)} = 10 * \log(\text{Total PSD (mW)})$$

Channel L

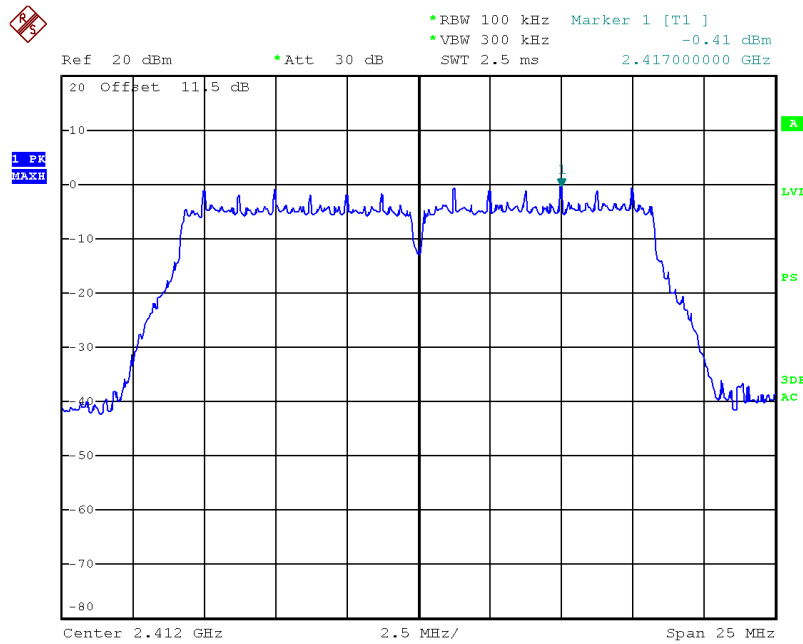

Date: 11.JUN.2015 16:28:15

Channel M

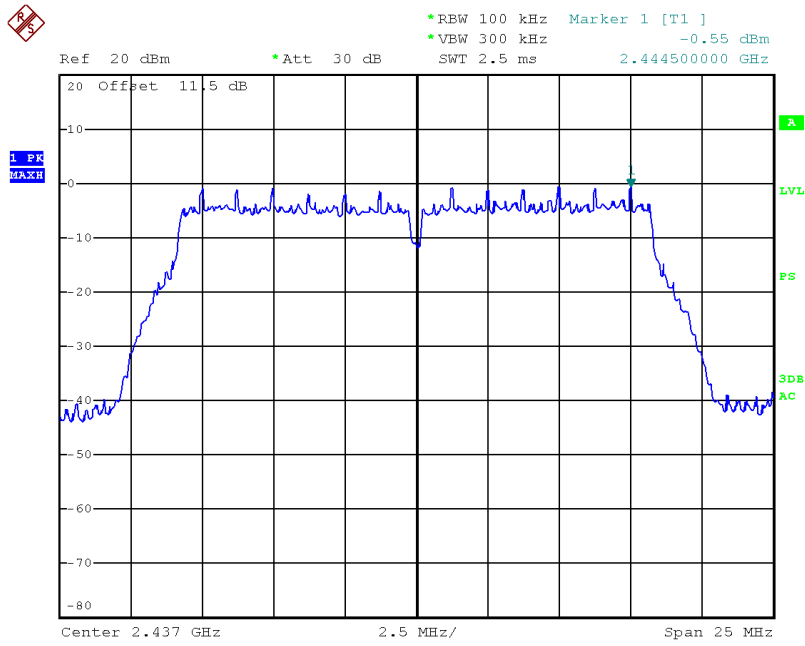

Date: 11.JUN.2015 16:29:19

Channel H

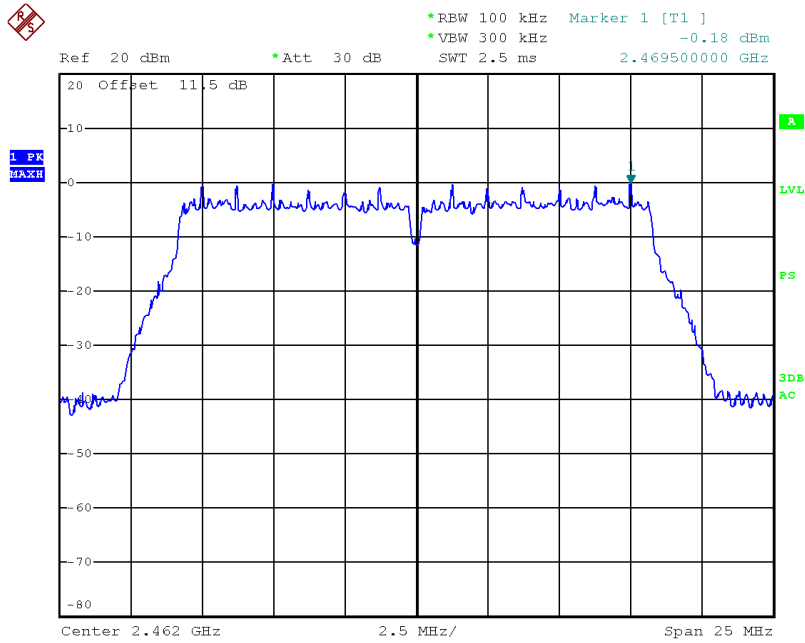

Date: 11.JUN.2015 16:30:01

Mode	Channel	PSD (dBm)			Total PSD (dBm)	Limit (dBm)
		Port 0	Port 1	Port 2		
802.11n (HT20)	L	-0.31	-	-	-0.31	8
	M	-0.13	-	-	-0.13	8
	H	-0.11	-	-	-0.11	8

Note 1:

$$\text{PSD port } x \text{ (mW)} = 10^{(\text{PSD port } x \text{ (dBm)}/10)}; x = 0, 1, 2.$$

$$\text{Total PSD (mW)} = \text{PSD port 0 (mW)} + \text{PSD port 1 (mW)} + \text{PSD port 2 (mW)}$$

$$\text{Total PSD (dBm)} = 10 * \log(\text{Total PSD (mW)})$$

Channel L

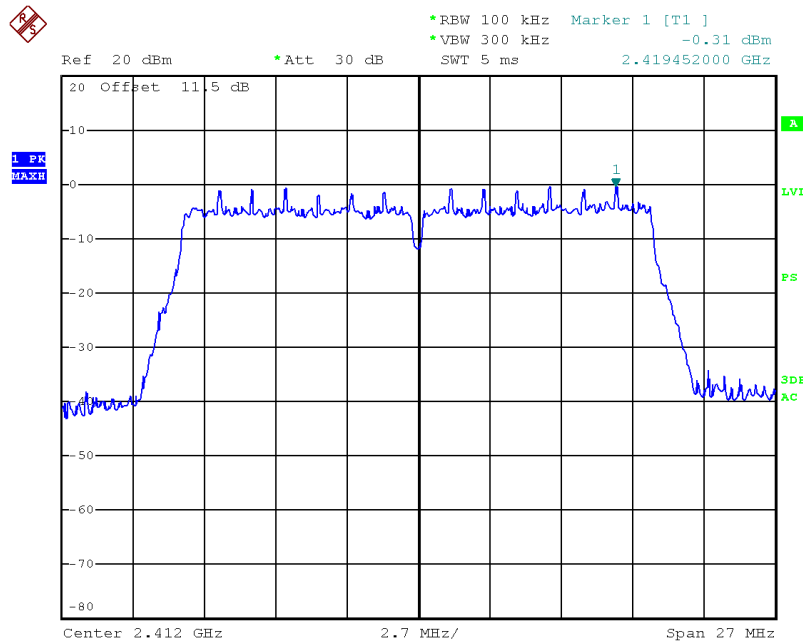

Date: 11.JUN.2015 16:30:48

Channel M

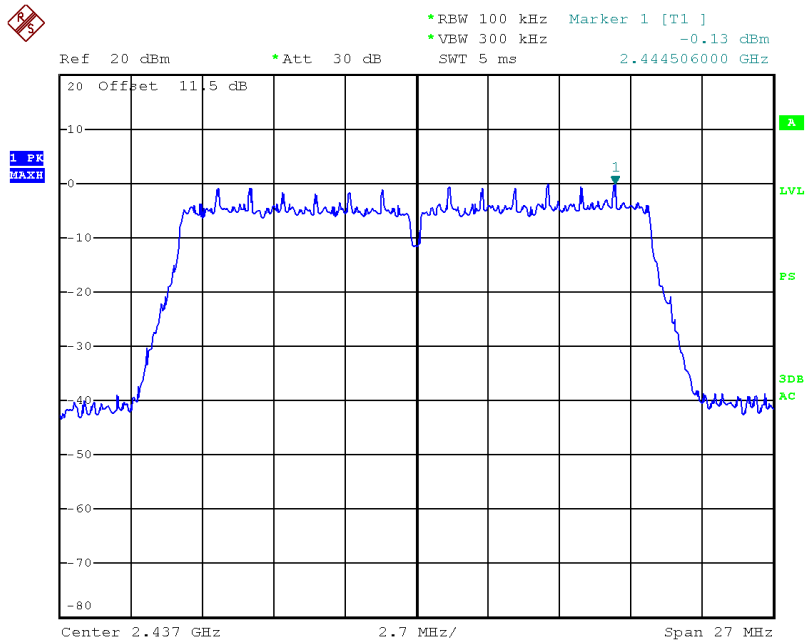

Date: 11.JUN.2015 16:31:23

Channel H

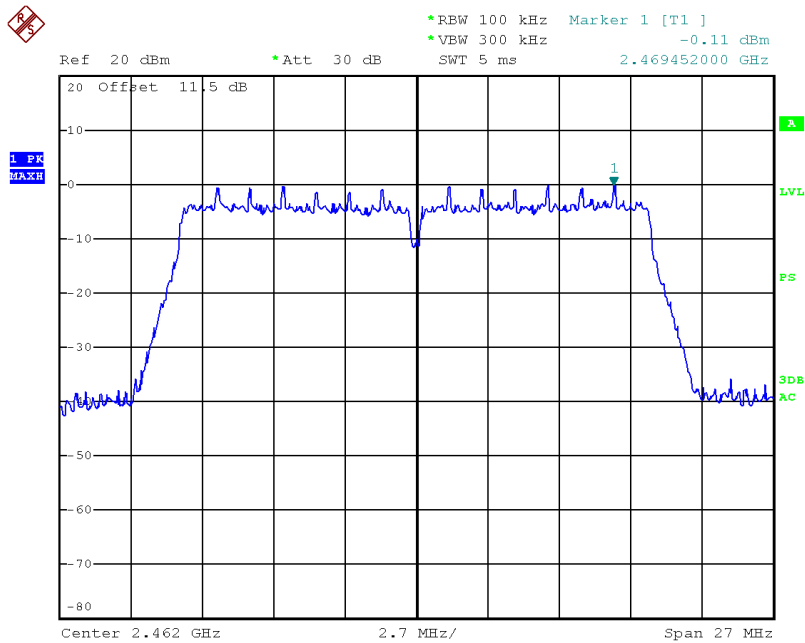

Date: 11.JUN.2015 16:32:17

Mode	Channel	PSD (dBm)			Total PSD (dBm)	Limit (dBm)
		Port 0	Port 1	Port 2		
802.11n (HT40)	L	-3.48	-	-	-3.48	8
	M	-3.19	-	-	-3.19	8
	H	-3.30	-	-	-3.30	8

Note 1:

$$\text{PSD port } x \text{ (mW)} = 10^{(\text{PSD port } x \text{ (dBm)}/10)}; x = 0, 1, 2.$$

$$\text{Total PSD (mW)} = \text{PSD port 0 (mW)} + \text{PSD port 1 (mW)} + \text{PSD port 2 (mW)}$$

$$\text{Total PSD (dBm)} = 10 * \log(\text{Total PSD (mW)})$$

Channel L

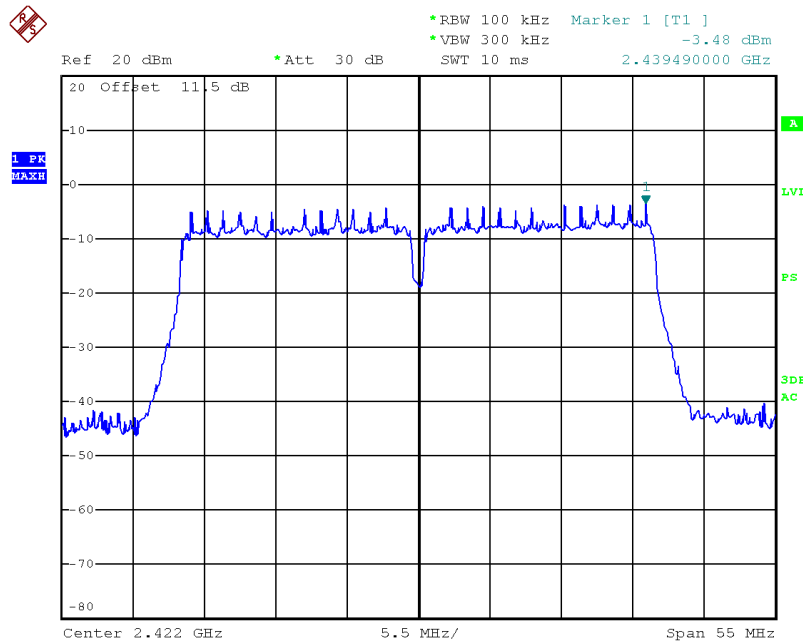

Date: 11.JUN.2015 16:33:24

Channel M

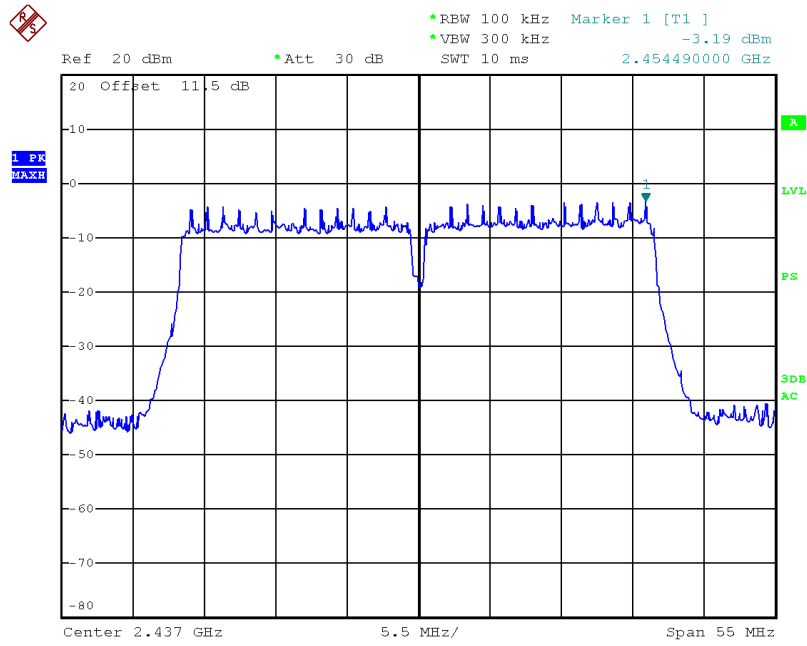

Date: 11.JUN.2015 16:34:20

Channel H

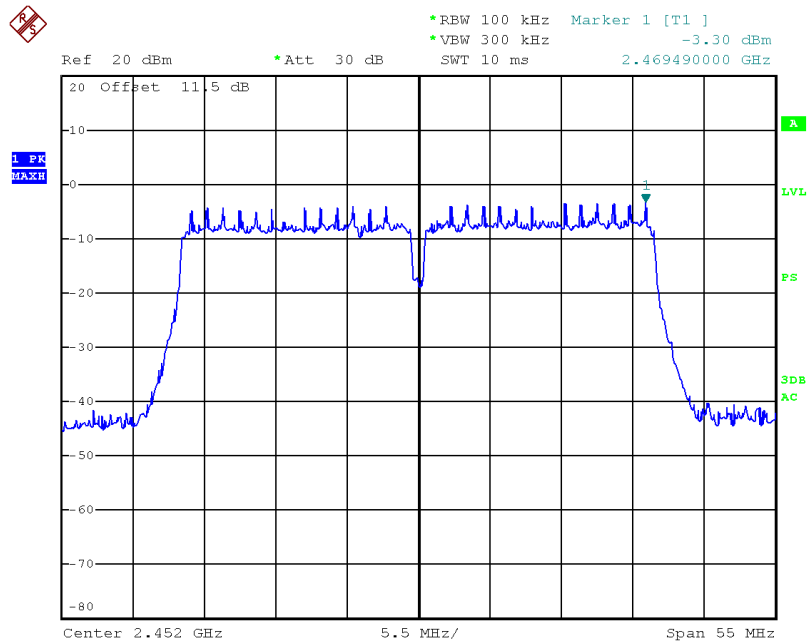

Date: 11.JUN.2015 16:35:00

6 Emission outside the frequency band

Test result: Pass

6.1 Test limit

In any 100 kHz bandwidth outside the frequency band in which the spread spectrum intentional radiator is operating, the radio frequency power that is produced by the intentional radiator shall be at least 20 dB below that in the 100 kHz bandwidth within the band that contains the highest level of the desired power.

6.2 Test Configuration

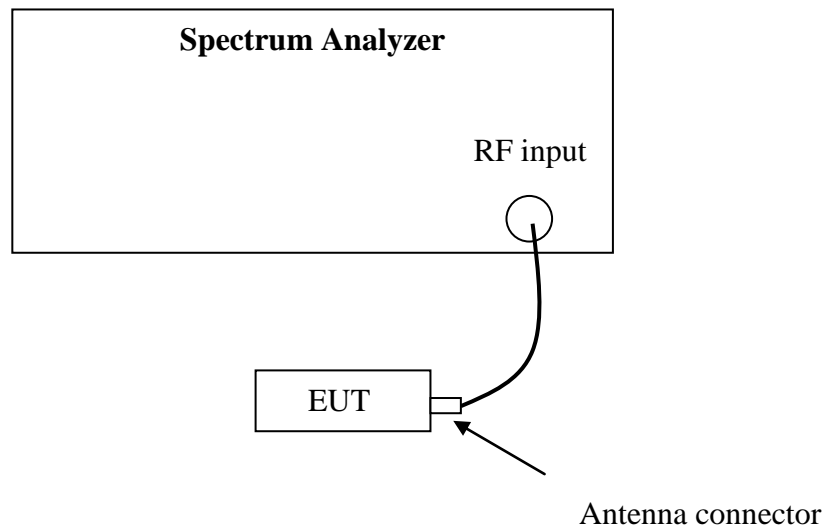

6.3 Test procedure and test setup

The EUT was tested according to DTS test procedure of “KDB558074 D01 DTS Meas Guidance v03r03” (clause 11.0) for compliance to FCC 47CFR 15.247 requirements.

Reference level measurement

Establish a reference level by using the following procedure:

- a) Set instrument center frequency to DTS channel center frequency.
- b) Set the span to ≥ 1.5 times the *DTS bandwidth*.
- c) Set the RBW = 100 kHz.
- d) Set the VBW $\geq 3 \times$ RBW.
- e) Detector = peak.
- f) Sweep time = auto couple.
- g) Trace mode = max hold.

- h) Allow trace to fully stabilize.
- i) Use the peak marker function to determine the maximum PSD level.

Note that the channel found to contain the maximum PSD level can be used to establish the reference level.

Emission level measurement

- a) Set the center frequency and span to encompass frequency range to be measured.
- b) Set the RBW = 100 kHz.
- c) Set the VBW $\geq 3 \times$ RBW.
- d) Detector = peak.
- e) Sweep time = auto couple.
- f) Trace mode = max hold.
- g) Allow trace to fully stabilize.
- h) Use the peak marker function to determine the maximum amplitude level.

Ensure that the amplitude of all unwanted emissions outside of the authorized frequency band (excluding restricted frequency bands) are attenuated by at least the minimum requirements specified in 11.1 a) or 11.1 b). Report the three highest emissions relative to the limit.

6.4 Test Protocol

Temperature: 25 °C
Relative Humidity: 55 %

Mode	Channel	Results (dB)			Limits (dB)
		Port0	Port 1	Port 2	
802.11b	L	46.95	-	-	≥20
	M	45.01	-	-	≥20
	H	48.40	-	-	≥20

Channel L

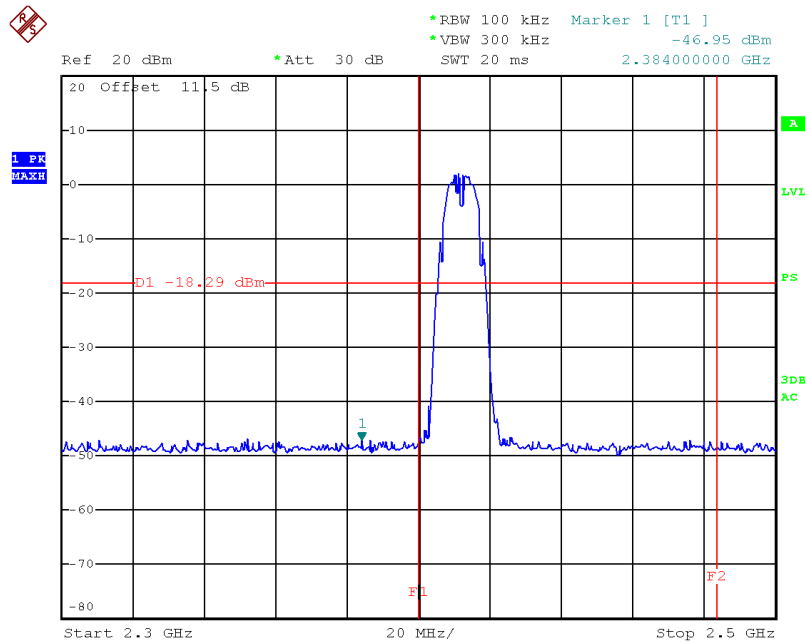

Date: 11.JUN.2015 16:39:08

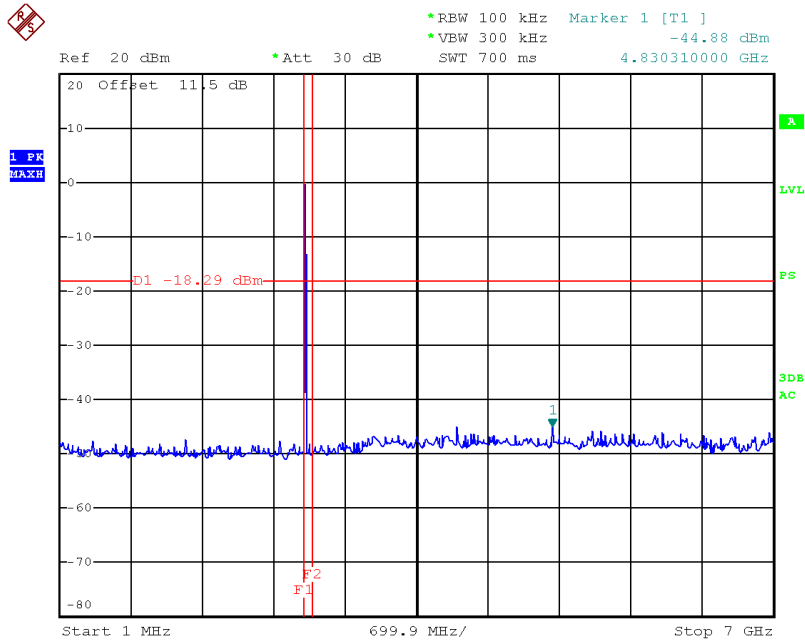

Date: 11.JUN.2015 16:40:37

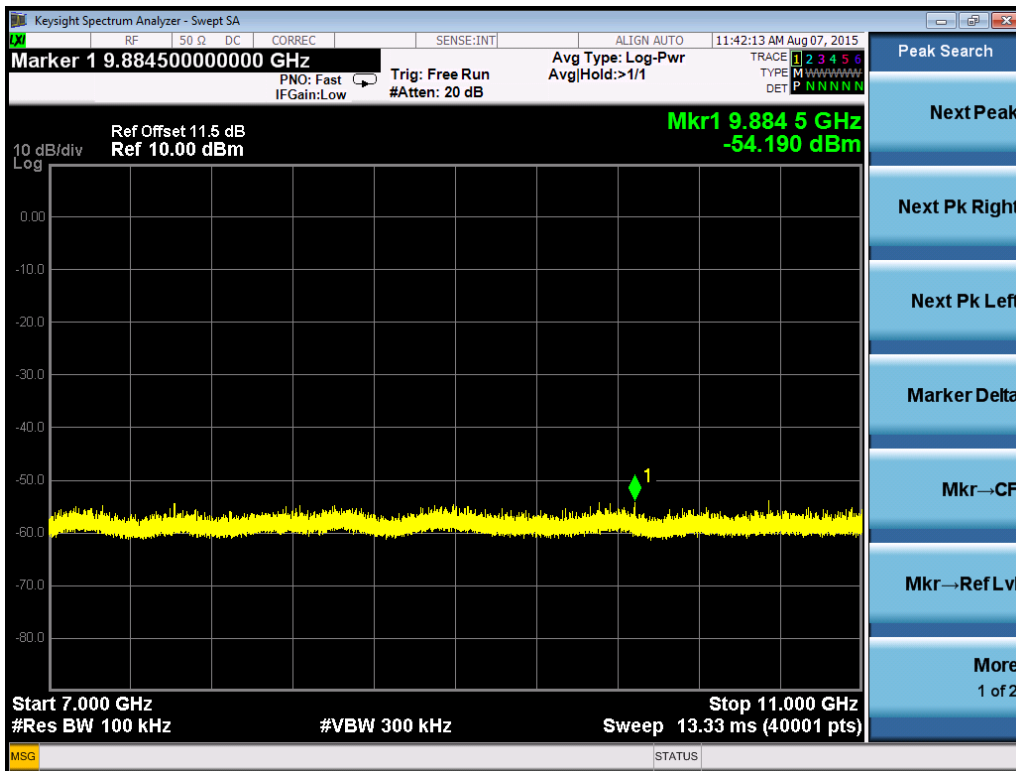

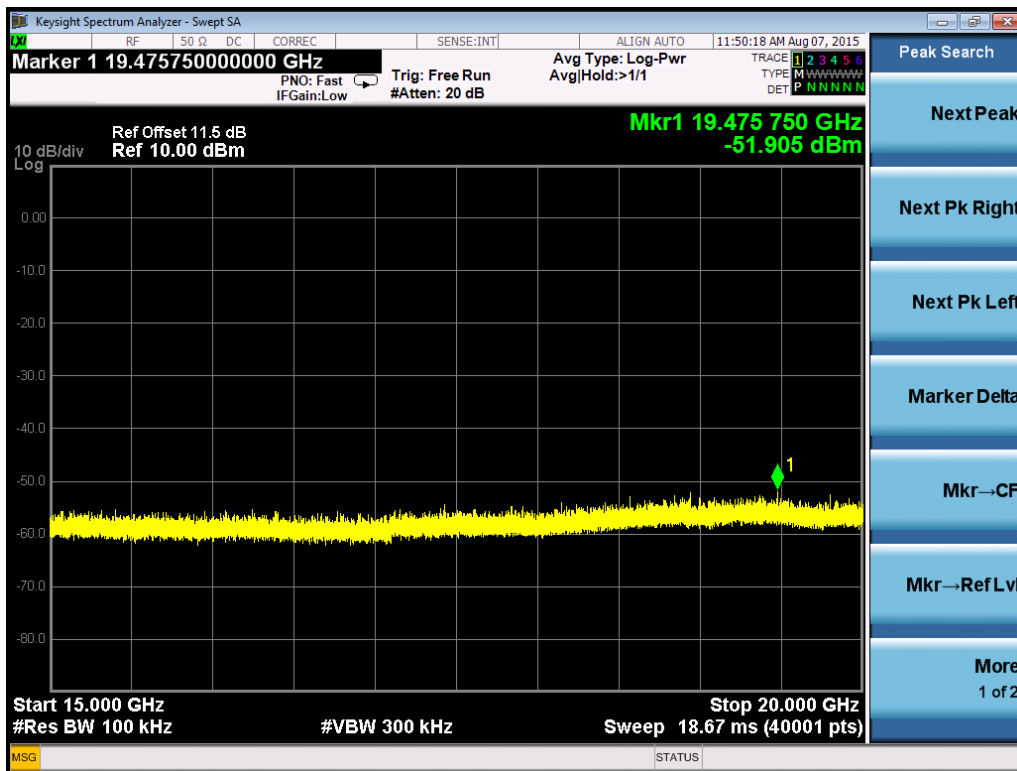
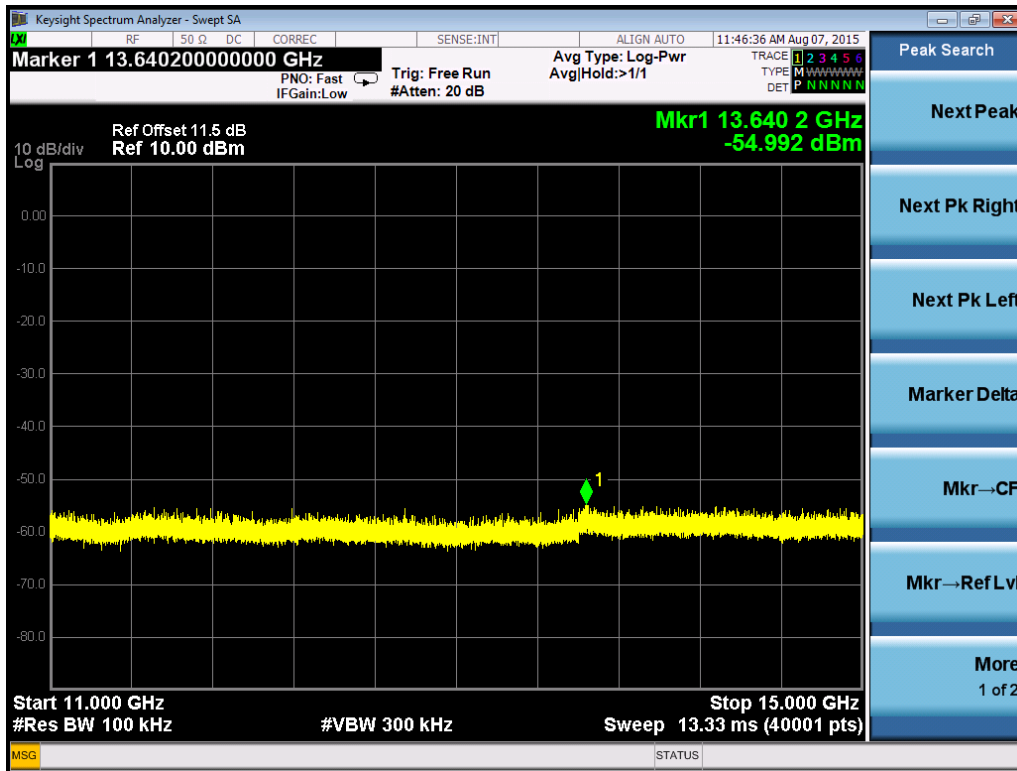

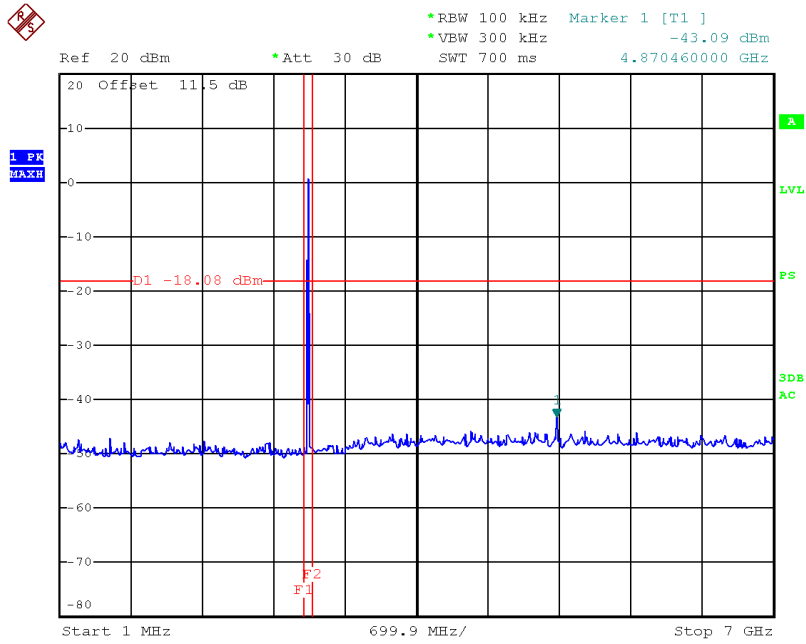

Date: 11.JUN.2015 16:42:32

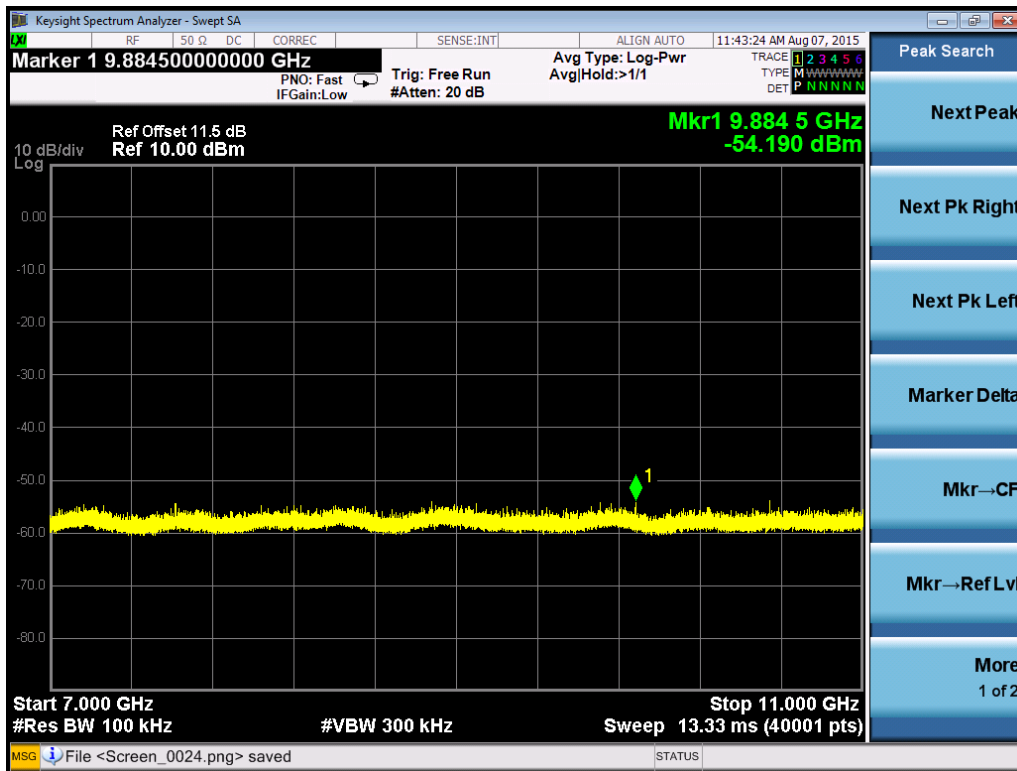

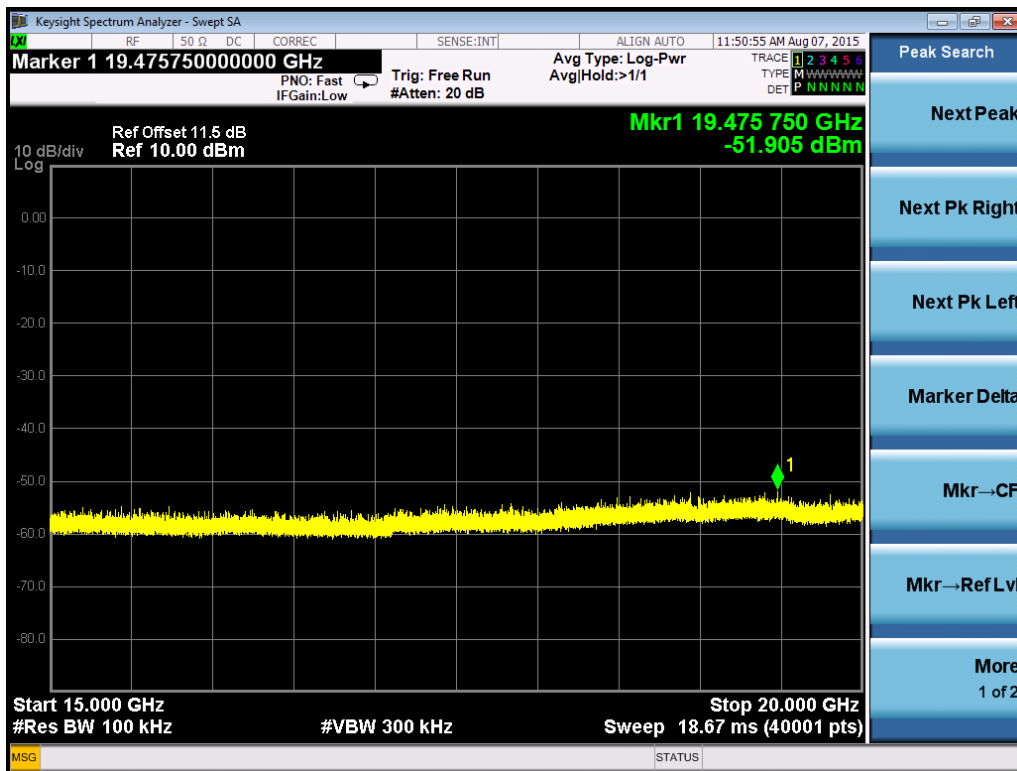

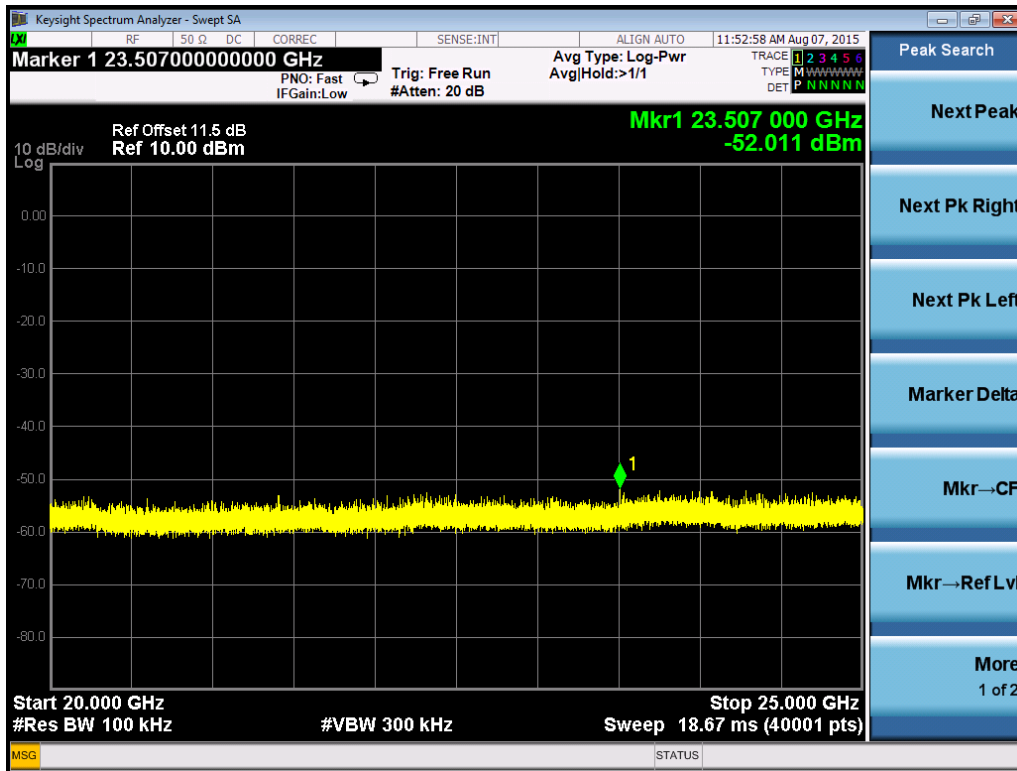

Channel H

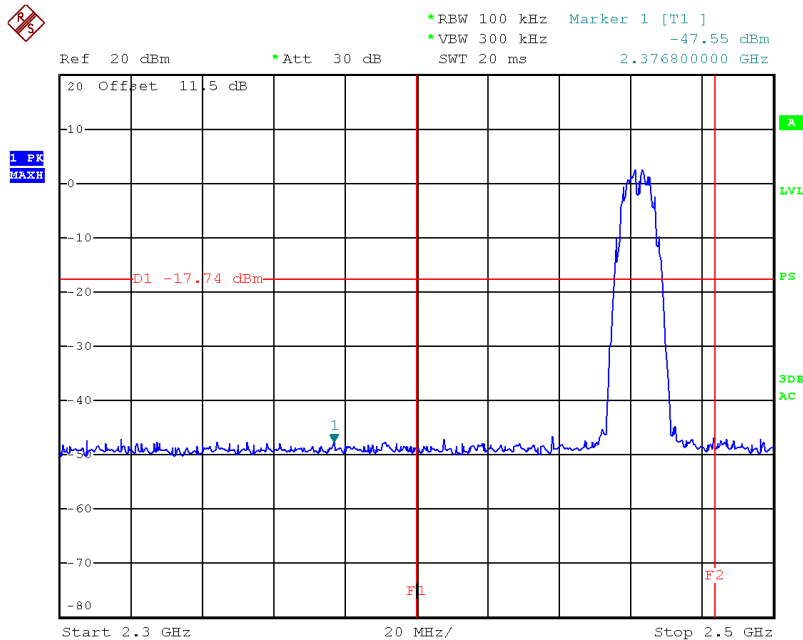

Date: 11.JUN.2015 16:43:32

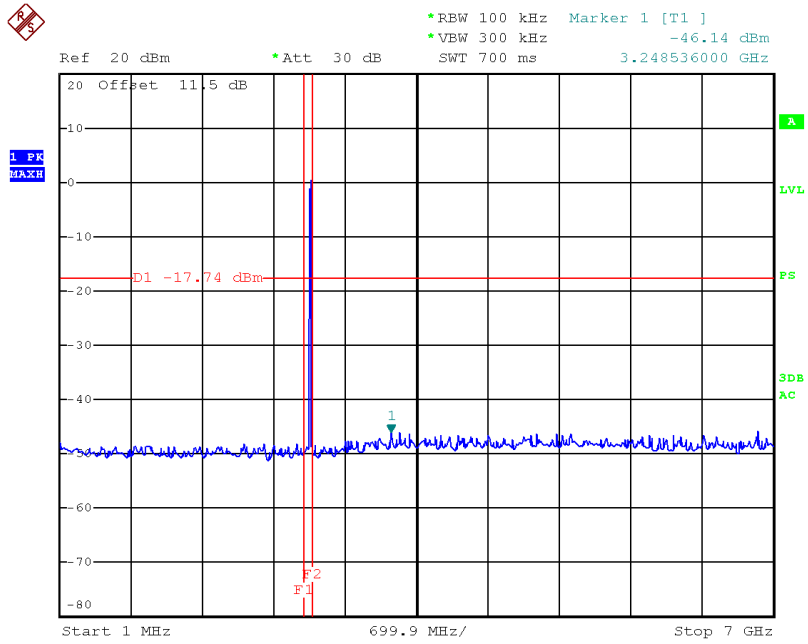

Date: 11.JUN.2015 16:44:00

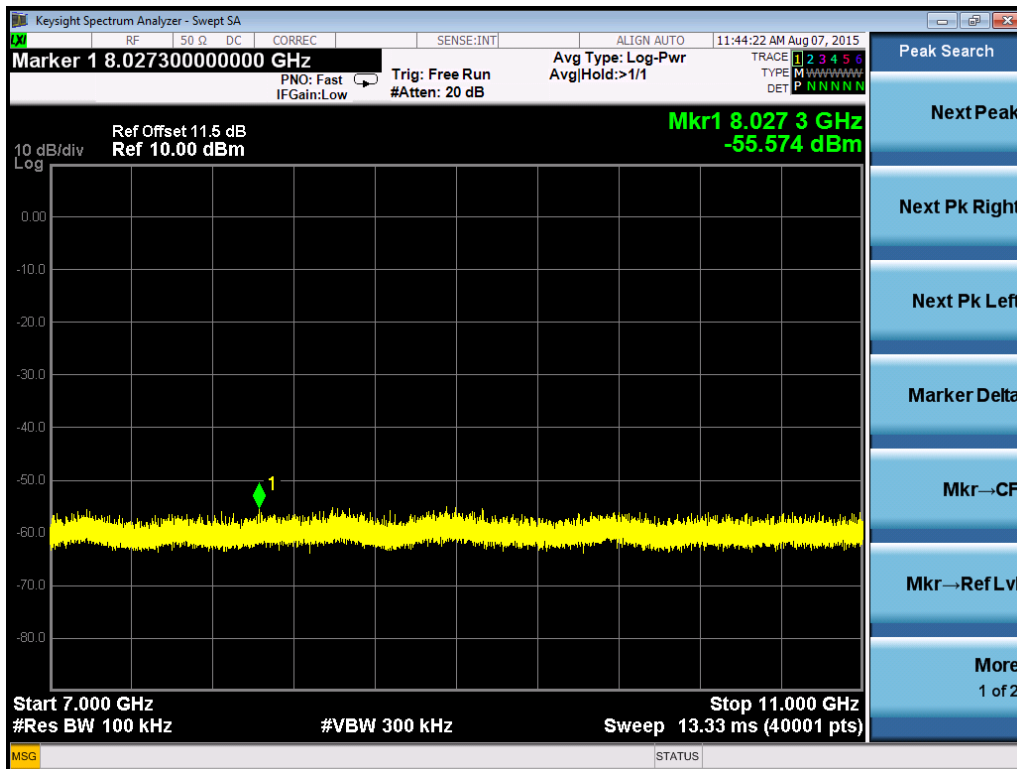

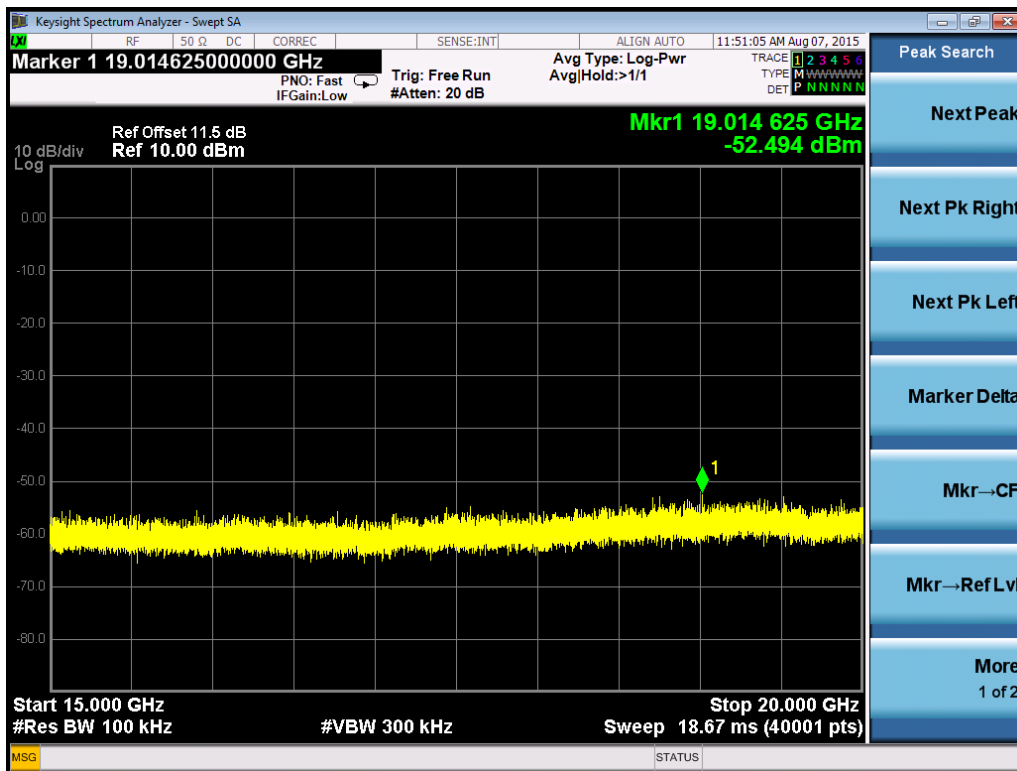
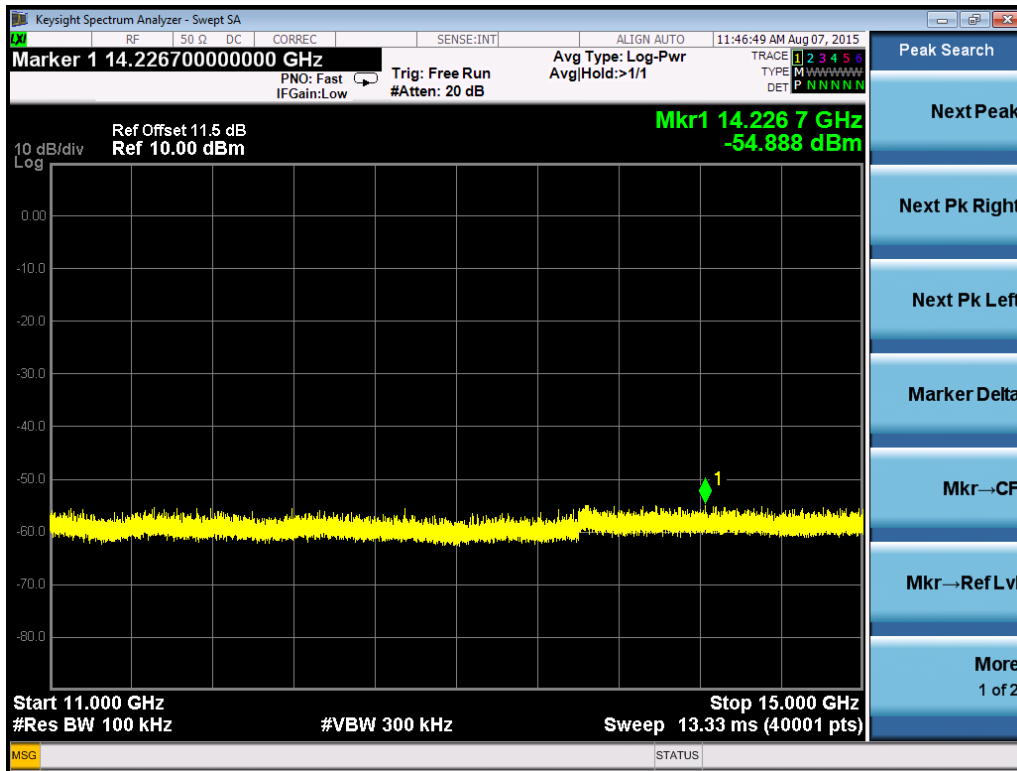

Mode	Channel	Results (dB)			Limits (dB)
		Port0	Port 1	Port 2	
802.11g	L	38.89	-	-	≥20
	M	44.79	-	-	≥20
	H	44.37	-	-	≥20

Channel L

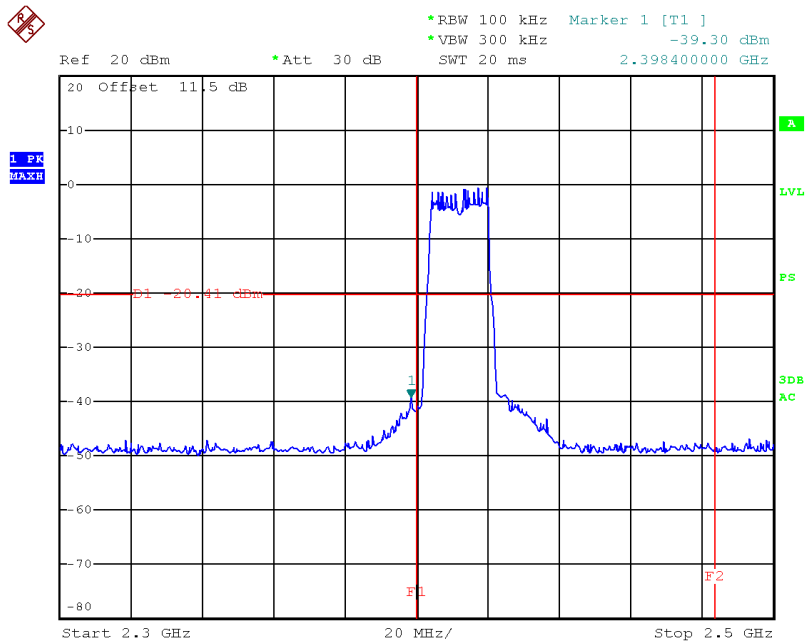

Date: 14.JUN.2015 09:16:59

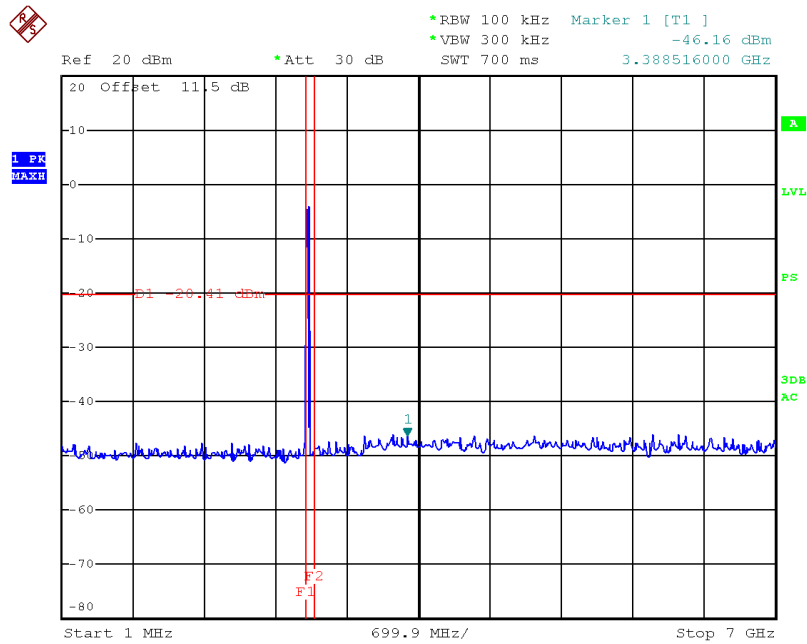

Date: 14.JUN.2015 09:17:32

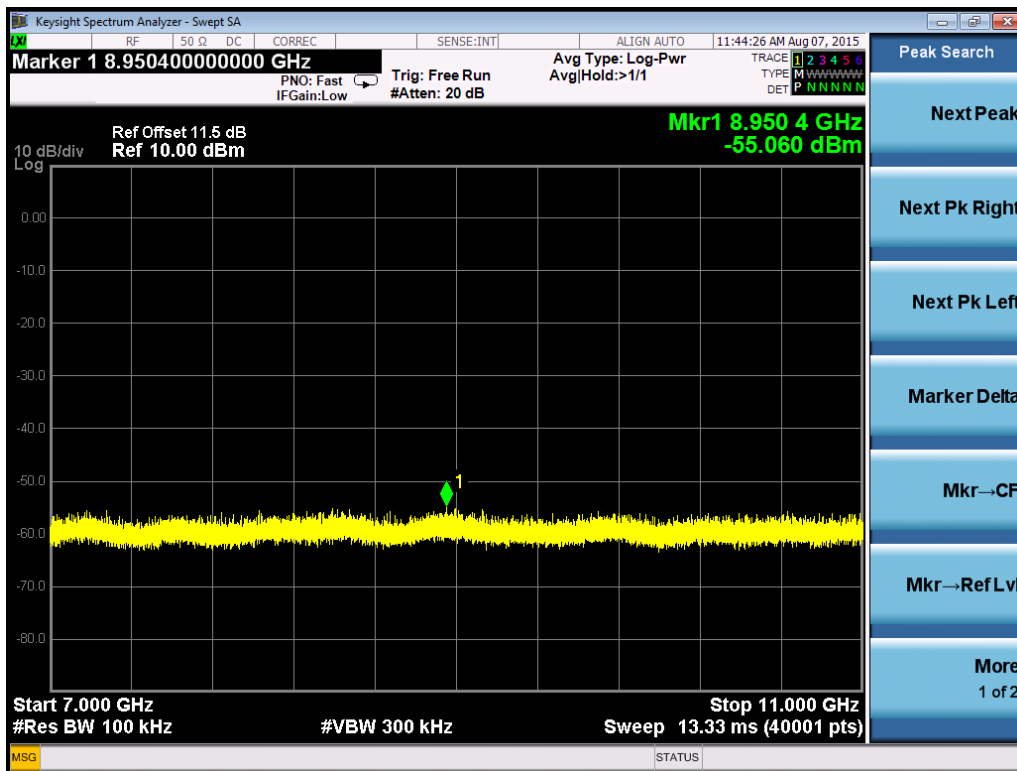

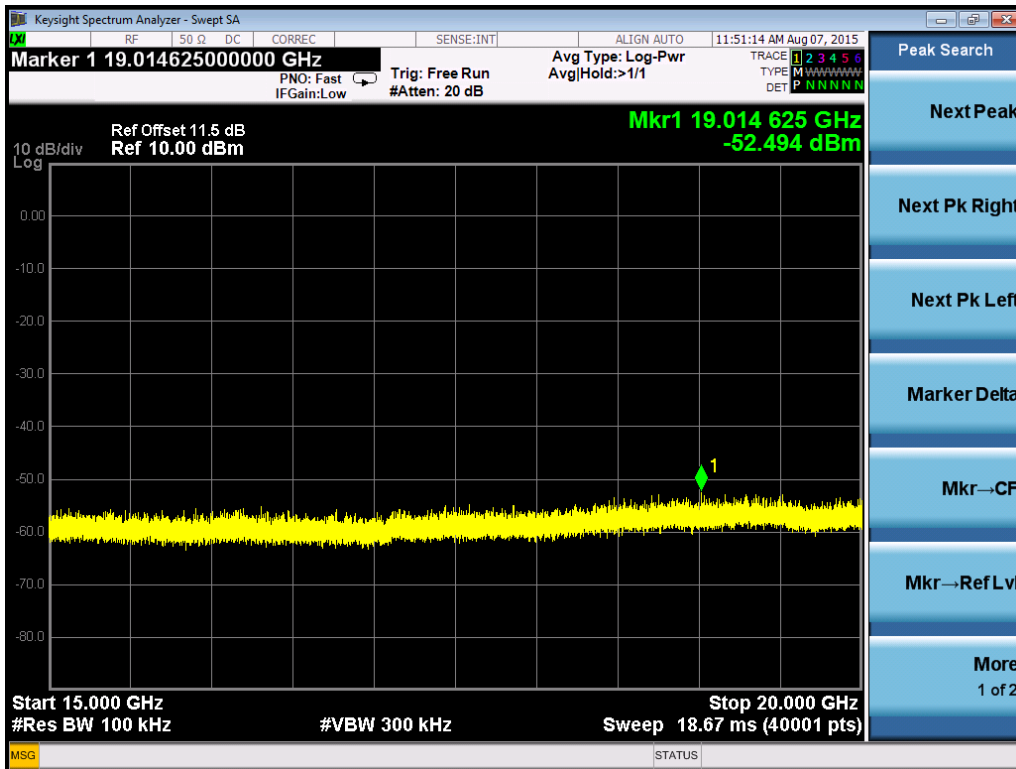
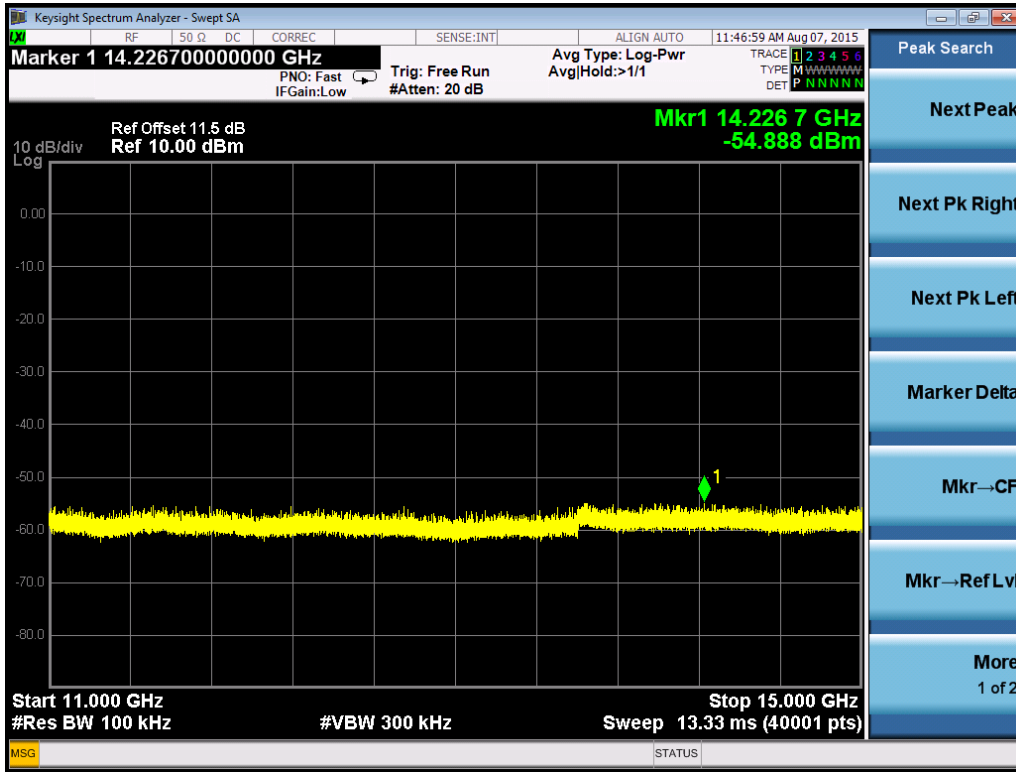

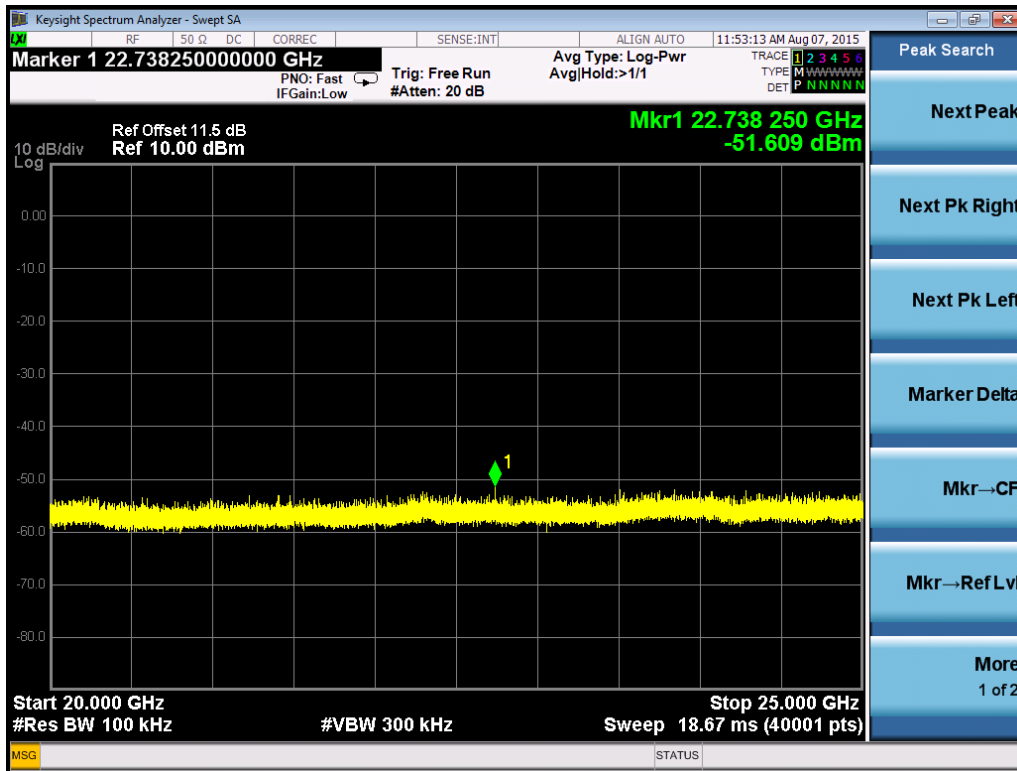

Channel M

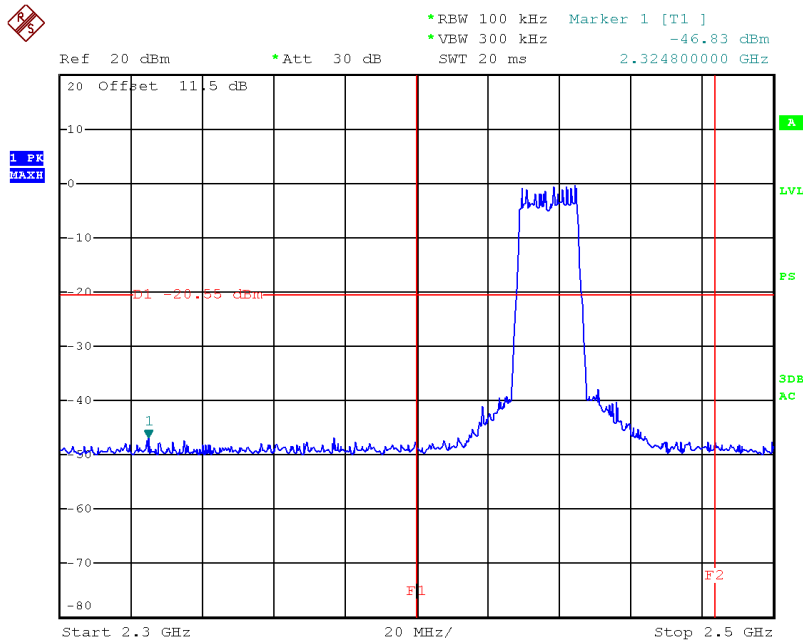

Date: 14.JUN.2015 09:18:35

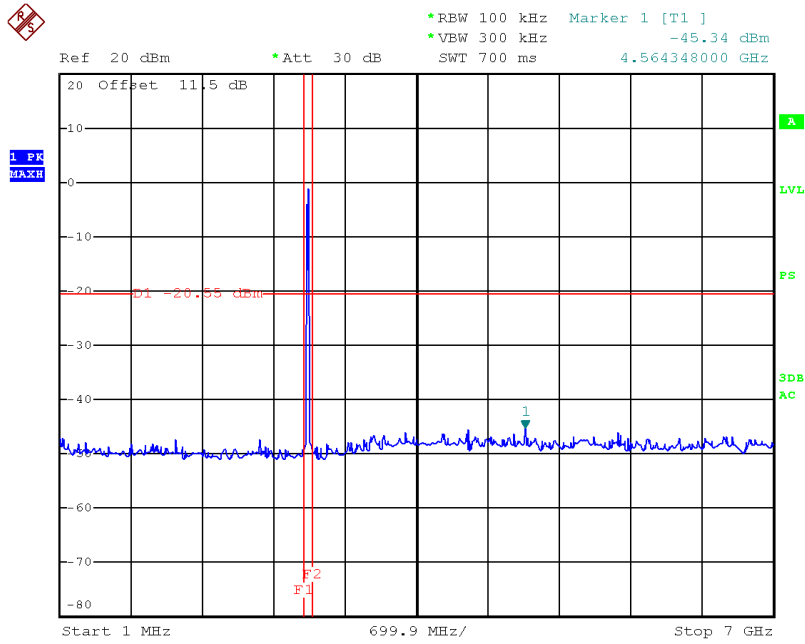

Date: 14.JUN.2015 09:19:00

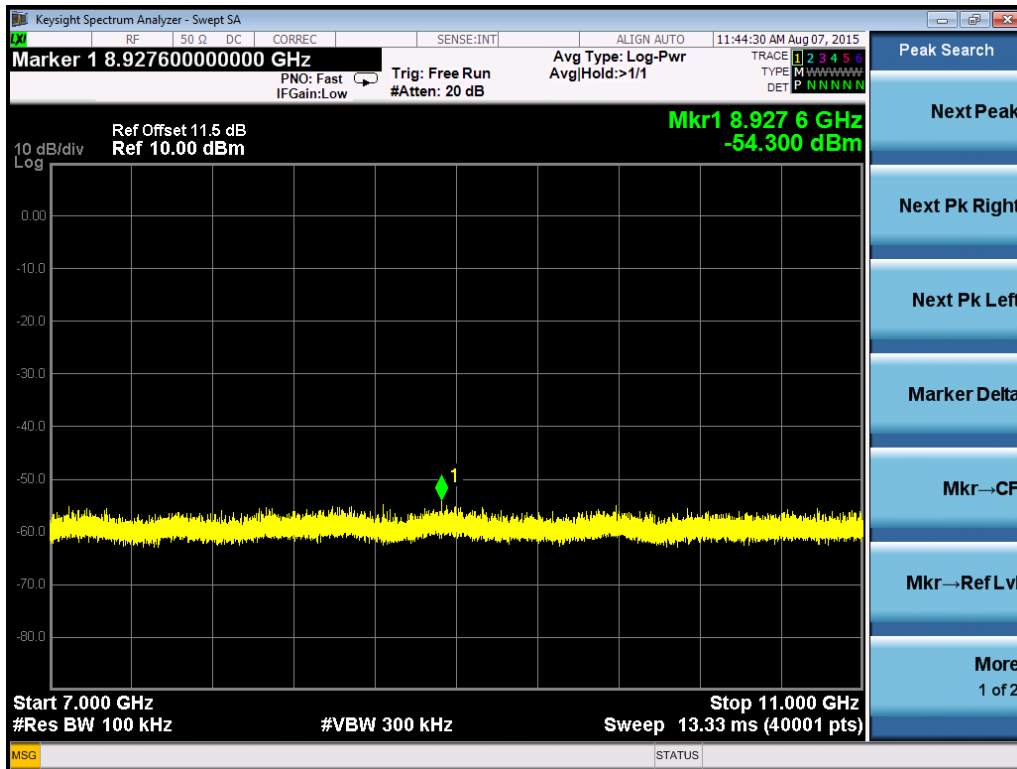

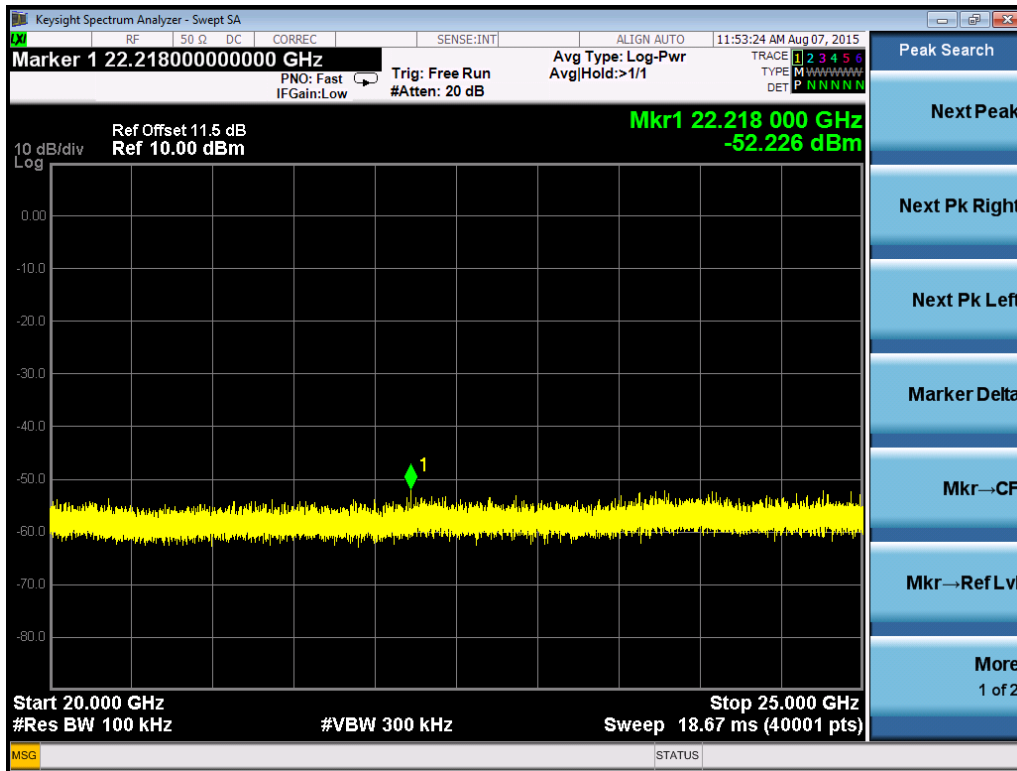

Channel H

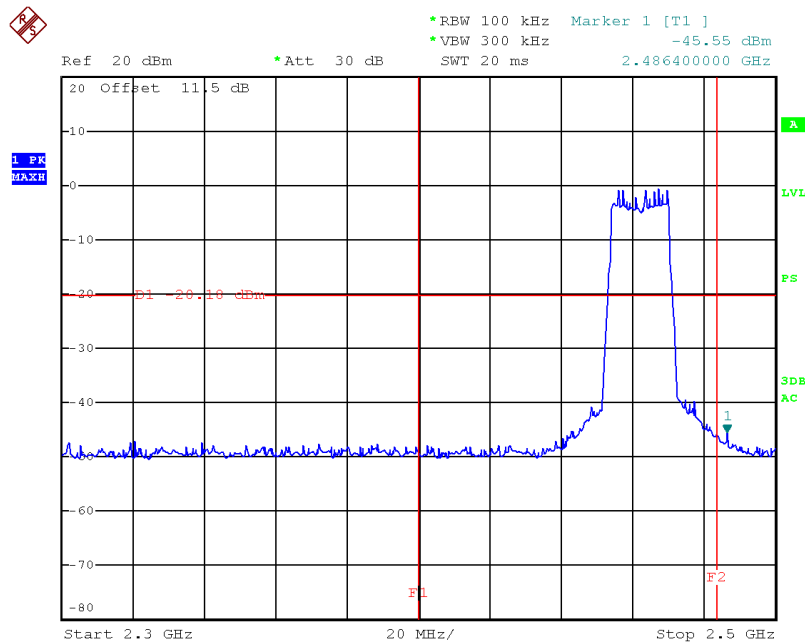

Date: 14.JUN.2015 09:21:27

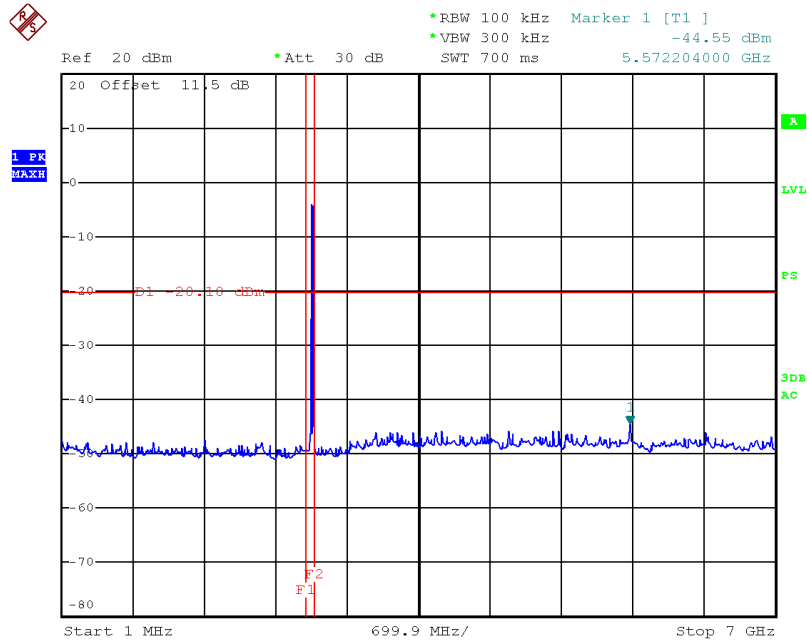

Date: 14.JUN.2015 09:24:19

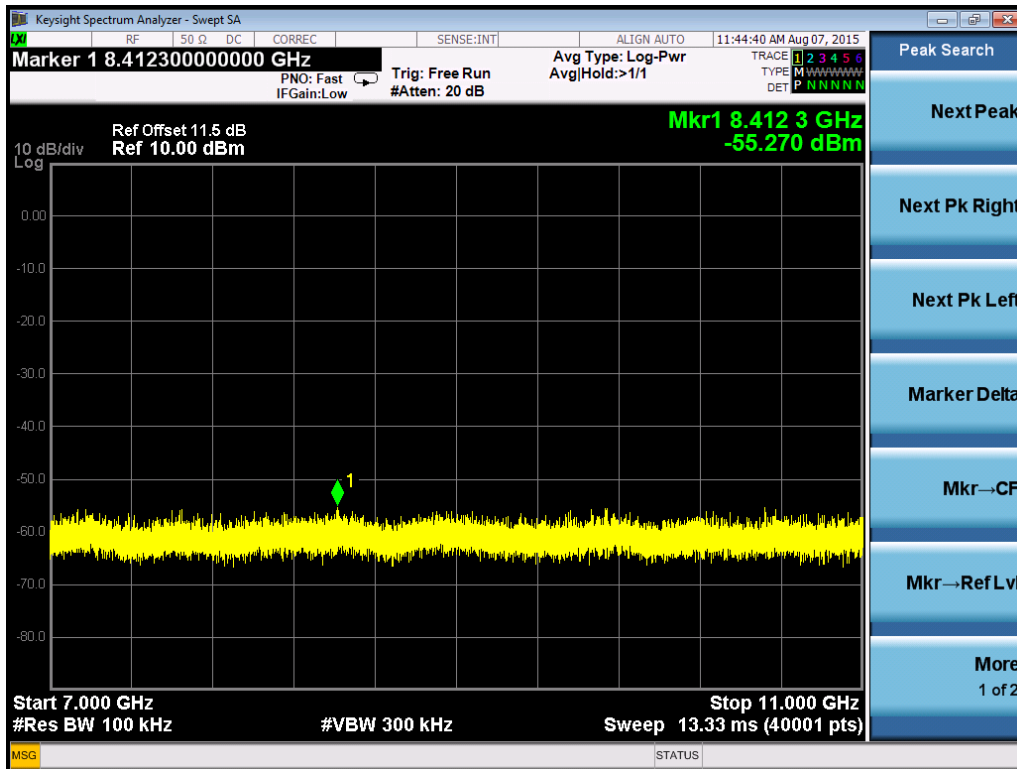

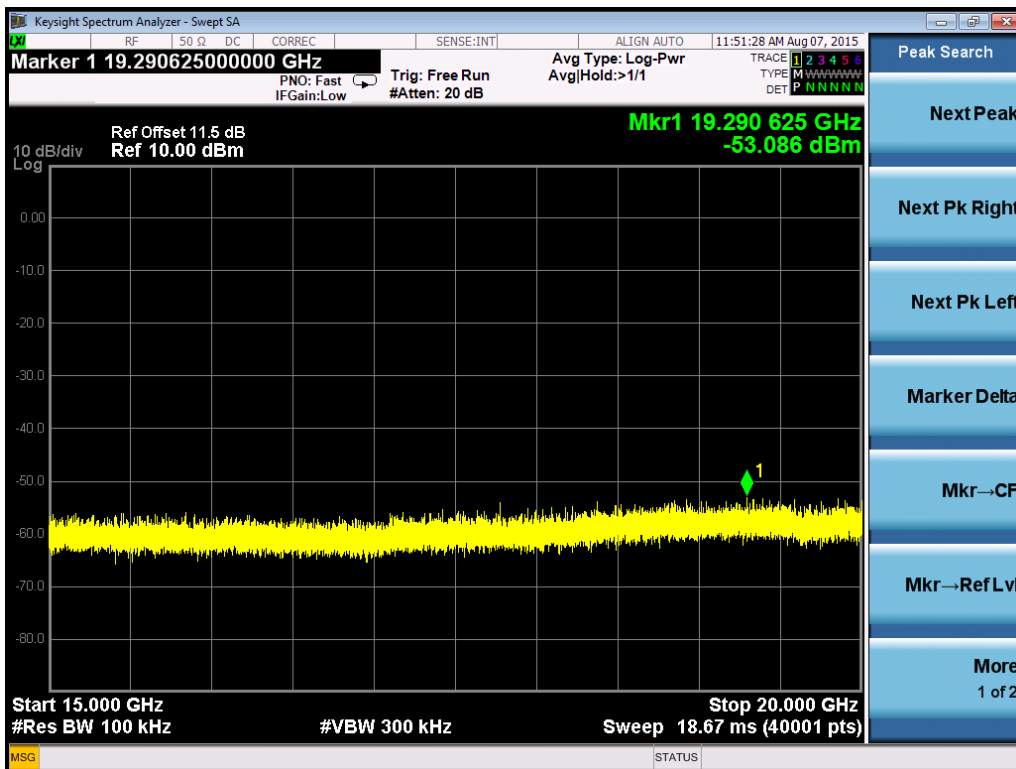
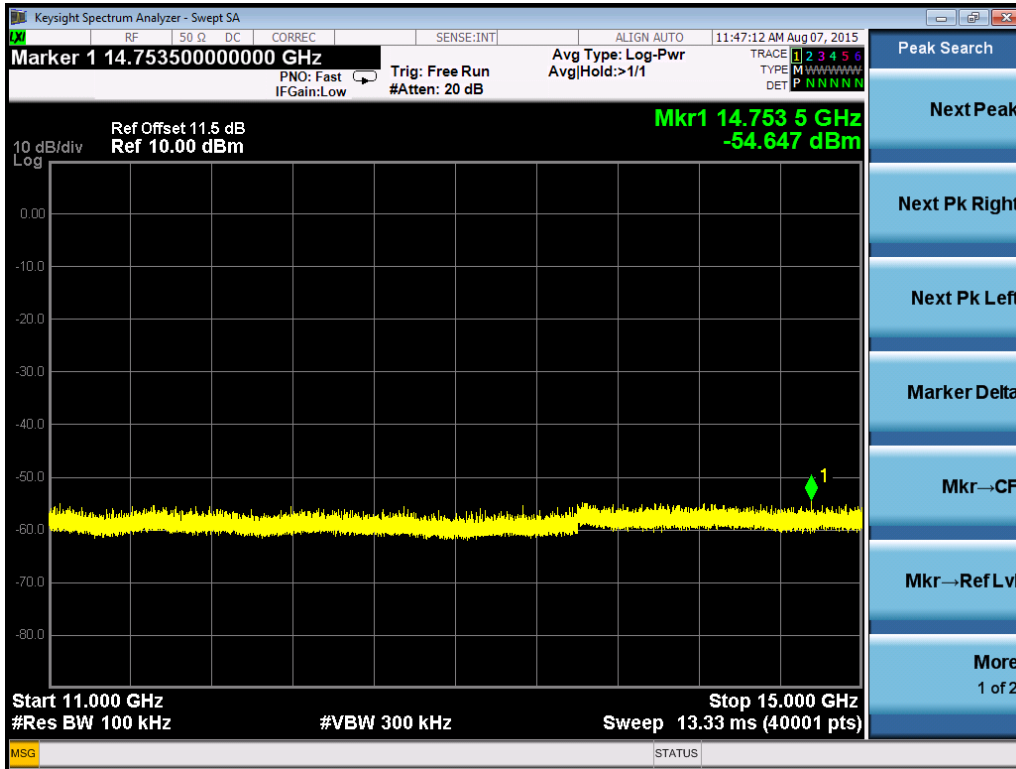

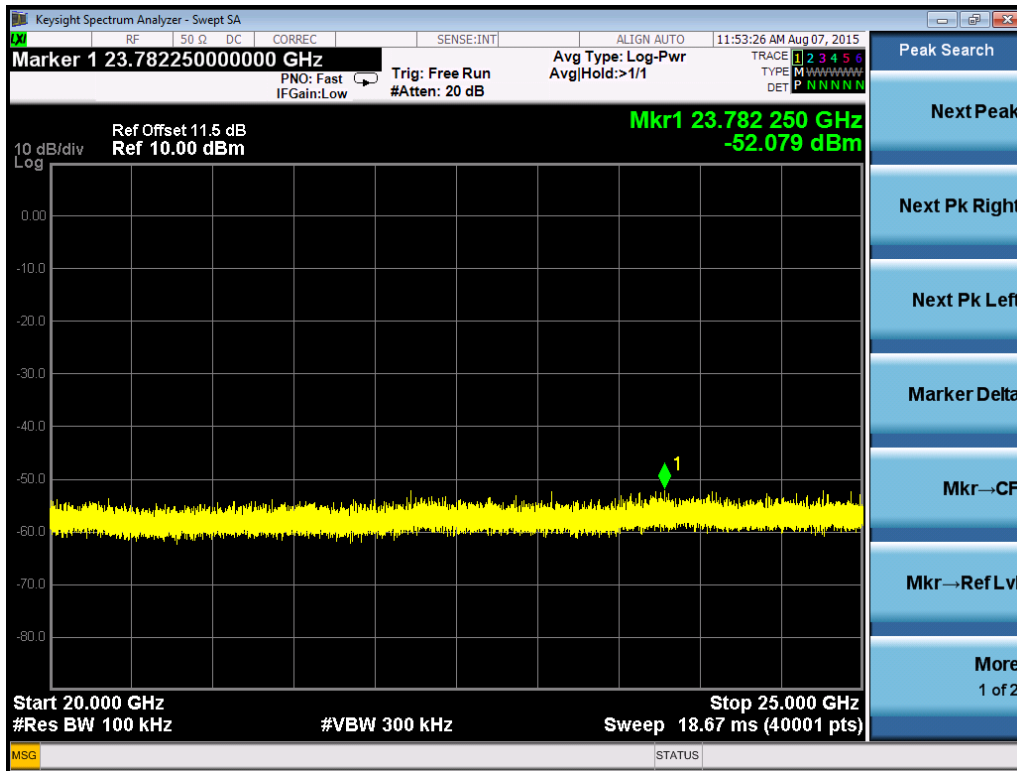

Mode	Channel	Results (dB)			Limits (dB)
		Port0	Port 1	Port 2	
802.11n (HT20)	L	38.35	-	-	≥ 20
	M	45.29	-	-	≥ 20
	H	45.44	-	-	≥ 20

Channel L

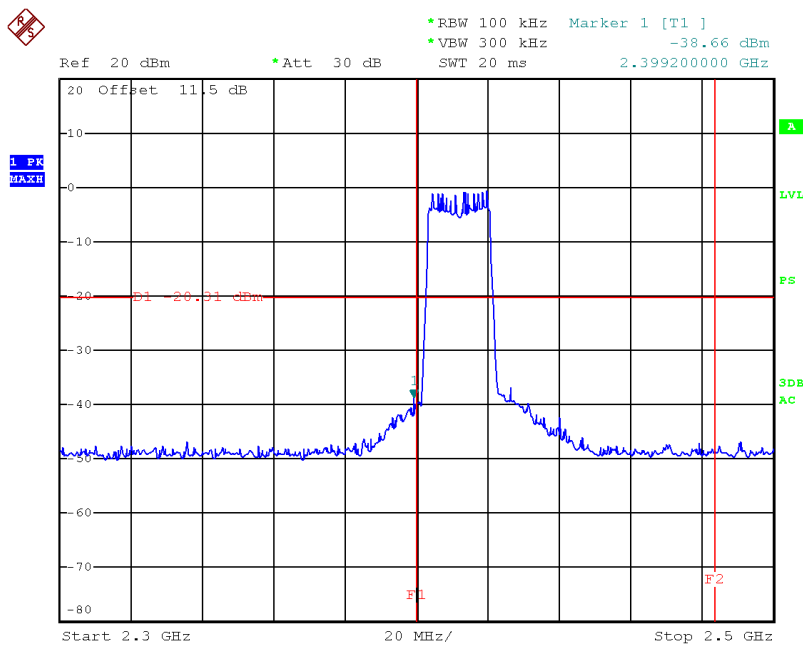

Date: 14.JUN.2015 09:25:15

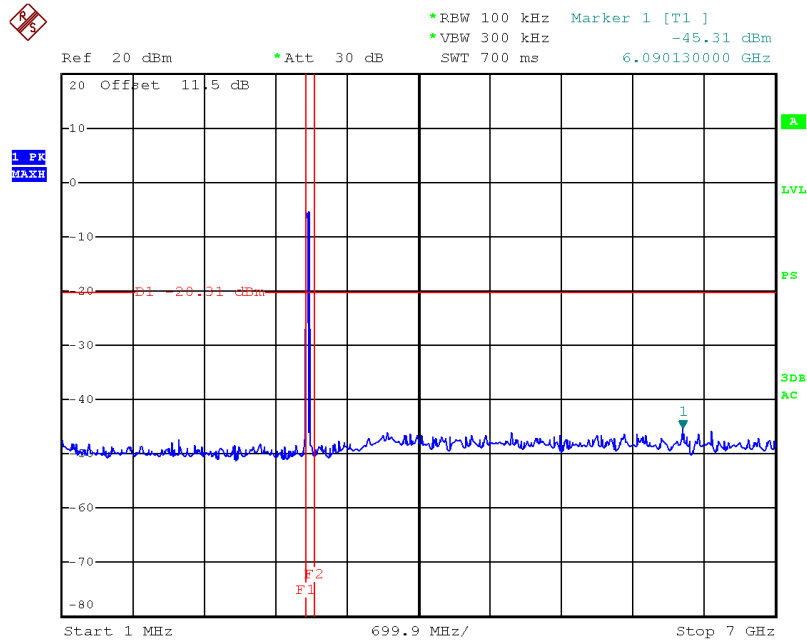

Date: 14.JUN.2015 09:27:23

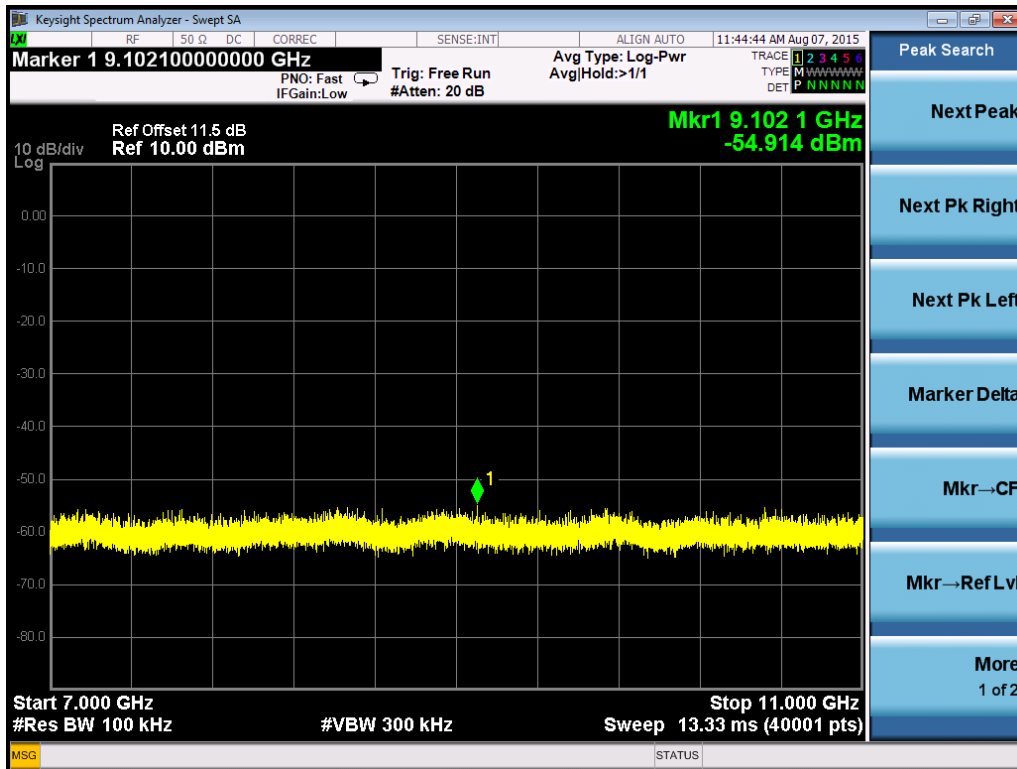

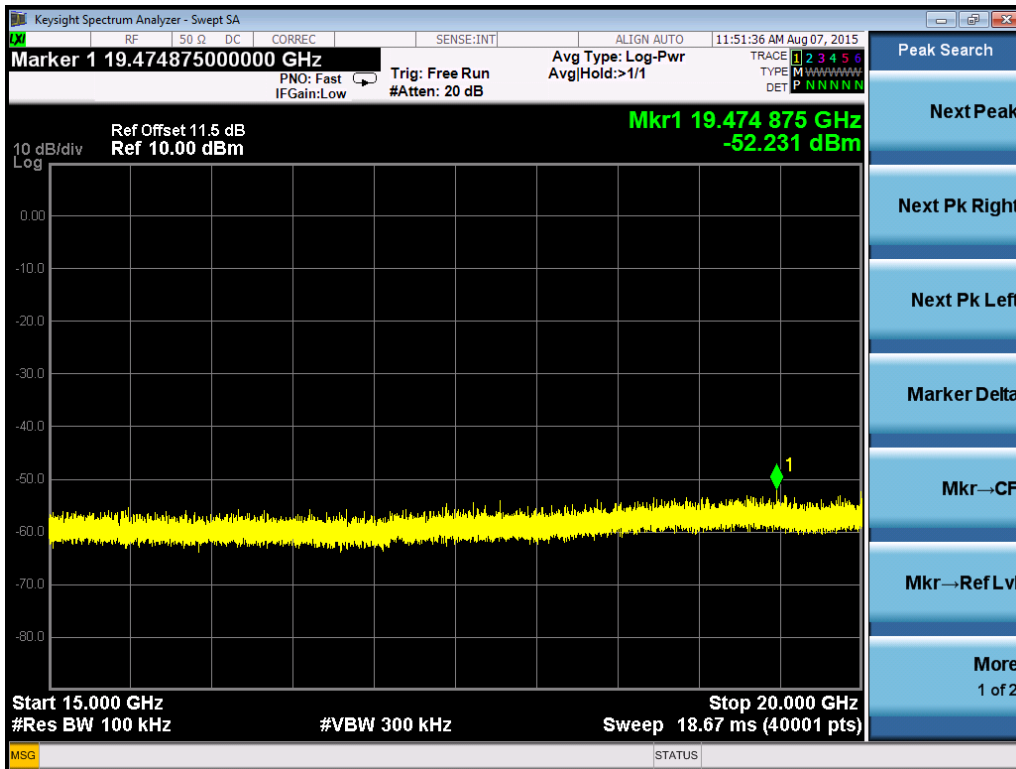
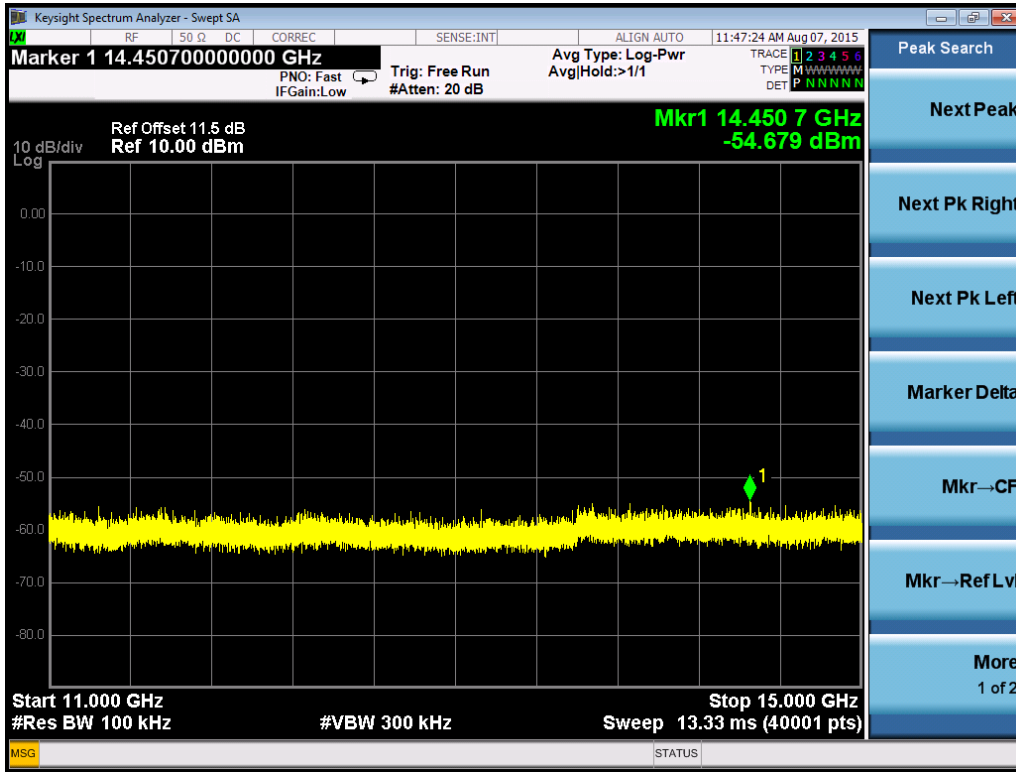

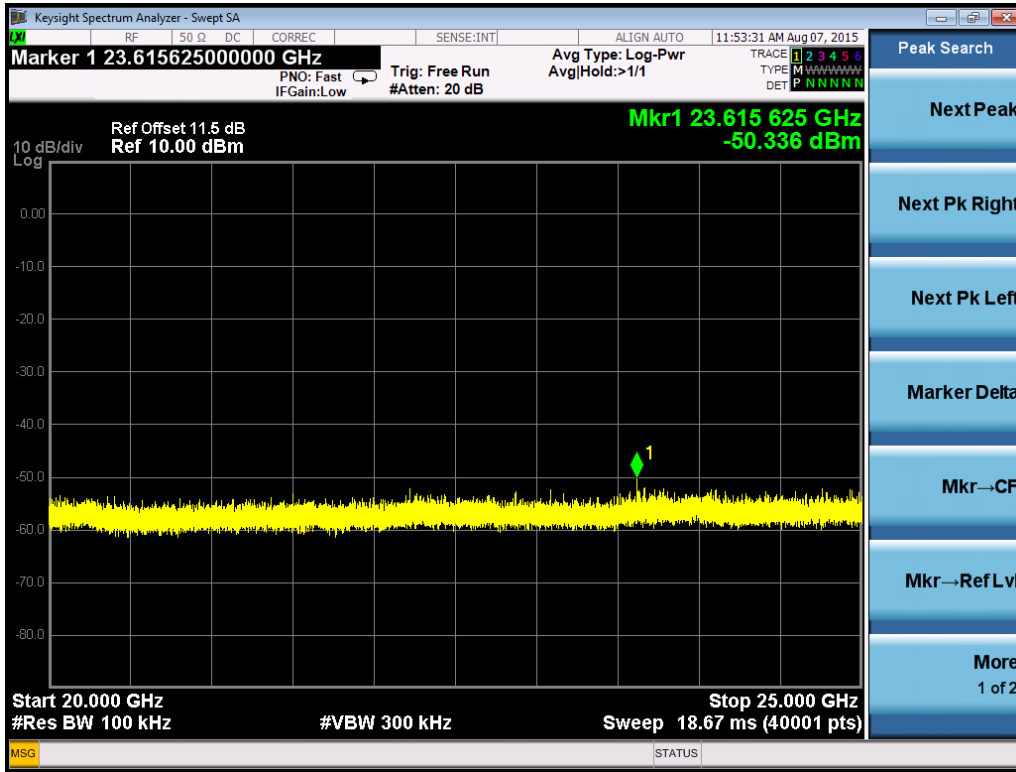

Channel M

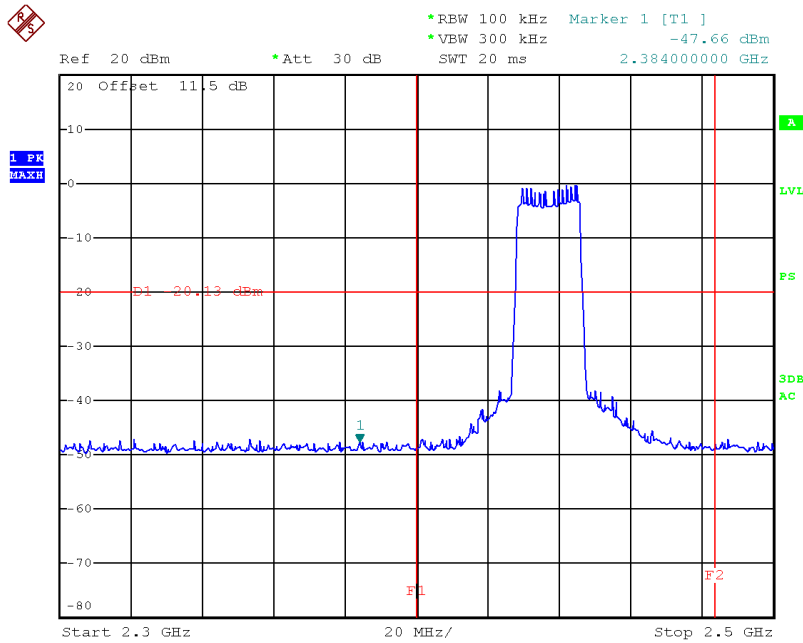

Date: 14.JUN.2015 09:28:36

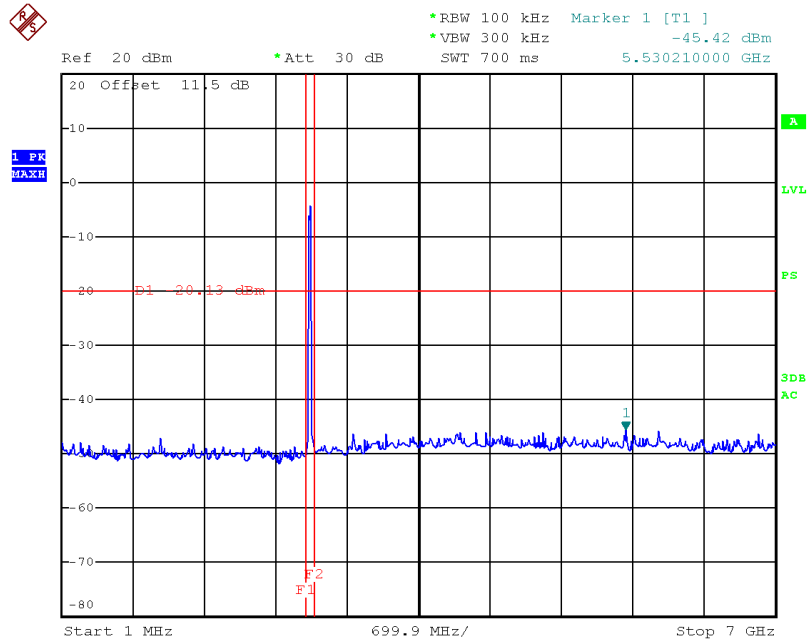

Date: 14.JUN.2015 09:29:27

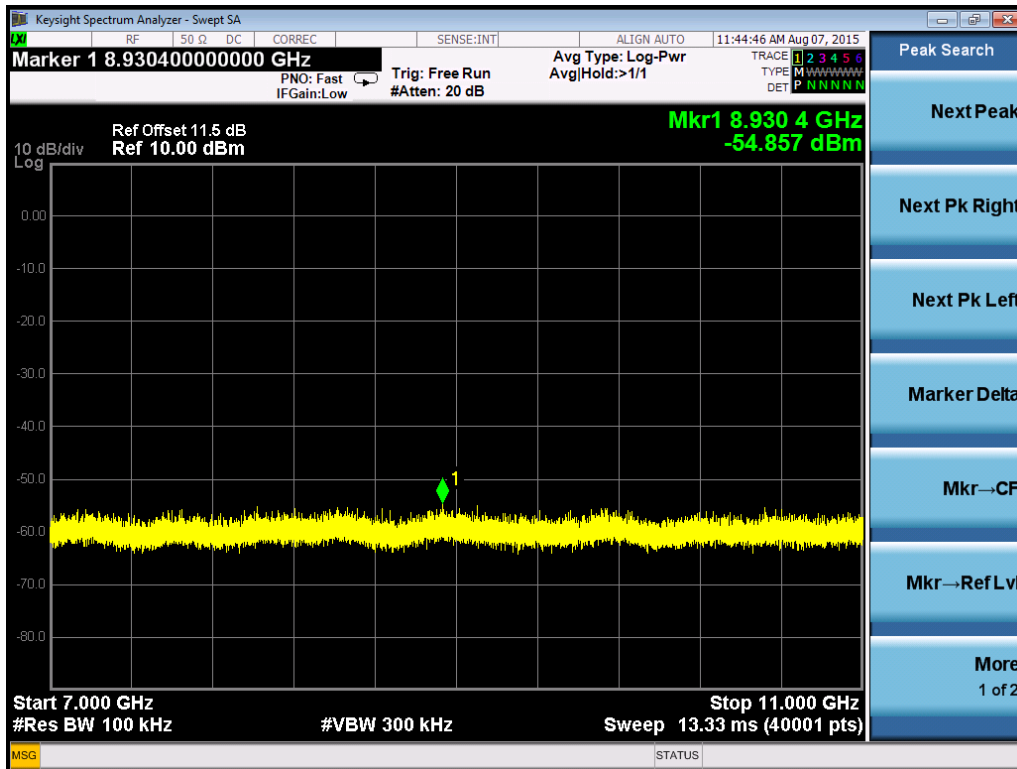

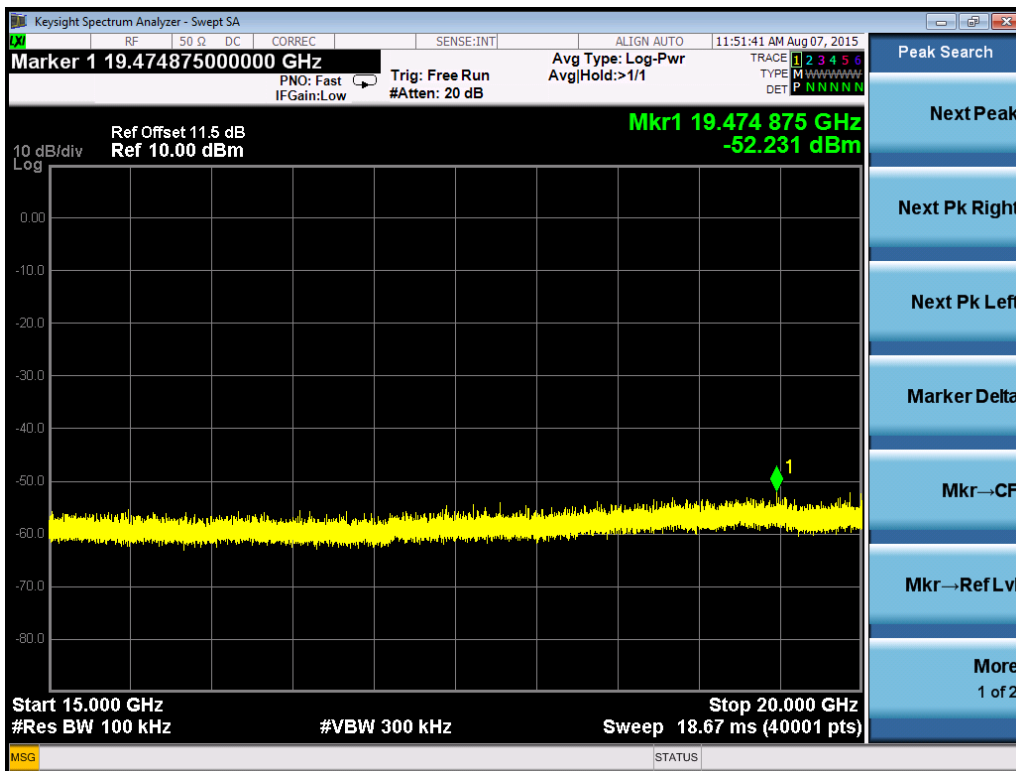
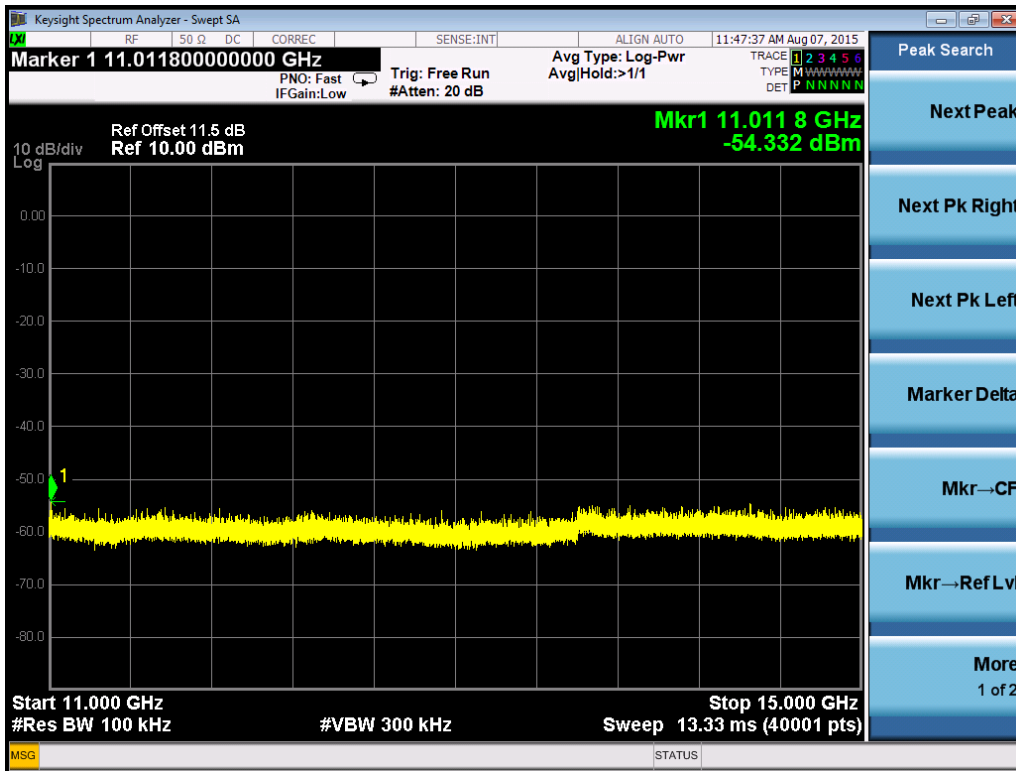

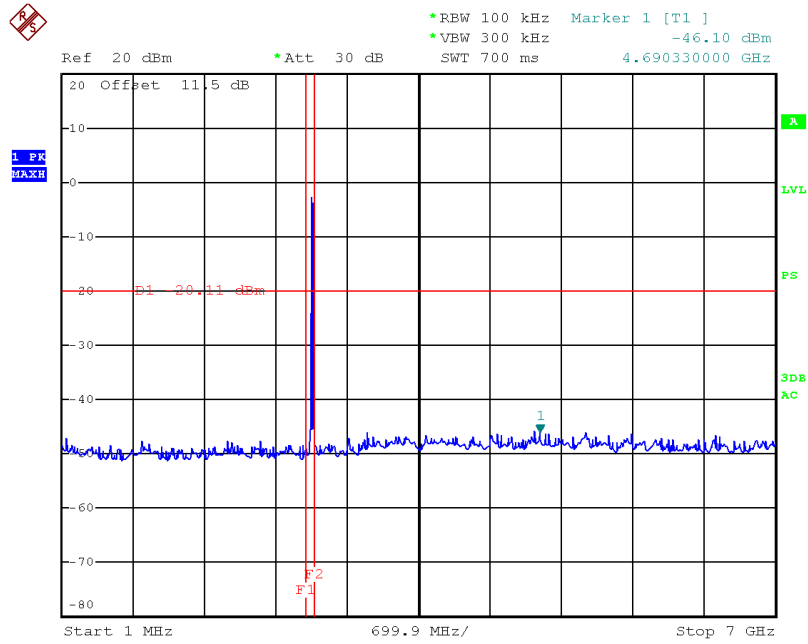

Date: 14.JUN.2015 09:30:37

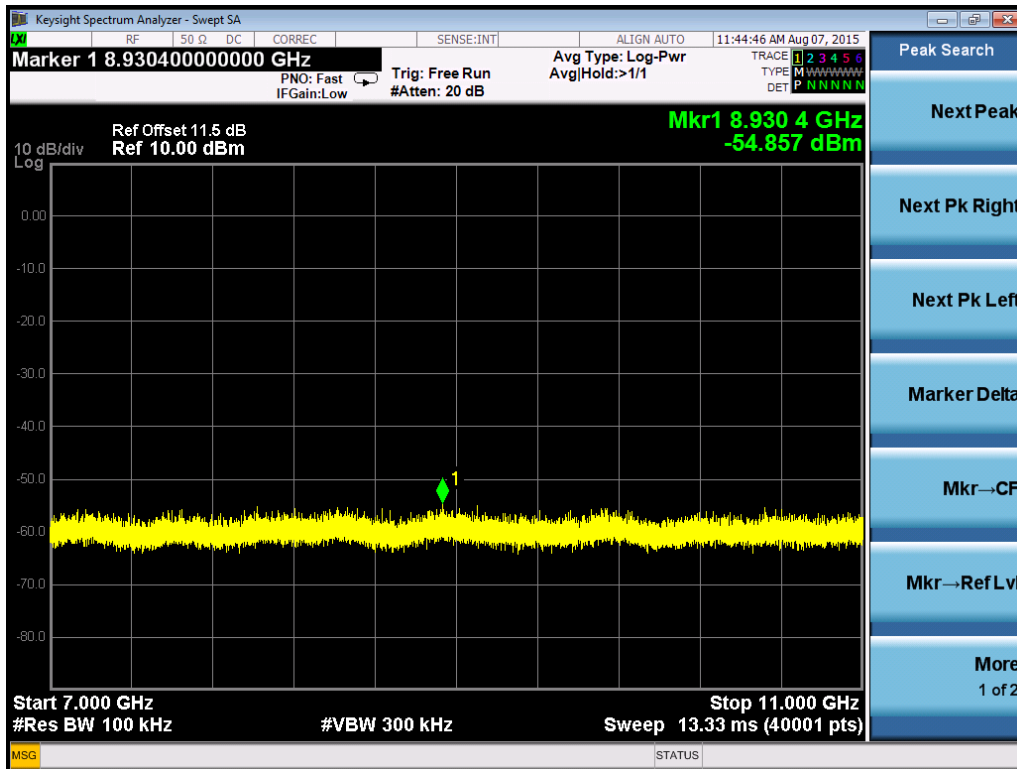

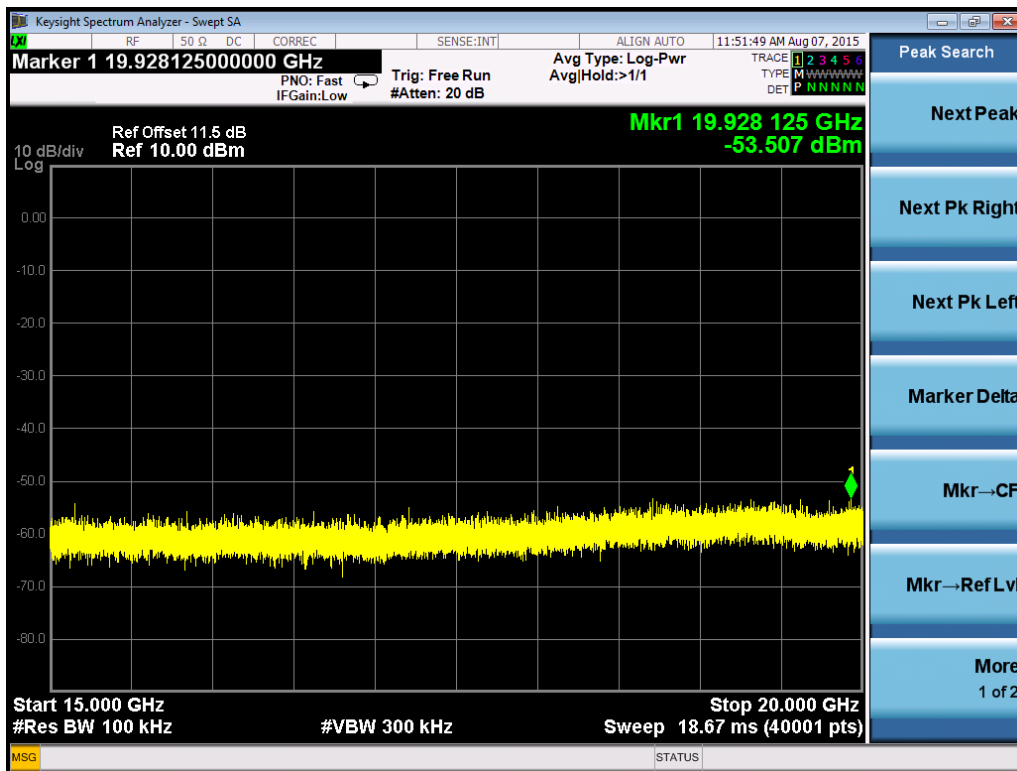
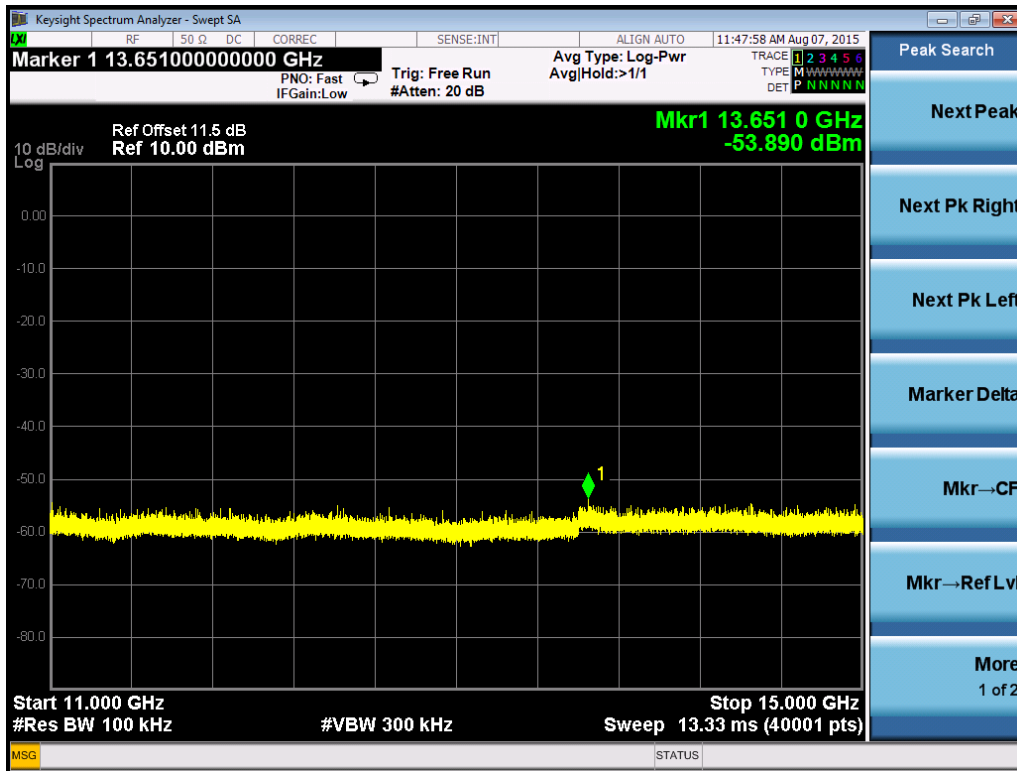

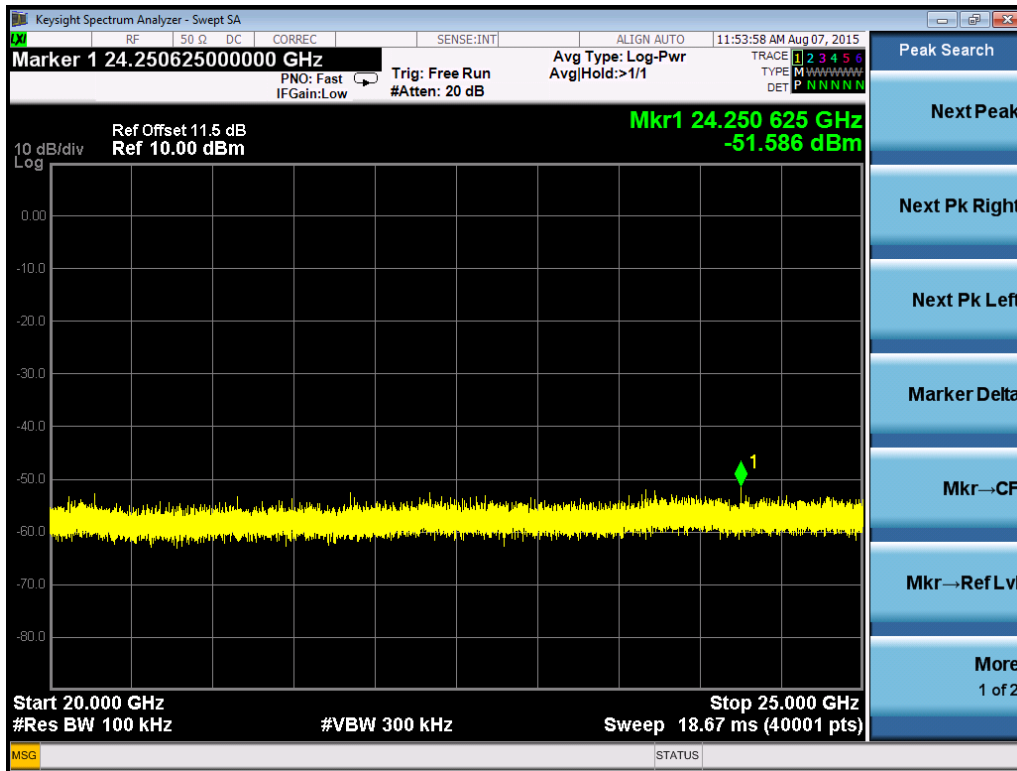

Mode	Channel	Results (dB)			Limits (dB)
		Port0	Port 1	Port 2	
802.11n (HT40)	L	38.01	-	-	≥ 20
	M	39.75	-	-	≥ 20
	H	38.54	-	-	≥ 20

Channel L

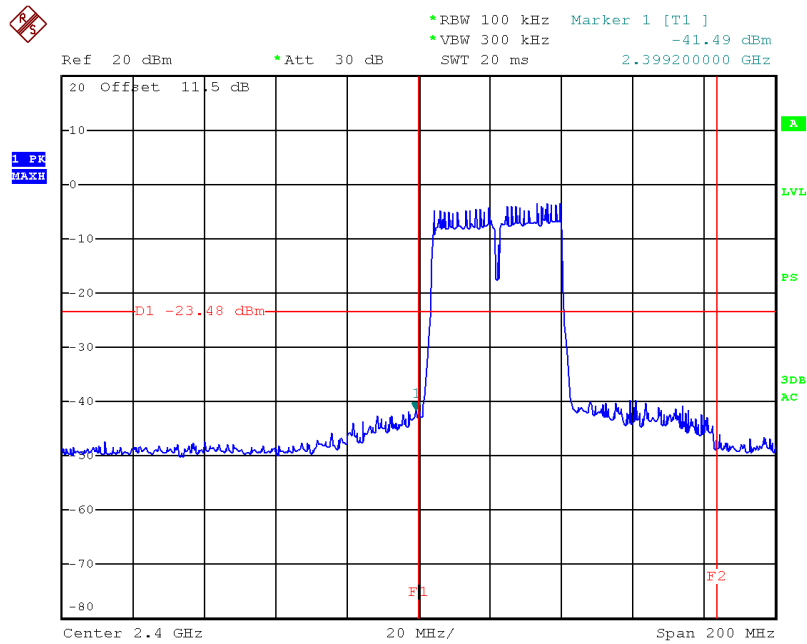

Date: 14.JUN.2015 09:35:45

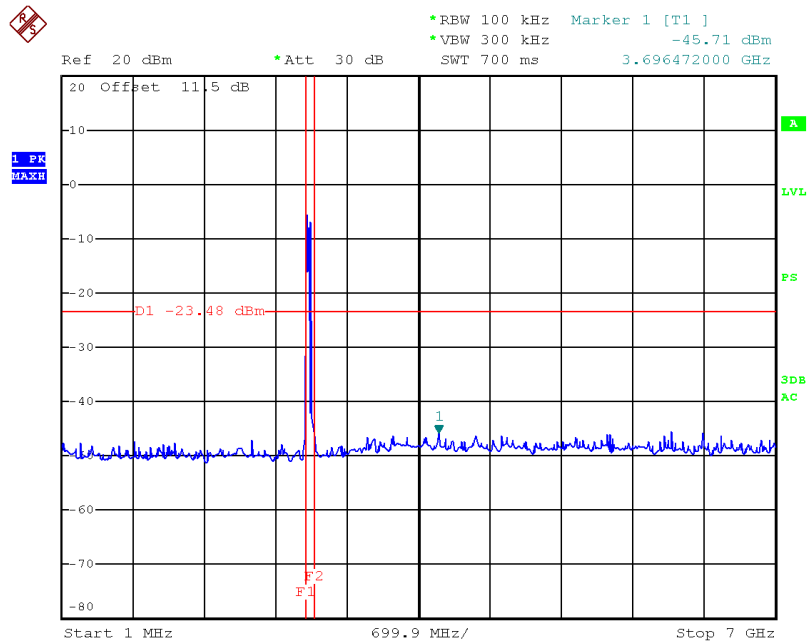

Date: 14.JUN.2015 09:36:08

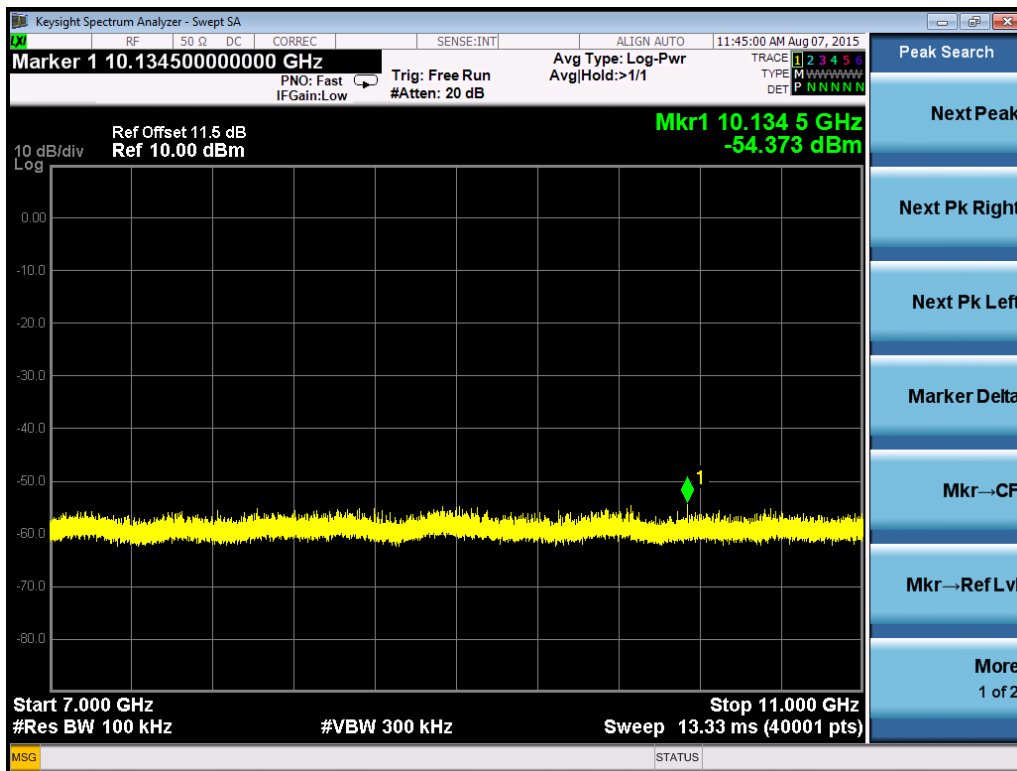

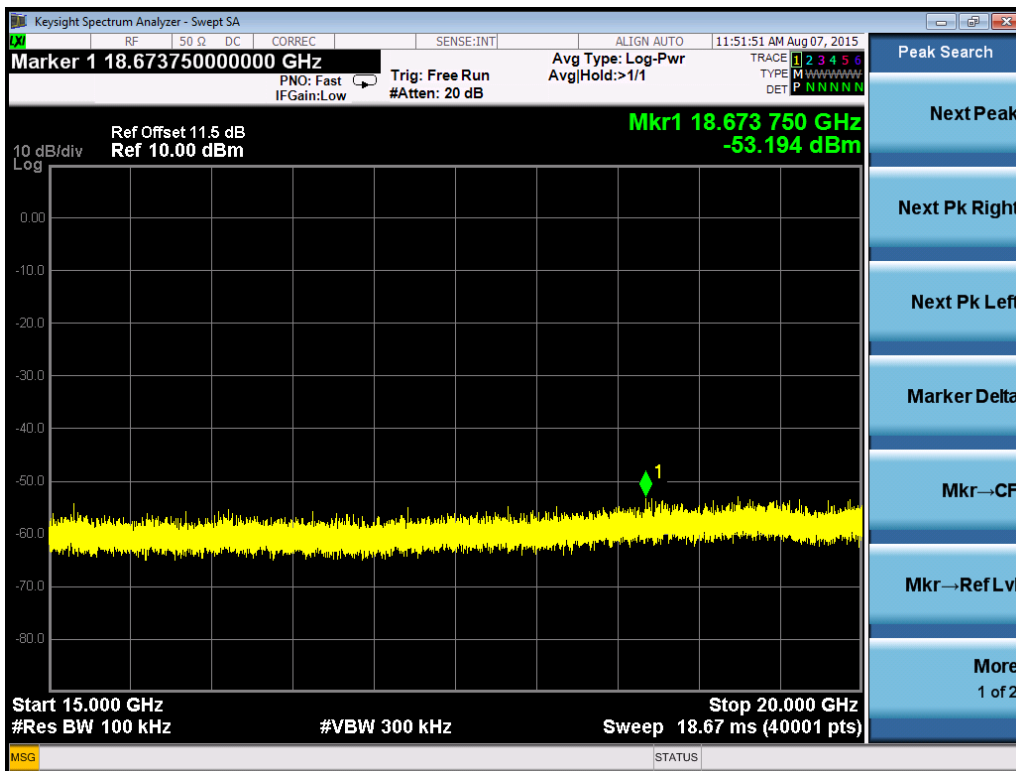
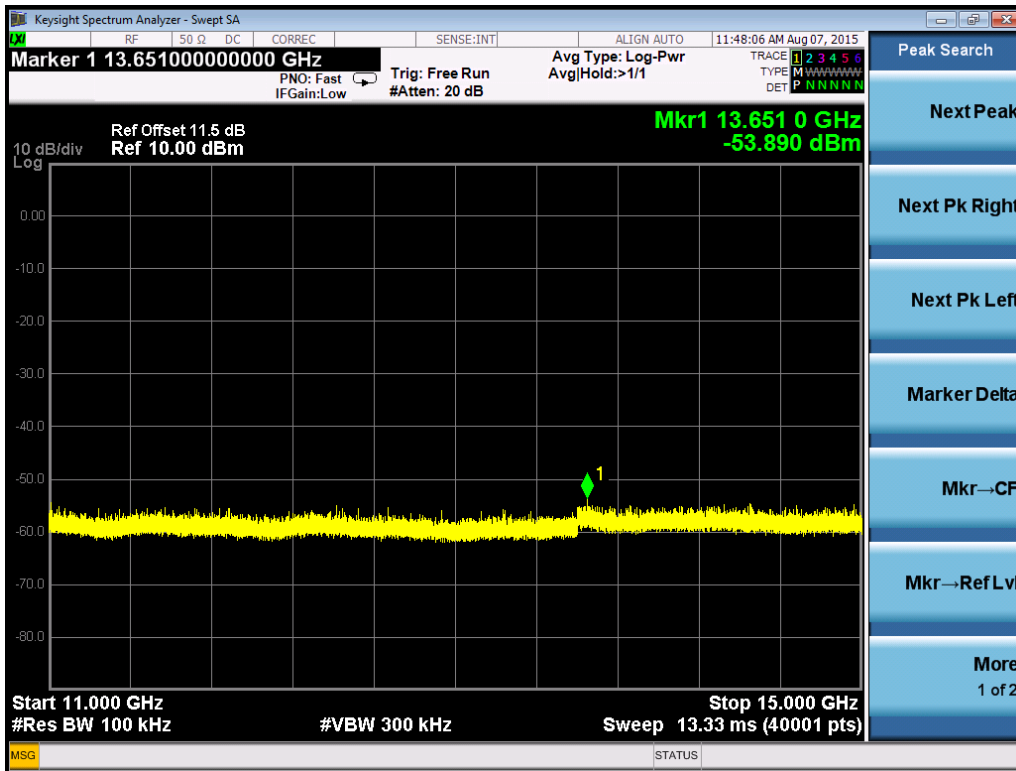



Channel M

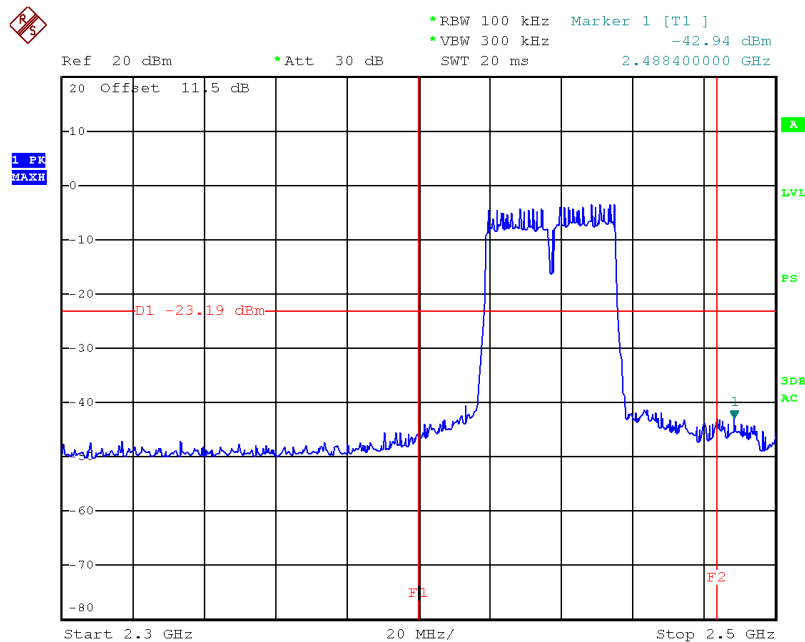

Date: 14.JUN.2015 09:36:50

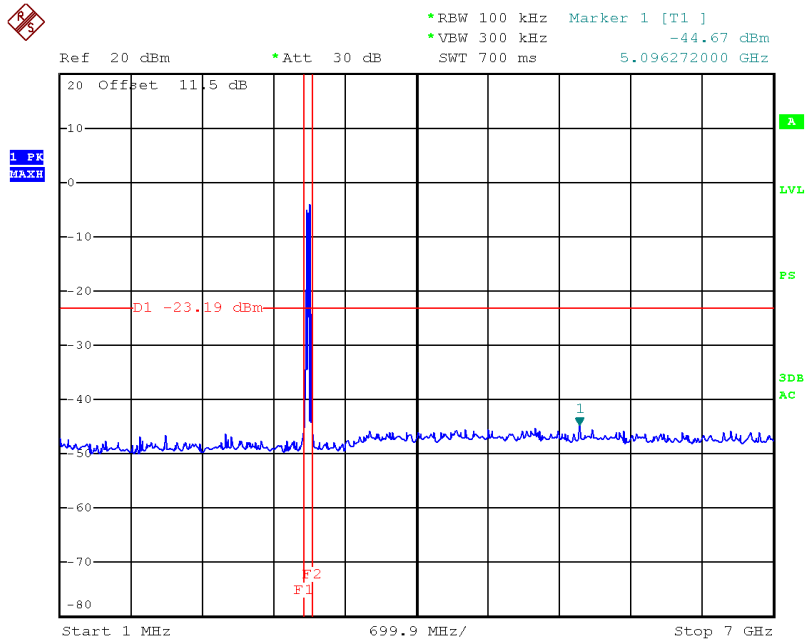

Date: 14.JUN.2015 09:39:07

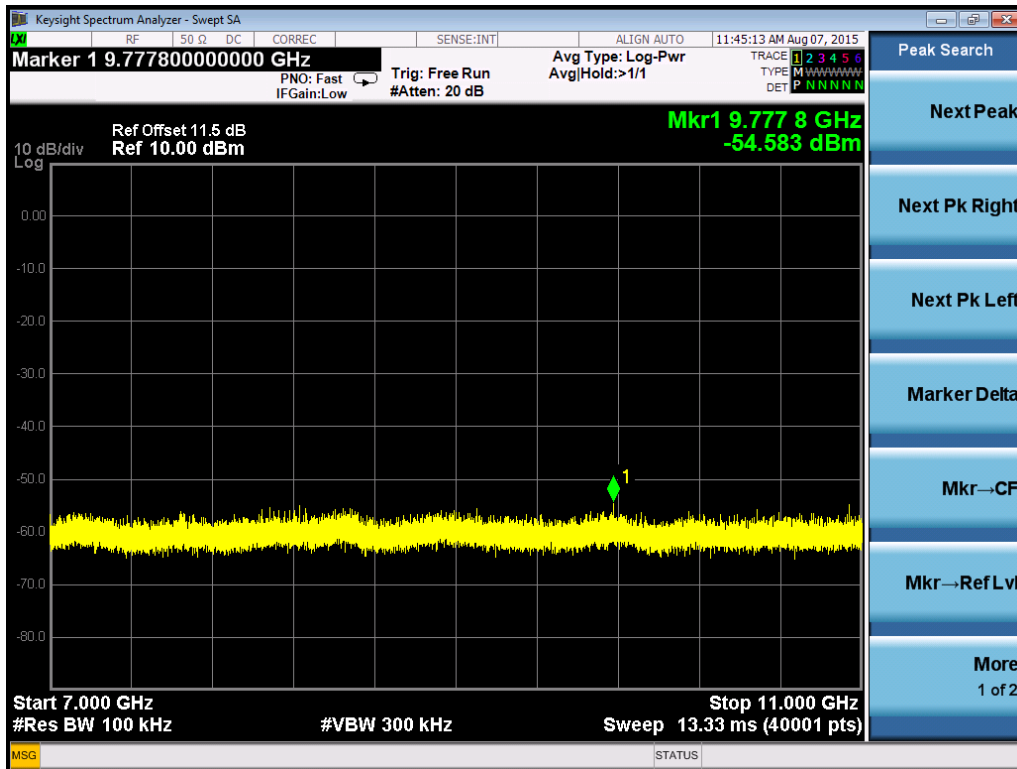

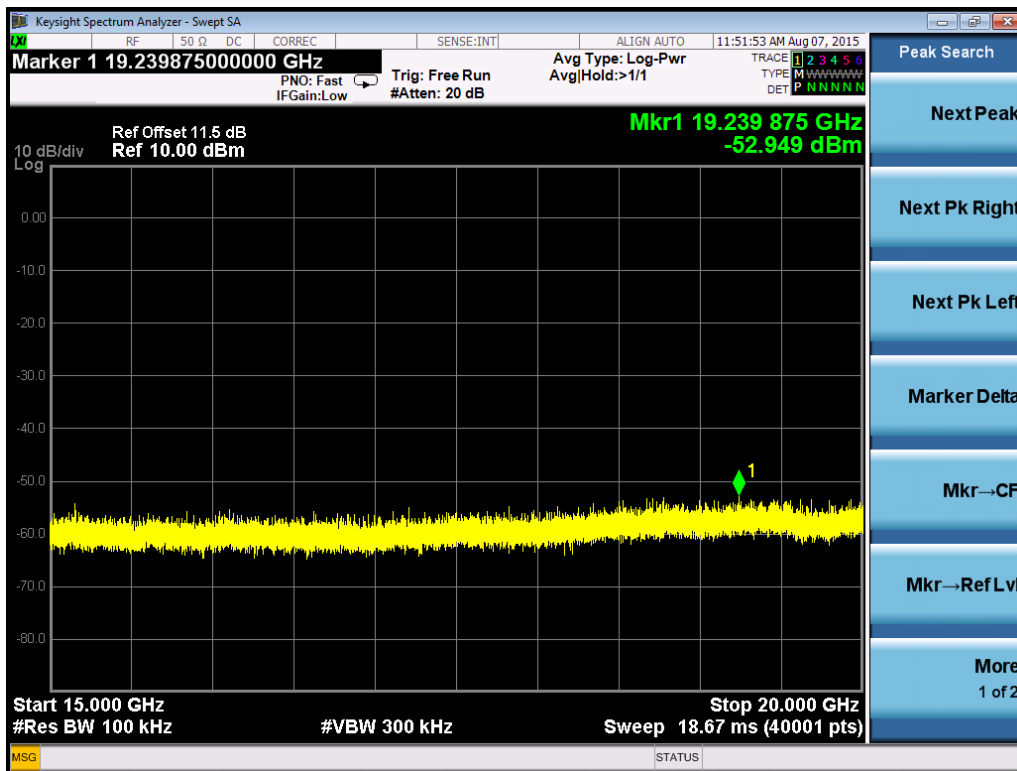
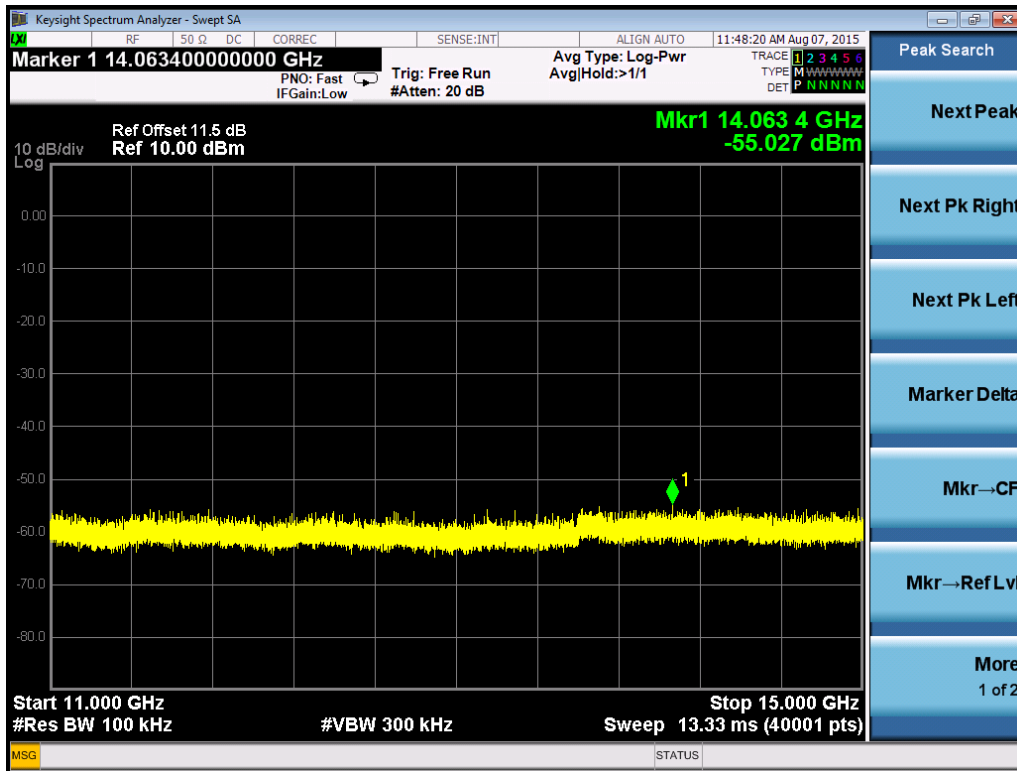

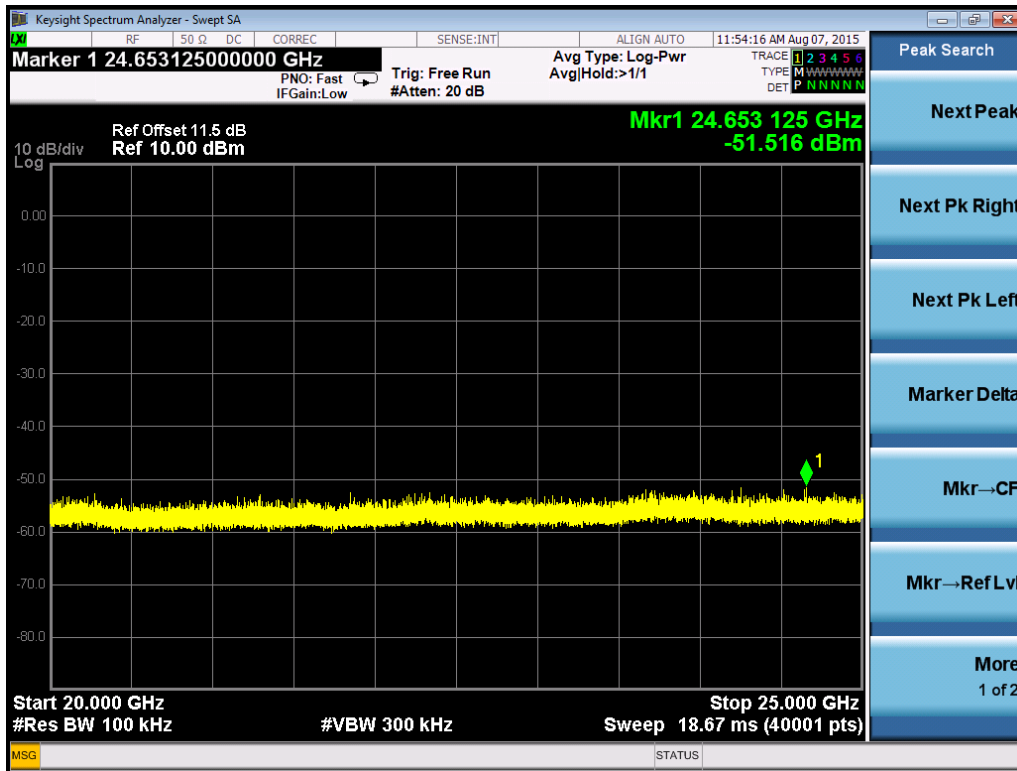

Channel H

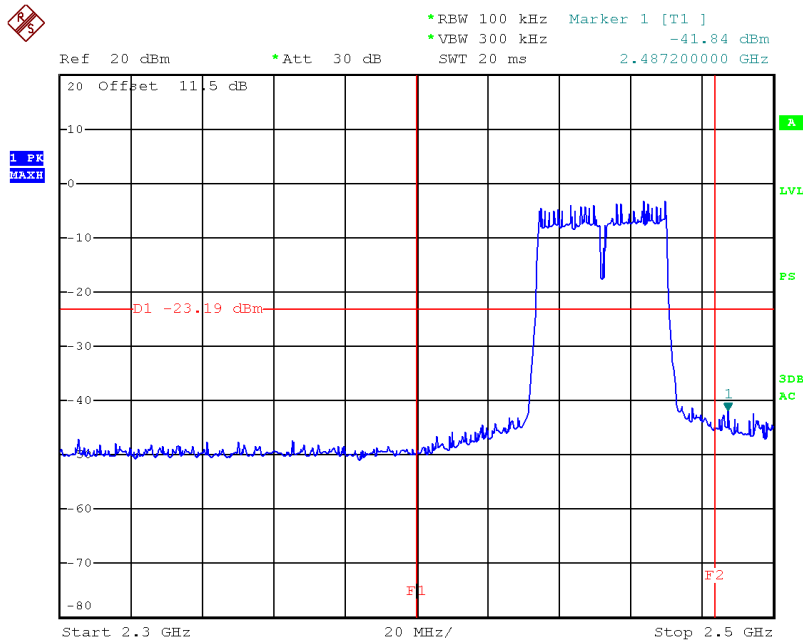

Date: 14.JUN.2015 09:39:36

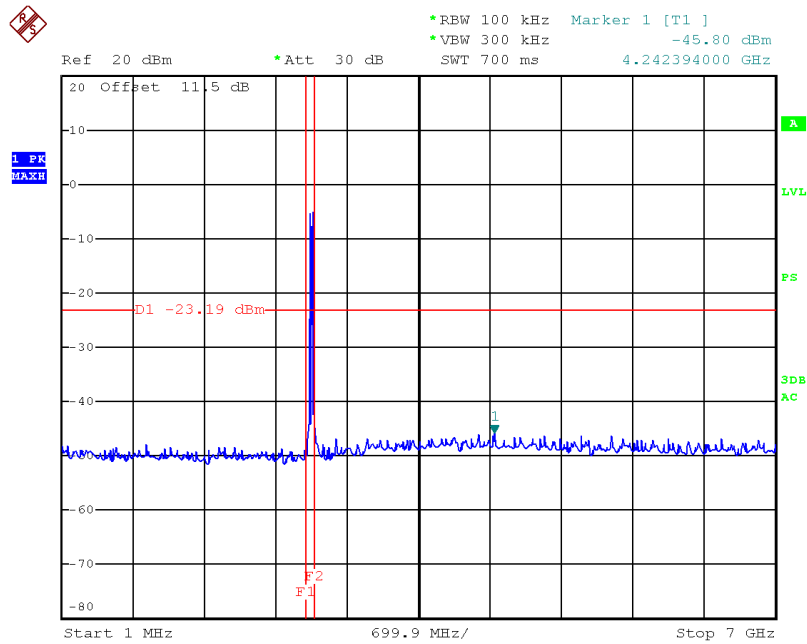

Date: 14.JUN.2015 09:40:02

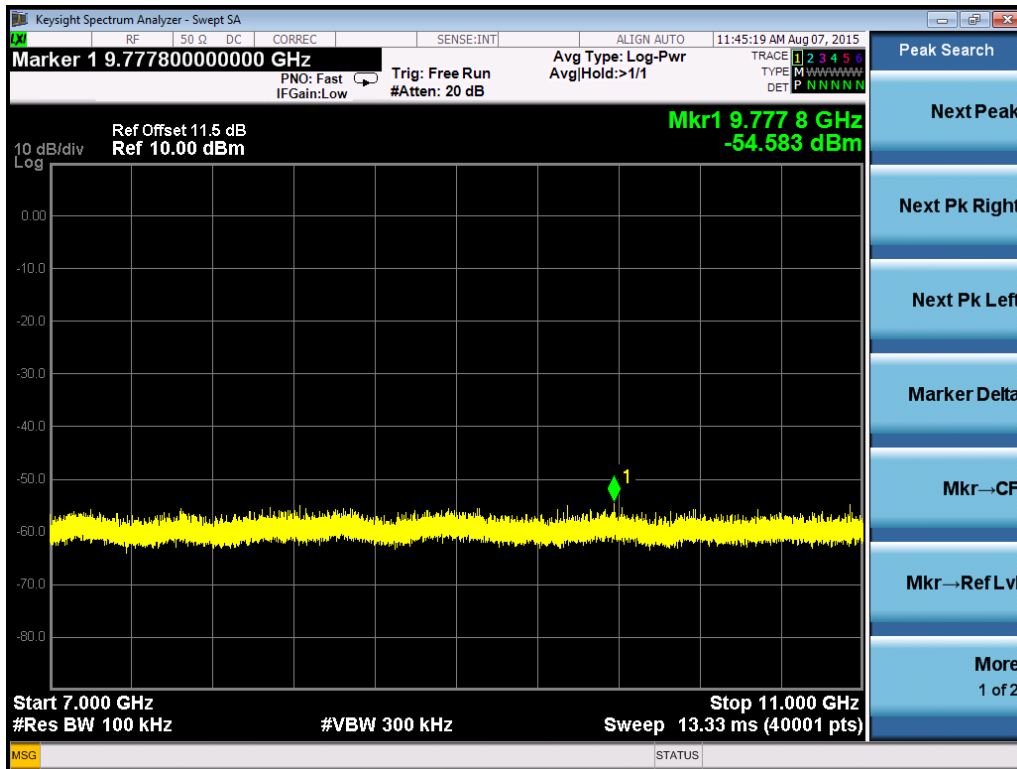

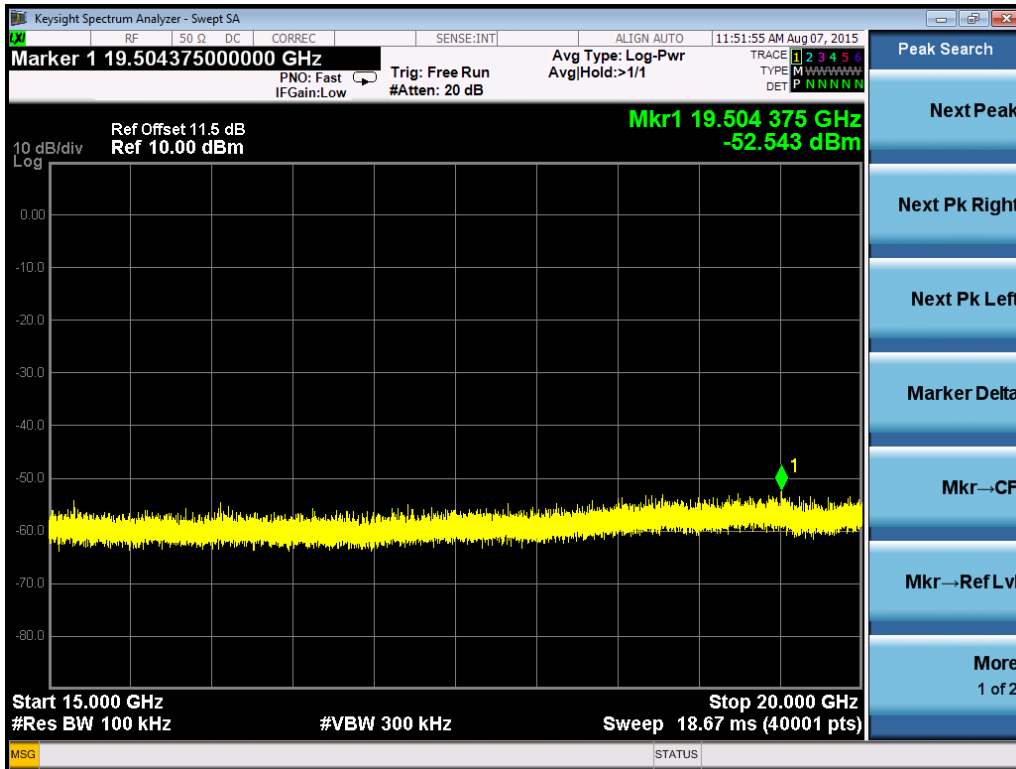
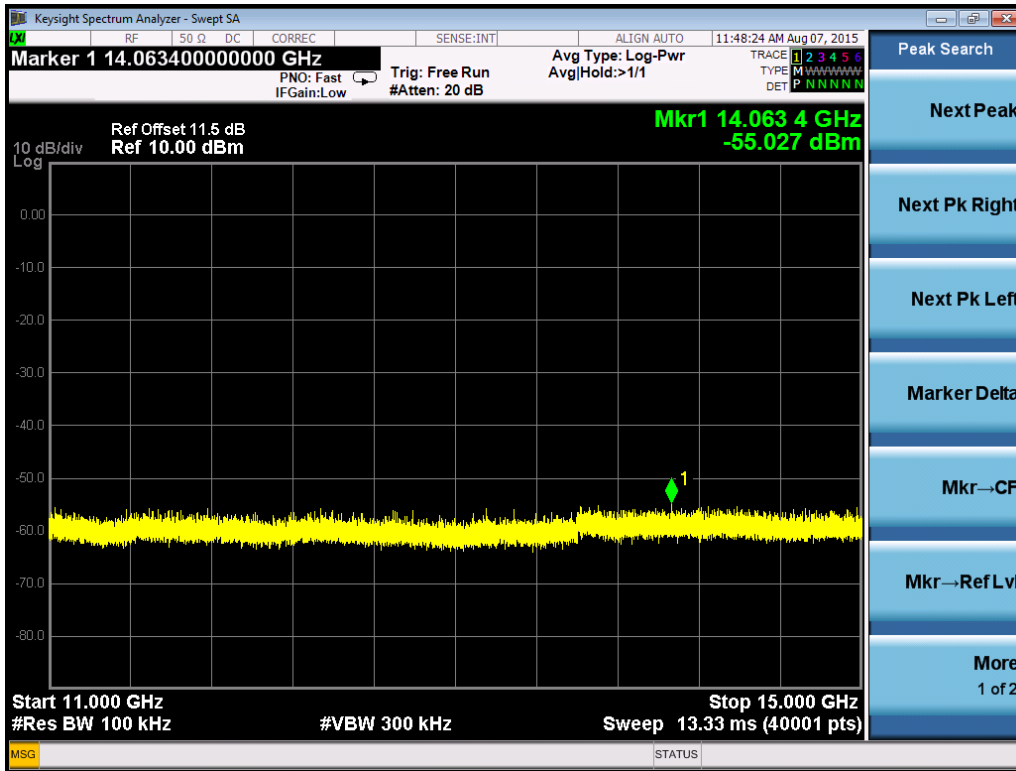

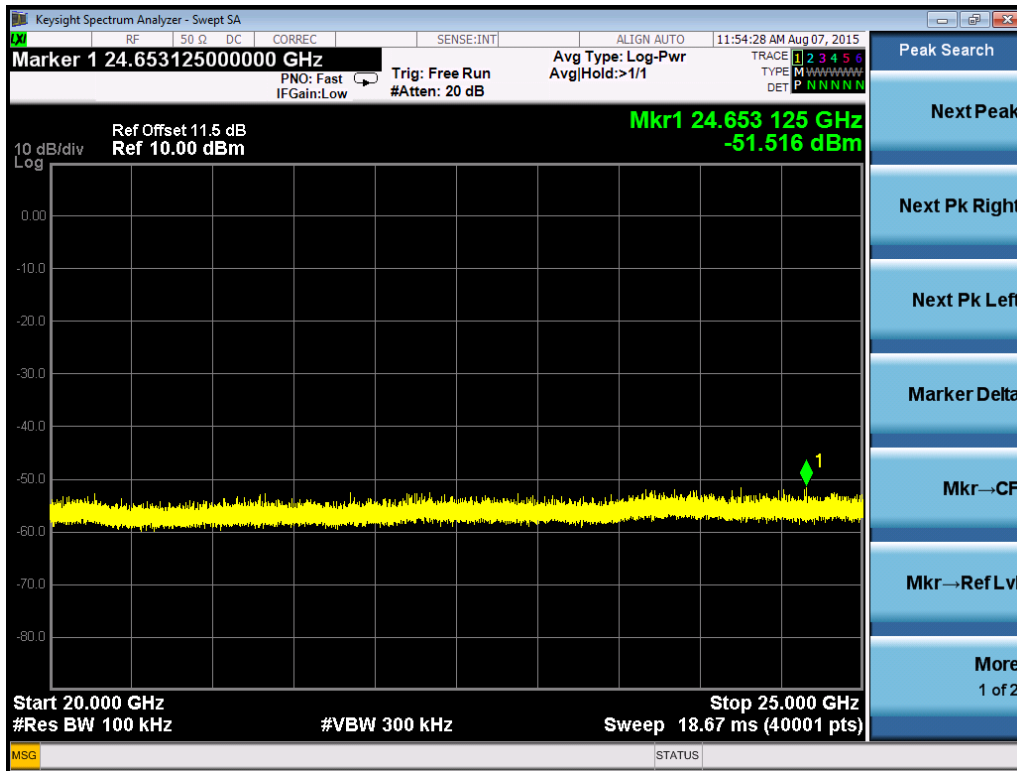

7 Radiated Emissions in restricted frequency bands

Test result: Pass

7.1 Test limit

The radiated emissions which fall in the restricted bands, as defined in § 15.205(a), must also comply with the radiated emission limits specified in § 15.209(a) showed as below:

Frequencies (MHz)	Field Strength (microvolts/meter)	Measurement Distance (meters)
0.009 ~ 0.490	2400/F(kHz)	300
0.490 ~ 1.705	24000/F(kHz)	30
1.705 ~ 30.0	30	30
30 ~ 88	100	3
88 ~ 216	150	3
216 ~ 960	200	3
Above 960	500	3

7.2 Test Configuration

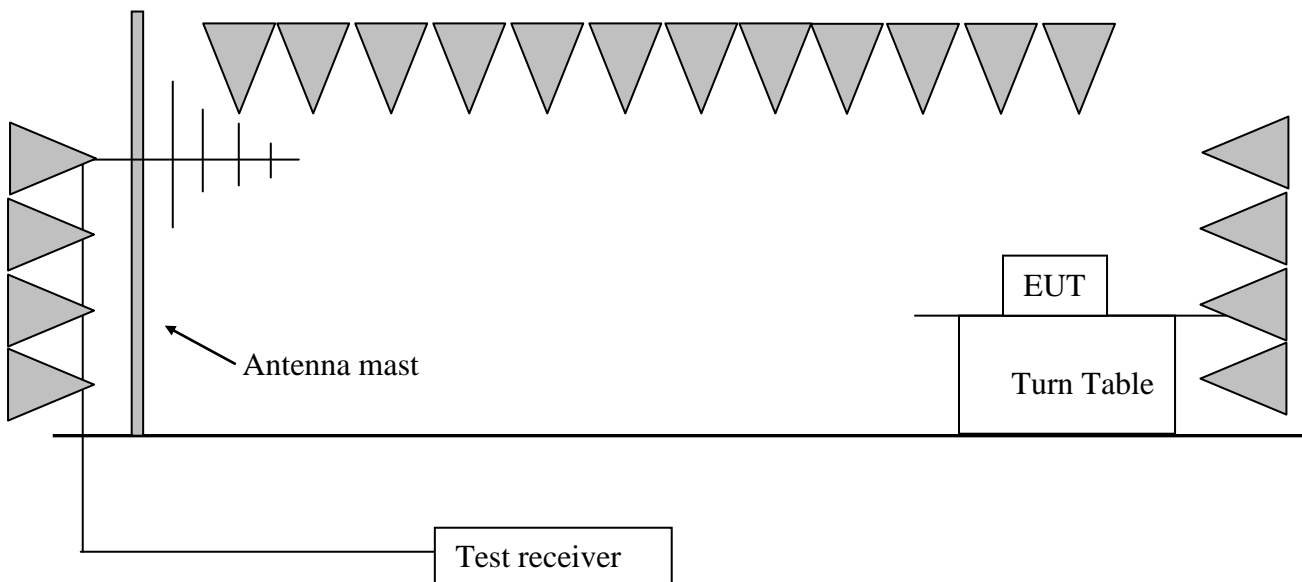

7.3 Test procedure and test setup

The measurement was applied in a semi-anechoic chamber. While testing for spurious emission higher than 1GHz, if applied, the pre-amplifier would be equipped just at the output terminal of the antenna.

Tabletop devices shall be placed on a nonconducting platform with nominal top surface dimensions 1 m by 1.5 m. For emissions testing at or below 1 GHz, the table height shall be 80 cm above the reference ground plane. For emission measurements above 1 GHz, the table height shall be 1.5 m.

The turntable rotated 360 degrees to determine the position of the maximum emission level. The EUT was set 3 meters away from the receiving antenna which was mounted on an antenna mast. The antenna moved up and down between from 1 meter to 4 meters to find out the maximum emission level.

The EUT was tested according to DTS test procedure of KDB558074 D01 DTS “Meas Guidance v03r03” for compliance to FCC 47CFR 15.247 requirements.

The radiated emission was measured using the Spectrum Analyzer with the resolutions bandwidth set as:

RBW = 300 Hz, VBW = 1 kHz (9 kHz~150 kHz);
RBW = 10 kHz, VBW = 30 kHz (150 kHz~30MHz);
RBW = 100 kHz, VBW = 300 kHz (30MHz~1GHz for PK)
RBW = 1MHz, VBW = 3MHz (>1GHz for PK);
RBW = 1MHz, VBW = 10Hz (>1GHz for AV);

Remark:

1. Factor= Antenna Factor + Cable Loss (-Amplifier, is employed)
2. Measured level= Original Receiver Reading + Factor
3. Margin = Limit – Measured level
4. If the PK measured level is lower than AV limit, the AV test can be elided.

Example:

Assuming Antenna Factor = 30.20dB/m, Cable Loss = 2.00dB,
Gain of Preamplifier = 32.00dB, Original Receiver Reading = 10dBuV.
Then Factor = 30.20 + 2.00 – 32.00 = 0.20dB/m;
Measured level = 10dBuV + 0.20dB/m = 10.20dBuV/m
Assuming limit = 54dBuV/m,
Measured level = 10.20dBuV/m, then Margin = 54 - 10.20 = 43.80dBuV/m.

7.4 Test Protocol

Temperature: 25 °C
Relative Humidity: 55 %

The low frequency, which started from 9 kHz to 30MHz, was pre-scanned and the result which was 20dB lower than the limit line per 15.31(o) was not reported.

The frequency range, which started from 30MHz to 1000MHz, was pre-scanned and found that 802.11b was the worst case, the waveform and test results was listed as below:

Horizontal

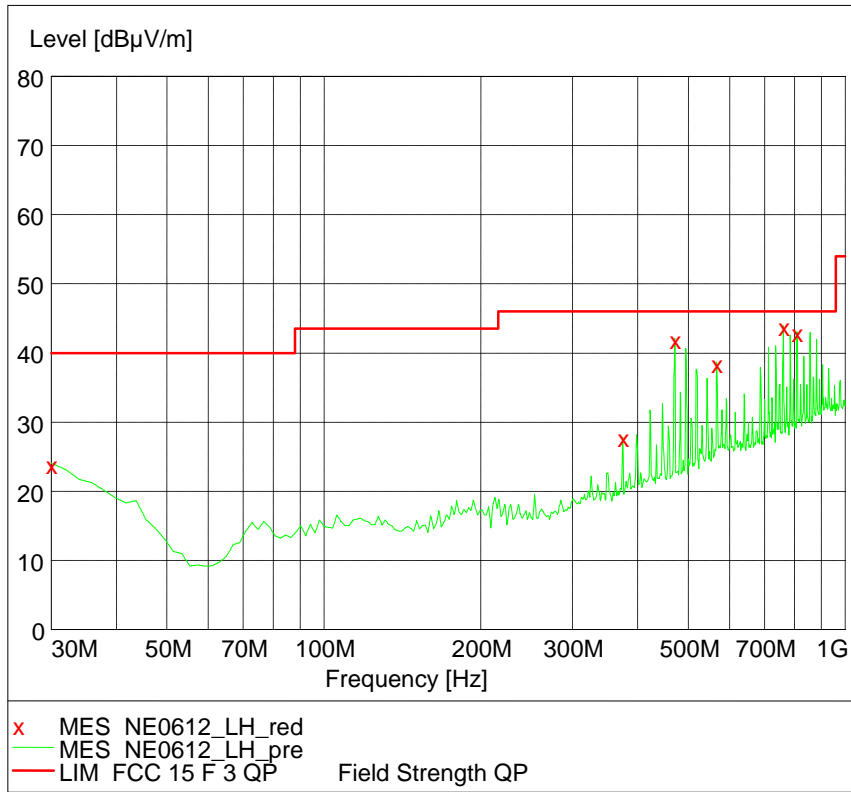

Vertical

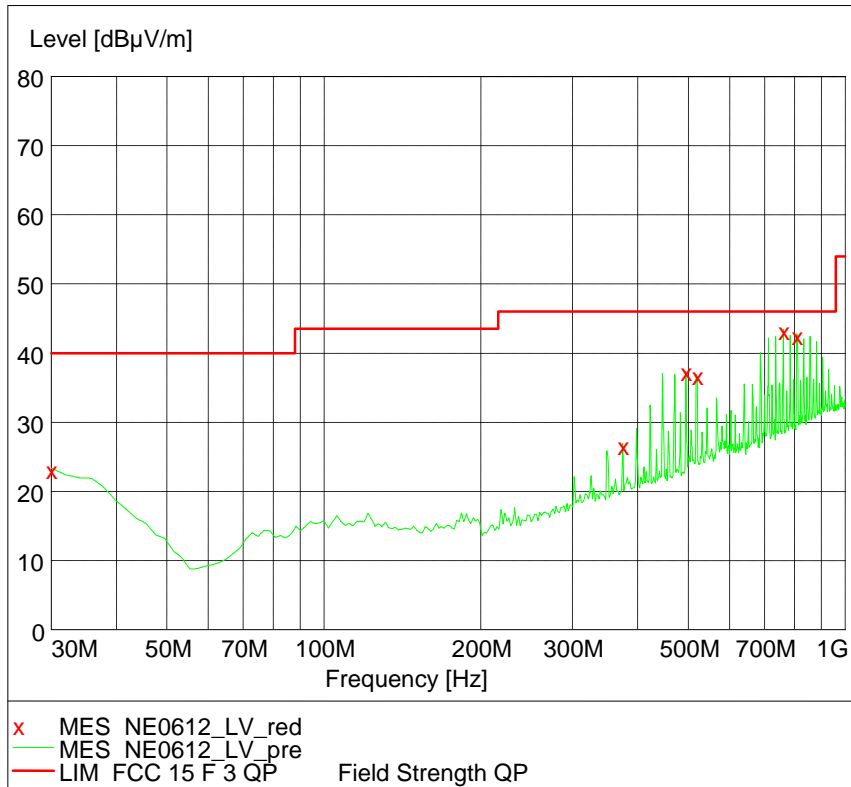

CH	Antenna	Frequency (MHz)	Corrected Reading (dBuV/m)	Correct Factor (dB/m)	Limit (dBuV/m)	Margin (dB)	Detector
L	H	471.26	42.10	18.90	46.00	3.90	PK
	H	760.90	43.90	23.60	46.00	2.10	PK
	H	807.56	43.10	24.20	46.00	2.90	PK
	V	760.90	43.50	23.60	46.00	2.50	PK
	V	807.56	42.80	24.20	46.00	3.20	PK
M	H	470.13	41.85	18.90	46.00	4.15	PK
	H	762.13	43.55	23.60	46.00	2.45	PK
	H	806.32	42.87	24.20	46.00	3.13	PK
	V	760.28	43.24	23.60	46.00	2.76	PK
	V	807.26	42.36	24.20	46.00	3.64	PK
H	H	472.56	42.05	18.90	46.00	3.95	PK
	H	761.35	43.18	23.60	46.00	2.82	PK
	H	807.14	42.98	24.20	46.00	3.02	PK
	V	760.57	43.37	23.60	46.00	2.63	PK
	V	806.98	42.19	24.20	46.00	3.81	PK

The frequency range, which started from 1GHz to 25GHz, was tested and test results was listed as below:

802.11b

CH	Antenna	Frequency (MHz)	Corrected Reading (dBuV/m)	Correct Factor (dB/m)	Limit (dBuV/m)	Margin (dB)	Detector
L	V	2412.60	104.90	34.10	Fundamental	/	PK
	V	2386.29	67.70	34.20	74.00	6.30	PK
	V	2386.29	44.94	34.20	54.00	9.06	AV
	V	4824.10	47.18	-3.60	74.00	26.82	PK
M	V	2437.55	104.70	34.20	Fundamental	/	PK
	V	4874.25	47.06	-3.40	74.00	26.94	PK
H	V	2462.90	104.40	34.40	Fundamental	/	PK
	V	2483.52	55.55	34.80	74.00	18.45	PK
	V	2483.52	42.63	34.80	54.00	11.37	AV
	V	4924.10	50.80	-3.30	74.00	23.20	PK

802.11g

CH	Antenna	Frequency (MHz)	Corrected Reading (dBuV/m)	Correct Factor (dB/m)	Limit (dBuV/m)	Margin (dB)	Detector
L	V	2412.60	104.61	34.10	Fundamental	/	PK
	V	2389.96	62.96	34.20	74.00	11.04	PK
	V	2389.96	45.94	34.20	54.00	8.06	AV
	V	4824.25	43.97	-3.60	74.00	30.03	PK
M	V	2437.55	105.99	34.20	Fundamental	/	PK
	V	4874.64	47.20	-3.40	74.00	26.80	PK
H	V	2462.90	105.54	34.40	Fundamental	/	PK
	V	2484.00	70.63	34.80	74.00	3.37	PK
	V	2484.00	48.16	34.80	54.00	5.84	AV
	V	4924.65	47.00	-3.30	74.00	27.00	PK

802.11n (HT20)

CH	Antenna	Frequency (MHz)	Corrected Reading (dBuV/m)	Correct Factor (dB/m)	Limit (dBuV/m)	Margin (dB)	Detector
L	V	2412.40	105.52	34.10	Fundamental	/	PK
	V	2389.58	64.11	34.20	74.00	9.89	PK
	V	2389.58	46.62	34.20	54.00	7.38	AV
	V	4824.34	45.20	-3.60	74.00	28.80	PK
M	V	2437.45	106.70	34.20	Fundamental	/	PK
	V	4874.38	46.10	-3.40	74.00	27.90	PK
H	V	2462.50	106.25	34.40	Fundamental	/	PK
	V	2483.52	71.59	34.80	74.00	2.41	PK
	V	2483.52	49.37	34.80	54.00	4.63	AV
	V	4924.58	49.20	-3.30	74.00	24.80	PK

802.11n (HT40)

CH	Antenna	Frequency (MHz)	Corrected Reading (dBuV/m)	Correct Factor (dB/m)	Limit (dBuV/m)	Margin (dB)	Detector
L	V	2422.35	103.20	34.10	Fundamental	/	PK
	V	2386.29	67.70	34.20	74.00	6.30	PK
	V	2386.29	44.94	34.20	54.00	9.06	AV
	V	4844.35	42.84	-3.60	74.00	31.16	PK
M	V	2437.68	102.80	34.20	Fundamental	/	PK
	V	4874.38	45.89	-3.40	74.00	28.11	PK
H	V	2452.80	103.00	34.30	Fundamental	/	PK
	V	2483.55	71.04	34.80	74.00	3.96	PK
	V	2483.55	49.65	34.80	54.00	4.35	AV
	V	4904.28	45.50	-3.30	74.00	28.50	PK

8 Power line conducted emission

Test result: Pass

8.1 Limit

Frequency of Emission (MHz)	Conducted Limit (dBuV)	
	QP	AV
0.15-0.5	66 to 56*	56 to 46 *
0.5-5	56	46
5-30	60	50

* Decreases with the logarithm of the frequency.

8.2 Test configuration

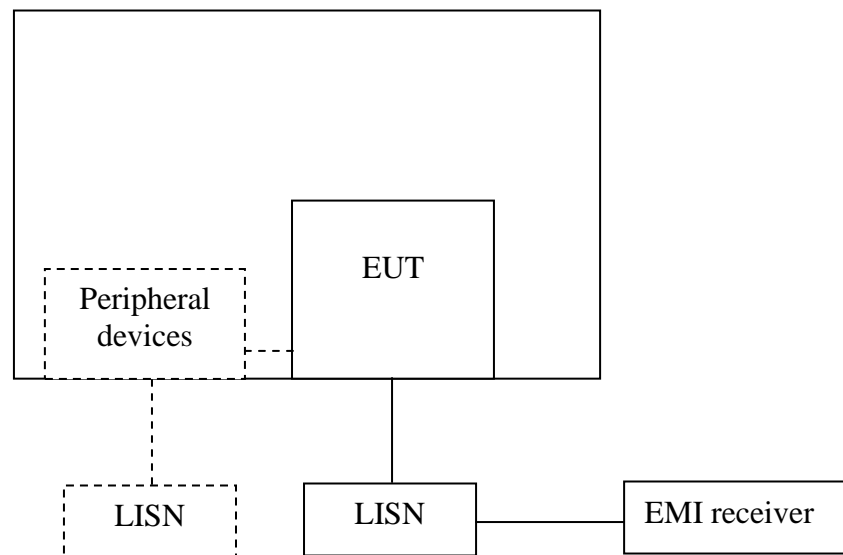

For table top equipment, wooden support is 0.8m height table

For floor standing equipment, wooden support is 0.1m height rack.

8.3 Test procedure and test set up

Measured levels of ac power-line conducted emission shall be the emission voltages from the voltage probe, where permitted, or across the 50 Ω LISN port (to which the EUT is connected), where permitted, terminated into a 50 Ω measuring instrument. All emission voltage and current measurements shall be made on each current-carrying conductor at the plug end of the EUT power cord by the use of mating plugs and receptacles on the LISN, if used. Equipment shall be tested with power cords that are normally supplied or recommended by the manufacturer and that have electrical and shielding characteristics that are the same as those cords normally supplied or recommended by the manufacturer. For those measurements using a LISN, the 50 Ω measuring port is terminated by a measuring instrument having 50 Ω input impedance. All other ports are terminated in 50 Ω loads.

Tabletop devices shall be placed on a platform of nominal size 1 m by 1.5 m, raised 80 cm above the reference ground plane. The vertical conducting plane or wall of an RF-shielded (screened) room shall be located 40 cm to the rear of the EUT. Floor-standing devices shall be placed either directly on the reference ground-plane or on insulating material as described in ANSI C63.4. All other surfaces of tabletop or floor-standing EUTs shall be at least 80 cm from any other grounded conducting surface, including the case or cases of one or more LISNs.

The bandwidth of the test receiver is set at 9 kHz.

8.4 Test protocol

Temperature: 25 °C
Relative Humidity: 55 %

L Line

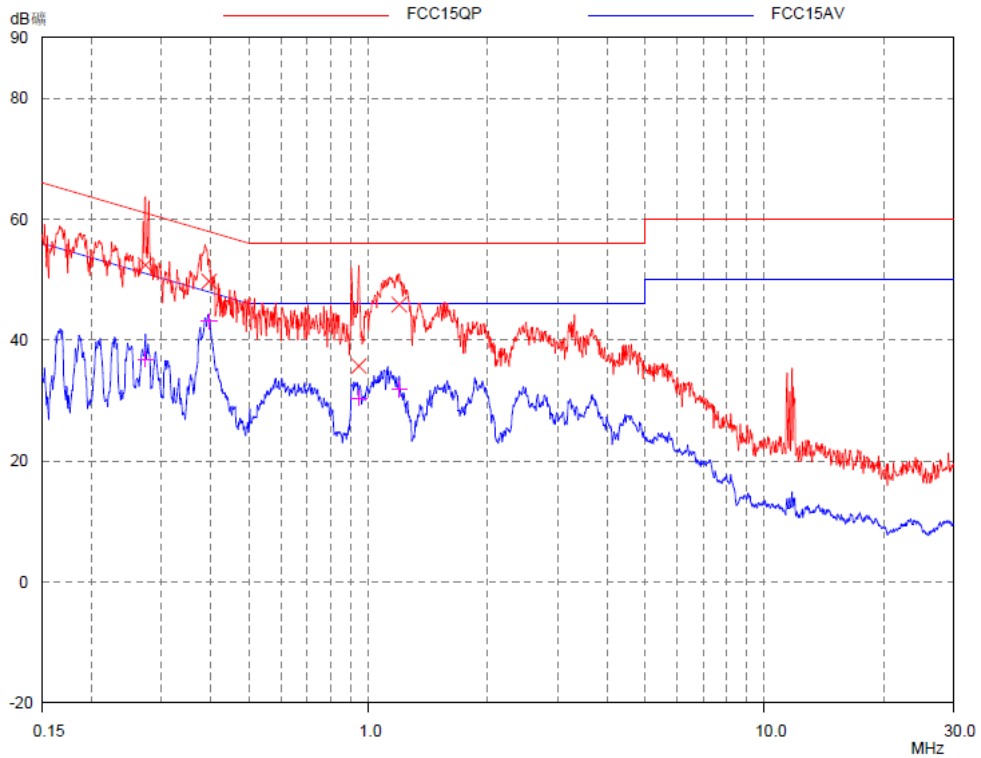

Test Data:

Frequency (MHz)	Quasi-peak			Average		
	level dB(µV)	Limit dB(µV)	Margin (dB)	level dB(µV)	limit dB(µV)	Margin (dB)
0.273	52.43	61.03	8.60	36.81	51.03	14.22
0.396	49.70	57.94	8.24	43.13	47.94	4.81
0.945	35.71	56.00	20.29	30.40	46.00	15.60
1.196	45.87	56.00	10.13	31.84	46.00	14.16

N Line

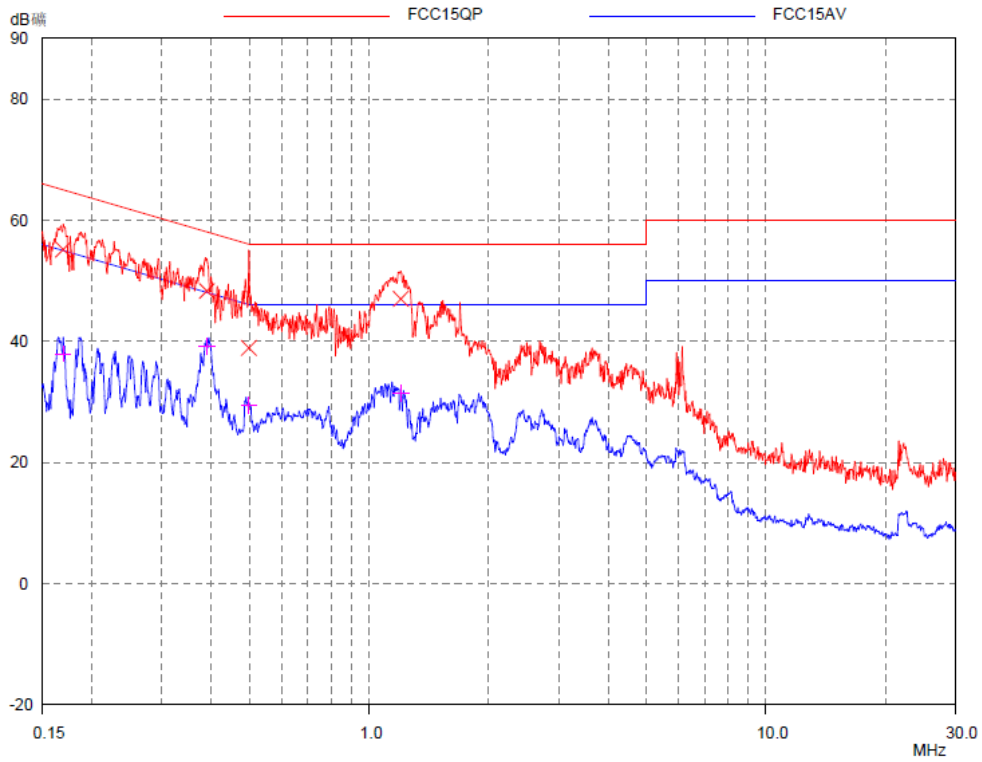

Test Data:

Frequency (MHz)	Quasi-peak			Average		
	level dB(µV)	Limit dB(µV)	Margin (dB)	level dB(µV)	limit dB(µV)	Margin (dB)
0.169	55.17	65.01	9.84	37.95	55.01	17.06
0.389	48.33	58.08	9.75	39.22	48.08	8.86
0.497	38.92	56.05	17.13	29.41	46.05	16.64
1.200	47.01	56.00	8.99	31.47	46.00	14.53

9 Occupied Bandwidth

Test Status: Tested

9.1 Test limit

None

9.2 Test Configuration

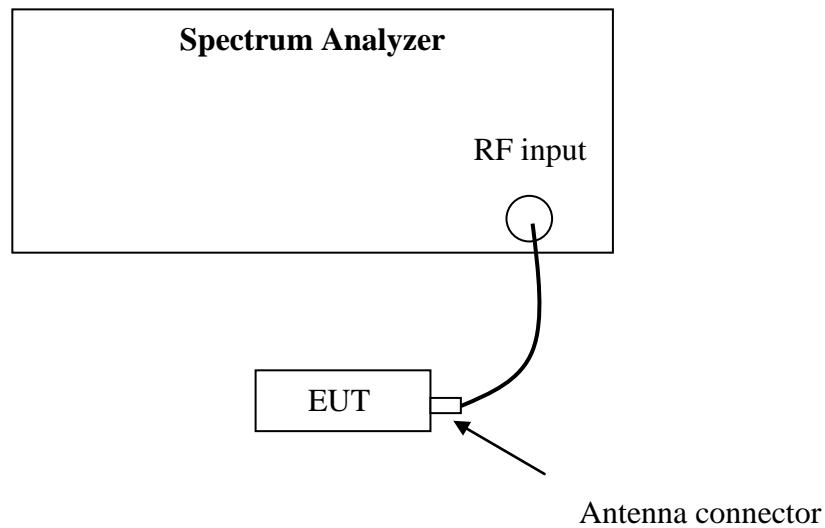

9.3 Test procedure and test setup

The occupied bandwidth per RSS-Gen Issue 4 Clause 6.6 was measured using the Spectrum Analyzer.

9.4 Test protocol

Temperature : 25 °C
Relative Humidity : 55 %

Mode	Mode	99% Bandwidth (MHz)		
		Port0	Port 1	Port 2
802.11b	L	11.94	-	-
	M	11.94	-	-
	H	11.88	-	-

Channel L

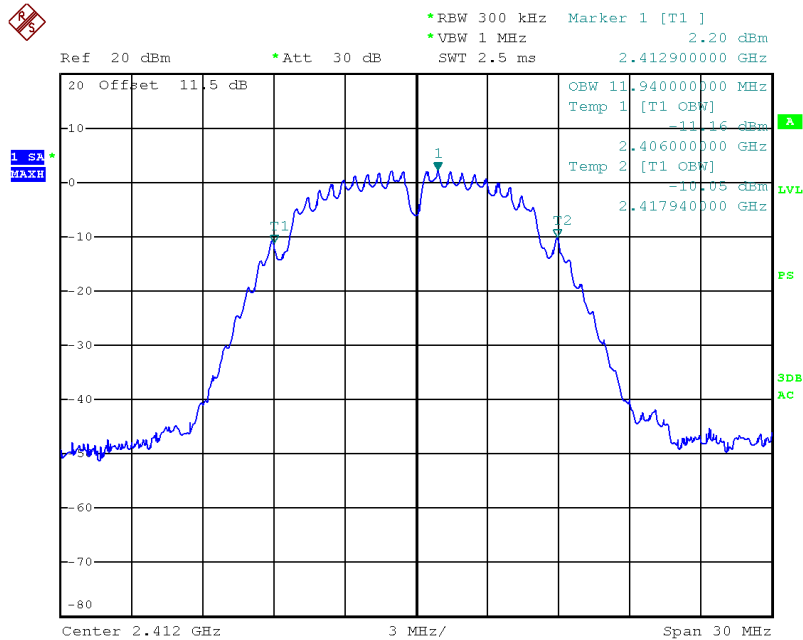

Date: 11.JUN.2015 16:04:33

Channel M

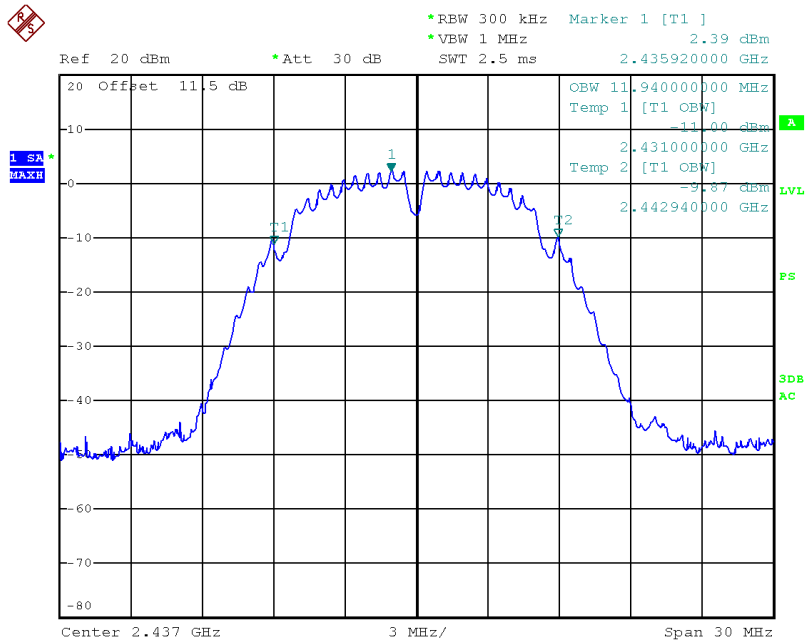

Date: 11.JUN.2015 16:05:22

Channel H

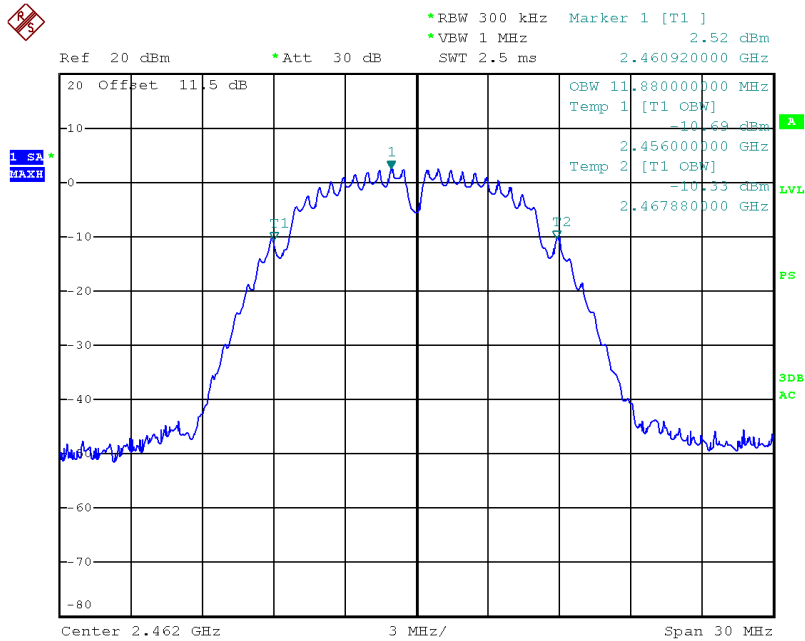

Date: 11.JUN.2015 16:06:09

Mode	Mode	99% Bandwidth (MHz)		
		Port0	Port 1	Port 2
802.11g	L	17.10	-	-
	M	17.04	-	-
	H	17.10	-	-

Channel L

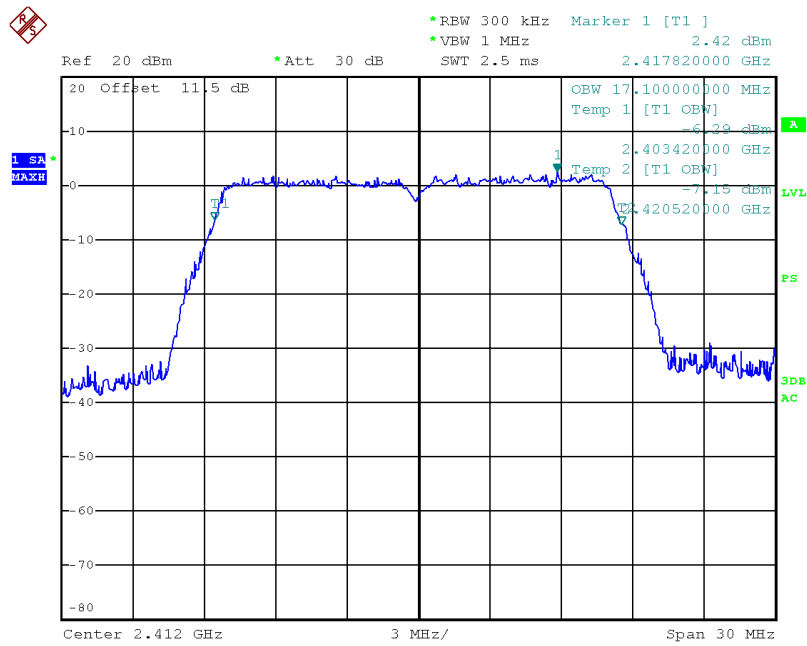

Date: 11.JUN.2015 16:07:29

Channel M

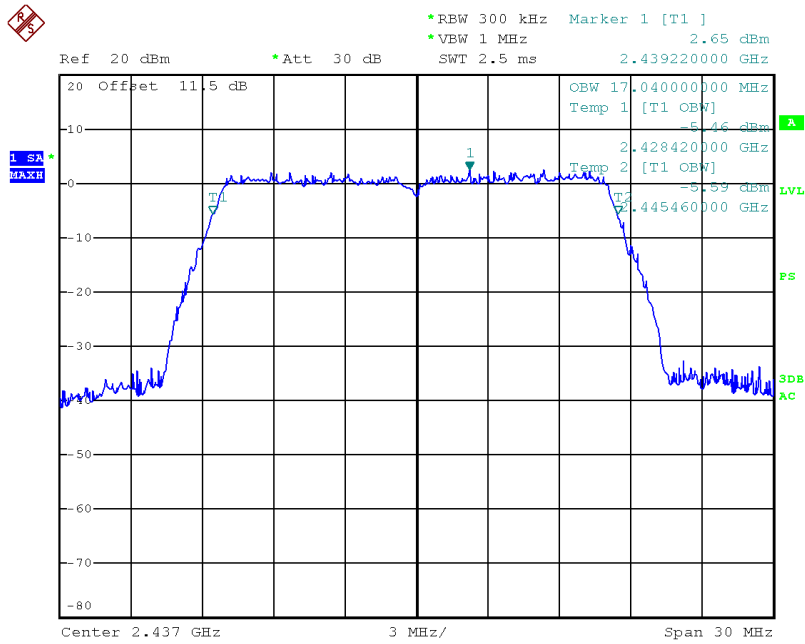

Date: 11.JUN.2015 16:08:20

Channel H

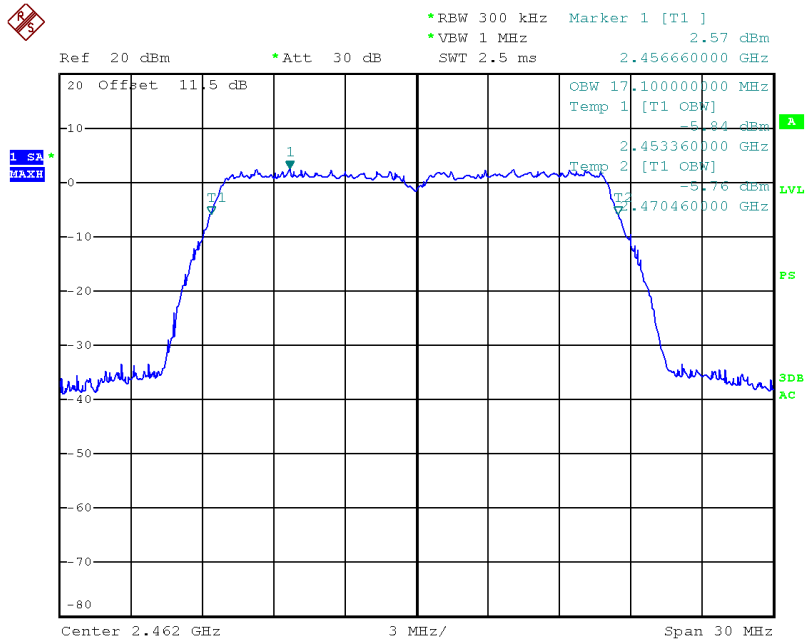

Date: 11.JUN.2015 16:10:00

Mode	Mode	99% Bandwidth (MHz)		
		Port0	Port 1	Port 2
802.11n (HT20)	L	18.00	-	-
	M	18.00	-	-
	H	18.00	-	-

Channel L

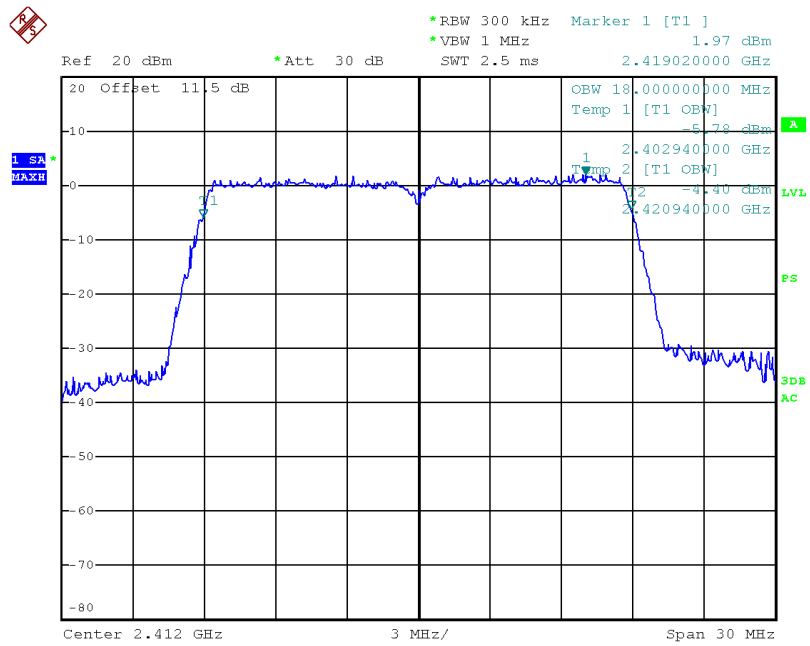

Date: 11.JUN.2015 16:11:34

Channel M

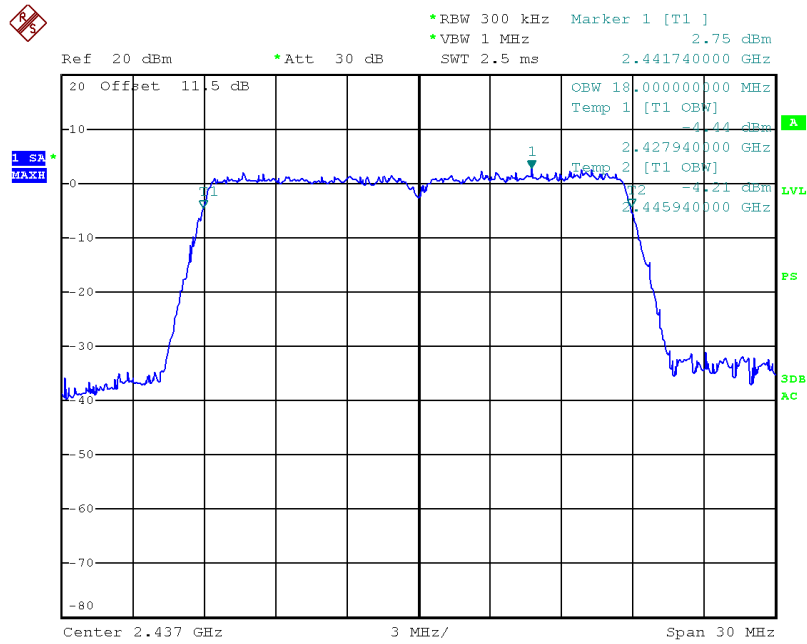

Date: 11.JUN.2015 16:12:56

Channel H

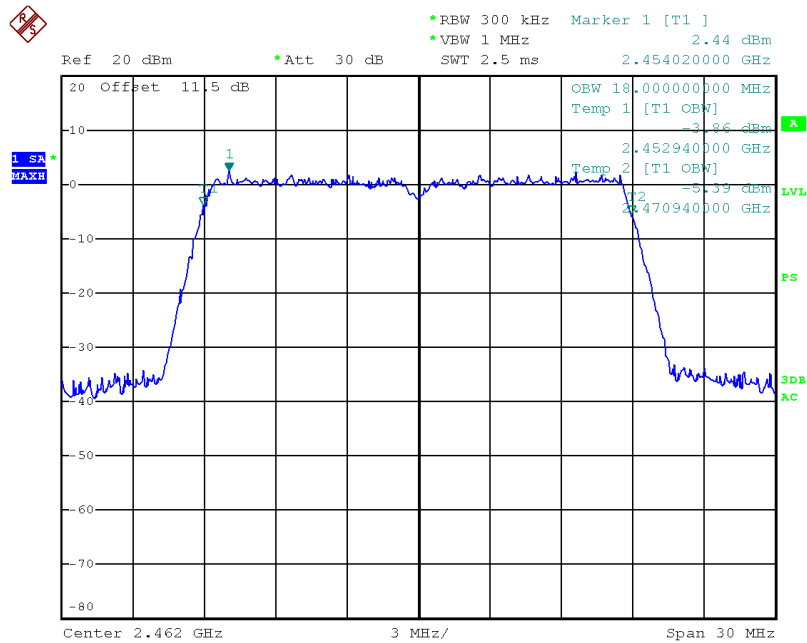

Date: 11.JUN.2015 16:17:18

Mode	Mode	99% Bandwidth (MHz)		
		Port0	Port 1	Port 2
802.11n (HT40)	L	36.80	-	-
	M	36.64	-	-
	H	36.64	-	-

Channel L

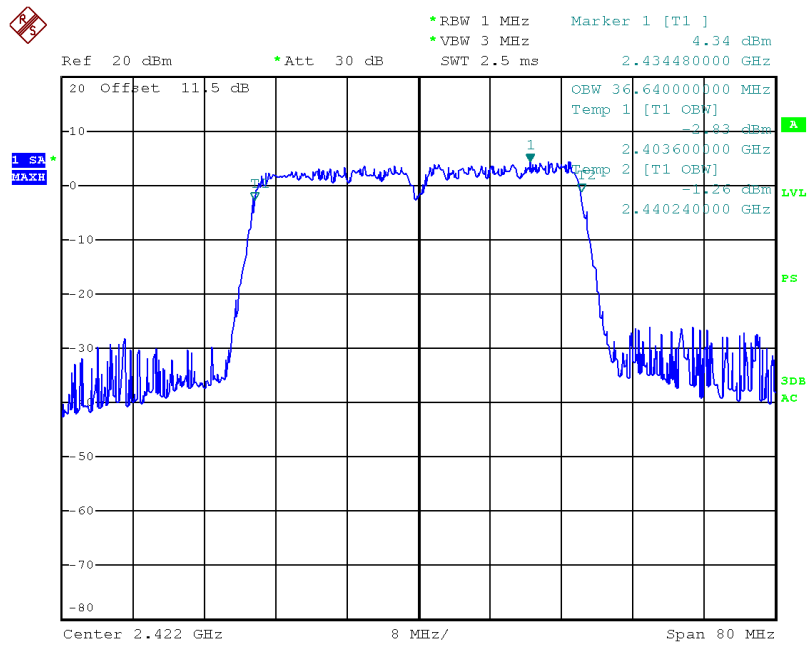

Date: 11.JUN.2015 16:18:58

Channel M

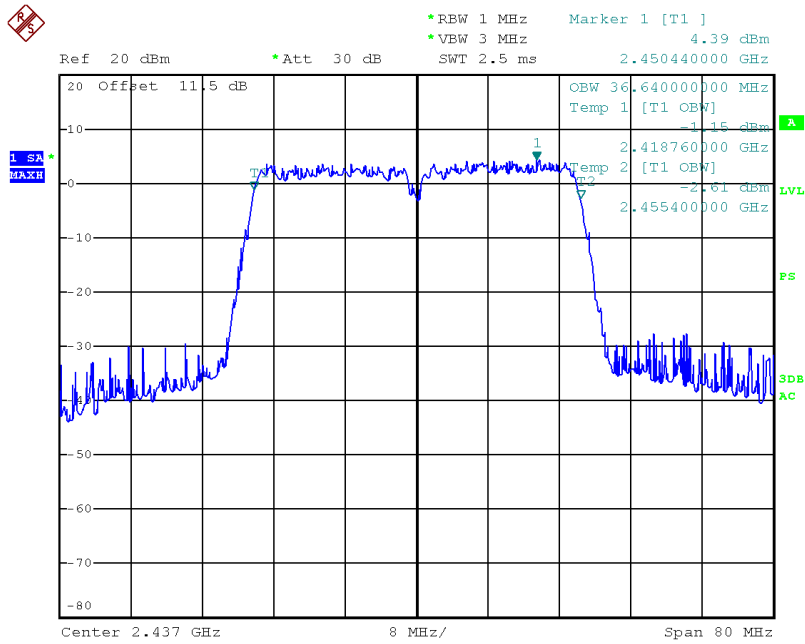

Date: 11.JUN.2015 16:19:58

Channel H

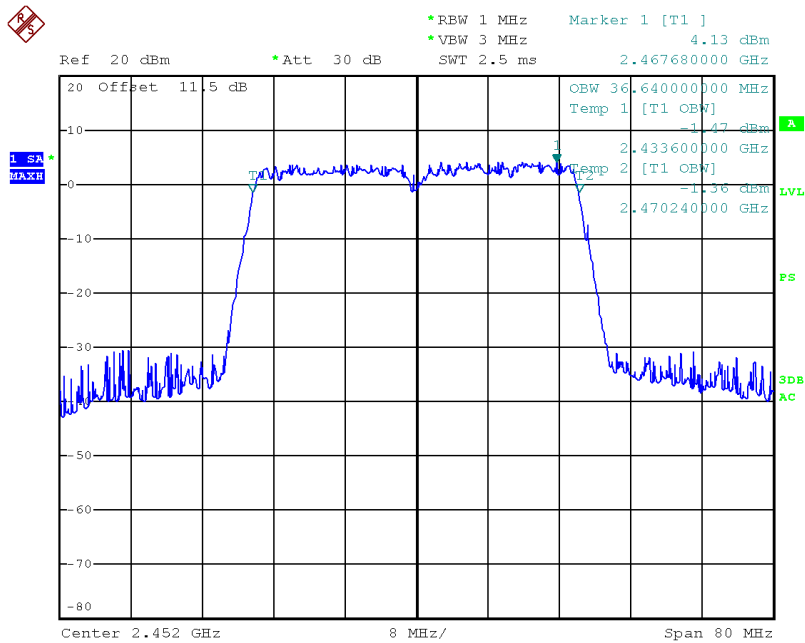

Date: 11.JUN.2015 16:20:47