



FCC Part 15, Subpart C, Section 15.247

Test Report

On

Ruggedized Wireless Structural Health Monitoring Node
FCC ID: XJQMSLINK0008

Customer Name: Lord Corporation

Customer P.O.: 702539

Date of Report: November 17, 2017

Test Report No.: R-6265N-1

Test Start Date: October 18, 2017

Test Finish Date: October 27, 2017

Test Technician: M. Seamans

Report Approved By: T. Hannemann

Report Prepared By: J. Ramsey

Our letters, procedures and reports are for the exclusive use of the customer to whom they are addressed and their communication or the use of the name of Retlif Testing Laboratories must receive our prior written approval. Our letters, procedures and reports apply only to the sample tested and are not necessarily indicative of the qualities of apparently identical or similar products. The letters, procedures and reports and the name of Retlif Testing Laboratories or insignia are not to be used under any circumstances in advertising to the general public. This test report shall not be reproduced, except in full, without the written approval of Retlif Testing Laboratories.

Technical Information

Report Number: R-6265N-1

Customer: Lord Corporation

Address: 459 Hurricane Lane, Suite 102
Williston, VT 05495

Manufacturer: Lord Corporation

Manufacturer Address: 459 Hurricane Lane, Suite 102
Williston, VT 05495

Test Sample: Ruggedized Wireless Structural Health Monitoring Node

Model Number: SHM-Link-201

Serial Number: 6329-0150-00001

FCC ID: XJQMSLINK0008
Type: Digital Transmission – Direct Sequence Spread Spectrum Transmitter

Power Requirements: 3.6 VDC Internal Battery

Frequency of Operation: 2402.0 to 2480.0 MHz

Modulations: LXRS, LXRS+

Equipment Class: DTS

Antenna Type: Internal Chip Antenna 1.5 dBi Gain

Equipment Use: Wireless Data Node

Test Specification:

FCC Rules and Regulations Part 15, Subpart C, Section 15.247

Test Procedure:

ANSI C63.4: 2014

ANSI C63.10: 2013

Test Facility:

Retlif Testing Laboratories

101 New Boston Road

Goffstown, NH 03045

FCC Designation Number: US5327



Retlif Testing Laboratories

Report No. R-6265N-1

Table 1 – Tests Performed

FCC Part 15, Subpart C	Test Method
15.247(b)(3)	Power Output
15.247(a)(2)	Occupied Bandwidth
15.247(d)	Antenna Terminal Out of Band/Band Edge Conducted Emissions
15.247(d)	Out of Band/Band Edge Radiated Emissions
15.247(e)	Power Density

EUT Operation:

The EUT was transmitting a modulated signal at 2.405 GHz (Channel 11), 2.440 GHz (Channel 18) and 2.480 GHz (Channel 26).

EUT Description:

The SHM-Link-201 Structural Health Monitoring Node is used for in-situ, multidimensional measurement and analysis of component strain and fatigue.

All equipment that was utilized to achieve the EUT operating state is specified in the table below:

Table 2 – Support Equipment

Description	Manufacturer	Model Number	Serial Number
Wireless Gateway	Lord Corporation	WSDA-200-USB	6307-2040-00086
Laptop	Gateway	NE56R52U	NXY1UAA045348501F63400



Retlif Testing Laboratories

Report No. R-6265N-1

Certification and Signatures

We certify that this report is a true representation of the results obtained from the tests of the equipment stated. We further certify that the measurements shown in this report were made in accordance with the procedures indicated and vouch for the qualifications of all Retlif Testing Laboratories personnel taking them.



Scott Wentworth
Branch Manager
NVLAP Approved Signatory



Todd Hannemann
EMC Test Engineer
iNARTE Certified Technician ATL-0255-T

Non-Warranty Provision

The testing services have been performed, findings obtained and reports prepared in accordance with generally accepted laboratory principles and practices. This warranty is in lieu of all others, either expressed or implied.

Non-Endorsement

This test report contains only findings and results arrived at after employing the specific test procedures and standards listed herein. It is not intended to constitute a recommendation, endorsement or certification of the product or material tested. This test report must not be used by the client to claim product endorsement by NVLAP or any agency of the U.S. Government.



Retlif Testing Laboratories

Report No. R-6265N-1

Revision History

Revisions to this document are listed below; the latest revised document supersedes all previous issues of this document:

Revision	Date	Pages Affected
-	November 17, 2017	Original Release



Retlif Testing Laboratories

Report No. R-6265N-1

Requirements and Test Results

FCC Section 15.247 (a)(2) – Bandwidth

For systems using digital modulation techniques operating in the 902-928 MHz, 2400-2483.5 MHz, and 5725 – 5850 MHz bands the minimum 6 dB bandwidth shall be at least 500 kHz.

- **Results:**

The minimum 6dB bandwidth measured while transmitting was 1.675 MHz. The device was found to meet the requirement of 15.247 (a)(2).

FCC Section 15.247 (b)(3) - Power Output

For systems using digital modulation in the 902-928 MHz, 2400-2483.5 MHz, and 5725-5850 MHz bands: 1 Watt. As an alternative to a peak power measurement, compliance with the one Watt limit can be based on a measurement of the maximum conducted output power. Maximum Conducted Output Power is defined as the total transmit power delivered to all antennas and antenna elements averaged across all symbols in the signaling alphabet when the transmitter is operating at its maximum power control level. Power must be summed across all antennas and antenna elements. The average must not include any time intervals during which the transmitter is off or is transmitting at a reduced power level. If multiple modes of operation are possible (e.g.: alternative modulation methods), the maximum conducted output power is the highest total transmit power occurring in any mode.

- **Results:**

The maximum measured peak conducted output power when transmitting was 16.79 mW. The maximum antenna gain of the antenna is 1.5 dBi. The device was found to meet the power output requirements of 15.247 (b)(3) including de facto EIRP.



Retlif Testing Laboratories

Report No. R-6265N-1

Requirements and Test Results (con't)

FCC Section 15.247(d) – Unwanted Emissions

Antenna Terminal Out of Band/Band Edge Conducted Emissions

In any 100 kHz bandwidth outside the frequency band in which the spread spectrum or digitally modulated intentional radiator is operating, the radio frequency power that is produced by the intentional radiator shall be at least 20 dB below that in the 100 kHz bandwidth within the band that contains the highest level of the desired power, based on either an RF conducted or a radiated measurement, provided the transmitter demonstrates compliance with the peak conducted power limits. If the transmitter complies with the conducted power limits based on the use of RMS averaging over a time interval, as permitted under Paragraph (b)(3) of Section 15.247, the attenuation required under this paragraph shall be 30 dB instead of 20 dB. Attenuation below the general limits specified in Section 15.209(a) is not required. In addition, radiated emissions which fall in the restricted bands, as defined in Section 15.205(a) must also comply with the radiated emission limits specified in Section 15.209(a) (see Section 15.205(c)).

- **Results:**

All measured out of band/band edge conducted emissions were below the specified limits and the device was found to meet the requirements of 15.247 (d).

FCC Section 15.247(d) – Unwanted Emissions

Radiated Spurious Emissions/Restricted Bands/Band Edge

Emissions which fall into restricted bands, as defined in 15.205(a) must comply with the radiated emissions limits specified in 15.209(a) and shown below in Table 3. Emissions emanating from the EUT cabinet and cables must also comply with the radiated emissions limits. Radiated emissions measurements were also performed at the band edges to ensure band edge compliance.

Table 3 - Radiated Emission Limits

Frequency of Emission (MHz)	Field Strength (microvolts/meter)	Measurement Distance (meters)
30 to 88	100	3
88 to 216	150	3
216 to 960	200	3
Above 960	500	3

- **Results:**

All spurious emissions were measured and found to be in compliance with the limits specified in 15.209(a). Band edge emissions were also found to be in compliance with the limits specified in 15.209(a).



Retlif Testing Laboratories

Report No. R-6265N-1

Requirements and Test Results (con't)

FCC Section 15.247(e) – Power Spectral Density

For digitally modulated systems, the power spectral density conducted from the intentional radiator to the antenna shall not be greater than 8 dBm in any 3 kHz band during any time interval of continuous transmission. This power spectral density shall be determined in accordance with the provisions of paragraph (b) of this section. The same method of determining the conducted output power shall be used to determine the power spectral density.

- **Results:**

The power spectral density conducted from the intentional radiator to the antenna was not greater than 8 dBm in any 3 kHz band during any time interval of continuous transmission. This power spectral density was determined in accordance with Section 15.247(b)(3), herein.



Retlif Testing Laboratories

Report No. R-6265N-1

Requirements and Test Results (con't)

Field Strength Calculation/Conversion:

The maximized field strength of the emission was obtained as follows:

$$CR = MR + CF$$

Where:

CR = Corrected Reading in dB μ V/m

MR = Uncorrected Meter Reading in dB μ V

CF = Correction Factor in dB (Antenna Factor, Pre-amp + Cable Loss)

Example:

$$MR = 15.35 \text{ dB}\mu\text{V}$$

$$CF = 16.85 \text{ dB}$$

$$CR = 15.35 \text{ dB}\mu\text{V} + 16.85 = 32.2 \text{ dB}\mu\text{V/m}$$

dB μ V/M is converted to uV/M for comparison to the specified limit using the formula:

$$\text{invLog dB}\mu\text{V/M}/20$$

$$32.2 \text{ dB}\mu\text{V/m} = 40.74 \text{ uV/m}$$

RF Power Conversion:

Power readings in dBm may be converted to mW using the formula:

$$\text{InvLog dBm}/10$$

$$\text{Example: } 20\text{dBm} = 100\text{mW}$$



Retlif Testing Laboratories

Report No. R-6265N-1

FCC Section 15.247 (i)

RF Exposure Limits

Spread Spectrum Transmitters operating under 15.247 must be operated in a manner that ensures the public is not exposed to RF energy levels in excess of the commission's guidelines. Based on the transmitter power and maximum antenna gain (see calculation below) the minimum separation distance was calculated to determine the distance for acceptable MPE power density levels to meet both the Occupational/Controlled Exposure and the General Population/Uncontrolled Exposure requirements of FCC Part 1.1310. The calculation below uses the more stringent General Population MPE Limits.

$$S = \frac{PG}{4\pi D^2}$$

D = Minimum Separation Distance in cm

S = Max allowed Power Density in mW/cm²

Per 1.1310 For the Frequency of 2400 MHz S = 1 mW/cm²

Power = Max Power Input to Antenna = 16.79 mW

Gain = Max Power Gain of Antenna = 1.5 dBi = 1.41 numeric

$$1.0 \text{ mW/cm}^2 = \frac{16.79 \times 1.41}{4 \times (3.14) \times D^2} = \frac{23.71}{12.56 \times D^2}$$

$$D^2 = \frac{23.71}{12.56 \times 1.0}$$

$$D = \sqrt{1.88} = 1.37 \text{ cm}$$



Retlif Testing Laboratories

Report No. R-6265N-1

Equipment List

FCC Section 15.247(a)(2) Occupied Bandwidth

EN	Manufacturer	Description	Range	Model No.	Cal Date	Due Date
5134	NARDA MICROWAVE	ATTENUATOR, COAXIAL	10 dB, DC - 12.4 GHz	757C-10	12/2/2016	12/31/2017
5231	AGILENT / HP	ANALYZER, SPECTRUM	3 Hz - 26.5 GHz	E4440A	5/24/2017	5/31/2018

FCC Section 15.247 (d) Band Edge Conducted Emissions

EN	Manufacturer	Description	Range	Model No.	Cal Date	Due Date
5134	NARDA MICROWAVE	ATTENUATOR, COAXIAL	10 dB, DC - 12.4 GHz	757C-10	12/2/2016	12/31/2017
5231	AGILENT / HP	ANALYZER, SPECTRUM	3 Hz - 26.5 GHz	E4440A	5/24/2017	5/31/2018

FCC Section 15.247(b)(3) Power Output

EN	Manufacturer	Description	Range	Model No.	Cal Date	Due Date
5134	NARDA MICROWAVE	ATTENUATOR, COAXIAL	10 dB, DC - 12.4 GHz	757C-10	12/2/2016	12/31/2017
5231	AGILENT / HP	ANALYZER, SPECTRUM	3 Hz - 26.5 GHz	E4440A	5/24/2017	5/31/2018

FCC Section 15.247 (d) Out of Band/Band Edge Radiated Emissions

EN	Manufacturer	Description	Range	Model No.	Cal Date	Due Date
1232	AGILENT / HP	PRE-AMPLIFIER	1 - 26.5 GHz	8449B	5/23/2017	5/31/2018
3258	ETS / EMCO	ANTENNA, DOUBLE RIDGED GUIDE	1 - 18 GHz	3115	10/13/2016	4/30/2018
3427B	ETS / EMCO	ANTENNA, BICONICAL	20 - 200 MHz	3104	9/21/2017	3/31/2019
3430	MCS	ANTENNA, HORN	18 - 26.5 GHz	K-5039	No Calibration Required	
4029B	RETLIF	OPEN AREA TEST SITE, ATTENUATION	3 / 10 Meters	RNH	4/13/2016	4/30/2018
443	ELECTRO-METRICS	ANTENNA, LOG PERIODIC	200 MHz - 1000 MHz	LPA-25	10/6/2016	4/30/2018
5070	ROHDE & SCHWARZ	RECEIVER, EMI	20 Hz - 40 GHz	ESIB40	10/21/2016	10/31/2017
5188	Cybertron	COMPUTER, CONTROL	N/A	TSVQJA2221	No Calibration Required	



Retlif Testing Laboratories

Report No. R-6265N-1

Equipment List_(continued)

FCC Section 15.247(e) Power Density

EN	Manufacturer	Description	Range	Model No.	Cal Date	Due Date
5134	NARDA MICROWAVE	ATTENUATOR, COAXIAL	10 dB, DC - 12.4 GHz	757C-10	12/2/2016	12/31/2017
5231	AGILENT / HP	ANALYZER, SPECTRUM	3 Hz - 26.5 GHz	E4440A	5/24/2017	5/31/2018



Retlif Testing Laboratories

Report No. R-6265N-1

Test Photographs Occupied Bandwidth



Test Setup



Retlif Testing Laboratories

Report No. R-6265N-1

**FCC Section 15.247(a)(2)
Occupied Bandwidth
Test Data**



Retlif Testing Laboratories

Report No. R-6265N-1

EMISSIONS TEST DATA SHEET

Method:	Occupied Bandwidth
Test Specification:	FCC Part 15, Subpart C Paragraph: 15.247 (a)(2)
Job Number:	R-6265N-1
Customer:	Lord Corporation
Test Sample:	Ruggedized Wireless Structural Health Monitoring Node
Model Number:	SHM-Link-201
Serial Number:	6329-0150-00001
Operating Mode:	Transmitting modulated (LXRS) signal at 2.405GHz
Technician:	M.Seamans
Date(s):	October 18 th , 2017
Temp/ Relative Humidity:	20.7 °C / 39.1 %
Notes:	6dB Bandwidth: 1.675 MHz

Agilent 16:45:32 Oct 4, 2037

Δ Mkr1 1.675 MHz
-0.38 dB

Ref 20 dBm

Atten 20 dB

#Peak

Log

10

dB/

Offst

10

dB

DI

2.5

dBm

LgAv

V1 S2

S3 FC

AA

Ê (f):

f > 50k

Swp

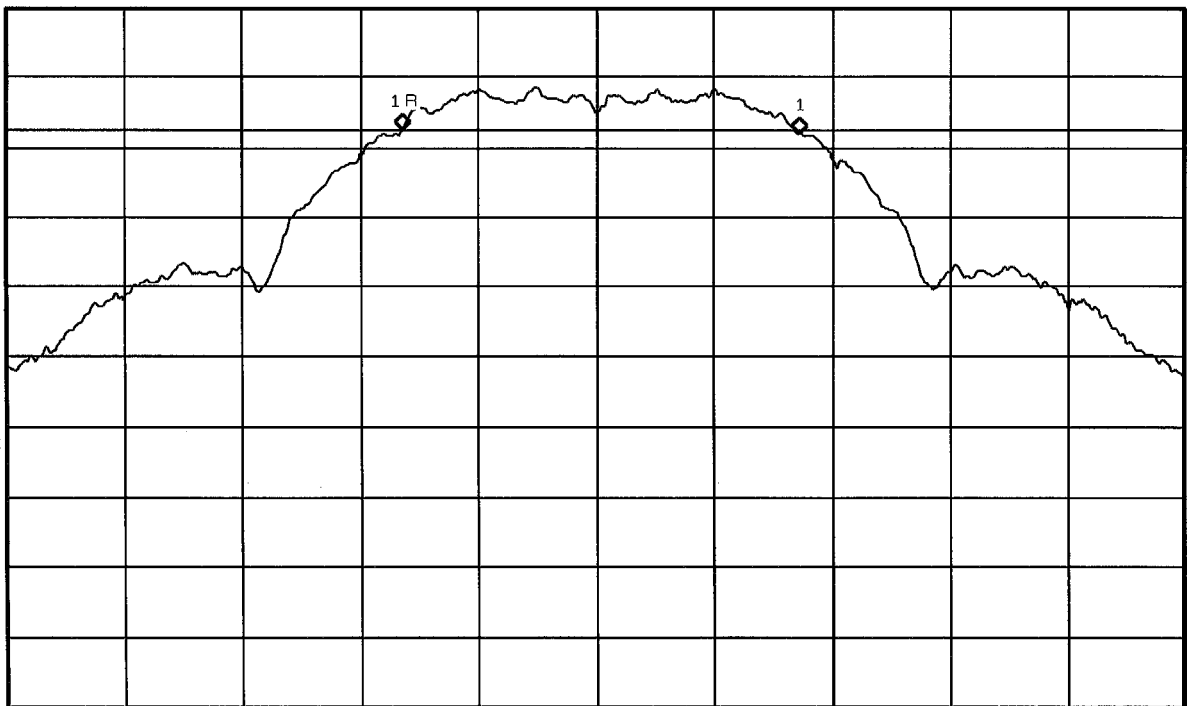

Center 2.405 000 GHz

Span 5 MHz

#Res BW 100 kHz

#VBW 300 kHz

Sweep 1 ms (601 pts)



Retlif Testing Laboratories

Report No. R-6265N-1

EMISSIONS TEST DATA SHEET

Method:	Occupied Bandwidth
Test Specification:	FCC Part 15, Subpart C Paragraph: 15.247 (a)(2)
Job Number:	R-6265N-1
Customer:	Lord Corporation
Test Sample:	Ruggedized Wireless Structural Health Monitoring Node
Model Number:	SHM-Link-201
Serial Number:	6329-0150-00001
Operating Mode:	Transmitting modulated (LXRS) signal at 2.440GHz
Technician:	M.Seamans
Date(s):	October 18 th , 2017
Temp/ Relative Humidity:	20.7 °C / 39.1 %
Notes:	6dB Bandwidth: 1.675 MHz

Agilent 16:36:45 Oct 4, 2037

Δ Mkr1 1.675 MHz
-0.01 dB

Ref 20 dBm

Atten 20 dB



Center 2.440 000 GHz

Span 5 MHz

#Res BW 100 kHz

#VBW 300 kHz

Sweep 1 ms (601 pts)



Retlif Testing Laboratories

Report No. R-6265N-1

EMISSIONS TEST DATA SHEET

Method:	Occupied Bandwidth
Test Specification:	FCC Part 15, Subpart C Paragraph: 15.247 (a)(2)
Job Number:	R-6265N-1
Customer:	Lord Corporation
Test Sample:	Ruggedized Wireless Structural Health Monitoring Node
Model Number:	SHM-Link-201
Serial Number:	6329-0150-00001
Operating Mode:	Transmitting modulated (LXRS) signal at 2.480GHz
Technician:	M.Seamans
Date(s):	October 18 th , 2017
Temp/ Relative Humidity:	20.7 °C / 39.1 %
Notes:	6dB Bandwidth: 1.675 MHz

Agilent 16:47:47 Oct 4, 2037

Δ Mkr1 1.675 MHz
-0.34 dB

Ref 20 dBm

Atten 20 dB

#Peak

Log

10

dB/

Offst

10

dB

DI

1.6

dBm

LgAv

V1 S2

S3 FC

AA

Ê(f):

f>50k

Swp

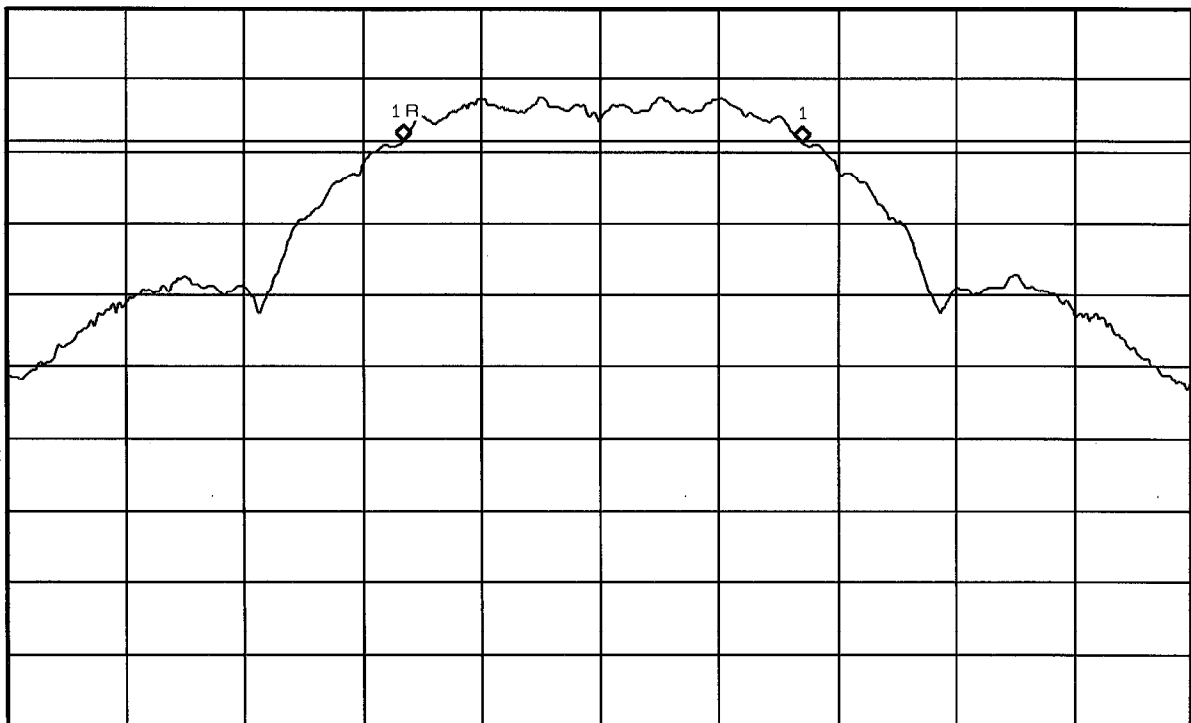

Center 2.480 000 GHz

Span 5 MHz

#Res BW 100 kHz

#VBW 300 kHz

Sweep 1 ms (601 pts)



Retlif Testing Laboratories

Report No. R-6265N-1

EMISSIONS TEST DATA SHEET

Method:	Occupied Bandwidth
Test Specification:	FCC Part 15, Subpart C Paragraph: 15.247 (a)(2)
Job Number:	R-6265N-1
Customer:	Lord Corporation
Test Sample:	Ruggedized Wireless Structural Health Monitoring Node
Model Number:	SHM-Link-201
Serial Number:	6329-0150-00001
Operating Mode:	Transmitting modulated (LXRS+) signal at 2.405GHz
Technician:	M.Seamans
Date(s):	October 18 th , 2017
Temp/ Relative Humidity:	20.7 °C / 39.1 %
Notes:	6dB Bandwidth: 2.242 MHz

Agilent 16:43:29 Oct 4, 2037

Δ Mkr1 2.242 MHz
-0.02 dB

Ref 20 dBm

Atten 20 dB

#Peak
Log
10
dB/
Offst
10
dB
DI
4.9
dBm
LgAv
V1 S2
S3 FC
AA
Ê(f):
f>50k
Swp

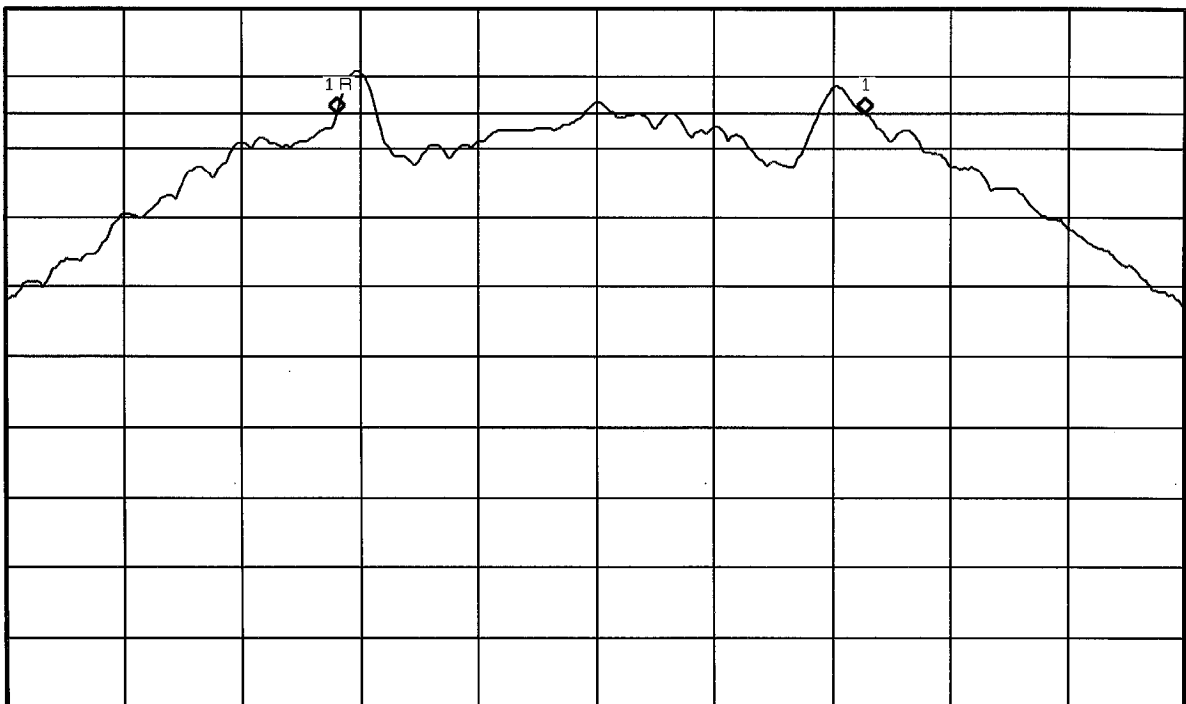

Center 2.405 000 GHz

Span 5 MHz

#Res BW 100 kHz

#VBW 300 kHz

Sweep 1 ms (601 pts)



Retlif Testing Laboratories

Report No. R-6265N-1

EMISSIONS TEST DATA SHEET

Method:	Occupied Bandwidth
Test Specification:	FCC Part 15, Subpart C Paragraph: 15.247 (a)(2)
Job Number:	R-6265N-1
Customer:	Lord Corporation
Test Sample:	Ruggedized Wireless Structural Health Monitoring Node
Model Number:	SHM-Link-201
Serial Number:	6329-0150-00001
Operating Mode:	Transmitting modulated (LXRS+) signal at 2.440GHz
Technician:	M.Seamans
Date(s):	October 18 th , 2017
Temp/ Relative Humidity:	20.7 °C / 39.1 %
Notes:	6dB Bandwidth: 2.242 MHz

Agilent 16:39:26 Oct 4, 2037

Δ Mkr1 2.242 MHz
-0.02 dB

Ref 20 dBm

Atten 20 dB

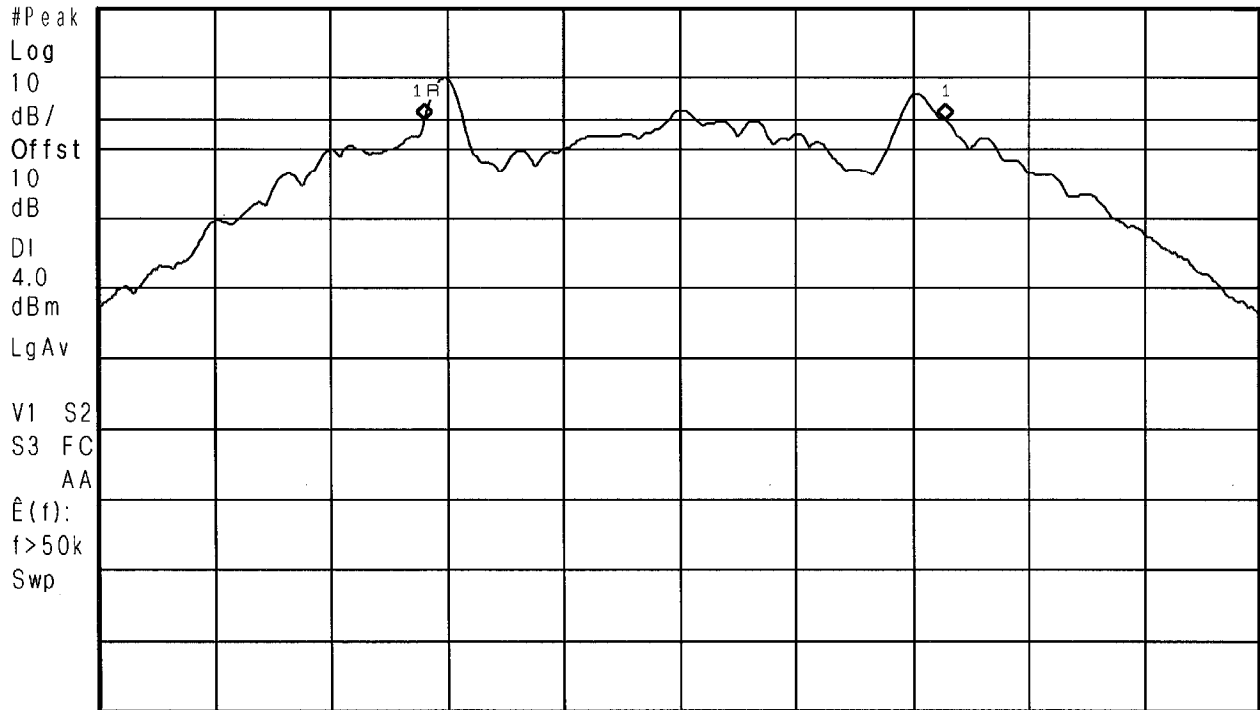

Center 2.440 000 GHz

Span 5 MHz

#Res BW 100 kHz

#VBW 300 kHz

Sweep 1 ms (601 pts)



Retlif Testing Laboratories

Report No. R-6265N-1

EMISSIONS TEST DATA SHEET

Method:	Occupied Bandwidth
Test Specification:	FCC Part 15, Subpart C Paragraph: 15.247 (a)(2)
Job Number:	R-6265N-1
Customer:	Lord Corporation
Test Sample:	Ruggedized Wireless Structural Health Monitoring Node
Model Number:	SHM-Link-201
Serial Number:	6329-0150-00001
Operating Mode:	Transmitting modulated (LXRS+) signal at 2.480GHz
Technician:	M.Seamans
Date(s):	October 18 th , 2017
Temp/ Relative Humidity:	20.7 °C / 39.1 %
Notes:	6dB Bandwidth: 2.242 MHz

Agilent 16:51:33 Oct 4, 2037

Δ Mkr1 2.242 MHz
-0.18 dB

Ref 20 dBm

Atten 20 dB

#Peak

Log

10

dB/

Offst

10

dB

DI

3.3

dBm

LgAv

V1 S2

S3 FC

AA

Ê (f):

f > 50k

Swp

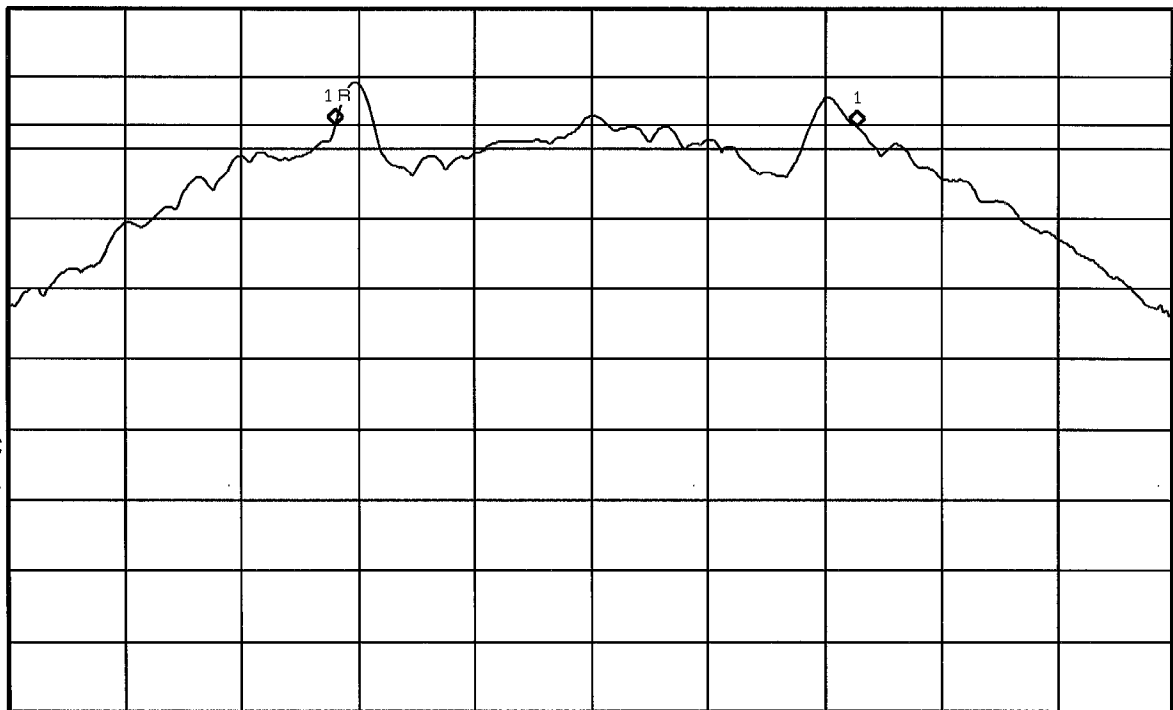

Center 2.480 000 GHz

Span 5 MHz

#Res BW 100 kHz

#VBW 300 kHz

Sweep 1 ms (601 pts)



Retlif Testing Laboratories

Report No. R-6265N-1

Test Photographs Power Output



Test Setup



Retlif Testing Laboratories

Report No. R-6265N-1

**FCC Section 15.247 (b)(3)
Power Output
Test Data**



Retlif Testing Laboratories

Report No. R-6265N-1

EMISSIONS TEST DATA SHEET

Method:	Power Output
Test Specification:	FCC Part 15, Subpart C Paragraph: 15.247 (b)(3)
Job Number:	R-6265N-1
Customer:	Lord Corporation
Test Sample:	Ruggedized Wireless Structural Health Monitoring Node
Model Number:	SHM-Link-201
Serial Number:	6329-0150-00001
Operating Mode:	Transmitting modulated (LXRS) signal at 2.405GHz
Technician:	M.Seamans
Date(s):	October 18 th , 2017
Temp/ Relative Humidity:	20.7 °C / 39.1 %
Notes:	Power Output: 12.14 dBm

Agilent 17:06:00 Oct 4, 2037

Mkr1 2.404 483 GHz
12.14 dBm

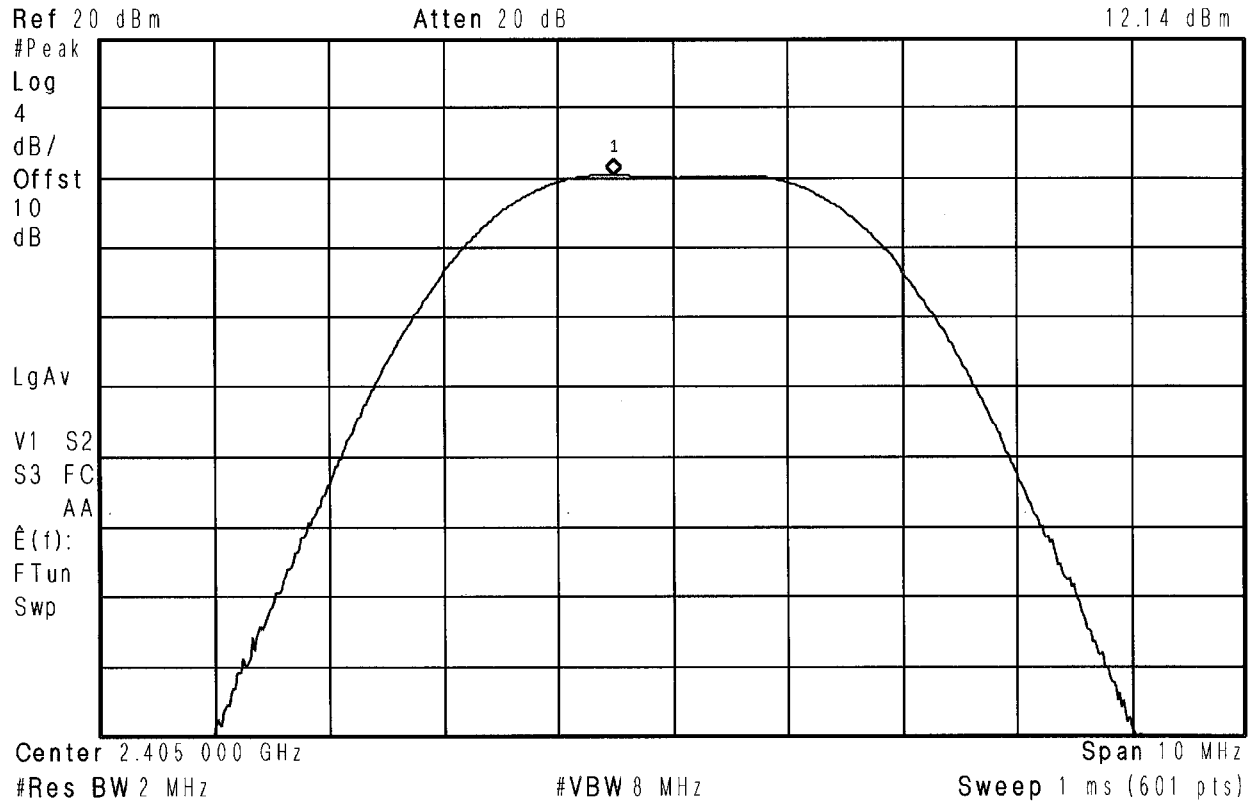

Retlif Testing Laboratories

Report No. R-6265N-1

EMISSIONS TEST DATA SHEET

Method:	Peak Power Output
Test Specification:	FCC Part 15, Subpart C Paragraph: 15.247 (b)(3)
Job Number:	R-6265N-1
Customer:	Lord Corporation
Test Sample:	Ruggedized Wireless Structural Health Monitoring Node
Model Number:	SHM-Link-201
Serial Number:	6329-0150-00001
Operating Mode:	Transmitting modulated (LXRS) signal at 2.440GHz
Technician:	M.Seamans
Date(s):	October 18 th , 2017
Temp/ Relative Humidity:	20.7 °C / 39.1 %
Notes:	Power Output: 11.66 dBm

Agilent 17:04:48 Oct 4, 2037

Mkr1 2.439 450 GHz

Ref 20 dBm

Atten 20 dB

11.66 dBm

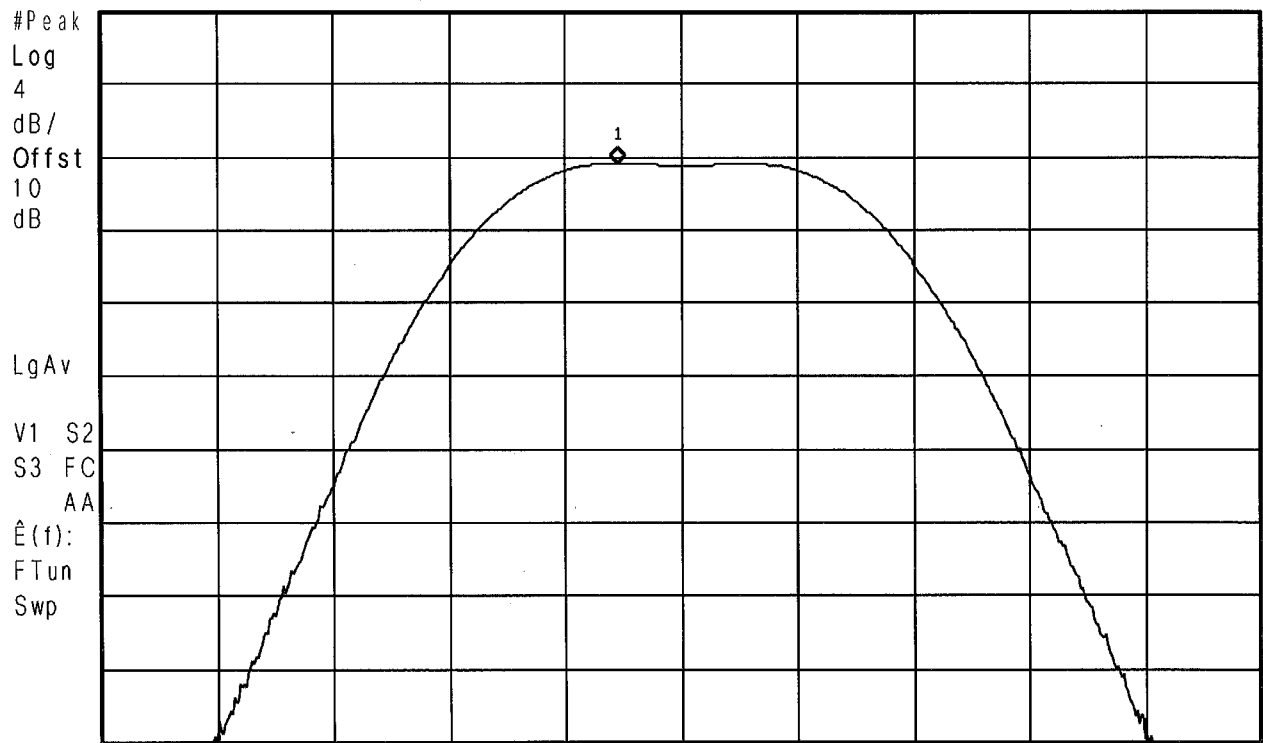

Center 2.440 000 GHz

Span 10 MHz

#Res BW 2 MHz

#VBW 8 MHz

Sweep 1 ms (601 pts)



Retlif Testing Laboratories

Report No. R-6265N-1

EMISSIONS TEST DATA SHEET

Method:	Peak Power Output
Test Specification:	FCC Part 15, Subpart C Paragraph: 15.247 (b)(3)
Job Number:	R-6265N-1
Customer:	Lord Corporation
Test Sample:	Ruggedized Wireless Structural Health Monitoring Node
Model Number:	SHM-Link-201
Serial Number:	6329-0150-00001
Operating Mode:	Transmitting modulated (LXRS) signal at 2.480GHz
Technician:	M.Seamans
Date(s):	October 18 th , 2017
Temp/ Relative Humidity:	20.7 °C / 39.1 %
Notes:	Power Output: 11.23 dBm

Agilent 17:07:16 Oct 4, 2037

Mkr1 2.479 433 GHz

Ref 20 dBm

Atten 20 dB

11.23 dBm

#Peak
Log
4
dB/
Offst
10
dB

LgAv

V1 S2
S3 FC
AA

Ê(f):
FTun
Swp

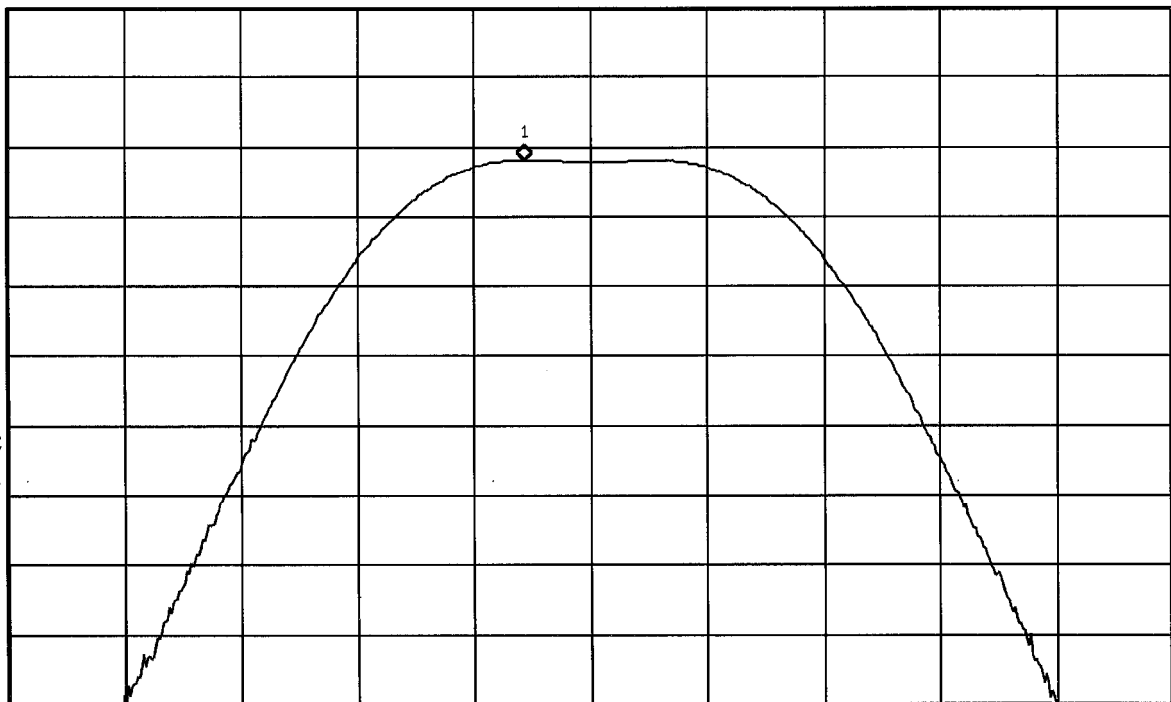

Center 2.480 000 GHz

Span 10 MHz

#Res BW 2 MHz

#VBW 8 MHz

Sweep 1 ms (601 pts)



Retlif Testing Laboratories

Report No. R-6265N-1

EMISSIONS TEST DATA SHEET

Method:	Power Output
Test Specification:	FCC Part 15, Subpart C Paragraph: 15.247 (b)(3)
Job Number:	R-6265N-1
Customer:	Lord Corporation
Test Sample:	Ruggedized Wireless Structural Health Monitoring Node
Model Number:	SHM-Link-201
Serial Number:	6329-0150-00001
Operating Mode:	Transmitting modulated (LXRS+) signal at 2.405GHz
Technician:	M.Seamans
Date(s):	October 18 th , 2017
Temp/ Relative Humidity:	20.7 °C / 39.1 %
Notes:	Power Output: 12.25 dBm

Agilent 17:01:36 Oct 4, 2037

Mkr1 2.404 250 GHz
12.25 dBm

Ref 20 dBm

Atten 20 dB

#Peak
Log
4
dB/
Offst
10
dB

LgAv

V1 S2
S3 FC
AA
Ê (f):
FTun
Swp

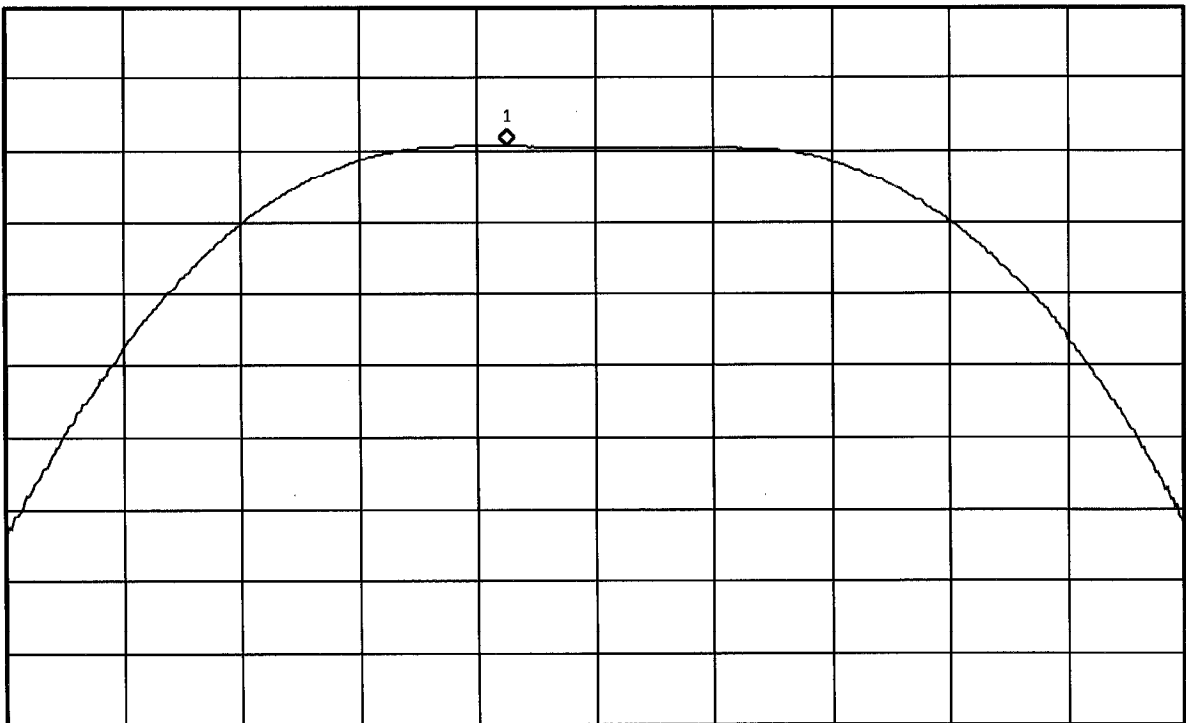

Center 2.405 000 GHz

Span 10 MHz

#Res BW 3 MHz

#VBW 8 MHz

Sweep 1 ms (601 pts)



Retlif Testing Laboratories

Report No. R-6265N-1

EMISSIONS TEST DATA SHEET

Method:	Peak Power Output
Test Specification:	FCC Part 15, Subpart C Paragraph: 15.247 (b)(3)
Job Number:	R-6265N-1
Customer:	Lord Corporation
Test Sample:	Ruggedized Wireless Structural Health Monitoring Node
Model Number:	SHM-Link-201
Serial Number:	6329-0150-00001
Operating Mode:	Transmitting modulated (LXRS+) signal at 2.440GHz
Technician:	M.Seamans
Date(s):	October 18 th , 2017
Temp/ Relative Humidity:	20.7 °C / 39.1 %
Notes:	Power Output: 11.77 dBm

Agilent 17:00:29 Oct 4, 2037

Mkr1 2.439 000 GHz
11.77 dBm

Ref 20 dBm

Atten 20 dB

#Peak
Log
4
dB/
Offst
10
dB

LgAv

V1 S2
S3 FC
AA
Ê(f):
FTun
Swp

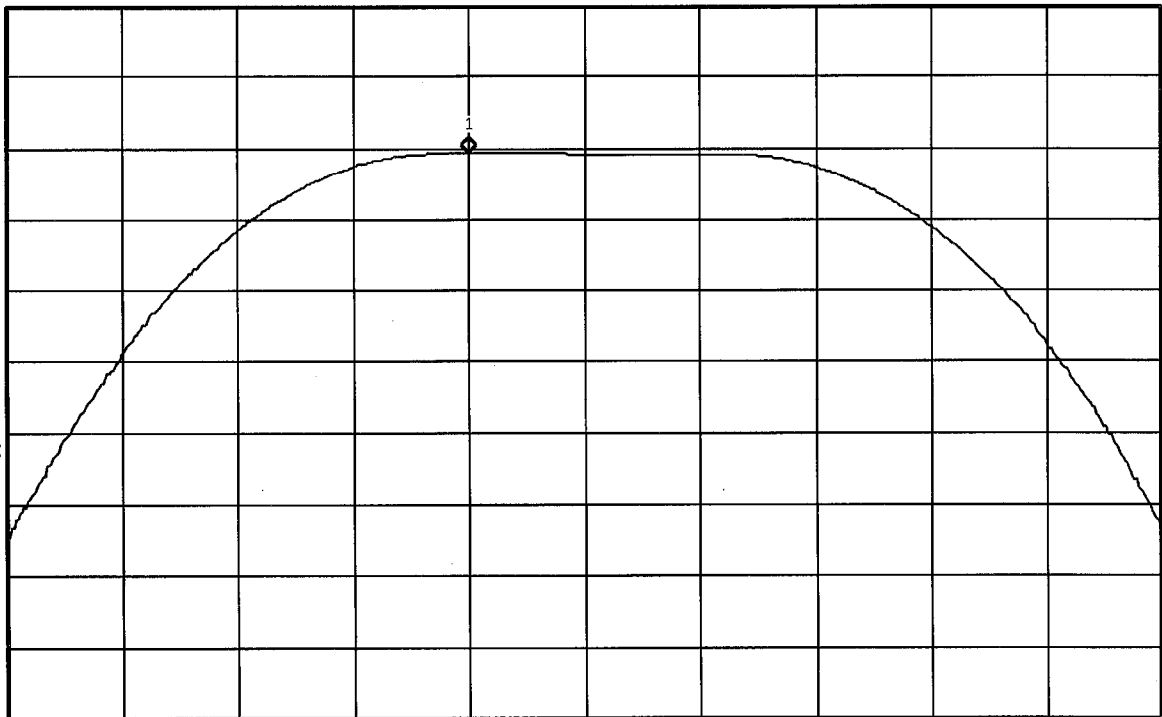

Center 2.440 000 GHz

Span 10 MHz

#Res BW 3 MHz

#VBW 8 MHz

Sweep 1 ms (601 pts)



Retlif Testing Laboratories

Report No. R-6265N-1

EMISSIONS TEST DATA SHEET

Method:	Peak Power Output
Test Specification:	FCC Part 15, Subpart C Paragraph: 15.247 (b)(3)
Job Number:	R-6265N-1
Customer:	Lord Corporation
Test Sample:	Ruggedized Wireless Structural Health Monitoring Node
Model Number:	SHM-Link-201
Serial Number:	6329-0150-00001
Operating Mode:	Transmitting modulated (LXRS+) signal at 2.480GHz
Technician:	M.Seamans
Date(s):	October 18 th , 2017
Temp/ Relative Humidity:	20.7 °C / 39.1 %
Notes:	Power Output: 11.35 dBm

Agilent 16:58:50 Oct 4, 2037

Mkr1 2.479 033 GHz

11.35 dBm

Ref 20 dBm

Atten 20 dB

#Peak
Log
4
dB/
Offst
10
dB

LgAv

V1 S2
S3 FC
AA

$\hat{E}(f)$:
FTun
Swp

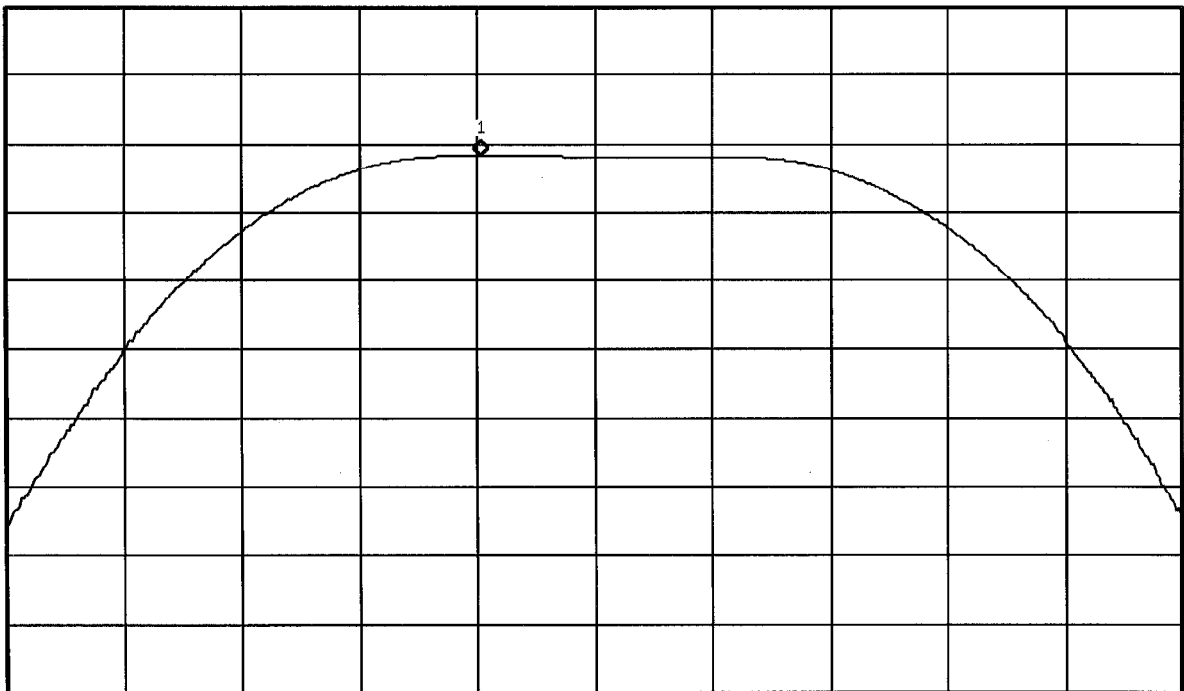

Center 2.480 000 GHz

Span 10 MHz

#Res BW 3 MHz

#VBW 8 MHz

Sweep 1 ms (601 pts)



Retlif Testing Laboratories

Report No. R-6265N-1

Test Photographs
Antenna Terminal Out of Band/Band Edge Conducted Emissions



Test Setup



Retlif Testing Laboratories

Report No. R-6265N-1

**FCC Section 15.247 (d)
Antenna Terminal Out of Band/Band Edge Conducted Emissions
Test Data**



Retlif Testing Laboratories

Report No. R-6265N-1

**Out of Band Conducted Emissions
Test Data**



Retlif Testing Laboratories

Report No. R-6265N-1

EMISSIONS TEST DATA SHEET

Method:	Conducted Out of Band
Test Specification:	FCC Part 15, Subpart C Paragraph: 15.247 (d)
Job Number:	R-6265N-1
Customer:	Lord Corporation
Test Sample:	Ruggedized Wireless Structural Health Monitoring Node
Model Number:	SHM-Link-201
Serial Number:	6329-0150-00001
Operating Mode:	Transmitting modulated (LXRS) signal at 2.405GHz
Technician:	M.Seamans
Date(s):	October 18 th , 2017
Temp/ Relative Humidity:	20.7 °C / 39.1 %
Notes:	Limit: -7.8 dBm

Agilent 17:48:02 Oct 4, 2037

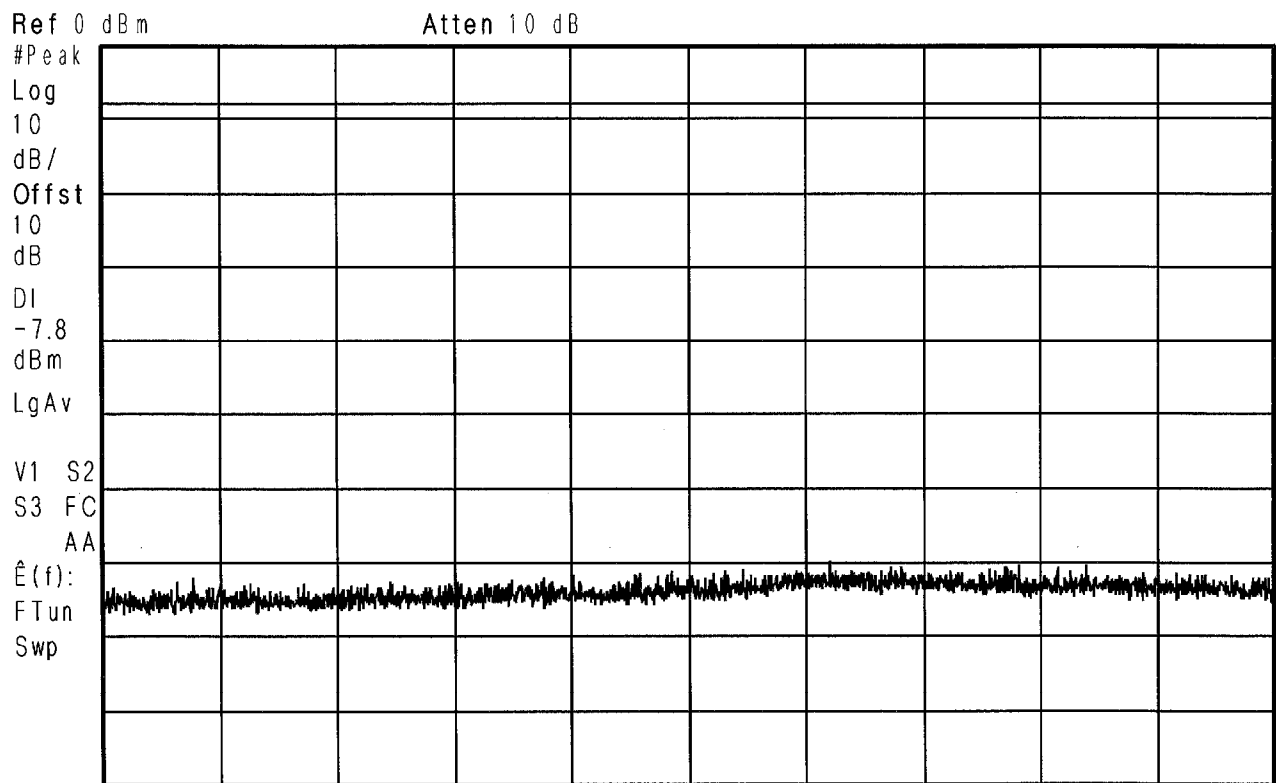

Start 25.0 MHz

Stop 1.000 0 GHz

#Res BW 100 kHz

#VBW 300 kHz

Sweep 93.3 ms (2500 pts)



Retlif Testing Laboratories

Report No. R-6265N-1

EMISSIONS TEST DATA SHEET

Method:	Conducted Out of Band
Test Specification:	FCC Part 15, Subpart C Paragraph: 15.247 (d)
Job Number:	R-6265N-1
Customer:	Lord Corporation
Test Sample:	Ruggedized Wireless Structural Health Monitoring Node
Model Number:	SHM-Link-201
Serial Number:	6329-0150-00001
Operating Mode:	Transmitting modulated (LXRS) signal at 2.440GHz
Technician:	M.Seamans
Date(s):	October 18 th , 2017
Temp/ Relative Humidity:	20.7 °C / 39.1 %
Notes:	Limit: -7.8 dBm

Agilent 17:49:50 Oct 4, 2037

Mkr1 478.8 MHz
-60.37 dBm

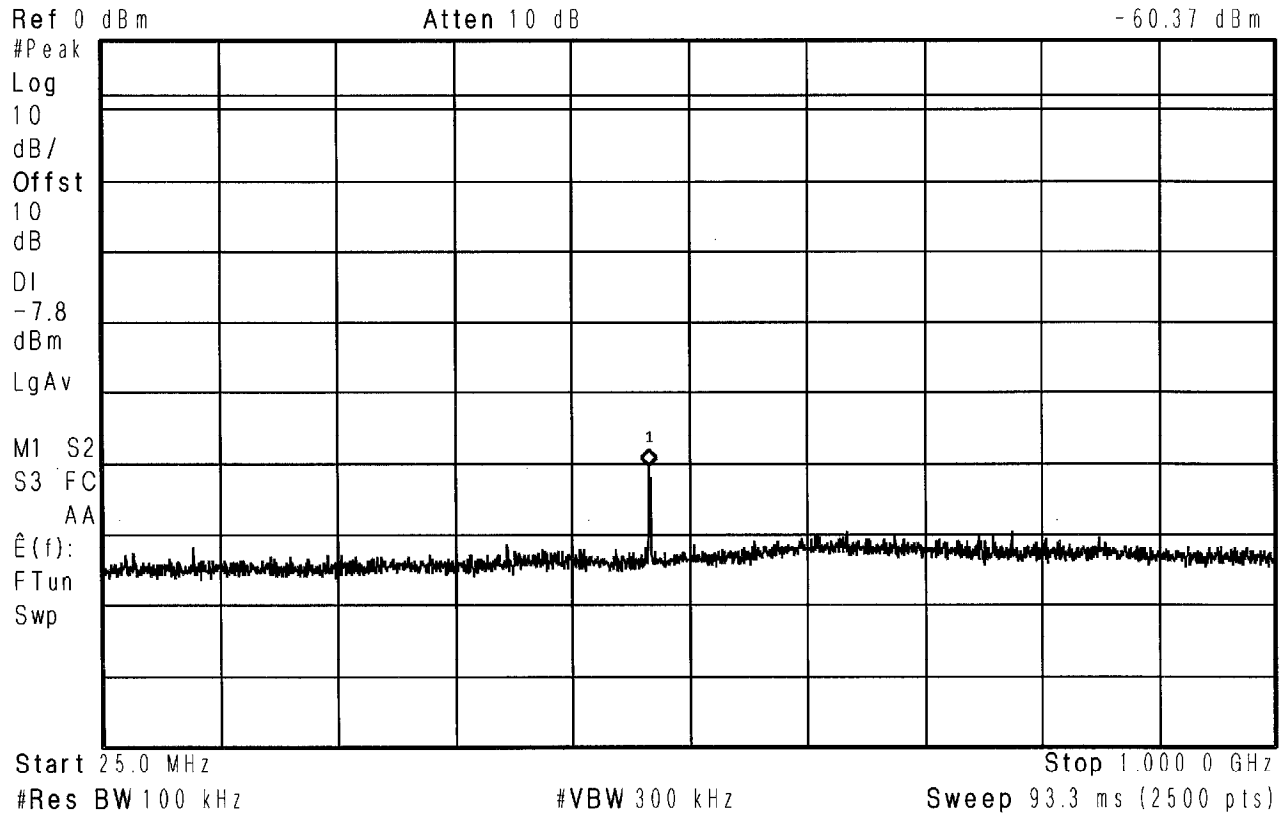

Retlif Testing Laboratories

Report No. R-6265N-1

EMISSIONS TEST DATA SHEET

Method:	Conducted Out of Band
Test Specification:	FCC Part 15, Subpart C Paragraph: 15.247 (d)
Job Number:	R-6265N-1
Customer:	Lord Corporation
Test Sample:	Ruggedized Wireless Structural Health Monitoring Node
Model Number:	SHM-Link-201
Serial Number:	6329-0150-00001
Operating Mode:	Transmitting modulated (LXRS) signal at 2.480GHz
Technician:	M.Seamans
Date(s):	October 18 th , 2017
Temp/ Relative Humidity:	20.7 °C / 39.1 %
Notes:	Limit: -7.8 dBm

Agilent 17:53:21 Oct 4, 2037

Mkr1 518.9 MHz

-62.49 dBm

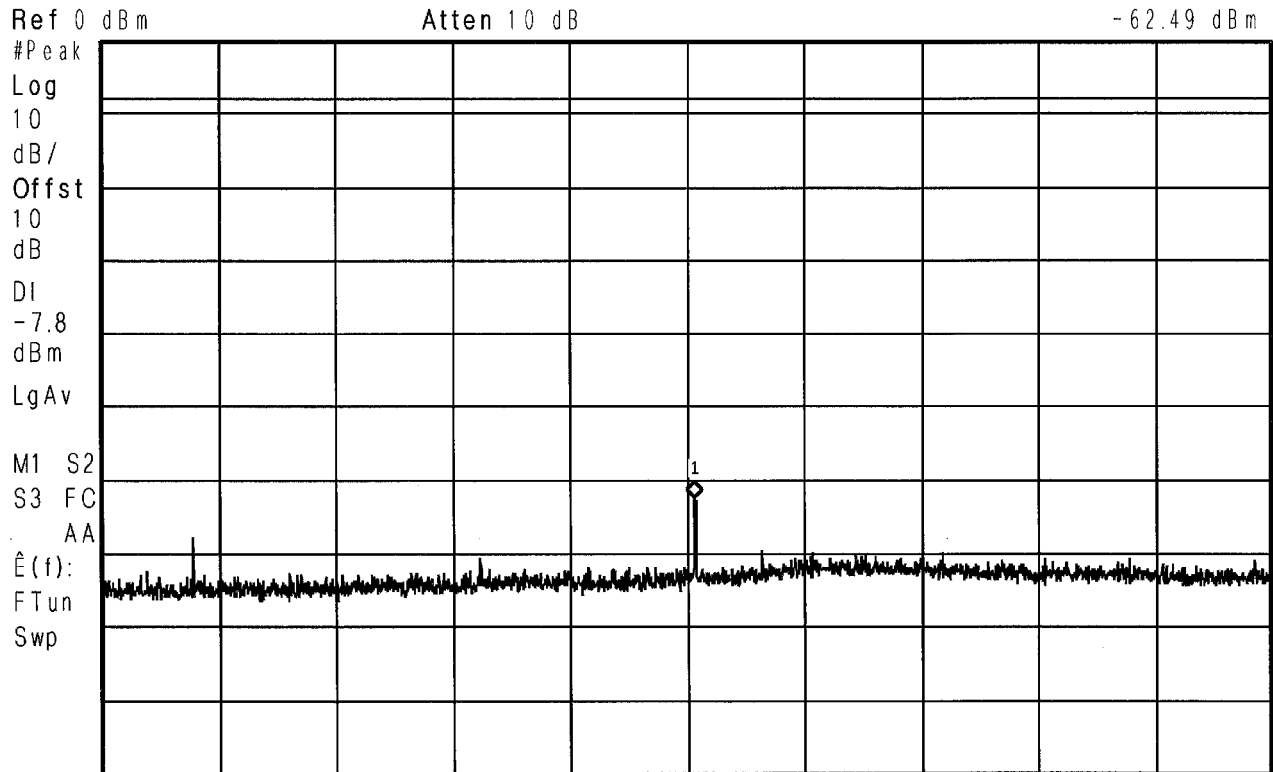

Start 25.0 MHz

Stop 1.000 0 GHz

#Res BW 100 kHz

#VBW 300 kHz

Sweep 93.3 ms (2500 pts)



Retlif Testing Laboratories

Report No. R-6265N-1

EMISSIONS TEST DATA SHEET

Method:	Conducted Out of Band
Test Specification:	FCC Part 15, Subpart C Paragraph: 15.247 (d)
Job Number:	R-6265N-1
Customer:	Lord Corporation
Test Sample:	Ruggedized Wireless Structural Health Monitoring Node
Model Number:	SHM-Link-201
Serial Number:	6329-0150-00001
Operating Mode:	Transmitting modulated (LXRS) signal at 2.480GHz
Technician:	M.Seamans
Date(s):	October 18 th , 2017
Temp/ Relative Humidity:	20.7 °C / 39.1 %
Notes:	Limit: -7.8 dBm

Agilent 17:52:56 Oct 4, 2017

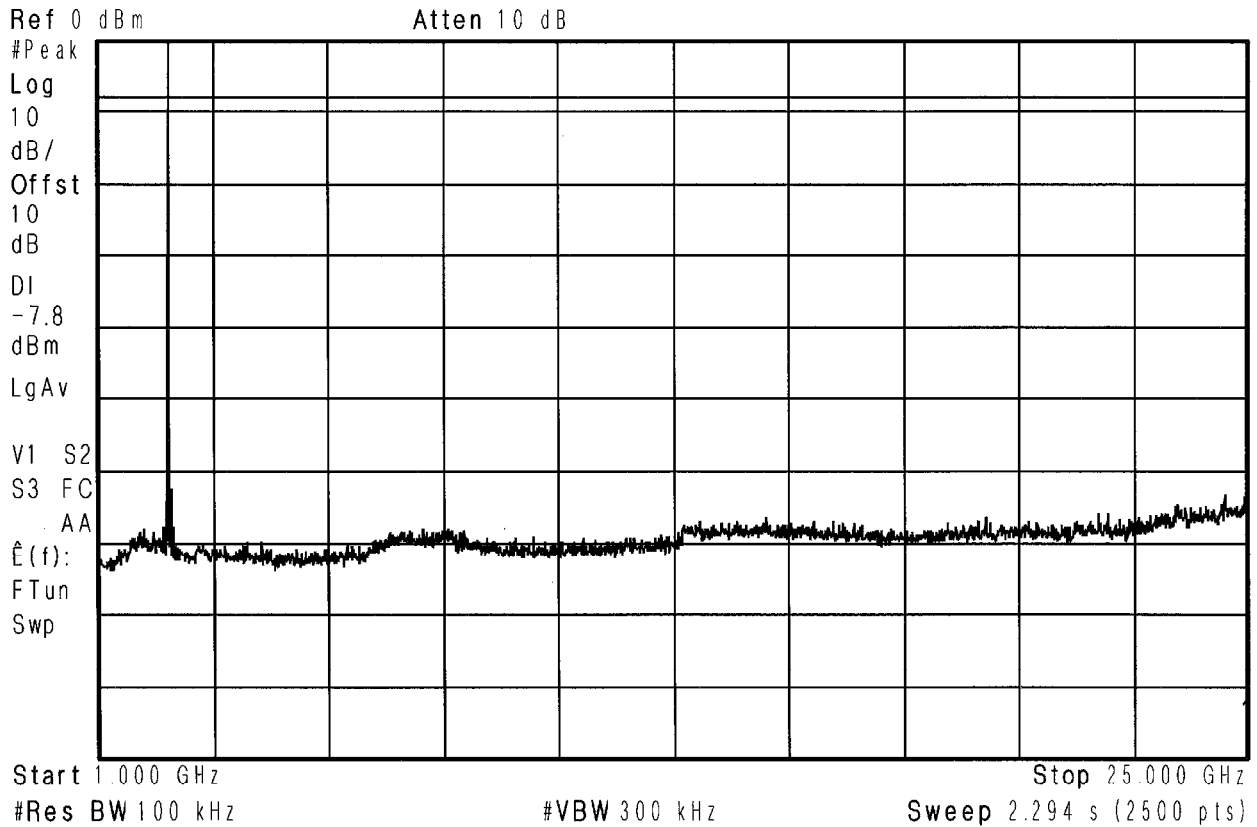

Retlif Testing Laboratories

Report No. R-6265N-1

EMISSIONS TEST DATA SHEET

Method:	Conducted Out of Band
Test Specification:	FCC Part 15, Subpart C Paragraph: 15.247 (d)
Job Number:	R-6265N-1
Customer:	Lord Corporation
Test Sample:	Ruggedized Wireless Structural Health Monitoring Node
Model Number:	SHM-Link-201
Serial Number:	6329-0150-00001
Operating Mode:	Transmitting modulated (LXRS+) signal at 2.405GHz
Technician:	M.Seamans
Date(s):	October 18 th , 2017
Temp/ Relative Humidity:	20.7 °C / 39.1 %
Notes:	Limit: -7.8 dBm

Agilent 17:45:08 Oct 4, 2037

Ref 0 dBm

Atten 10 dB

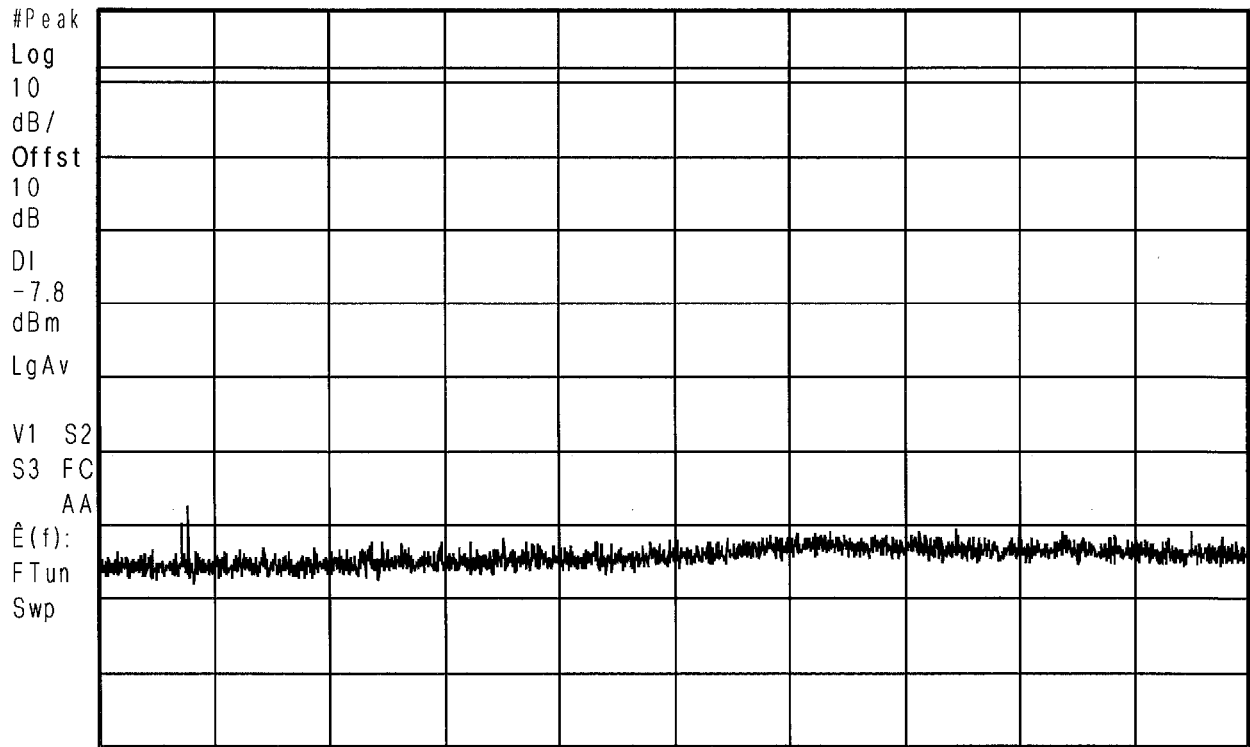

Start 25.0 MHz

Stop 1.000 0 GHz

#Res BW 100 kHz

#VBW 300 kHz

Sweep 93.3 ms (2500 pts)



Retlif Testing Laboratories

Report No. R-6265N-1

EMISSIONS TEST DATA SHEET

Method:	Conducted Out of Band
Test Specification:	FCC Part 15, Subpart C Paragraph: 15.247 (d)
Job Number:	R-6265N-1
Customer:	Lord Corporation
Test Sample:	Ruggedized Wireless Structural Health Monitoring Node
Model Number:	SHM-Link-201
Serial Number:	6329-0150-00001
Operating Mode:	Transmitting modulated (LXRS+) signal at 2.440GHz
Technician:	M.Seamans
Date(s):	October 18 th , 2017
Temp/ Relative Humidity:	20.7 °C / 39.1 %
Notes:	Limit: -7.8 dBm

Agilent 17:39:56 Oct 4, 2037

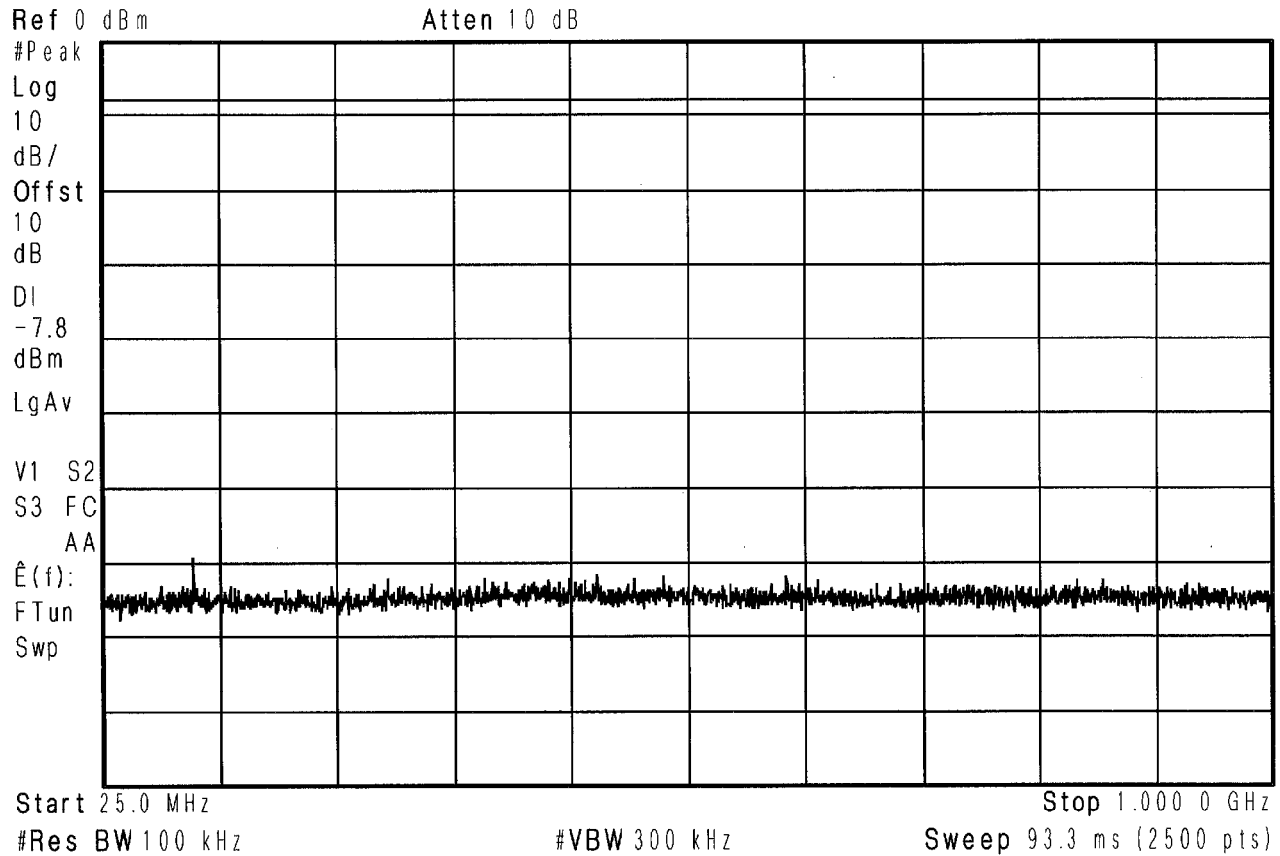

Retlif Testing Laboratories

Report No. R-6265N-1

EMISSIONS TEST DATA SHEET

Method:	Conducted Out of Band
Test Specification:	FCC Part 15, Subpart C Paragraph: 15.247 (d)
Job Number:	R-6265N-1
Customer:	Lord Corporation
Test Sample:	Ruggedized Wireless Structural Health Monitoring Node
Model Number:	SHM-Link-201
Serial Number:	6329-0150-00001
Operating Mode:	Transmitting modulated (LXRS+) signal at 2.480GHz
Technician:	M.Seamans
Date(s):	October 18 th , 2017
Temp/ Relative Humidity:	20.7 °C / 39.1 %
Notes:	Limit: -7.8 dBm

Agilent 17:31:28 Oct 4, 2037

Ref 0 dBm

Atten 10 dB

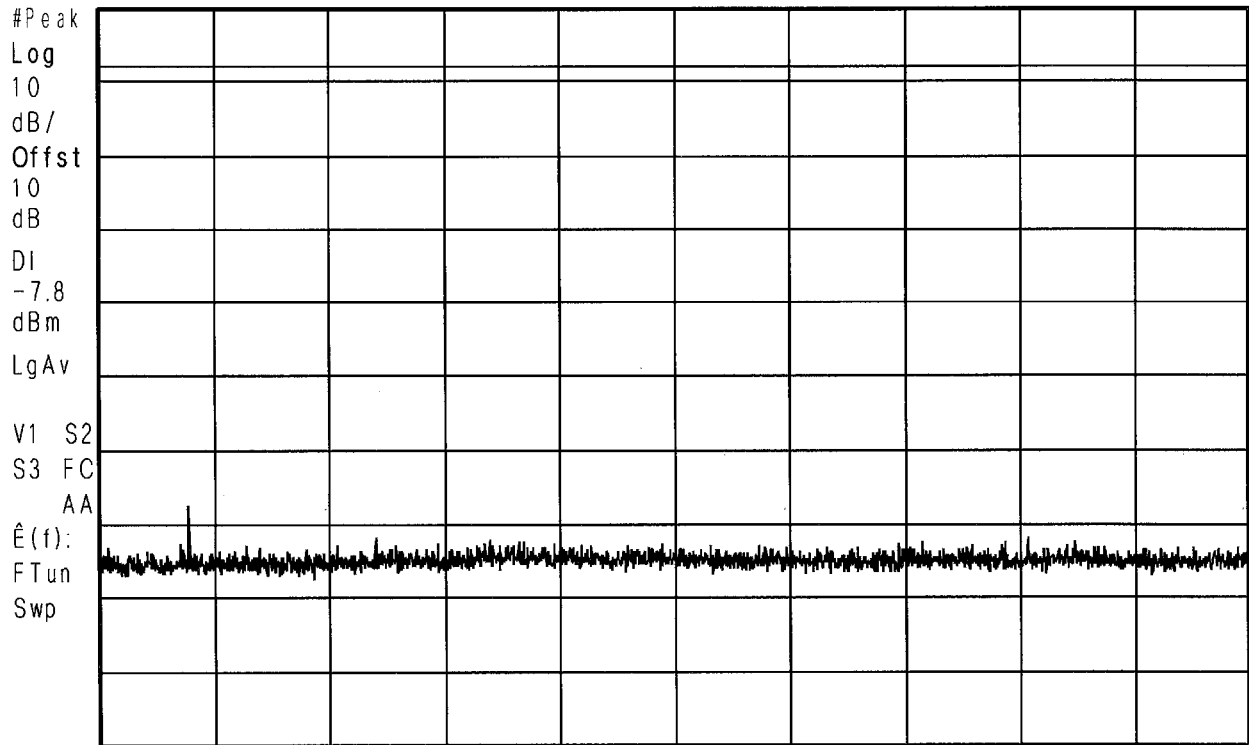

Start 25.0 MHz

Stop 1.000 0 GHz

#Res BW 100 kHz

#VBW 300 kHz

Sweep 93.3 ms (2500 pts)



Retlif Testing Laboratories

Report No. R-6265N-1

EMISSIONS TEST DATA SHEET

Method:	Conducted Out of Band
Test Specification:	FCC Part 15, Subpart C Paragraph: 15.247 (d)
Job Number:	R-6265N-1
Customer:	Lord Corporation
Test Sample:	Ruggedized Wireless Structural Health Monitoring Node
Model Number:	SHM-Link-201
Serial Number:	6329-0150-00001
Operating Mode:	Transmitting modulated (LXRS+) signal at 2.480GHz
Technician:	M.Seamans
Date(s):	October 18 th , 2017
Temp/ Relative Humidity:	20.7 °C / 39.1 %
Notes:	Limit: -7.8 dBm

Agilent 17:33:35 Oct 4, 2037

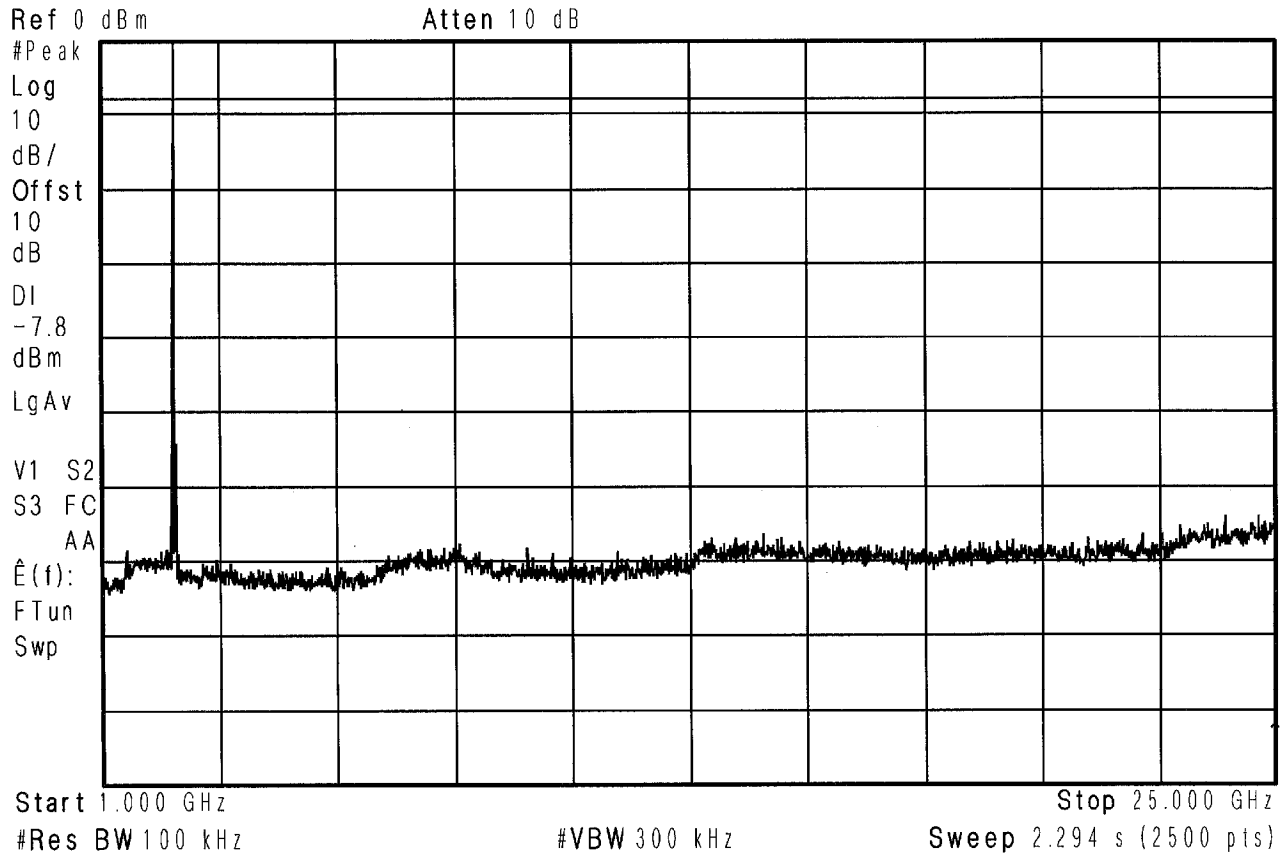

Retlif Testing Laboratories

Report No. R-6265N-1

**Band Edge Conducted
Test Data**



Retlif Testing Laboratories

Report No. R-6265N-1

EMISSIONS TEST DATA SHEET

Method:	Band Edge
Test Specification:	FCC Part 15, Subpart C Paragraph: 15.247 (d)
Job Number:	R-6265N-1
Customer:	Lord Corporation
Test Sample:	Ruggedized Wireless Structural Health Monitoring Node
Model Number:	SHM-Link-201
Serial Number:	6329-0150-00001
Operating Mode:	Transmitting modulated (LXRS) signal at 2.405GHz
Technician:	M.Seamans
Date(s):	October 18 th , 2017
Temp/ Relative Humidity:	20.7 °C / 39.1 %
Notes:	Limit: -7.8 dBm

Agilent 18:02:23 Oct 4, 2037

Mkr1 2.399 778 GHz
-44.21 dBm

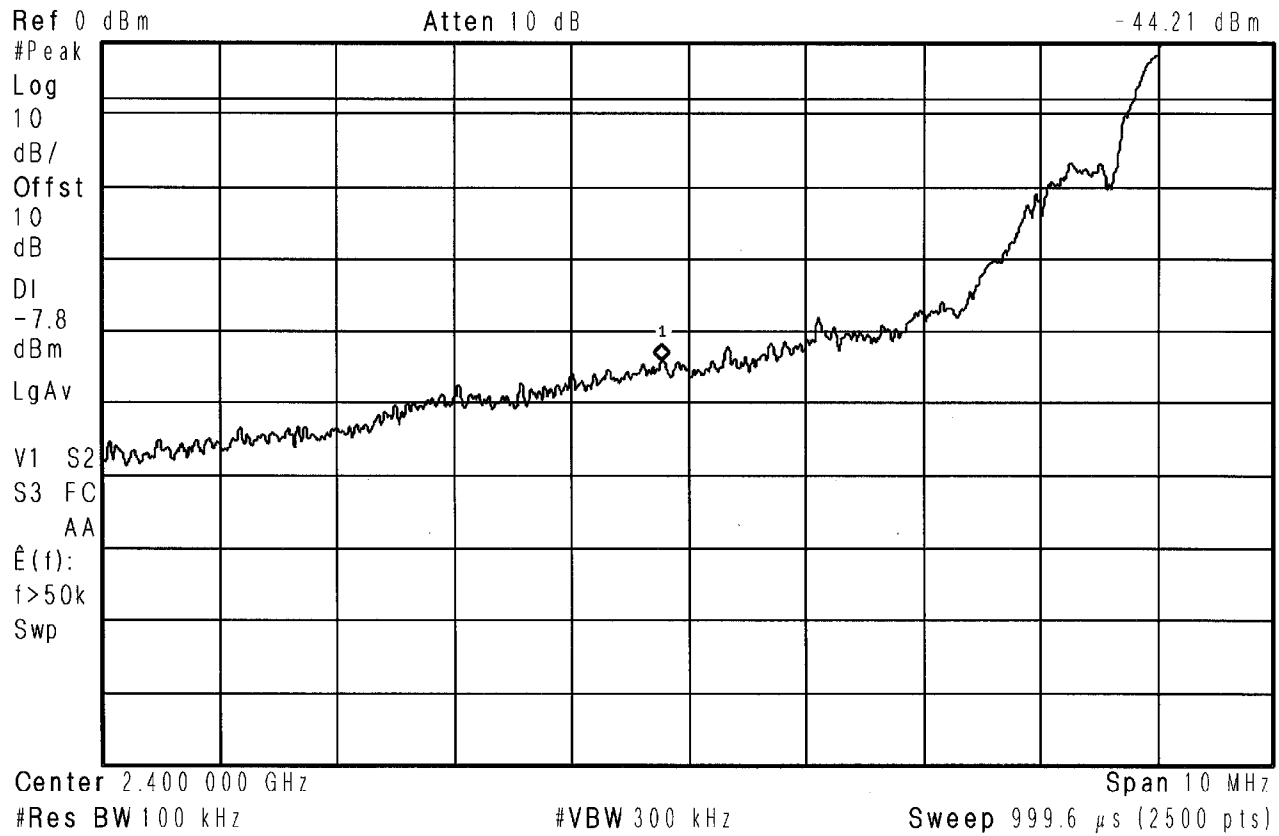

Band Edge Low



Retlif Testing Laboratories

Report No. R-6265N-1

EMISSIONS TEST DATA SHEET

Method:	Band Edge
Test Specification:	FCC Part 15, Subpart C Paragraph: 15.247 (d)
Job Number:	R-6265N-1
Customer:	Lord Corporation
Test Sample:	Ruggedized Wireless Structural Health Monitoring Node
Model Number:	SHM-Link-201
Serial Number:	6329-0150-00001
Operating Mode:	Transmitting modulated (LXRS) signal at 2.480GHz
Technician:	M.Seamans
Date(s):	October 18 th , 2017
Temp/ Relative Humidity:	20.7 °C / 39.1 %
Notes:	Limit: -7.8 dBm

Agilent 18:03:54 Oct 4, 2037

Mkr1 2.483 606 GHz
-40.07 dBm

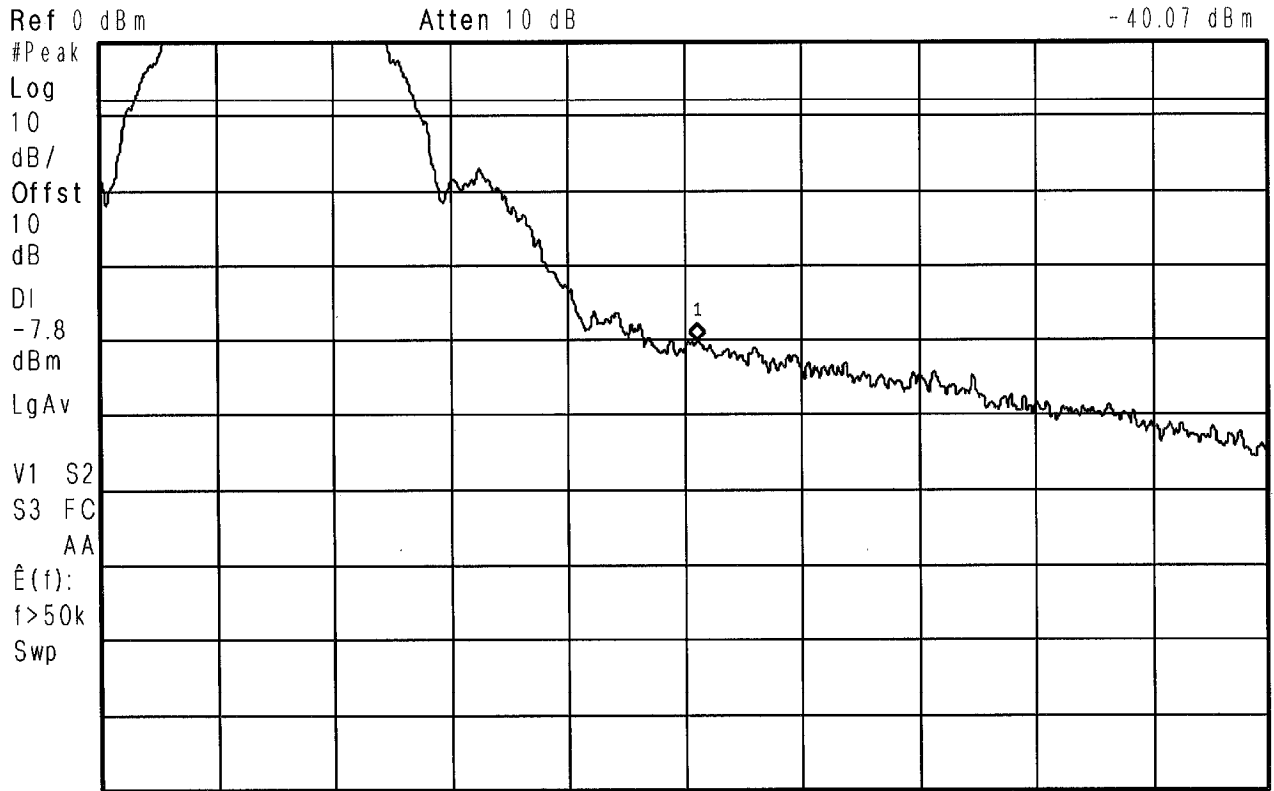

Center 2.483 500 GHz Span 10 MHz
 #Res BW 100 kHz #VBW 300 kHz Sweep 999.6 μs (2500 pts)

Band Edge High



Retlif Testing Laboratories

Report No. R-6265N-1

EMISSIONS TEST DATA SHEET

Method:	Band Edge
Test Specification:	FCC Part 15, Subpart C Paragraph: 15.247 (d)
Job Number:	R-6265N-1
Customer:	Lord Corporation
Test Sample:	Ruggedized Wireless Structural Health Monitoring Node
Model Number:	SHM-Link-201
Serial Number:	6329-0150-00001
Operating Mode:	Transmitting modulated (LXRS+) signal at 2.405GHz
Technician:	M.Seamans
Date(s):	October 18 th , 2017
Temp/ Relative Humidity:	20.7 °C / 39.1 %
Notes:	Limit: -7.8 dBm

Agilent 17:59:03 Oct 4, 2037

Mkr1 2.399 550 GHz

-41.69 dBm

Ref 0 dBm

Atten 10 dB

#Peak

Log

10

dB/

Offst

10

dB

DI

-7.8

dBm

LgAv

V1 S2

S3 FC

AA

E(f):

f>50k

Swp

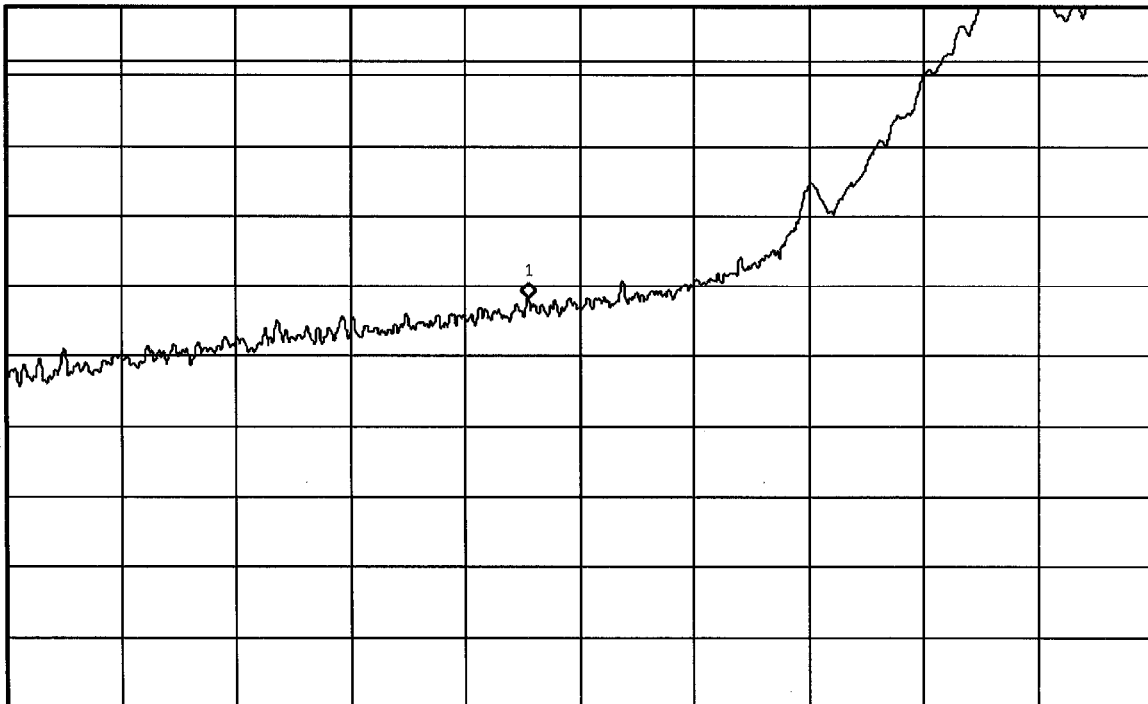

Center 2.400 000 GHz

Span 10 MHz

#Res BW 100 kHz

#VBW 300 kHz

Sweep 999.6 μs (2500 pts)

Band Edge Low



Retlif Testing Laboratories

Report No. R-6265N-1

EMISSIONS TEST DATA SHEET

Method:	Band Edge
Test Specification:	FCC Part 15, Subpart C Paragraph: 15.247 (d)
Job Number:	R-6265N-1
Customer:	Lord Corporation
Test Sample:	Ruggedized Wireless Structural Health Monitoring Node
Model Number:	SHM-Link-201
Serial Number:	6329-0150-00001
Operating Mode:	Transmitting modulated (LXRS+) signal at 2.480GHz
Technician:	M.Seamans
Date(s):	October 18 th , 2017
Temp/ Relative Humidity:	20.7 °C / 39.1 %
Notes:	Limit: -7.8 dBm

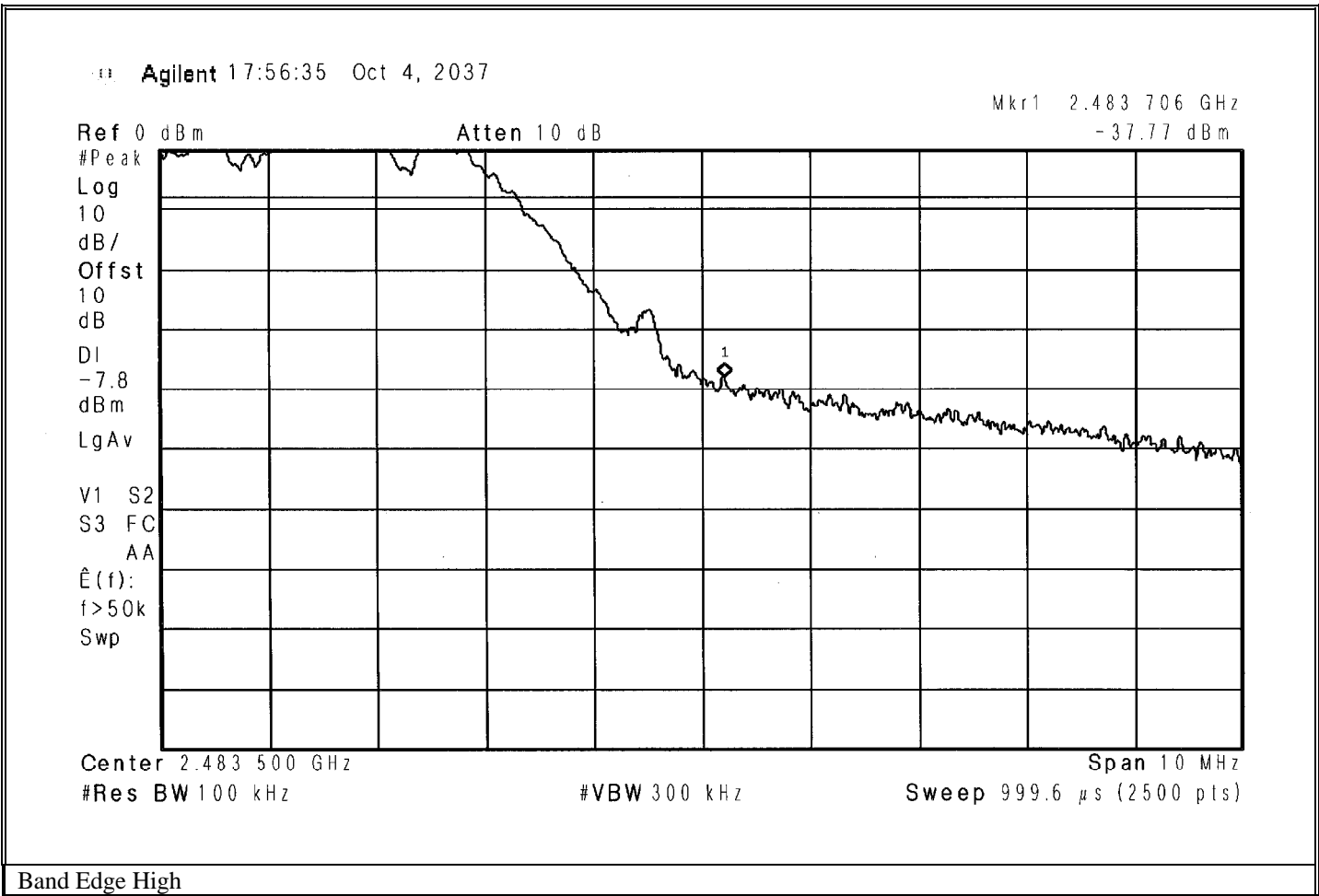

Retlif Testing Laboratories

Report No. R-6265N-1

Test Photographs
Spurious Radiated Emissions

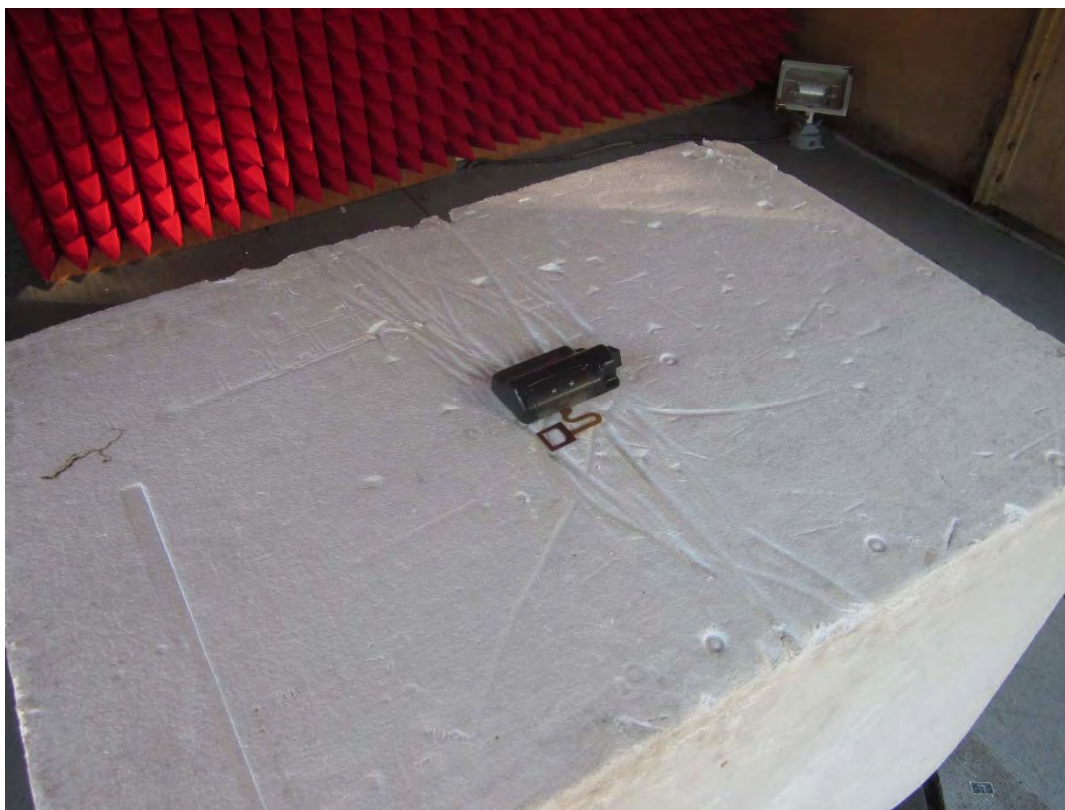

Test Setup



Retlif Testing Laboratories

Report No. R-6265N-1

Test Photographs Spurious Radiated Emissions



Horizontal Antenna Polarization, 30 MHz to 200 MHz, Biconical Antenna



Vertical Antenna Polarization, 30 MHz to 200 MHz, Biconical Antenna



Retlif Testing Laboratories

Report No. R-6265N-1

Test Photographs Spurious Radiated Emissions



Horizontal Antenna Polarization, 200 MHz to 1 GHz, Log Periodic



Vertical Antenna Polarization, 200 MHz to 1 GHz, Log Periodic



Retlif Testing Laboratories

Report No. R-6265N-1

Test Photographs Spurious Radiated Emissions

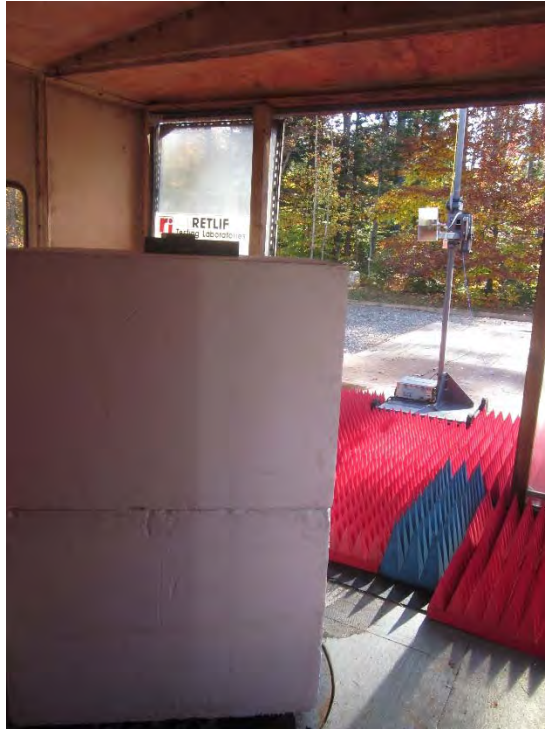

Horizontal Antenna Polarization, 1 GHz to 18 GHz



Vertical Antenna Polarization, 1 GHz to 18 GHz



Retlif Testing Laboratories

Report No. R-6265N-1

**Test Photographs
Spurious Radiated Emissions**



Horizontal Antenna Polarization, 18 GHz to 25 GHz



Vertical Antenna Polarization, 18 GHz to 25 GHz



Retlif Testing Laboratories

Report No. R-6265N-1

**FCC Section 15.247 (d)
Out of Band/Band Edge Radiated Emissions
Test Data**



Retlif Testing Laboratories

Report No. R-6265N-1

RETLIF TESTING LABORATORIES

EMISSIONS TEST DATA SHEET

Test Method	Unwanted Emissions into Restricted Frequency Bands	
Customer	Lord Corporation	
Job Number	R-6265N-1	
Test Sample	Ruggedized Wireless Structural Health Monitoring Node	
Model Number	SHM-Link-201	
Serial Number	6329-0150-00001	
Test Specification	FCC Part 15 Subpart C	Paragraph: 15.247(d)
Operating Mode	Transmitting modulated signal at 2405 MHz, 2440 MHz and 2480 MHz consecutively.	
Technician	M. Seamans	
Date	October 27 th , 2017	

Notes: Antenna Test Distance: 3 meters Detector: Quasi-Peak <1GHz, Average >1GHz

TEST PARAMETERS

Restricted Band	Measured Frequency	Meter Reading	Correction Factor	Corrected Reading		Converted Reading	Limit at 3M
MHz	MHz	dBuV	dB	dBuV/m		uV/m	uV/m
37.50	-	-	-	-		-	100.00
	38.00	4.30	14.20	18.50	*	8.41	I
38.25	-	-	-	-		-	100.00
73.00	-	-	-	-		-	100.00
	74.00	15.54	8.36	23.90	*	15.67	I
74.60	-	-	-	-		-	100.00
74.80	-	-	-	-		-	100.00
	75.00	10.04	8.36	18.40	*	8.32	
75.20	-	-	-	-		-	100.00
108.00	-	-	-	-		-	150.00
	115.00	6.08	10.02	16.10	*	6.38	
	-	-	-	-		-	
121.94	-	-	-	-		-	150.00
123.00	-	-	-	-		-	150.00
	130.00	6.66	9.44	16.10	*	6.38	
	-	-	-	-		-	
138.00	-	-	-	-		-	150.00

No EUT emissions within 10 dB of the specified test limit were observed at the specified test distance throughout the given frequency spectrum.
 * This emission is not from the EUT. It is a measurement of minimum measurement system sensitivity (Noise Floor).

Data Sheet 1 of 7



Retlif Testing Laboratories

Report No. R-6265N-1

RETLIF TESTING LABORATORIES

EMISSIONS TEST DATA SHEET

Test Method	Unwanted Emissions into Restricted Frequency Bands	
Customer	Lord Corporation	
Job Number	R-6265N-1	
Test Sample	Ruggedized Wireless Structural Health Monitoring Node	
Model Number	SHM-Link-201	
Serial Number	6329-0150-00001	
Test Specification	FCC Part 15 Subpart C	Paragraph: 15.247(d)
Operating Mode	Transmitting modulated signal at 2405 MHz, 2440 MHz and 2480 MHz consecutively.	
Technician	M. Seamans	
Date	October 27 th , 2017	

Notes: Antenna Test Distance: 3 meters Detector: Quasi-Peak <1GHz, Average >1GHz

TEST PARAMETERS

Restricted Band	Measured Frequency	Meter Reading	Correction Factor	Corrected Reading			Converted Reading	Limit at 3M
MHz	MHz	dBuV	dB	dBuV/m			uV/m	uV/m
149.90	-	-	-	-			-	150.00
	150.00	4.03	11.17	15.20	*		5.75	
150.05	-	-	-	-			-	150.00
156.52	-	-	-	-			-	150.00
	156.52	4.22	12.08	16.30	*		6.53	
156.52	-	-	-	-			-	150.00
156.70	-	-	-	-			-	150.00
	156.80	4.18	12.12	16.30	*		6.53	
156.90	-	-	-	-			-	150.00
162.01	-	-	-	-			-	150.00
	165.00	4.72	12.68	17.40	*		7.41	
167.17	-	-	-	-			-	150.00
167.72	-	-	-	-			-	150.00
	170.00	5.60	12.80	18.40	*		8.32	
173.20	-	-	-	-			-	150.00

No EUT emissions within 10 dB of the specified test limit were observed at the specified test distance throughout the given frequency spectrum.
 * This emission is not from the EUT. It is a measurement of minimum measurement system sensitivity (Noise Floor).

Data Sheet 2 of 7



Retlif Testing Laboratories

Report No. R-6265N-1

RETLIF TESTING LABORATORIES

EMISSIONS TEST DATA SHEET

Test Method	Unwanted Emissions into Restricted Frequency Bands	
Customer	Lord Corporation	
Job Number	R-6265N-1	
Test Sample	Ruggedized Wireless Structural Health Monitoring Node	
Model Number	SHM-Link-201	
Serial Number	6329-0150-00001	
Test Specification	FCC Part 15 Subpart C	Paragraph: 15.247(d)
Operating Mode	Transmitting modulated signal at 2405 MHz, 2440 MHz and 2480 MHz consecutively.	
Technician	M. Seamans	
Date	October 27 th , 2017	

Notes: Antenna Test Distance: 3 meters Detector: Quasi-Peak <1GHz, Average >1GHz

TEST PARAMETERS

Restricted Band	Measured Frequency	Meter Reading	Correction Factor	Corrected Reading			Converted Reading	Limit at 3M
MHz	MHz	dBuV	dB	dBuV/m			uV/m	uV/m
240.00	-	-	-	-			-	200.00
	260.00	-0.85	16.85	16.00	*		6.31	
285.00	-	-	-	-			-	200.00
322.80	-	-	-	-			-	200.00
	330.00	-0.71	18.91	18.20	*		8.13	
335.40	-	-	-	-			-	200.00
399.90	-	-	-	-			-	200.00
	405.00	-3.39	21.49	18.10	*		8.04	
410.00	-	-	-	-			-	200.00
608.00	-	-	-	-			-	200.00
	611.00	-3.44	27.34	23.90	*		16.67	
614.00	-	-	-	-			-	200.00
960.00	-	-	-	-			-	500.00
	975.00	-0.20	32.10	31.90	*		39.36	
1240.00	-	-	-	-			-	500.00
1300.00	-	-	-	-			-	500.00
	1350.00	33.07	-9.40	23.67	*		15.25	
1427.00	-	-	-	-			-	500.00

EUT emissions observed throughout the given frequency spectrum were recorded and evaluated. Emission levels closest to the limit are listed on this data sheet. * This emission is not from the EUT. It is a measurement of minimum measurement system sensitivity (Noise Floor).

Data Sheet 3 of 7



Retlif Testing Laboratories

Report No. R-6265N-1

RETLIF TESTING LABORATORIES

EMISSIONS TEST DATA SHEET

Test Method	Unwanted Emissions into Restricted Frequency Bands	
Customer	Lord Corporation	
Job Number	R-6265N-1	
Test Sample	Ruggedized Wireless Structural Health Monitoring Node	
Model Number	SHM-Link-201	
Serial Number	6329-0150-00001	
Test Specification	FCC Part 15 Subpart C	Paragraph: 15.247(d)
Operating Mode	Transmitting modulated signal at 2405 MHz, 2440 MHz and 2480 MHz consecutively.	
Technician	M. Seamans	
Date	October 27 th , 2017	

Notes: Antenna Test Distance: 3 meters Detector: Quasi-Peak <1GHz, Average >1GHz

TEST PARAMETERS

Restricted Band	Measured Frequency	Meter Reading	Correction Factor	Corrected Reading			Converted Reading	Limit at 3M
MHz	MHz	dBuV	dB	dBuV/m			uV/m	uV/m
1435.00	-	-	-	-			-	500.00
	1500.00	32.91	-8.64	24.27	*		16.34	
1646.50	-	-	-	-			-	500.00
1660.00	-	-	-	-			-	500.00
	1680.00	32.68	-7.65	25.03	*		17.84	
1710.00	-	-	-	-			-	500.00
1718.80	-	-	-	-			-	500.00
	1720.00	32.37	-5.78	26.59	*		21.35	
1722.20	-	-	-	-			-	500.00
2200.00	-	-	-	-			-	500.00
	2250.00	32.19	-5.46	26.73	*		21.70	
2300.00	-	-	-	-			-	500.00
2310.00	-	-	-	-			-	500.00
	2360.00	31.19	-5.46	25.73	*		19.34	
2390.00	-	-	-	-			-	500.00
2483.50	-	-	-	-			-	500.00
	2490.00	32.10	-5.11	26.99	*		22.36	
2500.00	-	-	-	-			-	500.00

No EUT emissions within 10 dB of the specified test limit were observed at the specified test distance throughout the given frequency spectrum.
 * This emission is not from the EUT. It is a measurement of minimum measurement system sensitivity (Noise Floor).

Data Sheet 4 of 7



Retlif Testing Laboratories

Report No. R-6265N-1

RETLIF TESTING LABORATORIES

EMISSIONS TEST DATA SHEET

Test Method	Unwanted Emissions into Restricted Frequency Bands	
Customer	Lord Corporation	
Job Number	R-6265N-1	
Test Sample	Ruggedized Wireless Structural Health Monitoring Node	
Model Number	SHM-Link-201	
Serial Number	6329-0150-00001	
Test Specification	FCC Part 15 Subpart C	Paragraph: 15.247(d)
Operating Mode	Transmitting modulated signal at 2405 MHz, 2440 MHz and 2480 MHz consecutively.	
Technician	M. Seamans	
Date	October 27 th , 2017	

Notes: Antenna Test Distance: 3 meters Detector: Quasi-Peak <1GHz, Average >1GHz

TEST PARAMETERS

Restricted Band	Measured Frequency	Meter Reading	Correction Factor	Corrected Reading			Converted Reading	Limit at 3M
MHz	MHz	dBuV	dB	dBuV/m			uV/m	uV/m
2690.00	-	-	-	-			-	500.00
	-	-	-	-			-	
	2750.00	32.14	-4.45	27.69	*		24.23	
	-	-	-	-			-	
2900.00	-	-	-	-			-	500.00
3260.00	-	-	-	-			-	500.00
	3263.00	32.01	-2.88	29.13	*		28.60	
3267.00	-	-	-	-			-	500.00
3332.00	-	-	-	-			-	500.00
	3336.00	31.82	-2.62	29.20	*		28.84	
3339.00	-	-	-	-			-	500.00
3345.00	-	-	-	-			-	500.00
	3350.00	31.93	-2.57	29.36	*		29.37	
3358.00	-	-	-	-			-	500.00
3600.00	-	-	-	-			-	500.00
	-	-	-	-			-	
	3700.00	31.39	-1.40	29.99	*		31.58	
	-	-	-	-			-	

EUT emissions observed throughout the given frequency spectrum were recorded and evaluated. Emission levels closest to the limit are listed on this data sheet. * This emission is not from the EUT. It is a measurement of minimum measurement system sensitivity (Noise Floor).

Data Sheet 5 of 7



Retlif Testing Laboratories

Report No. R-6265N-1

RETLIF TESTING LABORATORIES

EMISSIONS TEST DATA SHEET

Test Method	Unwanted Emissions into Restricted Frequency Bands	
Customer	Lord Corporation	
Job Number	R-6265N-1	
Test Sample	Ruggedized Wireless Structural Health Monitoring Node	
Model Number	SHM-Link-201	
Serial Number	6329-0150-00001	
Test Specification	FCC Part 15 Subpart C	Paragraph: 15.247(d)
Operating Mode	Transmitting modulated signal at 2405 MHz, 2440 MHz and 2480 MHz consecutively.	
Technician	M. Seamans	
Date	October 27 th , 2017	

Notes: Antenna Test Distance: 3 meters Detector: Quasi-Peak <1GHz, Average >1GHz

TEST PARAMETERS

Restricted Band MHz	Measured Frequency MHz	Meter Reading dBuV	Correction Factor dB	Corrected Reading dBuV/m			Converted Reading uV/m	Limit at 3M uV/m
	-	-	-	-			-	
4400.00	-	-	-	-			-	500.00
4500.00	-	-	-	-			-	500.00
	4810.00	49.10	0.29	49.39			294.78	
	-	-	-	-			-	
5150.00	-	-	-	-			-	500.00
5350.00	-	-	-	-			-	500.00
	5400.00	30.80	0.92	31.72	*		38.54	
5460.00	-	-	-	-			-	500.00
7250.00	-	-	-	-			-	500.00
	7440.00	35.52	3.65	39.17	*		90.88	
7750.00	-	-	-	-			-	500.00
8025.00	-	-	-	-			-	500.00
	8300.00	32.75	4.43	37.18	*		72.27	
8500.00	-	-	-	-			-	500.00
9000.00	-	-	-	-			-	500.00
	9100.00	32.94	5.10	38.04	*		79.79	
9200.00	-	-	-	-			-	500.00

EUT emissions observed throughout the given frequency spectrum were recorded and evaluated. Emission levels closest to the limit are listed on this data sheet. * This emission is not from the EUT. It is a measurement of minimum measurement system sensitivity (Noise Floor).

Data Sheet 6 of 7



Retlif Testing Laboratories

Report No. R-6265N-1

RETLIF TESTING LABORATORIES

EMISSIONS TEST DATA SHEET

Test Method	Unwanted Emissions into Restricted Frequency Bands	
Customer	Lord Corporation	
Job Number	R-6265N-1	
Test Sample	Ruggedized Wireless Structural Health Monitoring Node	
Model Number	SHM-Link-201	
Serial Number	6329-0150-00001	
Test Specification	FCC Part 15 Subpart C	Paragraph: 15.247(d)
Operating Mode	Transmitting modulated signal at 2405 MHz, 2440 MHz and 2480 MHz consecutively.	
Technician	M. Seamans	
Date	October 27 th , 2017	

Notes: Antenna Test Distance: 3 meters Detector: Quasi-Peak <1GHz, Average >1GHz

TEST PARAMETERS

Restricted Band	Measured Frequency	Meter Reading	Correction Factor	Corrected Reading			Converted Reading	Limit at 3M
MHz	MHz	dBuV	dB	dBuV/m			uV/m	uV/m
9300.00	-	-	-	-			-	500.00
	9400.00	33.15	5.38	38.53	*		84.43	
9500.00	-	-	-	-			-	500.00
10600.00	-	-	-	-			-	500.00
	12200.00	33.40	8.37	41.77	*		122.60	
12700.00	-	-	-	-			-	500.00
13250.00	-	-	-	-			-	500.00
	15800.00	34.60	8.84	43.44	*		148.59	
16200.00	-	-	-	-			-	500.00
17700.00	-	-	-	-			-	500.00
	19240.00	33.19	-6.52	26.67	*		21.55	
21400.00	-	-	-	-			-	500.00
22010.00	-	-	-	-			-	500.00
	22320.00	33.50	-5.30	28.20	*		25.70	
23120.00	-	-	-	-			-	500.00
23600.00	-	-	-	-			-	500.00
	23800.00	34.10	-4.17	29.93	*		31.36	
24000.00	-	-	-	-			-	500.00

EUT emissions observed throughout the given frequency spectrum were recorded and evaluated. Emission levels closest to the limit are listed on this data sheet. * This emission is not from the EUT. It is a measurement of minimum measurement system sensitivity (Noise Floor).

Data Sheet 7 of 7



Retlif Testing Laboratories

Report No. R-6265N-1

Test Photographs Power Density

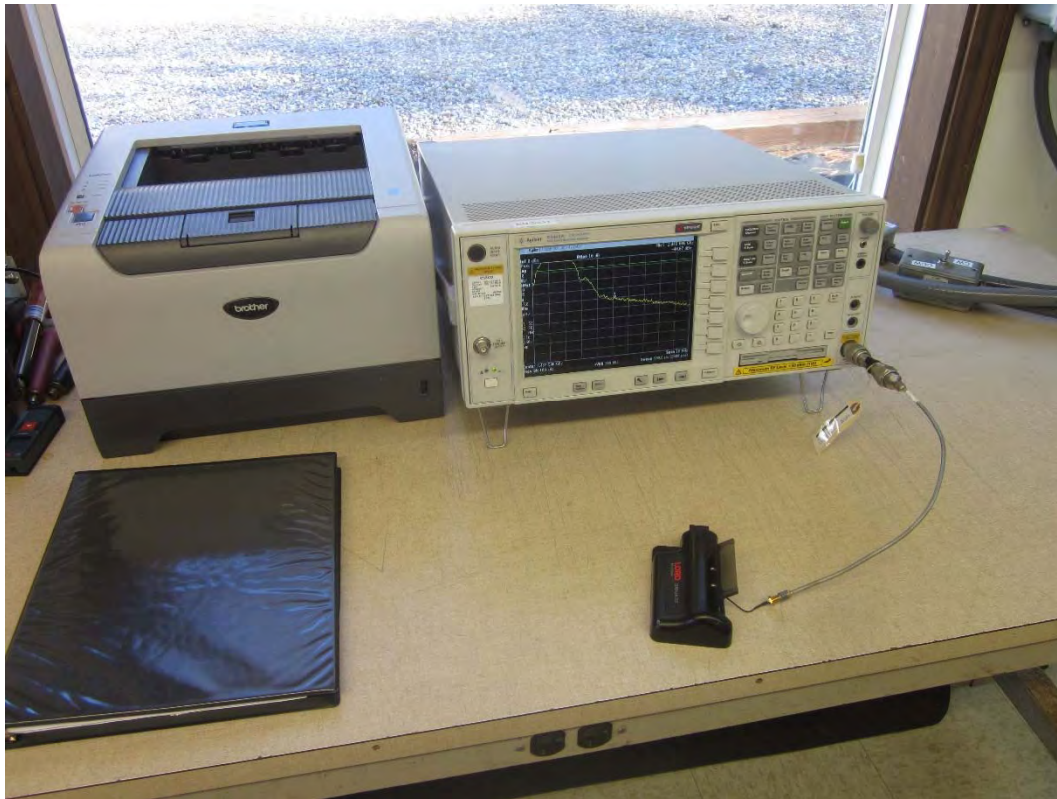

Test Configuration



Retlif Testing Laboratories

Report No. R-6265N-1

**FCC Section 15.247(e)
Power Density
Test Data**



Retlif Testing Laboratories

Report No. R-6265N-1

EMISSIONS TEST DATA SHEET

Method:	Power Spectral Density
Test Specification:	FCC Part 15, Subpart C Paragraph: 15.247 (e)
Job Number:	R-6265N-1
Customer:	Lord Corporation
Test Sample:	Ruggedized Wireless Structural Health Monitoring Node
Model Number:	SHM-Link-201
Serial Number:	6329-0150-00001
Operating Mode:	Transmitting modulated (LXRS) signal at 2.405GHz
Technician:	M.Seamans
Date(s):	October 18 th , 2017
Temp/ Relative Humidity:	20.7 °C / 39.1 %
Notes:	Power Spectral Density: 4.17dBm

Agilent 17:15:18 Oct 4, 2037

Mkr1 2.405 101 0 GHz

Ref 20 dBm

Atten 20 dB

4.17 dBm

#Peak

Log

10

dB/

Offst

10

dB

DI

8.0

dBm

LgAv

V1 S2

S3 FC

AA

E(f):

f>50k

Swp

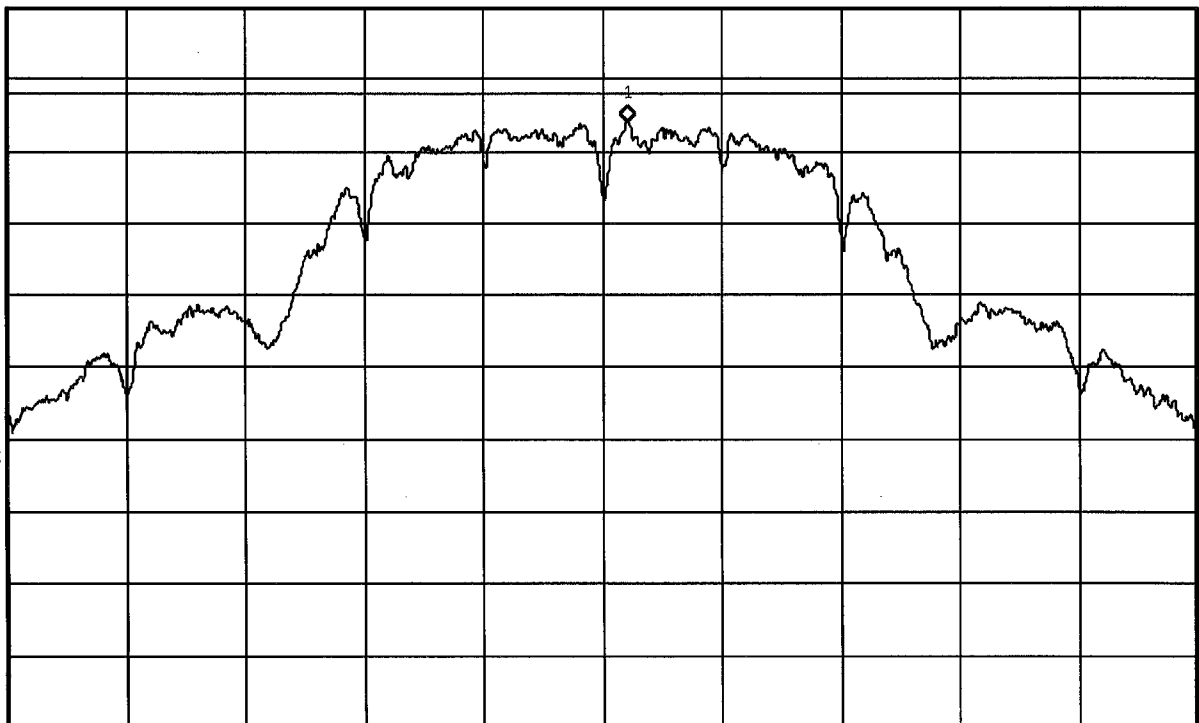

Center 2.405 000 0 GHz

Span 5 MHz

#Res BW 30 kHz

#VBW 100 kHz

Sweep 5.331 ms (2500 pts)



Retlif Testing Laboratories

Report No. R-6265N-1

EMISSIONS TEST DATA SHEET

Method:	Power Spectral Density
Test Specification:	FCC Part 15, Subpart C Paragraph: 15.247 (e)
Job Number:	R-6265N-1
Customer:	Lord Corporation
Test Sample:	Ruggedized Wireless Structural Health Monitoring Node
Model Number:	SHM-Link-201
Serial Number:	6329-0150-00001
Operating Mode:	Transmitting modulated (LXRS) signal at 2.440GHz
Technician:	M.Seamans
Date(s):	October 18 th , 2017
Temp/ Relative Humidity:	20.7 °C / 39.1 %
Notes:	Power Spectral Density: 3.71dBm

Agilent 17:14:42 Oct 4, 2037

Mkr1 2.440 101 0 GHz

Ref 20 dBm

Atten 20 dB

3.71 dBm

#Peak
Log
10
dB/
Offst
10
dB
DI
8.0
dBm
LgAv
V1 S2
S3 FC
.AA
Ê(f):
f>50k
Swp

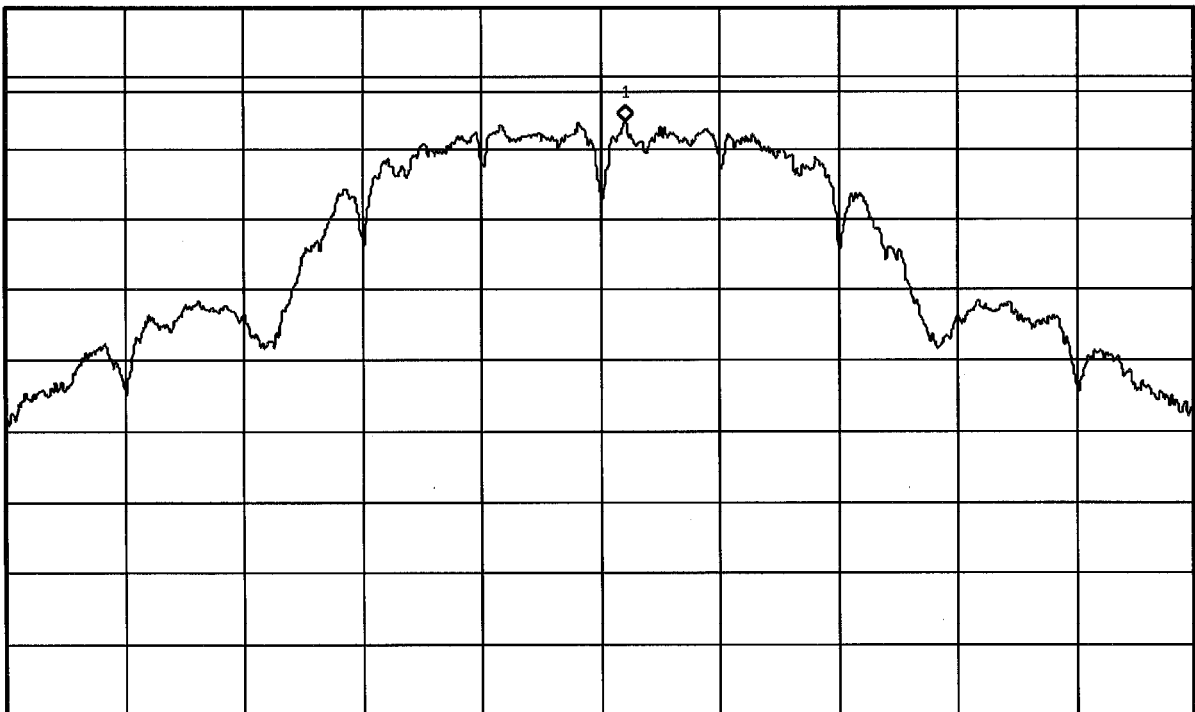

Center 2.440 000 0 GHz

Span 5 MHz

#Res BW 30 kHz

#VBW 100 kHz

Sweep 5.331 ms (2500 pts)



Retlif Testing Laboratories

Report No. R-6265N-1

EMISSIONS TEST DATA SHEET

Method:	Power Spectral Density
Test Specification:	FCC Part 15, Subpart C Paragraph: 15.247 (e)
Job Number:	R-6265N-1
Customer:	Lord Corporation
Test Sample:	Ruggedized Wireless Structural Health Monitoring Node
Model Number:	SHM-Link-201
Serial Number:	6329-0150-00001
Operating Mode:	Transmitting modulated (LXRS) signal at 2.480GHz
Technician:	M.Seamans
Date(s):	October 18 th , 2017
Temp/ Relative Humidity:	20.7 °C / 39.1 %
Notes:	Power Spectral Density: 3.39dBm

Agilent 17:13:22 Oct 4, 2037

Mkr1 2.480 107 0 GHz

Ref 20 dBm

Atten 20 dB

3.39 dBm

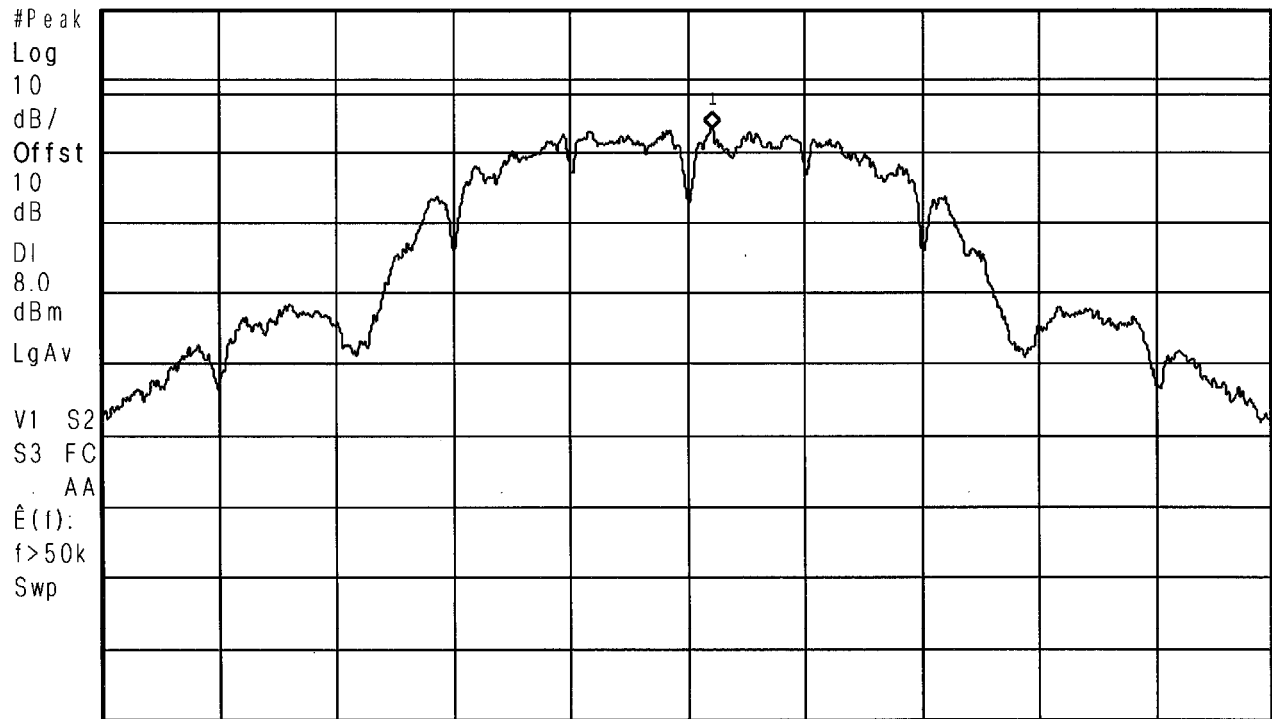

Center 2.480 000 GHz

Span 5 MHz

#Res BW 30 kHz

#VBW 100 kHz

Sweep 5.331 ms (2500 pts)



Retlif Testing Laboratories

Report No. R-6265N-1

EMISSIONS TEST DATA SHEET

Method:	Power Spectral Density
Test Specification:	FCC Part 15, Subpart C Paragraph: 15.247 (e)
Job Number:	R-6265N-1
Customer:	Lord Corporation
Test Sample:	Ruggedized Wireless Structural Health Monitoring Node
Model Number:	SHM-Link-201
Serial Number:	6329-0150-00001
Operating Mode:	Transmitting modulated (LXRS+) signal at 2.405GHz
Technician:	M.Seamans
Date(s):	October 18 th , 2017
Temp/ Relative Humidity:	20.7 °C / 39.1 %
Notes:	Power Spectral Density: 5.28 dBm

Agilent 17:17:44 Oct 4, 2037

Mkr1 2.404 006 6 GHz
5.28 dBm

Ref 20 dBm

Atten 20 dB

#Peak

Log

10

dB/

Offst

10

dB

DI

8.0

dBm

LgAv

V1 S2

S3 FC

AA

E(f):

f>50k

Swp

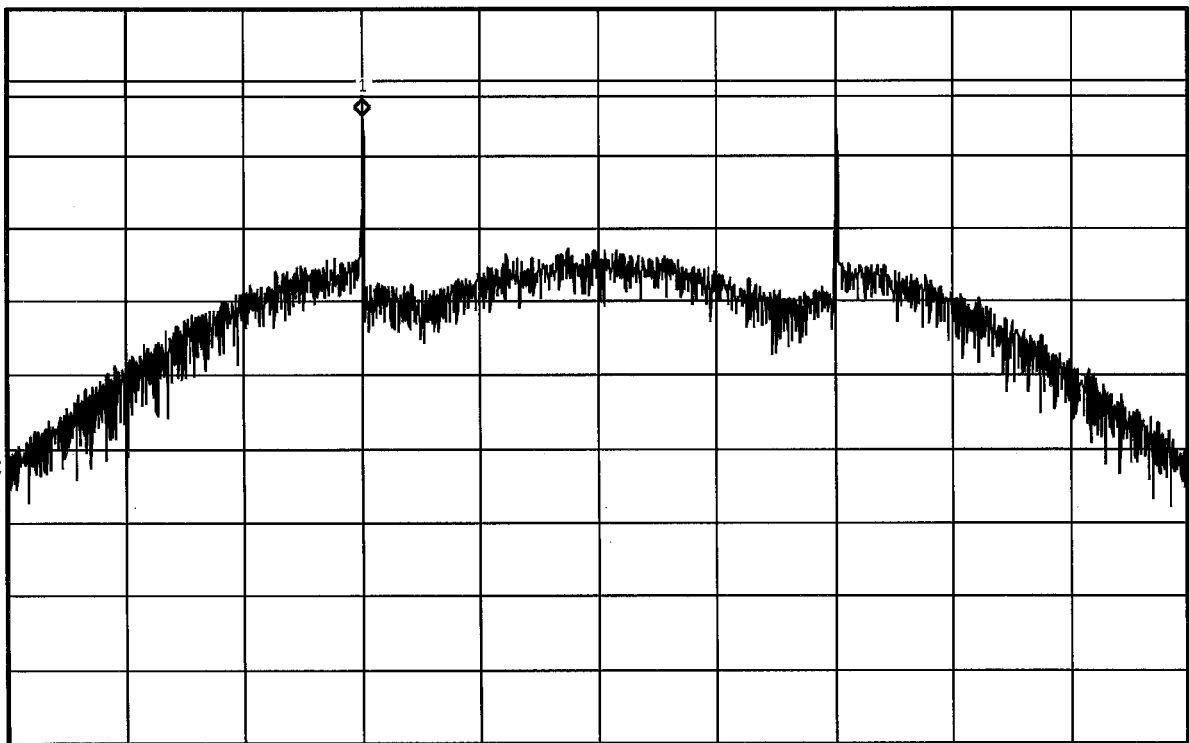

Center 2.405 000 0 GHz

Span 5 MHz

#Res BW 3 kHz

#VBW 10 kHz

Sweep 527.3 ms (2500 pts)



Retlif Testing Laboratories

Report No. R-6265N-1

EMISSIONS TEST DATA SHEET

Method:	Power Spectral Density
Test Specification:	FCC Part 15, Subpart C Paragraph: 15.247 (e)
Job Number:	R-6265N-1
Customer:	Lord Corporation
Test Sample:	Ruggedized Wireless Structural Health Monitoring Node
Model Number:	SHM-Link-201
Serial Number:	6329-0150-00001
Operating Mode:	Transmitting modulated (LXRS+) signal at 2.440GHz
Technician:	M.Seamans
Date(s):	October 18 th , 2017
Temp/ Relative Humidity:	20.7 °C / 39.1 %
Notes:	Power Spectral Density: 4.86 dBm

Agilent 17:18:25 Oct 4, 2037

Mkr1 2.439 006 6 GHz
4.86 dBm

Ref 20 dBm

Atten 20 dB

#Peak
Log
10
dB/
Offst
10
dB
DI
8.0
dBm
LgAv
V1 S2
S3 FC
AA
Ê(f):
f>50k
Swp

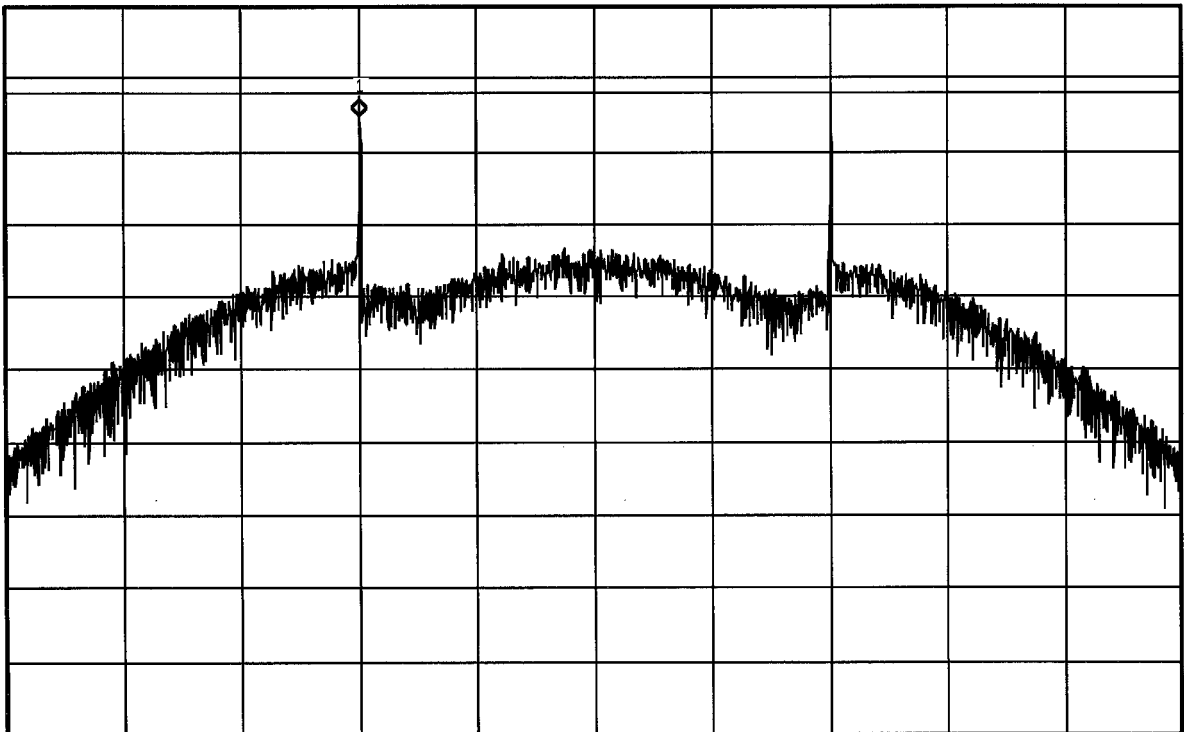

Center 2.440 000 0 GHz

Span 5 MHz

#Res BW 3 kHz

#VBW 10 kHz

Sweep 527.3 ms (2500 pts)



Retlif Testing Laboratories

Report No. R-6265N-1

EMISSIONS TEST DATA SHEET

Method:	Power Spectral Density
Test Specification:	FCC Part 15, Subpart C Paragraph: 15.247 (e)
Job Number:	R-6265N-1
Customer:	Lord Corporation
Test Sample:	Ruggedized Wireless Structural Health Monitoring Node
Model Number:	SHM-Link-201
Serial Number:	6329-0150-00001
Operating Mode:	Transmitting modulated (LXRS+) signal at 2.480GHz
Technician:	M.Seamans
Date(s):	October 18 th , 2017
Temp/ Relative Humidity:	20.7 °C / 39.1 %
Notes:	Power Spectral Density: 4.51dBm

Agilent 17:19:06 Oct 4, 2037

Mkr1 2.481 005 4 GHz
4.51 dBm

Ref 20 dBm

Atten 20 dB

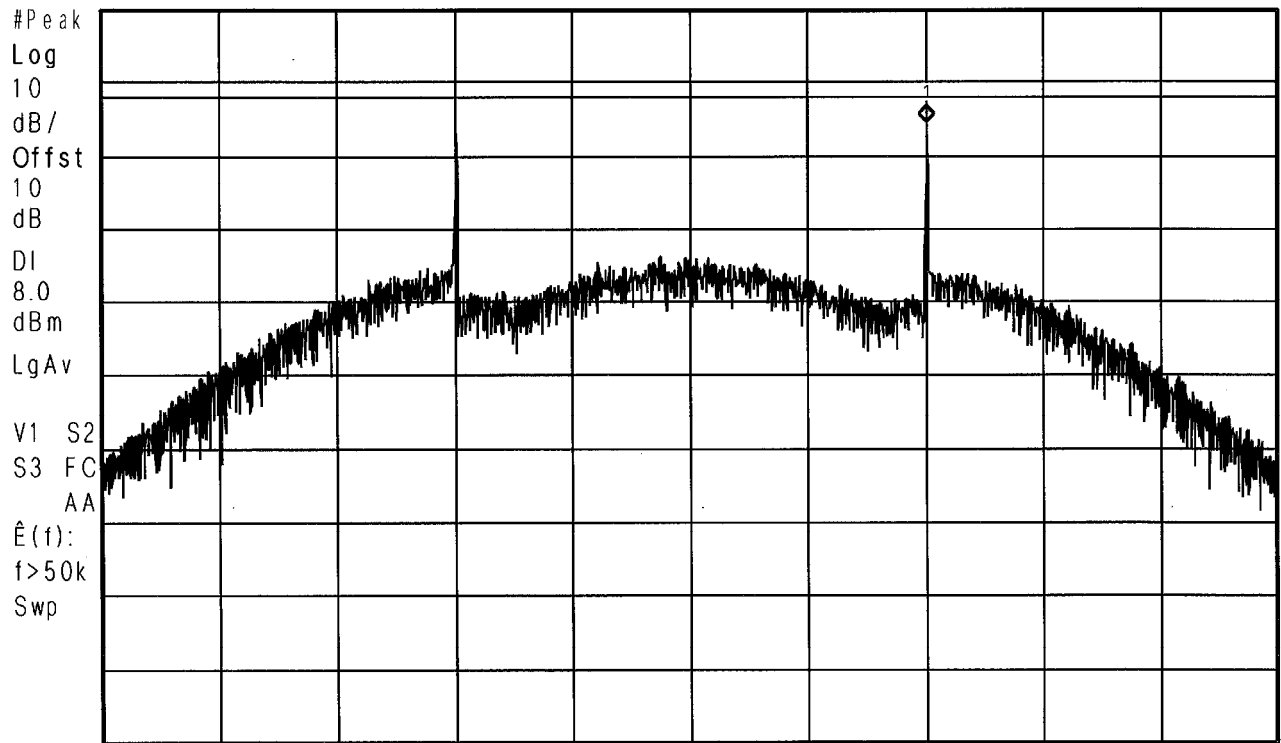

Center 2.480 000 0 GHz

Span 5 MHz

#Res BW 3 kHz

#VBW 10 kHz

Sweep 527.3 ms (2500 pts)



Retlif Testing Laboratories

Report No. R-6265N-1