



FCC Part 15, Subpart C, Section 15.247

Test Report

On

G-Link-200 Accelerometer  
FCC ID: XJQMSLINK0005

**Customer Name:** Lord Corporation

**Customer P.O.:** 687572

**Date of Report:** April 21, 2017

**Test Report No.:** R-6179N-1

**Test Start Date:** March 7, 2017

**Test Finish Date:** March 16, 2017

**Test Technician:** M. Seamans

**Report Approved By:** T. Hannemann

**Report Prepared By:** J. Ramsey

Our letters, procedures and reports are for the exclusive use of the customer to whom they are addressed and their communication or the use of the name of Retlif Testing Laboratories must receive our prior written approval. Our letters, procedures and reports apply only to the sample tested and are not necessarily indicative of the qualities of apparently identical or similar products. The letters, procedures and reports and the name of Retlif Testing Laboratories or insignia are not to be used under any circumstances in advertising to the general public. This test report shall not be reproduced, except in full, without the written approval of Retlif Testing Laboratories.

## Technical Information

**Report Number:** R-6179N-1

**Customer:** Lord Corporation

**Address:** 459 Hurricane Lane, Suite 102  
Williston, VT 05495

**Manufacturer:** Lord Corporation

**Manufacturer Address:** 459 Hurricane Lane, Suite 102  
Williston, VT 05495

**Test Sample:** G-Link-200 Accelerometer

**Model Number:** G-Link-200-8G

**Serial Numbers:** 6305-6000-6009, 6305-6000-6003

**FCC ID:** XJQMSLINK0005  
Digital Transmission – Direct Sequence Spread Spectrum

**Type:** Transmitter

**Power Requirements:** 3.6 VDC via three (3) Lithium Ion batteries

**Frequency of Operation:** 2402.0 to 2480.0 MHz

**Equipment Class:** DTS

**Antenna Type:** Internal SMD Patch Antenna 2dBi Gain

**Equipment Use:** Wireless Data Node

**Test Specification:**

FCC Rules and Regulations Part 15, Subpart C, Section 15.247

**Test Procedure:**

ANSI C63.4: 2014

ANSI C63.10: 2013

**Test Facility:**

Retlif Testing Laboratories

101 New Boston Road

Goffstown, NH 03045

FCC Registered Test Site Number: 90899



Retlif Testing Laboratories

Report No. R-6179N-1

Table 1 – Tests Performed

FCC Part 15, Subpart C	Test Method
15.247(b)(3)	Power Output
15.247(a)(2)	Occupied Bandwidth
15.247(d)	Antenna Terminal Out of Band/Band Edge Conducted Emissions (30 MHz – 25 GHz)
15.247(d)	Spurious Emissions, 30 MHz to 10 GHz
15.247(e)	Power Density

Table 2 – Support Equipment

Description	Manufacturer	Model Number	Serial Number
Laptop	Gateway	NE56R52U	NXY1UAA045348501F63400
Wireless Base Station	Lord Microstrain	WSDA-Base-LXRS	6307-1040-57209

**EUT Operation:**

The EUT was transmitting a modulating signal at 2.405 GHz Channel 11, 2.440 GHz Channel 18 and 2.480 GHz Channel 26.



**Retlif Testing Laboratories**

Report No. R-6179N-1

## Certification and Signatures

We certify that this report is a true representation of the results obtained from the tests of the equipment stated. We further certify that the measurements shown in this report were made in accordance with the procedures indicated and vouch for the qualifications of all Retlif Testing Laboratories personnel taking them.



---

Scott Wentworth  
Branch Manager  
NVLAP Approved Signatory



---

Todd Hannemann  
EMC Test Engineer  
iNARTE Certified Technician ATL-0255-T

### Non-Warranty Provision

The testing services have been performed, findings obtained and reports prepared in accordance with generally accepted laboratory principles and practices. This warranty is in lieu of all others, either expressed or implied.

### Non-Endorsement

This test report contains only findings and results arrived at after employing the specific test procedures and standards listed herein. It is not intended to constitute a recommendation, endorsement or certification of the product or material tested. This test report must not be used by the client to claim product endorsement by NVLAP or any agency of the U.S. Government.



**Retlif Testing Laboratories**

Report No. R-6179N-1

## Revision History

Revisions to this document are listed below; the latest revised document supersedes all previous issues of this document:

<b>Revision</b>	<b>Date</b>	<b>Pages Affected</b>
-	April 21, 2017	Original Release



**Retlif Testing Laboratories**

Report No. R-6179N-1

## Requirements and Test Results

### **FCC Section 15.247 (a)(2) – Bandwidth**

For systems using digital modulation techniques operating in the 902-928 MHz, 2400-2483.5 MHz, and 5725 – 5850 MHz bands the minimum 6 dB bandwidth shall be at least 500 kHz.

- **Results:** The minimum 6dB bandwidth measured while transmitting was 1.68 MHz. The device was found to meet the requirement of 15.247 (a)(2).

### **FCC Section 15.247 (b)(3) - Power Output**

For systems using digital modulation in the 902-928 MHz, 2400-2483.5 MHz, and 5725-5850 MHz bands: 1 Watt. As an alternative to a peak power measurement, compliance with the one Watt limit can be based on a measurement of the maximum conducted output power. Maximum Conducted Output Power is defined as the total transmit power delivered to all antennas and antenna elements averaged across all symbols in the signaling alphabet when the transmitter is operating at its maximum power control level. Power must be summed across all antennas and antenna elements. The average must not include any time intervals during which the transmitter is off or is transmitting at a reduced power level. If multiple modes of operation are possible (e.g.: alternative modulation methods), the maximum conducted output power is the highest total transmit power occurring in any mode.

- **Results:** The maximum measured peak conducted output power when transmitting was 69.18 mW. The maximum antenna gain of the antenna is 2.0 dBi. The device was found to meet the power output requirements of 15.247 (b)(3) including de facto EIRP.



**Retlif Testing Laboratories**

Report No. R-6179N-1

**Requirements and Test Results (con't)**

**FCC Section 15.247(d) – Unwanted Emissions**

**Antenna Terminal Out of Band/Band Edge Conducted Emissions**

In any 100 kHz bandwidth outside the frequency band in which the spread spectrum or digitally modulated intentional radiator is operating, the radio frequency power that is produced by the intentional radiator shall be at least 20 dB below that in the 100 kHz bandwidth within the band that contains the highest level of the desired power, based on either an RF conducted or a radiated measurement, provided the transmitter demonstrates compliance with the peak conducted power limits. If the transmitter complies with the conducted power limits based on the use of RMS averaging over a time interval, as permitted under Paragraph (b)(3) of Section 15.247, the attenuation required under this paragraph shall be 30 dB instead of 20 dB. Attenuation below the general limits specified in Section 15.209(a) is not required. In addition, radiated emissions which fall in the restricted bands, as defined in Section 15.205(a) must also comply with the radiated emission limits specified in Section 15.209(a) (see Section 15.205(c)).

- **Results:** All measured out of band/band edge conducted emissions were below the specified limits and the device was found to meet the requirements of 15.247 (d).

**FCC Section 15.247(d) – Unwanted Emissions**

**Radiated Spurious Emissions/Restricted Bands/Band Edge**

Emissions which fall into restricted bands, as defined in 15.205(a) must comply with the radiated emissions limits specified in 15.209(a) and shown below in Table 1. Emissions emanating from the EUT cabinet and cables must also comply with the radiated emissions limits. Radiated emissions measurements were also performed at the band edges to ensure band edge compliance.

Table 3 - Radiated Emission Limits

Frequency of Emission (MHz)	Field Strength (microvolts/meter)	Measurement Distance (meters)
30 to 88	100	3
88 to 216	150	3
216 to 960	200	3
Above 960	500	3

- **Results:** All spurious emissions were measured and found to be in compliance with the limits specified in 15.209(a). Band edge emissions were also found to be in compliance with the limits specified in 15.209(a).



**Retlif Testing Laboratories**

Report No. R-6179N-1

**Requirements and Test Results (con't)**

**FCC Section 15.247(e) – Power Spectral Density**

For digitally modulated systems, the power spectral density conducted from the intentional radiator to the antenna shall not be greater than 8 dBm in any 3 kHz band during any time interval of continuous transmission. This power spectral density shall be determined in accordance with the provisions of paragraph (b) of this section. The same method of determining the conducted output power shall be used to determine the power spectral density.

- **Results:** The power spectral density conducted from the intentional radiator to the antenna was not greater than 8 dBm in any 3 kHz band during any time interval of continuous transmission. This power spectral density was determined in accordance with Section 15.247(b)(3), herein.



**Retlif Testing Laboratories**

Report No. R-6179N-1



## Requirements and Test Results (con't)

Field Strength Calculation/Conversion:

The maximized field strength of the emission was obtained as follows:

$$CR = MR + CF$$

Where:

CR = Corrected Reading in dB $\mu$ V/m

MR = Uncorrected Meter Reading in dB $\mu$ V

CF = Correction Factor in dB (Antenna Factor, Pre-amp + Cable Loss)

Example:

$$MR = 15.35 \text{ dB}\mu\text{V}$$

$$CF = 16.85 \text{ dB}$$

$$CR = 15.35 \text{ dB}\mu\text{V} + 16.85 = 32.2 \text{ dB}\mu\text{V/m}$$

dB $\mu$ V/M is converted to uV/M for comparison to the specified limit using the formula:

$$\text{invLog dB}\mu\text{V/M}/20$$

$$32.2 \text{ dB}\mu\text{V/m} = 40.74 \text{ uV/m}$$

RF Power Conversion:

Power readings in dBm may be converted to mW using the formula:

$$\text{InvLog dBm}/10$$

$$\text{Example: } 20\text{dBm} = 100\text{mW}$$



**Retlif Testing Laboratories**

Report No. R-6179N-1

## FCC Section 15.247 (i)

### RF Exposure Limits

Spread Spectrum Transmitters operating under 15.247 must be operated in a manner that ensures the public is not exposed to RF energy levels in excess of the commission's guidelines. Based on the transmitter power and maximum antenna gain (see calculation below) the minimum separation distance was calculated to determine the distance for acceptable MPE power density levels to meet both the Occupational/Controlled Exposure and the General Population/Uncontrolled Exposure requirements of FCC Part 1.1310. The calculation below uses the more stringent General Population MPE Limits.

$$S = \frac{PG}{4\pi D^2}$$

D = Minimum Separation Distance in cm

S = Max allowed Power Density in mW/cm<sup>2</sup>

Per 1.1310 For the Frequency of 2400 MHz S = 1 mW/cm<sup>2</sup>

Power = Max Power Input to Antenna = 69.18 mW

Gain = Max Power Gain of Antenna = 2.0 dBi = 1.58 numeric

$$1.0 \text{ mW/cm}^2 = \frac{69.18 \times 1.58}{4 \times (3.14) \times D^2} = \frac{109.65}{12.56 \times D^2}$$

$$D^2 = \frac{109.65}{12.56 \times 1.0}$$

$$D = \sqrt{8.73} = 2.95 \text{ cm}$$



**Retlif Testing Laboratories**

Report No. R-6179N-1

## Equipment List

### FCC Section 15.247(a)(2) Occupied Bandwidth

EN	Manufacturer	Description	Range	Model No.	Cal Date	Due Date
5070	ROHDE & SCHWARZ	RECEIVER, EMI	20 Hz - 40 GHz	ESIB40	10/21/2016	10/31/2017
5133	NARDA MICROWAVE	ATTENUATOR, COAXIAL	10 dB, DC - 12.4 GHz	757C-10	10/10/2016	10/31/2017

### FCC Section 15.247 (d) Band Edge Conducted Emissions, 30 MHz to 25 GHz

EN	Manufacturer	Description	Range	Model No.	Cal Date	Due Date
5133	NARDA MICROWAVE	ATTENUATOR, COAXIAL	10 dB, DC - 12.4 GHz	757C-10	10/10/2016	10/31/2017
R469	AGILENT / HP	ANALYZER, SPECTRUM	100 Hz - 26.5 GHz	E7405A;A	12/1/2016	12/31/2017

### FCC Section 15.247(b)(3) Power Output

EN	Manufacturer	Description	Range	Model No.	Cal Date	Due Date
5070	ROHDE & SCHWARZ	RECEIVER, EMI	20 Hz - 40 GHz	ESIB40	10/21/2016	10/31/2017
5133	NARDA MICROWAVE	ATTENUATOR, COAXIAL	10 dB, DC - 12.4 GHz	757C-10	10/10/2016	10/31/2017

### FCC Section 15.247 (d) Spurious Radiated Emissions, 30 MHz to 25 GHz

EN	Manufacturer	Description	Range	Model No.	Cal Date	Due Date
1232	AGILENT / HP	PRE-AMPLIFIER	1 - 26.5 GHz	8449B	6/16/2016	6/30/2017
3258	ETS / EMCO	ANTENNA, DOUBLE RIDGED GUIDE	1 - 18 GHz	3115	10/13/2016	4/30/2018
3427B	ETS / EMCO	ANTENNA, BICONICAL	20 - 200 MHz	3104	2/5/2016	8/31/2017
3430	MCS	ANTENNA, HORN	18 - 26.5 GHz	K-5039	No Calibration Required	
4029B	RETLIF	OPEN AREA TEST SITE, ATTENUATION	3 / 10 Meters	RNH	4/13/2016	4/30/2018
443	ELECTRO-METRICS	ANTENNA, LOG PERIODIC	200 MHz - 1000 MHz	LPA-25	10/6/2016	4/30/2018
R469	AGILENT / HP	ANALYZER, SPECTRUM	100 Hz - 26.5 GHz	E7405A;A	12/1/2016	12/31/2017

### FCC Section 15.247(e) Power Density

EN	Manufacturer	Description	Range	Model No.	Cal Date	Due Date
5070	ROHDE & SCHWARZ	RECEIVER, EMI	20 Hz - 40 GHz	ESIB40	10/21/2016	10/31/2017
5133	NARDA MICROWAVE	ATTENUATOR, COAXIAL	10 dB, DC - 12.4 GHz	757C-10	10/10/2016	10/31/2017



Retlif Testing Laboratories

Report No. R-6179N-1

## Test Photographs Occupied Bandwidth



Test Setup



**Retlif Testing Laboratories**

Report No. R-6179N-1

**FCC Section 15.247(a)(2)  
Occupied Bandwidth  
Test Data**



**Retlif Testing Laboratories**

Report No. R-6179N-1

# RETLIF TESTING LABORATORIES

<b>Test Method:</b>	6dB Bandwidth		
<b>Customer</b>	Lord Corporation	<b>Job No.</b>	R-6179N-1
<b>Test Sample</b>	G-Link-200 Accelerometer		
<b>Model Number</b>	G-Link-200-8G	<b>Serial No.</b>	6305-6000-6003
<b>Operating Mode</b>	Transmitting modulated signal at 2.405 GHz		
<b>Test Specification</b>	FCC Part 15, Subpart C Paragraph: 15.247 (a)(2)		
<b>Technician</b>	M. Seamans	<b>Date</b>	March 7 <sup>th</sup> , 2017
<b>Climatic Conditions</b>	Temp: 21.0 °C    Relative Humidity: 16.6 %		
<b>Notes</b>	Occupied Bandwidth: 1.68 MHz		

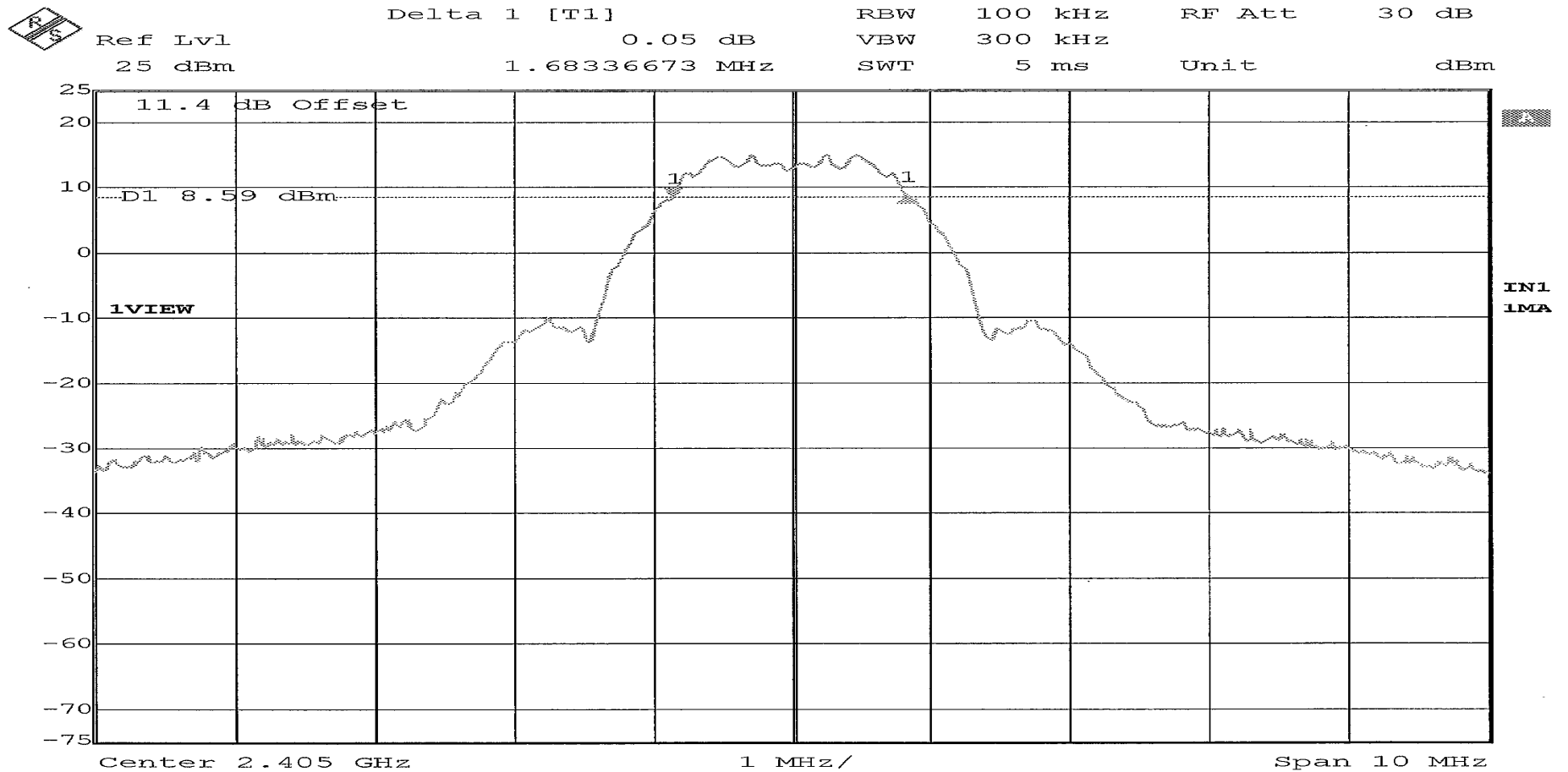

# RETLIF TESTING LABORATORIES

<b>Test Method:</b>	6dB Bandwidth		
<b>Customer</b>	Lord Corporation	<b>Job No.</b>	R-6179N-1
<b>Test Sample</b>	G-Link-200 Accelerometer		
<b>Model Number</b>	G-Link-200-8G	<b>Serial No.</b>	6305-6000-6003
<b>Operating Mode</b>	Transmitting modulated signal at 2.440 GHz		
<b>Test Specification</b>	FCC Part 15, Subpart C Paragraph: 15.247 (a)(2)		
<b>Technician</b>	M. Seamans	<b>Date</b>	March 7 <sup>th</sup> , 2017
<b>Climatic Conditions</b>	Temp: 21.0 °C    Relative Humidity: 16.6 %		
<b>Notes</b>	Occupied Bandwidth: 1.68 MHz		

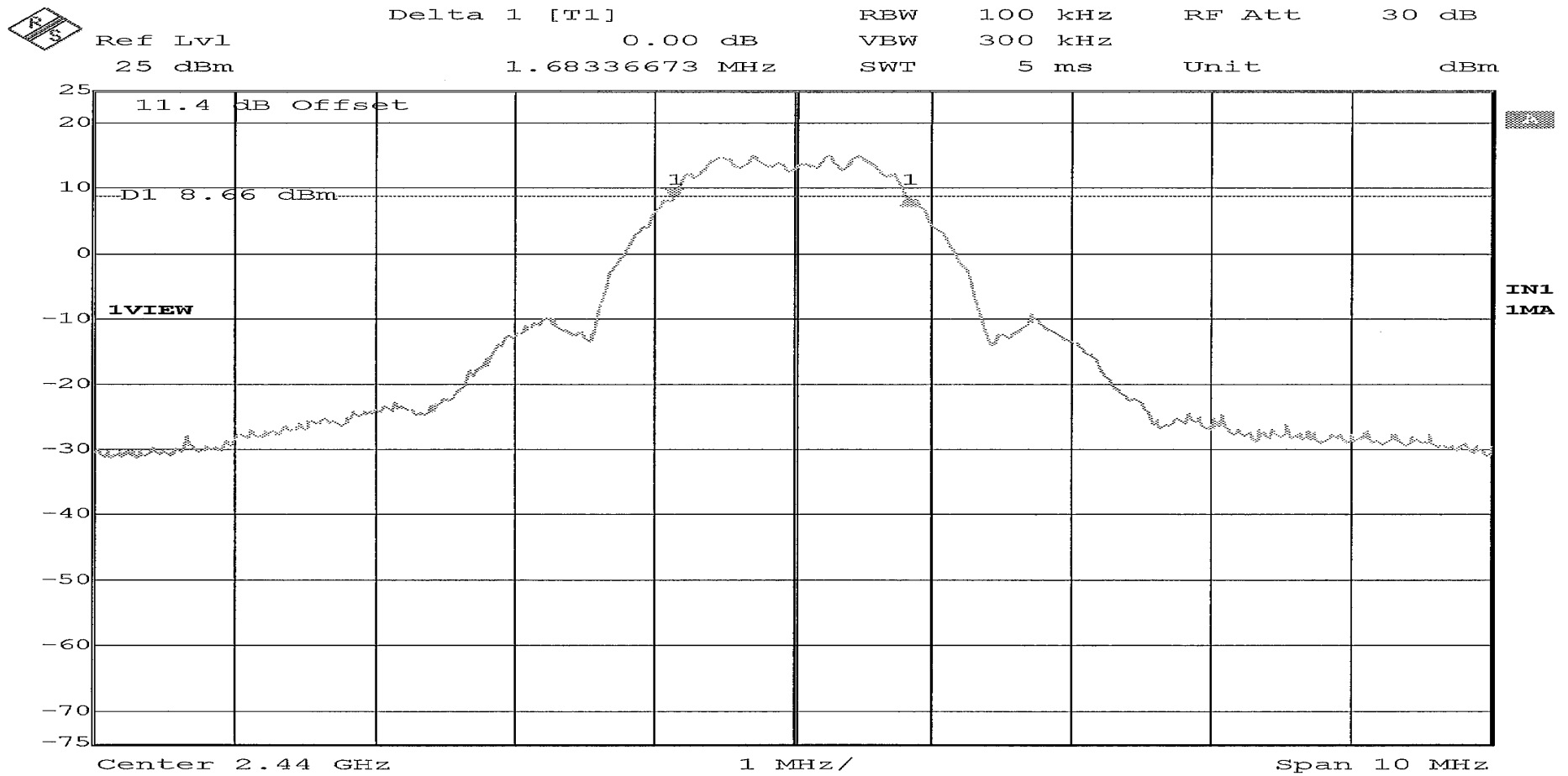

# RETLIF TESTING LABORATORIES

<b>Test Method:</b>	6dB Bandwidth		
<b>Customer</b>	Lord Corporation	<b>Job No.</b>	R-6179N-1
<b>Test Sample</b>	G-Link-200 Accelerometer		
<b>Model Number</b>	G-Link-200-8G	<b>Serial No.</b>	6305-6000-6003
<b>Operating Mode</b>	Transmitting modulated signal at 2.480GHz		
<b>Test Specification</b>	FCC Part 15, Subpart C Paragraph: 15.247 (a)(2)		
<b>Technician</b>	M. Seamans	<b>Date</b>	March 7 <sup>th</sup> , 2017
<b>Climatic Conditions</b>	Temp: 21.0 °C    Relative Humidity: 16.6 %		
<b>Notes</b>	Occupied Bandwidth: 1.68 MHz		

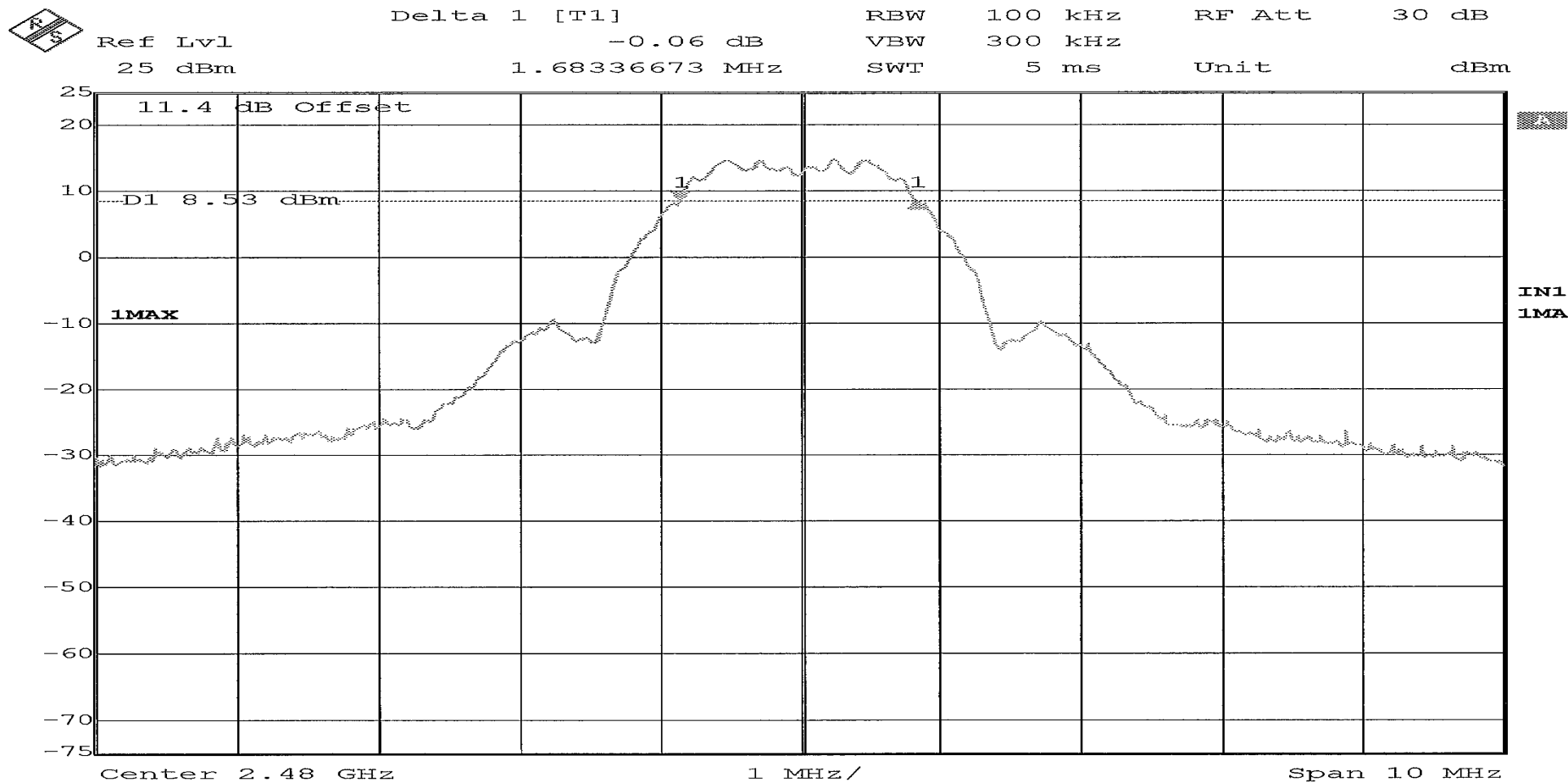



## Test Photographs Power Output



Test Setup



Retlif Testing Laboratories

Report No. R-6179N-1

**FCC Section 15.247 (b)(3)  
Power Output  
Test Data**



**Retlif Testing Laboratories**

Report No. R-6179N-1

# RETLIF TESTING LABORATORIES

<b>Test Method:</b>	Conducted Peak Power Output		
<b>Customer</b>	Lord Corporation	<b>Job No.</b>	R-6179N-1
<b>Test Sample</b>	G-Link-200 Accelerometer		
<b>Model Number</b>	G-Link-200-8G	<b>Serial No.</b>	6305-6000-6003
<b>Operating Mode</b>	Transmitting modulated signal at 2.405 GHz		
<b>Test Specification</b>	FCC Part 15, Subpart C Paragraph: 15.247 (b)(3)		
<b>Technician</b>	M. Seamans	<b>Date</b>	March 7 <sup>th</sup> , 2017
<b>Climatic Conditions</b>	Temp: 19.5 °C    Relative Humidity: 19.3 %		
<b>Notes</b>	Peak Power Output: 18.27 dBm		

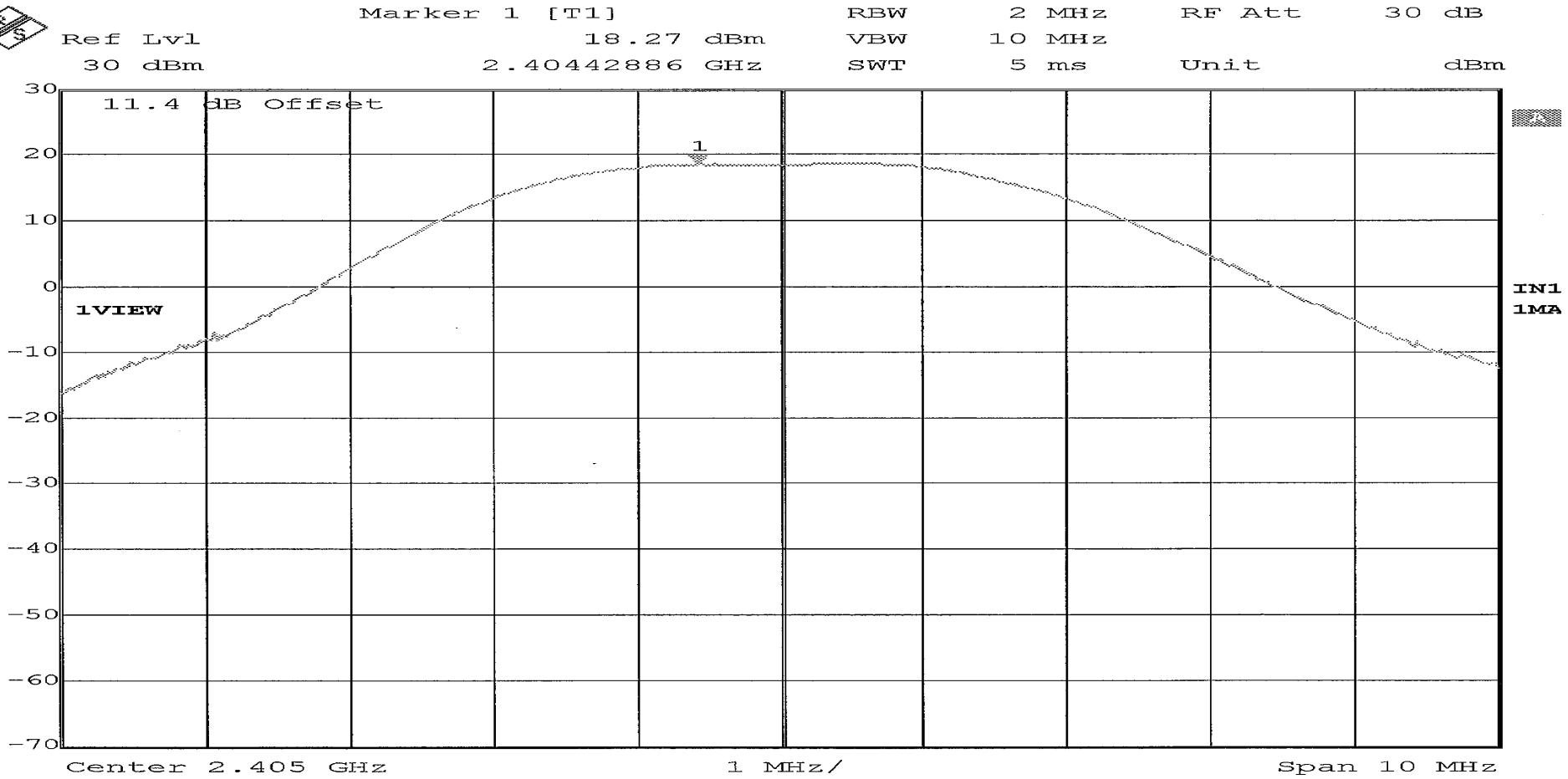

# RETLIF TESTING LABORATORIES

<b>Test Method:</b>	Conducted Peak Power Output		
<b>Customer</b>	Lord Corporation	<b>Job No.</b>	R-6179N-1
<b>Test Sample</b>	G-Link-200 Accelerometer		
<b>Model Number</b>	G-Link-200-8G	<b>Serial No.</b>	6305-6000-6003
<b>Operating Mode</b>	Transmitting modulated signal at 2.440 GHz		
<b>Test Specification</b>	FCC Part 15, Subpart C Paragraph: 15.247 (b)(3)		
<b>Technician</b>	M. Seamans	<b>Date</b>	March 7 <sup>th</sup> , 2017
<b>Climatic Conditions</b>	Temp: 19.5 °C    Relative Humidity: 19.3 %		
<b>Notes</b>	Peak Power Output: 18.40 dBm		

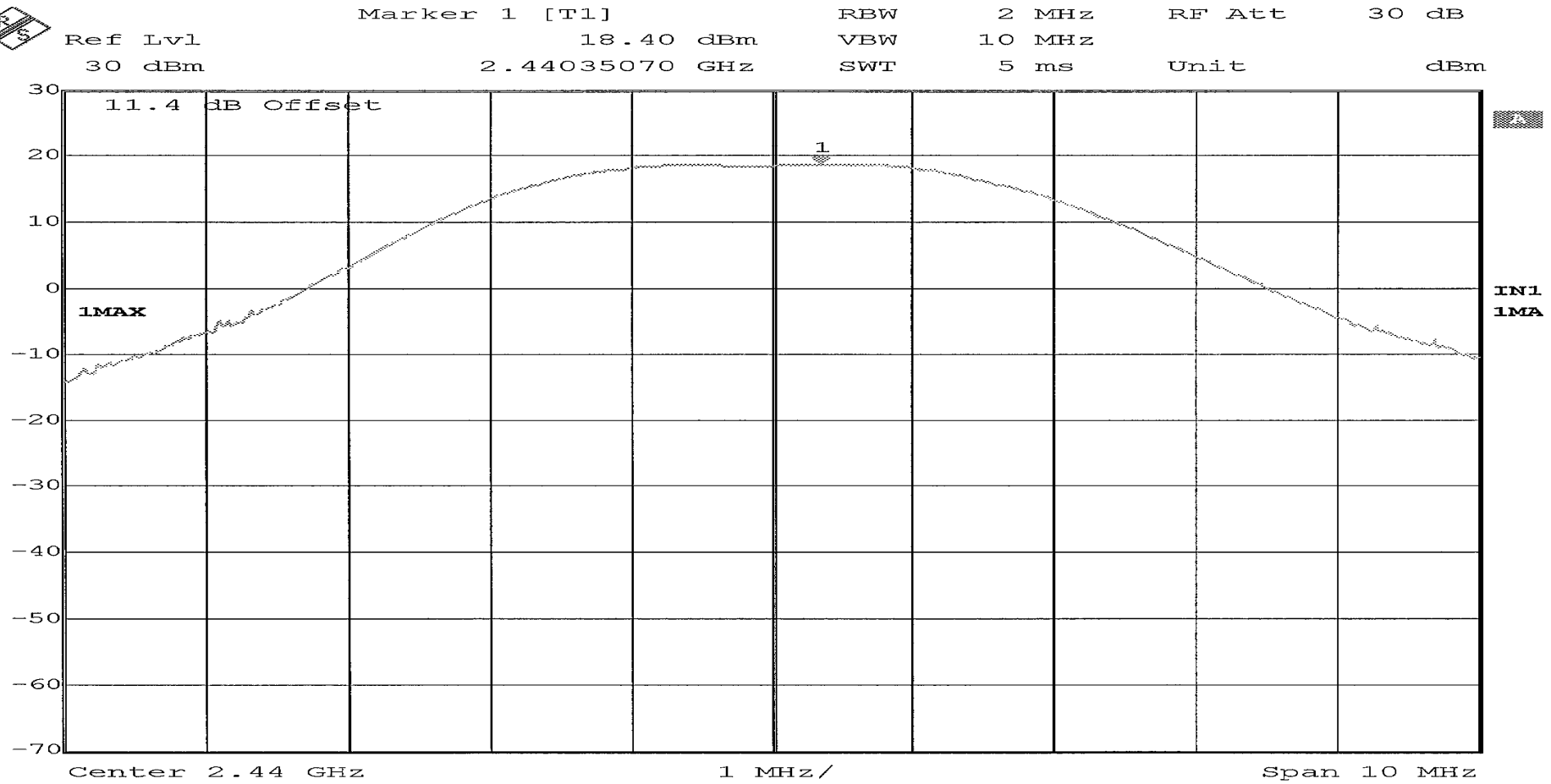

# RETLIF TESTING LABORATORIES

<b>Test Method:</b>	Conducted Peak Power Output		
<b>Customer</b>	Lord Corporation	<b>Job No.</b>	R-6179N-1
<b>Test Sample</b>	G-Link-200 Accelerometer		
<b>Model Number</b>	G-Link-200-8G	<b>Serial No.</b>	6305-6000-6003
<b>Operating Mode</b>	Transmitting modulated signal at 2.480GHz		
<b>Test Specification</b>	FCC Part 15, Subpart C Paragraph: 15.247 (b)(3)		
<b>Technician</b>	M. Seamans	<b>Date</b>	March 7 <sup>th</sup> , 2017
<b>Climatic Conditions</b>	Temp: 19.5 °C    Relative Humidity: 19.3 %		
<b>Notes</b>	Peak Power Output: 18.15 dBm		



Marker 1 [T1]                      RBW            2 MHz            RF Att            30 dB  
 Ref Lvl                                    18.15 dBm            VBW            10 MHz  
 30 dBm                                    2.47934870 GHz            SWT            5 ms            Unit            dBm

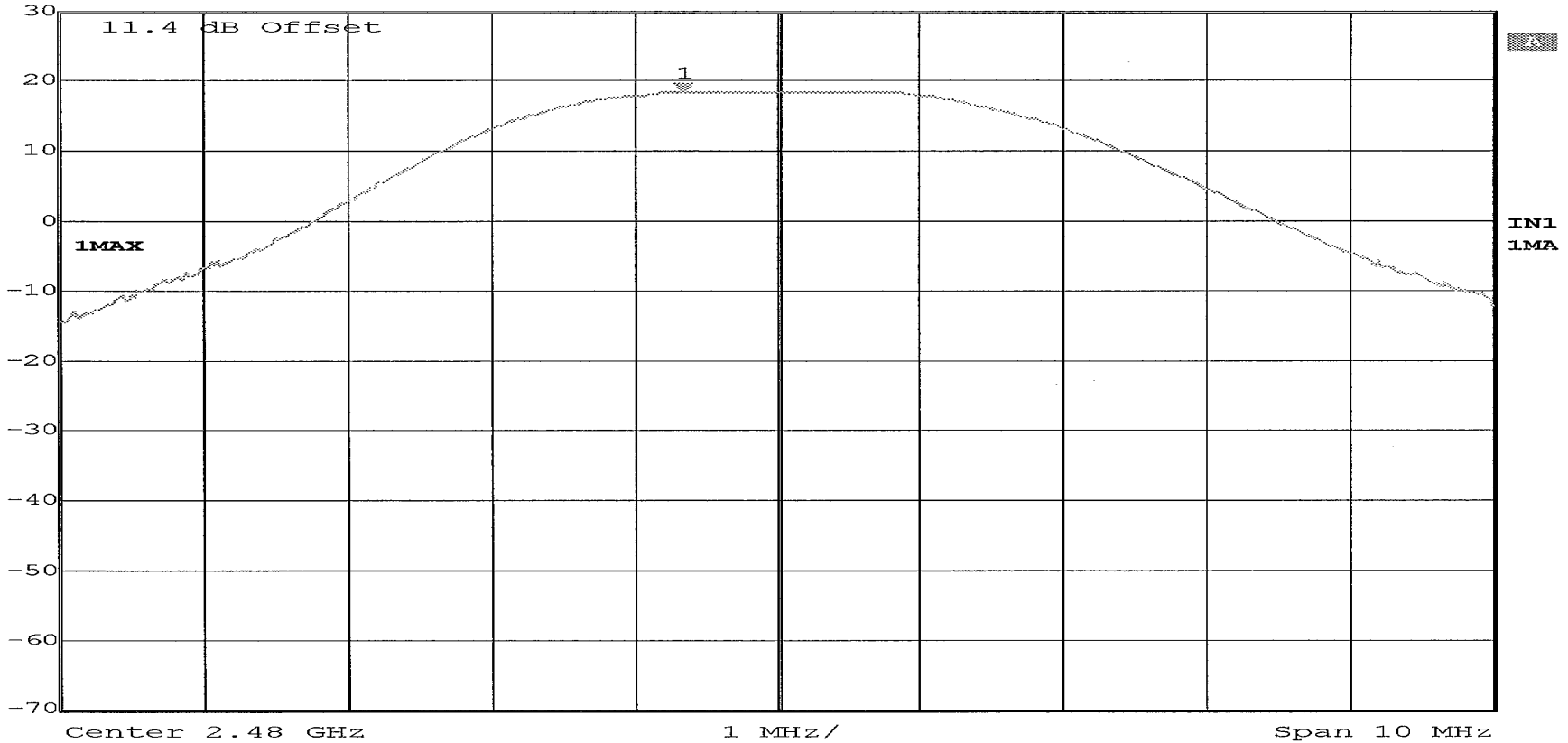

**Test Photographs**  
**Antenna Terminal Out of Band/Band Edge Conducted Emissions (30 MHz to 25 GHz)**



Test Setup



**Retlif Testing Laboratories**

Report No. R-6179N-1

**FCC Section 15.247 (d)**  
**Antenna Terminal Out of Band/Band Edge Conducted Emissions (30 MHz to 25 GHz)**  
**Test Data**



**Retlif Testing Laboratories**

Report No. R-6179N-1

**Out of Band Conducted Emissions  
Test Data**



**Retlif Testing Laboratories**

Report No. R-6179N-1



# RETLIF TESTING LABORATORIES

<b>Test Method:</b>	Out of Band Conducted Emissions 25 MHz to 25 GHz		
<b>Customer</b>	Lord Corporation	<b>Job No.</b>	R-6179N-1
<b>Test Sample</b>	G-Link-200 Accelerometer		
<b>Model Number</b>	G-Link-200-8G	<b>Serial No.</b>	6305-6000-6003
<b>Operating Mode</b>	Transmitting modulated signal at 2.405 GHz		
<b>Test Specification</b>	FCC Part 15, Subpart C Paragraph: 15.247 (d)		
<b>Technician</b>	M. Seamans	<b>Date</b>	March 15 <sup>th</sup> , 2017
<b>Climatic Conditions</b>	Temp: 19.3 °C     Relative Humidity: 20.3 %		
<b>Notes</b>	Limit: -5.93 dBm		

Agilent    09:32:49    Mar 15, 2017

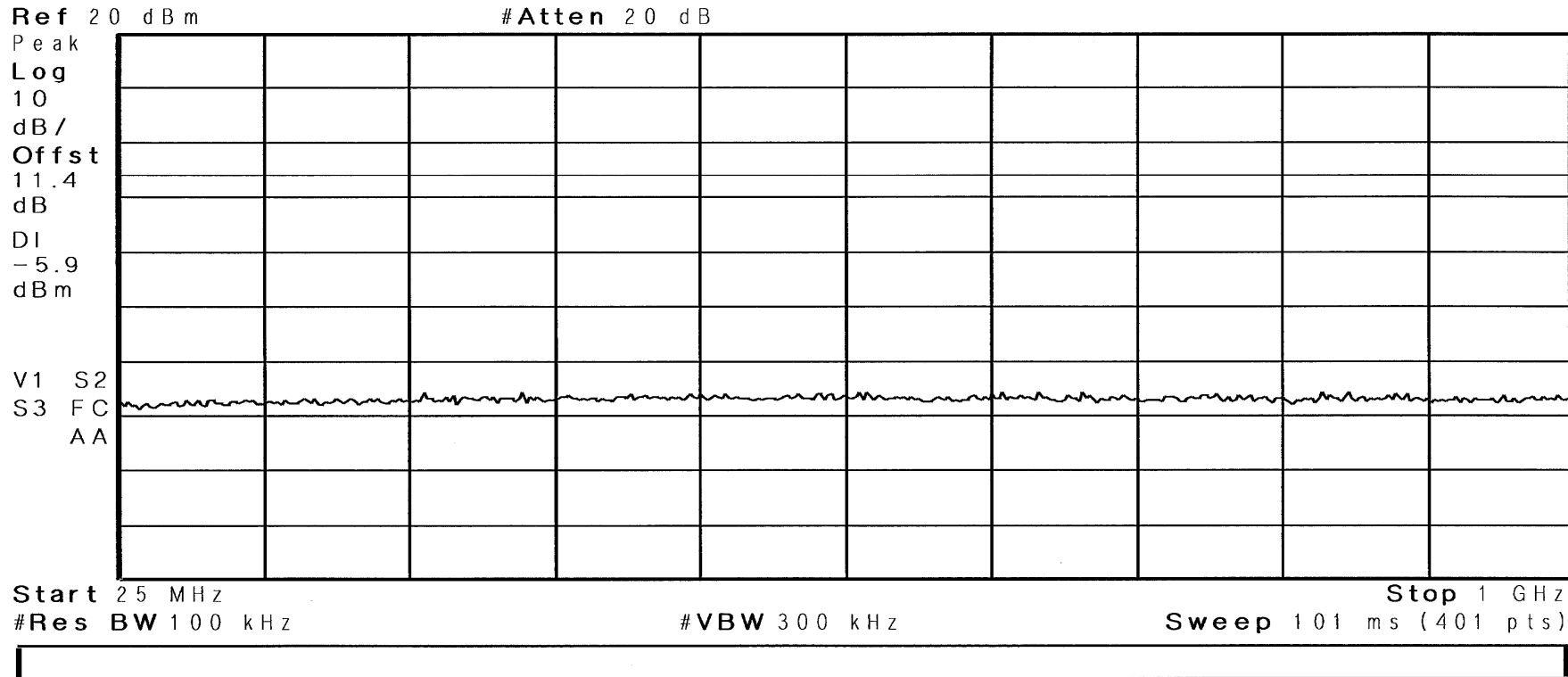



# RETLIF TESTING LABORATORIES

<b>Test Method:</b>	Out of Band Conducted Emissions 25 MHz to 25 GHz		
<b>Customer</b>	Lord Corporation	<b>Job No.</b>	R-6179N-1
<b>Test Sample</b>	G-Link-200 Accelerometer		
<b>Model Number</b>	G-Link-200-8G	<b>Serial No.</b>	6305-6000-6003
<b>Operating Mode</b>	Transmitting modulated signal at 2.440 GHz		
<b>Test Specification</b>	FCC Part 15, Subpart C Paragraph: 15.247 (d)		
<b>Technician</b>	M. Seamans	<b>Date</b>	March 15 <sup>th</sup> , 2017
<b>Climatic Conditions</b>	Temp: 19.3 °C    Relative Humidity: 20.3 %		
<b>Notes</b>	Limit: -5.93 dBm		

**Agilent**    09:20:09    Mar 15, 2017

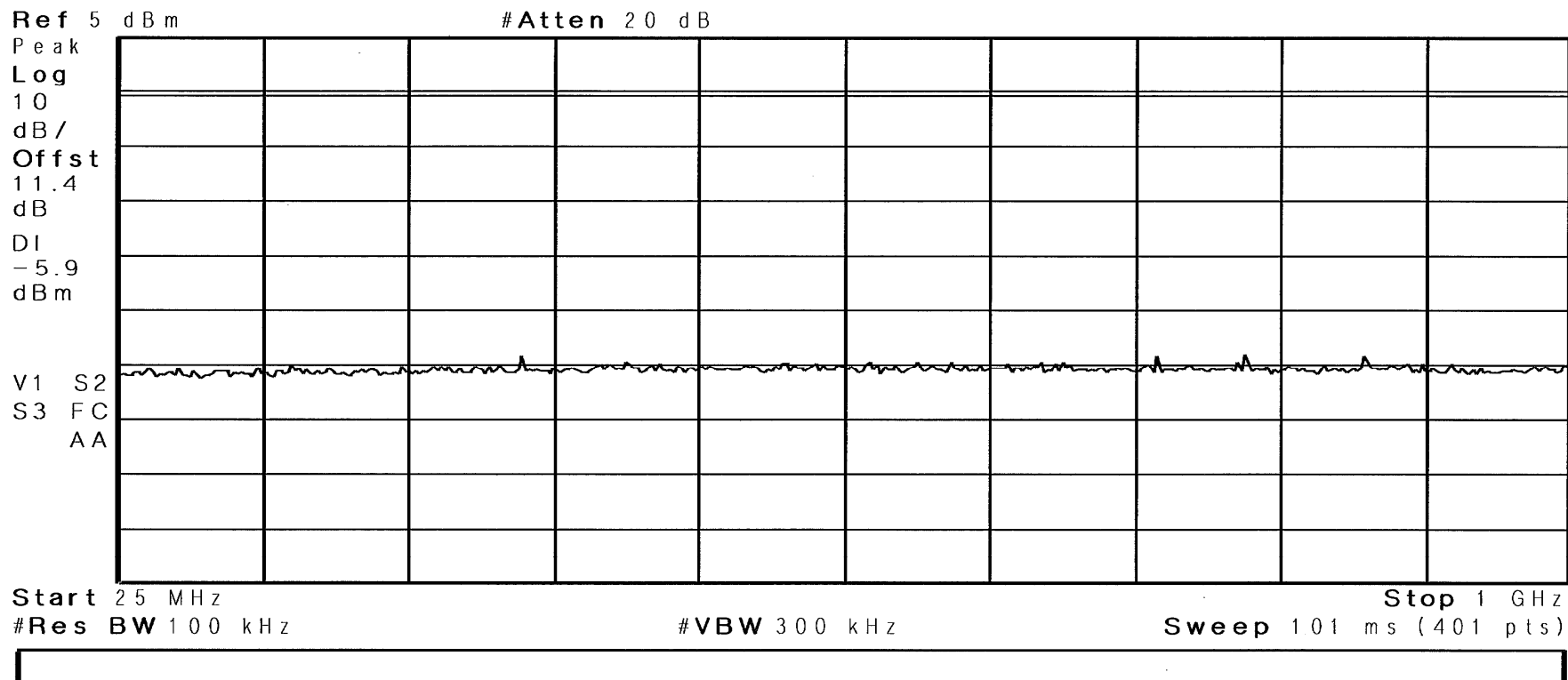

# RETLIF TESTING LABORATORIES

<b>Test Method:</b>	Out of Band Conducted Emissions 25 MHz to 25 GHz		
<b>Customer</b>	Lord Corporation	<b>Job No.</b>	R-6179N-1
<b>Test Sample</b>	G-Link-200 Accelerometer		
<b>Model Number</b>	G-Link-200-8G	<b>Serial No.</b>	6305-6000-6003
<b>Operating Mode</b>	Transmitting modulated signal at 2.440 GHz		
<b>Test Specification</b>	FCC Part 15, Subpart C Paragraph: 15.247 (d)		
<b>Technician</b>	M. Seamans	<b>Date</b>	March 15 <sup>th</sup> , 2017
<b>Climatic Conditions</b>	Temp: 19.3 °C Relative Humidity: 20.3 %		
<b>Notes</b>	Limit: -5.93 dBm		

Agilent 09:22:04 Mar 15, 2017

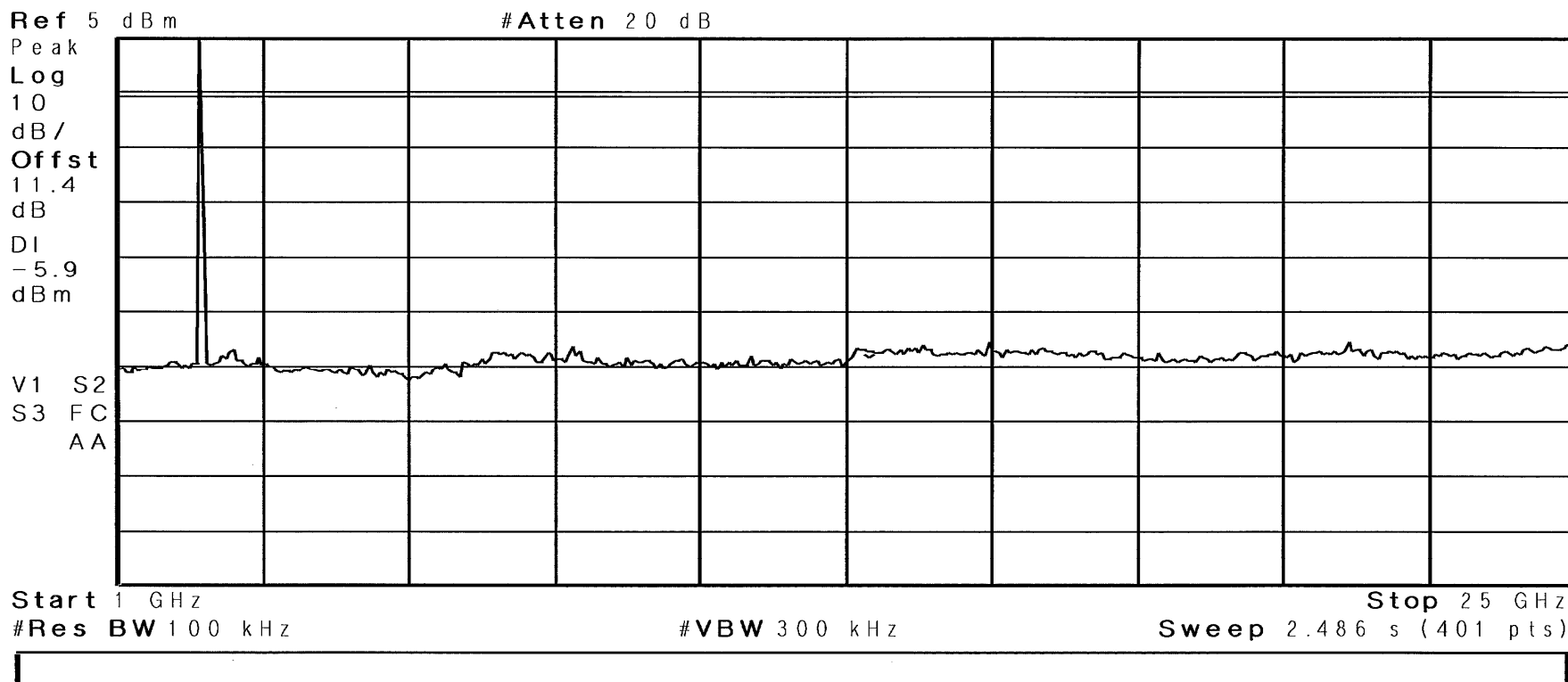

# RETLIF TESTING LABORATORIES

<b>Test Method:</b>	Out of Band Conducted Emissions 25 MHz to 25 GHz		
<b>Customer</b>	Lord Corporation	<b>Job No.</b>	R-6179N-1
<b>Test Sample</b>	G-Link-200 Accelerometer		
<b>Model Number</b>	G-Link-200-8G	<b>Serial No.</b>	6305-6000-6003
<b>Operating Mode</b>	Transmitting modulated signal at 2.480 GHz		
<b>Test Specification</b>	FCC Part 15, Subpart C Paragraph: 15.247 (d)		
<b>Technician</b>	M. Seamans	<b>Date</b>	March 15 <sup>th</sup> , 2017
<b>Climatic Conditions</b>	Temp: 19.3 °C    Relative Humidity: 20.3 %		
<b>Notes</b>	Limit: -5.93 dBm		

**Agilent**    09:13:25    Mar 15, 2017

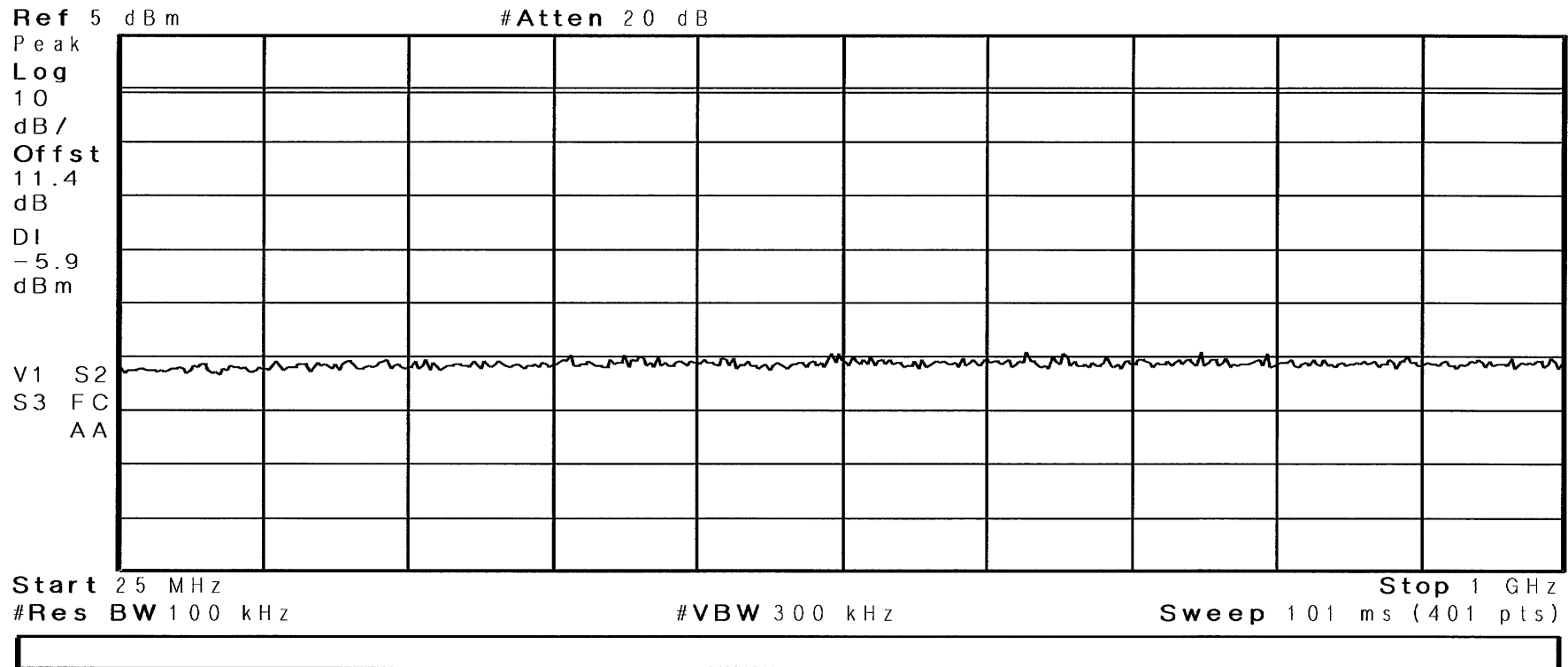

# RETLIF TESTING LABORATORIES

<b>Test Method:</b>	Out of Band Conducted Emissions 25 MHz to 25 GHz		
<b>Customer</b>	Lord Corporation	<b>Job No.</b>	R-6179N-1
<b>Test Sample</b>	G-Link-200 Accelerometer		
<b>Model Number</b>	G-Link-200-8G	<b>Serial No.</b>	6305-6000-6003
<b>Operating Mode</b>	Transmitting modulated signal at 2.480 GHz		
<b>Test Specification</b>	FCC Part 15, Subpart C Paragraph: 15.247 (d)		
<b>Technician</b>	M. Seamans	<b>Date</b>	March 15 <sup>th</sup> , 2017
<b>Climatic Conditions</b>	Temp: 19.3 °C    Relative Humidity: 20.3 %		
<b>Notes</b>	Limit: -5.93 dBm		

**Agilent**    09:12:17    Mar 15, 2017

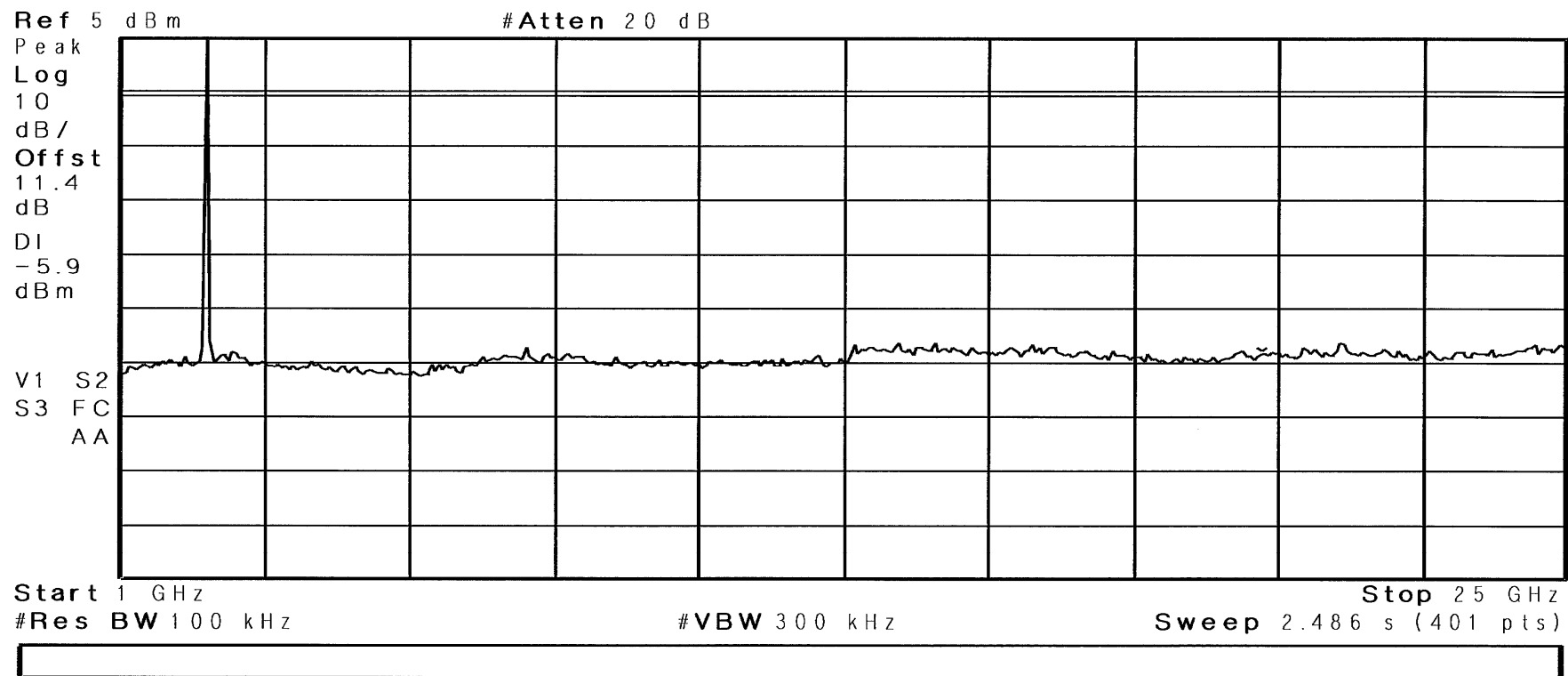

**Band Edge Conducted  
Test Data**



**Retlif Testing Laboratories**

Report No. R-6179N-1

# RETLIF TESTING LABORATORIES

<b>Test Method:</b>	Band Edge Conducted		
<b>Customer</b>	Lord Corporation	<b>Job No.</b>	R-6179N-1
<b>Test Sample</b>	G-Link-200 Accelerometer		
<b>Model Number</b>	G-Link-200-8G	<b>Serial No.</b>	6305-6000-6003
<b>Operating Mode</b>	Transmitting modulated signal at 2.405 GHz		
<b>Test Specification</b>	FCC Part 15, Subpart C Paragraph: 15.247 (d)		
<b>Technician</b>	M. Seamans	<b>Date</b>	March 15 <sup>th</sup> , 2017
<b>Climatic Conditions</b>	Temp: 19.3 °C    Relative Humidity: 20.3 %		
<b>Notes</b>	Limit: -5.93 dBm		

**Agilent**    09:23:13    Mar 15, 2017

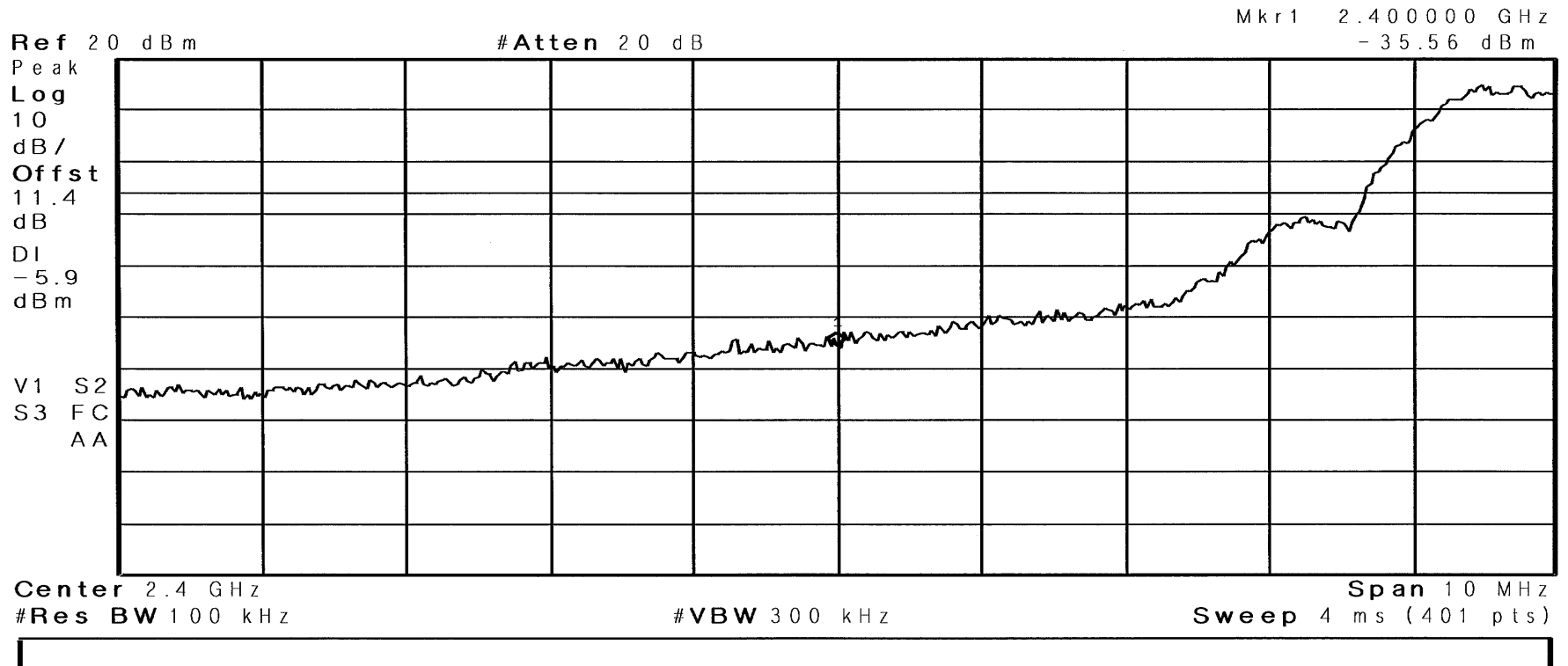



# RETLIF TESTING LABORATORIES

<b>Test Method:</b>	Band Edge Conducted		
<b>Customer</b>	Lord Corporation	<b>Job No.</b>	R-6179N-1
<b>Test Sample</b>	G-Link-200 Accelerometer		
<b>Model Number</b>	G-Link-200-8G	<b>Serial No.</b>	6305-6000-6003
<b>Operating Mode</b>	Transmitting modulated signal at 2.480GHz		
<b>Test Specification</b>	FCC Part 15, Subpart C Paragraph: 15.247 (d)		
<b>Technician</b>	M. Seamans	<b>Date</b>	March 7 <sup>th</sup> , 2017
<b>Climatic Conditions</b>	Temp: 19.3 °C    Relative Humidity: 20.3 %		
<b>Notes</b>	Limit: -5.93 dBm		

Agilent 09:31:16 Mar 15, 2017

Mkr1 2.483500 GHz  
-26.9 dBm

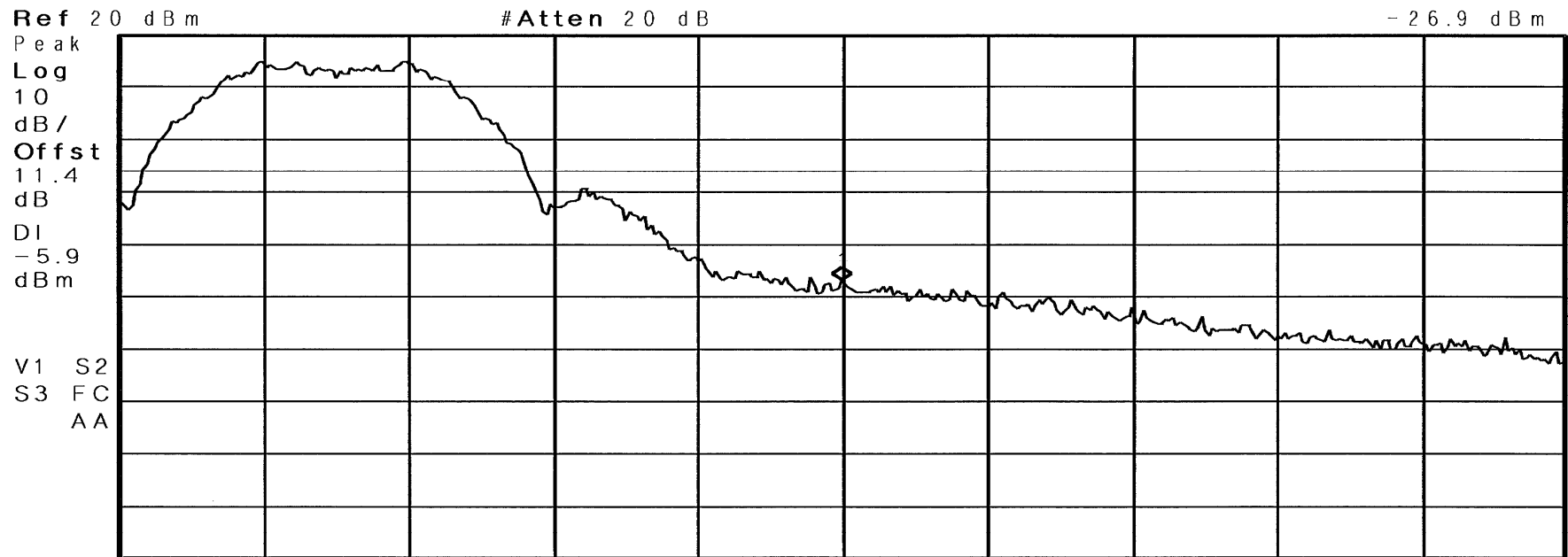

Center 2.483 GHz      #Res BW 100 kHz      #VBW 300 kHz      Span 10 MHz  
Sweep 4 ms (401 pts)

**Test Photographs**  
**Spurious Radiated Emissions (30 MHz to 25 GHz)**



Test Setup



**Retlif Testing Laboratories**

Report No. R-6179N-1

**Test Photographs**  
**Spurious Radiated Emissions (30 MHz to 25 GHz)**



Horizontal Antenna Polarization, 30 MHz to 200 MHz, Biconical Antenna



Vertical Antenna Polarization, 30 MHz to 200 MHz, Biconical Antenna



**Retlif Testing Laboratories**

Report No. R-6179N-1

**Test Photographs**  
**Spurious Radiated Emissions (30 MHz to 25 GHz)**



Horizontal Antenna Polarization, 200 MHz to 1 GHz, Log Periodic



Vertical Antenna Polarization, 200 MHz to 1 GHz, Log Periodic



**Retlif Testing Laboratories**

Report No. R-6179N-1

**Test Photographs**  
**Spurious Radiated Emissions (30 MHz to 25 GHz)**

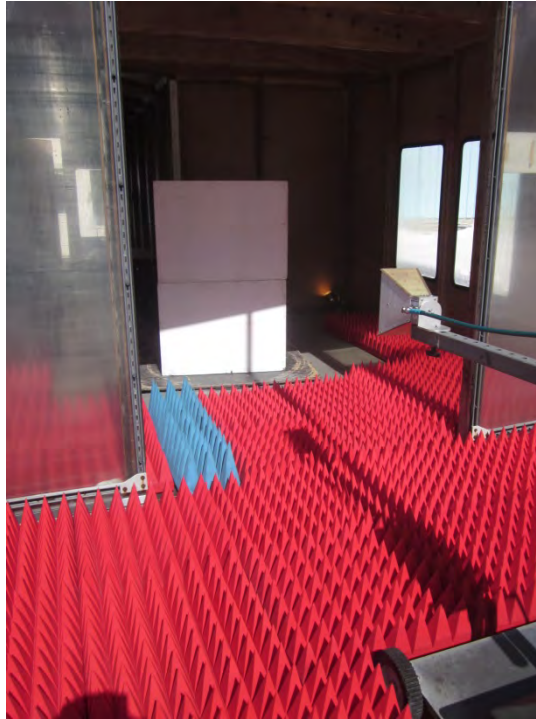

Horizontal Antenna Polarization, 1 GHz to 18 GHz

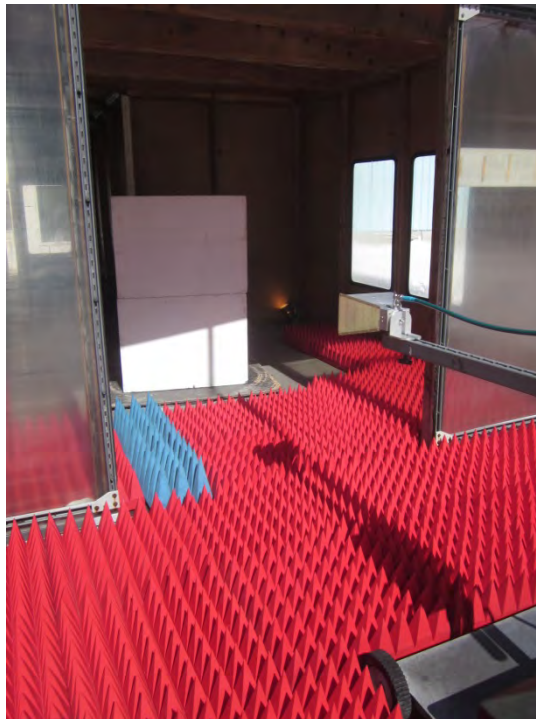

Vertical Antenna Polarization, 1 GHz to 18 GHz



**Retlif Testing Laboratories**

Report No. R-6179N-1

**Test Photographs**  
**Spurious Radiated Emissions (30 MHz to 25 GHz)**



Horizontal Antenna Polarization, 18 GHz to 25 GHz

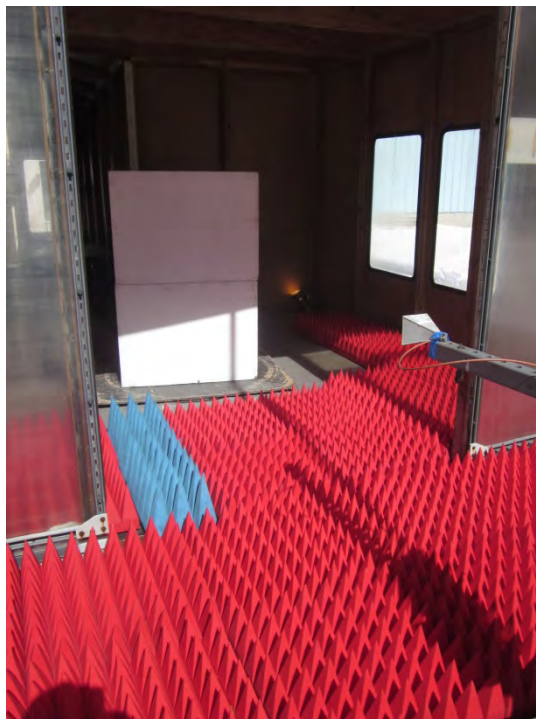

Vertical Antenna Polarization, 18 GHz to 25 GHz



**Retlif Testing Laboratories**

Report No. R-6179N-1

**FCC Section 15.247 (d)  
Spurious Radiated Emissions, 30 MHz to 25 GHz  
Test Data**



**Retlif Testing Laboratories**

Report No. R-6179N-1

# RETLIF TESTING LABORATORIES

## EMISSIONS TEST DATA SHEET

<b>Test Method</b>	Unwanted Emissions into Restricted Frequency Bands	
<b>Customer</b>	Lord Corporation	
<b>Job Number</b>	R-6179N-1	
<b>Test Sample</b>	G-Link-200 Accelerometer	
<b>Model Number</b>	G-Link-200-8G	
<b>Serial Number</b>	6305-6000-6009	
<b>Test Specification</b>	FCC Part 15 Subpart C	Paragraph: 15.247(d)
<b>Operating Mode</b>	Transmitting modulated signal at 2405 MHz, 2442 MHz and 2480 MHz consecutively.	
<b>Technician</b>	M. Seamans	
<b>Date</b>	March 16 <sup>th</sup> , 2017	

**Notes:** Antenna Test Distance: 3 meters      Detector: Quasi-Peak <1GHz, Average >1GHz

### TEST PARAMETERS

Restricted Band	Measured Frequency	Meter Reading	Correction Factor	Corrected Reading		Converted Reading	Limit at 3M
MHz	MHz	dBuV	dB	dBuV/m		uV/m	uV/m
37.50	-	-	-	-		-	100.00
	38.00	22.10	14.20	36.30	*	65.31	I
38.25	-	-	-	-		-	100.00
73.00	-	-	-	-		-	100.00
	74.00	22.84	8.36	31.20	*	36.31	I
74.60	-	-	-	-		-	100.00
74.80	-	-	-	-		-	100.00
	75.00	19.54	8.36	27.90	*	24.83	
75.20	-	-	-	-		-	100.00
108.00	-	-	-	-		-	150.00
	115.00	12.78	10.02	22.80	*	13.80	
	-	-	-	-		-	
121.94	-	-	-	-		-	150.00
123.00	-	-	-	-		-	150.00
	130.00	14.26	9.44	23.70	*	15.31	
	-	-	-	-		-	
138.00	-	-	-	-		-	150.00

No EUT emissions within 10 dB of the specified test limit were observed at the specified test distance throughout the given frequency spectrum.  
 \* This emission is not from the EUT. It is a measurement of minimum measurement system sensitivity (Noise Floor).

Data Sheet 1 of 7



**Retlif Testing Laboratories**

Report No. R-6179N-1



# RETLIF TESTING LABORATORIES

## EMISSIONS TEST DATA SHEET

<b>Test Method</b>	Unwanted Emissions into Restricted Frequency Bands	
<b>Customer</b>	Lord Corporation	
<b>Job Number</b>	R-6179N-1	
<b>Test Sample</b>	G-Link-200 Accelerometer	
<b>Model Number</b>	G-Link-200-8G	
<b>Serial Number</b>	6305-6000-6009	
<b>Test Specification</b>	FCC Part 15 Subpart C	Paragraph: 15.247(d)
<b>Operating Mode</b>	Transmitting modulated signal at 2405 MHz, 2442 MHz and 2480 MHz consecutively.	
<b>Technician</b>	M. Seamans	
<b>Date</b>	March 16 <sup>th</sup> , 2017	

**Notes:** Antenna Test Distance: 3 meters      Detector: Quasi-Peak <1GHz, Average >1GHz

### TEST PARAMETERS

Restricted Band	Measured Frequency	Meter Reading	Correction Factor	Corrected Reading			Converted Reading	Limit at 3M
MHz	MHz	dBuV	dB	dBuV/m			uV/m	uV/m
149.90	-	-	-	-			-	150.00
	150.00	15.43	11.17	26.60	*		21.38	
150.05	-	-	-	-			-	150.00
156.52	-	-	-	-			-	150.00
	156.52	13.82	12.08	25.90	*		19.72	
156.52	-	-	-	-			-	150.00
156.70	-	-	-	-			-	150.00
	156.80	12.08	12.12	24.20	*		16.22	
156.90	-	-	-	-			-	150.00
162.01	-	-	-	-			-	150.00
	165.00	9.92	12.68	22.60	*		13.49	
167.17	-	-	-	-			-	150.00
167.72	-	-	-	-			-	150.00
	170.00	9.60	12.80	22.40	*		13.18	
173.20	-	-	-	-			-	150.00

No EUT emissions within 10 dB of the specified test limit were observed at the specified test distance throughout the given frequency spectrum.  
 \* This emission is not from the EUT. It is a measurement of minimum measurement system sensitivity (Noise Floor).

Data Sheet 2 of 7



**Retlif Testing Laboratories**

Report No. R-6179N-1

# RETLIF TESTING LABORATORIES

## EMISSIONS TEST DATA SHEET

<b>Test Method</b>	Unwanted Emissions into Restricted Frequency Bands	
<b>Customer</b>	Lord Corporation	
<b>Job Number</b>	R-6179N-1	
<b>Test Sample</b>	G-Link-200 Accelerometer	
<b>Model Number</b>	G-Link-200-8G	
<b>Serial Number</b>	6305-6000-6009	
<b>Test Specification</b>	FCC Part 15 Subpart C	Paragraph: 15.247(d)
<b>Operating Mode</b>	Transmitting modulated signal at 2405 MHz, 2442 MHz and 2480 MHz consecutively.	
<b>Technician</b>	M. Seamans	
<b>Date</b>	March 16 <sup>th</sup> , 2017	

**Notes:** Antenna Test Distance: 3 meters      Detector: Quasi-Peak <1GHz, Average >1GHz

### TEST PARAMETERS

Restricted Band	Measured Frequency	Meter Reading	Correction Factor	Corrected Reading			Converted Reading	Limit at 3M
MHz	MHz	dBuV	dB	dBuV/m			uV/m	uV/m
240.00	-	-	-	-			-	200.00
	260.00	0.16	16.85	17.01	*		7.09	
285.00	-	-	-	-			-	200.00
322.80	-	-	-	-			-	200.00
	330.00	0.93	18.91	19.84	*		9.82	
335.40	-	-	-	-			-	200.00
399.90	-	-	-	-			-	200.00
	405.00	-1.82	21.49	19.67	*		9.63	
410.00	-	-	-	-			-	200.00
608.00	-	-	-	-			-	200.00
	611.00	-1.60	27.34	25.74	*		19.36	
614.00	-	-	-	-			-	200.00
960.00	-	-	-	-			-	500.00
	975.00	1.37	32.10	33.47	*		47.15	
1240.00	-	-	-	-			-	500.00
1300.00	-	-	-	-			-	500.00
	1350.00	32.82	-5.55	27.27	*		23.09	
1427.00	-	-	-	-			-	500.00

EUT emissions observed throughout the given frequency spectrum were recorded and evaluated. Emission levels closest to the limit are listed on this data sheet. \* This emission is not from the EUT. It is a measurement of minimum measurement system sensitivity (Noise Floor).

Data Sheet 3 of 7



**Retlif Testing Laboratories**

Report No. R-6179N-1

# RETLIF TESTING LABORATORIES

## EMISSIONS TEST DATA SHEET

<b>Test Method</b>	Unwanted Emissions into Restricted Frequency Bands	
<b>Customer</b>	Lord Corporation	
<b>Job Number</b>	R-6179N-1	
<b>Test Sample</b>	G-Link-200 Accelerometer	
<b>Model Number</b>	G-Link-200-8G	
<b>Serial Number</b>	6305-6000-6009	
<b>Test Specification</b>	FCC Part 15 Subpart C	Paragraph: 15.247(d)
<b>Operating Mode</b>	Transmitting modulated signal at 2405 MHz, 2442 MHz and 2480 MHz consecutively.	
<b>Technician</b>	M. Seamans	
<b>Date</b>	March 16 <sup>th</sup> , 2017	

**Notes:** Antenna Test Distance: 3 meters      Detector: Quasi-Peak <1GHz, Average >1GHz

### TEST PARAMETERS

Restricted Band	Measured Frequency	Meter Reading	Correction Factor	Corrected Reading			Converted Reading	Limit at 3M
MHz	MHz	dBuV	dB	dBuV/m			uV/m	uV/m
1435.00	-	-	-	-			-	500.00
	1500.00	32.15	-4.81	27.34	*		23.28	
1646.50	-	-	-	-			-	500.00
1660.00	-	-	-	-			-	500.00
	1680.00	31.76	-4.01	27.75	*		24.41	
1710.00	-	-	-	-			-	500.00
1718.80	-	-	-	-			-	500.00
	1720.00	31.57	-3.84	27.73	*		24.35	
1722.20	-	-	-	-			-	500.00
2200.00	-	-	-	-			-	500.00
	2250.00	31.64	-2.07	29.57	*		30.10	
2300.00	-	-	-	-			-	500.00
2310.00	-	-	-	-			-	500.00
	2360.00	31.55	-1.79	29.76	*		30.76	
2390.00	-	-	-	-			-	500.00
2483.50	-	-	-	-			-	500.00
	2490.00	31.12	-1.47	29.65	*		30.37	
2500.00	-	-	-	-			-	500.00

No EUT emissions within 10 dB of the specified test limit were observed at the specified test distance throughout the given frequency spectrum.  
 \* This emission is not from the EUT. It is a measurement of minimum measurement system sensitivity (Noise Floor).

Data Sheet 4 of 7



**Retlif Testing Laboratories**

Report No. R-6179N-1

# RETLIF TESTING LABORATORIES

## EMISSIONS TEST DATA SHEET

<b>Test Method</b>	Unwanted Emissions into Restricted Frequency Bands	
<b>Customer</b>	Lord Corporation	
<b>Job Number</b>	R-6179N-1	
<b>Test Sample</b>	G-Link-200 Accelerometer	
<b>Model Number</b>	G-Link-200-8G	
<b>Serial Number</b>	6305-6000-6009	
<b>Test Specification</b>	FCC Part 15 Subpart C	Paragraph: 15.247(d)
<b>Operating Mode</b>	Transmitting modulated signal at 2405 MHz, 2442 MHz and 2480 MHz consecutively.	
<b>Technician</b>	M. Seamans	
<b>Date</b>	March 16 <sup>th</sup> , 2017	

**Notes:** Antenna Test Distance: 3 meters      Detector: Quasi-Peak <1GHz, Average >1GHz

### TEST PARAMETERS

Restricted Band	Measured Frequency	Meter Reading	Correction Factor	Corrected Reading		Converted Reading	Limit at 3M
MHz	MHz	dBuV	dB	dBuV/m		uV/m	uV/m
2690.00	-	-	-	-		-	500.00
	-	-	-	-		-	
	2750.00	31.44	-0.88	30.56	*	33.73	
	-	-	-	-		-	
2900.00	-	-	-	-		-	500.00
3260.00	-	-	-	-		-	500.00
	3263.00	30.27	0.11	30.38	*	33.04	
3267.00	-	-	-	-		-	500.00
3332.00	-	-	-	-		-	500.00
	3336.00	30.70	0.23	30.93	*	35.20	
3339.00	-	-	-	-		-	500.00
3345.00	-	-	-	-		-	500.00
	3350.00	30.82	0.26	31.08	*	35.81	
3358.00	-	-	-	-		-	500.00
3600.00	-	-	-	-		-	500.00
	-	-	-	-		-	
	3700.00	29.87	0.81	30.68	*	34.20	
	-	-	-	-		-	

EUT emissions observed throughout the given frequency spectrum were recorded and evaluated. Emission levels closest to the limit are listed on this data sheet. \* This emission is not from the EUT. It is a measurement of minimum measurement system sensitivity (Noise Floor).

Data Sheet 5 of 7



**Retlif Testing Laboratories**

Report No. R-6179N-1

# RETLIF TESTING LABORATORIES

## EMISSIONS TEST DATA SHEET

<b>Test Method</b>	Unwanted Emissions into Restricted Frequency Bands	
<b>Customer</b>	Lord Corporation	
<b>Job Number</b>	R-6179N-1	
<b>Test Sample</b>	G-Link-200 Accelerometer	
<b>Model Number</b>	G-Link-200-8G	
<b>Serial Number</b>	6305-6000-6009	
<b>Test Specification</b>	FCC Part 15 Subpart C	Paragraph: 15.247(d)
<b>Operating Mode</b>	Transmitting modulated signal at 2405 MHz, 2442 MHz and 2480 MHz consecutively.	
<b>Technician</b>	M. Seamans	
<b>Date</b>	March 16 <sup>th</sup> , 2017	

**Notes:** Antenna Test Distance: 3 meters      Detector: Quasi-Peak <1GHz, Average >1GHz

### TEST PARAMETERS

Restricted Band MHz	Measured Frequency MHz	Meter Reading dBuV	Correction Factor dB	Corrected Reading dBuV/m			Converted Reading uV/m	Limit at 3M uV/m
	-	-	-	-			-	
4400.00	-	-	-	-			-	500.00
4500.00	-	-	-	-			-	500.00
	4800.00	30.02	2.07	32.09	*		40.23	
	-	-	-	-			-	
5150.00	-	-	-	-			-	500.00
5350.00	-	-	-	-			-	500.00
	5400.00	29.58	2.70	32.28	*		42.56	
5460.00	-	-	-	-			-	500.00
7250.00	-	-	-	-			-	500.00
	7440.00	30.61	3.46	34.07	*		50.52	
7750.00	-	-	-	-			-	500.00
8025.00	-	-	-	-			-	500.00
	8300.00	30.27	4.45	34.72	*		54.45	
8500.00	-	-	-	-			-	500.00
9000.00	-	-	-	-			-	500.00
	9100.00	30.88	4.85	35.73	*		61.16	
9200.00	-	-	-	-			-	500.00

EUT emissions observed throughout the given frequency spectrum were recorded and evaluated. Emission levels closest to the limit are listed on this data sheet. \* This emission is not from the EUT. It is a measurement of minimum measurement system sensitivity (Noise Floor).

Data Sheet 6 of 7



**Retlif Testing Laboratories**

Report No. R-6179N-1

# RETLIF TESTING LABORATORIES

## EMISSIONS TEST DATA SHEET

<b>Test Method</b>	Unwanted Emissions into Restricted Frequency Bands	
<b>Customer</b>	Lord Corporation	
<b>Job Number</b>	R-6179N-1	
<b>Test Sample</b>	G-Link-200 Accelerometer	
<b>Model Number</b>	G-Link-200-8G	
<b>Serial Number</b>	6305-6000-6009	
<b>Test Specification</b>	FCC Part 15 Subpart C	Paragraph: 15.247(d)
<b>Operating Mode</b>	Transmitting modulated signal at 2405 MHz, 2442 MHz and 2480 MHz consecutively.	
<b>Technician</b>	M. Seamans	
<b>Date</b>	March 16 <sup>th</sup> , 2017	

**Notes:** Antenna Test Distance: 3 meters      Detector: Quasi-Peak <1GHz, Average >1GHz

### TEST PARAMETERS

Restricted Band	Measured Frequency	Meter Reading	Correction Factor	Corrected Reading		Converted Reading	Limit at 3M
MHz	MHz	dBuV	dB	dBuV/m		uV/m	uV/m
9300.00	-	-	-	-		-	500.00
	9400.00	30.88	5.12	36.00	*	63.10	
9500.00	-	-	-	-		-	500.00
10600.00	-	-	-	-		-	500.00
	12200.00	31.41	7.45	38.86	*	87.70	
12700.00	-	-	-	-		-	500.00
13250.00	-	-	-	-		-	500.00
	15800.00	31.96	9.56	41.52	*	119.12	
16200.00	-	-	-	-		-	500.00
17700.00	-	-	-	-		-	500.00
	19240.00	33.19	-6.50	26.69	*	21.60	
21400.00	-	-	-	-		-	500.00
22010.00	-	-	-	-		-	500.00
	22320.00	33.45	-6.00	27.45	*	23.58	
23120.00	-	-	-	-		-	500.00
23000.00	-	-	-	-		-	500.00
	23800.00	33.68	-4.40	29.28	*	29.11	
24000.00	-	-	-	-		-	500.00

EUT emissions observed throughout the given frequency spectrum were recorded and evaluated. Emission levels closest to the limit are listed on this data sheet. \* This emission is not from the EUT. It is a measurement of minimum measurement system sensitivity (Noise Floor).

Data Sheet 7 of 7



**Retlif Testing Laboratories**

Report No. R-6179N-1

## Test Photographs Power Density



Test Configuration



**Retlif Testing Laboratories**

Report No. R-6179N-1

**FCC Section 15.247(e)  
Power Density  
Test Data**



**Retlif Testing Laboratories**

Report No. R-6179N-1



# RETLIF TESTING LABORATORIES

<b>Test Method:</b>	Power Spectral Density		
<b>Customer</b>	Lord Corporation	<b>Job No.</b>	R-6179N-1
<b>Test Sample</b>	G-Link-200 Accelerometer		
<b>Model Number</b>	G-Link-200-8G	<b>Serial No.</b>	6305-6000-6003
<b>Operating Mode</b>	Transmitting modulated signal at 2.405 GHz		
<b>Test Specification</b>	FCC Part 15, Subpart C Paragraph: 15.247 (e)		
<b>Technician</b>	M. Seamans	<b>Date</b>	March 7 <sup>th</sup> , 2017
<b>Climatic Conditions</b>	Temp: 19.4 °C    Relative Humidity: 19.4 %		
<b>Notes</b>	Power Spectral Density: 2.74 dBm    Limit: 8 dBm		



Marker 1 [T1]                      RBW            3 kHz            RF Att            30 dB  
 Ref Lvl                                      2.74 dBm            VBW            10 kHz  
 30 dBm                                      2.40542886 GHz            SWT            1.15 s            Unit            dBm

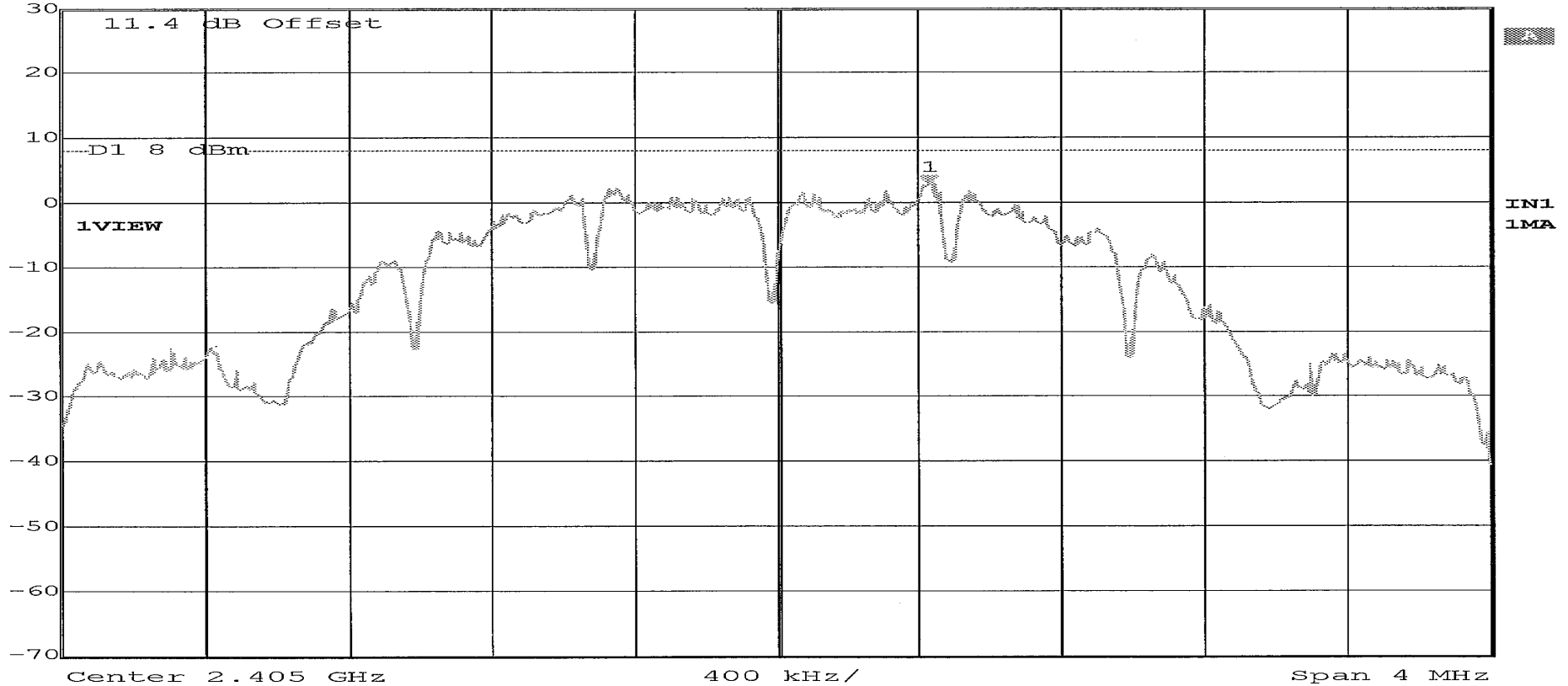

# RETLIF TESTING LABORATORIES

<b>Test Method:</b>	Power Spectral Density		
<b>Customer</b>	Lord Corporation	<b>Job No.</b>	R-6179N-1
<b>Test Sample</b>	G-Link-200 Accelerometer		
<b>Model Number</b>	G-Link-200-8G	<b>Serial No.</b>	6305-6000-6003
<b>Operating Mode</b>	Transmitting modulated signal at 2.440 GHz		
<b>Test Specification</b>	FCC Part 15, Subpart C Paragraph: 15.247 (e)		
<b>Technician</b>	M. Seamans	<b>Date</b>	March 7 <sup>th</sup> , 2017
<b>Climatic Conditions</b>	Temp: 19.4 °C    Relative Humidity: 19.4 %		
<b>Notes</b>	Power Spectral Density: 2.77 dBm    Limit: 8 dBm		

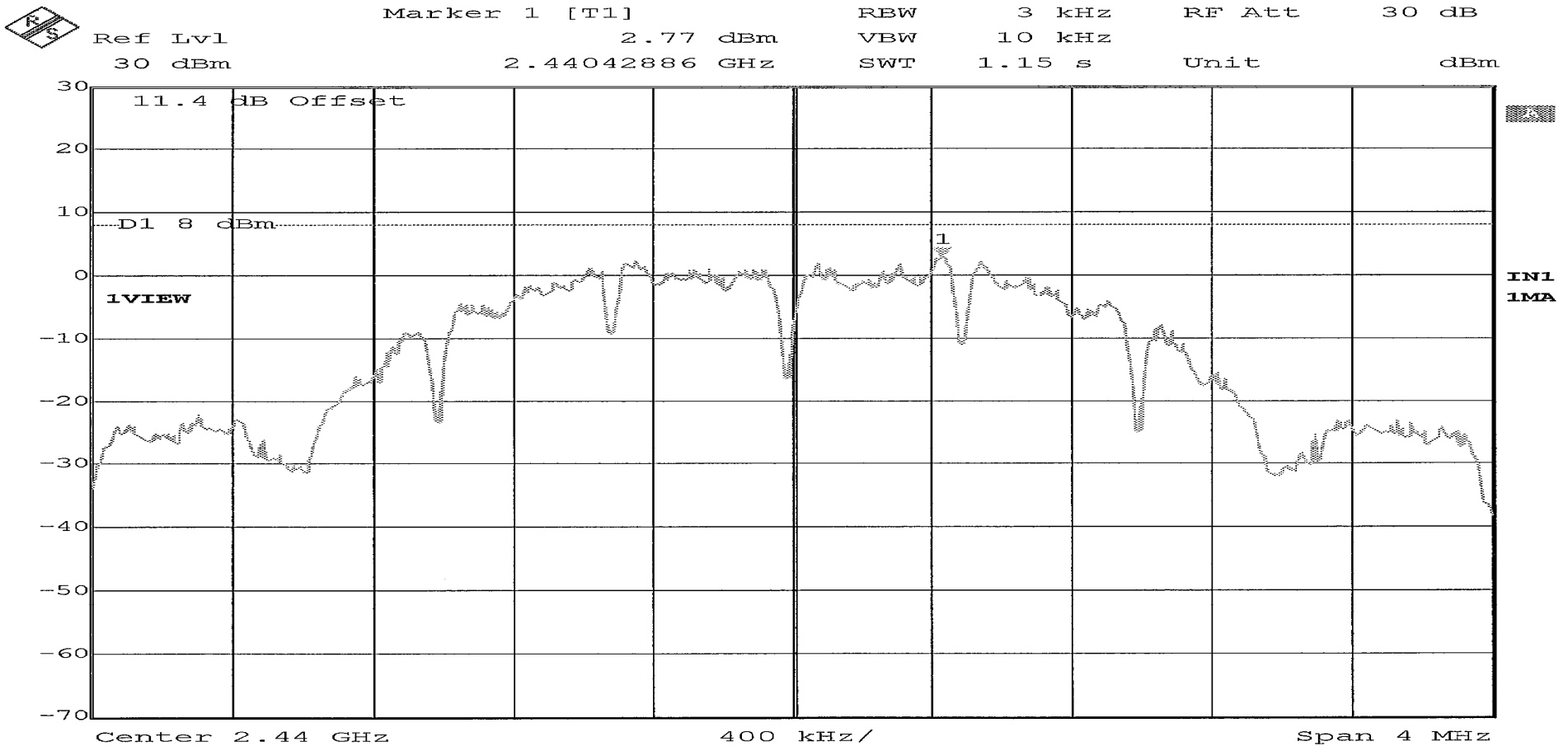

# RETLIF TESTING LABORATORIES

<b>Test Method:</b>	Power Spectral Density		
<b>Customer</b>	Lord Corporation	<b>Job No.</b>	R-6179N-1
<b>Test Sample</b>	G-Link-200 Accelerometer		
<b>Model Number</b>	G-Link-200-8G	<b>Serial No.</b>	6305-6000-6003
<b>Operating Mode</b>	Transmitting modulated signal at 2.480GHz		
<b>Test Specification</b>	FCC Part 15, Subpart C Paragraph: 15.247 (e)		
<b>Technician</b>	M. Seamans	<b>Date</b>	March 7 <sup>th</sup> , 2017
<b>Climatic Conditions</b>	Temp: 19.4 °C    Relative Humidity: 19.4 %		
<b>Notes</b>	Power Spectral Density: 2.56 dBm    Limit: 8 dBm		

